



2023-2024 | Catalog

Cutting Tools



KYOCERA UNIMERCO

ADVANCING PRODUCTIVITY

ADVANCING PRODUCTIVITY

Advancing your productivity through efficient cutting tool products and advanced tooling solutions.

Kyocera is the global and comprehensive cutting tool manufacturer who provides innovative materials and tool designs as well as proposes solutions for technological improvements.

Kyocera contributes to a world manufacturing by the innovative products and technology.

Kyocera's management aims to be focused on the user's perspective.

We promise to be a comprehensive value-added manufacturer.

<p>A</p>  <p>Insert grades</p>	<p>B</p>  <p>Turning indexable inserts</p>	<p>C</p>  <p>CBN & PCD tools</p>	<p>D</p>  <p>External</p>
<p>E</p>  <p>Small tools</p>	<p>F</p>  <p>Boring</p>	<p>G</p>  <p>Grooving</p>	<p>H</p>  <p>Cut-off</p>
<p>J</p>  <p>Threading</p>	<p>K</p>  <p>Drilling</p>	<p>M</p>  <p>Milling</p>	<p>P</p>  <p>Spare parts</p>
<p>R</p>  <p>Technical information</p>	<p>T</p>  <p>Index</p>		

CONTENTS | 2023-2024

Introduction	2-4
Insert grades	A1-A21
Turning	
Inserts	B1-B124
CBN & PCD tools	C1-C62
External	D1-D70
Small tools	E1-E68
Boring	F1-F153
Grooving	G1-G149
Cut-off	H1-H62
Threading	J1-J65
Drilling	K1-K107
Milling	M1-281
Spare parts	P1-P36
Technical information	R1-R55
Index	T1-T23

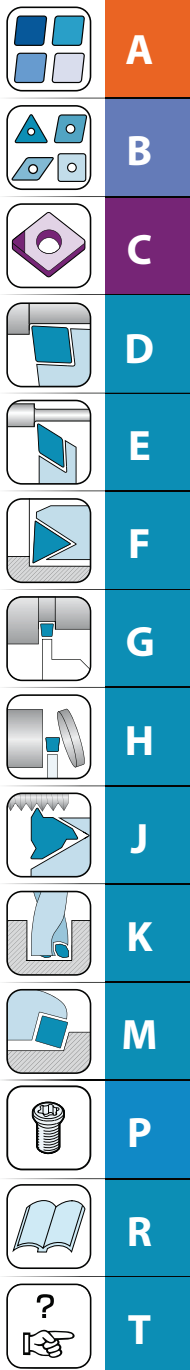

Tool Management

Maximum flexibility solutions: See on last page of catalogue



Introduction

1. Introduction

Kyocera has put a "caution" or a "warning" label on the package of the cutting tool products, but it is not on the tool itself. Before using and handling any cutting tool products and cutting tool materials, be sure to read this guideline so they are used correctly. Also, as part of your safety education, please make sure to familiarize all of your actual operators with the contents of this guideline.

2. Basic information for cutting tool materials

2.1 Technical terms

Cutting tool material: Terminology for cutting tool materials, such as cemented carbide, coated carbide, cermet, coated cermet, ceramics, CBN and PCD

Carbide material: Cemented carbide with WC (Tungsten carbide) as the main component

2.2 Physical properties

Appearance: Depends on materials. (e.g. gray, black, gold, etc.)

Smell: None

Hardness: Carbide / Cermet 5 ~ 30 GPaHV, Ceramic 10 ~ 40 GPaHV
CBN 20 ~ 50 GPaHV, PCD 80 ~ 120 GPaHV

Sp. Gr.: Carbide 9 ~ 16, Cermet 5 ~ 9, Ceramic 2 ~ 7, CBN / PCD 3 ~ 5

2.3 Composition

Carbide, Nitride, Carbon-nitride and Oxide with W, Ti, Al, Si, Ta, B, etc. and additionally, metals such as Co, Ni, Cr, Mo are included in some cutting materials.

3. Notes for handling cutting tool materials

- These cutting tool materials are very hard, but also brittle. Therefore, they may break by shock or excessive clamp force.
- Carbide base material, in particular, can be very heavy. Handle with care when transferring and storing large size products or large quantities as heavy load.
- Carbide base material has a different rate of thermal expansion to that of normal metals. When brazing the cutting tool material, use the proper temperature to prevent the tool from breaking.

4. Notes for cutting tools

- The cutting edge is very sharp; wear gloves when handling or installing tools to prevent injury.
- When cutting, cutting tools may break due to shock, excessive tool wear or improper conditions. It is essential to wear protective clothing such as safe guards, safety eyeglasses, and gloves to prevent injury.
- Depending on workpiece material and cutting conditions, sparks or fire may occur. Use protective material such as safe guards, safety eyeglasses and gloves.
- When cutting, flying chips or metal pieces may be dangerous. Use protective materials such as safe guards and safety eyeglasses to prevent injury.

Introduction

Precaution for using cutting tools

Target products	Precariousness	Countermeasures
General cutting tools	Direct touch to a sharp cutting edge may cause injury.	When you set up tools to the machine or take tools out of the case, please wear protective gloves.
	Misuse or inappropriate working conditions may cause tool breakage or dispersion of broken pieces.	<ul style="list-style-type: none"> • Please use safety items, such as safety glasses and protective gloves. • Please use in the range of our recommended cutting condition. See our catalog or instruction manuals.
	Excessive impact or heavy wear will increase cutting force and may cause tool breakage and dispersion of broken pieces.	<ul style="list-style-type: none"> • Please use safety items, such as safety glasses and protective gloves. • Early exchanging tools is preferable.
	Dispersion of heated or prolonged chips may cause injury or burn.	<ul style="list-style-type: none"> • Please use safety items, such as safety glasses and protective gloves. • For chips removal, please stop the machine beforehand and use safety items, such as safety glasses and protective gloves.
	Tools and materials reach high temperatures during cutting operation. Direct touch to the tools and materials shortly after cutting may cause burn.	Please prepare safety items, such as safety glasses and protective gloves.
	Sparks, generation of heat or chips in high temperature during operation may cause fire.	<ul style="list-style-type: none"> • Please do not operate around Hazardous zone, in which there is some possibility of fire or explosion. • In case of using oil-coolant, please make sure there is sufficient fire-protection equipment.
	Lack of dynamic balance during high-speed revolutions leads to vibrations which can make the tool break.	<ul style="list-style-type: none"> • Please use safety items, such as safety glasses and protective gloves. • Please conduct test-operation before cutting, and confirm that there is no vibration or unusual sound.
	Direct touch to burrs which were generated on the rough surface of the workpiece may cause injury.	Do not touch workpiece with bare hand.
Indexable cutting tools	If the inserts or other tool parts are not installed properly, they can fall down or break which may cause injuries.	<ul style="list-style-type: none"> • Please clean up insert pockets or clamping parts before setting insert. • Please set up inserts with supplied wrench only, and confirm that the inserts or parts are clamped completely. Never use inserts or parts other than those prescribed.
	If inserts are clamped too tightly by supplementary tools like pipe etc, inserts or body may brake.	Do not use aids such as pipes. Please set up using supplied wrench only.
	When tools are used in high-speed revolution, inserts or parts may burst out of the body due to centrifugal force. When handling, please pay special attention to safety.	Please use in the range of our recommended cutting conditions. See our catalog or instruction manuals.
Milling cutters and other milling tools	Since milling cutters have sharp edges, direct contact with bare hands may cause injury.	Please use safety items, such as safety glasses and protective gloves.
	If a cutter lacks balance, the tool can start to vibrate. The dispersion of broken pieces can cause injuries.	<ul style="list-style-type: none"> • Please use in the range of our recommended cutting condition. • Accuracy and balance of machine spindle should be checked and adjusted regularly to prevent wear of the bearings due to eccentric rotation.
Drilling	When drilling a through-bore, it is possible that a disc is created during the drilling procedure that can fly out of the workpiece at a high speed. This is very dangerous since the disc has sharp edges.	Please use safety items, such as safety glasses and protective gloves. Also attach a cover on a chuck part.
Brazed tools	Dispersion or falling down of broken inserts may cause injury.	<ul style="list-style-type: none"> • Please check that the cutting inserts are brazed firmly before use. • Please do not use brazed tools in the condition that requires high cutting temperature.
Others	If brazing is carried out many times, the strength of carbide insert is deteriorated and can break easily during cutting.	Please do not use tools that have been brazed several times. The quality of the tool deteriorates.
	The tools can only be used for the appropriate application. It may damage tools and machines.	Please follow our recommended usage for the tools.

Introduction

Preface

This general catalog is as of November 2022.

The availability of products will be shown as follows:

●	Standard item	□	Check availability
R	Right-hand only	MTO	Made to order
L	Left-hand only	None	No Stock

The specifications of products in this catalog may be changed due to research / development / modification without prior notice. Also conventional products might be integrated or centralized due to new material or new product development.

Kyocera Cutting Tools will continue to improve product quality and safety.

For safety data sheet (SDS) of each insert grade, please refer to our machine tool homepage:

<https://www.kyocera-unimerco.com/products-and-services/metal/technical-documentation/safety-data-sheets/> ⇨



Packaging units

Toolholder body / Parts

Type	Pieces/box	Remarks
Toolholder	1 piece/box	
Milling	1 piece/box	
Parts	1 piece/box	Light weight parts (Clamp screws) are in a plastic bag

Inserts

Type	Pieces/box	Remarks
Twin bars	5 pieces/box	TWB / TWBT / TWFG / TWFGT insert
System tip-bars	5 pieces/box	VNB / VNBT / VNFG / VNG / VNT insert
EZ bars	1 piece/box	EZB / EZVB / EZFG / EZG / EZT ... inserts
CBN inserts	1 piece/box	Insert grades: KBN...
PCD inserts	1 piece/box	Insert grades: KPD...
Threading inserts	5 pieces/box	Insert grades: PR930 / PR1115 / PR1215 / PR1515 / PR1535 / GW15 only
GC inserts	5 pieces/box	Inserts for SIGC
DA...M-GM type insert	1 piece/box	Inserts for MagicDrill DRA
DC...M-SC type insert	1 piece/box	Inserts for MagicDrill DRC
SEEN-W inserts	5 pieces/box	Insert grades: TN100M / KW10 only
PNEG-W inserts	5 pieces/box	MFK insert with wiper edge
PNEU-W inserts	5 pieces/box	MFPN insert with wiper edge
RDFG type insert	2 pieces/box	MRF / MRFW ball end mill insert
RBG Type insert	1 piece/box	
Other than above inserts	10 pieces/box	

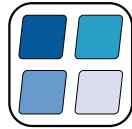

A

Summary of insert grades	A2-A5
Turning	A2
Small parts machining	A3
Grooving / Cut-Off / Threading	A4
Drilling	A5
Milling	A5

Insert grades	A6-A21
Cermet	A6
PVD coated cermet	A6
CVD coated carbide (Turning)	A8
PVD coated carbide (Turning)	A10
PVD / CVD coated carbide (Milling / Drilling)	A12
Carbide	A14
DLC coated carbide	A14
Ceramic	A15
CBN (Cubic boron nitride)	A16
PCD (Polycrystalline diamond)	A17
Honeycomb structure CBN	A18
Insert material selection table	A19
Grade properties	A20

Kyocera promotes research and development to help improve customers' productivity and profitability. Kyocera provides high-quality inserts in various grades including cermet, coated carbide, coated super micro grain carbide, carbide, ceramic, PCD and CBN.



Insert grades

Turning

Workpiece material		Steel				Stainless steel / Cast steel					Cast iron						
Cutting range		Finishing ← → Roughing				Finishing ← → Roughing					Finishing ← → Roughing						
Classification		P01	P10	P20	P30	P40	M01	M10	M20	M30	M40	K01	K10	K20	K30		
Cermet	TN series	TN610, TN620, TN60, TN90					TN610, TN620, TN60, TN90					TN60					
	TC series		TC60					TC60									
	CCX (CVD coated)	CCX											CCX				
	PV series		PV90					PV90									
	MEGACOAT												PV7005				
	MEGACOAT NANO	PV710, PV720, PV730					PV710, PV720, PV730										
Coated carbide	CA series	CA510, CA515, CA025P, CA525, CA530					CA6515, CA6525					CA310, CA315, CA320					
		CA5505, CA5515, CA5525, CA5535										CA4505, CA4515					
	PR series	PR930, PR1025					PR930, PR1025										
	MEGACOAT	PR1225					PR1225										
	MEGACOAT NANO	PR1535					PR1535										
	MEGACOAT NANO PLUS	PR1705, PR1725					PR1725										
	Ceramic												KA30, KT66, A66N, PT600M, KS6015, KS6050, CS7050				
													KW10				
													KBN475, KBN60M, KBN900				
Carbide																	
CBN																	

Turning



Insert grades

Workpiece material		Non-ferrous metals				Difficult-to-cut materials Titanium / Titanium alloys				Hard materials				Sintered steel			
Cutting range		Finishing ↔ Roughing				Finishing ↔ Roughing				Finishing ↔ Roughing				Finishing ↔ Roughing			
Classification		N01	N10	N20	N30	S01	S10	S20	S30	H01	H10	H20	H30	01	10	20	30
Coated carbide	CA series						CA6515										
	MEGACOAT HARD						PR005S										
	MEGACOAT NANO						PR015S										
	Cermet														TN610		
															TN60		
	Ceramic						KS6030				KT66						
							KS6040				A66N						
											PT600M						
CBN											KBN510						
											KBN525						
MEGACOAT											KBN900						
											KBN05M						
											KBN10M						
											KBN25M						
											KBN35M						
	MEGACOAT TOUGH										KBN020						
															KBN70M		
															KBN570		

Workpiece material		Non-ferrous metals				Difficult-to-cut materials Heat-resistant alloys / Ni-base heat-resistant alloys				Hard materials				Sintered steel			
Cutting range		Finishing ↔ Roughing				Finishing ↔ Roughing				Finishing ↔ Roughing				Finishing ↔ Roughing			
Classification		N01	N10	N20	N30	S01	S10	S20	S30	H01	H10	H20	H30	01	10	20	30
	MEGACOAT NANO Coated carbide																
Carbide							GW05				SW05						
							KW10				SW10						
											SW25						
DLC coated carbide																	
PCD																	

Small parts machining

Workpiece material		Steel				Stainless steel / Cast steel					Cast iron				
Cutting range		Finishing ↔ Roughing				Finishing ↔ Roughing					Finishing ↔ Roughing				
Classification		P01	P10	P20	P30	P40	M01	M10	M20	M30	M40	K01	K10	K20	K30
Coated carbide	PR series														
	MEGACOAT														
	MEGACOAT NANO														
	MEGACOAT NANO PLUS														

Workpiece material		Non-ferrous metals				Difficult-to-cut materials Heat-resistant alloys / Ni-base heat-resistant alloys				Hard materials				Sintered steel			
Cutting range		Finishing ↔ Roughing				Finishing ↔ Roughing				Finishing ↔ Roughing				Finishing ↔ Roughing			
Classification		N01	N10	N20	N30	S01	S10	S20	S30	H01	H10	H20	H30	01	10	20	30
	Carbide																

A

Grooving / Cut-Off / Threading

Insert grades

Workpiece material		Steel				Stainless steel / Cast steel					Cast iron					
Cutting range		Finishing ↔ Roughing				Finishing ↔ Roughing					Finishing ↔ Roughing					
Classification		P01	P10	P20	P30	P40	M01	M10	M20	M30	M40	K01	K10	K20	K30	
Cermet	MEGACOAT	PV7040										PV7040				
	TN series	TN620					TN620									
		TN6020					TN6020									
		TN60					TN60						TN60			
TC series	TN90					TN90										
	TC40											TC40				
Coated carbide	CR series		CR9025					CR9025								
	PR series	PR915					PR915						PR905			
		PR930					PR930									
		PR1025					PR1025									
		PR1115														
	MEGACOAT	PR1215					PR1215						PR1215			
		PR1225					PR1225									
MEGACOAT NANO	PR1535					PR1515										
	PR1625					PR1625										
Ceramic												A65				
												A66N				
												PT600M				
Carbide												KW10				
												GW15				

Workpiece material		Non-ferrous metals				Difficult-to-cut materials Titanium / Titanium alloys				Hard materials				Sintered steel				
Cutting range		Finishing ↔ Roughing				Finishing ↔ Roughing				Finishing ↔ Roughing				Finishing ↔ Roughing				
Classification		N01	N10	N20	N30	S01	S10	S20	S30	H01	H10	H20	H30	01	10	20	30	
MEGACOAT Coated carbide																PR1215		
																PR1225		
Cermet															TN60			
Ceramic										A65								
										A66N								
										PT600M								
Carbide		KW10					KW10											
		GW05					GW15											
		GW15					GW15											
DLC coated carbide		PDL025																
CBN										KBN510					KBN570			
										KBN525								
PCD		KPD001				KPD001												
		KPD010				KPD010												



Drilling

Workpiece material	Steel					Stainless steel / Cast steel					Cast iron			
Cutting range	Finishing ↔ Roughing					Finishing ↔ Roughing					Finishing ↔ Roughing			
Classification	P01	P10	P20	P30	P40	M01	M10	M20	M30	M40	K01	K10	K20	K30
Coated carbide	CA series	CA520D				CA6535					CA415D			
	MEGACOAT	PR1225				PR1225					PR1210			
	MEGACOAT NANO	PR1535				PR1535								
Carbide											KW10			
											GW15			

Workpiece material	Non-ferrous metals				Difficult-to-cut materials Titanium / Titanium alloys				Hard materials			
Cutting range	Finishing ↔ Roughing				Finishing ↔ Roughing				Finishing ↔ Roughing			
Classification	N01	N10	N20	N30	S01	S10	S20	S30	H01	H10	H20	H30
MEGACOAT Coated carbide									PR1230			
Carbide	KW10				KW10							
	GW15				GW15							

Milling

Workpiece material	Steel					Stainless steel / Cast steel					Cast iron			
Cutting range	Finishing ↔ Roughing					Finishing ↔ Roughing					Finishing ↔ Roughing			
Classification	P01	P10	P20	P30	P40	M01	M10	M20	M30	M40	K01	K10	K20	K30
Cermet	TN620M					TN60								
	TN60					TN100M								
	TN100M													
Coated carbide	PV60M					CA6535					CA420M			
	PR1225					PR1225					PR1210			
	PR1230					PR1525					PR1510			
MEGACOAT NANO	PR1525					PR1535								
											KW10			
Carbide											GW25			

Workpiece material	Non-ferrous metals				Difficult-to-cut materials Heat-resistant alloys / Ni-base heat-resistant alloys				Difficult-to-cut materials Titanium / Titanium alloys				Hard materials			
Cutting range	Finishing ↔ Roughing				Finishing ↔ Roughing				Finishing ↔ Roughing				Finishing ↔ Roughing			
Classification	N01	N10	N20	N30	S01	S10	S20	S30	S01	S10	S20	S30	H01	H10	H20	H30
Coated carbide					CA6535				CA6535							
									PR1210							
													PR0155			
					PR1535				PR1535							
Carbide	KW10								KW10							
	GW25								GW25							
DLC coated carbide	PDL025															
CBN																
PCD	KPD001								KPD001							
	KPD010								KPD010							
	KPD230															
	KPD250															

Cermet

Cermet

KYOCERA is known as one of the leading manufacturer of cermets. Cermets combine toughness with superior wear resistance, and provide longer tool life and excellent surface finishes. Typical materials used in cermets are TiC, TiN, TiCN and NbC.

PVD coated cermet (MEGACOAT / MEGACOAT NANO Cermet)

PVD coated cermet is coated on cermet substrate with a thin layer of high wear resistance and high adhesion resistance by PVD (Physical Vapor Deposition) technology. Generally because of the low processing temperature of PVD compared with CVD, PVD coated cermet features less deterioration and more bending strength.



Features of cermet and PVD coated cermet

Classification	Grade	Color	Main component (Coated composition)	Advantages and applications	
<div style="border: 1px solid black; padding: 5px; text-align: center; width: 30px; margin: 0 auto;"> P Steel </div>	Cermet	TN610	TiCN	<ul style="list-style-type: none"> High wear resistant cermet due to three types of special reinforcement technology Application: Cermet for steel machining, long tool life in high speed and continuous 	
		TN620	TiCN	<ul style="list-style-type: none"> Three types of special reinforcement technology realized the superior fracture resistance and wear resistance Application: Stable machining of steel 	
		TN60	TiCN+NbC	<ul style="list-style-type: none"> Application: Machining of steel, continuous to interruption 	
		TN6020	TiCN	<ul style="list-style-type: none"> Application : Uncoated cermet for grooving of steel 	
		TN620M	TiCN	<ul style="list-style-type: none"> Tough cermet for milling with excellent balance of wear resistance and toughness Application : Milling of steel with high quality surface finish and long tool life 	
		TN100M	TiCN+NbC	<ul style="list-style-type: none"> Tough cermet with improved oxidation resistance and thermal shock resistance Application: Milling of steel at high speed 	
		TC40	TiC+TiN	<ul style="list-style-type: none"> Good balance of wear resistance and toughness Application: Grooving and threading of steel 	
	CVD Coated Cermet	CCX	Gold	TiCN (TiCN+Al ₂ O ₃ +Tin)	<ul style="list-style-type: none"> Specialized high-strength micro grain cermet base material with superior wear-resistant thick CVD coating Excellent wear resistance leads long tool life in high speed machining Application : High speed finishing to light interrupted machining of steel
	MEGACOAT NANO Cermet	PV710	Gold	TiCN (MEGACOAT NANO)	<ul style="list-style-type: none"> Superior wear and adhesion resistant MEGACOAT NANO on the high wear resistant cermet Application: Long tool life and stability in high speed continuous machining of steel, excellent surface
		PV720		TiCN (MEGACOAT NANO)	<ul style="list-style-type: none"> Superior wear and adhesion resistant MEGACOAT NANO on the special reinforcement cermet Application: First choice PVD coated cermet for steel machining, high efficient machining and high quality surface finish
		PV60M	Gold	TiCN+NbC (MEGACOAT NANO)	<ul style="list-style-type: none"> Improved stable grade for milling by MEGACOAT NANO coating technology Application: Milling of steel with high quality surface finish and stable machining
	MEGACOAT Cermet	PV7040	Blackish Red	TiC+TiN (MEGACOAT)	<ul style="list-style-type: none"> MEGACOAT Cermet for Grooving Application: Excellent surface finish and longer tool life in steel grooving
		PV7005		TiC+TiN MEGACOAT	<ul style="list-style-type: none"> Heat-resistant MEGACOAT on cermet with excellent wear resistance Application: High speed finishing of gray and nodular cast iron

Application map

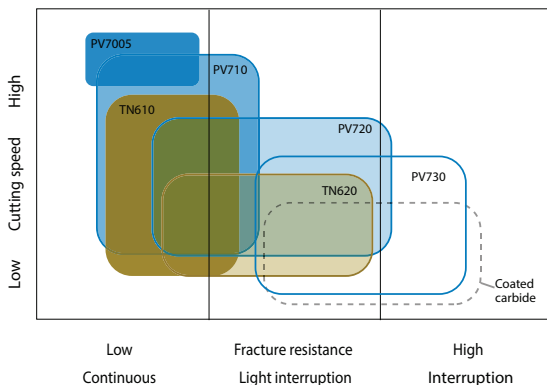

Properties of PVD coating

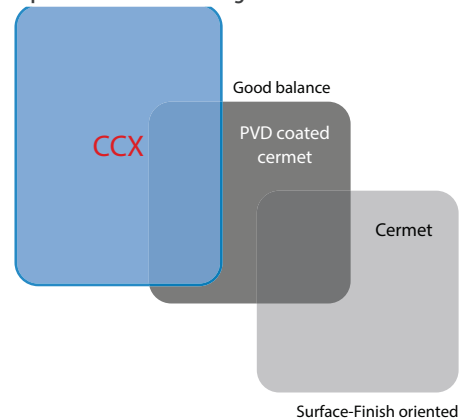



Uncoated CERMET

TN610/TN620

Special reinforcement technology (hybrid technology)
Superior surface finish and machining stability.

MEGACOAT NANO CERMET

PV710/PV720/PV730

1 Excellent surface finish

- Combining the conventional cermet bonded phase (nickel, cobalt) and the special high melting point metallic bonded phase
- Provides high adhesion resistance to eliminate galling of the workpiece

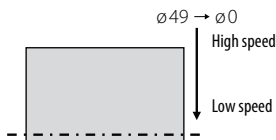
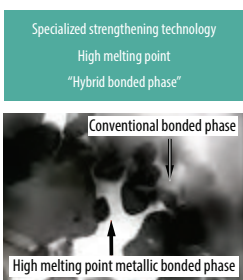

Surface finish comparison (In-house evaluation)

Cutting conditions: $V_c = 180 \sim 0$ m/min (Constant rotational speed), $a_p = 0.5$ mm, $f = 0.1$ mm/rev, wet, CNMG120404 type, workpiece: C10

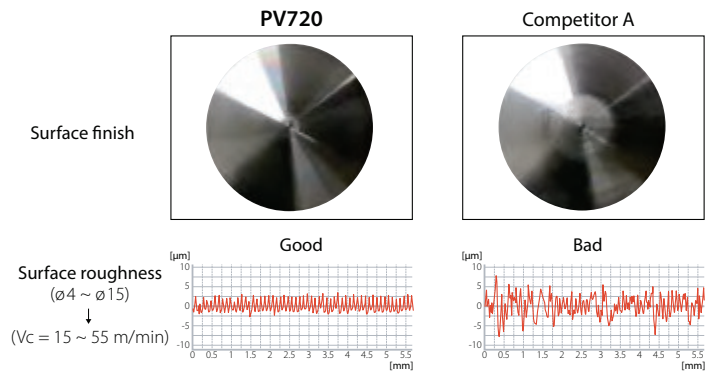

CVD coated cermet for finishing

CCX

Excellent high speed finishing leads to greater productivity. Applicable to a wide range of cutting conditions from general to high speed machining. Maintains long tool life in soft steel, general steel and cast iron machining

1 Superior wear resistance to PVD coated cermets

2 Unique cermet base material with thick CVD coating

Alloy Steel - 34CrMo4 High speed comparison: $V_c = 400$ m/min

CCX provided better tool life than competitor's PVD cermets by greatly reducing the amount of wear

Wear resistance comparison (Internal evaluation)

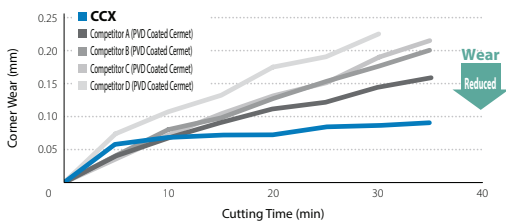

Cutting edge (After machining 35 min)

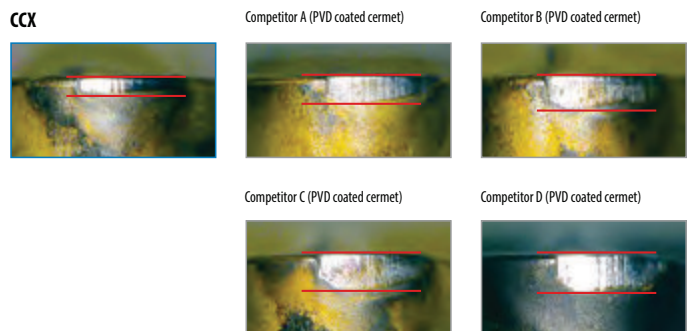

* Picture shows 30 min after machining due to a large amount of wear

Cutting conditions: $V_c = 400$ m/min, $a_p = 0.3$ mm, $f = 0.12$ mm/rev, Wet, CNMG120408 type, external turning

CVD coated carbide (Turning)



Insert grades

CVD coated carbide

Using chemical vapor deposition coating technology, CVD coated carbide grades provide stable, efficient machining at high speeds or for heavy interrupted applications.

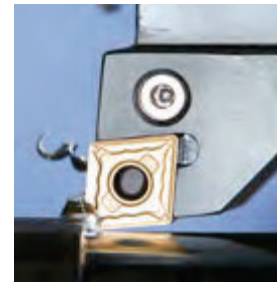

Features

- Applicable from low to high speed machining and from finishing to roughing
- Stable machining is achieved due to the superior toughness and crack resistance
- Cutting times are reduced due to good chip control from effective chipbreakers

Features of CVD coated carbide

Classification	Grade	Color	Coated composition	Advantages and applications
<div style="background-color: #0070C0; color: white; padding: 5px; text-align: center; border-radius: 5px;"> P Steel </div>	CA510	Gold	TiCN+Al ₂ O ₃ +TiN	<ul style="list-style-type: none"> • Special substrate with thermal deformation resistance along with a thick and tough coating layer providing high wear resistance • Application: High speed and high efficiency steel machining
	CA515		TiCN+Al ₂ O ₃ +TiN	<ul style="list-style-type: none"> • Improved wear resistance and stability due to special substrate with heat deformation resistance and hard and tough coating layer with reinforced interface • Application: Light interrupted machining of steel
	CA025P		TiCN+Al ₂ O ₃ +TiN	<ul style="list-style-type: none"> • CVD coating with improved wear resistance. Adopted base material, excellent chipping resistance, resistance to wear and resistance to improve chip performance • Application: Continuous to interrupted processing of steel
	CA525		TiCN+Al ₂ O ₃ +TiN	<ul style="list-style-type: none"> • Stable and long tool life machining due to special substrate with heat deformation resistance and tougher coating layer and reinforced interface • Application: Interrupted to general machining of steel
	CA530		TiCN+Al ₂ O ₃ +TiN	<ul style="list-style-type: none"> • Special tough substrate and tough coating layer providing high stability and wear resistance • Application: General to heavy interrupted machining (stability oriented)
	CA5505		TiCN+Al ₂ O ₃ +TiN	<ul style="list-style-type: none"> • Application: High speed continuous machining of steel, continuous to light interrupted machining of cast iron
	CA5515		TiCN+Al ₂ O ₃ +TiN	<ul style="list-style-type: none"> • Application: Machining of steel, continuous to light interruption
	CA5525		TiCN+Al ₂ O ₃ +TiN	<ul style="list-style-type: none"> • Application: For general machining of steel, roughing to interruption
	CA5535		TiCN+Al ₂ O ₃ +TiN	<ul style="list-style-type: none"> • Application: Roughing to heavy interrupted machining of steel
	CR9025		TiCN+TiN	<ul style="list-style-type: none"> • Improved toughness and stability due to specialized carbide substrate with plastic deformation resistance • Application: Cut-off, grooving and multi-function machining of steel
<div style="background-color: #FFD700; color: black; padding: 5px; text-align: center; border-radius: 5px;"> M Stainless steel </div>	CA6515		TiCN+Al ₂ O ₃ +TiN	<ul style="list-style-type: none"> • Specialized carbide substrate for machining stainless steel, excellent wear resistance • Application: Continuous machining of stainless steel
	CA6525		TiCN+Al ₂ O ₃ +TiN	<ul style="list-style-type: none"> • Specialized carbide substrate for machining stainless steel, excellent notching resistance and toughness • Application: First choice for general machining of stainless steel, from finishing to roughing, continuous to interruption
<div style="background-color: #C00000; color: white; padding: 5px; text-align: center; border-radius: 5px;"> K Cast iron </div>	CA310	Rose Gold	TiCN+Al ₂ O ₃ +Ti base	<ul style="list-style-type: none"> • Grade for high-speed continuous machining and improved tool life through the deposition of a thickened Al₂O₃ coating layer • Application : For finishing to roughing of gray cast iron
	CA315		TiCN+Al ₂ O ₃ +Ti base	<ul style="list-style-type: none"> • Both high abrasion resistance and stability are compatible, high efficiency and long life performance are demonstrated. Can be adapted to both continuous machining and interrupted machining. • Application: Compatible with a wide processing area for cast iron and gray cast iron. First recommendation for cast iron
	CA320		TiCN+Al ₂ O ₃ +Ti base	<ul style="list-style-type: none"> • Improved stability with CVD layer structure with high adhesion • Application : Heavily interrupted or High-speed machining for Nodular Cast Iron. The 1st Recommendation for the FCDS500 or higher application
	CA4505	Blackish gray	TiCN+Al ₂ O ₃	<ul style="list-style-type: none"> • Stable, longer tool life due to improved bonding strength of coating layers and special treatment of the surface of the top coating layer • Application: For gray cast iron and nodular cast iron at high speed in continuous to light interrupted machining
	CA4515		TiCN+Al ₂ O ₃	<ul style="list-style-type: none"> • Stable, longer tool life due to improved bonding strength of coating layers and special treatment of the surface of the top coating layer • Application: First choice for gray cast iron and nodular cast iron in light to heavy interrupted machining



CVD coated carbide grade for steel

CA025P

Next generation CVD coating for longer tool life

1 Improved wear resistance with new CVD grade for steel

Thickened alumina with good thermal resistance (Twice as thick as conventional coating)
Improved plastic deformation resistance by increased temperature strength

Wear resistance comparison (Internal evaluation)

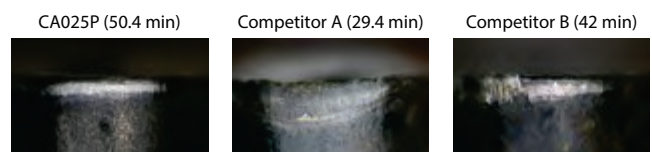
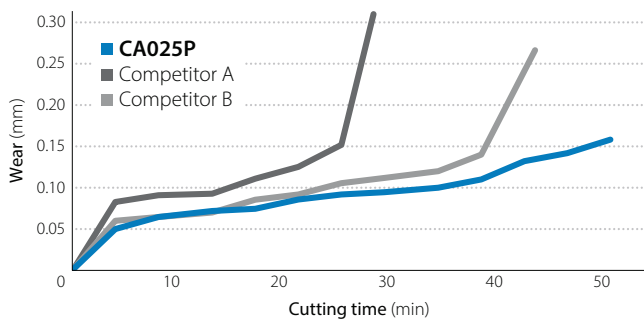

CA025P (50.4 min)
Good wear condition

Cutting conditions: $V_c = 300$ m/min, $a_p = 1.5$ mm, $f = 0.3$ mm/rev, wet workpiece: 34CrMo4

Wear comparison (Internal evaluation) Cutting time: 25.2 min

CA025P maintains smooth and flat wear with stable tool life

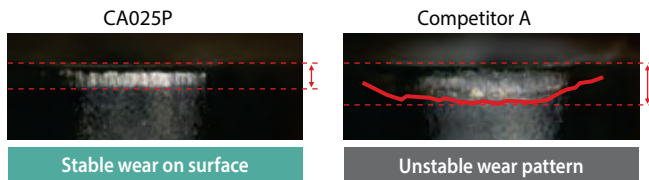

Cutting conditions: $V_c = 300$ m/min, $a_p = 1.5$ mm, $f = 0.3$ mm/rev, wet workpiece: 34CrMo4

Plastic deformation comparison under high temperature (Internal evaluation)
Comparison with Competitor A

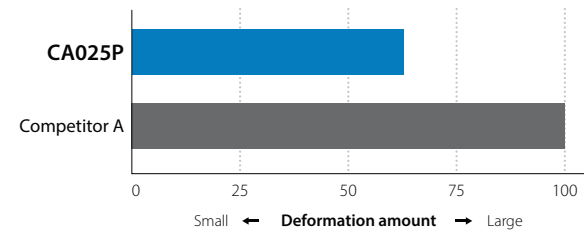

2 Excellent fracture resistance

New substrate with high stability provides excellent chipping resistance

Fracture resistance comparison (Internal evaluation) Average of 5 times

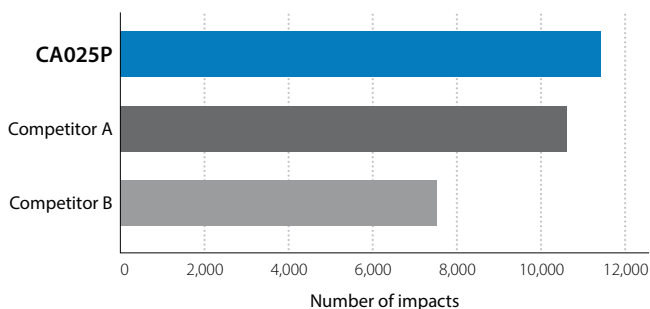

Cutting conditions: $V_c = 250$ m/min, $a_p = 1.5$ mm, $f = 0.35$ mm/rev, wet Workpiece: 42CrMo4 (with 4 slots)

3 Excellent adhesion resistance and chipping resistance

Specialized post-coating process prevents adhesion

Adhesion on the edge after cutting (Internal evaluation)

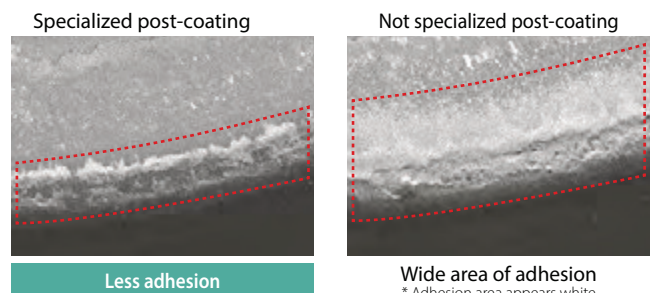

Specialized post-coating
Less adhesion

Not specialized post-coating
Wide area of adhesion
* Adhesion area appears white

Cutting conditions: $V_c = 270$ m/min, $a_p = 1.0$ mm, $f = 0.1$ mm/rev, wet Workpiece: 42CrMo4 (with 4 slots)

PVD coated carbide (Turning)



PVD coated carbide (MEGACOAT / MEGACOAT NANO)

Using a physical vapor deposition coating technology, generally because of the low processing temperature of PVD compared with CVD, PVD coated carbide features less deterioration and more bending strength. PVD coated carbide grades are coated on a very tough carbide substrate and suitable for turning.

PVD coated super micro-grain carbide

- Smooth fine surface of PVD coated carbide provides good surface finish and high precision machining
- Stable machining with excellent toughness

Features of PVD coated carbide

Classification	Grade	Color	Coated composition	Advantages and applications
<div style="background-color: #0070C0; color: white; padding: 5px; text-align: center; border-radius: 5px;"> P Steel </div>	PR915 <small>Super micro-grain</small>	Bluish violet	TiAlN	• Application: Stable and reliable high precision machining of steel
	PR930 <small>Super micro-grain</small>	Reddish gray	TiCN	• Application: Low machining speed, precise machining with sharp edge
	PR1025	Reddish gray	TiCN	• Application: General machining of steel and stainless steel, stable and longer tool life
	PR1115	Purple red	TiAlN	• Superior oxidation resistance with well balanced wear resistance and toughness • Application: Machining of steel and stainless steel, for grooving, cut-off and threading
	PR1215	Blackish red	MEGACOAT	• Superior wear and oxidation-resistant MEGACOAT on micro-grain carbide substrate • Application: Superior adhesion resistance and longer tool life for steel and stainless steel machining
	PR1625	Reddish green	MEGACOAT NANO	• Adopted special nano multi-layer coating "MEGACOAT NANO" excellent in wear resistance and lubricity • Stable processing with steel and stainless steel grooving - Long tool life
	PR1705	Silver	MEGACOAT NANO PLUS	• High-hardness ultrafine particle carbide substrates with special multilayer nano coating MEGACOAT NANO PLUS offer excellent wear resistance and high precision machining. • Application: For free-cutting steel turning. Long tool life with excellent wear resistance and high-precision machining.
	PR1725	Silver	MEGACOAT NANO PLUS	• New coating technology [MEGACOAT NANO PLUS] with superior wear resistance and adhesion resistance • Application : General grade for steel and stainless steel machining provides stability and longer tool life
<div style="background-color: #FFD700; color: black; padding: 5px; text-align: center; border-radius: 5px;"> M Stainless steel </div>	PR1225	Blackish red	MEGACOAT	• Superior wear and oxidation-resistant MEGACOAT on micro-grain carbide substrate • Application: Light interrupted to interrupted machining of stainless steel
	PR1515	Reddish green	MEGACOAT NANO	• Improved wear resistance and stability by using fine granite carbide base metal and special nano multi-layer coating "MEGACOAT NANO" • Application: For thread cutting of stainless steel
	PR1535			• Nano thin multi-layer coating (MEGACOAT NANO) improved wear resistance and stability • Application: Medium to roughing of stainless steel and heat-resistant alloys, cut-off of stainless steel
<div style="background-color: #FF0000; color: white; padding: 5px; text-align: center; border-radius: 5px;"> K Cast iron </div>	PR905	Bluish violet	TiAlN	• Smooth fine surface PVD coated hard carbide with plastic deformation resistance • Application: Suitable for machining gray and nodular cast iron
<div style="background-color: #8B4513; color: white; padding: 5px; text-align: center; border-radius: 5px;"> S Heat-resistant alloys </div>	PR005S	Grey black	MEGACOAT HARD	• Superior high temperature properties of special carbide substrate and excellent heat-resistance of MEGACOAT HARD enables high wear resistance • Application: Finish processing of heat-resistant alloys, also for high speed machining
	PR015S	Grey black	MEGACOAT HARD	• Superior high temperature properties of special carbide substrate and MEGACOAT HARD improved heat-resistance and stability • Application: Recommended for continuous to light interruption machining and finishing of heat-resistant alloys

Properties of PVD coating

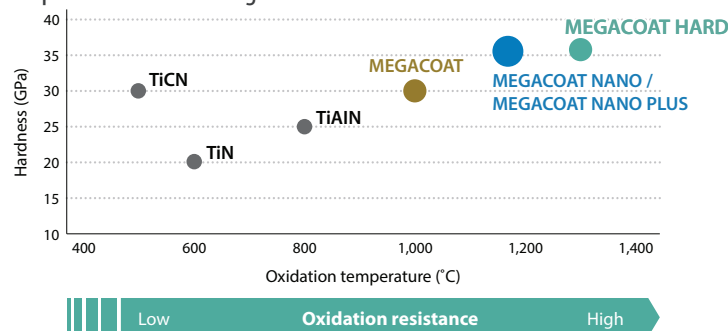



Application map

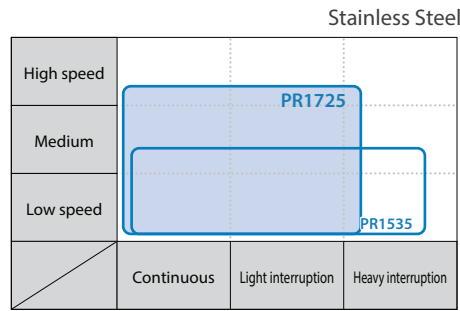
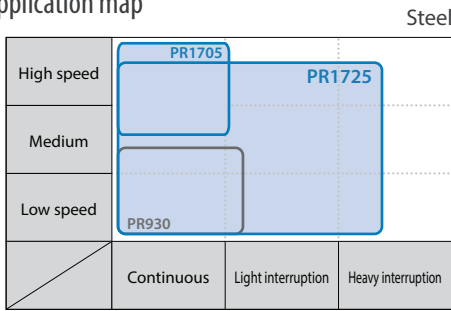

PVD coated carbide for small parts machining

PR1725

1st recommendation for steel machining
 Excellent surface finish and long tool life
 Great performance in small parts machining applications



MEGACOAT NANO PLUS

AlTiN/AlCrN Nano laminated film with superior wear resistance and adhesion resistance. Excellent surface finish and long tool life

Reduces cracking

Reduces abnormal damages such as chipping because of increased lamination layer with a thinner gap than conventional coatings

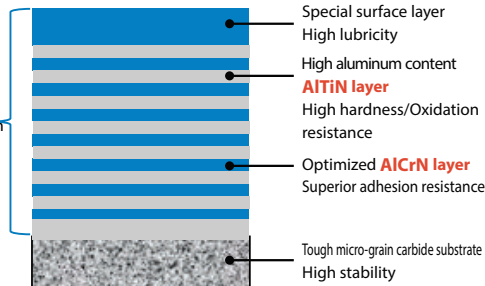

Wear coefficient comparison (Internal evaluation)

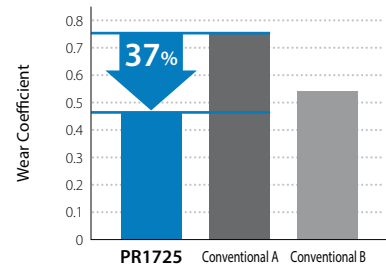

Superior wear and chipping resistance

High hardness with nano laminated film layer properties
 Internal stress optimization reduces chipping

Applicable to various workpiece materials

Excellent oxidation resistance. Superior high temperature properties maintains good performance in steel, stainless steel and free-cutting steel

Excellent surface finish

Special surface layer with great lubricity reduces adhesion

High machining stability

Tough micro-grain carbide substrate provides stable machining

Features of PR005S / PR015S

- Improved thermal properties help to reduce sudden fracture and decrease edge wear
 Improved thermal conductivity by optimum distribution of WC coarse grains
 Resists heat concentration at the cutting edge to promote stable machining
- Improved wear resistance with MEGACOAT HARD coating
 Excellent wear resistance with high-hardness and resists boundary damage with improved thermal properties

Fracture resistance comparison (Internal evaluation)

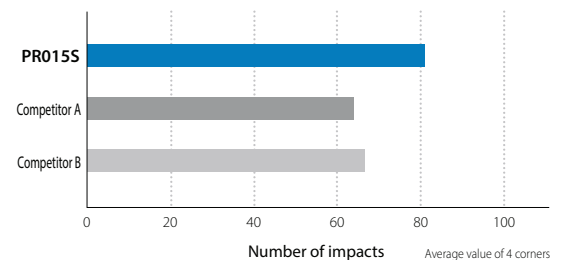

Cutting conditions : Vc = 25m/min, ap = 1.0 mm, f = 0.10 mm/rev, Wet
 CNMG120408 type Workpiece Material : Ni-based Superalloy
 Cylindrical workpiece with 1 flat face

PVD / CVD coated carbide (Milling / Drilling)

PVD coated carbide (MEGACOAT / MEGACOAT NANO)

PVD coated carbide grades for milling and drilling are coated on a very tough carbide substrate. Because of the low processing temperature of PVD compared with CVD, it features less deterioration and more bending strength.

CVD coated carbide

CVD coated carbide grades provide stable, efficient machining at high speeds or for heavy interrupted applications. Ti-base (TiN, TiCN) coating with superior hardness and wear resistance or ceramic-base (Al₂O₃) coating with high-thermal stability is applied on a tough carbide substrate. Superior fracture resistance and wear resistance.



Insert grades

Features of PVD / CVD coated carbide

Classification	Grade	Color	Coated composition	Advantages and applications
<div style="background-color: #0070C0; color: white; padding: 5px; text-align: center; border-radius: 5px;"> P Steel </div>	PR1230	Blackish red	MEGACOAT	<ul style="list-style-type: none"> • Superior wear and oxidation-resistant MEGACOAT on a special tough carbide substrate • Application: Stable and high feed milling and drilling of steel
	PR1525	Reddish green	MEGACOAT NANO	<ul style="list-style-type: none"> • New coating technology (MEGACOAT NANO) is applied. Nano thin multi-layer coating performs superior wear resistance and high oxidation resistance • Application: Stable and longer tool life for milling of steel and stainless steel
	CA520D	Gold	TiCN+Al ₂ O ₃ +TiN (CVD)	<ul style="list-style-type: none"> • Improved abrasion resistance and fracture resistance by improving high toughness • Combination of high toughness substrate, toughened coating and enhanced interface allow both wear and fracture resistance • Application: Drilling of steel - first recommended grade (for high speed machining)
<div style="background-color: #FFD700; color: black; padding: 5px; text-align: center; border-radius: 5px;"> M Stainless steel </div>	PR1225	Blackish red	MEGACOAT	<ul style="list-style-type: none"> • Superior wear and oxidation-resistant MEGACOAT on micro-grain carbide substrate • Application: General machining and high feed milling and drilling of steel and stainless steel
<div style="background-color: #D9534F; color: white; padding: 5px; text-align: center; border-radius: 5px;"> K Cast iron </div>	PR1210	Blackish red	MEGACOAT	<ul style="list-style-type: none"> • Superior wear and oxidation-resistant MEGACOAT coated on special carbide substrate • Application: Highly efficient stable milling and drilling of gray and nodular cast iron
	PR1510	Reddish green	MEGACOAT NANO	<ul style="list-style-type: none"> • New coating technology (MEGACOAT NANO) is applied. Nano thin multi-layer coating performs superior wear resistance and high oxidation resistance • Application: Highly fracture resistance and wear resistance for gray and nodular cast iron
	CA415D	Gold	TiCN+Al ₂ O ₃ +TiN	<ul style="list-style-type: none"> • Special carbide substrate for cast iron, toughened coating and enhanced interface allow both wear and fracture resistance • Application: Drilling of cast iron - 1st recommended material for high speed processing
	CA420M		TiCN+Al ₂ O ₃ +TiN (CVD)	<ul style="list-style-type: none"> • Kyocera's unique crystal control technology and advanced layer adhesion CVD coating with superior wear resistance and toughness • Application: Milling of gray and nodular cast iron
<div style="background-color: #8B4513; color: white; padding: 5px; text-align: center; border-radius: 5px;"> S Heat-resistant alloys Titanium alloys </div>	PR1535	Reddish green	MEGACOAT NANO	<ul style="list-style-type: none"> • Nano thin multi-layer coating (MEGACOAT NANO) improved wear resistance and stability • Application: For milling of Ni-base heat-resistant alloys, titanium alloys and precipitation hardened stainless steel
<div style="background-color: #8B4513; color: white; padding: 5px; text-align: center; border-radius: 5px;"> S Heat-resistant alloys </div>	CA6535	Gold	TiCN+Al ₂ O ₃ +TiN (CVD)	<ul style="list-style-type: none"> • High heat-resistance and wear resistance with CVD coating • Application: For milling of Ni-base heat-resistant alloys and martensitic stainless steel
<div style="background-color: #696969; color: white; padding: 5px; text-align: center; border-radius: 5px;"> H Hard material </div>	PR015S	Blackish Gray	MEGACOAT HARD	<ul style="list-style-type: none"> • Substrate with improved thermal properties reduces sudden fracture and decrease edge wear. MEGACOAT HARD coating technology delivers the high hardness and superior wear resistance • Excellent wear and chipping resistance maintains stable machining for high hard materials • Application : Difficult-to-cut materials and high hard (less than 60HRC) machining



Excellent grade for heat-resistant alloys and difficult-to-cut materials

CA6535

CVD: For martensitic stainless steel and Ni-base heat-resistant alloys

PR1535

PVD: For Ni-base heat-resistant alloys, titanium alloys and precipitation hardened stainless steel



Suitable for variety of workpiece materials

Stable machining by preventing sudden insert fracture. Suitable for high-efficiency machining



New development:
High toughness
substrate



CA6535

For martensitic stainless steel and Ni-base heat-resistant alloys.
High heat resistance and wear resistance with CVD coating.
Improved stability due to thin layer coating technology.

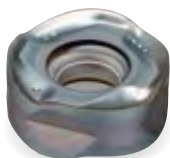
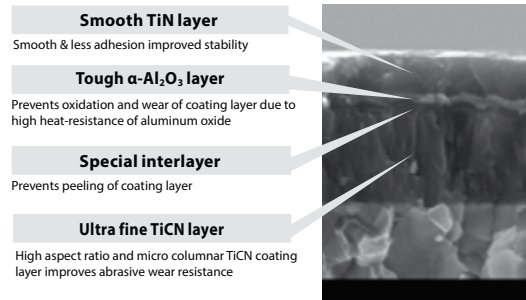

PR1535

For Ni-base heat-resistant alloys, titanium alloys and precipitation hardened stainless steel.
Stable and longer tool life by special nano thin multi-layer coating (MEGACOAT NANO)

MEGACOAT base multi-layer composition



Tool life comparison: Longer tool life and more stable machining than competitors

Ni-base heat-resistant alloys

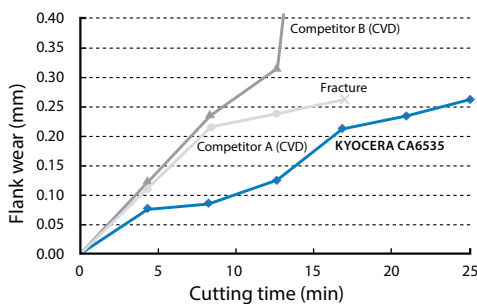

Cutting conditions: Vc = 50 m/min, ap = 1.0 mm, fz = 0.15 mm/t, wet
Internal evaluation

Martensitic stainless steel

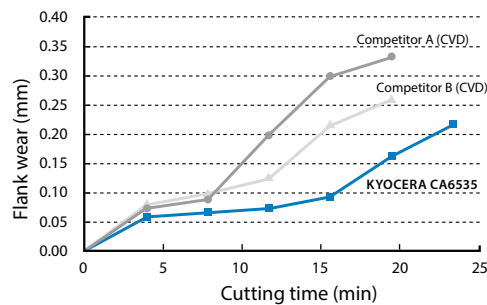

Cutting conditions: Vc = 300 m/min, ap = 2.0 mm, fz = 0.2 mm/t, wet
Internal evaluation

Carbide

Carbide

Uncoated tungsten carbide grade is used in a variety of applications due to its superior mechanical properties.

Features

- KW10: Suitable for machining cast iron with high hardness and toughness
- GW05, GW15, GW25: Suitable for machining cast iron, non-ferrous metals and non-metals
- SW series: Suitable for machining of titanium and titanium alloy



Features of carbide

Classification	Grade	Color	Main component	Advantages and applications
	KW10	Gray	WC+Co	<ul style="list-style-type: none"> • ISO identification symbol K carbide (K10 relevant) • Application: Machining cast iron, non-ferrous materials and non-metals
	GW05			<ul style="list-style-type: none"> • ISO identification symbol K carbide (K05 relevant) • Application: Excellent wear resistance for machining of cast iron and non-ferrous metal
	GW15			<ul style="list-style-type: none"> • ISO identification symbol K carbide (K10 relevant), tough micro-grain carbide • Application: Machining cast iron, non-ferrous materials and non-metals
	GW25			<ul style="list-style-type: none"> • ISO identification symbol K carbide (K30 relevant) • Application: Milling operations of aluminum
	SW05			<ul style="list-style-type: none"> • ISO identification symbol K carbide (K05 relevant) • Application: Titanium alloys for continuous machining and finishing
	SW10 (Made to order)			<ul style="list-style-type: none"> • ISO identification symbol K carbide (K10 relevant) • Application: Titanium alloys for continuous and light interrupted machining
	SW25 (Made to order)			<ul style="list-style-type: none"> • ISO identification symbol K carbide (K25 relevant) • Application: Titanium alloys for interrupted and light interrupted machining

DLC coated carbide

DLC coated carbide

DLC (Diamond-Like Carbon) Coated carbide is coated on carbide substrate with a thin layer of amorphous carbon.

Features

- High Hardness with Kyocera's proprietary hydrogen-free DLC coating
- Excellent surface finish achieved through anti-adhesion performance



Features of DLC coated carbide

Classification	Grade	Color	Coated composition	Advantages and applications
	PDL010	Rainbow color	C	<ul style="list-style-type: none"> • DLC coating of original technology has high hardness, excellent adhesion resistance and film peeling resistance • Application: Excellent finished surface processing and long service life of aluminum alloy
	PDL025			<ul style="list-style-type: none"> • High Hardness with Kyocera's Proprietary Hydrogen-free DLC Coating • Application: Long tool life and stable machining of aluminum alloys

Coating properties

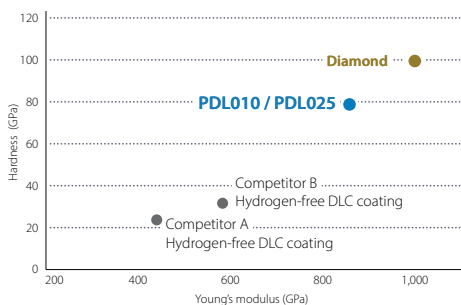

Adhesion resistance comparison

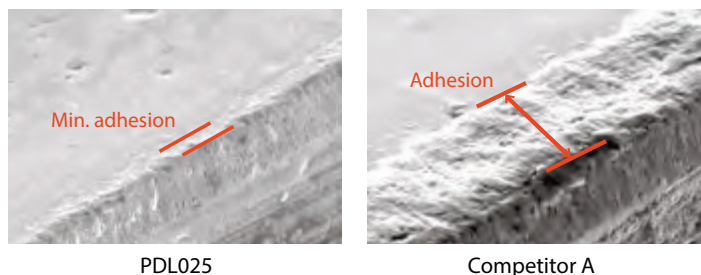

Cutting conditions: $V_c = 800$ m/min, $f_z = 0.1$ mm/t, $ap \times ae = 3 \times 3$ mm
 Dry, cutter dia. $\phi 25$ mm, workpiece material: A5052 cutting length: 57 m
 (Internal evaluation)

Ceramic

Ceramic

Ceramics inserts are capable of machining at high speeds. Recommended for hard turning of hardened steel or rough to finish turning of cast iron and heat-resistant alloys.

Features

- Excellent wear resistance enables high speeds machining of cast iron
- Ceramic maintains good surface finishes due to the low affinity to workpiece materials
- Silicon nitride ceramic can machine cast iron with coolant due to its superior thermal shock resistance



Insert grades

Features of ceramic

Classification	Grade	Color	Main component (Coated composition)	Coating layer	Hardness of substrate (GPa)	Fracture toughness (MPa·m ^{1/2})	Transverse strength (MPa)	Advantages and applications
	KA30	White	Al ₂ O ₃	-	17.5	4.0	750	<ul style="list-style-type: none"> • Aluminum oxide ceramic (Al₂O₃) • Application: Finishing of cast iron at high cutting speeds without coolant
	KS6015	Gray	Si ₃ N ₄		15.2	7.8	1,000	<ul style="list-style-type: none"> • Silicon nitride ceramic with superior wear resistance reduces heat at the cutting edge. • Application: Roughing and high speed machining of cast iron (with or without coolant)
	KS6050	Gray	Si ₃ N ₄	Thin coating	15.6	8.0	1,200	<ul style="list-style-type: none"> • Silicon nitride ceramic (Si₃N₄) • Application: Roughing and interrupted machining of cast iron. Focusing on stability. (with or without coolant)
	CS7050	Grayish white	Si ₃ N ₄ (Special Al ₂ O ₃ COAT)					<ul style="list-style-type: none"> • Silicon nitride ceramic (Si₃N₄) + CVD Coating (Special Al₂O₃ COAT) • Application: Finishing and continuous machining, and high speed and high efficient machining. (with or without coolant)
 	KT66	Black	Al ₂ O ₃ +TiC	-	20.1	4.1	980	<ul style="list-style-type: none"> • Aluminum oxide and titanium carbide ceramic (Al₂O₃+TiC) • Application: Semi-roughing to finishing of cast iron, and hard materials
	A66N	Gold	Al ₂ O ₃ +TiC (TiN COAT)					<ul style="list-style-type: none"> • TiN PVD coated aluminum oxide and titanium carbide ceramic (TiN coated Al₂O₃+TiN) • Application: Semi-roughing to finishing of hard materials
	PT600M	Blackish red	Al ₂ O ₃ +TiC (MEGACOAT)	Thin coating				<ul style="list-style-type: none"> • Heat-resistant MEGACOAT on aluminum oxide and titanium carbide ceramic (MEGACOAT Al₂O₃+TiC) • Application: Semi-roughing to finishing of cast iron, hard materials and hardened roll materials
	KS6030	Gray	SiAlON	-	15.2	6.0	600	<ul style="list-style-type: none"> • SiAlON Ceramic with superior wear resistance and high resistance against boundary wear • Application: Finishing to medium machining of heat-resistant alloys
	KS6040	Brown			16.7	7.0	900	<ul style="list-style-type: none"> • High stability SiAlON ceramic with wear resistance and fracture resistance • Application: Roughing of heat-resistant alloys

Application map

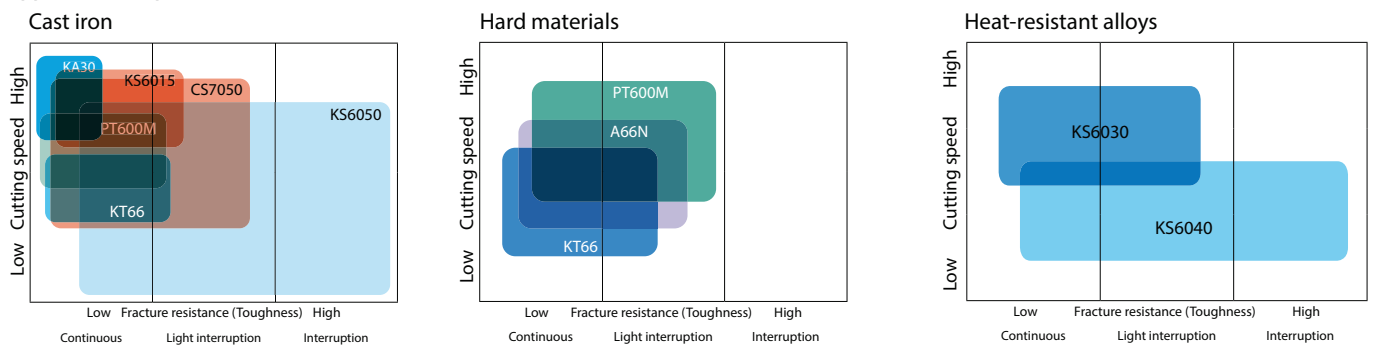

High-Temperature hardness

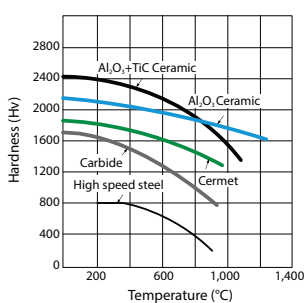

Properties of PVD coating

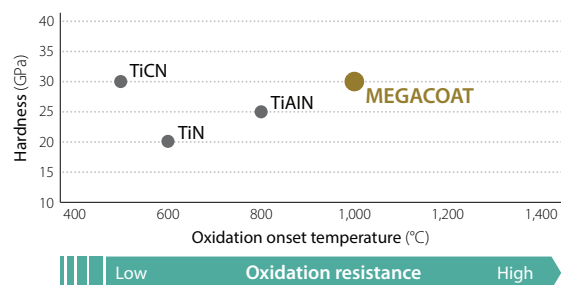

CBN (Cubic boron nitride)

CBN

CBN (Cubic Boron Nitride) is second only to diamond in hardness, and is a synthetically produced material with high thermal conductivity.

Features

- Superior wear resistance when machining hard materials
- Suitable for high speed machining of hard materials, sintered steel and cast iron
- High thermal conductivity provides stable machining



Features of CBN

Classification	Grade	Color	Ave. grain size (µm)	Hardness of substrate (GPa)	Transverse strength (MPa)	Advantages and Applications
<div style="border: 1px solid black; padding: 5px; display: inline-block;"> H Hard materials </div>	KBN510	Black	2	28	1,000	<ul style="list-style-type: none"> • Excellent wear resistance and crack resistance, non-coated CBN • Application: Finishing and continuous machining of hardened die steel
	KBN525		1 and under	25	1,250	<ul style="list-style-type: none"> • Application: General purpose for hardened steel
	KBN05M (MEGACOAT)	Blackish red	0.5-1.5	27	1,000	<ul style="list-style-type: none"> • Heat-resistant MEGACOAT on highly heat-resistant CBN substrate • Application: High speed finishing of hardened steel
	KBN10M (MEGACOAT)		2	28		<ul style="list-style-type: none"> • Application: High speed finishing of hardened die steel
	KBN25M (MEGACOAT)		1 and under	25	1,250	<ul style="list-style-type: none"> • Heat-resistant MEGACOAT on micro-grain CBN with heat-resistant binder phase • Application: Stable machining of hardened steel at high cutting speeds
	KBN020 (MEGACOAT TOUGH)		3	31-32	1,300	<ul style="list-style-type: none"> • High toughness CBN coated with high wear resistance enables machining in a wide range of cutting areas • Application: Continuous to interrupted machining of hardened steel
Sintered steel	KBN570	Black	2-4	34	1,350	<ul style="list-style-type: none"> • High content CBN • Application: Processing of sintered steel (burr suppression)
	KBN70M (MEGACOAT)	Blackish red				<ul style="list-style-type: none"> • Heat-resistant MEGACOAT on CBN rich substrate • Application: Stable machining of sintered steel (ferrous sintered alloys)
<div style="border: 1px solid black; padding: 5px; display: inline-block;"> K Cast iron </div>	KBN475	Black	2	39	1,400	<ul style="list-style-type: none"> • Excellent wear resistance due to high CBN content and special binder • Application: High speed machining of gray cast iron
	KBN60M (MEGACOAT)	Blackish red	0.5-6	33	1,250	<ul style="list-style-type: none"> • Heat-resistant MEGACOAT on CBN rich substrate with hard binder phase • Application: High speed finishing of gray cast iron
	KBN900 (TIN COAT)	Gold	9	31	630	<ul style="list-style-type: none"> • TIN coated solid CBN • Application: Heavy duty, interrupted machining and finishing of hardened steel, hardened roll steel and cast iron

For KBN35M, see page A18.

Advantages of MEGACOAT TOUGH

An adhesion layer is laminated between the high wear resistance layer and the CBN. Reduces layer peeling to achieve long tool life and stable machining.



Properties of PVD coating

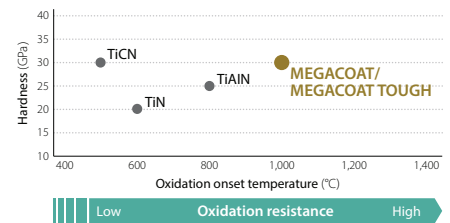

Application map

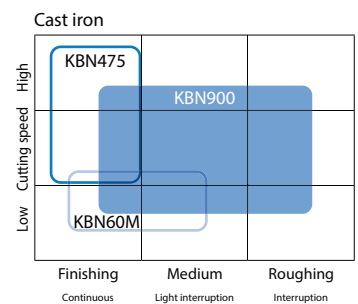
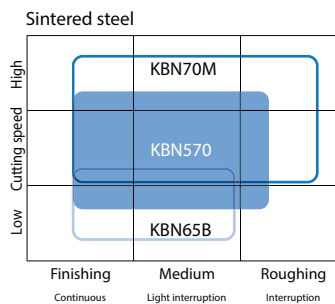
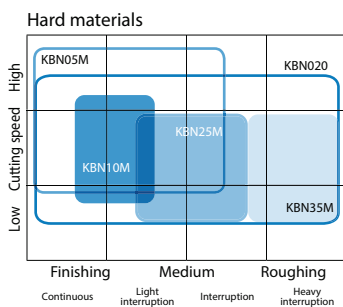



PCD (Polycrystalline diamond)

PCD

PCD is a synthetic diamond sintered under high temperatures and pressures.

Features

- Applicable for milling of non-ferrous metals and non-metals
- No edge build-up provides high precision machining
- Diversified applications for machining of non-ferrous metals and non-metals
- Finished surface will be rainbow colored (A mirror-like finished surface will not be obtained)



Features of PCD

Classification	Grade	Ave. grain size (μm)	Advantages and applications
	KPD001	0.5	<ul style="list-style-type: none"> • Super Micro-Grain PCD features cutting edge strength, wear resistance, fracture resistance, good edge-sharpening performance and longer, stable tool life • Application: High speed machining of aluminum alloys, brass, non-ferrous metals and non-metals including plastics, and carbide.
	KPD010	10	<ul style="list-style-type: none"> • Good wear resistance and toughness, good grindability • Application: High speed machining of aluminum alloys, brass, non-ferrous metals and non-metals including plastics, and carbide.
	KPD230	2-30	<ul style="list-style-type: none"> • Superior abrasive wear resistance and toughness due to high density PCD with mixed rough and fine grains • Application: High speed machining of aluminum alloys, brass, non-ferrous metals and non-metals including plastics.
	KPD250 (Made to order)	25	<ul style="list-style-type: none"> • Superior wear resistance due to rough grain PCD (25μm) • Application: High speed machining of high silicon aluminum alloy and machining of carbide

Applications

Workpiece material		Non-ferrous metals				Difficult-to-cut materials			
Cutting range		Finishing ← → Roughing				Finishing ← → Roughing			
Classification		N01	N10	N20	N30	S01	S10	S20	S30
Turning Milling	PCD	KPD001				KPD001			
		KPD010				KPD010			
		KPD230							
		KPD250							

Application map

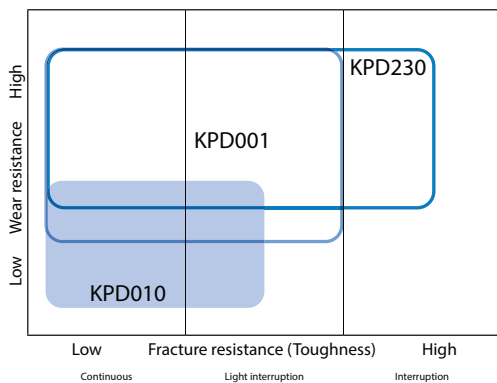

Surface finish roughness comparison of aluminum machining

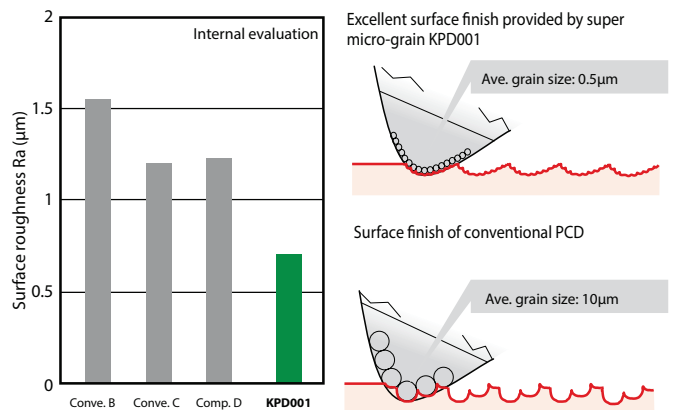

(Grain size affects surface finish quality)

Honeycomb structure CBN

Honeycomb structure CBN

Honeycomb structure is the high structural controlled composite material consisting of a hard and superior wear-resistance core (gray portion) and a tough shell (white portion).

Features

- Honeycomb structure CBN combine a hard, wear-resistant core and a tough shell into one insert.
- The tough shell stops cracks that form in the core.
- CBN is suitable for interrupted machining of exceptionally hard material

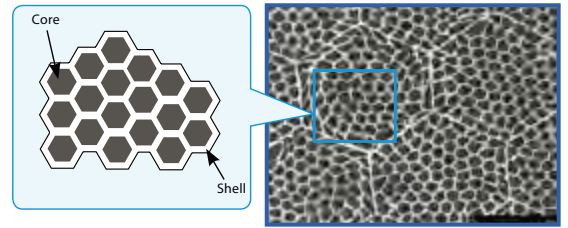

Features of honeycomb structure CBN

Classification	Grade	Color	Main component	Advantages and applications
H Hard materials	KBN35M (MEGACOAT)	Blackish red	CBN	<ul style="list-style-type: none"> • Honeycomb structure CBN composite material consisting of wear resistant CBN (core) and tough CBN (shell) • Heat-resistant MEGACOAT on tough Honeycomb structure CBN • Application: Stable machining of hardened steel at interrupted machining

KBN35M (MEGACOAT honeycomb structure CBN)

Tough CBN (shell) prevents crack growth

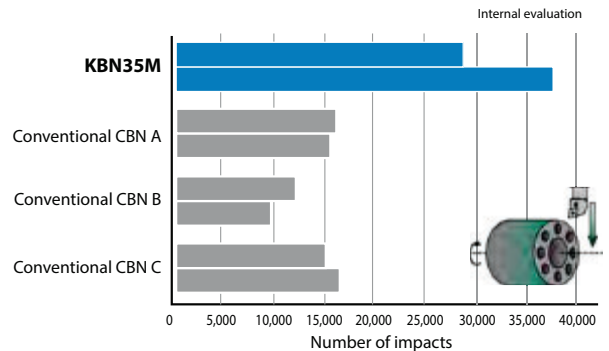
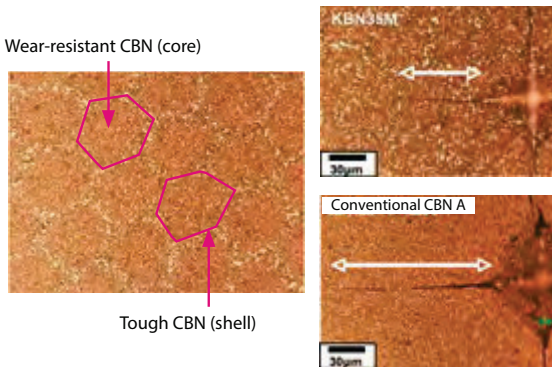

Application map

Hard materials

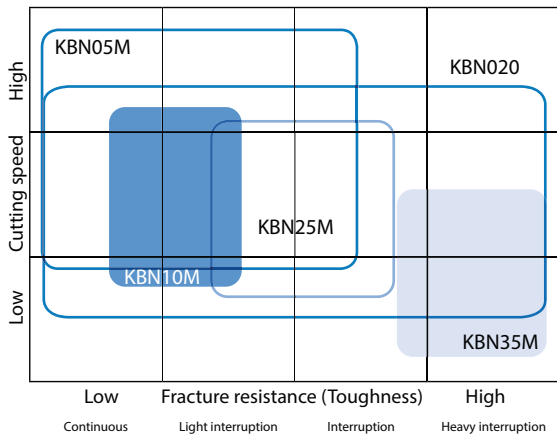

Insert material selection table



Insert grades

Applications		Cutting range	Steel	Stainless steel	Gray cast iron	Nodular cast iron	Non-ferrous metals	Heat-resistant alloys	Titanium alloys	Hard materials	Sintered steel		
Turning		Finishing	TN610	TN610	KBN475								
			CCX	TN620	KBN60M								
			TN620	TN620	KBN60M							KT66	
			TN60	TN60	KA30	TN60				KS6040		A66N	TN610
			PV710	PV720	PV7005	PV7005	KPD001	KW10			PT600M	TN60	
		PV720	CA6515	CA5505	CA5505	KPD010	CA6515	KPD001		KBN05M			
		PV730	CA6525	CA310	CA310	PDL010	CA6525	KPD010		KBN020	KBN570		
		CA510	PR1535	CA315	CA315	PDL025	PR0055	SW05		KBN10M	KBN70M		
		CA515			CA320	KW10	PR0155	SW10		KBN25M			
		CA025P						PR1535	SW25	KBN35M			
CA530	Roughing	CA530							KBN900				
Small tools		Finishing	TN610	TN610									
			TN620	TN620									
			PV710	PV720									
			PV720	PR1725	CA310	CA310	KPD001	CA6515	KPD001		KBN05M	TN610	
			PR1705	PR930	CA315	CA315	KPD010	PR1125	KPD010		KBN020	TN60	
		PR1725	PR1025	KW10	CA320	PDL010	PR1225	KW10		KBN10M	KBN570		
		PR930	PR1225		KW10	PDL025	PR1535	PR1535		KBN25M	KBN70M		
		PR1025	PR1535										
		PR1535											
		PR1535	Roughing										
Boring		Large	TN610										
			TN620										
			PV710	TN60									
			PV720	CA6515	KBN475								
			PV730	CA6525	KBN60M							PT600M	TN610
		CA515	PR1725	PV7005	PV7005	KPD001	CA6515	KPD001		KBN05M	TN60		
		CA025P	PR1025	CA310	CA310	KPD010	CA6525	KPD010		KBN020			
		CA530	PR1225	CA315	CA315	PDL010	PR1125	KW10		KBN10M	KBN570		
		PR1705	PR930	KW10	CA320	PDL025	PR1225	SW05		KBN25M	KBN70M		
		PR1725	PR1535		KW10	GW05	PR1535	PR1535					
PR1025				KW10									
PR930													
PR1535	Small												
Cut-Off		Large	CR9025	CR9025									
			PR930	PR930									
			PR915	PR915	KW10	KW10	PDL025	KW10	KW10				
			PR1215	PR1215	PR1215	PR1215	KW10	PR1225					
			PR1225	PR1225				PR660					
PR1535	PR1535												
Cut-Off		Small	PR1025	PR1025	KW10	KW10	PDL025	KW10	KW10				
			PR1225	PR1225			KW10	PR1025					
			PR1535	PR1535				PR1225					
Grooving		Glossy finish	TC40N	TC40N									
			TN620	TN620									
			TN90	TN90	PR905	PR905	KPD001	PR915	KPD001		KBN510	TC40N	
		PV7040	PV7040	PR1215	PR1215	PDL025	KW10	KW10		KBN525			
		PR930	PR930	KW10	KW10	KW10	PR1215			PT600M	KBN570		
		PR1115	PR1115	GW15	GW15	GW15	PR1225						
		PR1215	PR1215				PR1535	PR1535					
PR1225	PR1225												
PR1625	PR1625												
Threading		Glossy finish	TC60M	TC60M	KW10	KW10	KW10	KW10	KW10		PR1515		
			PR1215	PR1515	GW15	GW15	GW15	GW15	GW15		PR1115		
		PR1115	PR1115										
		PR930	PR930										
Drilling		Wear resistance	CA520D		CA415D								
			PR1225	PR1225	PR1210	PR1210	KW10	PR1225	KW10				
		PR1230	PR1535	KW10	KW10	GW15	KW10						
		PR1535				GW15	GW15						
Milling		Finishing	TN100M	CA6535			KPD230	CA6535	KPD230				
			TN620M	PR1225	PR1210	PR1210	KPD001	PR1225	KPD001				
			PV60M	PR1525	PR1510	PR1510	KPD010	PR1535	KW10		PR0155		
		PR1225	PR1535	KW10	KW10	PDL025		PR905					
		PR1230				KW10		PR1210					
						GW25		PR1535					

Highlighted materials are recommended choice.

Grade properties

Cermet

Grade	Color	Main component	Coating layer	Ratio	Hardness of substrate		Fracture toughness (MPa·m ^{1/2})	Transverse strength (MPa)
					(HV)	(GPa)		
TN610	Gray	TiCN	-	6.6	1,750	17.2	6.0	2,100
TN620				6.9	1,550	15.2	9.0	2,500
TN620M				6.9	1,550	15.2	9.0	2,500
TN6020				6.4	1,500	14.7	10.0	2,500
TN60		TiCN+NbC		6.6	1,600	15.7	9.0	1,760
TN90				6.4	1,450	14.2	10.0	1,960
TN100M				6.7	1,520	14.9	10.5	1,860
TC40				TiC+TiN	6.0	1,650	16.2	9.0
TC60		NbC		8.1	1,500	14.7	10.5	1,670

CVD coated cermet

Grade	Color	Coated composition	Coating layer	Ratio	Hardness of substrate		Fracture toughness (MPa·m ^{1/2})	Transverse strength (MPa)
					(HV)	(GPa)		
CCX	Gold	TiCN+Al ₂ O ₃ +TiN	Thin coating	7.0	1,500	14.7	10.0	2,600

PVD coated cermet

Grade	Color	Coated composition	Coating layer	Ratio	Hardness of substrate		Fracture toughness (MPa·m ^{1/2})	Transverse strength (MPa)
					(HV)	(GPa)		
PV710	Gold	MEGACOAT NANO	Thin coating	6.6	1,750	17.2	6.0	2,100PV730
PV720				6.9	1,550	15.2	9.0	2,500
PV730				7.0	1,550	14.2	10.0	2,500
PV7005	Blackish red	MEGACOAT		6.0	1,650	16.2	8.5	1,470
PV7040				6.0	1,650	16.2	9.0	1,570
PV90	Gold	TiN		6.4	1,450	14.2	10.0	1,960
PV60M	Gold	MEGACOAT NANO		6.6	1,600	15.7	9.0	1,760

CVD coated carbide

Grade	Color	Coated composition	Coating layer	Ratio	Hardness of substrate		Fracture toughness (MPa·m ^{1/2})	Transverse strength (MPa)			
					(HV)	(GPa)					
CA310	Rose Gold	TiCN+Al ₂ O ₃ +Ti base	Thick coating	15	1,570	15.4	12.0	2,780			
CA315				15	1,570	15.4	12.0	2,780			
CA320				15	1,570	15.4	12.0	2,780			
CA415D	Gold	TiCN+Al ₂ O ₃ +TiN		15	1,570	15.4	12.0	2,780			
CA420M				14.5	1,600	15.8	13.0	3,400			
CA4505	Blackish gray	TiCN+Al ₂ O ₃		15.0	1,790	17.5	9.5	2,350			
CA4515				15.0	1,570	15.4	12.0	2,780			
CA510	Gold	TiCN+Al ₂ O ₃ +TiN		14.5	1,470	14.4	11.5	2,500			
CA515				14.4	1,440	14.1	12.5	2,650			
CA520D				14.7	1,370	13.4	16.0	3,100			
CA025P				14.2	1,400	13.7	13.5	2,800			
CA525				14.2	1,360	13.3	13.5	2,750			
CA530				13.9	1,340	13.1	14.5	2,850			
CA5505				14.7	1,730	17.0	10.0	2,540			
CA5515				14.7	1,550	15.2	12.0	2,750			
CA5525				14.5	1,400	13.7	12.0	2,780			
CA5535				14.1	1,340	13.1	16.5	2,970			
CA6515				Thin coating	14.7	1,530	15.0	12.0	2,780		
CA6525					14.7	1,370	13.4	16.0	3,100		
CA6535					14.3	1,320	12.9	16.0	3,700		
CR9025					TiCN+TiN	Thick coating	14.5	1,400	13.7	12.0	2,780

Insert grades



Grade properties

PVD coated carbide

Grade	Color	Coated composition	Coating layer	Ratio	Hardness of substrate		Fracture toughness (MPa·m ^{1/2})	Transverse strength (MPa)
					(HV)	(GPa)		
PR005S	Gray black	MEGACOAT HARD	Thin coating	15.0	1,750	17.2	8.0	2,000
PR015S				14.9	1,680	16.5	9.0	2,400
PR905	Bluish violet	TiAlN		14.8	1,720	16.8	9.0	2,450
PR915				14.1	1,700	16.7	11.0	4,140
PR930	Reddish gray	TiCN		14.1	1,700	16.7	11.0	4,140
PR1025				14.5	1,600	15.8	13.0	3,400
PR1115	Purple red	TiAlN		14.7	1,700	16.7	11.0	3,000
PR1210	Blackish red	MEGACOAT		14.8	1,720	16.8	9.0	2,450
PR1215				14.7	1,700	16.7	11.0	3,000
PR1225				14.5	1,600	15.8	13.0	3,400
PR1230				13.7	1,450	14.2	13.0	2,250
PR1510	Reddish green	MEGACOAT NANO		14.8	1,720	16.8	9.0	2,450
PR1515				14.7	1,700	16.7	11.0	3,000
PR1525				14.5	1,600	15.8	13.0	3,400
PR1535				14.3	1,320	12.9	16.0	3,700
PR1625				14.5	1,600	15.8	13.0	3,400
PR1705			Silver	MEGACOAT NANO PLUS	14.9	1,800	17.6	10.0
PR1725	14.5	1,600			15.8	13.0	3,400	

Carbide

Grade	Color	Main component	Coating layer	Ratio	Hardness of substrate		Fracture toughness (MPa·m ^{1/2})	Transverse strength (MPa)
					(HV)	(GPa)		
KW10	Gray	WC+Co	-	15.0	1,650	16.2	10.0	1,470
GW05				14.9	1,800	17.6	10.0	3,300
GW15				14.7	1,700	16.7	11.0	3,000
GW25				14.5	1,600	15.8	13.0	3,400
SW05				15.0	1,790	17.5	9.5	2,350
SW10				14.8	1,720	16.8	9.0	2,450
SW25				14.7	1,370	13.4	16.0	3,100

DLC coated carbide

Grade	Color	Coated composition	Coating layer	Ratio	Hardness of substrate		Fracture toughness (MPa·m ^{1/2})	Transverse strength (MPa)
					(HV)	(GPa)		
PDL010	Rainbow color	C	Thin coating	15.0	1,650	16.2	10.0	1,470
PDL025				14.5	1,600	15.8	13.0	3,400

Turning indexable inserts

B

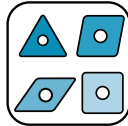

Introduction		B2	
Negative type chipbreaker		B4	
Positive type chipbreaker		B12	
Page Guide		B15	
Cermet / coated carbide / carbide lineup		B16	
Negative inserts	80° Rhombic	B16	
	55° Rhombic	B24	
	55° Parallelogram	B32	
	Round	B33	
	90° Square	B34	
	60° Triangle	B39	
	35° Rhombic	B47	
	80° Trigon	B50	
	Small double sided tools	B55	
	Small double sided tools	B56	
	Small double sided tools	B57	
	Positive inserts	80° Rhombic	B58
		55° Rhombic	B68
		70° Rhombic	B80
Round		B81	
90° Square		B82	
60° Triangle		B84	
35° Rhombic		B97	
80° Trigon		B105	
25° Rhombic		B108	
Bearing machining		Round / SNMF Type	B109
Inserts for back turning	TKFB	B110	
	TKF-GTP	B111	
	ABS / ABW	B112	
Ceramic lineup		B113	
Negative inserts	80° Rhombic	B113	
	55° Rhombic	B114	
	75° Rhombic	B115	
	Round	B116	
	90° Square	B117	
	60° Triangle	B118	
	35° Rhombic	B119	
	Positive inserts	Round	B120
Square		B121	
Triangle		B122	
Inserts for high hardened roll		B123	
Grooving inserts		B124	

B

Turning indexable inserts identification system



Turning indexable inserts

Symbol	Shape
H	Hexagon
O	Octagon
P	Pentagon
S	Square
T	Triangle
C	80° Rhombic
D	55° Rhombic
E	75° Rhombic
F	50° Rhombic
M	86° Rhombic
V	35° Rhombic
W	80° Trigon
L	Rectangle
A	85° Parallelogram
B	82° Parallelogram
K	55° Parallelogram
R	Round

Shown angle stands for acute angle for rhombic and parallelogram inserts.

«1» Shape symbol

Symbol	Relief angle
A	3°
B	5°
C	7°
D	15°
E	20°
F	25°
G	30°
N	0°
P	11°

«2» Relief angle symbol

Symbol Class	Tolerance (mm)			
	Corner Height	Thickness	I.C. Size	
A	±0.005	±0.025	±0.025	
F			±0.013	
C			±0.025	
H	±0.013			
E	±0.025		±0.13	±0.025
G			±0.13	±0.025
J	±0.005	±0.025	±0.05 - ±0.15	
K*	±0.013			
L*	±0.025			
M*	±0.08 - ±0.18			±0.13
E	±0.08 - ±0.18	±0.025	±0.13	
N*		±0.13 - ±0.38	±0.13	±0.08 - ±0.25
U*	±0.13 - ±0.38	±0.13	±0.08 - ±0.25	

* Insert's periphery is as fired. Tolerance difference is depending on insert size.

«3» Tolerance symbol

Symbol	Hole	Hole shape	Chipbreaker	Shape
N	No	-	No	
R			Single sided	
F			Double sided	
A	With hole	-	No	
M			Single sided	
G			Double sided	
W			No	
T	Yes	With hole and one countersink 40° - 60°	Single sided	
Q			No	
U	Yes	With hole and two countersink 40° - 60°	Double sided	
B			No	
H	Yes	With hole and one countersink 70° - 90°	Single sided	
C			No	
J	Yes	With hole and two countersink 70° - 90°	Double sided	
X			-	-

«4» Hole / Chipbreaker symbol

ISO
metric



ANSI
inch



«5» Edge length symbol (ISO)							«5» I.C. size (ANSI)		
C	D	R	S	T	V	W	I.C. size (mm)	IC size (inch)	Symbol
03	04		03	06			3.97	5/32	12
04	05		04	08	08		4.76	3/16	15
		05					5		
05	06		05	09		03	5.56	7/32	18
		06					6		
06	07		06	11	11	04	6.35	1/4	2
08	09		07	13		05	7.94	5/16	25
		08					8		
09	11	09	09	16	16	06	9.525	3/8	3
		12					10		
		12					12		
12	15	12	12	22	22	08	12.7	1/2	4
16	19	15	15	27	27	10	15.875	5/8	5
		16					16		
19	23	19	19	33	33	13	19.05	3/4	6
		20					20		
22	27		22	38			22.225	7/8	7
		25					25		
25	31	25	25	44	44	17	25.4	1	8
32	38	31	31	54	54	21	31.75	1-1/4	10
		32					32		

«6» Thickness symbol			
ISO		ANSI	
Thickness (mm)	Symbol	Thickness (inch)	Symbol
1.59	01	1/16	1
1.98	T1	5/64	12
2.38	02	3/32	15
2.78	T2	-	-
3.18	03	1/8	2
3.97	T3	5/32	25
4.76	04	3/16	3
5.56	05	7/32	35
6.35	06	1/4	4
7.94	07	5/16	5
9.525	09	3/8	6

Thickness displayed as the distance between bottom surface and highest point on cutting edge.

«7» Corner-R (RE) symbol			
ISO		ANSI	
Corner-R(RE) (mm)	Symbol	Corner-R(RE) (inch)	Symbol
Sharp corner	00	.000	00
0.03	003	.001	01
0.05	005	.002	013
0.1	01	.004	02
0.2	02	.008	05
0.4	04	1/64	1
0.8	08	1/32	2
1.2	12	3/64	3
1.6	16	1/16	4
2.0	20	5/64	5
2.4	24	3/32	6
2.8	28	7/64	7
3.2	32	1/8	8
Round insert	00 (inch) or M0 (metric)	Round insert	0

«8» Manufacturer's option
Hand symbol, chipbreaker symbol, etc.

· Expressed as edge length for ISO.
· ANSI expresses the inscribed circle diameter in inches.

Positive inserts identification system

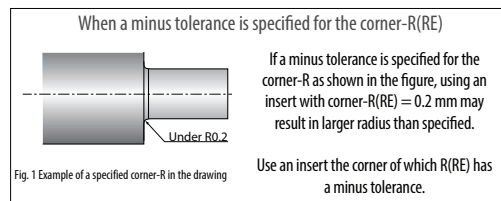
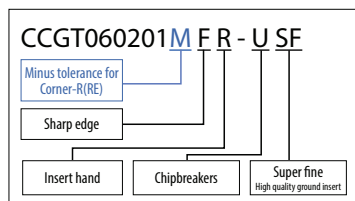
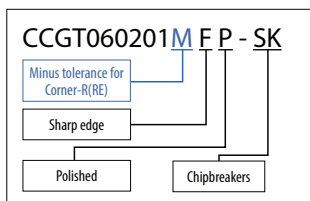



Insert colour

Red colour = New grade

Cermet

Grades	Cermet									CVD coated cermet	MEGACOAT NANO cermet				MEGACOAT cermet		PVD coated cermet
	TN610	TN620	TN620M	TN6020	TN60	TN90	TN100M	TC40N	TC60M	CCX	PV710	PV720	PV730	PV60M	PV7005	PV7040	PV90
Insert colour																	

CVD coated carbide

Grades	CVD coated carbide														
	CA310	CA315	CA320	CA415D	CA520D	CA420M	CA45 series	CA510	CA515	CA025P	CA525	CA530	CA55 series	CA65 series	CR9025
Insert colour															

PVD coated carbide

Grades	MEGACOAT NANO					MEGACOAT NANO PLUS		MEGACOAT HARD		MEGACOAT				PVD coated carbide				
	PR1510	PR1515	PR1525	PR1535	PR1625	PR1705	PR1725	PR0055	PR0155	PR1210	PR1215	PR1225	PR1230	PR905	PR915	PR930	PR1025	PR1115
Insert colour																		

Ceramic

Grades	Aluminum oxide ceramic			PVD coated ceramic		MEGACOAT ceramic		Silicon nitride ceramic		CVD coated silicon nitride ceramic		SiAlON ceramic			
	KA30	A65	KT66	A66N		PT600M		KS6015	KS6050	C57050		KS6030	KS6040		
Insert colour															

CBN & PCD

Grades	CBN				PCD			MEGACOAT TOUGH CBN / MEGACOAT CBN		PVD coated CBN
	KBN475	KBN510	KBN525	KBN570	KPD001	KPD010	KPD230	KBN020	KBN...M	KBN900
Insert colour										

DLC coated carbide

Grades	DLC coated carbide	
	PDL010	PDL025
Insert colour		

Uncoated carbide

Grades	Carbide				
	GW05	GW15	GW25	KW10	SW05
Insert colour					

B



Turning indexable inserts

Chip breakers

Steel (Molded chipbreaker)

Cutting Range	Name	Design		Advantages
Finishing	WF			<ul style="list-style-type: none"> Wiper insert Good chip control in finishing operations Excellent surface roughness by controlling adhesion Less cutting force due to sharp cutting edge
Finishing	WP			<ul style="list-style-type: none"> Wiper insert Good chip control at small machining
Finishing - Medium	WE			<ul style="list-style-type: none"> Wiper insert Good surface finish at high feed machining High productivity with smooth chip control in a wide range of applications
Finishing - Medium	WQ			<ul style="list-style-type: none"> Wiper insert Double feed rate possible while maintaining a smooth finish High efficiency and good chip control
Finishing	PP			<ul style="list-style-type: none"> 3-step dot structure realizes stable chip control at a wide range of feed rate Less cutting force due to sharp cutting edge and smooth rake face
Finishing - Medium	PQ			<ul style="list-style-type: none"> Stable chip control in a wide feed rate range by breaking chips effectively Well-balanced edge sharpness and toughness
Finishing	GP			<ul style="list-style-type: none"> Finishing to light machining Good chip control
Finishing - Medium	HQ			<ul style="list-style-type: none"> Sharp cutting performance with 3-D rake angle and double projection design
Finishing - Medium	CQ			<ul style="list-style-type: none"> Good chip control for varied ap such as copying Applicable to up facing

Applicable chipbreaker range (ap indicates radius)

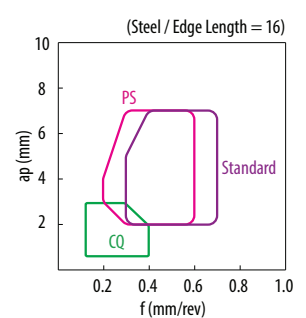
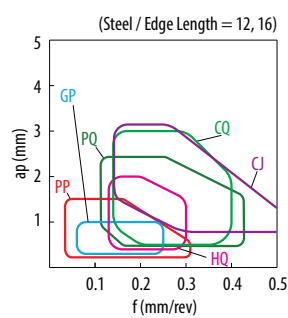
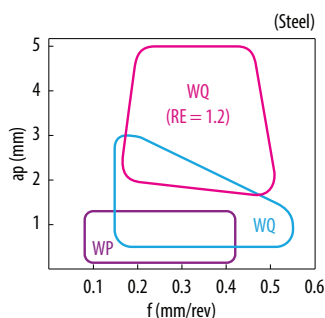
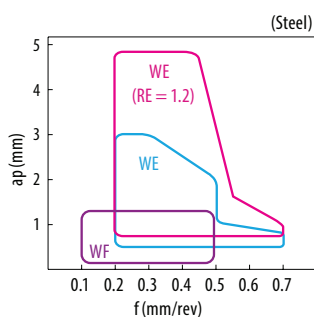

Steel (Molded chipbreaker)

Cutting Range	Name	Design	Advantages
Finishing - Medium / up facing	CJ		<ul style="list-style-type: none"> Improved chip curling at small machining and high feed rate machining Improved chip evacuation at copying and up facing
Medium - Roughing	PG		<ul style="list-style-type: none"> Stable machining with good balance of edge sharpness and strength Prevent chip dogging at high feed rate Good chip control at low feed rate Stable machining with wide chip control range
Medium - Roughing	GS		<ul style="list-style-type: none"> Strong edge chipbreaker Stable for continuous machining and light interrupted machining
Medium - Roughing	PS		<ul style="list-style-type: none"> General purpose chipbreaker More stable due to large contact surface

Cutting Range	Name	Design	Advantages
Medium - Roughing / High Feed Rate	PT		<ul style="list-style-type: none"> Low cutting force at high feed machining Land support structure
Medium - Roughing / High Feed Rate	GT		<ul style="list-style-type: none"> Strong edge chipbreaker Wide land design and smooth chip control even at high feed rate machining
Roughing Standard (without indication)			<ul style="list-style-type: none"> Low cutting force and applicable to large ap roughing

Applicable chipbreaker range (ap indicates radius)

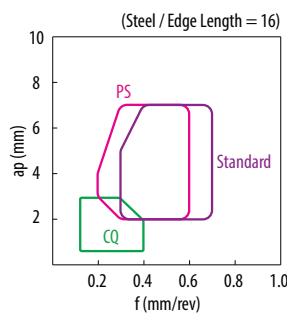
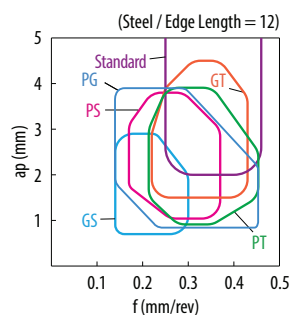
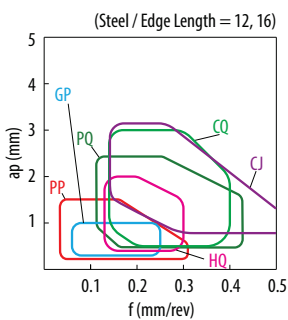

B



Turning indexable inserts

Steel (Molded chipbreaker)

Cutting Range	Name	Design	Advantages
Roughing	PH		<ul style="list-style-type: none"> Suitable for heavy interrupted machining and for workpieces with scale due to strong cutting edge

Cutting Range	Name	Design	Advantages
Roughing (high feed rate)	PX		<ul style="list-style-type: none"> Roughing and high feed rate operation Low cutting force chipbreaker

Applicable chipbreaker range (ap indicates radius)

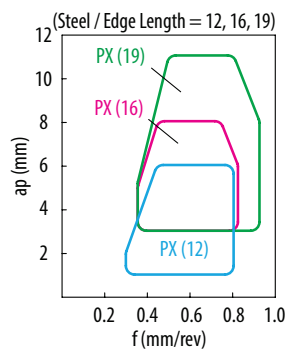
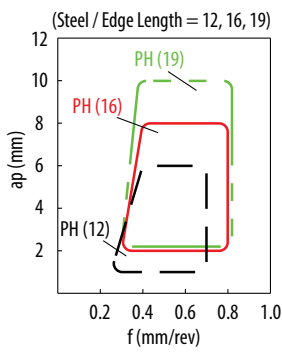

Steel (copying / undercutting , varied ap)

Cutting Range	Name	Design	Advantages
Finishing - Medium	VC		<ul style="list-style-type: none"> Handed chipbreaker for copying Good chip control at varied ap because of the large space on the main cutting edge side
Finishing - Medium	VF		<ul style="list-style-type: none"> Good chip control at varied ap such as copying and undercutting

Applicable chipbreaker range (ap indicates radius)

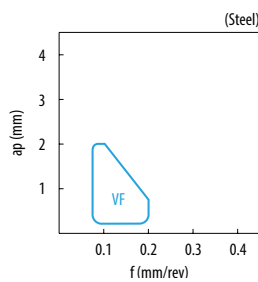
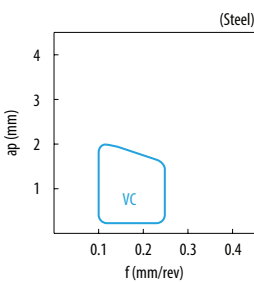



Low carbon steel (pipe / rolled plate / rolled steel)

Cutting Range	Name	Design	Advantages
Finishing	XF		<ul style="list-style-type: none"> Excellent chip control at high speed and small ap machining of low carbon steel
	XP		<ul style="list-style-type: none"> Short chips due to sharp cutting and special design
Medium	XQ		<ul style="list-style-type: none"> Consistent chip breaking due to moderate rake face and special design
	XS		<ul style="list-style-type: none"> Consistent chip breaking due to special rake face and rake angle design

Applicable chipbreaker range (ap indicates radius)

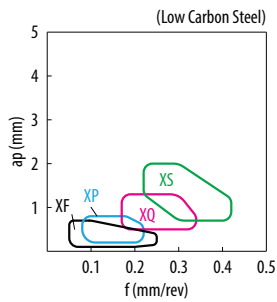

Steel / stainless steel (for automatic lathe)

Cutting Range	Name	Design	Advantages
Finishing - Medium	SK	<p>- FP-SK: Polished sharp edge - SK: Honed</p>	<ul style="list-style-type: none"> Machining in automatic lathes Sharp cutting performance equivalent to positive inserts 2-step dot design provides reliable chip control at various ap
Medium - Roughing	FP-TK		<ul style="list-style-type: none"> Good in automatic lathes (When machining workpieces of medium to large diameter) Superior cutting performance achieved by sharp edge and polished surface Smooth chipbreaker geometry improves chip flow with less adhesion Large curled chips
Large ap	LD		<ul style="list-style-type: none"> Available for greater depths of cut than many conventional chipbreakers Achieves high-precision machining in a single pass Chipbreaker shape optimized for various depths of cut Stable chip control in a wide range of machining applications

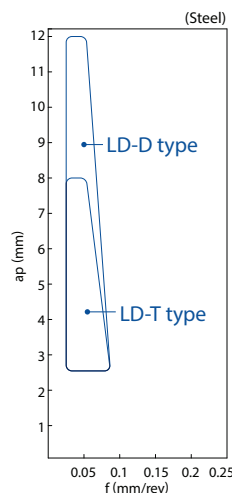
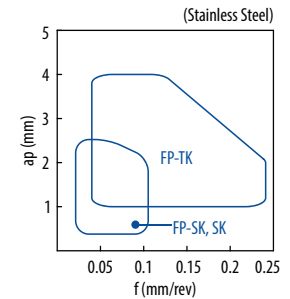
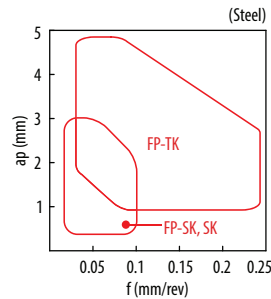

B



Turning indexable inserts

Chip breakers

Stainless steel / heat-resistant alloys / titanium alloy

Cutting Range	Name	Design	Advantages
Finishing	MQ		<ul style="list-style-type: none"> • Large rake angle • Low cutting force and good chip control
Medium - Roughing	MS		<ul style="list-style-type: none"> • Superior cutting edge sharpness and strength achieved by a positive land • Extra strength of cutting edge inhibits damage from wall shouldering
Medium - Roughing	MU		<ul style="list-style-type: none"> • Large rake angle reduces cutting force • Less burring achieved by diminishing damage from notching

Cutting Range	Name	Design	Advantages
Medium - Roughing	TK		<ul style="list-style-type: none"> • Smooth chipbreaker geometry improves chip flow with less adhesion • Large curled chips
Medium - Roughing	ST		<ul style="list-style-type: none"> • Less cutting force due to large rake angle • Less notching by special design

Applicable chipbreaker range (ap indicates radius)

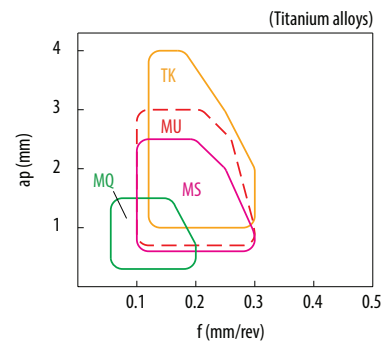
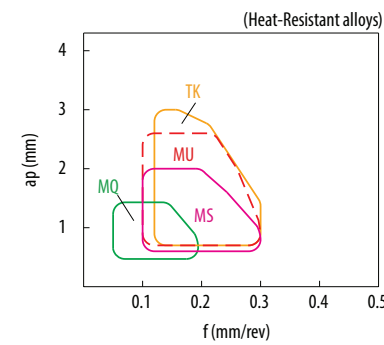
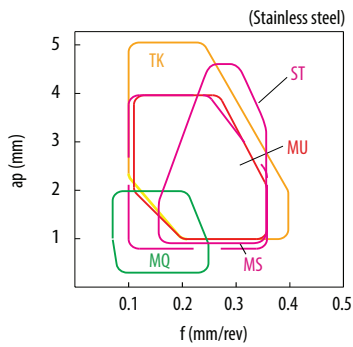



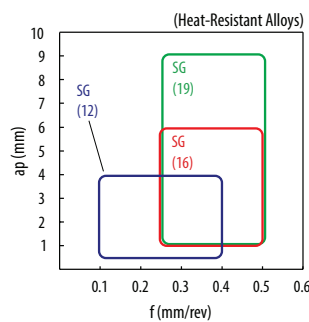
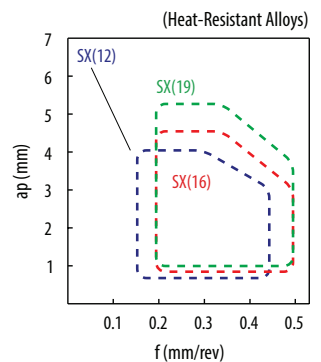
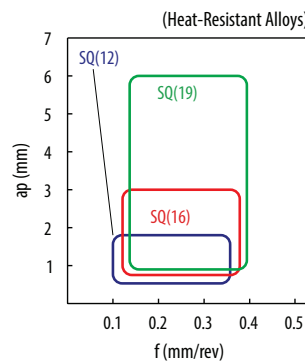

Heat-resistant alloys

Cutting Range	Name	Design	Advantages
Finishing - Medium	SQ		<ul style="list-style-type: none"> • Effective for burr suppression and reducing notching by slant cutting edge (inclined in (-) direction)
Roughing	SG		<ul style="list-style-type: none"> • Well-balanced edge strength • Cutting force reduction for stable machining at high-load cutting • Shallow and gently curved breaker controls chips smoothly
Roughing	SX		<ul style="list-style-type: none"> • Slant cutting edge reduces cutting force • Less burring achieved by unique cutting edge design

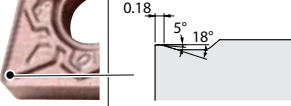

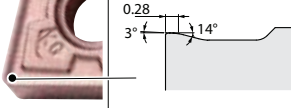
Cast iron (K series)

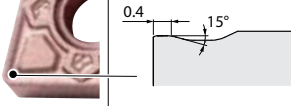
Cutting Range	Name	Design		Advantages
Sharp cutting oriented	KQ			<ul style="list-style-type: none"> • Sharp cutting chipbreaker • Edge geometry is suitable for workpieces that require sharpness such as thin-walled
Roughing	KG			<ul style="list-style-type: none"> • Excellent balance of sharpness and strength • Realized stability at continuous machining
Roughing	KH			<ul style="list-style-type: none"> • Good for heavily interrupted machining • Strong edge chipbreaker • Improved locating / seating in the toolholder pocket, high reliability achieved

Applicable chipbreaker range (ap indicates radius)

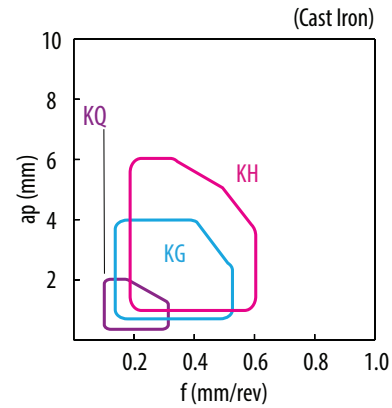



B

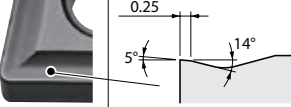
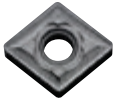
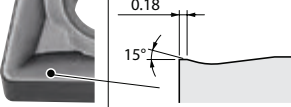

Turning indexable inserts

Cast iron

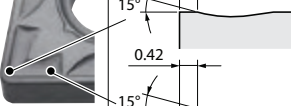
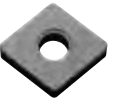
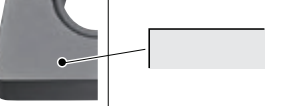
Cutting Range	Name	Design		Advantages
Sharp cutting oriented	Standard (Without Indication)			<ul style="list-style-type: none"> • Standard type for continuous to light interrupted cut (Low cutting force)
	C			<ul style="list-style-type: none"> • High feed rate chipbreaker for continuous to light interrupted cut
	ZS			<ul style="list-style-type: none"> • Standard type for light interrupted to interrupted cut (Stability oriented)
	Without chipbreaker			<ul style="list-style-type: none"> • High feed rate chipbreaker for light interrupted to interrupted cut

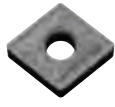
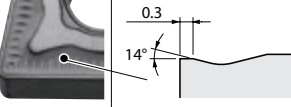
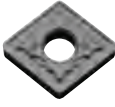
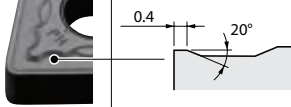
Cutting Range	Name	Design		Advantages
Stability oriented	GC			<ul style="list-style-type: none"> • For heavy interrupted cut (Tough edge chipbreaker)
	PH			<ul style="list-style-type: none"> • For roughing • Suitable for heavy interrupted cut and for workpieces with scale due to strong cutting edge

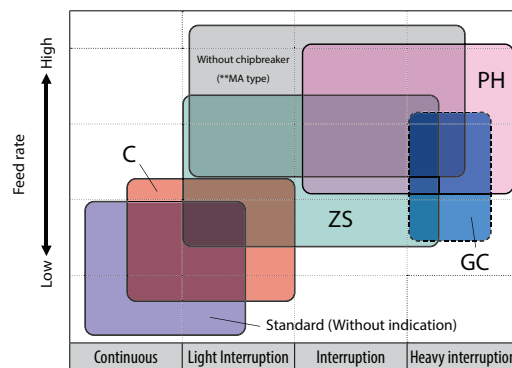

B

Non-ferrous metals



Turning indexable inserts

Cutting Range	Name	Design	Advantages
Finishing - Medium	A3		<ul style="list-style-type: none"> • Large rake angle and smooth surface • Good chip control and less adhesion

Cutting Range	Name	Design	Advantages
Medium - Roughing	AH		<ul style="list-style-type: none"> • Polished chipbreaker • Smooth chip control and less adhesion <p>G class: Sharp edge M class: Horned edge prep.</p>



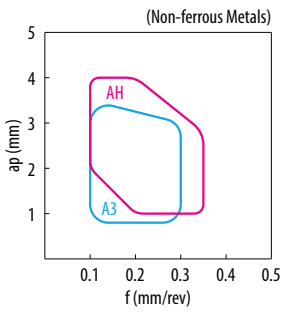



Applicable chipbreaker range (ap indicates radius)

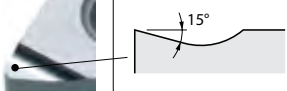

A3 chipbreaker	
	ap = 2 mm f = 0.2 mm/rev
	ap = 2 mm f = 0.3 mm/rev

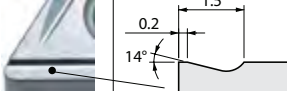
AH chipbreaker	
	ap = 2 mm f = 0.2 mm/rev
	ap = 2 mm f = 0.3 mm/rev

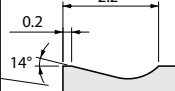
Steel (Ground chipbreaker)

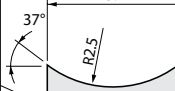
Cutting Range	Name	Design		Advantages
Finishing	S			<ul style="list-style-type: none"> • Sharp edge and less cutting force • Good chip control and smooth chip evacuation
Finishing - Medium	B			<ul style="list-style-type: none"> • Suitable for general purpose machining at feed rate 0.15 to 0.25mm/rev
Medium - Roughing	C			<ul style="list-style-type: none"> • Suitable for general purpose machining at feed rate 0.20 to 0.35 mm/rev
Medium - Roughing / Low cutting force	25R			<ul style="list-style-type: none"> • Applicable to sticky material such as low carbon steel • Large rake angle and suitable for stainless steel

B
Turning indexable inserts

Effectiveness of ground chipbreaker

1. Lower cutting force and improve edge
2. Improved adhesion resistance
3. Improved dimension accuracy and finishing surface accuracy
4. Controlled chip evacuation direction

Specification of B, C and parallel ground chipbreaker

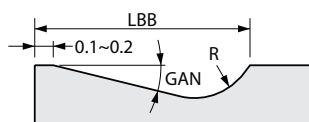

Insert type	Size	Chipbreaker name	LBB	GAN	R
CNGG	09,12	Without indication (Similar to C)	2.2	14°	1.0
WNGG	06	Without indication (Similar to C)	2.2	14°	1.0
TNGG	11,16	B	1.5	14°	0.5
	16,22	C	2.2	14°	1.0
DNGG	11,15	Without indication (Similar to C)	2.5	14°	2.0
VNGG	16	Without indication (Similar to B)	1.5	14°	0.5
SNGG	09,12	B	1.5	14°	0.5
	12	C	2.2	14°	1.0

Applicable chipbreaker range (ap indicates radius)

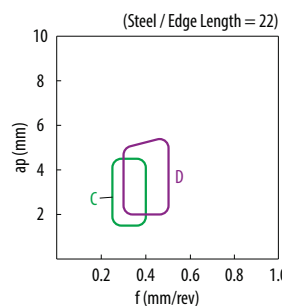
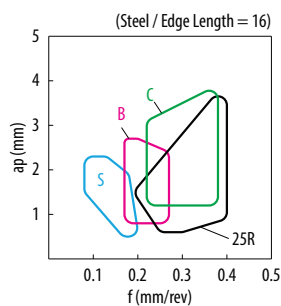
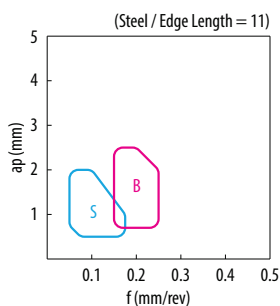

B



Turning indexable inserts

Chip breakers

Steel (Molded chipbreaker)

Name	Design	Advantages
Minute ap CF		• Available for minute ap (0.02 to 0.2 mm) finishing
Finishing PF		• Chipbreaker for finishing boring available from ap 0.15~0.6 mm
Finishing GF		• Chips fragmented in small pieces in machining of small ap
Finishing - Medium GQ		• Wide range of conditions by using the optimum chipbreaker width according to the cutting depth
Finishing SKS		• Chipbreaker for finishing available from 0.2~1.5mm • Rake face, bottom face and chipbreaker face provide stable chip control.
Finishing SK		• Sharp cutting performance due to large rake angle • Large dot to the corner edge improved chip control in a wide feed rate range
Finishing CK		• Good cutting performance • Applicable without hand for two direction machining on automatic lathe
Finishing WP		• Wiper insert • Good surface finish and good chip control at high feeds • Reduces surface finish galling

Name	Design	Advantages
Finishing - Medium GK		• Good chip evacuation at wide range by breaker dot and wide chip pocket
Finishing PP		• 1st. recommendation • Stable chip control in a wide feed rate range • Stable tool life due to special edge design with sharpness and improved strength
Finishing DP		• Consistent chip breaking performance for finishing
Finishing GP		• Good chip control
Finishing VF		• Good chip control for varied ap such as copying and undercutting
Finishing - Medium HQ		• General purpose chipbreaker for medium machining
Medium G		• Chipbreaker for short chips
Medium Standard (without indication)		• Strong edge chipbreaker

Applicable chipbreaker range (ap indicates radius)

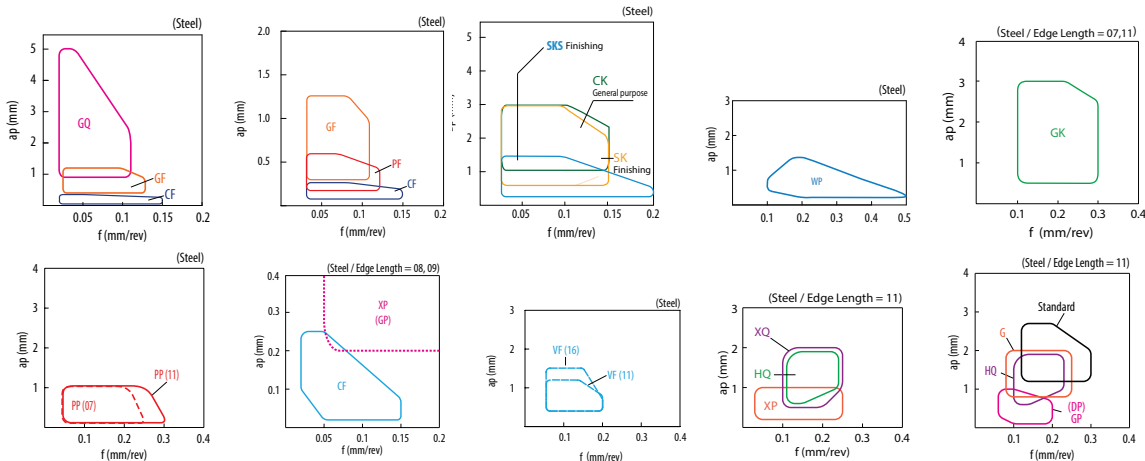

Steel (Ground chipbreaker)

Cutting Range	Name	Design	Advantages
Finishing	Lead (Without Indication)		• Good chip control at finishing to light machining with low cutting force
Finishing	F		• Good chip control at finishing to light machining with low cutting force
Finishing	P		• Flows chips towards the inlet of hole • Sharp edge
Medium	Y		• Sharp cutting performance and good surface finish
Low Feed	J		• Slant chipbreaker width and chip control at various ap • Applicable to automatic lathes
Low Feed	U		• Good chip control at low feed rate and varied ap with low cutting force

Cutting Range	Name	Design	Advantages
Finishing	A		• Large rake angle and low cutting force • Narrow chipbreaker width and consistent chip control
Finishing - Medium	B		• General purpose chipbreaker for medium machining • Good balance between chip control and sharp cutting
Medium	C		• Applicable to high load machining • Good chip flow and less resistance
Medium	H		• Sharp cutting performance and small curled chips

Specification of A, B, C and parallel ground chipbreaker

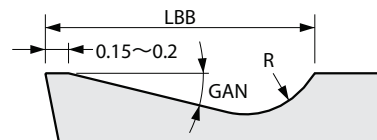

Insert type	Size	Chipbreaker name	LBB	GAN	R
TPGR	11	A	1.0	17°	0.5
	11,16	B	1.5	14°	0.5
	16	C	2.2	14°	1.0
SPGR	09	Without Indication (Similar to B)	1.5	14°	0.5
	12	Without Indication (Similar to C)	2.2	14°	1.0

Applicable chipbreaker range (ap indicates radius)

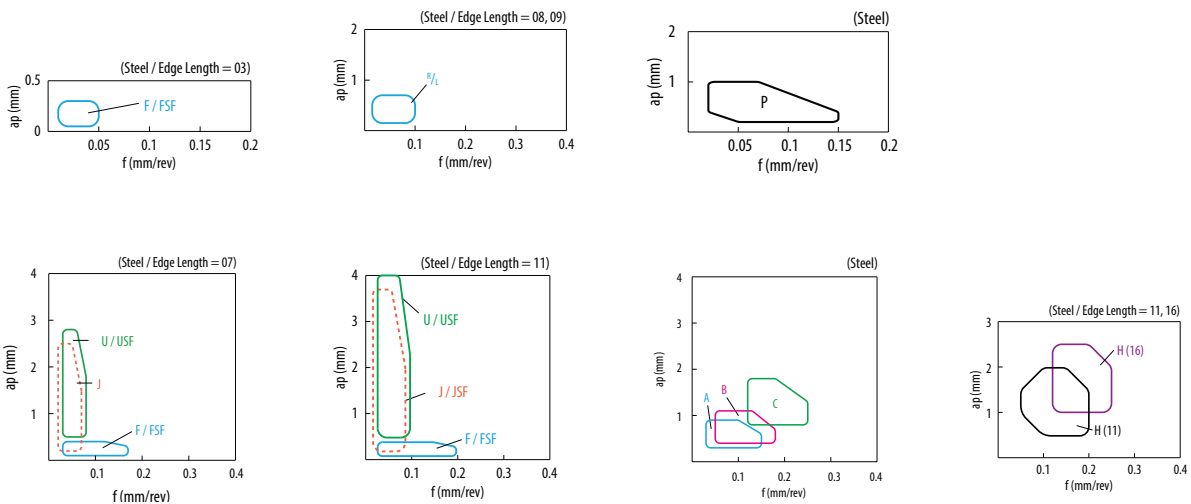

B



Turning indexable inserts

Chip breakers

Low carbon steel (pipe / rolled plate / rolled steel)

Cutting Range	Name	Design	Advantages
Finishing	XP		<ul style="list-style-type: none"> Consistent chip breaking performance even for low carbon steel and sticky material

Cutting Range	Name	Design	Advantages
Finishing - Medium	XQ		<ul style="list-style-type: none"> Wide chip control range and sharp cutting performance Suitable for low carbon steel and sticky material

Applicable chipbreaker range (ap indicates radius)

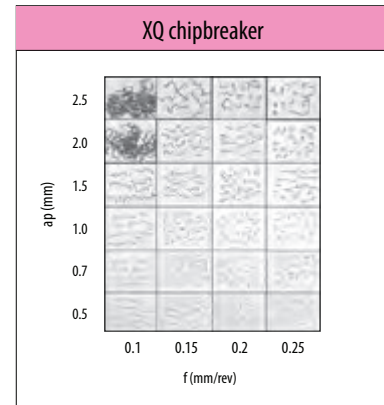
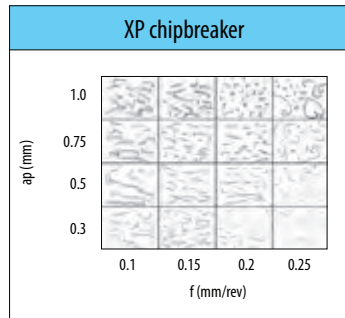
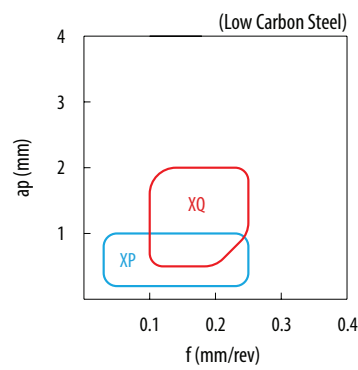

Stainless steel

Cutting Range	Name	Design	Advantages
Finishing	MQ		<ul style="list-style-type: none"> Good chip evacuation at internal turning Small curled chips Prevents chip entanglement with toolholder and stabilizes surface roughness

Applicable chipbreaker range (ap indicates radius)

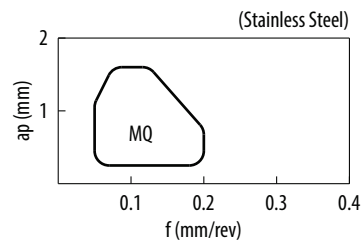

Non-ferrous metals

Cutting Range	Name	Design	Advantages
Finishing	AP		<ul style="list-style-type: none"> Curved edge and shape of chipbreaker lead good chip control Sharp cutting edge provides excellent surface finish Polished chipbreaker
Finishing - Medium	AH		<ul style="list-style-type: none"> Positive chip groove and good chip control with low cutting force Polished surface reduces adhesion

Cutting Range	Name	Design	Advantages
Finishing - Medium	A3		<ul style="list-style-type: none"> Large rake angle, smooth chip flow and less adhesion Superior cutting performance achieved by sharp edge

Applicable chipbreaker range (ap indicates radius)

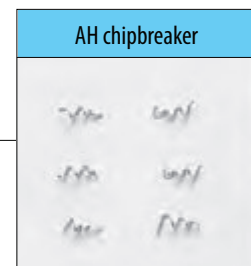
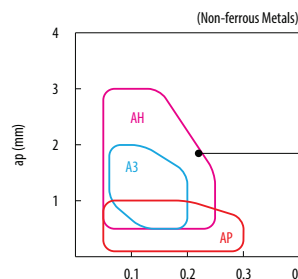



How to read pages of turning inserts

- Ref. to below for page contents of "Turning Inserts"
- Some contents are same in Chapter C

Classification of usage	Recommended grades for each applications and workpiece materials are shown here.
✳: Interruption / 1st Choice	
✳: Interruption / 2nd Choice	
●: Light interruption / 1st Choice	
○: Light interruption / 2nd Choice	
●: Continuous / 1st Choice	
○: Continuous / 2nd Choice	
(In case hardness is 45HRC or under)	

80° Rhombic

Insert corner radius

Classification of usage

Material	Free-cutting steel	Carbon steel / Alloy steel	Stainless steel	Gray cast iron	Nodular cast iron	Non-ferrous metals	Heat-resistant alloy	Titanium alloy	Hard materials	Applicable toolholder
P	●	●	●	●	●	●	●	●	●	
M	●	●	●	●	●	●	●	●	●	
K	●	●	●	●	●	●	●	●	●	
N	●	●	●	●	●	●	●	●	●	
S	●	●	●	●	●	●	●	●	●	
H	●	●	●	●	●	●	●	●	●	

How to read pages of "Turning inserts" See page B15

Insert	Description	Applicable chipbreaker range	No. of Edges	Dimension (mm)				Carbide								Cermet				Applicable toolholder
				IC	S	D1	RE	CVD				Cermet								
								CB	CB	PVD	PVD	-	-	-	-					
	CNMG 120404WF 120408WF With Wiper Edge	1	4	12.7	4.76	5.16	0.4 0.8	●●●●				●●●●				D8-D10 F116 F125 F126				
								●●●●				●●●●								
	CNMG 120404WP 120408WP With Wiper Edge	2	4	12.7	4.76	5.16	0.4 0.8	●●●●				●●●●								
								●●●●				●●●●								
	CNMG 120404WE 120408WE 120412WE With Wiper Edge	1	4	12.7	4.76	5.16	0.4 0.8 1.2	●●●●				●●●●								
								●●●●				●●●●								
	CNMG 120404WQ 120408WQ 120412WQ With Wiper Edge	2	4	12.7	4.76	5.16	0.4 0.8 1.2	●●●●				●●●●								
								●●●●				●●●●								
	CNMG 120402PP 120404PP 120408PP 120412PP	3	4	12.7	4.76	5.16	0.2 0.4 0.8 1.2	●●●●				●●●●								
								●●●●				●●●●								
	CNMG 090404GP 090408GP	4	4	9.525	4.76	3.81	0.4 0.8	●●●●				●●●●				D10 F126				
								●●●●				●●●●								
CNMG 120402GP 120404GP 120408GP	3	4	12.7	4.76	5.16	0.2 0.4 0.8	●●●●				●●●●				D8-D10 F116 F125 F126					
							●●●●				●●●●									
CNMG 120494PQ 120408PQ 120412PQ	3	4	12.7	4.76	5.16	0.4 0.8 1.2	●●●●				●●●●									
							●●●●				●●●●									

See "Precautions when using Wiper inserts" in the R34 and R35 for W/WE chipbreakers.

Applicable chipbreaker range

1	2	3	4

●: Standard item R: Right-hand only L: Left-hand only □: Check availability

B16

Availability

80° Rhombic

How to read pages of "Turning inserts" See page B15

B



Turning indexable inserts

Chip breakers

Negative



Ceramic

Insert	Description	Applicable chipbreaker range	Dimension (mm)				Material														Applicable toolholder	
			No. of edges	IC	S	D1	RE	Material														
								Material														
								Material														
Finishing	CNMG 120404WF 120408WF	1	4	12.7	4.76	5.16	0.4 0.8	Free-cutting steel Carbon steel / Alloy steel Stainless steel Gray cast iron Nodular cast iron Non-ferrous metals Heat-resistant alloy Titanium alloy Hard materials	P M K N S H													
With Wiper Edge							CA02SP CA310 CA315 CA320 CA4505 CA4515 CA510 CA515 CA525 CA530 CA5505 CA5515 CA5525 CA5535 CA6515 CA6525 PRT1535 CCX	PVD CVD	PVD CVD	PVD CVD												
Finishing	CNMG 120404WP 120408WP	2	4	12.7	4.76	5.16	0.4 0.8															
With Wiper Edge																						
Finishing - Medium	CNMG 120404WE 120408WE 120412WE	1	4	12.7	4.76	5.16	0.4 0.8 1.2															D8~D10 F116 F125 F126
With Wiper Edge																						
Finishing - Medium	CNMG 120404WQ 120408WQ 120412WQ	2	4	12.7	4.76	5.16	0.4 0.8 1.2															
With Wiper Edge																						
Finishing	CNMG 120402PP 120404PP 120408PP 120412PP	3	4	12.7	4.76	5.16	0.2 0.4 0.8 1.2															
Finishing	CNMG 090404GP 090408GP	4	4	9.525	4.76	3.81	0.4 0.8															D10 F126
Finishing	CNMG 120402GP 120404GP 120408GP	3	4	12.7	4.76	5.16	0.2 0.4 0.8															D8~D10 F116 F125 F126
Finishing - Medium	CNMG 120404PQ 120408PQ 120412PQ	3	4	12.7	4.76	5.16	0.4 0.8 1.2															

See "Precautions when using Wiper inserts" in the R34 and R35 for WF/WE chipbreakers.

Applicable chipbreaker range

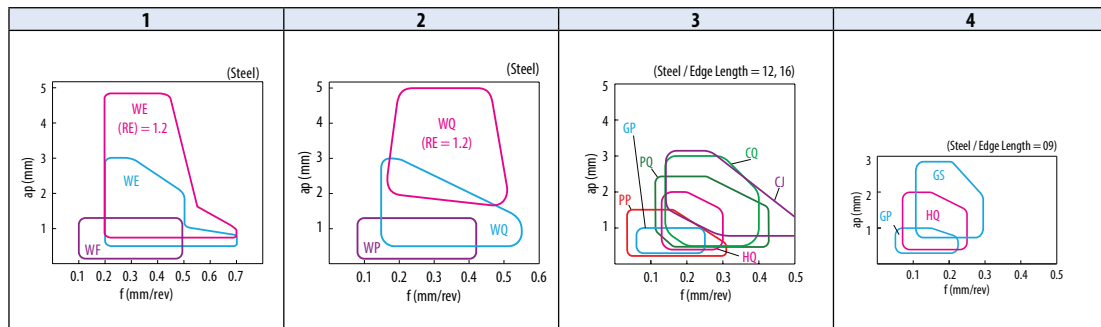

● : Standard item R : Right-hand only L : Left-hand only □ : Check availability

80° Rhombic

How to read pages of "Turning inserts" See page B15

Insert		Description		Applicable chipbreaker range		Dimension (mm)				Material										Applicable toolholder				
						No. of edges	IC	S	D1	RE	Material													
											Carbide					Cermet								
											CVD					PVD		PVD			-			
Free-cutting steel		Carbon steel / Alloy steel		Stainless steel		Gray cast iron		Nodular cast iron		Non-ferrous metals		Heat-resistant alloy		Titanium alloy		Hard materials		P						
Finishing - Medium		CNMG 090404HQ 090408HQ		1		4	9.525	4.76	3.81	0.4 0.8	●	●	●	●	●	●	●	●	●	●	●	●	D10 F126	
Finishing - Medium		CNMG 120404HQ 120408HQ 120412HQ		2		4	12.7	4.76	5.16	0.4 0.8 1.2	●	●	●	●	●	●	●	●	●	●	●	●	●	D8~D10 F116 F125 F126
Finishing - Medium		CNMG 120404CQ 120408CQ 120412CQ		2		4	12.7	4.76	5.16	0.4 0.8 1.2	●	●	●	●	●	●	●	●	●	●	●	●	D8~D10 F116 F125 F126	
Finishing - Medium		Up facing CNMG 160608CQ 160612CQ		2		4	15.875	6.35	6.35	0.8 1.2	●	●	●	●	●	●	●	●	●	●	●	●	D10	
Finishing - Medium		Up facing CNMG 120408CJ 120412CJ		2		4	12.7	4.76	5.16	0.8 1.2	●	●	●	●	●	●	●	●	●	●	●	●	D8~D10 F116 F125 F126	
Finishing - Medium		Up facing CNMG 160612CJ 160616CJ		2		4	15.875	6.35	6.35	1.2 1.6	●	●	●	●	●	●	●	●	●	●	●	●	D10	
Medium - Roughing		CNMG 090404GS 090408GS		1		4	9.525	4.76	3.81	0.4 0.8	●	●	●	●	●	●	●	●	●	●	●	●	D10 F126	
Medium - Roughing		CNMG 120404GS 120408GS 120412GS		4		4	12.7	4.76	5.16	0.4 0.8 1.2	●	●	●	●	●	●	●	●	●	●	●	●	D8~D10 F116 F125 F126	
Medium - Roughing		CNMG 120404PG 120408PG 120412PG 120416PG		4		4	12.7	4.76	5.16	0.4 0.8 1.2 1.6	●	●	●	●	●	●	●	●	●	●	●	●	D8~D10 F116 F125 F126	

Applicable chipbreaker range

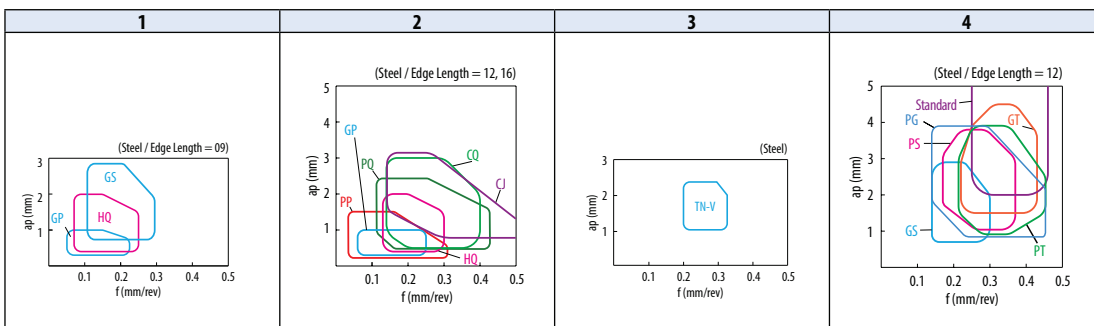

● : Standard item R : Right-hand only L : Left-hand only □ : Check availability

B
Turning indexable inserts

80° Rhombic

How to read pages of "Turning inserts" See page B15

B



Turning indexable inserts

Chip breakers

Negative

C

D

R

S

T

V

W

Ceramic

		Material										
		Free-cutting steel									P	
		Carbon steel / Alloy steel										
		Stainless steel	●	●	●	●	●	●	●	●	M	
		Gray cast iron									K	
		Nodular cast iron										
		Non-ferrous metals									N	
		Heat-resistant alloy	○	○	○	○	○	○	○	○	S	
		Titanium alloy										
		Hard materials									H	
Insert	Description	Applicable chipbreaker range	Dimension (mm)				Carbide				Applicable toolholder	
			No. of edges	IC	S	D1	RE	CVD	PVD	-		
Stainless steel / Heat-resistant alloys	Medium - Roughing / Sharp edge	1	4	12.7	4.76	5.16	0.4 0.8					D8~D10 F116 F125 F126
	Medium - Roughing	1	4	12.7	4.76	5.16	0.4 0.8	●	●	●		
	Finishing - Medium	1	4	12.7	4.76	5.16	0.4 0.8	●	●	●	●	
Heat-resistant alloys	Finishing - Medium	3	4	12.7	4.76	5.16	0.4 0.8 1.2		●	●		D10
		3	4	15.875	6.35	6.35	1.2 1.6		●	●		
		3	4	19.05	6.35	7.94	1.2 1.6		●	●		
Stainless steel / Heat-resistant alloys	Medium - Roughing	1	4	12.7	4.76	5.16	0.4 0.8 1.2 1.6	●	●	●	●	D8~D10 F116 F125 F126
		1	4	12.7	4.76	5.16	0.4 0.8 1.2	●	●	●	●	
		1	4	15.875	6.35	6.35	0.8 1.2 1.6	●	●	●	●	
	Medium - Roughing	1	4	19.05	6.35	7.94	1.2 1.6	●	●	●	●	D10
		2	4	19.05	6.35	7.94	1.2 1.6	●	●	●	●	

Applicable chipbreaker range

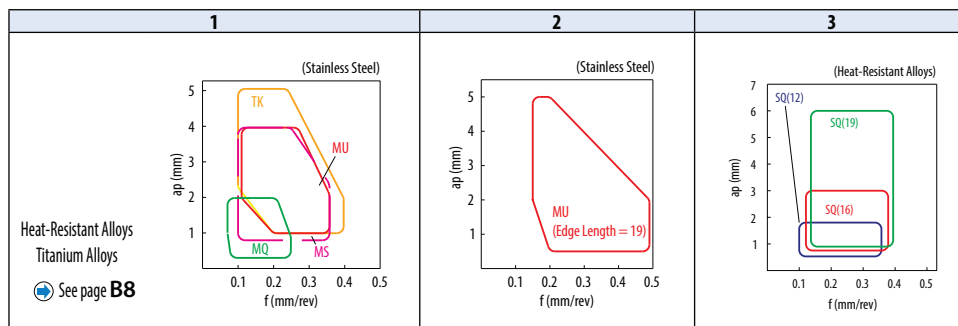





● : Standard item R : Right-hand only L : Left-hand only □ : Check availability

80° Rhombic

How to read pages of "Turning inserts" See page B15

Turning indexable inserts

Insert			Applicable chipbreaker range				Dimension (mm)				Carbide					Applicable toolholder
			No. of edges	IC	S	D1	RE	CVD		PVD						
Heat-resistant alloys		Cast iron						Stainless steel		Carbon steel / Alloy steel		Free-cutting steel		Titanium alloy		Hard materials
Heat-resistant alloys Roughing		CNMG 120408SG 120412SG	1	4	12.7	4.76	5.16	0.8	1.2	•••	•••	•••	•••	•••	•••	D8~D10 F116, F125 F126
		CNMG 160612SG 160616SG	1	4	15.875	6.35	6.35	1.2	1.6	•••	•••	•••	•••	•••	•••	D10
		CNMG 190612SG 190616SG	1	4	19.05	6.35	7.94	1.2	1.6	•••	•••	•••	•••	•••	•••	D10
Heat-resistant alloys Roughing / Single-sided		CNMM 1204XR-SX 1204XL-SX	2	2	12.7	4.42	5.16	-	-	•••	•••	•••	•••	•••	D8~D10	
		CNMM 1606XR-SX 1606XL-SX	2	2	15.875	5.96	6.35	-	-	•••	•••	•••	•••	•••	D10	
		CNMM 1906XR-SX 1906XL-SX	2	2	19.05	5.93	7.94	-	-	•••	•••	•••	•••	•••	D10	
Cast iron Sharp cutting oriented		CNMG 120404KQ 120408KQ 120412KQ	3	4	12.7	4.76	5.16	0.4 0.8 1.2	-	•••	•••	•••	•••	•••	D8~D10 F116 F125 F126	
Cast iron Roughing		CNMG 120404KG 120408KG 120412KG	3	4	12.7	4.76	5.16	0.4 0.8 1.2	-	•••	•••	•••	•••	•••	D8~D10 F116 F125 F126	
Cast iron Roughing		CNMG 120408KH 120412KH 120416KH	3	4	12.7	4.76	5.16	0.8 1.2 1.6	-	•••	•••	•••	•••	•••	D8~D10 F116 F125 F126	

Applicable chipbreaker range

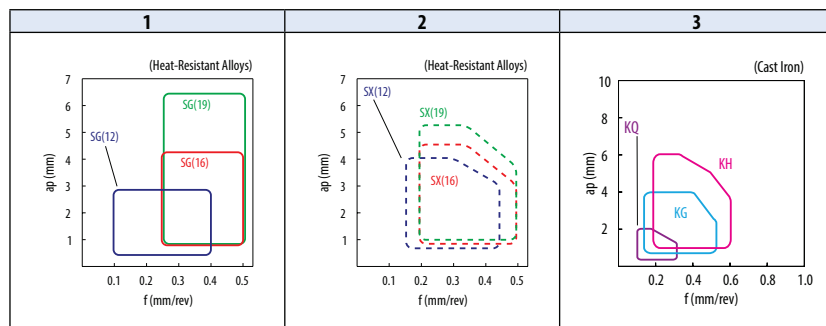

● : Standard item R : Right-hand only L : Left-hand only □ : Check availability

80° Rhombic

How to read pages of "Turning inserts" See page B15

B



Turning indexable inserts

Chip breakers

Negative

C

D

R

S

T

V

W

Ceramic

Insert	Description	Applicable chipbreaker range	No. of edges	Dimension (mm)				Carbide					Cermet	Applicable toolholder				
				IC	S	D1	RE	CVD										
								CA310	CA315	CA320	CA4505	CA4515			CA5505	RW10	CCX	PV7005
Cast iron Roughing	CNMG 120404C 120408C 120412C 120416C	1	4	12.7	4.76	5.16	0.4 0.8 1.2 1.6	●	●	●	●	●	●	●	●	●	●	D8~D10 F116 F125 F126
	CNMG 160612C	1	4	15.875	6.35	6.35	1.2	●	●	●	●	●	●	●	●	●	D10	
Cast iron Roughing	CNMG 120408ZS 120412ZS	1	4	12.7	4.76	5.16	0.8 1.2	●	●	●	●	●	●	●	●	●	●	D8~D10 F116 F125 F126
Cast iron Roughing	CNMG 120408GC 120412GC	1	4	12.7	4.76	5.16	0.8 1.2	●	●	●	●	●	●	●	●	●	●	
Cast iron Without Chipbreaker	CNMA 120404 120408 120412 120416	-	4	12.7	4.76	5.16	0.4 0.8 1.2 1.6	●	●	●	●	●	●	●	●	●	●	

Applicable chipbreaker range

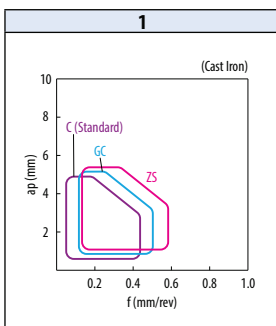

● : Standard item R : Right-hand only L : Left-hand only □ : Check availability

80° Rhombic

How to read pages of "Turning inserts" See page B15

Insert		Description	Applicable chipbreaker range		Dimension (mm)				Carbide		Cermet		Applicable toolholder																																																																																																																													
					No. of edges	IC	S	D1	RE	-		-																																																																																																																														
										PDL010	PDL025	KW10		PV710	PV720	PV730	TN60	TN610	TN620																																																																																																																							
<table border="1"> <tr><td>Free-cutting steel</td><td></td><td></td><td></td><td></td><td></td><td></td><td></td><td></td><td></td><td></td><td></td><td></td><td>P</td></tr> <tr><td>Carbon steel / Alloy steel</td><td></td><td></td><td></td><td></td><td></td><td></td><td></td><td></td><td></td><td></td><td></td><td></td><td>M</td></tr> <tr><td>Stainless steel</td><td></td><td></td><td></td><td></td><td></td><td></td><td></td><td></td><td></td><td></td><td></td><td></td><td>K</td></tr> <tr><td>Gray cast iron</td><td></td><td></td><td></td><td></td><td></td><td></td><td></td><td></td><td></td><td></td><td></td><td></td><td>N</td></tr> <tr><td>Nodular cast iron</td><td></td><td></td><td></td><td></td><td></td><td></td><td></td><td></td><td></td><td></td><td></td><td></td><td>S</td></tr> <tr><td>Non-ferrous metals</td><td></td><td></td><td></td><td></td><td></td><td></td><td></td><td></td><td></td><td></td><td></td><td></td><td>H</td></tr> <tr><td>Heat-resistant alloy</td><td></td><td></td><td></td><td></td><td></td><td></td><td></td><td></td><td></td><td></td><td></td><td></td><td></td></tr> <tr><td>Titanium alloy</td><td></td><td></td><td></td><td></td><td></td><td></td><td></td><td></td><td></td><td></td><td></td><td></td><td></td></tr> <tr><td>Hard materials</td><td></td><td></td><td></td><td></td><td></td><td></td><td></td><td></td><td></td><td></td><td></td><td></td><td></td></tr> </table>													Free-cutting steel													P	Carbon steel / Alloy steel													M	Stainless steel													K	Gray cast iron													N	Nodular cast iron													S	Non-ferrous metals													H	Heat-resistant alloy														Titanium alloy														Hard materials													
Free-cutting steel													P																																																																																																																													
Carbon steel / Alloy steel													M																																																																																																																													
Stainless steel													K																																																																																																																													
Gray cast iron													N																																																																																																																													
Nodular cast iron													S																																																																																																																													
Non-ferrous metals													H																																																																																																																													
Heat-resistant alloy																																																																																																																																										
Titanium alloy																																																																																																																																										
Hard materials																																																																																																																																										
Non-Ferrous Metals		CNGG 120404R-A3 120404L-A3 120408R-A3 120408L-A3	1	4	12.7	4.76	5.16	0.4 0.4 0.8 0.8	●●●●	●●●●			D8~D10 F116 F125 F126																																																																																																																													
Non-Ferrous Metals		CNGG 120404AH 120408AH	1	4	12.7	4.76	5.16	0.4 0.8	●●●●	●●●●																																																																																																																																
Non-Ferrous Metals		CNMG 120404AH 120408AH	1	4	12.7	4.76	5.16	0.4 0.8	●●●●	●●●●																																																																																																																																
Finishing		CNGG 090402R-S 090402L-S 090404R-S 090404L-S 090408R-S 090408L-S	2	4	9.525	4.76	3.81	0.2 0.2 0.4 0.4 0.8 0.8	●●●●	●●●●	●●●●	●●●●	D10 F126																																																																																																																													
Medium		CNGG 090404L 090408L	2	4	9.525	4.76	3.81	0.4 0.8	●●	●●			D8~D10 F116 F125 F126																																																																																																																													
		CNGG 120404R 120404L 120408R 120408L	3	4	12.7	4.76	5.16	0.4 0.4 0.8 0.8	●●●●	●●●●	●●●●	●●●●																																																																																																																														
Medium - Roughing		CNGG 120404R-25R 120404L-25R 120408R-25R 120408L-25R	3	4	12.7	4.76	5.16	0.4 0.4 0.8 0.8	●●●●	●●●●	●●●●	●●●●																																																																																																																														
Medium - Roughing		CNGG 120404Z	3	4	12.7	4.76	5.16	0.4			●																																																																																																																															

Applicable chipbreaker range

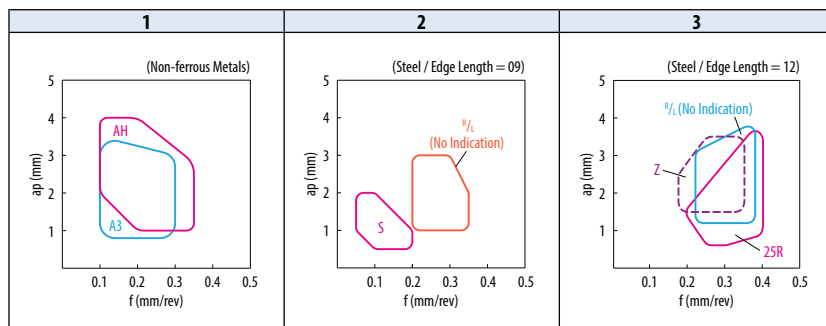

● : Standard item R : Right-hand only L : Left-hand only □ : Check availability

Turning indexable inserts

55° Rhombic

How to read pages of "Turning inserts" See page B15

B



Turning indexable inserts

Chip breakers

Negative

C

D

R

S

T

V

W

Ceramic

				Free-cutting steel																P																			
				Carbon steel / Alloy steel																																			
				Stainless steel																																			
				Gray cast iron																																			
				Nodular cast iron																K																			
				Non-ferrous metals																																			
				Heat-resistant alloy																S																			
				Titanium alloy																																			
				Hard materials																H																			
Insert	Description	Applicable chipbreaker range	No. of edges	Dimension (mm)				Carbide						Cermet				Applicable toolholder																					
				IC	S	D1	RE	CVD						PVD		-																							
										CA025P	CA510	CA515	CA525	CA530	CA530S	CA5515	CA5525	CCX	PV770	PV720	PV730	PV90	TN60	TN610	TN620														
Finishing	 With Wiper Edge	1	4	12.7	4.76	5.16	0.4	●	●	●	●	●	●	●	●	●	●	●	●	●	●	●	●	●	●	●	●	●	●	D13~D17	F118, F130	F132~F134							
							0.8	●	●	●	●	●	●	●	●	●	●	●	●	●	●	●	●	●	●	●	●	●	●	●	●	●	●	●	●	●			
Finishing	 	1	4	12.7	6.35	5.16	0.4	●	●	●	●	●	●	●	●	●	●	●	●	●	●	●	●	●	●	●	●	●	●	D13~D17	F118								
							0.8	●	●	●	●	●	●	●	●	●	●	●	●	●	●	●	●	●	●	●	●	●	●	●	●	●	●	●	●	●	●		
Finishing	 	3	4	12.7	4.76	5.16	0.2	●	●	●	●	●	●	●	●	●	●	●	●	●	●	●	●	●	●	●	●	●	●	D13~D17	F118, F130	F132~F134							
							0.4	●	●	●	●	●	●	●	●	●	●	●	●	●	●	●	●	●	●	●	●	●	●	●	●	●	●	●	●	●	●		
							0.8	●	●	●	●	●	●	●	●	●	●	●	●	●	●	●	●	●	●	●	●	●	●	●	●	●	●	●	●	●	●	●	
							1.2	●	●	●	●	●	●	●	●	●	●	●	●	●	●	●	●	●	●	●	●	●	●	●	●	●	●	●	●	●	●	●	
Finishing	 	2	4	9.525	4.76	3.81	0.4	●	●	●	●	●	●	●	●	●	●	●	●	●	●	●	●	●	●	●	●	●	●	D16	F128								
							0.8	●	●	●	●	●	●	●	●	●	●	●	●	●	●	●	●	●	●	●	●	●	●	●	●	●	●	●	●	●	●		
							0.2	●	●	●	●	●	●	●	●	●	●	●	●	●	●	●	●	●	●	●	●	●	●	●	●	●	●	●	●	●	●	●	●
							0.4	●	●	●	●	●	●	●	●	●	●	●	●	●	●	●	●	●	●	●	●	●	●	●	●	●	●	●	●	●	●	●	●
Finishing	 	3	4	12.7	4.76	5.16	0.4	●	●	●	●	●	●	●	●	●	●	●	●	●	●	●	●	●	●	●	●	●	●	D13~D17	F118, F130	F132~F134							
							0.8	●	●	●	●	●	●	●	●	●	●	●	●	●	●	●	●	●	●	●	●	●	●	●	●	●	●	●	●	●	●		
							0.2	●	●	●	●	●	●	●	●	●	●	●	●	●	●	●	●	●	●	●	●	●	●	●	●	●	●	●	●	●	●	●	●
							0.4	●	●	●	●	●	●	●	●	●	●	●	●	●	●	●	●	●	●	●	●	●	●	●	●	●	●	●	●	●	●	●	●
Finishing - Medium	 	3	4	12.7	4.76	5.16	0.4	●	●	●	●	●	●	●	●	●	●	●	●	●	●	●	●	●	●	●	●	●	●	D13~D17	F118, F130	F132~F134							
							0.8	●	●	●	●	●	●	●	●	●	●	●	●	●	●	●	●	●	●	●	●	●	●	●	●	●	●	●	●	●	●		
							1.2	●	●	●	●	●	●	●	●	●	●	●	●	●	●	●	●	●	●	●	●	●	●	●	●	●	●	●	●	●	●	●	●
							0.4	●	●	●	●	●	●	●	●	●	●	●	●	●	●	●	●	●	●	●	●	●	●	●	●	●	●	●	●	●	●	●	●
Finishing - Medium	 	3	4	12.7	6.35	5.16	0.4	●	●	●	●	●	●	●	●	●	●	●	●	●	●	●	●	●	●	●	●	●	●	D13~D17	F118								
							0.8	●	●	●	●	●	●	●	●	●	●	●	●	●	●	●	●	●	●	●	●	●	●	●	●	●	●	●	●	●	●	●	
							1.2	●	●	●	●	●	●	●	●	●	●	●	●	●	●	●	●	●	●	●	●	●	●	●	●	●	●	●	●	●	●	●	●
							0.4	●	●	●	●	●	●	●	●	●	●	●	●	●	●	●	●	●	●	●	●	●	●	●	●	●	●	●	●	●	●	●	●

See "Precautions when using Wiper inserts" in the R34 and R35 for WF chipbreaker.

Applicable chipbreaker range

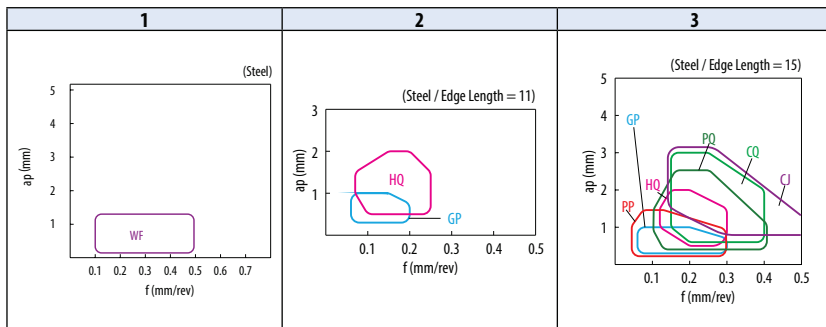

● : Standard item R : Right-hand only L : Left-hand only □ : Check availability

55° Rhombic

How to read pages of "Turning inserts" See page B15

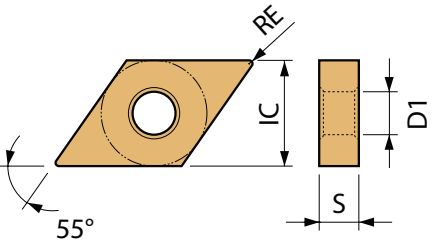

Insert		Description	Applicable chipbreaker range		Dimension (mm)				Carbide								Cermet			Applicable toolholder										
					No. of edges	IC	S	D1	RE	CVD								PVD	PVD		-									
										CA02SP	CA510	CA515	CA525	CA530	CA530S	CA5515	CA5525	CA5535	CA6515		CA6525	PRI535	CCX	PV710	PV770	PV730	PV90	TN60	TN610	TN620
Finishing - Medium		DNMG 110402HQ 110404HQ	1	4	9.525	4.76	3.81	0.2 0.4	●	●	●	●	●	●			●	●	●	●	●		D16 F128							
		DNMG 150404HQ 150408HQ 150412HQ	2	4	12.7	4.76	5.16	0.4 0.8 1.2	●	●	●	●	●	●	●	●	●	●	●	●	●	●	●	D13~D17 F118, F130 F132~F134						
		DNMG 150604HQ 150608HQ 150612HQ	2	4	12.7	6.35	5.16	0.4 0.8 1.2	●	●	●	●	●	●	●	●	●	●	●	●	●	●	●	D13~D17 F118						
Finishing - Medium		DNMG 150404CQ 150408CQ 150412CQ	2	4	12.7	4.76	5.16	0.4 0.8 1.2	●	●	●	●	●	●			●	●	●	●	●	●	D13~D17 F118, F130 F132~F134							
		DNMG 150604CQ 150608CQ 150612CQ	2	4	12.7	6.35	5.16	0.4 0.8 1.2	●	●	●	●	●	●			●	●	●	●	●	●	D13~D17 F118							
Finishing - Medium		DNMG 150408CJ 150412CJ	2	4	12.7	4.76	5.16	0.8 1.2	●	●	●	●	●	●									D13~D17 F118, F130 F132~F134							
		DNMG 150608CJ 150612CJ	2	4	12.7	6.35	5.16	0.8 1.2	●	●	●	●	●	●									D13~D17 F118							
Medium		DNMG 150404TN-V 150408TN-V	3	4	12.7	4.76	5.16	0.4 0.8															D13~D17 F118, F130 F132~F134							
Medium - Roughing		DNMG 110404GS 110408GS	4	4	9.525	4.76	3.81	0.4 0.8	●	●	●	●	●	●			●	●	●	●	●	●	D16 F128							
		DNMG 150404GS 150408GS 150412GS	4	4	12.7	4.76	5.16	0.4 0.8 1.2	●	●	●	●	●	●			●	●	●	●	●	●	D13~D17 F118, F130 F132~F134							
		DNMG 150604GS 150608GS	4	4	12.7	6.35	5.16	0.4 0.8	●	●													D13~D17 F118							

B



Turning indexable inserts

Applicable chipbreaker range

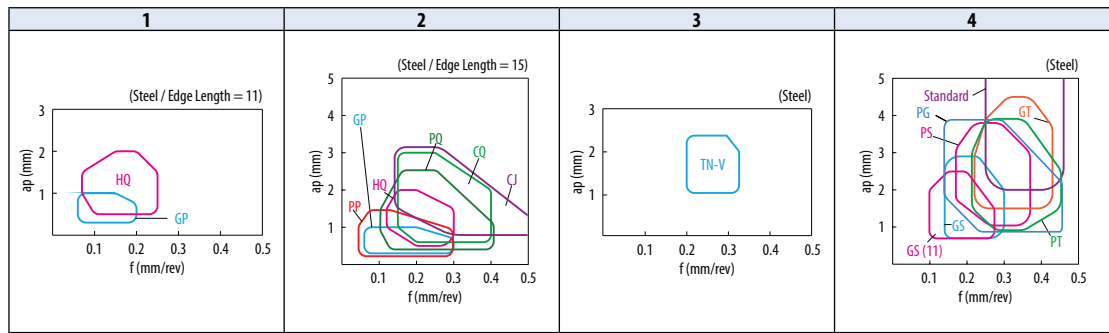

● : Standard item R : Right-hand only L : Left-hand only □ : Check availability

55° Rhombic

How to read pages of "Turning inserts" See page B15

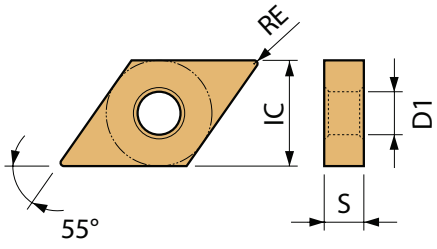

Insert	Description	Applicable chipbreaker range	No. of edges	Dimension (mm)				Material										Applicable toolholder												
				IC	S	D1	RE	Material																						
								Free-cutting steel	Carbon steel / Alloy steel	Stainless steel	Gray cast iron	Nodular cast iron	Non-ferrous metals	Heat-resistant alloy	Titanium alloy	Hard materials	P		M	K	N	S	H							
								CA02SP	CA310	CA315	CA370	CA4505	CA4515	CA510	CA525	CA530	CA5505	CA5515	CA5525	CA5535	CC	PV7005	PV710	PV720	PV730	PV90	TN60	TN610	TN620	
Roughing	DNMG 150404 150408 150412	1	4	12.7	4.76	5.16	0.4 0.8 1.2	●	●	●	●	●	●	●	●	●	●	●	●	●	●	●	●	●	●	●	●	●	●	D13~D17 F118, F130 F132~F134
Roughing	DNMG 150604 150608 150612	1	4	12.7	6.35	5.16	0.4 0.8 1.2	●	●	●	●	●	●	●	●	●	●	●	●	●	●	●	●	●	●	●	●	●	●	D13~D17 F118
Roughing	DNMG 150408PH 150412PH 150416PH	2	4	12.7	4.76	5.16	0.8 1.2 1.6	●	●	●	●	●	●	●	●	●	●	●	●	●	●	●	●	●	●	●	●	●	●	D13~D17 F118, F130 F132~F134
Roughing	DNMG 150608PH 150612PH 150616PH	2	4	12.7	6.35	5.16	0.8 1.2 1.6	●	●	●	●	●	●	●	●	●	●	●	●	●	●	●	●	●	●	●	●	●	●	D13~D17 F118
Roughing	DNMM 150408PX 150412PX 150416PX	2	2	12.7	4.76	5.16	0.8 1.2 1.6	●	●	●	●	●	●	●	●	●	●	●	●	●	●	●	●	●	●	●	●	●	●	D13~D17 F118, F130 F132~F134
Roughing	DNMM 150608PX 150612PX 150616PX	2	2	12.7	6.35	5.16	0.8 1.2 1.6	●	●	●	●	●	●	●	●	●	●	●	●	●	●	●	●	●	●	●	●	●	●	D13~D17 F118
Low carbon steel	DNMG 150404XF 150408XF	3	4	12.7	4.76	5.16	0.4 0.8	●	●	●	●	●	●	●	●	●	●	●	●	●	●	●	●	●	●	●	●	●	●	D13~D17 F118, F130 F132~F134
Low carbon steel	DNMG 150404XP 150408XP	3	4	12.7	4.76	5.16	0.4 0.8	●	●	●	●	●	●	●	●	●	●	●	●	●	●	●	●	●	●	●	●	●	●	D13~D17 F118
Low carbon steel	DNMG 150604XP 150608XP	3	4	12.7	6.35	5.16	0.4 0.8	●	●	●	●	●	●	●	●	●	●	●	●	●	●	●	●	●	●	●	●	●	●	D13~D17 F118
Low carbon steel	DNMG 150404XQ 150408XQ	3	4	12.7	4.76	5.16	0.4 0.8	●	●	●	●	●	●	●	●	●	●	●	●	●	●	●	●	●	●	●	●	●	●	D13~D17 F118, F130 F132~F134
Low carbon steel	DNMG 150408XS	3	4	12.7	4.76	5.16	0.8	●	●	●	●	●	●	●	●	●	●	●	●	●	●	●	●	●	●	●	●	●	●	D13~D17 F118, F130 F132~F134

Applicable chipbreaker range

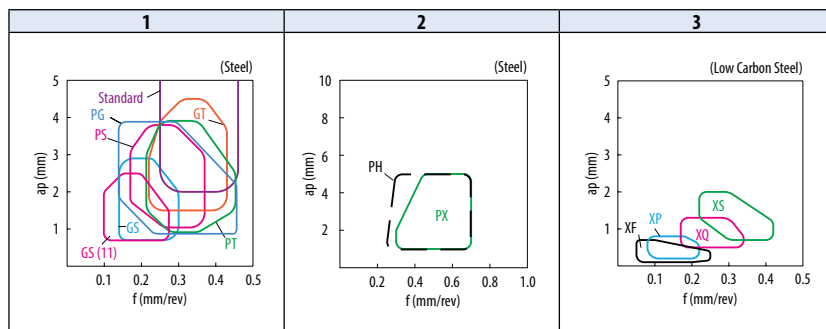

● : Standard item R : Right-hand only L : Left-hand only □ : Check availability

B



Turning indexable inserts

55° Rhombic

How to read pages of "Turning inserts" See page B15

B

Turning indexable inserts

Chip breakers

Negative

C

D

R

S

T

V

W

Ceramic

Insert	Description	Applicable chipbreaker range	Dimension (mm)				Carbide						Applicable toolholder			
			No. of edges	IC	S	D1	RE	CVD		PVD		- PVD		Cermet		
								CA6515	CA6525	PR0055	PR0155				PR1225	PR1535
Finishing - Medium Polished / Sharp edge	DNGG 150402MFP-SK 150404MFP-SK	1	4	12.7	4.76	5.16	< 0.2 < 0.4			●	●	●	●	●		
Large-ap	DNMG 150402R-LD 150404R-LD	2	4	12.7	4.76	5.16	0.2 0.4			●	●					
Medium - Roughing Polished / Sharp edge	DNGG 150404FP-TK 150408FP-TK	1	4	12.7	4.76	5.16	0.4 0.8			●	●	●	●			D13~D17 F118, F130 F132~F134
Stainless steel / Heat-resistant alloys	Medium - Roughing / Sharp edge	DNGG 150404TK 150408TK	3	4	12.7	4.76	5.16	0.4 0.8					●	●		
		DNMG 150404TK 150408TK	3	4	12.7	4.76	5.16	0.4 0.8	●	●		●				
	Medium - Roughing	DNMG 150604TK 150608TK	3	4	12.7	6.35	5.16	0.4 0.8	●	●		●				D13~D17 F118
	Finishing - Medium	DNMG 150404MQ 150408MQ	3	4	12.7	4.76	5.16	0.4 0.8	●	●	●	●		●		D13~D17 F118, F130 F132~F134
		DNMG 150604MQ 150608MQ	3	4	12.7	6.35	5.16	0.4 0.8	●	●	●	●		●		D13~D17 F118

Insert whose corner-R(RE) dimension expressed with less than sign (e.g. <0.05, <0.1, <0.2 etc.) indicate models with minus tolerance on corner-R(RE).

Applicable chipbreaker range

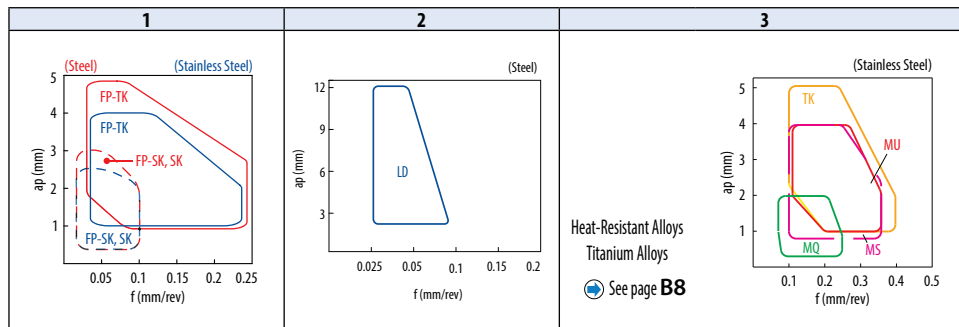

● : Standard item R : Right-hand only L : Left-hand only □ : Check availability

55° Rhombic

How to read pages of "Turning inserts" See page B15

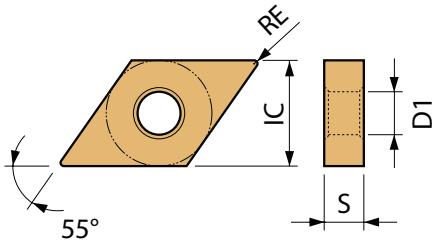

		Material Compatibility									
		Free-cutting steel	Carbon steel / Alloy steel	Stainless steel	Gray cast iron	Nodular cast iron	Non-ferrous metals	Heat-resistant alloy	Titanium alloy	Hard materials	
				●	●	●	●	○	●	●	P
				●	●	●	●	○	●	●	M
				●	●	●	●	○	●	●	K
				●	●	●	●	○	●	●	N
				●	●	●	●	○	●	●	S
				●	●	●	●	○	●	●	H

Insert	Description	Applicable chipbreaker range		Dimension (mm)				Carbide					Applicable toolholder	
		No. of edges	IC	S	D1	RE								
							CVD	PVD	-					
							CA6515	CA6525	PR0055	PR0155	PR1535	SW05		
Heat-resistant alloys Finishing - Medium	DNMG 150404SQ 150408SQ 150412SQ	1	4	12.7	4.76	5.16	0.4 0.8 1.2	●	●	●	●	●	●	D13~D17 F118, F130 F132~F134
	DNMG 150604SQ 150608SQ 150612SQ	1	4	12.7	6.35	5.16	0.4 0.8 1.2	●	●	●	●	●	●	D13~D17 F118
Stainless steel / Heat-resistant alloys Medium - Roughing	DNMG 150404MS 150408MS 150412MS	2	4	12.7	4.76	5.16	0.4 0.8 1.2	●	●	●	●	●	●	D13~D17 F118, F130 F132~F134
	DNMG 150604MS 150608MS 150612MS	2	4	12.7	6.35	5.16	0.4 0.8 1.2	●	●	●	●	●	●	D13~D17 F118
Stainless steel / Heat-resistant alloys Medium - Roughing	DNMG 150404MU 150408MU	2	4	12.7	4.76	5.16	0.4 0.8	●	●	●	●	●	●	D13~D17 F118, F130 F132~F134
	DNMG 150604MU 150608MU	2	4	12.7	6.35	5.16	0.4 0.8	●	●	●	●	●	●	D13~D17 F118
Heat-resistant alloys Roughing	DNMG 150408SG 150412SG	3	4	12.7	4.76	5.16	0.8 1.2	●	●	●	●	●	●	D13~D17 F118, F130 F132~F134
	DNMG 150608SG 150612SG	3	4	12.7	6.35	5.16	0.8 1.2	●	●	●	●	●	●	D13~D17 F118

Applicable chipbreaker range

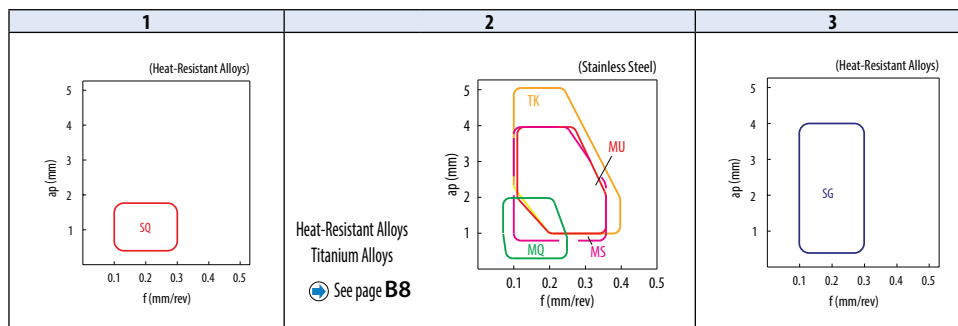

● : Standard item R : Right-hand only L : Left-hand only □ : Check availability

Turning indexable inserts

55° Rhombic

How to read pages of "Turning inserts" See page B15

B



Turning indexable inserts

Chip breakers

Negative

C

D

R

S

T

V

W

Ceramic

		Free-cutting steel										P	
		Carbon steel / Alloy steel										M	
		Stainless steel										K	
		Gray cast iron										N	
		Nodular cast iron										S	
		Non-ferrous metals										H	
		Heat-resistant alloy											
		Titanium alloy											
		Hard materials											
Insert	Description	Applicable chipbreaker range	No. of edges	Dimension (mm)				Carbide					Applicable toolholder
				IC	S	D1	RE	CVD					
								CA310	CA315	CA320	CA4505	CA4515	
Cast iron Sharp cutting oriented	DNMG 150404KQ 150408KQ	1	4	12.7	4.76	5.16	0.4 0.8	●●● ●●●	●●● ●●●	●●● ●●●	●●● ●●●	D13~D17 F118, F130 F132~F134	
	DNMG 150604KQ 150608KQ	1	4	12.7	6.35	5.16	0.4 0.8	●●● ●●●	●●● ●●●	●●● ●●●	●●● ●●●	D13~D17 F118	
Cast iron Roughing	DNMG 150404KG 150408KG 150412KG	1	4	12.7	4.76	5.16	0.4 0.8 1.2	●●● ●●● ●●●	●●● ●●● ●●●	●●● ●●● ●●●	●●● ●●● ●●●	D13~D17 F118, F130 F132~F134	
	DNMG 150604KG 150608KG 150612KG	1	4	12.7	6.35	5.16	0.4 0.8 1.2	●●● ●●● ●●●	●●● ●●● ●●●	●●● ●●● ●●●	●●● ●●● ●●●	D13~D17 F118	
Cast iron Roughing	DNMG 150408KH 150412KH	1	4	12.7	4.76	5.16	0.8 1.2	●●● ●●●	●●● ●●●	●●● ●●●	●●● ●●●	D13~D17 F118, F130 F132~F134	
	DNMG 150608KH 150612KH	1	4	12.7	6.35	5.16	0.8 1.2	●●● ●●●	●●● ●●●	●●● ●●●	●●● ●●●	D13~D17 F118	
Cast iron Roughing	DNMG 150404C 150408C 150412C	2	4	12.7	4.76	5.16	0.4 0.8 1.2	●●● ●●● ●●●	●●● ●●● ●●●	●●● ●●● ●●●	●●● ●●● ●●●	D13~D17 F118, F130 F132~F134	
	DNMG 150604C 150608C 150612C	2	4	12.7	6.35	5.16	0.4 0.8 1.2	●●● ●●● ●●●	●●● ●●● ●●●	●●● ●●● ●●●	●●● ●●● ●●●	D13~D17 F118	
Cast iron Roughing	DNMG 150408ZS 150412ZS	2	4	12.7	4.76	5.16	0.8 1.2	●●● ●●●	●●● ●●●	●●● ●●●	●●● ●●●	D13~D17 F118, F130 F132~F134	
	DNMG 150608ZS 150612ZS	2	4	12.7	6.35	5.16	0.8 1.2	●●● ●●●	●●● ●●●	●●● ●●●	●●● ●●●	D13~D17 F118	
Cast iron Roughing	DNMG 150408GC 150412GC	2	4	12.7	4.76	5.16	0.8 1.2	●●● ●●●	●●● ●●●	●●● ●●●	●●● ●●●	D13~D17 F118, F130 F132~F134	
	DNMG 150608GC 150612GC	2	4	12.7	6.35	5.16	0.8 1.2	●●● ●●●	●●● ●●●	●●● ●●●	●●● ●●●	D13~D17 F118	

Applicable chipbreaker range

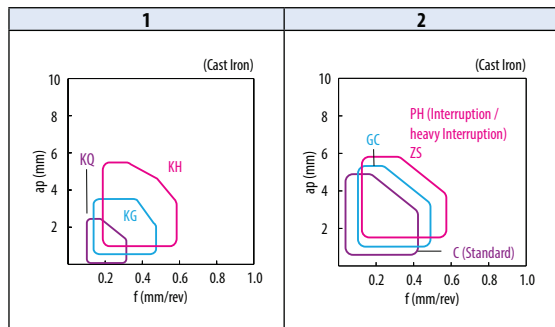

● : Standard item R : Right-hand only L : Left-hand only □ : Check availability

55° Rhombic

How to read pages of "Turning inserts" See page B15

Insert	Description	Applicable chipbreaker range	No. of edges	Dimension (mm)				Material										Applicable toolholder							
				IC	S	D1	RE	Carbide					Cermet												
								CVD		DLC	PVD	CVD	PVD		-										
								CA310	CA315	CA320	CA4505	CA4515	CA5505	PD1010	PD1025	PR930	KT10		CCX	PV7005	PV710	PV720	PV730	PV90	TN60
Free-cutting steel	Carbon steel / Alloy steel	Stainless steel	Gray cast iron	Nodular cast iron	Non-ferrous metals	Heat-resistant alloy	Titanium alloy	Hard materials																	P
																									M
																									K
																									N
																									S
																									H

Material	Insert	Description	Applicable chipbreaker range	No. of edges	IC	S	D1	RE	Material										Applicable toolholder						
									CA310	CA315	CA320	CA4505	CA4515	CA5505	PD1010	PD1025	PR930	KT10		CCX	PV7005	PV710	PV720	PV730	PV90
Cast Iron	Without Chipbreaker	DNMA 150404 150408	-	4	12.7	4.76	5.16	0.4 0.8	●	●	●	●	●	●	●	●	●	●	●	●	●	●	●	●	D13~D17 F118, F130 F132~F134
		DNMA 150604 150608	-	4	12.7	6.35	5.16	0.4 0.8	●	●	●	●	●	●	●	●	●	●	●	●	●	●	●	●	D13~D17 F118
Non-Ferrous Metals	Finishing - Medium / Sharp edge	DNMG 150404R-A3 150404L-A3 150408R-A3 150408L-A3	1	4	12.7	4.76	5.16	0.4 0.4 0.8 0.8	●	●	●	●	●	●	●	●	●	●	●	●	●	●	●	●	D13~D17 F118, F130 F132~F134
		DNMG 150404AH 150408AH	1	4	12.7	4.76	5.16	0.4 0.8	●	●	●	●	●	●	●	●	●	●	●	●	●	●	●	●	D13~D17 F118
	Medium - Roughing / Sharp edge	DNMG 150604AH 150608AH	1	4	12.7	6.35	5.16	0.4 0.8	●	●	●	●	●	●	●	●	●	●	●	●	●	●	●	●	D13~D17 F118
		DNMG 150404AH 150408AH	1	4	12.7	4.76	5.16	0.4 0.8	●	●	●	●	●	●	●	●	●	●	●	●	●	●	●	●	D13~D17 F118, F130 F132~F134
Finishing	Sharp edge / Surface finish oriented	DNMG 110402R-S 110402L-S 110404R-S 110404L-S 110408R-S 110408L-S	2	4	9.525	4.76	3.81	0.2 0.2 0.4 0.4 0.8 0.8	●	●	●	●	●	●	●	●	●	●	●	●	●	●	●	●	D16 F128
		DNMG 110404R 110404L	2	4	9.525	4.76	3.81	0.4	●	●	●	●	●	●	●	●	●	●	●	●	●	●	●	●	D13~D17 F118, F130 F132~F134
		DNMG 150404R 150404L 150408R 150408L	2	4	12.7	4.76	5.16	0.4 0.4 0.8 0.8	●	●	●	●	●	●	●	●	●	●	●	●	●	●	●	●	D13~D17 F118, F130 F132~F134

Applicable chipbreaker range

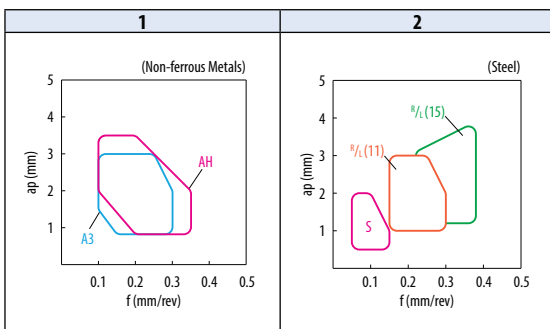

● : Standard item R : Right-hand only L : Left-hand only □ : Check availability



55° Parallelogram

How to read pages of "Turning inserts" See page B15

B

Turning indexable inserts

Chip breakers
Negative

- C
- D
- R
- S
- T
- V
- W
- Ceramic

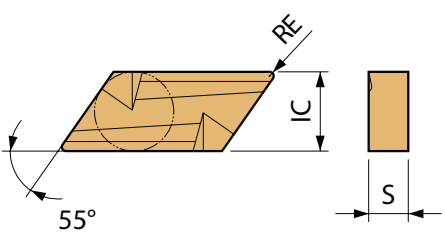

Insert	Description	Applicable chipbreaker range		Dimension (mm)			Car-bide	Applicable toolholder
		No. of edges		IC	S	RE		
Medium - Roughing 	KNMX 160405R-1 160405L-1 160410R-1 160410L-1	1	2	9.525	4.76	0.5	● ●	-
						0.5	● ●	
						1	● ●	
						1	● ●	

Free-cutting steel	●	☺	P
Carbon steel / Alloy steel	●	☺	P
Stainless steel			M
Gray cast iron			K
Nodular cast iron			K
Non-ferrous metals			N
Heat-resistant alloy			S
Titanium alloy			S
Hard materials			H

Applicable chipbreaker range

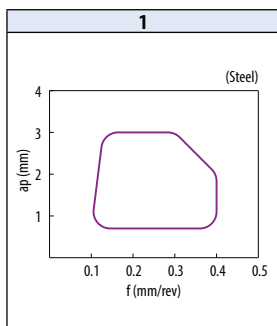

● : Standard item R : Right-hand only L : Left-hand only □ : Check availability

Round

How to read pages of "Turning inserts" → See page B15

Insert		Description		Applicable chipbreaker range	Dimension (mm)			Carbide					Cermet		Applicable toolholder		
					IC	S	D1	CVD					PVD	-			
								CA025P	CA310	CA315	CA320	CA515				CA525	CA530
Medium - Roughing		RNMG	090300	1	9.525	3.18	3.81	●		●	●	●	●	●	●	D42	
		RNMG	120400	1	12.7	4.76	5.16	●	●	●	●	●	●	●	●		●
		RNMG	150600	1	15.875	6.35	6.35	●	●	●	●	●	●				

Applicable chipbreaker range

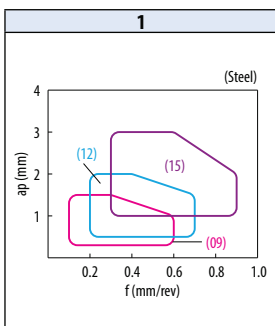

● : Standard item R : Right-hand only L : Left-hand only □ : Check availability

90° Square

How to read pages of "Turning inserts" See page B15

Insert				Description	Applicable chipbreaker range	Dimension (mm)				Material											Applicable toolholder																																																																													
						No. of edges	IC	S	D1	RE	Material																																																																																							
											Carbide		Cermet		Material																																																																																			
Free-cutting steel											Carbon steel / Alloy steel											Stainless steel											Gray cast iron											Nodular cast iron											Non-ferrous metals											Heat-resistant alloy											Titanium alloy											Hard materials										
Roughing	[Image]	SNMG	120408PH 120412PH 120416PH	1	8	12.7	4.76	5.16	0.8 1.2 1.6	CA02SP	CA310	CA315	CA320	CA4505	CA4510	CA525	CA530	CA5515	CA5525	CA5535	CCX	PV710	PV720	PV730	PV90	TN610	TN620	D19~D21 F136																																																																						
										CA02SP	CA310	CA315	CA320	CA4505	CA4510	CA525	CA530	CA5515	CA5525	CA5535	CCX	PV710	PV720	PV730	PV90	TN610	TN620																																																																							
										CA02SP	CA310	CA315	CA320	CA4505	CA4510	CA525	CA530	CA5515	CA5525	CA5535	CCX	PV710	PV720	PV730	PV90	TN610	TN620																																																																							
Roughing	[Image]	SNMM	120408PX 120412PX 120416PX	2	4	12.7	4.76	5.16	0.8 1.2 1.6	CA02SP	CA310	CA315	CA320	CA4505	CA4510	CA525	CA530	CA5515	CA5525	CA5535	CCX	PV710	PV720	PV730	PV90	TN610	TN620	D19~D21 F136																																																																						
										CA02SP	CA310	CA315	CA320	CA4505	CA4510	CA525	CA530	CA5515	CA5525	CA5535	CCX	PV710	PV720	PV730	PV90	TN610	TN620																																																																							
										CA02SP	CA310	CA315	CA320	CA4505	CA4510	CA525	CA530	CA5515	CA5525	CA5535	CCX	PV710	PV720	PV730	PV90	TN610	TN620																																																																							
Low carbon steel	[Image]	SNMG	120408XP	3	8	12.7	4.76	5.16	0.8	CA02SP	CA310	CA315	CA320	CA4505	CA4510	CA525	CA530	CA5515	CA5525	CA5535	CCX	PV710	PV720	PV730	PV90	TN610	TN620	D19~D21 F136																																																																						
										CA02SP	CA310	CA315	CA320	CA4505	CA4510	CA525	CA530	CA5515	CA5525	CA5535	CCX	PV710	PV720	PV730	PV90	TN610	TN620																																																																							
										CA02SP	CA310	CA315	CA320	CA4505	CA4510	CA525	CA530	CA5515	CA5525	CA5535	CCX	PV710	PV720	PV730	PV90	TN610	TN620																																																																							
Low carbon steel	[Image]	SNMG	120408XQ	3	8	12.7	4.76	5.16	0.8	CA02SP	CA310	CA315	CA320	CA4505	CA4510	CA525	CA530	CA5515	CA5525	CA5535	CCX	PV710	PV720	PV730	PV90	TN610	TN620	D19~D21 F136																																																																						
										CA02SP	CA310	CA315	CA320	CA4505	CA4510	CA525	CA530	CA5515	CA5525	CA5535	CCX	PV710	PV720	PV730	PV90	TN610	TN620																																																																							
										CA02SP	CA310	CA315	CA320	CA4505	CA4510	CA525	CA530	CA5515	CA5525	CA5535	CCX	PV710	PV720	PV730	PV90	TN610	TN620																																																																							
Low carbon steel	[Image]	SNMG	120408XS	3	8	12.7	4.76	5.16	0.8	CA02SP	CA310	CA315	CA320	CA4505	CA4510	CA525	CA530	CA5515	CA5525	CA5535	CCX	PV710	PV720	PV730	PV90	TN610	TN620	D19~D21 F136																																																																						
										CA02SP	CA310	CA315	CA320	CA4505	CA4510	CA525	CA530	CA5515	CA5525	CA5535	CCX	PV710	PV720	PV730	PV90	TN610	TN620																																																																							
										CA02SP	CA310	CA315	CA320	CA4505	CA4510	CA525	CA530	CA5515	CA5525	CA5535	CCX	PV710	PV720	PV730	PV90	TN610	TN620																																																																							

Applicable chipbreaker range

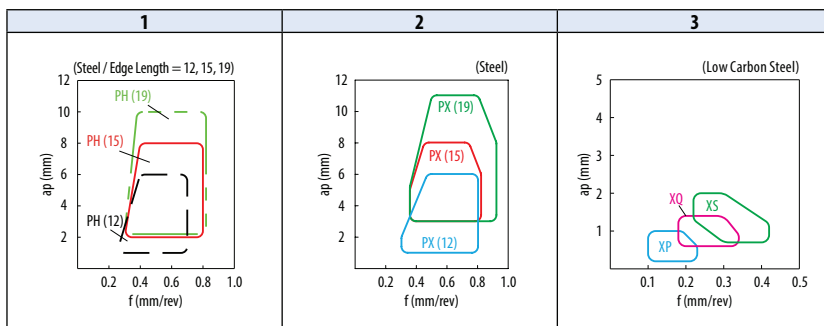

● : Standard item R : Right-hand only L : Left-hand only □ : Check availability

90° Square

How to read pages of "Turning inserts" See page B15

B

Turning indexable inserts

Chip breakers

Negative

C

D

R

S

T

V

W

Ceramic

Insert		Description	Applicable chipbreaker range	Dimension (mm)				Carbide							Applicable toolholder				
				No. of edges	IC	S	D1	RE	CVD			PVD		-					
									CA310	CA315	CA320	CA4515	CA6515	CA6525	PR0055	PR0155	PR1535	SW05	
		SNMG 120404MQ 120408MQ	1	8	12.7	4.76	5.16	0.4 0.8							●	●	●	●	D19~D21 F136
		SNMG 120404MS 120408MS 120412MS 120416MS	1	8	12.7	4.76	5.16	0.4 0.8 1.2 1.6							●	●	●	●	
		SNMG 190612MU 190616MU	1	8	19.05	6.35	7.94	1.2 1.6							●	●	●		
		SNMG 120408SG 120412SG	2	8	12.7	4.76	5.16	0.8 1.2							●	●	●	●	D19~D21 F136
		SNMG 190612SG 190616SG	2	8	19.05	6.35	7.94	1.2 1.6							●	●	●		
		SNMG 120408KG 120412KG	3	8	12.7	4.76	5.16	0.8 1.2	●	●	●								
		SNMG 120408KH 120412KH 120416KH	3	8	12.7	4.76	5.16	0.8 1.2 1.6	●	●	●								D19~D21 F136
		SNMG 120408C 120412C	4	8	12.7	4.76	5.16	0.8 1.2	●	●	●								

Applicable chipbreaker range

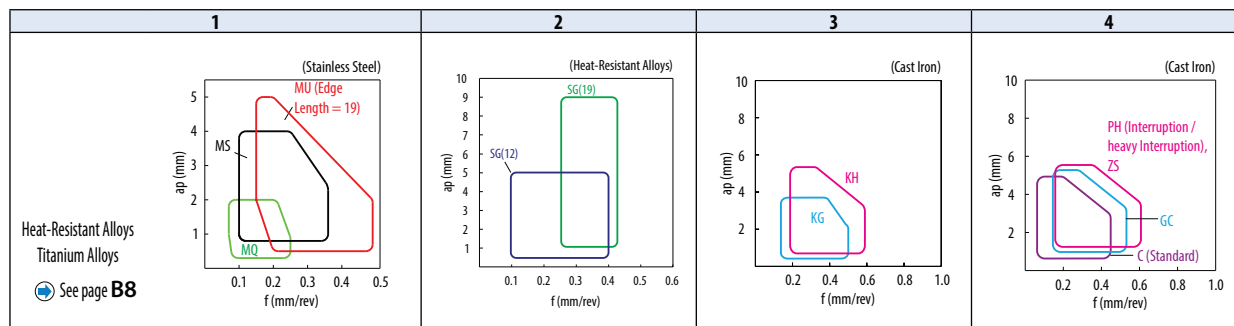

● : Standard item R : Right-hand only L : Left-hand only □ : Check availability

90° Square

How to read pages of "Turning inserts" See page B15

Insert	Description	Applicable chipbreaker range	Dimension (mm)				Carbide				Cermet				Applicable toolholder						
			No. of edges	IC	S	D1	RE	CVD				PVD									
								CA310	CA315	CA320	CA4505	CA4515	CA5505	RW10		PV7005	PV710	PV720	TN60	TN610	TN620
Cast iron	SNMG 120408ZS 120412ZS	1	8	12.7	4.76	5.16	0.8	●	●	●	●	●	●	●	●	●	D19~D21 F136				
Cast iron	SNMG 120408GC 120412GC	1	8	12.7	4.76	5.16	0.8	●	●	●	●	●	●	●	●	●					
Cast iron	SNGA 120404 120408	-	8	12.7	4.76	5.16	0.4						●	●							
	SNMA 120404 120408 120412 120416 120420	-	8	12.7	4.76	5.16	0.4	●	●	●	●	●	●	●	●	●					
Finishing - Medium	SNGG 090304R-B 090304L-B 090308R-B 090308L-B	2	8	9.525	3.18	3.81	0.4						●	●	●	●	D20 D21				
Medium - Roughing	SNGG 120404R-C 120404L-C 120408R-C 120408L-C	2	8	12.7	4.76	5.16	0.4						●	●	●	●	D19~D21 F136				
Medium - Roughing	SNMG 120404R-C 120404L-C 120408R-C 120408L-C	2	8	12.7	4.76	5.16	0.4						●	●	●	●					
							0.4						●	●	●	●					
							0.8						●	●	●	●					
Medium - Roughing	SNGG 120404R-25R 120404L-25R 120408R-25R 120408L-25R	2	8	12.7	4.76	5.16	0.4						●	●	●	●					
							0.4						●	●	●	●					
							0.8						●	●	●	●					
							0.8						●	●	●	●					

Applicable chipbreaker range

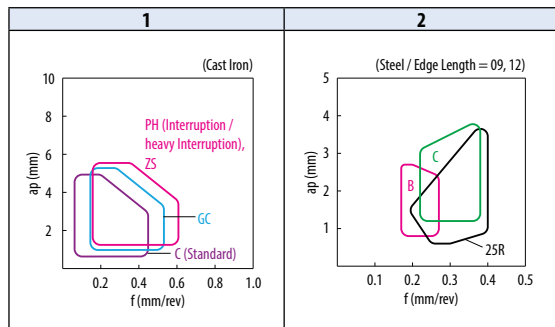

● : Standard item R : Right-hand only L : Left-hand only □ : Check availability

B



Turning indexable inserts

90° Square

How to read pages of "Turning inserts" See page B15

B



Turning indexable inserts

Chip breakers
Negative

- C
- D
- R
- S
- T
- V
- W
- Ceramic

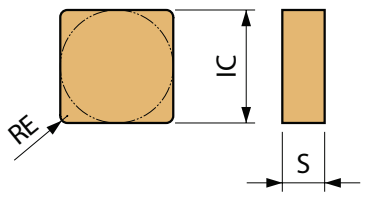

Free-cutting steel					P
Carbon steel / Alloy steel					
Stainless steel					M
Gray cast iron	●	●	●	●	K
Nodular cast iron	○	○	○	○	
Non-ferrous metals					N
Heat-resistant alloy					S
Titanium alloy					
Hard materials					H

Insert	Description	Applicable chipbreaker range	No. of edges	Dimension (mm)			Carbide			Applicable toolholder
				IC	S	RE	CVD			
							CA310	CA315	CA320	
Cast iron  Without Chipbreaker	SNMN 120408 120412	-	8	12.7	4.76	0.8 1.2	● ● ● ●	● ● ●	D52~D54 D63 D64	

● : Standard item R : Right-hand only L : Left-hand only □ : Check availability

60° Triangle

How to read pages of "Turning inserts" See page B15

		Material Compatibility												P														
		Free-cutting steel																										
		Carbon steel / Alloy steel																										
		Stainless steel																										
		Gray cast iron																										
		Nodular cast iron																										
		Non-ferrous metals																										
		Heat-resistant alloy																										
		Titanium alloy																										
		Hard materials																										
Insert	Description	Applicable chipbreaker range	Dimension (mm)				Material										Applicable toolholder											
			No. of edges	IC	S	D1	RE																					
								CVD					PVD	PVD		-												
Finishing	With Wiper Edge	1	6	9.525	4.76	3.81	0.4	CA02SP	CA510	CA515	CA525	CA530	CA530S	CA5515	CA5525	CA5535	CA6515	CA6525	PR1535	CCX	PV710	PV770	PV730	PV90	TN60	TN610	TN620	D22~D25 F137
								CA02SP	CA510	CA515	CA525	CA530	CA530S	CA5515	CA5525	CA5535	CA6515	CA6525	PR1535	CCX	PV710	PV770	PV730	PV90	TN60	TN610	TN620	
								CA02SP	CA510	CA515	CA525	CA530	CA530S	CA5515	CA5525	CA5535	CA6515	CA6525	PR1535	CCX	PV710	PV770	PV730	PV90	TN60	TN610	TN620	
Finishing		3	6	9.525	4.76	3.81	0.2	CA02SP	CA510	CA515	CA525	CA530	CA530S	CA5515	CA5525	CA5535	CA6515	CA6525	PR1535	CCX	PV710	PV770	PV730	PV90	TN60	TN610	TN620	D22~D25 D27, D28 F120 F137 F138
								CA02SP	CA510	CA515	CA525	CA530	CA530S	CA5515	CA5525	CA5535	CA6515	CA6525	PR1535	CCX	PV710	PV770	PV730	PV90	TN60	TN610	TN620	
								CA02SP	CA510	CA515	CA525	CA530	CA530S	CA5515	CA5525	CA5535	CA6515	CA6525	PR1535	CCX	PV710	PV770	PV730	PV90	TN60	TN610	TN620	
Finishing		2	6	6.35	4.76	2.26	0.4	CA02SP	CA510	CA515	CA525	CA530	CA530S	CA5515	CA5525	CA5535	CA6515	CA6525	PR1535	CCX	PV710	PV770	PV730	PV90	TN60	TN610	TN620	D24, D25 F138
								CA02SP	CA510	CA515	CA525	CA530	CA530S	CA5515	CA5525	CA5535	CA6515	CA6525	PR1535	CCX	PV710	PV770	PV730	PV90	TN60	TN610	TN620	
Finishing - Medium		3	6	9.525	4.76	3.81	0.4	CA02SP	CA510	CA515	CA525	CA530	CA530S	CA5515	CA5525	CA5535	CA6515	CA6525	PR1535	CCX	PV710	PV770	PV730	PV90	TN60	TN610	TN620	D22~D25 D27, D28 F120 F137 F138
								CA02SP	CA510	CA515	CA525	CA530	CA530S	CA5515	CA5525	CA5535	CA6515	CA6525	PR1535	CCX	PV710	PV770	PV730	PV90	TN60	TN610	TN620	
								CA02SP	CA510	CA515	CA525	CA530	CA530S	CA5515	CA5525	CA5535	CA6515	CA6525	PR1535	CCX	PV710	PV770	PV730	PV90	TN60	TN610	TN620	
Finishing - Medium		2	6	6.35	4.76	2.26	0.4	CA02SP	CA510	CA515	CA525	CA530	CA530S	CA5515	CA5525	CA5535	CA6515	CA6525	PR1535	CCX	PV710	PV770	PV730	PV90	TN60	TN610	TN620	D24, D25 F138
								CA02SP	CA510	CA515	CA525	CA530	CA530S	CA5515	CA5525	CA5535	CA6515	CA6525	PR1535	CCX	PV710	PV770	PV730	PV90	TN60	TN610	TN620	
Finishing - Medium	Up facing	3	6	9.525	4.76	3.81	0.4	CA02SP	CA510	CA515	CA525	CA530	CA530S	CA5515	CA5525	CA5535	CA6515	CA6525	PR1535	CCX	PV710	PV770	PV730	PV90	TN60	TN610	TN620	D22~D25 D27, D28 F120 F137 F138
								CA02SP	CA510	CA515	CA525	CA530	CA530S	CA5515	CA5525	CA5535	CA6515	CA6525	PR1535	CCX	PV710	PV770	PV730	PV90	TN60	TN610	TN620	
								CA02SP	CA510	CA515	CA525	CA530	CA530S	CA5515	CA5525	CA5535	CA6515	CA6525	PR1535	CCX	PV710	PV770	PV730	PV90	TN60	TN610	TN620	
Finishing - Medium		4	6	12.7	4.76	5.16	0.8	CA02SP	CA510	CA515	CA525	CA530	CA530S	CA5515	CA5525	CA5535	CA6515	CA6525	PR1535	CCX	PV710	PV770	PV730	PV90	TN60	TN610	TN620	D24, D25 F137
								CA02SP	CA510	CA515	CA525	CA530	CA530S	CA5515	CA5525	CA5535	CA6515	CA6525	PR1535	CCX	PV710	PV770	PV730	PV90	TN60	TN610	TN620	

See "Precautions when using Wiper inserts" in the R34 and R35 for WF chipbreaker.

Applicable chipbreaker range

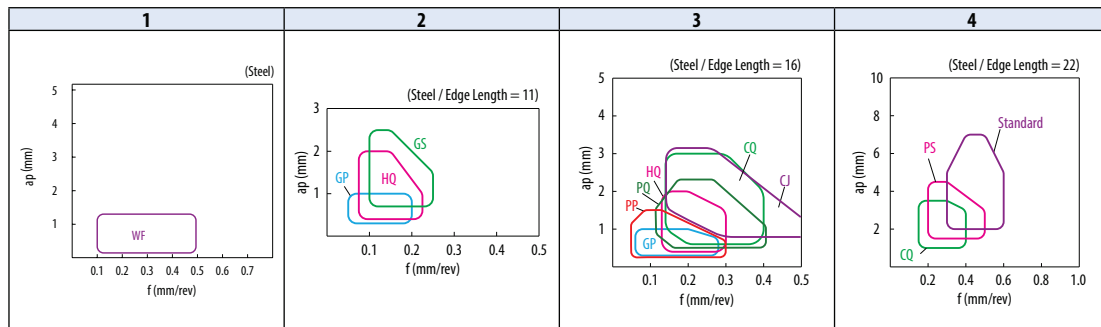

● : Standard item R : Right-hand only L : Left-hand only □ : Check availability

B
Turning indexable inserts

60° Triangle

How to read pages of "Turning inserts" See page B15

B

Turning indexable inserts

Chip breakers

Negative

C

D

R

S

T

V

W

Ceramic

Insert	Description	Applicable chipbreaker range	No. of edges	Dimension (mm)				Material														Applicable toolholder								
				IC	S	D1	RE	Material																						
								Carbide							Cermet															
				CVD							PVD		PVD		-															
				CA02SP	CA310	CA315	CA370	CA4505	CA4515	CA510	CA515	CA525	CA530	CA5505	CA5515	CA5525	CA5535	CA6515	CA6525	PR1535	CCX	PV7005	PV710	PV720	PV730	PI90	TN60	TN610	TN620	
Medium - Roughing	TNMG 110404GS 110408GS	1	6	6.35	4.76	2.26	0.4 0.8	●																						D24, D25 F138
	TNMG 160404GS 160408GS	2	6	9.525	4.76	3.81	0.4 0.8	●																						
Medium - Roughing	TNMG 160404PG 160408PG 160412PG	2	6	9.525	4.76	3.81	0.4 0.8 1.2	●																						D22~D25 D27, D28 F120 F137 F138
Medium - Roughing	TNMG 160404PS 160408PS 160412PS	2	6	9.525	4.76	3.81	0.4 0.8 1.2	●																						D24, D25 F137
	TNMG 220404PS 220408PS 220412PS 220416PS	3	6	12.7	4.76	5.16	0.4 0.8 1.2 1.6	●																						
Medium - Roughing	TNMG 160408PT 160412PT	2	6	9.525	4.76	3.81	0.8 1.2	●																						D22~D25 D27, D28 F120 F137 F138
Medium - Roughing	TNMG 160408GT 160412GT	2	6	9.525	4.76	3.81	0.8 1.2	●																						D22~D25 D27, D28 F120 F137 F138
Roughing	TNMG 160404 160408 160412 160416 160420	2	6	9.525	4.76	3.81	0.4 0.8 1.2 1.6 2	●																						D24, D25 F137
	TNMG 220404 220408 220412	3	6	12.7	4.76	5.16	0.4 0.8 1.2	●																						

Applicable chipbreaker range

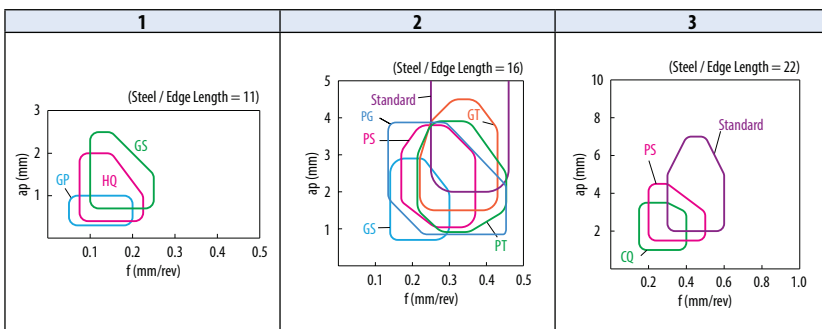

● : Standard item R : Right-hand only L : Left-hand only □ : Check availability

60° Triangle

How to read pages of "Turning inserts" See page B15

		Free-cutting steel											Carbon steel / Alloy steel											Stainless steel											Gray cast iron											Nodular cast iron											Non-ferrous metals											Heat-resistant alloy											Titanium alloy											Hard materials										
		P											M											K											N											S											H																																											
Insert	Description	Applicable chipbreaker range	Dimension (mm)				Carbide											Cermet				Applicable toolholder																																																																														
			No. of edges	IC	S	D1	RE	CVD											CVD	PVD	-																																																																															
				IC	S	D1	RE	CA02SP	CA310	CA315	CA370	CA4505	CA4515	CA510	CA525	CA530	CA5505	CA5515	CA5525	CA5535	CC	PV710	PV720	PV730	PV90	TN60	TN610	TN620																																																																								
Roughing	TNMG 160408PH 160412PH	1	6	9.525	4.76	3.81	0.8 1.2	●	●	●	●	●	●	●	●	●	●	●	●	●	●	●	●	●	●	●	●	●	●	●	D22~D25 D27, D28 F120 F137 F138																																																																					
	TNMG 220408PH 220412PH 220416PH	1	6	12.7	4.76	5.16	0.8 1.2 1.6	●	●	●	●	●	●	●	●	●	●	●	●	●	●	●	●	●	●	●	●	●	●	●	D24, D25 F137																																																																					
Roughing	TNMM 160408PX 160412PX	2	3	9.525	4.76	3.81	0.8 1.2	●	●	●	●	●	●	●	●	●	●	●	●	●	●	●	●	●	●	●	●	●	●	●	D22~D25 D27, D28 F120 F137 F138																																																																					
	TNMM 220408PX 220412PX 220416PX	2	3	12.7	4.76	5.16	0.8 1.2 1.6	●	●	●	●	●	●	●	●	●	●	●	●	●	●	●	●	●	●	●	●	●	●	●	D24, D25 F137																																																																					
Low carbon steel	TNMG 160404XF 160408XF	3	6	9.525	4.76	3.81	0.4 0.8	●	●	●	●	●	●	●	●	●	●	●	●	●	●	●	●	●	●	●	●	●	●	●	D22~D25 D27, D28 F120 F137 F138																																																																					
Low carbon steel	TNMG 160404XP 160408XP	3	6	9.525	4.76	3.81	0.4 0.8	●	●	●	●	●	●	●	●	●	●	●	●	●	●	●	●	●	●	●	●	●	●	●	D22~D25 D27, D28 F120 F137 F138																																																																					
Low carbon steel	TNMG 160404XQ 160408XQ	3	6	9.525	4.76	3.81	0.4 0.8	●	●	●	●	●	●	●	●	●	●	●	●	●	●	●	●	●	●	●	●	●	●	●	D22~D25 D27, D28 F120 F137 F138																																																																					
Low carbon steel	TNMG 160408XS	3	6	9.525	4.76	3.81	0.8	●	●	●	●	●	●	●	●	●	●	●	●	●	●	●	●	●	●	●	●	●	●	●	D22~D25 D27, D28 F120 F137 F138																																																																					

Applicable chipbreaker range

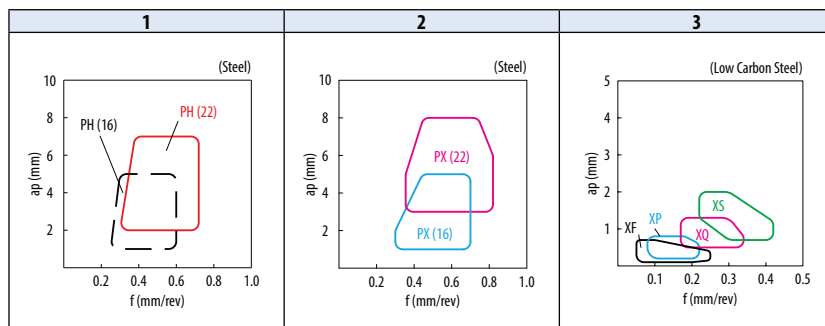

● : Standard item R : Right-hand only L : Left-hand only □ : Check availability

B



Turning indexable inserts

60° Triangle

How to read pages of "Turning inserts" See page B15

B



Turning indexable inserts

Chip breakers

Negative

C

D

R

S

T

V

W

Ceramic

Insert	Description	Applicable chipbreaker range	Dimension (mm)					Carbide							Cermet	Applicable toolholder																																																																																																																																														
			No. of edges	IC	S	D1	RE	CVD																																																																																																																																																						
								CA6515	CA6525	PRO05S	PRO15S	PR1225	PR1535	PR1725			SW05	PV770	PV730																																																																																																																																											
<table border="1"> <tr><td>Free-cutting steel</td><td></td><td></td><td></td><td></td><td></td><td></td><td></td><td></td><td></td><td></td><td></td><td></td><td></td><td></td><td>P</td></tr> <tr><td>Carbon steel / Alloy steel</td><td></td><td></td><td></td><td></td><td></td><td></td><td></td><td></td><td></td><td></td><td></td><td></td><td></td><td></td><td>M</td></tr> <tr><td>Stainless steel</td><td></td><td></td><td></td><td></td><td></td><td></td><td></td><td></td><td></td><td></td><td></td><td></td><td></td><td></td><td>K</td></tr> <tr><td>Gray cast iron</td><td></td><td></td><td></td><td></td><td></td><td></td><td></td><td></td><td></td><td></td><td></td><td></td><td></td><td></td><td>N</td></tr> <tr><td>Nodular cast iron</td><td></td><td></td><td></td><td></td><td></td><td></td><td></td><td></td><td></td><td></td><td></td><td></td><td></td><td></td><td>S</td></tr> <tr><td>Non-ferrous metals</td><td></td><td></td><td></td><td></td><td></td><td></td><td></td><td></td><td></td><td></td><td></td><td></td><td></td><td></td><td>H</td></tr> <tr><td>Heat-resistant alloy</td><td></td><td></td><td></td><td></td><td></td><td></td><td></td><td></td><td></td><td></td><td></td><td></td><td></td><td></td><td></td></tr> <tr><td>Titanium alloy</td><td></td><td></td><td></td><td></td><td></td><td></td><td></td><td></td><td></td><td></td><td></td><td></td><td></td><td></td><td></td></tr> <tr><td>Hard materials</td><td></td><td></td><td></td><td></td><td></td><td></td><td></td><td></td><td></td><td></td><td></td><td></td><td></td><td></td><td></td></tr> </table>															Free-cutting steel															P	Carbon steel / Alloy steel															M	Stainless steel															K	Gray cast iron															N	Nodular cast iron															S	Non-ferrous metals															H	Heat-resistant alloy																Titanium alloy																Hard materials															
Free-cutting steel															P																																																																																																																																															
Carbon steel / Alloy steel															M																																																																																																																																															
Stainless steel															K																																																																																																																																															
Gray cast iron															N																																																																																																																																															
Nodular cast iron															S																																																																																																																																															
Non-ferrous metals															H																																																																																																																																															
Heat-resistant alloy																																																																																																																																																														
Titanium alloy																																																																																																																																																														
Hard materials																																																																																																																																																														
Finishing - Medium Polished / Sharp edge	TNGG	160401MFP-SK 160402MFP-SK 160404MFP-SK	1	6	9.525	4.76	3.81	< 0.1 < 0.2 < 0.4								D22~D25 D27, D28 E64 F120 F137 F138																																																																																																																																														
	TNGG	160402M-SK 160404M-SK	1	6	9.525	4.76	3.81	< 0.2 < 0.4																																																																																																																																																						
Large ap	TNMG	160402R-LD 160404R-LD	2	6	9.525	4.76	3.81	0.2 0.4																																																																																																																																																						
	TNGG	160404FP-TK 160408FP-TK	2	6	9.525	4.76	3.81	0.4 0.8																																																																																																																																																						
Medium - Roughing Polished / Sharp edge	TNGG	160404TK 160408TK	3	6	9.525	4.76	3.81	0.4 0.8																																																																																																																																																						
	TNMG	160404TK 160408TK	3	6	9.525	4.76	3.81	0.4 0.8																																																																																																																																																						
Stainless steel / Heat-resistant alloys	TNMG	160404MQ 160408MQ	3	6	9.525	4.76	3.81	0.4 0.8									D22~D25 D27, D28 F120 F137 F138																																																																																																																																													
	TNMG	160404MS 160408MS 160412MS	3	6	9.525	4.76	3.81	0.4 0.8 1.2																																																																																																																																																						
	TNMG	160404MU 160408MU	3	6	9.525	4.76	3.81	0.4 0.8																																																																																																																																																						

Insert whose corner-R(RE) dimension expressed with less than sign (e.g. <0.05, <0.1, <0.2 etc.) indicate models with minus tolerance on corner-R(RE).

Applicable chipbreaker range

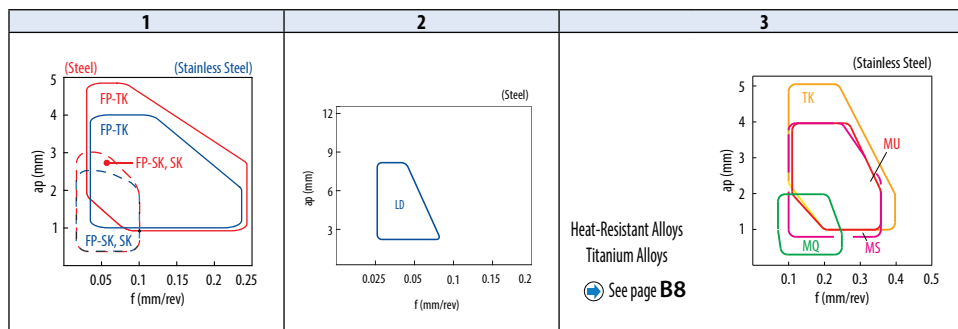

See page B8

● : Standard item R : Right-hand only L : Left-hand only □ : Check availability

60° Triangle

How to read pages of "Turning inserts" See page B15

B



Turning indexable inserts

Insert	Description	Applicable chipbreaker range		Dimension (mm)				Material														Applicable toolholder													
		No. of edges		IC	S	D1	RE	Material																											
		No. of edges						Carbide							Cermet																				
		No. of edges		Carbide							Cermet																								
		No. of edges		CVD							PVD																								
		No. of edges		CA02SP	CA310	CA315	CA370	CA4505	CA4515	CA510	CA525	CA530	CA5505	CA5515	CA5525	CA6515	CA6525	PR0055	PR0155	PR1535	SW05	PV710	PV720	TN60	TN610	TN620									
Stainless steel	Medium - Roughing	1	6	9.525	4.76	3.81	0.4	●													●	●	●	●											
								●																				●	●	●	●				
								●																					●	●	●	●			
								●																						●	●	●	●		
Heat-resistant alloys	Roughing	2	6	9.525	4.76	3.81	0.8														●	●	●												
																											●	●	●						
Heat-resistant alloys	Roughing	2	6	12.7	4.76	5.16	1.2														●	●	●												
																											●	●	●						
Cast iron	Sharp cutting oriented	3	6	9.525	4.76	3.81	0.4		●	●																									
									●	●																									
Cast iron	Roughing	3	6	9.525	4.76	3.81	0.8		●	●																									
									●	●																									
Cast iron	Roughing	3	6	9.525	4.76	3.81	1.2		●	●																									
									●	●																									
Cast iron	Roughing	3	6	9.525	4.76	3.81	1.6		●	●																									
									●	●																									
Cast iron	Roughing	4	6	9.525	4.76	3.81	0.4		●	●																									
									●	●																									
									●	●																									
Cast iron	Roughing	4	6	9.525	4.76	3.81	0.8		●	●	●																								
									●	●	●																								
									●	●	●																								
Cast iron	Roughing	4	6	9.525	4.76	3.81	1.2		●	●	●																								
									●	●	●																								
Cast iron	Roughing	4	6	9.525	4.76	3.81	1.2		●	●	●																								
									●	●	●																								

Applicable chipbreaker range

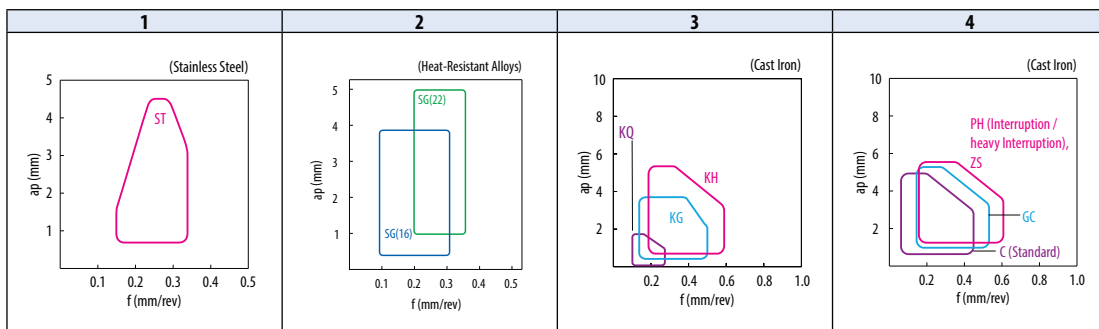

● : Standard item R : Right-hand only L : Left-hand only ☐ : Check availability

60° Triangle

How to read pages of "Turning inserts" See page B15

B

Turning indexable inserts

Chip breakers

Negative

C

D

R

S

T

V

W

Ceramic

Insert		Description		Applicable chipbreaker range		Dimension (mm)				Carbide						Cermet			Applicable toolholder	
						No. of edges	IC	S	D1	RE	CVD			DLC	-	CVD		-		
											CA310	CA315	CA320			CA4505	CA4515	CA5505		PD1010
Cast Iron 	TNGA	110304	-	6	6.35	3.18	2.26	0.4												D24 D25
	TNGA	160404 160408	-	6	9.525	4.76	3.81	0.4 0.8												
	TNMA	160404 160408 160412 160416 160420	-	6	9.525	4.76	3.81	0.4 0.8 1.2 1.6 2	●	●	●	●	●	●	●	●	●	●	●	
	TNGG	160404R-A3 160404L-A3 160408R-A3 160408L-A3	1	6	9.525	4.76	3.81	0.4 0.4 0.8 0.8				●	●	●						D22~D25 D27, D28 F120 F137 F138
Non-Ferrous Metals 	TNGG	160404AH 160408AH	1	6	9.525	4.76	3.81	0.4 0.8				●	●	●						
Non-Ferrous Metals 	TNMG	160404AH 160408AH	1	6	9.525	4.76	3.81	0.4 0.8				●	●	●						

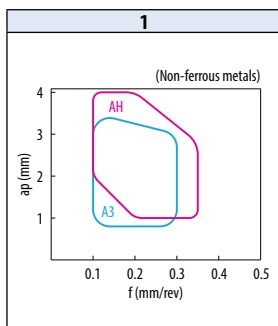

Applicable chipbreaker range



● : Standard item R : Right-hand only L : Left-hand only □ : Check availability

60° Triangle

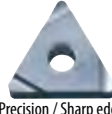
How to read pages of "Turning inserts" See page B15

		Material Compatibility															
		Free-cutting steel														P	
		Carbon steel / Alloy steel															
		Stainless steel	●	●	●	●	●	●	●	●	●	●	●	●	●	M	
		Gray cast iron															
		Nodular cast iron														K	
		Non-ferrous metals														N	
		Heat-resistant alloy															
		Titanium alloy														S	
		Hard materials														H	
Insert	Description	Applicable chipbreaker range	No. of edges	Dimension (mm)				Carbide		Cermet		Applicable toolholder					
				IC	S	D1	RE	PVD	-	PVD	-						
								PR1535 PR1725 PR930	KM10	PV705 PV710 PV720 PV730 PV90	TN60 TN610 TN620						
Finishing 	TNEG 160402R-SSF 160402L-SSF 160404R-SSF 160404L-SSF	2	6	9.525	4.76	3.81	0.2	●	●	●	●	●	●	●	D22~D25 D27, D28 F120 F137 F138		
							0.2	●	●	●	●	●	●	●		●	
							0.4	●	●	●	●	●	●	●		●	●
							0.4	●	●	●	●	●	●	●		●	●
Finishing 	TNGG 110402R-S 110402L-S 110404R-S 110404L-S 110408R-S 110408L-S	1	6	6.35	4.76	2.26	0.2		●			●		D24 D25 F138			
							0.2		●			●					
							0.4					●					
							0.4					●					
							0.8					●					
	TNGG 160401R-S 160401L-S 160402R-S 160402L-S 160404R-S 160404L-S 160408R-S 160408L-S	2	6	9.525	4.76	3.81	0.1				●		●	D22~D25 D27, D28 F120 F137 F138			
							0.1				●		●				
							0.2	●	●	●	●	●	●		●	●	●
							0.2	●	●	●	●	●	●		●	●	●
							0.4	●	●	●	●	●	●		●	●	●
Finishing - Medium 	TNGG 110302R-B 110302L-B 110304R-B 110304L-B	4	6	6.35	3.18	2.26	0.2		●	●	●	●	D24 D25				
							0.2		●	●	●	●					
							0.4		●	●	●	●					
							0.4		●	●	●	●					
	TNGG 160304R-B	3	6	9.525	3.18	3.81	0.4				●		-				
	TNGG 160402R-B 160402L-B 160404R-B 160404L-B 160408R-B 160408L-B	3	6	9.525	4.76	3.81	0.2		●	●	●	●	●	D22~D25 D27, D28 F120 F137 F138			
							0.2		●	●	●	●	●				
							0.4		●	●	●	●	●				
							0.4		●	●	●	●	●				

Applicable chipbreaker range

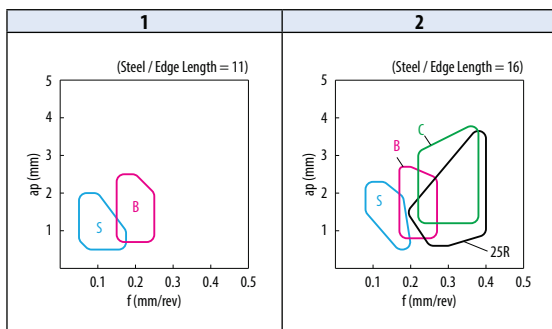

● : Standard item R : Right-hand only L : Left-hand only □ : Check availability

B
Turning indexable inserts

60° Triangle

How to read pages of "Turning inserts" → See page B15

B

Turning indexable inserts

Chip breakers

Negative

C

D

R

S

T

V

W

Ceramic

Insert	Description	Applicable chipbreaker range	Dimension (mm)				Material						Applicable toolholder				
			No. of edges	IC	S	D1	RE	Carbide			Cermet						
								PVD			PVD						
								PR1535	PR930	KW10	PV7005	PV710		PV720	PV730	PR930	TN60
Free-cutting steel	Carbon steel / Alloy steel	Stainless steel	Gray cast iron	Nodular cast iron	Non-ferrous metals	Heat-resistant alloy	Titanium alloy	Hard materials	P	M	K	N	S	H			
Medium - Roughing	TNGG 160402R-C 160402L-C 160404R-C 160404L-C 160408R-C 160408L-C 160412R-C 160412L-C	1	6	9.525	4.76	3.81	0.2									D22~D25 D27, D28 F120 F137 F138	
							0.2										
							0.4										
							0.4										
							0.8										
							0.8										
	1.2																
	1.2																
	TNGG 220404R-C 220404L-C 220408R-C 220408L-C	2	6	12.7	4.76	5.16	0.4									D24 D25 F137	
							0.4										
0.8																	
0.8																	
TNMG 160404R-C 160404L-C 160408R-C 160408L-C 160412R-C	1	6	9.525	4.76	3.81	0.4								D22~D25 D27, D28 F120 F137 F138			
						0.4											
						0.8											
						0.8											
Medium - Roughing	TNGG 110402R 110404R 110404L 110408R	1	6	6.35	4.76	2.26	0.2							D24 D25 F138			
							0.4										
							0.4										
							0.8										
Medium - Roughing	TNGG 160404R-25R 160404L-25R 160408R-25R 160408L-25R	1	6	9.525	4.76	3.81	0.4							D22~D25 D27, D28 F120 F137 F138			
							0.4										
							0.8										
							0.8										

Applicable chipbreaker range

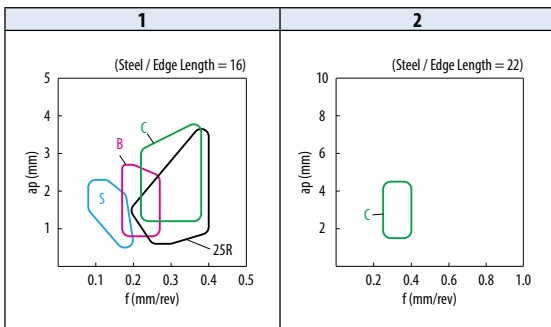

● : Standard item R : Right-hand only L : Left-hand only □ : Check availability

35° Rhombic

How to read pages of "Turning inserts" See page B15

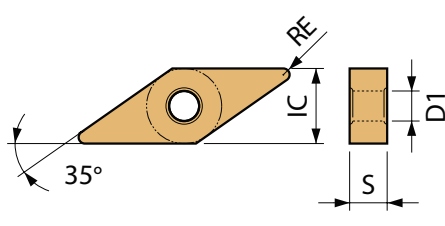

Insert	Description	Applicable chipbreaker range	No. of edges	Dimension (mm)				Material														Applicable toolholder													
				IC	S	D1	RE	Carbide																											
								CVD																											
								CA02SP	CA310	CA315	CA320	CA4505	CA4515	CA515	CA525	CA530	CA5505	CA5515	CA5525	CA5535	CA6515	CA6525	CCX	PV7005	PV710	PV720	PV730	PV90	TN60	TN610	TN620				
Finishing	VNMG 160402PP 160404PP 160408PP 160412PP	1	4	9.525	4.76	3.81	0.2 0.4 0.8 1.2	●						●	●	●	●	●	●	●	●	●	●	●	●	●	●	D30~D39							
Finishing	VNMG 160402GP 160404GP 160408GP	1	4	9.525	4.76	3.81	0.2 0.4 0.8	●						●	●	●	●	●	●	●	●	●	●	●	●	●	●								
Finishing - Medium	VNMG 160404R-VC 160404L-VC 160408R-VC 160408L-VC 160412R-VC 160412L-VC	2	4	9.525	4.76	3.81	0.4	●						●	●	●	●	●	●	●	●	●	●	●	●	●	●		●						
							0.4	●						●	●	●	●	●	●	●	●	●	●	●	●	●	●		●	●	●	●	●		
							0.8	●						●	●	●	●	●	●	●	●	●	●	●	●	●	●		●	●	●	●	●	●	●
							0.8	●						●	●	●	●	●	●	●	●	●	●	●	●	●	●		●	●	●	●	●	●	●
Finishing - Medium	VNMG 160404VF 160408VF 160412VF	3	4	9.525	4.76	3.81	0.4	●						●	●	●	●	●	●	●	●	●	●	●	●	●	●		●						
							0.8	●						●	●	●	●	●	●	●	●	●	●	●	●	●	●		●	●	●	●	●	●	
							1.2	●						●	●	●	●	●	●	●	●	●	●	●	●	●	●	●	●	●	●	●	●	●	●
Finishing - Medium	VNMG 160404PQ 160408PQ 160412PQ	1	4	9.525	4.76	3.81	0.4	●						●	●	●	●	●	●	●	●	●	●	●	●	●	●	●							
							0.8	●						●	●	●	●	●	●	●	●	●	●	●	●	●	●	●	●	●	●	●	●	●	
							1.2	●						●	●	●	●	●	●	●	●	●	●	●	●	●	●	●	●	●	●	●	●	●	●
Finishing - Medium	VNMG 160404HQ 160408HQ 160412HQ	1	4	9.525	4.76	3.81	0.4	●						●	●	●	●	●	●	●	●	●	●	●	●	●	●	●							
							0.8	●						●	●	●	●	●	●	●	●	●	●	●	●	●	●	●	●	●	●	●	●	●	
							1.2	●						●	●	●	●	●	●	●	●	●	●	●	●	●	●	●	●	●	●	●	●	●	●
Medium	VNMG 160404TN-V 160408TN-V 160412TN-V	3	4	9.525	4.76	3.81	0.4 0.8 1.2	●																		●	●								
Roughing	VNMG 160404 160408	3	4	9.525	4.76	3.81	0.4 0.8	●	●	●	●	●	●	●	●	●	●	●	●	●	●	●	●	●	●	●	●	●							

Applicable chipbreaker range

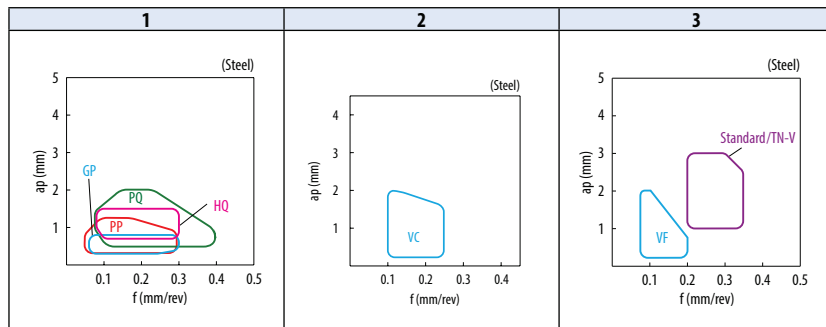

● : Standard item R : Right-hand only L : Left-hand only □ : Check availability

35° Rhombic

How to read pages of "Turning inserts" See page B15

B



Turning indexable inserts

Chip breakers

Negative

C

D

R

S

T

V

W

Ceramic

Insert	Description	Applicable chipbreaker range	Dimension (mm)				Carbide					Cermet		Applicable toolholder					
			No. of edges	IC	S	D1	RE	CVD		PVD		-	PVD		-				
								CA310	CA315	CA320	CA6515	CA6525	PR0055		PR1225	PR1535	PR1725	SN05	PV710
 Finishing - Medium Polished / Sharp edge	VNNG 160402MFP-SK 160404MFP-SK	1	4	9.525	4.76	3.81	< 0.2 < 0.4												
	VNNG 160402M-SK 160404M-SK	1	4	9.525	4.76	3.81	< 0.2 < 0.4												
 Finishing - Medium	VNMG 160404MQ 160408MQ	2	4	9.525	4.76	3.81	0.4 0.8												
	VNMG 160404MS 160408MS 160412MS	2	4	9.525	4.76	3.81	0.4 0.8 1.2												
 Medium - Roughing	VNMG 160404MU 160408MU	2	4	9.525	4.76	3.81	0.4 0.8												
	VNMG 160404SG 160408SG	3	4	9.525	4.76	3.81	0.4 0.8												
 Roughing	VNMG 160408KG 160412KG	4	4	9.525	4.76	3.81	0.8 1.2												
	VNMG 160408KH 160412KH	4	4	9.525	4.76	3.81	0.8 1.2												

Insert whose corner-R(RE) dimension expressed with less than sign (e.g. <0.05, <0.1, <0.2 etc.) indicate models with minus tolerance on corner-R(RE).

Applicable chipbreaker range

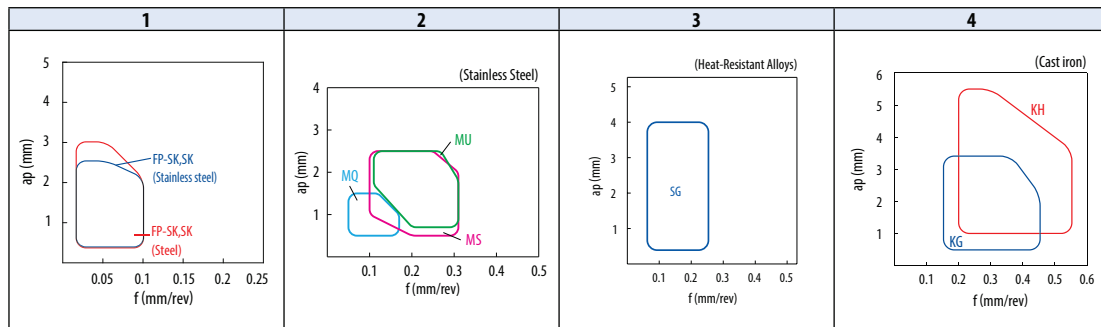

● : Standard item R : Right-hand only L : Left-hand only □ : Check availability

35° Rhombic

How to read pages of "Turning inserts" → See page B15

Insert		Description	Applicable chipbreaker range	Dimension (mm)				Carbide		Cermet		Applicable toolholder	
				No. of edges	IC	S	D1	RE	PVD		PVD		
									-	-	-		-
Cast iron Without Chipbreaker		VNGA 160404 160408	-	4	9.525	4.76	3.81	0.4 0.8	●	●			
									●	●			
									●	●			
Finishing Sharp edge / Surface finish oriented		VNGG 160402R-S 160402L-S 160404R-S 160404L-S	1	4	9.525	4.76	3.81	0.2	●	●	●	●	
								0.2	●	●	●		
								0.4	●	●	●		
								0.4	●	●	●		
Medium		VNGG 160402R 160402L 160404R 160404L 160408R 160408L	1	4	9.525	4.76	3.81	0.2	●	●	●	●	
								0.2	●	●	●		
								0.4	●	●	●		
								0.4	●	●	●		
								0.8	●	●	●		

Applicable chipbreaker range

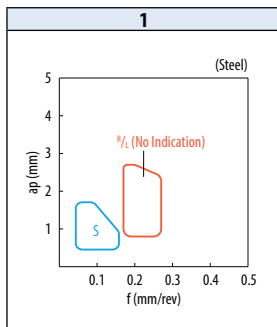

● : Standard item R : Right-hand only L : Left-hand only □ : Check availability

80° Trigon

How to read pages of "Turning inserts" See page B15

B

Turning indexable inserts

Chip breakers

Negative

C

D

R

S

T

V

W

Ceramic

		Free-cutting steel												Carbon steel / Alloy steel												Stainless steel												Gray cast iron												Nodular cast iron												Non-ferrous metals												Heat-resistant alloy												Titanium alloy												Hard materials												
Insert	Description	Applicable chipbreaker range	No. of edges	Dimension (mm)				Carbide						Cermet						Applicable toolholder																																																																																										
				IC	S	D1	RE	CVD						CVD			PVD																																																																																													
								CA02SP	CA510	CA515	CA525	CA530	CA530S	CA5515	CA5525	CCX	PV770	PV720	PV730		PV90	TN60	TN610	TN620																																																																																						
Finishing With Wiper Edge	WNMG 080404WF 080408WF	1	6	12.7	4.76	5.16	0.4	●●●●●●						●●●			●●●			D43~D46 F140 F142 F143																																																																																										
								●●●●●●						●●●			●●●																																																																																													
Finishing With Wiper Edge	WNMG 080404WP 080408WP	2	6	12.7	4.76	5.16	0.4	●●●●●●						●●●			●●●			D43~D46 F140 F142 F143																																																																																										
								●●●●●●						●●●			●●●																																																																																													
Finishing - Medium With Wiper Edge	WNMG 080404WE 080408WE 080412WE	1	6	12.7	4.76	5.16	0.4	●●●●●●						●●●			●●●			D43~D46 F140 F142 F143																																																																																										
							0.8	●●●●●●						●●●			●●●																																																																																													
							1.2	●●●●●●						●●●			●●●																																																																																													
Finishing - Medium With Wiper Edge	WNMG 080404WQ 080408WQ 080412WQ	2	6	12.7	4.76	5.16	0.4	●●●●●●						●●●			●●●			D43~D46 F140 F142 F143																																																																																										
							0.8	●●●●●●						●●●			●●●																																																																																													
							1.2	●●●●●●						●●●			●●●																																																																																													
Finishing	WNMG 080402PP 080404PP 080408PP 080412PP	4	6	12.7	4.76	5.16	0.2	●●●●●●						●●●			●●●			D43~D46 F140 F142 F143																																																																																										
							0.4	●●●●●●						●●●			●●●																																																																																													
							0.8	●●●●●●						●●●			●●●																																																																																													
							1.2	●●●●●●						●●●			●●●																																																																																													
Finishing	WNMG 060404GP 060408GP	3	6	9.525	4.76	3.81	0.4	●●●●●●						●●●			●●●			D45 F140																																																																																										
							0.8	●●●●●●						●●●			●●●																																																																																													
Finishing	WNMG 080404GP 080408GP	4	6	12.7	4.76	5.16	0.4	●●●●●●						●●●			●●●			D43~D46 F140 F142 F143																																																																																										
							0.8	●●●●●●						●●●			●●●																																																																																													
Finishing - Medium	WNMG 080404PQ 080408PQ 080412PQ	4	6	12.7	4.76	5.16	0.4	●●●●●●						●●●			●●●			D43~D46 F140 F142 F143																																																																																										
							0.8	●●●●●●						●●●			●●●																																																																																													
							1.2	●●●●●●						●●●			●●●																																																																																													

See "Precautions when using Wiper inserts" in the R34 and R35 for WF / WE chipbreakers.

Applicable chipbreaker range

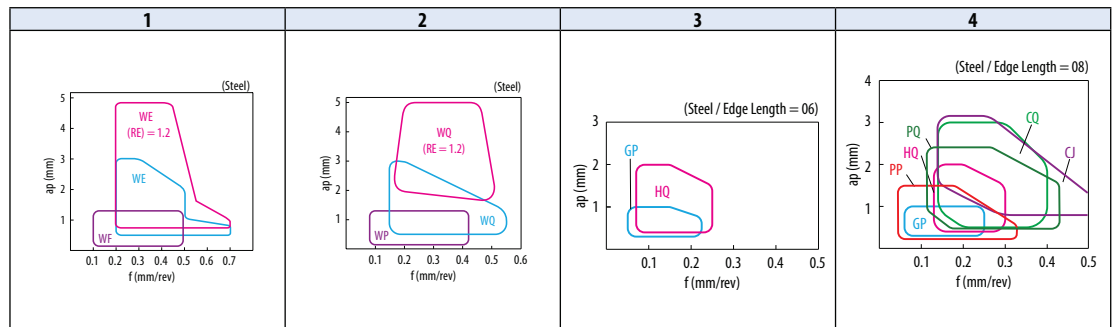

● : Standard item R : Right-hand only L : Left-hand only □ : Check availability

80° Trigon

How to read pages of "Turning inserts" See page B15

Insert	Description	Applicable chipbreaker range		Dimension (mm)				Material										Applicable toolholder										
		No. of edges	IC	S	D1	RE	Material																					
							Free-cutting steel	Carbon steel / Alloy steel	Stainless steel	Gray cast iron	Nodular cast iron	Non-ferrous metals	Heat-resistant alloy	Titanium alloy	Hard materials	P	M		K	N	S	H						
Finishing - Medium		1	6	9.525	3.97	3.81	0.4	CA02SP	CA510	CA515	CA525	CA530	CA5505	CA5515	CA5525	CA5535	CA6515	CA6525	PR1535	CCX	PV710	PV770	PV730	PV90	TN60	TN610	TN620	-
								CA02SP	CA510	CA515	CA525	CA530	CA5505	CA5515	CA5525	CA5535	CA6515	CA6525	PR1535	CCX	PV710	PV770	PV730	PV90	TN60	TN610	TN620	
								CA02SP	CA510	CA515	CA525	CA530	CA5505	CA5515	CA5525	CA5535	CA6515	CA6525	PR1535	CCX	PV710	PV770	PV730	PV90	TN60	TN610	TN620	
Finishing - Medium		2	6	12.7	4.76	5.16	0.4	CA02SP	CA510	CA515	CA525	CA530	CA5505	CA5515	CA5525	CA5535	CA6515	CA6525	PR1535	CCX	PV710	PV770	PV730	PV90	TN60	TN610	TN620	D45 F140
								CA02SP	CA510	CA515	CA525	CA530	CA5505	CA5515	CA5525	CA5535	CA6515	CA6525	PR1535	CCX	PV710	PV770	PV730	PV90	TN60	TN610	TN620	
								CA02SP	CA510	CA515	CA525	CA530	CA5505	CA5515	CA5525	CA5535	CA6515	CA6525	PR1535	CCX	PV710	PV770	PV730	PV90	TN60	TN610	TN620	
Finishing - Medium		2	6	12.7	4.76	5.16	0.4	CA02SP	CA510	CA515	CA525	CA530	CA5505	CA5515	CA5525	CA5535	CA6515	CA6525	PR1535	CCX	PV710	PV770	PV730	PV90	TN60	TN610	TN620	D43~D46 F140 F142 F143
								CA02SP	CA510	CA515	CA525	CA530	CA5505	CA5515	CA5525	CA5535	CA6515	CA6525	PR1535	CCX	PV710	PV770	PV730	PV90	TN60	TN610	TN620	
								CA02SP	CA510	CA515	CA525	CA530	CA5505	CA5515	CA5525	CA5535	CA6515	CA6525	PR1535	CCX	PV710	PV770	PV730	PV90	TN60	TN610	TN620	
Medium - Roughing		3	6	9.525	4.76	3.81	0.4	CA02SP	CA510	CA515	CA525	CA530	CA5505	CA5515	CA5525	CA5535	CA6515	CA6525	PR1535	CCX	PV710	PV770	PV730	PV90	TN60	TN610	TN620	D45 F140
								CA02SP	CA510	CA515	CA525	CA530	CA5505	CA5515	CA5525	CA5535	CA6515	CA6525	PR1535	CCX	PV710	PV770	PV730	PV90	TN60	TN610	TN620	
								CA02SP	CA510	CA515	CA525	CA530	CA5505	CA5515	CA5525	CA5535	CA6515	CA6525	PR1535	CCX	PV710	PV770	PV730	PV90	TN60	TN610	TN620	
Medium - Roughing		3	6	12.7	4.76	5.16	0.4	CA02SP	CA510	CA515	CA525	CA530	CA5505	CA5515	CA5525	CA5535	CA6515	CA6525	PR1535	CCX	PV710	PV770	PV730	PV90	TN60	TN610	TN620	D43~D46 F140 F142 F143
								CA02SP	CA510	CA515	CA525	CA530	CA5505	CA5515	CA5525	CA5535	CA6515	CA6525	PR1535	CCX	PV710	PV770	PV730	PV90	TN60	TN610	TN620	
								CA02SP	CA510	CA515	CA525	CA530	CA5505	CA5515	CA5525	CA5535	CA6515	CA6525	PR1535	CCX	PV710	PV770	PV730	PV90	TN60	TN610	TN620	
Medium - Roughing		3	6	12.7	4.76	5.16	0.4	CA02SP	CA510	CA515	CA525	CA530	CA5505	CA5515	CA5525	CA5535	CA6515	CA6525	PR1535	CCX	PV710	PV770	PV730	PV90	TN60	TN610	TN620	D43~D46 F140 F142 F143
								CA02SP	CA510	CA515	CA525	CA530	CA5505	CA5515	CA5525	CA5535	CA6515	CA6525	PR1535	CCX	PV710	PV770	PV730	PV90	TN60	TN610	TN620	
								CA02SP	CA510	CA515	CA525	CA530	CA5505	CA5515	CA5525	CA5535	CA6515	CA6525	PR1535	CCX	PV710	PV770	PV730	PV90	TN60	TN610	TN620	
Medium - Roughing		3	6	12.7	4.76	5.16	0.8	CA02SP	CA510	CA515	CA525	CA530	CA5505	CA5515	CA5525	CA5535	CA6515	CA6525	PR1535	CCX	PV710	PV770	PV730	PV90	TN60	TN610	TN620	-
								CA02SP	CA510	CA515	CA525	CA530	CA5505	CA5515	CA5525	CA5535	CA6515	CA6525	PR1535	CCX	PV710	PV770	PV730	PV90	TN60	TN610	TN620	
								CA02SP	CA510	CA515	CA525	CA530	CA5505	CA5515	CA5525	CA5535	CA6515	CA6525	PR1535	CCX	PV710	PV770	PV730	PV90	TN60	TN610	TN620	

Applicable chipbreaker range

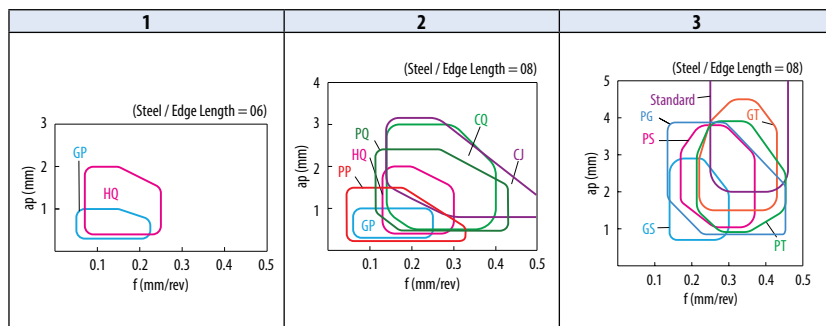

● : Standard item R : Right-hand only L : Left-hand only □ : Check availability

80° Trigon

How to read pages of "Turning inserts" See page B15

B

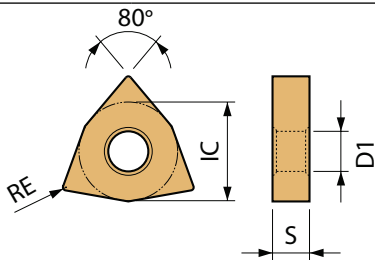

Turning indexable inserts

Chip breakers

Negative

C

D

R

S

T

V

W

Ceramic

Insert	Description	Applicable chipbreaker range	Dimension (mm)				Material																Applicable toolholder																														
			No. of edges	IC	S	D1	RE	Free-cutting steel																																													
								Carbon steel / Alloy steel																																													
																		Stainless steel																																			
																		Gray cast iron																																			
																		Nodular cast iron																																			
																		Non-ferrous metals																																			
																		Heat-resistant alloy																																			
																		Titanium alloy																																			
																		Hard materials																																			
																		P																																			
																		M																																			
																		K																																			
																		N																																			
																		S																																			
																		H																																			
				Carbide				Cermets																																													
				CVD				PVD		CVD		PVD																																									
				CA02SP		CA310		CA315		CA320		CA4505		CA510		CA515		CA525		CA530		CA535		CA5515		CA5525		CA615		CA6525		PR1535		SN05		CCX		PV7005		PV710		PV720		PV730		PV90		TN60		TN610		TN620	
Medium - Roughing	High feed	WNGM	080408GT	080412GT	1	6	12.7	4.76	5.16	0.8	1.2																																										
Roughing		WNGM	080404	080408	080412	1	6	12.7	4.76	5.16	0.4	0.8	1.2																																								
Roughing		WNGM	080408PH	080412PH	2	6	12.7	4.76	5.16	0.8	1.2																																										
Low carbon steel	Finishing	WNGM	080404XP	080408XP	3	6	12.7	4.76	5.16	0.4	0.8																	D43~D46 F140 F142 F143																									
Low carbon steel	Medium	WNGM	080404XQ	080408XQ	3	6	12.7	4.76	5.16	0.4	0.8																																										
Low carbon steel	Roughing	WNGM	080408XS		3	6	12.7	4.76	5.16	0.8																																											
Heat-resistant alloys	Medium - Roughing / Sharp edge	WNGG	080404TK	080408TK	4	6	12.7	4.76	5.16	0.4	0.8																																										
Stainless steel	Medium - Roughing	WNGM	080404TK	080408TK	4	6	12.7	4.76	5.16	0.4	0.8																																										

Applicable chipbreaker range

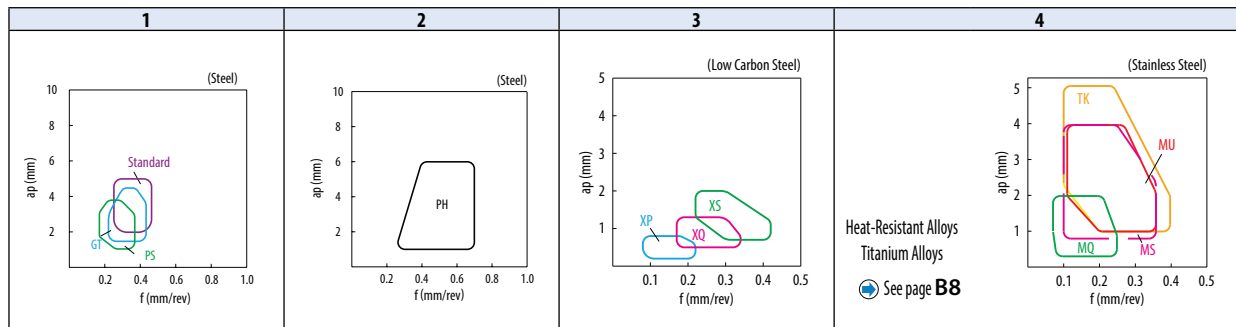

● : Standard item R : Right-hand only L : Left-hand only □ : Check availability

80° Trigon

How to read pages of "Turning inserts" See page B15

Insert		Description	Applicable chipbreaker range	Dimension (mm)				Carbide						Applicable toolholder	
Material	Grade			No. of edges	IC	S	D1	RE	CVD		PVD		-		
									CA310	CA315	CA320	CA6515			CA6525
Stainless steel / Heat-resistant alloys	Finishing - Medium	WNMG 080404MQ 080408MQ	1	6	12.7	4.76	5.16	0.4	●	●	●	●	●	●	D43~D46 F140 F142 F143
	Medium - Roughing	WNMG 080404MS 080408MS 080412MS	1	6	12.7	4.76	5.16	0.4 0.8 1.2	●	●	●	●	●	●	
	Medium - Roughing	WNMG 080404MU 080408MU	1	6	12.7	4.76	5.16	0.4 0.8	●	●	●	●	●	●	
Heat-resistant alloys	Roughing	WNMG 080408SG 080412SG	2	6	12.7	4.76	5.16	0.8 1.2	●	●	●	●	●	●	
Cast iron	Sharp cutting oriented	WNMG 080404KQ 080408KQ 080412KQ	3	6	12.7	4.76	5.16	0.4 0.8 1.2	●	●	●	●	●	●	
Cast iron	Roughing	WNMG 080404KG 080408KG 080412KG	3	6	12.7	4.76	5.16	0.4 0.8 1.2	●	●	●	●	●	●	
Cast iron	Roughing	WNMG 080408KH 080412KH 080416KH	3	6	12.7	4.76	5.16	0.8 1.2 1.6	●	●	●	●	●	●	

Turning indexable inserts

Applicable chipbreaker range

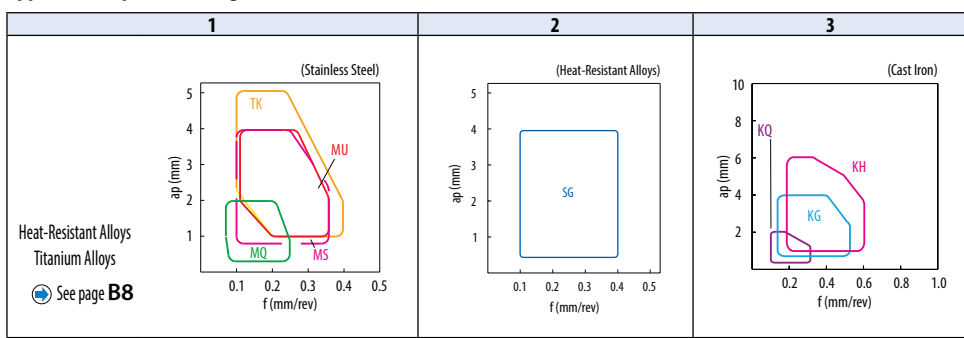

● : Standard item R : Right-hand only L : Left-hand only □ : Check availability

80° Trigon

How to read pages of "Turning inserts" See page B15

B

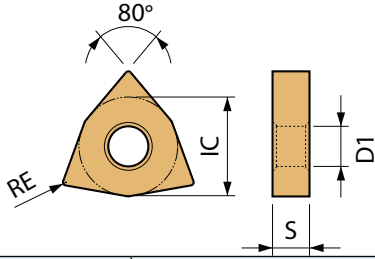

Turning indexable inserts

Chip breakers

Negative

C

D

R

S

T

V

W

Ceramic

Insert	Description	Applicable chipbreaker range	Dimension (mm)				Carbide					Cermet		Applicable toolholder				
			No. of edges	IC	S	D1	RE	CVD				DLC	- CVD		- PVD			
								CA310	CA315	CA320	CA4505					CA4515	CA5505	PO1010
Free-cutting steel																	P	
Carbon steel / Alloy steel																		M
Stainless steel																		M
Gray cast iron			●	●	●	●	●	●	●	●	●	●	●	●	●	●	●	K
Nodular cast iron			○	○	○	○	○	○	○	○	○	○	○	○	○	○	○	K
Non-ferrous metals										●	●	●	●	●	●	●	●	N
Heat-resistant alloy																		S
Titanium alloy																		S
Hard materials																		H
Cast iron	WNGM 080404C 080408C 080412C	1	6	12.7	4.76	5.16	0.4 0.8 1.2	●	●	●	●	●	●	●	●	●	●	D43~D46 F140 F142 F143
Cast iron	WNGM 080408ZS 080412ZS	1	6	12.7	4.76	5.16	0.8 1.2	●	●	●	●	●	●	●	●	●	●	
Cast iron	WNGM 080408GC 080412GC	1	6	12.7	4.76	5.16	0.8 1.2	●	●	●	●	●	●	●	●	●	●	
Cast iron	WNMA 080408 080412	-	6	12.7	4.76	5.16	0.8 1.2	●	●	●	●	●	●	●	●	●	●	
Non-Ferrous Metals	WNGG 080404AH 080408AH	2	6	12.7	4.76	5.16	0.4 0.8					●	●	●	●	●	●	
Finishing	WNGG 060402R-S 060402L-S 060404R-S 060404L-S 060408R-S 060408L-S	3	6	9.525	4.76	3.81	0.2 0.2 0.4 0.4 0.8 0.8											D45 F140
Medium	WNGG 060404R 060404L	3	6	9.525	4.76	3.81	0.4										●	

Applicable chipbreaker range

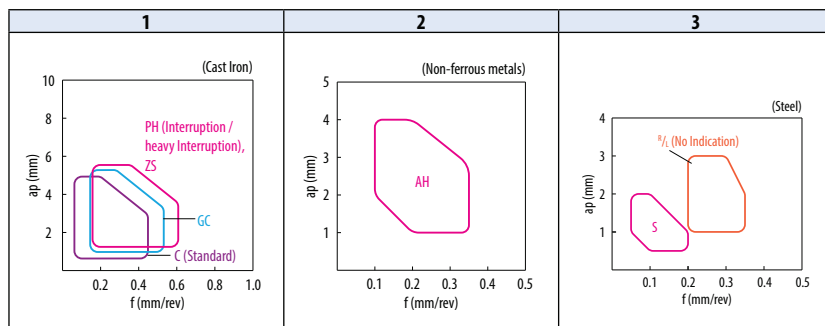

● : Standard item R : Right-hand only L : Left-hand only □ : Check availability

Small double sided tools

How to read pages of "Turning inserts" See page B15

Insert	Description	Applicable chipbreaker range	No. of edges	Dimension (mm)				Carbide			Applicable toolholder
				IC	S	D1	RE	PVD			
								PR1725	PR1535	PR1705	
Free-cutting steel											P
Carbon steel / Alloy steel											P
Stainless steel											M
Gray cast iron											K
Nodular cast iron											K
Non-ferrous metals											N
Heat-resistant alloy											S
Titanium alloy											S
Hard materials											H

Finish	Insert	Description	Applicable chipbreaker range	No. of edges	IC	S	D1	RE	Carbide			Applicable toolholder
									PR1725	PR1535	PR1705	
Finishing - Medium Polished / Sharp edge	CNGU	070301MFP-SK 070302MFP-SK	1	4	7.5	3.18	3.6	< 0.1	●	●	●	E60
								< 0.2	●	●	●	
Medium - Roughing With honing	CNMU	070302E-GK 070304E-GK	1	4	7.5	3.18	3.6	0.2	●	●	●	E60
								0.4	●	●	●	
Finishing Sharp edge	CNGU	0703005MFR-F 070301MFR-F 070302MFR-F 070304MFR-F	1	4	7.5	3.18	3.6	< 0.05	●	●	●	E60
								< 0.1	●	●	●	
								< 0.2	●	●	●	
								< 0.4	●	●	●	
Low feed Sharp edge	CNGU	0703005MFR-U 070301MFR-U 070302MFR-U 070304MFR-U	1	4	7.5	3.18	3.6	< 0.05	●	●	●	E60
								< 0.1	●	●	●	
								< 0.2	●	●	●	
								< 0.4	●	●	●	

Insert whose corner-R(RE) dimension expressed with less than sign (e.g. <0.05, <0.1, <0.2 etc.) indicate models with minus tolerance on corner-R(RE).

Small Double Sided Tools Identification System

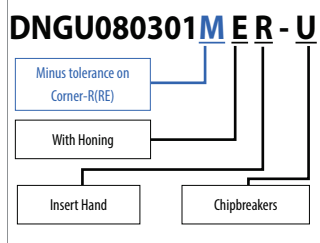
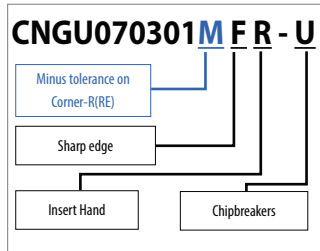
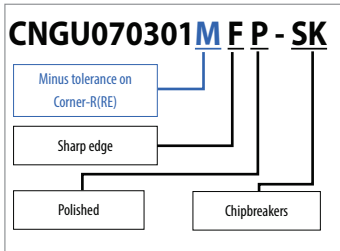

When a minus tolerance is specified for the corner-R(RE)

If a minus tolerance is specified for the corner-R(RE) as shown in the Fig. 1, using an insert with corner-R(RE)=0.2 mm may result in larger radius than specified. Use an insert the corner of which R(RE) has a minus tolerance.

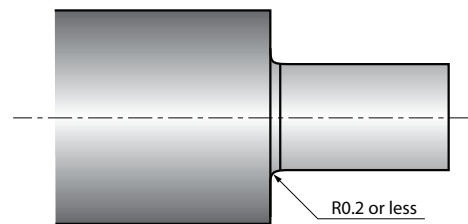
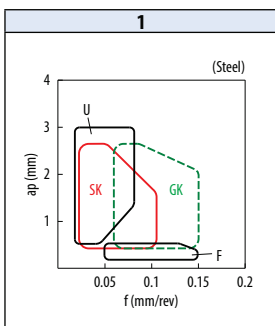

Fig. 1 Example of a specified corner-R in the drawing

Applicable chipbreaker range



● : Standard item R : Right-hand only L : Left-hand only □ : Check availability



Small double sided tools

How to read pages of "Turning inserts" See page B15

Turning indexable inserts

Chip breakers

Negative

C

D

R

S

T

V

W

Ceramic

Insert	Description	Applicable chipbreaker range	Dimension (mm)				Carbide			Applicable toolholder	
			No. of edges	IC	S	D1	RE	PVD			
								PR1725	PR1535		PR1705
Finishing - Medium Polished / Sharp edge	DNGU 080301MFP-SK 080302MFP-SK 080304MFP-SK	1	4	7	3.18	3.6	< 0.1 < 0.2 < 0.4	● ● ●	● ● ●	E61	
Medium - Roughing With honing	DNMU 080302E-GK 080304E-GK	1	4	7	3.18	3.6	0.2 0.4	● ● ●	● ● ●		
Finishing Sharp edge	DNGU 080301MFR-F 080302MFR-F 080304MFR-F	1	4	7	3.18	3.6	< 0.1 < 0.2 < 0.4	● ● ●	● ● ●		
Low feed Sharp edge	DNGU 080301MFR-U 080302MFR-U 080304MFR-U	1	4	7	3.18	3.6	< 0.1 < 0.2 < 0.4	● ● ●	● ● ●		
Low feed With honing	DNGU 080301MER-U 080302MER-U 080304MER-U	1	4	7	3.18	3.6	< 0.1 < 0.2 < 0.4	● ● ●	● ● ●		

Insert whose corner-R(RE) dimension expressed with less than sign (e.g. <0.05, <0.1, <0.2 etc.) indicate models with minus tolerance on corner-R(RE).

Chipbreaker Selection (Negative Inserts)

Cutting Range	Name	Cross-section	Advantages
Finishing - Medium	SK		A low cutting force chipbreaker designed for chip control in steel and stainless steel. Cutting performance is similar to comparable sized positive inserts.
Medium - Roughing	GK		Good chip evacuation at wide range by breaker dot and wide chip pocket.
Finishing	F		Good chip control at finishing with low cutting force.
Low Feed	U		Good chip control at low feed rate and varied ap with low cutting force.

Applicable chipbreaker range

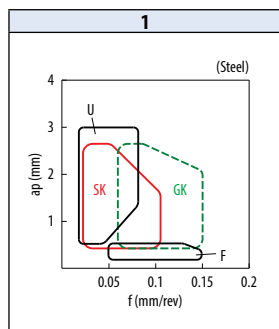

● : Standard item R : Right-hand only L : Left-hand only □ : Check availability

Small double sided tools

How to read pages of "Turning inserts" See page B15

Insert		Description	Applicable chipbreaker range	Dimension (mm)				Carbide			Applicable toolholder		
				No. of edges	IC	S	D1	RE	PVD				
									PR1725	PR1535		PR1705	
Finishing		TNGU 0903005MFR-F 090301MFR-F 090302MFR-F 090304MFR-F	1	6	5.56	3.18	3	< 0.05	●	●	●	E62	
									< 0.1	●	●		●
									< 0.2	●	●		●
Low feed		TNGU 090301MFR-U 090302MFR-U 090304MFR-U	1	6	5.56	3.18	3	< 0.1	●	●	E62		
								< 0.2	●	●			
								< 0.4	●	●			
Low feed		TNGU 090304MER-U	1	6	5.56	3.18	3	< 0.4	●	●	E62		

Insert whose corner-R(RE) dimension expressed with less than sign (e.g. <0.05, <0.1, <0.2 etc.) indicate models with minus tolerance on corner-R(RE).

Applicable chipbreaker range

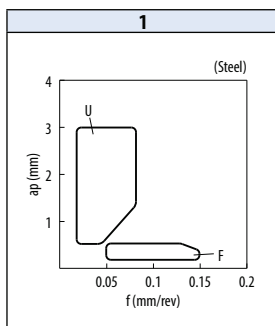

● : Standard item R : Right-hand only L : Left-hand only □ : Check availability

80° Rhombic

How to read pages of "Turning inserts" See page B15

B

Turning indexable inserts

Chip breakers

Positive

C

D

R

S

T

V

W

Ceramic

Insert	Description	Applicable chipbreaker range		Dimension (mm)				Angle (°)	Carbide				Applicable toolholder		
		No. of edges	No. of inserts	IC	S	D1	RE		AN	DLC					
								PVD							
Minutap Polished / Sharp edge	CCGT 030101MP-CF 030102MP-CF	1	2	3.5	1.4	2	< 0.1 < 0.2	7							F31 F32 F60 F62
	CCGT 040101MP-CF 040102MP-CF	1	2	4.3	1.8	2.4	< 0.1 < 0.2	7							
Finishing Polished / Sharp edge	CCGT 030101MFP-PF 030102MFP-PF	2	2	3.5	1.4	2	< 0.1 < 0.2	7							
	CCGT 040101MFP-PF 040102MFP-PF	2	2	4.3	1.8	2.4	< 0.1 < 0.2	7							
	CCGT 060201MFP-PF 060202MFP-PF 060204MFP-PF	2	2	6.35	2.38	3	< 0.1 < 0.2 < 0.4	7						E26 E28 E54 F31 F32 F60~F62	
Finishing Polished / Sharp edge	CCGT 060201MFP-GF 060202MFP-GF 060204MFP-GF	2	2	6.35	2.38	3	< 0.1 < 0.2 < 0.4	7						E26~E28 E54 F60~F62 F122	
	CCGT 09T301MFP-GF 09T302MFP-GF 09T304MFP-GF	2	2	9.525	3.97	4.7	< 0.1 < 0.2 < 0.4	7							

Insert whose corner-R(RE) dimension expressed with less than sign (e.g. <0.05, <0.1, <0.2 etc.) indicate models with minus tolerance on corner-R(RE).

Applicable chipbreaker range

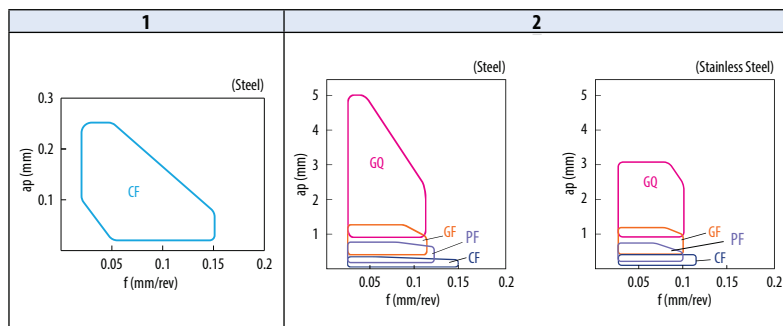

● : Standard item R : Right-hand only L : Left-hand only □ : Check availability

80° Rhombic

How to read pages of "Turning inserts" See page B15

Insert	Description	Applicable chipbreaker range	Dimension (mm)				Angle (°)	Carbide				Applicable toolholder		
			No. of edges	IC	S	D1		RE	AN	Cermet				
										POL10	POL025		PRI225	PRI1535
Finishing Polished / Sharp Edge	CCGT 0602005MFP-SKS 060201MFP-SKS 060202MFP-SKS	1	2	6.35	2.38	3	< 0.05 < 0.1 < 0.2	7		●	●	●	●	E26, E28 E54 F31, F32 F60~F62
	CCGT 09T3005MFP-SKS 09T301MFP-SKS 09T302MFP-SKS 09T304MFP-SKS	1	2	9.525	3.97	4.7	< 0.05 < 0.1 < 0.2 < 0.4	7		●	●	●	●	E26~E28 E54 F60~F62 F122
Finishing Polished / Sharp edge	CCGT 060201MFP-SK 060202MFP-SK 060204MFP-SK	1	2	6.35	2.38	3	< 0.1 < 0.2 < 0.4	7	●	●	●	●	●	E26, E28 E54 F31, F32 F60~F62
	CCGT 09T301MFP-SK 09T302MFP-SK 09T304MFP-SK	1	2	9.525	3.97	4.7	< 0.1 < 0.2 < 0.4	7	●	●	●	●	●	E26~E28 E54 F60~F62 F122
Finishing Polished / Sharp edge	CCGT 060201MP-CK 060202MP-CK	1	2	6.35	2.38	3	< 0.1 < 0.2	7	●	●	●	●	●	E26, E28 E54 F31, F32 F60~F62
	CCGT 09T301MP-CK 09T302MP-CK	1	2	9.525	3.97	4.7	< 0.1 < 0.2	7	●	●	●	●	●	E26~E28 E54 F60~F62 F122
Finishing - Medium Polished / Sharp edge	CCGT 060201MFP-GQ 060202MFP-GQ 060204MFP-GQ	2	2	6.35	2.38	3	< 0.1 < 0.2 < 0.4	7	●	●	●	●	●	E26, E28 E54 F31, F32 F60~F62
	CCGT 09T301MFP-GQ 09T302MFP-GQ 09T304MFP-GQ	2	2	9.525	3.97	4.7	< 0.1 < 0.2 < 0.4	7	●	●	●	●	●	E26~E28 E54 F60~F62 F122

Insert whose corner-R(RE) dimension expressed with less than sign (e.g. <0.05, <0.1, <0.2 etc.) indicate models with minus tolerance on corner-R(RE).

Applicable chipbreaker range

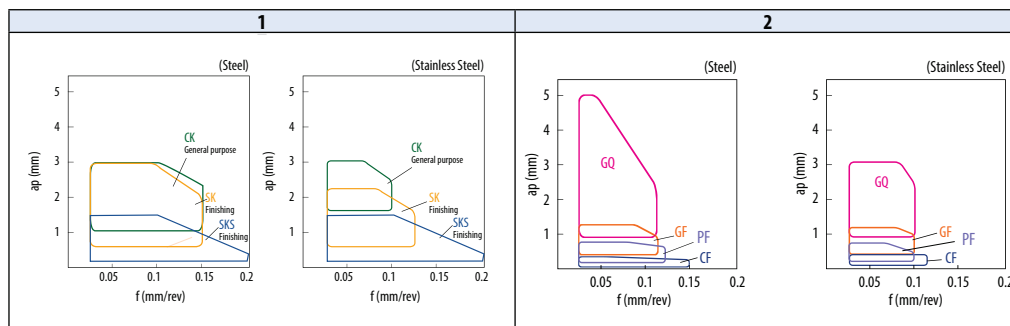

● : Standard item R : Right-hand only L : Left-hand only □ : Check availability

Turning indexable inserts

80° Rhombic

How to read pages of "Turning inserts" See page B15

- B
- Turning indexable inserts
- Chip breakers
- Positive
- C
- D
- R
- S
- T
- V
- W
- Ceramic

Insert	Description	Applicable chipbreaker range	Dimension (mm)					Angle (°)	Carbide												Cermet					Applicable toolholder													
			No. of edges	IC	S	D1	RE		AN	CVD						PVD			CVD			PVD																	
										CA02SP	CA310	CA315	CA320	CA4505	CA4515	CA510	CA525	CA530	CA5505	CA5515	CA5525	CA5535	CA6515	CA6525	PR1725		PR1535	PR1705	PR1725	PR930	CCX	PV7005	PV710	PV770	PV730	PV90	TN60	TN610	TN620
Finishing With Wiper Edge	CCMT 060202WP 060204WP 060208WP	1	2	6.35	2.38	3	0.2 0.4 0.8	7	●				●	●	●					●	●												●	●	●				E26, E28, E54 F31, F32 F60-F62
	CCMT 09T302WP 09T304WP 09T308WP	1	2	9.525	3.97	4.7	0.2 0.4 0.8	7	●				●	●	●					●	●												●	●	●				E26-E28, E54 F60-F62 F122
Finishing	CCMT 060202PP 060204PP	2	2	6.35	2.38	3	0.2 0.4	7	●				●	●	●					●	●												●	●	●				E26, E28, E54 F31, F32 F60-F62
	CCMT 09T302PP 09T304PP 09T308PP	2	2	9.525	3.97	4.7	0.2 0.4 0.8	7	●				●	●	●					●	●												●	●	●				E26-E28, E54 F60-F62 F122
Finishing - Medium	CCMT 060202GK 060204GK	2	2	6.35	2.38	2.8	0.2 0.4	7	●				●	●	●					●	●											●	●	●				E26, E28, E54 F31, F32 F60-F62	
	CCMT 09T302GK 09T304GK	2	2	9.525	3.97	4.4	0.2 0.4	7	●				●	●	●					●	●											●	●	●				E26-E28, E54 F60-F62 F122	
	CCMT 120404GK 120408GK 120412GK	2	2	12.7	4.76	5.5	0.4 0.8 1.2	7	●				●	●	●					●	●												●	●	●				E28
Finishing - Medium	CCMT 060202HQ 060204HQ	2	2	6.35	2.38	2.8	0.2 0.4	7	●				●	●	●					●	●											●	●	●				E26, E28, E54 F31, F32 F60-F62	
	CCMT 09T302HQ 09T304HQ 09T308HQ	2	2	9.525	3.97	4.4	0.2 0.4 0.8	7	●				●	●	●					●	●											●	●	●				E26-E28, E54 F60-F62 F122	
Medium	CCGT 060201 060202 060204	2	2	6.35	2.38	2.8	0.1 0.2 0.4	7																									●	●	●				E26, E28, E54 F31, F32 F60-F62
	CCGT 09T301 09T302 09T304	2	2	9.525	3.97	4.4	0.1 0.2 0.4	7																								●	●	●				E26-E28, E54 F60-F62 F122	
	CCMT 09T308	2	2	9.525	3.97	4.4	0.8	7	●				●	●	●					●	●											●	●	●					

See "Precautions when using Wiper inserts" in the R36 and R37 for WP chipbreaker.

Applicable chipbreaker range

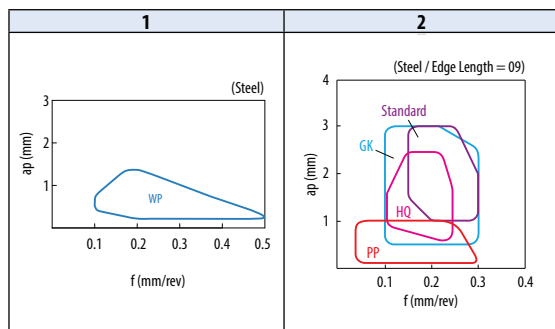

● : Standard item R : Right-hand only L : Left-hand only □ : Check availability

80° Rhombic

How to read pages of "Turning inserts" See page B15

Insert	Description	Applicable chipbreaker range		Dimension (mm)				Angle (°)	Carbide							Cermet	Applicable toolholder	
		No. of edges	No. of edges	IC	S	D1	RE		AN	CVD		PVD			-			-
								CA6515		CA6525	PR0055	PR0155	PR1725	PR1535		PR1705		
Medium Sharp edge	CCGT 0602005MF 060201MF 060202MF 060204MF	1	2	6.35	2.38	2.8	< 0.05 < 0.1 < 0.2 < 0.4	7				●	●	●	●			E26, E28 E54 F31, F32 F60~F62
	CCGT 09T3005MF 09T301MF 09T302MF 09T304MF	1	2	9.525	3.97	4.4	< 0.05 < 0.1 < 0.2 < 0.4	7				●	●	●	●			E26~E28 E54 F60~F62
Stainless steel / Heat-resistant alloys Finishing - Medium	CCMT 09T304MQ 09T308MQ	2	2	9.525	3.97	4.7	0.4 0.8	7	●	●	●	●	●	●	●	●		F122
Finishing Precision / Sharp edge	CCET 0301003R-FSF 0301003L-FSF 030101R-FSF 030101L-FSF 030102R-FSF 030102L-FSF 030104R-FSF 030104L-FSF	3	2	3.5	1.4	1.9	0.03 0.03 0.1 0.1 0.2 0.2 0.4 0.4	7							●	●		F31 F32 F60 F62
	CCET 040101R-FSF 040101L-FSF 040102R-FSF 040102L-FSF 040104R-FSF 040104L-FSF	4	2	4.3	1.8	2.3	0.1 0.1 0.2 0.2 0.4 0.4	7							●	●		
Finishing Precision / Sharp edge	CCET 0301005ML-FSF 030101MR-FSF 030101ML-FSF 030102MR-FSF 030102ML-FSF 030104MR-FSF 030104ML-FSF	3	2	3.5	1.4	1.9	< 0.05 < 0.1 < 0.1 < 0.2 < 0.2 < 0.4 < 0.4	7				●	●	●	●			F31 F32 F60 F62
	CCET 0401005ML-FSF 040101MR-FSF 040101ML-FSF 040102MR-FSF 040102ML-FSF 040104MR-FSF 040104ML-FSF	4	2	4.3	1.8	2.3	< 0.05 < 0.1 < 0.1 < 0.2 < 0.2 < 0.4 < 0.4	7				●	●	●	●			

Insert whose corner-R(RE) dimension expressed with less than sign (e.g. <0.05, <0.1, <0.2 etc.) indicate models with minus tolerance on corner-R(RE).

Applicable chipbreaker range

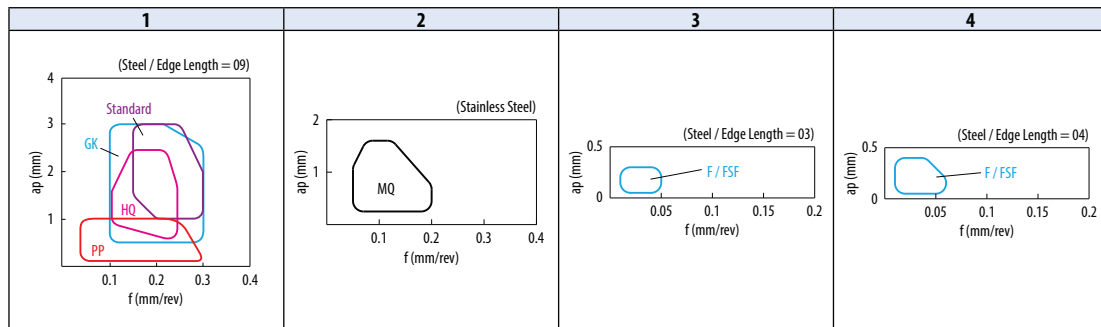

● : Standard item R : Right-hand only L : Left-hand only □ : Check availability

Turning indexable inserts

80° Rhombic

How to read pages of "Turning inserts" See page B15

B



Turning indexable inserts

Chip breakers

Positive

C

D

R

S

T

V

W

Ceramic

Insert	Description	Applicable chipbreaker range	Dimension (mm)				Angle (°)	Carbide						Cermet				Applicable toolholder						
			IC	S	D1	RE		AN	DLC		PVD		-		PVD		-							
									PD1010	PD1025	PR1725	PR1535	PR1705	PR1725	PR930	KW10	PV710		PV720	PV730	PV90	TN60	TN610	TN620
<div style="display: flex; align-items: center;"> </div>																								
Finishing 	CCET	0301005MR-F 0301005ML-F 030101MR-F 030101ML-F 030102MR-F 030102ML-F 030104MR-F 030104ML-F	1	2	3.5	1.4	1.9	< 0.05 < 0.05 < 0.1 < 0.1 < 0.2 < 0.2 < 0.4 < 0.4	7			●	●	●		●	●		●	●	●	●	F31 F32 F60 F62	
	CCET	040101MR-F 040101ML-F 040102MR-F 040102ML-F 040104MR-F 040104ML-F	2	2	4.3	1.8	2.3	< 0.1 < 0.1 < 0.2 < 0.2 < 0.4 < 0.4	7	●	●	●	●	●	●	●	●	●	●	●	●	●		●
	CCGT	0301003L-F 030101R-F 030101L-F 030102R-F 030102L-F 030104R-F 030104L-F	1	2	3.5	1.4	1.9	0.03 0.1 0.1 0.2 0.2 0.4 0.4	7					●	●	●	●		●	●				
	CCGT	0401003L-F 040101R-F 040101L-F 040102R-F 040102L-F 040104R-F 040104L-F	2	2	4.3	1.8	2.3	0.03 0.1 0.1 0.2 0.2 0.4 0.4	7					●	●	●		●	●					
	CCGT	0301005ML-F 030101MR-F 030101ML-F 030102MR-F 030102ML-F 030104MR-F 030104ML-F	1	2	3.5	1.4	1.9	< 0.05 < 0.1 < 0.1 < 0.2 < 0.2 < 0.4 < 0.4	7	●	●	●	●											
	CCGT	0401005ML-F 040101MR-F 040101ML-F 040102MR-F 040102ML-F 040104MR-F 040104ML-F	2	2	4.3	1.8	2.3	< 0.05 < 0.1 < 0.2 < 0.2 < 0.4 < 0.4	7	●	●	●	●											

Insert whose corner-R(RE) dimension expressed with less than sign (e.g. <0.05, <0.1, <0.2 etc.) indicate models with minus tolerance on corner-R(RE).

Applicable chipbreaker range

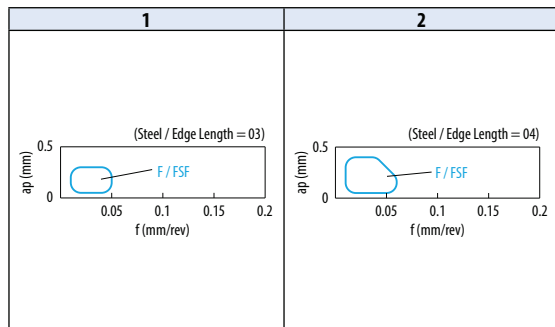



● : Standard item R : Right-hand only L : Left-hand only □ : Check availability

80° Rhombic

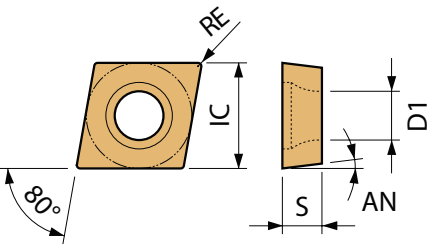
How to read pages of "Turning inserts" See page B15

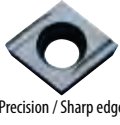

		Free-cutting steel											Carbon steel / Alloy steel											Stainless steel											Gray cast iron											Nodular cast iron											Non-ferrous metals											Heat-resistant alloy											Titanium alloy											Hard materials										
Insert	Description	Applicable chipbreaker range	Dimension (mm)				Angle (°)		Carbide						Cermet					Applicable toolholder																																																																																
			No. of edges	IC	S	D1	RE	AN	DLC			PVD			PVD			-																																																																																		
									PD1010	PD1025	PR1225	PR1535	PR1705	PR1725	PR930	PV710	PV720		PV730		TN60	TN610	TN620																																																																													
Finishing 	CCET 09T301MR-P 09T301ML-P 09T302MR-P 09T302ML-P 09T304MR-P 09T304ML-P	1	2	9.525	3.97	4.4	< 0.1 < 0.1 < 0.2 < 0.2 < 0.4 < 0.4	7							●	●																			E26~E28 E54 F60~F62 F122																																																																	
	Low feed 	CCET 0602003FR-USF 0602003FL-USF 060201FR-USF 060201FL-USF 060202FR-USF 060202FL-USF	2	2	6.35	2.38	2.8	0.03 0.03 0.1 0.1 0.2 0.2	7								●																	E26 E28 E54 F31 F32 F60~F62																																																																		
		CCET 09T3003FR-USF 09T3003FL-USF 09T301FR-USF 09T301FL-USF 09T302FR-USF 09T302FL-USF	3	2	9.525	3.97	4.4	0.03 0.03 0.1 0.1 0.2 0.2	7									●																E26~E28 E54 F60~F62 F122																																																																		
		CCET 0602005MFR-USF 0602005MFL-USF 060201MFR-USF 060201MFL-USF 060202MFR-USF 060202MFL-USF	2	2	6.35	2.38	2.8	< 0.05 < 0.05 < 0.1 < 0.1 < 0.2 < 0.2	7							●	●																		E26 E28 E54 F31 F32 F60~F62																																																																	
		CCET 09T3005MFR-USF 09T3005MFL-USF 09T301MFR-USF 09T301MFL-USF 09T302MFR-USF 09T302MFL-USF	3	2	9.525	3.97	4.4	< 0.05 < 0.05 < 0.1 < 0.1 < 0.2 < 0.2	7									●																	E26~E28 E54 F60~F62 F122																																																																	
Low feed 		CCET 0602005MFR-U 0602005MFL-U 060201MFR-U 060201MFL-U 060202MFR-U 060202MFL-U	2	2	6.35	2.38	2.8	< 0.05 < 0.05 < 0.1 < 0.1 < 0.2 < 0.2	7							●	●	●	●	●	●	●	●												E26 E28 E54 F31 F32 F60~F62																																																																	
		CCET 09T3005MFL-U 09T3005MFR-U 09T301MFL-U 09T301MFR-U 09T302MFL-U 09T302MFR-U 09T304MFL-U 09T304MFR-U	3	2	9.525	3.97	4.4	< 0.05 < 0.05 < 0.1 < 0.1 < 0.2 < 0.2 < 0.4 < 0.4	7									●	●	●	●	●	●	●											E26~E28 E54 F60~F62 F122																																																																	

Applicable chipbreaker range Insert whose corner-R(RE) dimension expressed with less than sign (e.g. <0.05, <0.1, <0.2 etc.) indicate models with minus tolerance on corner-R(RE).

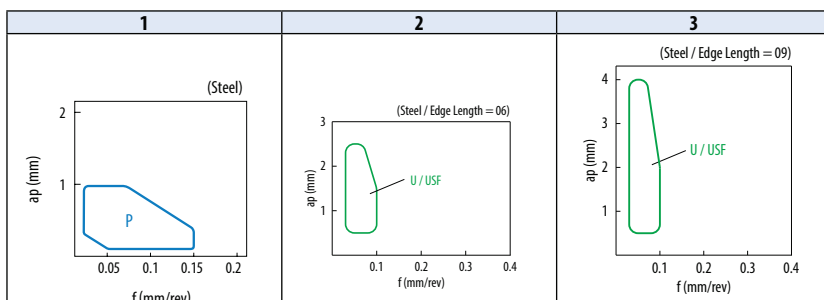

● : Standard item R : Right-hand only L : Left-hand only □ : Check availability

B
Turning indexable inserts

80° Rhombic

How to read pages of "Turning inserts" See page B15

B



Turning indexable inserts

Chip breakers

Positive

C

D

R

S

T

V

W

Ceramic

Insert	Description	Applicable chipbreaker range		Dimension (mm)					Angle (°)	Carbide				Applicable toolholder	
		No. of edges	IC	S	D1	RE	AN	Cermet							
								PR1225	PR930	KW10	TN60				
<p>Low feed</p> <p>Sharp edge</p>	CCGT 0602003FR-U	1	2	6.35	2.38	2.8	0.03	7	●	●	●	●	E26		
	0602003FL-U						0.03		●	●	●	●		E28	
	060201FR-U						0.1		●	●	●	E54			
	060201FL-U						0.1		●	●	●				F31
	060202FR-U						0.2		●	●	●				
	060202FL-U						0.2		●	●	●	F60~F62			
	CCGT 09T3003FR-U	2	2	9.525	3.97	4.4	0.03	7	●	●	●	●	E26~E28		
	09T3003FL-U						0.03		●	●	●	E54			
	09T301FR-U						0.1		●	●	●		F60~F62		
	09T301FL-U						0.1		●	●	●			F122	
	09T302FR-U						0.2		●	●	●		F122		
	09T302FL-U						0.2		●	●	●				
	CCGT 0602005MFR-U	1	2	6.35	2.38	2.8	< 0.05	7	●	●	●	●	E26		
	0602005MFL-U						< 0.05		●	●	●	E28			
	060201MFR-U						< 0.1		●	●	●		E54		
	060201MFL-U						< 0.1		●	●	●			F31	
	060202MFR-U						< 0.2		●	●	●		F32		
	060202MFL-U						< 0.2		●	●	●			F60~F62	
	060204MFR-U						< 0.4		●	●	●		F60~F62		
	060204MFL-U						< 0.4		●	●	●				
	CCGT 09T3005MFR-U	2	2	9.525	3.97	4.4	< 0.05	7	●	●	●	●	E26~E28		
	09T3005MFL-U						< 0.05		●	●	●	E54			
	09T301MFR-U						< 0.1		●	●	●		F60~F62		
	09T301MFL-U						< 0.1		●	●	●			F122	
09T302MFR-U	< 0.2						●		●	●	F122				
09T302MFL-U	< 0.2						●		●	●					
09T304MFR-U	< 0.4						●		●	●					
09T304MFL-U	< 0.4						●		●	●					

Insert whose corner-R(RE) dimension expressed with less than sign (e.g. <0.05, <0.1, <0.2 etc.) indicate models with minus tolerance on corner-R(RE).

Applicable chipbreaker range

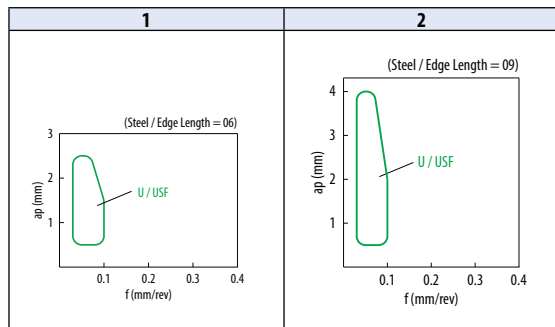

● : Standard item R : Right-hand only L : Left-hand only □ : Check availability

80° Rhombic

How to read pages of "Turning inserts" See page B15

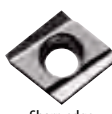
Insert		Description		Applicable chipbreaker range		Dimension (mm)				Angle (°)	Carbide						Cermet			Applicable toolholder											
						IC	S	D1	RE		AN	PVD						-													
												PR1225	PR1535	PR1725	PR930	PV710	PV720	PV730	Ti60		TiN610	TiN620									
																							E26			E28			E54		
Low feed 	CCGT	060201ER-U	060201EL-U	1	2	6.35	2.38	2.8	0.1	7	●	●	●	●	●	●	●	●	●	●	●	●	E26								
		060202ER-U	060202EL-U								●	●	●	●	●	●	●	●	●	●	●	●	●	●	●	●	●	●	●	E28	
		060204ER-U	060204EL-U								●	●	●	●	●	●	●	●	●	●	●	●	●	●	●	●	●	●	●	●	E54
		060202MER-U	060202MEL-U								●	●	●	●	●	●	●	●	●	●	●	●	●	●	●	●	●	●	●	●	F31
		060204MER-U	060204MEL-U								●	●	●	●	●	●	●	●	●	●	●	●	●	●	●	●	●	●	●	●	F32
		060204MER-U	060204MEL-U								●	●	●	●	●	●	●	●	●	●	●	●	●	●	●	●	●	●	●	●	F60~F62
	CCGT	09T301ER-U	09T301EL-U	2	2	9.525	3.97	4.4	0.1	7	●	●	●	●	●	●	●	●	●	●	●	●	●	E26~E28							
		09T302ER-U	09T302EL-U								●	●	●	●	●	●	●	●	●	●	●	●	●	●	●	●	●	●	●	E54	
		09T304ER-U	09T304EL-U								●	●	●	●	●	●	●	●	●	●	●	●	●	●	●	●	●	●	●	●	F60~F62
		09T302MER-U	09T302MEL-U								●	●	●	●	●	●	●	●	●	●	●	●	●	●	●	●	●	●	●	●	F122
		09T304MER-U	09T304MEL-U								●	●	●	●	●	●	●	●	●	●	●	●	●	●	●	●	●	●	●	●	F122
		09T304MER-U	09T304MEL-U								●	●	●	●	●	●	●	●	●	●	●	●	●	●	●	●	●	●	●	●	F122
Low feed 	CCET	0602005MFR-J	060201MFR-J	3	2	6.35	2.38	2.8	< 0.05	7	●	●	●	●	●	●	●	●	●	●	●	●	E26, E28								
		060201MFL-J	060202MFR-J								●	●	●	●	●	●	●	●	●	●	●	●	●	●	●	●	●	●	E54		
		060202MFL-J	060202MFL-J								●	●	●	●	●	●	●	●	●	●	●	●	●	●	●	●	●	●	●	●	F31, F32
		060202MFL-J	060202MFL-J								●	●	●	●	●	●	●	●	●	●	●	●	●	●	●	●	●	●	●	●	F60~F62
		060202MFL-J	060202MFL-J								●	●	●	●	●	●	●	●	●	●	●	●	●	●	●	●	●	●	●	●	F60~F62
		060202MFL-J	060202MFL-J								●	●	●	●	●	●	●	●	●	●	●	●	●	●	●	●	●	●	●	●	F60~F62
	CCET	09T301MFR-J	09T301MFL-J	3	2	9.525	3.97	4.4	< 0.1	7	●	●	●	●	●	●	●	●	●	●	●	●	●	E26~E28							
		09T302MFR-J	09T302MFL-J								●	●	●	●	●	●	●	●	●	●	●	●	●	●	●	●	●	●	●	E54	
		09T304MFR-J	09T304MFL-J								●	●	●	●	●	●	●	●	●	●	●	●	●	●	●	●	●	●	●	●	F60~F62
		09T302MFR-J	09T302MFL-J								●	●	●	●	●	●	●	●	●	●	●	●	●	●	●	●	●	●	●	●	F122
		09T304MFR-J	09T304MFL-J								●	●	●	●	●	●	●	●	●	●	●	●	●	●	●	●	●	●	●	●	F122
		09T304MFR-J	09T304MFL-J								●	●	●	●	●	●	●	●	●	●	●	●	●	●	●	●	●	●	●	●	F122

Insert whose corner-R(RE) dimension expressed with less than sign (e.g. <0.05, <0.1, <0.2 etc.) indicate models with minus tolerance on corner-R(RE).

Applicable chipbreaker range

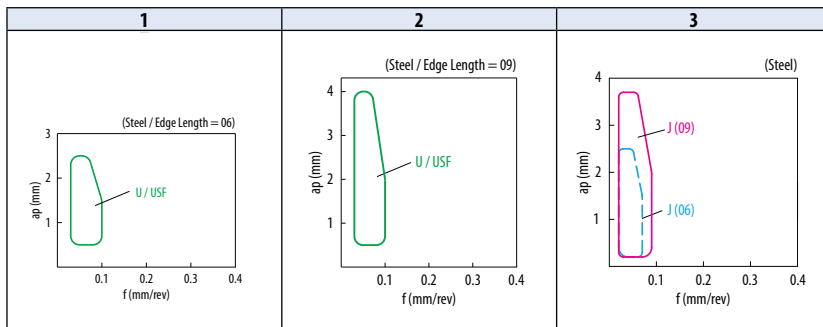

● : Standard item R : Right-hand only L : Left-hand only □ : Check availability

80° Rhombic

How to read pages of "Turning inserts" → See page B15

B



Turning indexable inserts

Chip breakers

Positive

C

D

R



S

T

V

W

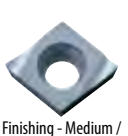
Ceramic

		Free-cutting steel		Carbon steel / Alloy steel		Stainless steel		Gray cast iron		Nodular cast iron		Non-ferrous metals		Heat-resistant alloy		Titanium alloy		Hard materials	
Insert	Description	Applicable chipbreaker range	No. of edges	Dimension (mm)					Angle (°)	Carbide		Applicable toolholder							
				IC	S	D1	RE	AN		DLC									
										P01010 P01025	KW110								
Non-Ferrous Metals  Finishing / Sharp edge	CCGT 060202AP 060204AP	1	2	6.35	2.38	3	0.2 0.4	7	●	●	●	E26, E28, E54 F31, F32 F60~F62							
	CCGT 09T302AP 09T304AP 09T308AP	1	2	9.525	3.97	4.7	0.2 0.4 0.8	7	●	●	●	E26~E28 E54							
Non-Ferrous Metals  Finishing - Medium / Sharp edge	CCGT 09T302R-A3 09T302L-A3 09T304R-A3 09T304L-A3 09T308R-A3 09T308L-A3	2	2	9.525	3.97	4.4	0.2 0.2 0.4 0.4 0.8 0.8	7	●	●	●	E26~E28 E54 F60~F62 F122							
	CCGT 120402R-A3 120402L-A3 120404R-A3 120404L-A3 120408R-A3 120408L-A3	2	2	12.7	4.76	5.5	0.2 0.2 0.4 0.4 0.8 0.8	7	●	●	●	E28							
Non-Ferrous Metals  Finishing - Medium / Sharp edge	CCGT 09T304AH 09T308AH	2	2	9.525	3.97	4.4	0.4 0.8	7	●	●	●	E26~E28 E54 F60~F62 F122							
Cast iron  Without Chipbreaker	CCGW 060201 060202	-	2	6.35	2.38	2.8	0.1 0.2	7	●	●	●	E26, E28, E54 F31, F32 F60~F62							
	CCGW 09T300 09T301 09T302 09T304	-	2	9.525	3.97	4.4	0 0.1 0.2 0.4	7	●	●	●	E26~E28 E54 F60~F62 F122							

Applicable chipbreaker range

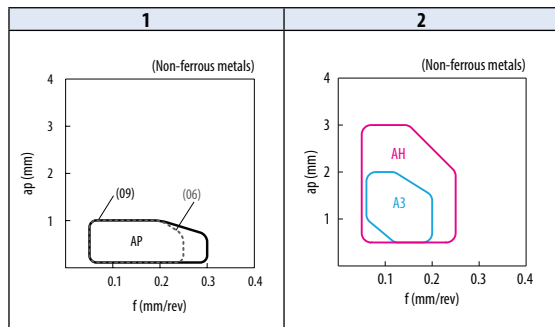

● : Standard item R : Right-hand only L : Left-hand only □ : Check availability

55° Rhombic

How to read pages of "Turning inserts" See page B15

B

Turning indexable inserts

Chip breakers

Positive

C

D

R

S

T

V

W

Ceramic

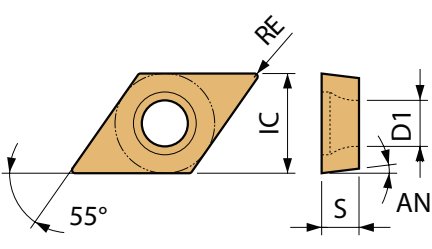

Insert	Description	Applicable chipbreaker range	Dimension (mm)					Angle (°)	Carbide						Applicable toolholder			
			No. of edges		IC	S	D1		RE	AN	DLC		PVD			Cermet		
			1	2							PO1010	PO1025	PR1225	PR1535			PR1705	PR1725
Minute ap Sharp edge	DCGT 070202CF	1	2	6.35	2.38	2.8	0.2	7										*1
	DCGT 11T302CF	1	2	9.525	3.97	4.4	0.2	7										*2
Minute ap Polished / Sharp edge	DCGT 070201MP-CF 070202MP-CF	1	2	6.35	2.38	2.8	<0.1 <0.2	7	●	●	●	●	●	●	●	●	●	*1
	DCGT 11T301MP-CF 11T302MP-CF	1	2	9.525	3.97	4.4	<0.1 <0.2	7	●	●	●	●	●	●	●	●	●	*2
Finishing Polished / Sharp edge	DCGT 070201MFP-GF 070202MFP-GF 070204MFP-GF	1	2	6.35	2.38	3	<0.1 <0.2 <0.4	7			●	●	●	●	●	●	●	*1
	DCGT 11T301MFP-GF 11T302MFP-GF 11T304MFP-GF	1	2	9.525	3.97	4.7	<0.1 <0.2 <0.4	7			●	●	●	●	●	●	●	*2
Finishing Polished / Sharp Edge	DCGT 0702005MFP-SKS 070201MFP-SKS 070202MFP-SKS	2	2	6.35	2.38	3	<0.05 <0.1 <0.2	7			●	●	●	●	●	●	●	*1
	DCGT 11T3005MFP-SKS 11T301MFP-SKS 11T302MFP-SKS 11T304MFP-SKS	2	2	9.525	3.97	4.7	<0.05 <0.1 <0.2 <0.4	7			●	●	●	●	●	●	●	*2
Finishing Polished / Sharp edge	DCGT 070201MFP-SK 070202MFP-SK 070204MFP-SK	2	2	6.35	2.38	3	<0.1 <0.2 <0.4	7	●	●	●	●	●	●	●	●	●	*1
	DCGT 11T301MFP-SK 11T302MFP-SK 11T304MFP-SK	2	2	9.525	3.97	4.7	<0.1 <0.2 <0.4	7	●	●	●	●	●	●	●	●	●	*2
Finishing	DCGT 070201CK 070202CK	2	2	6.35	2.38	2.8	0.1 0.2	7							●	●	●	*1
	DCGT 11T301CK 11T302CK	2	2	9.525	3.97	4.4	0.1 0.2	7							●	●	●	*2
Finishing	DCGT 070201MP-CK 070202MP-CK	2	2	6.35	2.38	2.8	<0.1 <0.2	7	●	●	●	●	●	●	●	●	●	*1
	DCGT 11T301MP-CK 11T302MP-CK	2	2	9.525	3.97	4.4	<0.1 <0.2	7	●	●	●	●	●	●	●	●	●	*2

Insert whose corner-R(RE) dimension expressed with less than sign (e.g. <0.05, <0.1, <0.2 etc.) indicate models with minus tolerance on corner-R(RE).

*1: DC..07type E29, E31, E34 E35, E55, E56, F66~F68, F70~F72, F74~F76

*2: DC..11type E23, E29~E32, E34, E35, E55, E56 F66~F68, F70~F72, F74~F76, F123

Applicable chipbreaker range

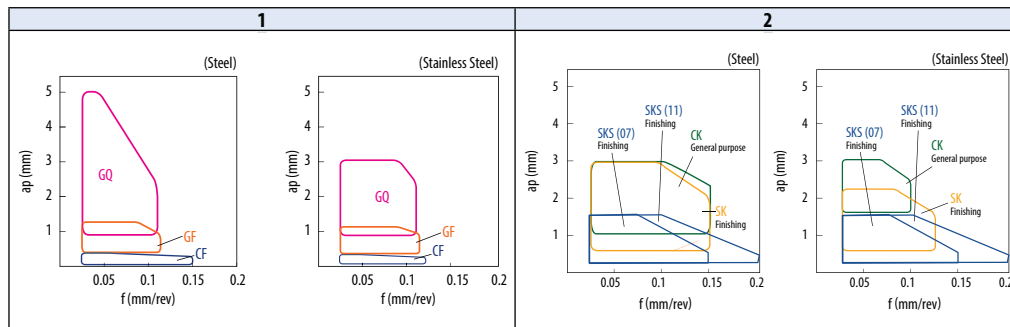

● : Standard item R : Right-hand only L : Left-hand only □ : Check availability

55° Rhombic

How to read pages of "Turning inserts" See page B15

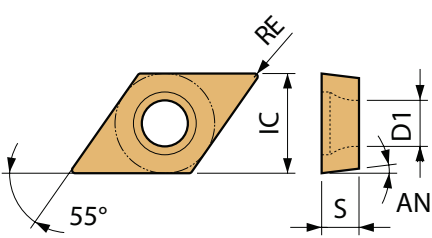

Insert	Description	Applicable chipbreaker range		Dimension (mm)				Angle (°)	Carbide								Cermet				Applicable toolholder						
		No. of edges	IC	S	D1	RE	AN		CVD				PVD				-										
									CA02SP	CA510	CA515	CA525	CA530	CA535	CA5515	CA5525	PR1225	PR1535	PR1705	PR1725		PR930	CCY	PV770	PV720	PV730	PV90
Finishing - Medium Polished / Sharp edge	DCGT 070201MFP-GQ 070202MFP-GQ 070204MFP-GQ	1	2	6.35	2.38	3	< 0.1 < 0.2 < 0.4	7																			*1
	DCGT 11T301MFP-GQ 11T302MFP-GQ 11T304MFP-GQ	1	2	9.525	3.97	4.7	< 0.1 < 0.2 < 0.4	7																			*2
Finishing With Wiper Edge	DCMX 070202WP 070204WP 070208WP	1	2	6.35	2.38	3	0.2 0.4 0.8	7																			*1
	DCMX 11T302WP 11T304WP 11T308WP	1	2	9.525	3.97	4.7	0.2 0.4 0.8	7																			*2
Finishing With Wiper Edge	DCMX 070204R-WP 070204L-WP	1	2	6.35	2.38	3	0.4	7																			*1
	DCMX 11T304R-WP 11T304L-WP	1	2	9.525	3.97	4.7	0.4	7																			*2
Finishing	DCMT 070202PP 070204PP	2	2	6.35	2.38	3	0.2 0.4	7																			*1
	DCMT 11T302PP 11T304PP 11T308PP	2	2	9.525	3.97	4.7	0.2 0.4 0.8	7																			*2
Finishing	DCMT 070202GP 070204GP	3	2	6.35	2.38	2.8	0.2 0.4	7																			*1
	DCMT 11T304GP 11T308GP	4	2	9.525	3.97	4.4	0.4 0.8	7																			*2

Insert whose corner-R(RE) dimension expressed with less than sign (e.g. <0.05, <0.1, <0.2 etc.) indicate models with minus tolerance on corner-R(RE).

See "Precautions when using Wiper inserts" in the R36 and R37 for WP chipbreaker.

*1: DC..07type E29, E31, E34 E35, E55, E56, F66~F68, F70~F72, F74~F76

*2: DC..11type E23, E29~E32, E34, E35, E55, E56 F66~F68, F70~F72, F74~F76, F123

Applicable chipbreaker range

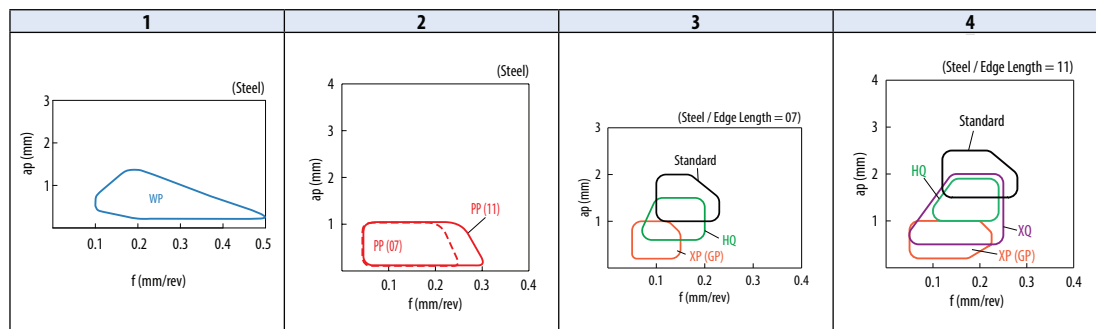

● : Standard item R : Right-hand only L : Left-hand only □ : Check availability

55° Rhombic

How to read pages of "Turning inserts" See page B15

B



Turning indexable inserts

Chip breakers

Positive



Ceramic

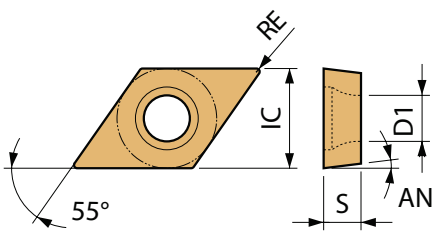

Insert	Description	Applicable chipbreaker range		Dimension (mm)				Angle (°)	Carbide				Cermet		Applicable toolholder				
		No. of edges	IC	S	D1	RE	AN		Carbide				Cermet						
								P01010	P01025	PR1225	PR1535	PR1705	PR1725	PR930		PV710	PV720	PV730	TN60
Finishing 	DCET 0702003R-FSF 0702003L-FSF 070201R-FSF 070201L-FSF 070202R-FSF 070202L-FSF 070204R-FSF 070204L-FSF	1	2	6.35	2.38	2.8	0.03	7									*1		
							0.03												
							0.1												
							0.1												
							0.2												
							0.2												
							0.4												
	DCET 11T3003R-FSF 11T301R-FSF 11T301L-FSF 11T302R-FSF 11T302L-FSF 11T304R-FSF 11T304L-FSF	2	2	9.525	3.97	4.4	0.03	7											*2
							0.1												
							0.1												
							0.2												
							0.2												
							0.4												
	DCET 0702005MR-FSF 0702005ML-FSF 070201MR-FSF 070201ML-FSF 070202MR-FSF 070202ML-FSF 070204MR-FSF	1	2	6.35	2.38	2.8	< 0.05	7											*1
							< 0.05												
							< 0.1												
							< 0.1												
							< 0.2												
< 0.2																			
< 0.4																			
DCET 11T3005MR-FSF 11T301MR-FSF 11T302MR-FSF 11T302ML-FSF 11T304MR-FSF	2	2	9.525	3.97	4.4	< 0.05	7											*2	
						< 0.1													
						< 0.2													
						< 0.2													
						< 0.2													
						< 0.4													
Finishing 	DCET 0702005MR-F 0702005ML-F 070201MR-F 070201ML-F 070202MR-F 070202ML-F 070204MR-F 070204ML-F	1	2	6.35	2.38	2.8	< 0.05	7										*1	
							< 0.05												
							< 0.1												
							< 0.1												
							< 0.2												
							< 0.2												
							< 0.4												
	DCET 11T3005MR-F 11T301MR-F 11T301ML-F 11T302MR-F 11T302ML-F 11T304MR-F 11T304ML-F	2	2	9.525	3.97	4.4	< 0.05	7											*2
							< 0.1												
							< 0.1												
							< 0.2												
							< 0.2												
							< 0.4												
							< 0.4												

Applicable chipbreaker range

Insert whose corner-R(RE) dimension expressed with less than sign (e.g. <0.05, <0.1, <0.2 etc) indicate models with minus tolerance on corner-R(RE).

*1 : DC..07type E29, E31, E34 E35, E55, E56, F66~F68, F70~F72, F74~F76

*2 : DC..11type E23, E29~E32, E34, E35, E55, E56 F66~F68, F70~F72, F74~F76, F123

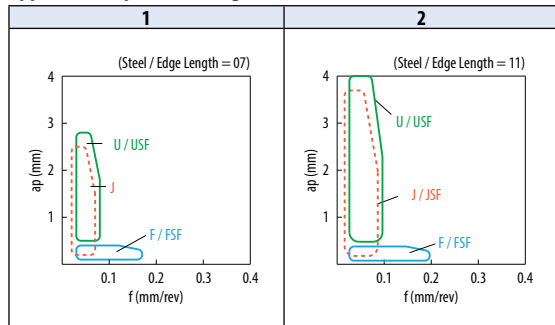

● : Standard item R : Right-hand only L : Left-hand only □ : Check availability

55° Rhombic

How to read pages of "Turning inserts" See page B15

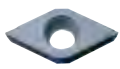
		Free-cutting steel										P			
		Carbon steel / Alloy steel										M			
		Stainless steel										K			
		Gray cast iron										N			
		Nodular cast iron										S			
		Non-ferrous metals										H			
		Heat-resistant alloy													
		Titanium alloy													
		Hard materials													
Insert	Description	Applicable chipbreaker range		Dimension (mm)				Angle (°)	Carbide				Applicable toolholder		
		No. of edges		IC	S	D1	RE		AN	PVD	-	Cermet			
Finishing 	DCGT 0702003R-F	1	2	6.35	2.38	2.8	0.03	7							
	DCGT 0702003L-F						0.03								
	DCGT 070201R-F						0.1								
	DCGT 070201L-F						0.1								
	DCGT 070202R-F						0.2								
	DCGT 070202L-F						0.2								
	DCGT 070204R-F						0.4								
	DCGT 070204L-F	0.4													
	DCGT 11T3003R-F	2	2	9.525	3.97	4.4	0.03	7							
	DCGT 11T3003L-F						0.03								
	DCGT 11T301R-F						0.1								
	DCGT 11T301L-F						0.1								
	DCGT 11T302R-F						0.2								
	DCGT 11T302L-F						0.2								
	DCGT 11T304R-F						0.4								
	DCGT 11T304L-F	0.4													
	DCGT 0702005MR-F	1	2	6.35	2.38	2.8	< 0.05	7							
	DCGT 0702005ML-F						< 0.05								
	DCGT 070201MR-F						< 0.1								
	DCGT 070201ML-F						< 0.1								
DCGT 070202MR-F	< 0.2														
DCGT 070202ML-F	< 0.2														
DCGT 070204MR-F	< 0.4														
DCGT 070204ML-F	< 0.4														
DCGT 11T3005MR-F	2	2	9.525	3.97	4.4	< 0.05	7								
DCGT 11T301MR-F						< 0.1									
DCGT 11T301ML-F						< 0.1									
DCGT 11T302MR-F						< 0.2									
DCGT 11T302ML-F						< 0.2									
DCGT 11T304MR-F						< 0.4									
DCGT 11T304ML-F						< 0.4									

Insert whose corner-R(RE) dimension expressed with less than sign (e.g. <0.05, <0.1, <0.2 etc.) indicate models with minus tolerance on corner-R(RE).

*1: DC..07type E29, E31, E34 E35, E55, E56, F66~F68, F70~F72, F74~F76

*2: DC..11type E23, E29~E32, E34, E35, E55, E56 F66~F68, F70~F72, F74~F76, F123

Applicable chipbreaker range

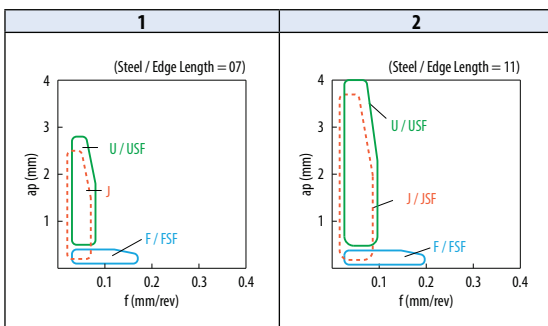

● : Standard item R : Right-hand only L : Left-hand only □ : Check availability

55° Rhombic

How to read pages of "Turning inserts" See page B15

B



Turning indexable inserts

Chip breakers

Positive

C

D

R

S

T

V

W

Ceramic

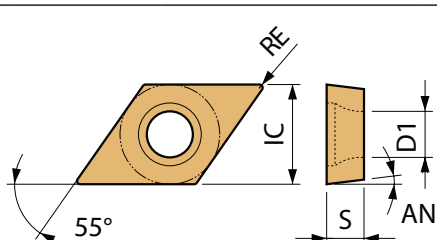

Insert	Description	Applicable chipbreaker range	Dimension (mm)					Angle (°)	Carbide						Cermet		Applicable toolholder							
			No. of edges	IC	S	D1	RE		AN	PVD			PVD	-										
										PL010	PL025	PR125			PR155	PR175		PR175	PR930	PV710	PV720	PV730	TN60	TN610
Low feed Precision / Sharp edge	DCET 0702003FR-USF	1	2	6.35	2.38	2.8	0.03	7																
	DCET 0702003FL-USF						0.03																	
	DCET 070201FR-USF						0.1																	
	DCET 070201FL-USF						0.1																	
	DCET 070202FR-USF						0.2																	
	DCET 070202FL-USF						0.2																	
	DCET 11T3003FR-USF	2	2	9.525	3.97	4.4	0.03	7																
	DCET 11T3003FL-USF						0.03																	
	DCET 11T301FR-USF						0.1																	
	DCET 11T301FL-USF						0.1																	
	DCET 11T302FR-USF						0.2																	
	DCET 11T302FL-USF						0.2																	
	DCET 0702005MFR-USF	1	2	6.35	2.38	2.8	< 0.05	7																
	DCET 070201MFR-USF						< 0.1																	
	DCET 070202MFR-USF						< 0.2																	
	DCET 070202MFL-USF						< 0.2																	
DCET 11T3005MFR-USF	< 0.05																							
DCET 11T301MFR-USF	< 0.1																							
DCET 11T301MFL-USF	< 0.1																							
DCET 11T302MFR-USF	< 0.2																							
DCET 11T302MFL-USF	< 0.2																							
Low feed Sharp edge	DCET 0702003FR-U	1	2	6.35	2.38	2.8	0.03	7																
	DCET 0702005MFR-U						< 0.05																	
	DCET 070201MFR-U	1	2	6.35	2.38	2.8	< 0.1	7																
	DCET 070201MFL-U						< 0.1																	
	DCET 070202MFR-U						< 0.2																	
	DCET 070202MFL-U						< 0.2																	
	DCET 11T3005MFR-U						< 0.05																	
	DCET 11T301MFR-U	< 0.1																						
	DCET 11T301MFL-U	< 0.1																						
	DCET 11T302MFR-U	< 0.2																						
DCET 11T302MFL-U	< 0.2																							
DCET 11T304MFR-U	< 0.4																							

Insert whose corner-R(RE) dimension expressed with less than sign (e.g. <0.05, <0.1, <0.2 etc.) indicate models with minus tolerance on corner-R(RE).

*1: DC..07type E29, E31, E34 E35, E55, E56, F66~F68, F70~F72, F74~F76

*2: DC..11type E23, E29~E32, E34, E35, E55, E56 F66~F68, F70~F72, F74~F76, F123

Applicable chipbreaker range

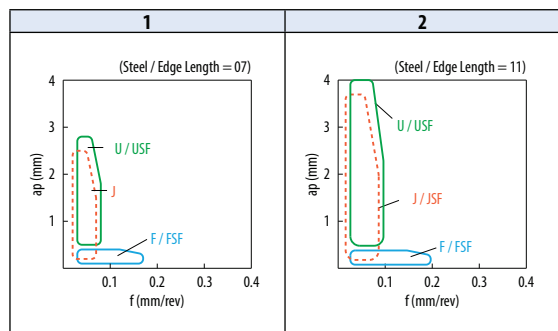

● : Standard item R : Right-hand only L : Left-hand only □ : Check availability

55° Rhombic

How to read pages of "Turning inserts" See page B15

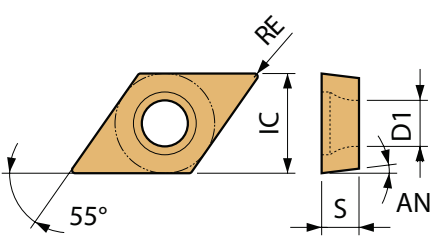

		Free-cutting steel		Carbon steel / Alloy steel		Stainless steel		Gray cast iron		Nodular cast iron		Non-ferrous metals		Heat-resistant alloy		Titanium alloy		Hard materials			
		P		M		K		N		S		H									
Insert	Description	Applicable chipbreaker range		Dimension (mm)					Angle (°)	Carbide				Cermet	Applicable toolholder						
		No. of edges	IC	S	D1	RE	AN	-													
								PR1225	PR930	KW10	PA90	TN60									
Low feed 	DCGT 0702003FR-U 0702003FL-U 070201FR-U 070201FL-U 070202FR-U 070202FL-U	1	2	6.35	2.38	2.8	0.03 0.03 0.1 0.1 0.2 0.2	7	●	●	●	●	●	●	●	●	●	●	●	●	*1
	DCGT 11T3003FR-U 11T3003FL-U 11T301FR-U 11T301FL-U 11T302FR-U 11T302FL-U	2	2	9.525	3.97	4.4	0.03 0.03 0.1 0.1 0.2 0.2	7	●	●	●	●	●	●	□	●	●	●	●	●	*2
	DCGT 0702005MFR-U 0702005MFL-U 070201MFR-U 070201MFL-U 070202MFR-U 070202MFL-U 070204MFR-U 070204MFL-U	1	2	6.35	2.38	2.8	< 0.05 < 0.05 < 0.1 < 0.1 < 0.2 < 0.2 < 0.4 < 0.4	7	●	●	●	●	●	●	●	●	●	●	●	●	*1
	DCGT 11T3005MFR-U 11T301MFR-U 11T301MFL-U 11T302MFR-U 11T302MFL-U 11T304MFR-U 11T304MFL-U	3	2	9.525	3.97	4.4	< 0.05 < 0.1 < 0.1 < 0.2 < 0.2 < 0.4 < 0.4	7	●	●	●	●	●	●	●	●	●	●	●	●	*2

Insert whose corner-R(RE) dimension expressed with less than sign (e.g. <0.05, <0.1, <0.2 etc.) indicate models with minus tolerance on corner-R(RE).

*1: DC..07type E29, E31, E34 E35, E55, E56, F66~F68, F70~F72, F74~F76

*2: DC..11type E23, E29~E32, E34, E35, E55, E56 F66~F68, F70~F72, F74~F76, F123

Applicable chipbreaker range

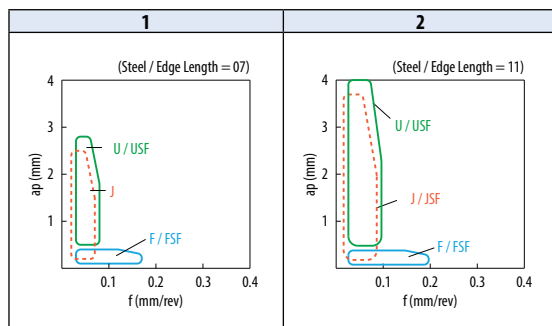

● : Standard item R : Right-hand only L : Left-hand only □ : Check availability

B



Turning indexable inserts

55° Rhombic

How to read pages of "Turning inserts" See page B15

B

Turning indexable inserts

Chip breakers

Positive

C

D

R

S

T

V

W

Ceramic

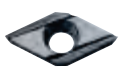
		Material										Applicable			
		Free-cutting steel												P	
		Carbon steel / Alloy steel												M	
		Stainless steel												K	
		Gray cast iron												N	
		Nodular cast iron												S	
		Non-ferrous metals												H	
		Heat-resistant alloy													
		Titanium alloy													
		Hard materials													
Insert	Description	Applicable chipbreaker range	Dimension (mm)				Angle (°)	Carbide		Cermet		Applicable toolholder			
			IC	S	D1	RE		AN	PVD	PVD	-				
									PR1225 PR1725	PV710 PV720 PV730	TN60 TN610 TN620				
Low feed  With honing	DCGT 070201ER-U 070201EL-U 070202ER-U 070202EL-U 070204ER-U 070204EL-U	1	2	6.35	2.38	2.8	0.1 0.1 0.2 0.2 0.4 0.4	7						*1	
	DCGT 11T301ER-U 11T301EL-U 11T302ER-U 11T302EL-U 11T304ER-U 11T304EL-U	2	2	9.525	3.97	4.4	0.1 0.1 0.2 0.2 0.4 0.4	7						*2	
	DCGT 070201MER-U 070202MER-U 070202MEL-U 070204MER-U 070204MEL-U	1	2	6.35	2.38	2.8	< 0.1 < 0.2 < 0.2 < 0.4 < 0.4	7						*1	
	DCGT 11T301MER-U 11T301MEL-U 11T302MER-U 11T302MEL-U 11T304MER-U 11T304MEL-U	2	2	9.525	3.97	4.4	< 0.1 < 0.1 < 0.2 < 0.2 < 0.4 < 0.4	7							
	Low feed  Precision / Sharp edge	DCET 11T3003FR-JSF 11T3003FL-JSF 11T301FR-JSF 11T301FL-JSF 11T302FR-JSF 11T302FL-JSF	2	2	9.525	3.97	4.4	0.03 0.03 0.1 0.1 0.2 0.2	7						*2
		DCET 11T3005MFR-JSF 11T301MFR-JSF 11T302MFR-JSF 11T302MFL-JSF	2	2	9.525	3.97	4.4	< 0.05 < 0.1 < 0.2 < 0.2	7						

Insert whose corner-R(RE) dimension expressed with less than sign (e.g. <0.05, <0.1, <0.2 etc.) indicate models with minus tolerance on corner-R(RE).

*1: DC..07type E29, E31, E34 E35, E55, E56, F66~F68, F70~F72, F74~F76

*2: DC..11type E23, E29~E32, E34, E35, E55, E56 F66~F68, F70~F72, F74~F76, F123

Applicable chipbreaker range

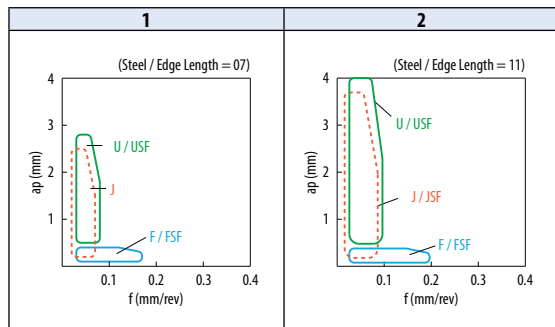

● : Standard item R : Right-hand only L : Left-hand only □ : Check availability

55° Rhombic

How to read pages of "Turning inserts" See page B15

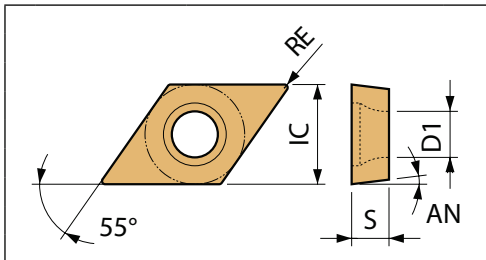

Free-cutting steel	●	●	●	●	●	●	●	●	●	●	●	●	●	●	●	●	●	●	●
Carbon steel / Alloy steel	●	●	●	●	●	●	●	●	●	●	●	●	●	●	●	●	●	●	●
Stainless steel	●	●	●	●	●	●	●	●	●	●	●	●	●	●	●	●	●	●	●
Gray cast iron								●	●	●	●	●	●	●	●	●	●	●	●
Nodular cast iron								●	●	●	●	●	●	●	●	●	●	●	●
Non-ferrous metals																			
Heat-resistant alloy																			
Titanium alloy																			
Hard materials																			

Insert	Description	Applicable chipbreaker range		Dimension (mm)				Angle (°)	Carbide					Cermet				Applicable toolholder							
				IC	S	D1	RE		AN	PVD	-	CVD	PVD	-	PVD	-									
																	PR1225		PR1535	PR1705	PR1725	PR1930	KW10	SW05	CC
Low feed Sharp edge	DCET 0702005MFR-J 070201MFR-J 070201MFL-J 070202MFR-J 070202MFL-J	1	2	6.35	2.38	2.8	< 0.05	7	●	●	●	●													
	< 0.1						●		●	●	●	●	●	●	●										
Low feed Sharp edge	DCET 11T3005MFR-J 11T301MFR-J 11T301MFL-J 11T302MFR-J 11T302MFL-J 11T304MFR-J 11T304MFL-J	2	2	9.525	3.97	4.4	< 0.05	7	●	●	●	●	●												
	< 0.1						●		●	●	●	●	●	●	●	●	●	●	●	●	●	●			
Low feed Sharp edge	DCGT 11T301FR-J 11T301FL-J 11T302FR-J 11T302FL-J	2	2	9.525	3.97	4.4	0.1	7		●	●	●	●							●					
	0.1								●	●	●	●	●	●	●	●	●	●	●	●	●	●	●	●	
Low feed With honing	DCGT 11T3003ER-J 11T301ER-J 11T301EL-J 11T302ER-J 11T302EL-J 11T304ER-J 11T304EL-J	2	2	9.525	3.97	4.4	0.03	7							●	●	●	●	●	●					
	0.1											●	●	●	●	●	●	●	●	●	●	●	●	●	
Low feed With honing	DCGT 11T3005MER-J 11T301MER-J 11T302MER-J 11T304MER-J 11T304MEL-J	2	2	9.525	3.97	4.4	< 0.05	7		●	●	●	●												
	< 0.1						●		●	●	●	●	●	●	●	●	●	●	●	●	●	●	●	●	

Insert whose corner-R(RE) dimension expressed with less than sign (e.g. <0.05, <0.1, <0.2 etc.) indicate models with minus tolerance on corner-R(RE).

*1: DC..07type E29, E31, E34 E35, E55, E56, F66~F68, F70~F72, F74~F76

*2: DC..11type E23, E29~E32, E34, E35, E55, E56 F66~F68, F70~F72, F74~F76, F123

Applicable chipbreaker range

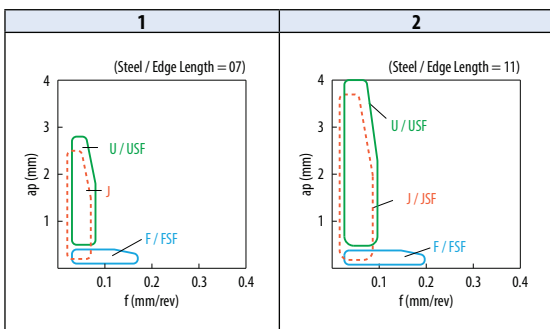

● : Standard item R : Right-hand only L : Left-hand only □ : Check availability

B



Turning indexable inserts

55° Rhombic

How to read pages of "Turning inserts" See page **B15**

B

Turning indexable inserts

Chip breakers

Positive

C

D

R

S

T

V

W

Ceramic

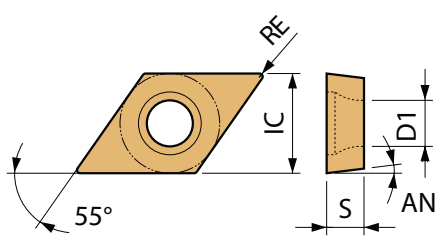

Insert	Description	Applicable chipbreaker range		Dimension (mm)					Angle (°)	Carbide			Applicable toolholder
		No. of edges	No. of edges	IC	S	D1	RE	AN		DLC	P1010 P1025	KW10	
Non-Ferrous Metals Finishing / Sharp edge	DCGT 070202AP 070204AP	1	2	6.35	2.38	2.8	0.2 0.4	7	●	●	●	*1	
	DCGT 11T302AP 11T304AP 11T308AP	1	2	9.525	3.97	4.4	0.2 0.4 0.8	7	●	●	●		
Non-Ferrous Metals Finishing - Medium / Sharp edge	DCGT 11T302R-A3 11T302L-A3 11T304R-A3 11T304L-A3 11T308R-A3 11T308L-A3	2	2	9.525	3.97	4.4	0.2 0.2 0.4 0.4 0.8 0.8	7	●	●	●	*2	
	Non-Ferrous Metals Finishing - Medium / Sharp edge	DCGT 11T304AH 11T308AH	2	2	9.525	3.97	4.4	0.4 0.8	7	●	●	●	
		Cast Iron Without Chipbreaker	DCGW 070201 070202	-	2	6.35	2.38	2.8	0.1 0.2	7	●	●	*1
	DCGW 11T301 11T302 11T304		-	2	9.525	3.97	4.4	0.1 0.2 0.4	7	●	●	●	*2

*1: DC..07type E29, E31, E34 E35, E55, E56, F66~F68, F70~F72, F74~F76

*2: DC..11type E23, E29~E32, E34, E35, E55, E56 F66~F68, F70~F72, F74~F76, F123

Applicable chipbreaker range

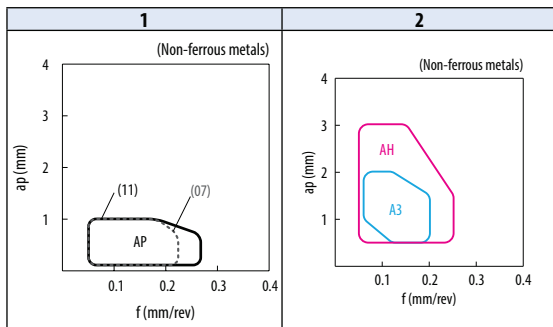

● : Standard item R : Right-hand only L : Left-hand only □ : Check availability

55° Rhombic

How to read pages of "Turning inserts" See page B15

		Applicable chipbreaker range		Dimension (mm)				Angle (°)	Car-bide	Cermet	Applicable toolholder																																																																																																		
Insert	Description	No. of edges	IC	S	D1	RE	AN	PVD	TiAlN																																																																																																				
													<table border="1"> <tr><td>Free-cutting steel</td><td></td><td></td><td></td><td></td><td></td><td></td><td></td><td></td><td></td><td>P</td></tr> <tr><td>Carbon steel / Alloy steel</td><td>●</td><td>●</td><td></td><td></td><td></td><td></td><td></td><td></td><td></td><td></td></tr> <tr><td>Stainless steel</td><td>●</td><td>●</td><td></td><td></td><td></td><td></td><td></td><td></td><td></td><td>M</td></tr> <tr><td>Gray cast iron</td><td></td><td></td><td></td><td></td><td></td><td></td><td></td><td></td><td></td><td>K</td></tr> <tr><td>Nodular cast iron</td><td></td><td></td><td></td><td></td><td></td><td></td><td></td><td></td><td></td><td>K</td></tr> <tr><td>Non-ferrous metals</td><td></td><td></td><td></td><td></td><td></td><td></td><td></td><td></td><td></td><td>N</td></tr> <tr><td>Heat-resistant alloy</td><td></td><td></td><td></td><td></td><td></td><td></td><td></td><td></td><td></td><td>S</td></tr> <tr><td>Titanium alloy</td><td></td><td></td><td></td><td></td><td></td><td></td><td></td><td></td><td></td><td>S</td></tr> <tr><td>Hard materials</td><td></td><td></td><td></td><td></td><td></td><td></td><td></td><td></td><td></td><td>H</td></tr> </table>								Free-cutting steel										P	Carbon steel / Alloy steel	●	●									Stainless steel	●	●								M	Gray cast iron										K	Nodular cast iron										K	Non-ferrous metals										N	Heat-resistant alloy										S	Titanium alloy										S	Hard materials
Free-cutting steel													P																																																																																																
Carbon steel / Alloy steel	●	●																																																																																																											
Stainless steel	●	●											M																																																																																																
Gray cast iron													K																																																																																																
Nodular cast iron													K																																																																																																
Non-ferrous metals													N																																																																																																
Heat-resistant alloy													S																																																																																																
Titanium alloy													S																																																																																																
Hard materials													H																																																																																																
Finishing Precision / Sharp edge	DPET 0702003R-FSF	1	2	6.35	2.38	2.8	0.03	11	●					E37																																																																																															
	DPET 070201R-FSF						0.1		●																																																																																																				
	DPET 070202R-FSF						0.2		●																																																																																																				
	DPET 070202L-FSF						0.2		●																																																																																																				
DPET 11T3003R-FSF DPET 11T301R-FSF DPET 11T302R-FSF DPET 11T302L-FSF	2	2	9.525	3.97	4.4	0.03	11	●	●																																																																																																				
						0.1		●																																																																																																					
						0.2		●																																																																																																					
						0.2		●																																																																																																					
DPET 070202MR-FSF DPET 070202ML-FSF	1	2	6.35	2.38	2.8	< 0.2	11	●																																																																																																					
						●																																																																																																							
DPET 11T3005MR-FSF DPET 11T301MR-FSF DPET 11T302MR-FSF	2	2	9.525	3.97	4.4	< 0.05	11	●																																																																																																					
						< 0.1		●																																																																																																					
						< 0.2		●																																																																																																					
						< 0.2		●																																																																																																					
Low feed Precision / Sharp edge	DPET 0702003FR-USF	1	2	6.35	2.38	2.8	0.03	11	●																																																																																																				
	DPET 070201FR-USF						0.1		●																																																																																																				
	DPET 070201FL-USF						0.1		●																																																																																																				
	DPET 070202FR-USF						0.2		●																																																																																																				
	DPET 070202FL-USF	0.2	●																																																																																																										
	DPET 11T3003FR-USF DPET 11T301FR-USF DPET 11T301FL-USF DPET 11T302FR-USF DPET 11T302FL-USF	2	2	9.525	3.97	4.4	0.03	11	●	●																																																																																																			
							0.1		●																																																																																																				
							0.1		●																																																																																																				
							0.2		●																																																																																																				
	DPET 0702005MFR-USF DPET 070201MFR-USF DPET 070202MFR-USF	1	2	6.35	2.38	2.8	< 0.05	11	●																																																																																																				
							< 0.1		●																																																																																																				
							< 0.2		●																																																																																																				
	DPET 11T3005MFR-USF DPET 11T301MFR-USF DPET 11T302MFR-USF	2	2	9.525	3.97	4.4	< 0.05	11	●																																																																																																				
							< 0.1		●																																																																																																				
							< 0.2		●																																																																																																				

Insert whose corner-R(RE) dimension expressed with less than sign (e.g. <0.05, <0.1, <0.2 etc.) indicate models with minus tolerance on corner-R(RE).

Applicable chipbreaker range

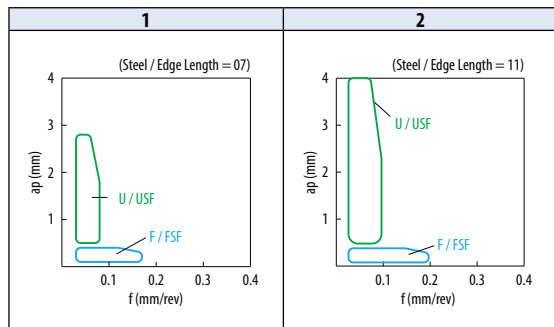

● : Standard item R : Right-hand only L : Left-hand only □ : Check availability

70° Rhombic

How to read pages of "Turning inserts" See page B15

B



Turning indexable inserts

Chip breakers

Positive

C

D

R

S

T

V

W

Ceramic

Insert	Description	Applicable chipbreaker range		Dimension (mm)					Angle (°)	Carbide				Cermet	Applicable toolholder
		No. of edges	IC	S	D1	RE	AN	PVD							
								PR1535	PR1725	PR930	RW10	TN60			
Finishing Precision / Sharp edge	JCET 030102R-FSF	1	2	3.5	1.4	1.9	0.2	7						F78 F79	
	JCET 030102L-FSF						0.2								
	JCET 030104L-FSF						0.4								
Finishing Sharp edge	JCET 030101MR-FSF	1	2	3.5	1.4	1.9	<0.1	7						F78 F79	
	JCET 030101ML-FSF						<0.1								
	JCET 030102MR-F						<0.2								
	JCET 030102ML-F						<0.2								
Finishing Sharp edge	JCGT 030101R-F	1	2	3.5	1.4	1.9	0.1	7						F78 F79	
	JCGT 030101L-F						0.1								
	JCGT 030102R-F						0.2								
	JCGT 030102L-F						0.2								
	JCGT 030104R-F						0.4								
JCGT 030104L-F	0.4														

Insert whose corner-R(RE) dimension expressed with less than sign (e.g. <0.05, <0.1, <0.2 etc.) indicate models with minus tolerance on corner-R(RE).

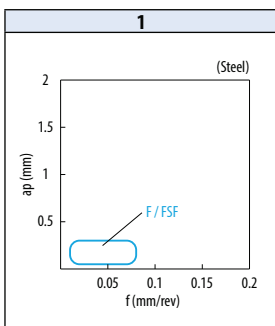

Applicable chipbreaker range



● : Standard item R : Right-hand only L : Left-hand only □ : Check availability

Round

How to read pages of "Turning inserts" See page B15

Insert		Description	Applicable chipbreaker range	Dimension (mm)				Angle (°)	Material										Applicable toolholder							
				IC	S	D1	AN		Carbide											Cermet						
									CVD											-	PVD	-				
								CA02SP	CA310	CA315	CA320	CA4515	CA510	CA515	CA525	CA530	CA5515	CA5525	CA6225	KM10	PV720	PV730	TN60	TN620		
Medium		RCMX 1003M0	1	10	3.18	3.6	7	●					●	●	●	●	●	●	●	●	●	●	●	●	●	D40
		RCMX 1204M0	1	12	4.76	4.2	7	●	●	●	●	●	●	●	●	●	●	●	●	●	●	●	●	●	●	
Non-Ferrous Metals	 Finishing - Medium	RCGX 1003M0-AQ	2	10	3.18	3.6	7													●						

Chipbreaker shape of RCMX... varies by grade (cermet / PVD coated cermet / CVD coated carbide)

Applicable chipbreaker range

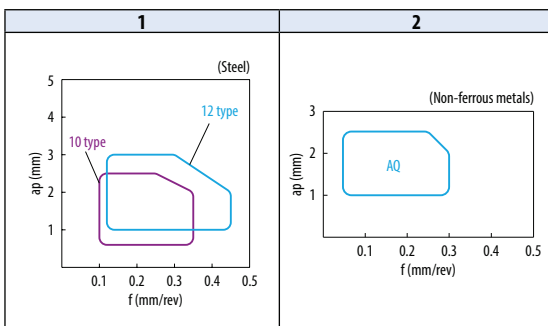

● : Standard item R : Right-hand only L : Left-hand only □ : Check availability

90° Square

How to read pages of "Turning inserts" See page B15

B



Turning indexable inserts

Chip breakers
Positive

- C
- D
- R
- S
- T
- V
- W
- Ceramic

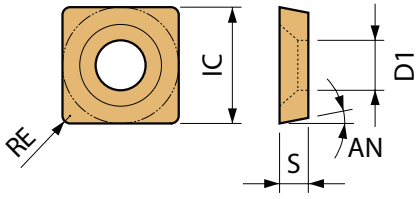

Insert	Description	Applicable chipbreaker range	No. of edges	Dimension (mm)				Angle (°)	Material							Applicable toolholder								
				IC	S	D1	RE		AN	Material														
										Carbide				Cermet										
										CVD			PVD	-										
Finishing - Medium	SCMT 09T304HQ 09T308HQ	1	4	9.525	3.97	4.4	0.4 0.8	7	CA02SP	CA510	CA515	CA525	CA530	CA5515	CA5525	CA5535	PV710	PV720	PV730	TN60	TN610	TN620	-	
Finishing	SPGH 090304L	1	4	9.525	3.18	4.6	0.4	11																F111

Applicable chipbreaker range

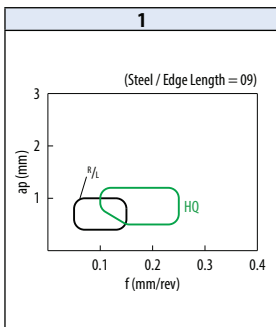

● : Standard item R : Right-hand only L : Left-hand only □ : Check availability

90° Square

How to read pages of "Turning inserts" See page B15

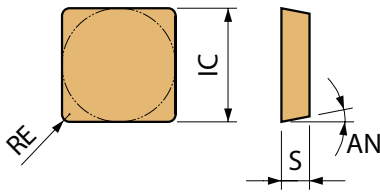

Insert	Description	Applicable chipbreaker range	Dimension (mm)				Angle (°)	Material												Applicable toolholder											
			No. of edges	IC	S	RE		Material																							
								Carbide						Cermet																	
								CVD						PVD																	
Free-cutting steel													P																		
Carbon steel / Alloy steel													●																		
Stainless steel																															
Gray cast iron													●																		
Nodular cast iron													●																		
Non-ferrous metals																															
Heat-resistant alloy																															
Titanium alloy																															
Hard materials																															
								CA02SP	CA310	CA315	CA370	CA4515	CA525	CA530	CA5505	CA5515	CA5525	CA6525	PR1535	KW10	CCY	PV7005	PV710	PV720	PV730	PV90	TN60	TN610	TN620		
Medium	SPMR 090304G 090308G	1	4	9.525	3.18	0.4 0.8	11																								
Medium	SPMR 120304G 120308G	2	4	12.7	3.18	0.4 0.8	11																								
Medium	SPMR 090304 090308	1	4	9.525	3.18	0.4 0.8	11	●																							
Medium	SPMR 120304 120308	2	4	12.7	3.18	0.4 0.8	11	●																							
Finishing	SPGR 090304R 090304L 090308R 090308L	1	4	9.525	3.18	0.4 0.4 0.8 0.8	11																								
Finishing	SPGR 120304R 120304L 120308R 120308L	2	4	12.7	3.18	0.4 0.4 0.8 0.8	11																								
Cast iron	SPGN 090304 090308	-	4	9.525	3.18	0.4 0.8	11																								
	SPGN 120304 120308	-	4	12.7	3.18	0.4 0.8	11																								
	SPMN 120304 120308 120312	-	4	12.7	3.18	0.4 0.8 1.2	11	●																							
	SPMN 120408 120412	-	4	12.7	4.76	0.8 1.2	11	●																							

Applicable chipbreaker range

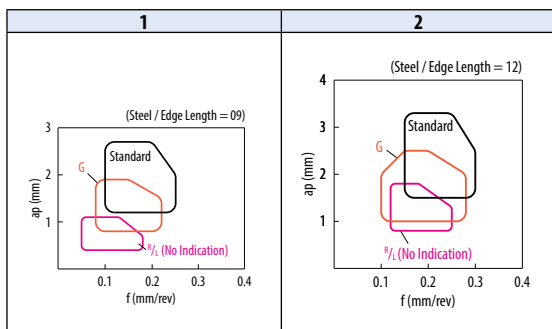

● : Standard item R : Right-hand only L : Left-hand only □ : Check availability

B



Turning indexable inserts

60° Triangle

How to read pages of "Turning inserts" See page B15

B



Turning indexable inserts

Chip breakers

Positive



R

S

T

V

W

Ceramic

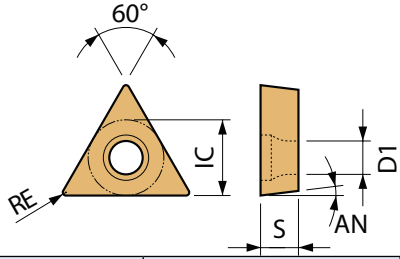

Material compatibility table for turning inserts with columns for Free-cutting steel, Carbon steel / Alloy steel, Stainless steel, Gray cast iron, Nodular cast iron, Non-ferrous metals, Heat-resistant alloy, Titanium alloy, Hard materials and rows P, M, K, N, S, H.

Main product table with columns: Insert (Image), Description, Applicable chipbreaker range, Dimension (mm) [IC, S, D1, RE, AN], Angle (°), Carbide (CA02SP to P8930), Cermet (CXX, PV710 to TN620), and Applicable toolholder (F33, F34, F80-F82, F86, F87).

Insert whose corner-R(RE) dimension expressed with less than sign (e.g. <0.05, <0.1, <0.2 etc.) indicate models with minus tolerance on corner-R(RE).

Applicable chipbreaker range

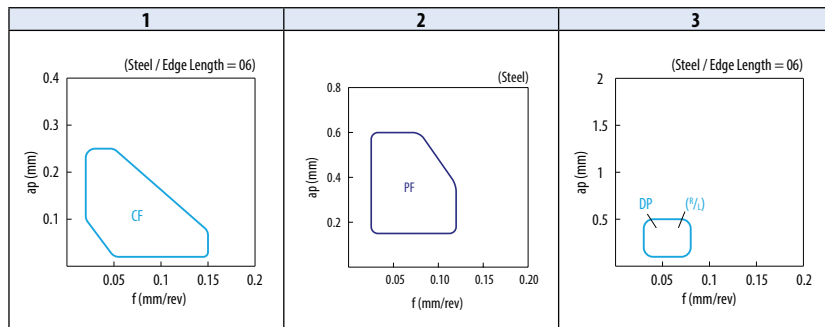

● : Standard item R : Right-hand only L : Left-hand only □ : Check availability

60° Triangle

How to read pages of "Turning inserts" See page B15

Insert	Description	Applicable chipbreaker range		Dimension (mm)				Angle (°)	Material													Applicable toolholder					
		No. of edges	IC	S	D1	RE	AN		Carbide																		
								CVD						PVD		Cermet											
				CA02SP	CA310	CA315	CA330	CA4515	CA510	CA515	CA525	CA530	CA5515	CA5525	CA5535	PR1725	PR1725	PR8930	CCX	PV710	PV770	PV730	TN60	TN610	TN620		
Finishing With Wiper Edge	TCMX 090204WP	1	3	5.56	2.38	2.5	0.4	7	●		●	●	●	●	●	●	●	●	●	●	●	●	●	●	●	●	F88 F89
	TCMX 110204WP	1	3	6.35	2.38	2.8	0.4	7	●		●	●	●	●	●	●	●	●	●	●	●	●	●	●	●	●	
Finishing - Medium	TCMT 090202HQ 090204HQ	2	3	5.56	2.38	2.5	0.2 0.4	7												●	●	●	●	●	●	●	E38
	TCMT 110202HQ 110204HQ 110208HQ	2	3	6.35	2.38	2.8	0.2 0.4 0.8	7	●	●	●	●	●	●	●	●	●	●	●	●	●	●	●	●	●	●	
	TCMT 16T304HQ 16T308HQ 16T312HQ	2	3	9.525	3.97	4.4	0.4 0.8 1.2	7	●	●	●	●	●	●	●	●	●	●	●	●	●	●	●	●	●	●	
Low feed Precision / Sharp edge	TCET 0802003FR-USF 0802003FL-USF 080201FR-USF 080202FR-USF	2	3	4.76	2.38	2.5	0.03 0.03 0.1 0.2	7												●						E38	
	TCET 1103003FR-USF 1103003FL-USF 110301FR-USF 110301FL-USF 110302FR-USF 110302FL-USF	2	3	6.35	3.18	2.8	0.03 0.03 0.1 0.1 0.2 0.2	7												●	●	●	●	●	●		●
	TCET 1103005MFR-USF 110301MFR-USF 110302MFR-USF	2	3	6.35	3.18	2.8	< 0.05 < 0.1 < 0.2	7												●	●	●	●	●	●		●

Insert whose corner-R(RE) dimension expressed with less than sign (e.g. <0.05, <0.1, <0.2 etc.) indicate models with minus tolerance on corner-R(RE). See "Precautions when using Wiper inserts" in the R36 and R37 for WP chipbreaker.

Applicable chipbreaker range

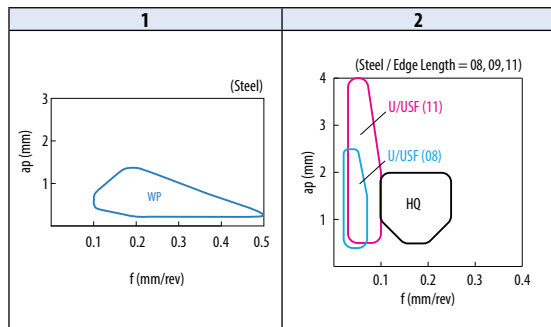

● : Standard item R : Right-hand only L : Left-hand only □ : Check availability



60° Triangle

How to read pages of "Turning inserts" See page B15

B



Turning indexable inserts

Chip breakers

Positive



Ceramic

Insert	Description	Applicable chipbreaker range		Dimension (mm)				Angle (°)	Carbide				Applicable toolholder
		No. of edges	IC	S	D1	RE	AN		Cermet				
								PR1225	PR1725	PR930	KW10	TN60	
<p>Sharp edge</p>	TCGT 080201FR-U	1	3	4.76	2.38	2.5	0.1	7	●	●	●	●	E38
	080202FR-U						0.2		●	●	●	●	
	080202FL-U						0.2		●	●	●	●	
	TCGT 1103003FR-U	1	3	6.35	3.18	2.8	0.03	7	●	●	●	●	
	110301FR-U						0.1		●	●	●	●	
	110301FL-U						0.1		●	●	●	●	
	110302FR-U						0.2		●	●	●	●	
	110302FL-U						0.2		●	●	●	●	
	TCGT 080201MFR-U	1	3	4.76	2.38	2.5	< 0.1	7	●	●	●	●	
	080202MFR-U						< 0.2		●	●	●	●	
080202MFL-U	< 0.2						●		●	●	●		
TCGT 1103005MFR-U	1	3	6.35	3.18	2.8	< 0.05	7	●	●	●	●		
1103005MFL-U						< 0.05		●	●	●	●		
110301MFR-U						< 0.1		●	●	●	●		
110301MFL-U						< 0.1		●	●	●	●		
110302MFR-U						< 0.2		●	●	●	●		
110302MFL-U						< 0.2		●	●	●	●		
110304MFR-U						< 0.4		●	●	●	●		
110304MFL-U	< 0.4	●	●	●	●								
<p>With honing</p>	TCGT 080202ER-U	1	3	4.76	2.38	2.5	0.2	7	●	●	●	●	
	080202EL-U						0.2		●	●	●	●	
	TCGT 110301ER-U	1	3	6.35	3.18	2.8	0.1	7	●	●	●	●	
	110302ER-U						0.2		●	●	●	●	
	110302EL-U						0.2		●	●	●	●	
	110304ER-U						0.4		●	●	●	●	
	TCGT 080202MER-U	1	3	4.76	2.38	2.5	< 0.2	7	●	●	●	●	
	TCGT 110302MER-U	1	3	6.35	3.18	2.8	< 0.2	7	●	●	●	●	
110302MEL-U	< 0.2						●		●	●	●		
110304MER-U	< 0.4						●		●	●	●		

Insert whose corner-R(RE) dimension expressed with less than sign (e.g. <0.05, <0.1, <0.2 etc.) indicate models with minus tolerance on corner-R(RE).

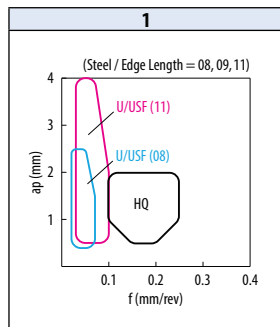

Applicable chipbreaker range



● : Standard item R : Right-hand only L : Left-hand only □ : Check availability

60° Triangle

How to read pages of "Turning inserts" See page B15

		Applicable chipbreaker range		Dimension (mm)					Angle (°)	Carbide			Applicable toolholder
Insert	Description	No. of edges	IC	S	D1	RE	AN	DLC	-		E38		
									PD1010	PD1025		KW10	
Non-Ferrous Metals  Finishing - Medium / Sharp edge	TCGT 110302R-A3	1	3	6.35	3.18	2.8	0.2	7	●	●	E38		
	110302L-A3						0.2		●	●			
	110304R-A3						0.4		●	●			
	110304L-A3						0.4		●	●			
	110308R-A3						0.8		●	●			
110308L-A3	0.8	●	●										
Cast iron  Without Chipbreaker	TCGW 080201	-	3	4.76	2.38	2.5	0.1	7	●	●	E38		
	080202						0.2		●	●			
	TCGW 110301	-	3	6.35	3.18	2.8	0.1	7	●	●	E38		
	110302						0.2		●	●			
	110304						0.4		●	●			

B

 Turning indexable inserts

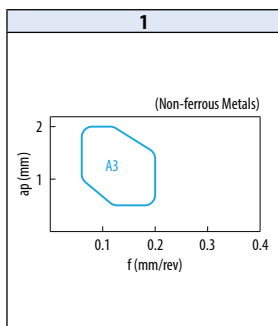
Applicable chipbreaker range



● : Standard item R : Right-hand only L : Left-hand only □ : Check availability

60° Triangle

How to read pages of "Turning inserts" See page B15

- B
- Turning indexable inserts
- Chip breakers
- Positive
- C
- D
- R
- S
- T
- V
- W
- h

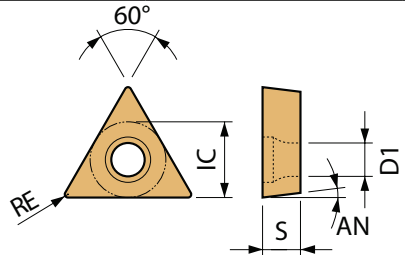

Insert	Description	Applicable chipbreaker range		Dimension (mm)				Angle (°)	Carbide							Cermet					Applicable toolholder								
		No. of edges		IC	S	D1	RE		AN	CVD			PVD				CVD	PVD											
										CA02SP	CA510	CA515	CA525	CA530	PR1225	PR1535			PR1705	PR1725		PR830	CCX		PV710	PV770	PV730	TN610	TN620
																							PV710	PV770					
Minute-ap Sharp edge	TPGT 080202CF	1	3	4.76	2.38	2.3	0.2	11																			E39 F80~F82 F86		
	TPGT 090202CF	1	3	5.56	2.38	2.8	0.2	11																			F33, F34 F80~F82 F86		
Minute-ap Polished / Sharp edge	TPGT 080201MP-CF 080202MP-CF	1	3	4.76	2.38	2.3	< 0.1 < 0.2	11																			E39 F80~F82 F86		
	TPGT 090201MP-CF 090202MP-CF	1	3	5.56	2.38	2.8	< 0.1 < 0.2	11																			E39 F80~F82 F86		
Finishing Polished / Sharp edge	TPGT 090201MFP-PF 090202MFP-PF 090204MFP-PF	2	3	5.56	2.38	2.8	< 0.1 < 0.2 < 0.4	11																			F33, F34 F80~F82 F86		
	TPMX 090202WP 090204WP 090208WP	3	3	5.56	2.38	2.8	0.2 0.4 0.8	11																			F33, F34 F80~F82 F86		
Finishing With Wiper Edge	TPMX 110302WP 110304WP 110308WP	3	3	6.35	3.18	3.3	0.2 0.4 0.8	11																			E39 F80~F82 F84, F85		
	TPMX 110304R-WP 110304L-WP	3	3	6.35	3.18	3.3	0.4	11																			F33, F34 F80~F82 F86		
Finishing	TPMT 090202PP 090204PP	4	3	5.56	2.38	2.8	0.2 0.4	11																			F33, F34 F80~F82 F86		
	TPMT 110302PP 110304PP 110308PP	5	3	6.35	3.18	3.3	0.2 0.4 0.8	11																			E39 F80~F82 F84, F85		

Insert whose corner-R(RE) dimension expressed with less than sign (e.g. <0.05, <0.1, <0.2 etc.) indicate models with minus tolerance on corner-R(RE). See "Precautions when using Wiper inserts" in the R36 and R37 for WP chipbreaker.

Applicable chipbreaker range

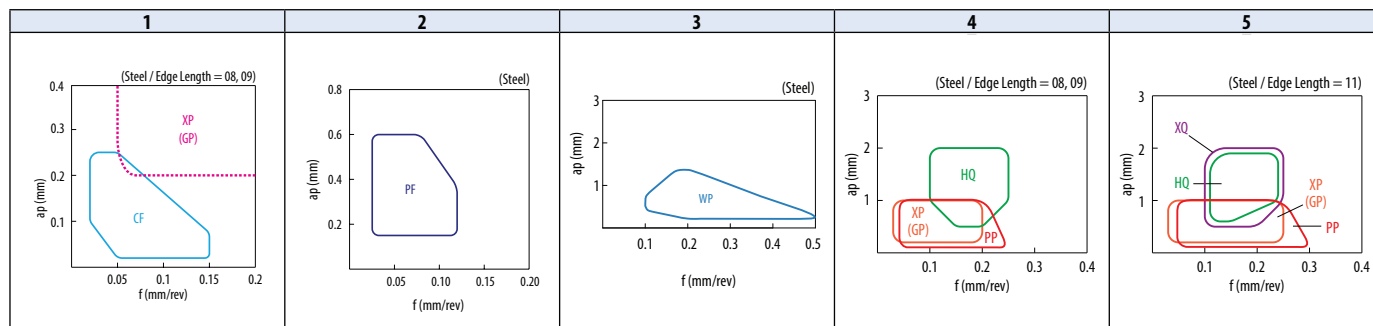

● : Standard item R : Right-hand only L : Left-hand only □ : Check availability

60° Triangle

How to read pages of "Turning inserts" → See page B15

Insert	Description	Applicable chipbreaker range		Dimension (mm)					Angle (°)	Carbide												Cermet					Applicable toolholder												
		No. of edges	IC	S	D1	RE	AN	CVD						PVD		CVD		PVD		-																			
								CA02SP		CA310	CA315	CA320	CA4505	CA4510	CA515	CA525	CA530	CA535	CA5525		CA5535	CA615	CA625	PR1535	PR1725	PR830		CCX	PV7005	PV710	PV720	PV730	PV90	TN60	TN610	TN620			
Finishing	TPMT 090202GP 090204GP	1	3	5.56	2.38	2.8	0.2 0.4	11	●																														F33, F34 F80~F82 F86
	TPMT 110304GP 110308GP	2	3	6.35	3.18	3.3	0.4 0.8	11	●																												E39 F80~F82 F84, F85		
	TPMT 160304GP	3	3	9.525	3.18	4.7	0.4	11	●																												F80~F82 F84		
Finishing - Medium	TPMT 090202HQ 090204HQ	1	3	5.56	2.38	2.8	0.2 0.4	11	●																												F33, F34 F80~F82 F86		
	TPMT 110302HQ 110304HQ 110308HQ	2	3	6.35	3.18	3.3	0.2 0.4 0.8	11	●																												E39 F80~F82 F84, F85		
	TPMT 160302HQ 160304HQ 160308HQ	3	3	9.525	3.18	4.7	0.2 0.4 0.8	11	●																												F80~F82 F84		
Low carbon steel Finishing	TPMT 090204XP	1	3	5.56	2.38	2.8	0.4	11	●																											F33, F34 F80~F82 F86			
	TPMT 110304XP 110308XP	2	3	6.35	3.18	3.3	0.4 0.8	11	●																												E39 F80~F82 F84, F85		
	TPMT 160304XP 160308XP	3	3	9.525	3.18	4.7	0.4 0.8	11	●																												F80~F82 F84		
Low carbon steel Finishing - Medium	TPMT 110304XQ 110308XQ	2	3	6.35	3.18	3.3	0.4 0.8	11	●																											E39 F80~F82 F84, F85			
	TPMT 160304XQ 160308XQ	3	3	9.525	3.18	4.7	0.4 0.8	11	●																												F80~F82 F84		

Applicable chipbreaker range

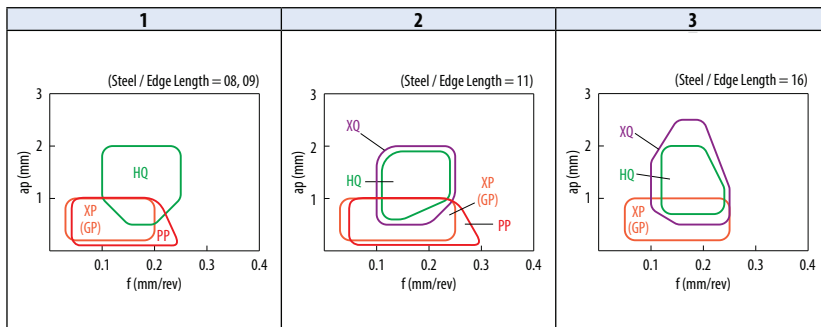

● : Standard item R : Right-hand only L : Left-hand only □ : Check availability

Turning indexable inserts

60° Triangle

How to read pages of "Turning inserts" → See page B15

B



Turning indexable inserts

Chip breakers

Positive

C

D

R

S

T

V

W

Ceramic

Insert	Description	Applicable chipbreaker range		Dimension (mm)				Angle (°)	Carbide		Cermet		Applicable toolholder							
		No. of edges	IC	S	D1	RE	AN		PVD		PVD									
									-	-	-	-								
														PR1535	PR1705	PR1725	PR930	KW10	PV7005	PV710
Finishing	TPGH 080201R 080201L 080202R 080202L 080204R 080204L	1	3	4.76	2.38	2.3	11	0.1	●	●	●	●	●	E39 F80~F82 F86						
									●	●	●	●	●		●	●	●	●	●	
									●	●	●	●	●		●	●	●	●	●	●
									●	●	●	●	●		●	●	●	●	●	●
									●	●	●	●	●		●	●	●	●	●	●
									●	●	●	●	●		●	●	●	●	●	●
	TPGH 090201R 090201L 090202R 090202L 090204R 090204L	1	3	5.56	2.38	3.2	11	0.1	●	●	●	●	●	●	F33, F34 F80~F82 F86					
									●	●	●	●	●	●		●	●	●	●	
									●	●	●	●	●	●		●	●	●	●	●
									●	●	●	●	●	●		●	●	●	●	●
									●	●	●	●	●	●		●	●	●	●	●
									●	●	●	●	●	●		●	●	●	●	●
	TPGH 110202R 110202L 110204R 110204L	2	3	6.35	2.38	3.7	11	0.2	●	●	●	●	●	●	F84 F85					
									●	●	●	●	●	●		●	●	●		
									●	●	●	●	●	●		●	●	●	●	
									●	●	●	●	●	●		●	●	●	●	
	TPGH 110302R 110302L 110304R 110304L 110308R 110308L	2	3	6.35	3.18	3.3	11	0.2	●	●	●	●	●	●	E39 F80~F82 F84, F85					
									●	●	●	●	●	●		●	●	●	●	
									●	●	●	●	●	●		●	●	●	●	●
									●	●	●	●	●	●		●	●	●	●	●
●									●	●	●	●	●	●		●	●	●	●	
●									●	●	●	●	●	●		●	●	●	●	
TPGH 160302R 160302L 160304R 160304L 160308R 160308L	2	3	9.525	3.18	4.7	11	0.2	●	●	●	●	●	●	F80~F82 F84						
								●	●	●	●	●	●		●	●	●	●		
								●	●	●	●	●	●		●	●	●	●	●	
								●	●	●	●	●	●		●	●	●	●	●	
								●	●	●	●	●	●		●	●	●	●	●	
								●	●	●	●	●	●		●	●	●	●	●	

Applicable chipbreaker range

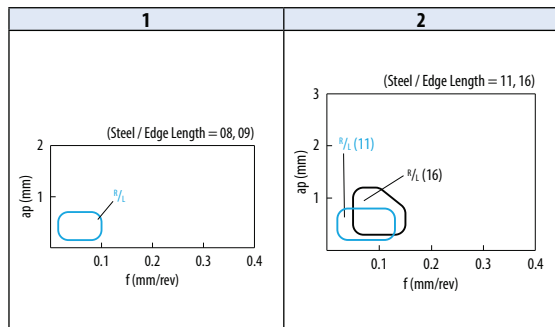

● : Standard item R : Right-hand only L : Left-hand only □ : Check availability

60° Triangle

How to read pages of "Turning inserts" See page B15

		Applicable chipbreaker range		Dimension (mm)					Angle (°)	Carbide	Applicable toolholder		
Insert	Description	No. of edges	IC	S	D1	RE	AN	PRI705 PRI725	PVD				
										Carbon steel / Alloy steel	M		
										Stainless steel	K		
										Gray cast iron	N		
										Nodular cast iron	S		
										Non-ferrous metals	H		
										Heat-resistant alloy			
										Titanium alloy			
										Hard materials			
Finishing		TPGH 080201ML	1	3	4.76	2.38	2.3	11	●	●	E39		
		080202MR										●	F80~F82
		080202ML										●	
		080204MR										●	
		080204ML										●	
	TPGH 090201ML	1	3	5.56	2.38	3.2	11	●	●	F33, F34			
	090202MR										●	F80~F82	
	090202ML										●		
	090204MR										●		
	090204ML										●		F86
TPGH 110202ML	2	3	6.35	2.38	3.7	11	●	●	F84				
110204ML										●	F85		
TPGH 110302MR	2	3	6.35	3.18	3.3	11	●	●	E39				
110302ML										●	F80~F82		
110304MR										●			
110304ML										●			
110308ML										●		F84, F85	
TPGH 160302ML	4	3	9.525	3.18	4.7	11	●	●	F80~F82				
160304MR										●			
160304ML										●			
160304ML										●			
160308ML										●	F84		

Insert whose corner-R(RE) dimension expressed with less than sign (e.g. <0.05, <0.1, <0.2 etc.) indicate models with minus tolerance on corner-R(RE).

Applicable chipbreaker range

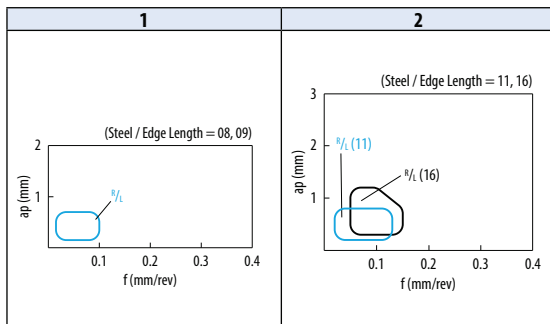

● : Standard item R : Right-hand only L : Left-hand only □ : Check availability

60° Triangle

How to read pages of "Turning inserts" See page B15

B



Turning indexable inserts

Chip breakers

Positive

C

D

R

S

T

V

W

Ceramic

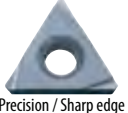
		Material										
		Free-cutting steel									P	
		Carbon steel / Alloy steel										
		Stainless steel									M	
		Gray cast iron										
		Nodular cast iron									K	
		Non-ferrous metals									N	
		Heat-resistant alloy										
		Titanium alloy									S	
		Hard materials									H	
Insert	Description	Applicable chipbreaker range		Dimension (mm)				Angle (°)	Carbide			Applicable toolholder
		No. of edges		IC	S	D1	RE		AN	PVD	Cermet	
Finishing  Precision / Sharp edge	TPET 0802003L-FSF 080201R-FSF 080201L-FSF 080202R-FSF 080202L-FSF	1	3	4.76	2.38	2.3	0.03 0.1 0.2 0.2	11				E39 F80~F82 F86
	TPET 1103003R-FSF 1103003L-FSF 1103005L-FSF 110301R-FSF 110301L-FSF 110302R-FSF 110302L-FSF	2	3	6.35	3.18	3.3	0.03 0.03 0.05 0.1 0.1 0.2 0.2	11				E39 F80~F82 F84, F85
	TPET 080202ML-FSF	1	3	4.76	2.38	2.3	<0.2	11				E39 F80~F82, F86
	TPET 1103005ML-FSF 110301MR-FSF 110301ML-FSF 110302MR-FSF 110302ML-FSF	2	3	6.35	3.18	3.3	<0.05 <0.1 <0.1 <0.2 <0.2	11				E39 F80~F82 F84, F85
	TPEH 080201MR-P 080201ML-P 080202MR-P 080202ML-P 080204MR-P 080204ML-P	3	3	4.76	2.38	2.3	<0.1 <0.1 <0.2 <0.2 <0.4 <0.4	11				E39 F80~F82 F86
	TPEH 090201MR-P 090201ML-P 090202MR-P 090202ML-P 090204MR-P 090204ML-P	3	3	5.56	2.38	3.2	<0.1 <0.1 <0.2 <0.2 <0.4 <0.4	11				F33, F34 F80~F82 F86
	TPEH 110301MR-P 110301ML-P 110302MR-P 110302ML-P 110304MR-P 110304ML-P	3	3	6.35	3.18	3.3	<0.1 <0.1 <0.2 <0.2 <0.4 <0.4	11				E39 F80~F82 F84, F85

Insert whose corner-R(RE) dimension expressed with less than sign (e.g. <0.05, <0.1, <0.2 etc.) indicate models with minus tolerance on corner-R(RE).

Applicable chipbreaker range

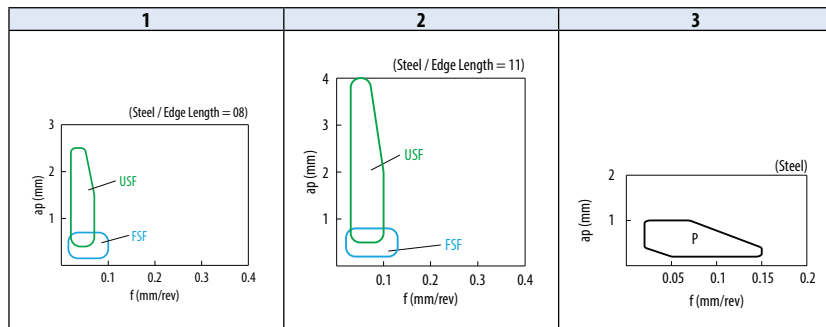

● : Standard item R : Right-hand only L : Left-hand only □ : Check availability

60° Triangle

How to read pages of "Turning inserts" See page B15

Insert	Description	Applicable chipbreaker range		Dimension (mm)				Angle (°)	Carbide		Cermet		Applicable toolholder
		No. of edges	IC	S	D1	RE	AN		PVD	-	PVD	-	
								PR1535	PR1725	PR930	KM10	PV710	
Medium	TPGH 090201L-H 090202L-H 090204L-H	1	3	5.56	2.38	3.2	0.1 0.2 0.4	11	●●				F33, F34 F80~F82 F86
	TPGH 110302R-H 110302L-H 110304R-H 110304L-H 110308R-H 110308L-H	1	3	6.35	3.18	3.3	0.2 0.2 0.4 0.4 0.8 0.8	11	●●●		●		E39 F80~F82 F84, F85
	TPGH 160304R-H 160304L-H 160308R-H 160308L-H	1	3	9.525	3.18	4.7	0.4 0.4 0.8 0.8	11	●●●		●		F80~F82 F84
	TPGT 160402L-H 160404L-H 160408L-H	1	3	9.525	4.76	4.5	0.2 0.4 0.8	11		●●●●●			-
	TPGH 110302ML-H 110304ML-H	1	3	6.35	3.18	3.3	<0.2 <0.4	11	●				E39 F80~F82 F84, F85
	TPGH 160304ML-H	1	3	9.525	3.18	4.7	<0.4	11	●				F80~F82 F84

Insert whose corner-R(RE) dimension expressed with less than sign (e.g. <0.05, <0.1, <0.2 etc.) indicate models with minus tolerance on corner-R(RE).

Applicable chipbreaker range

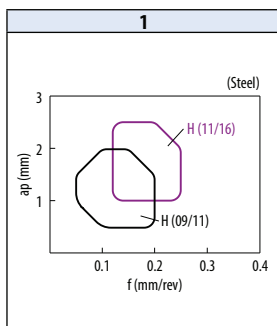

● : Standard item R : Right-hand only L : Left-hand only □ : Check availability

B
Turning indexable inserts

60° Triangle

How to read pages of "Turning inserts" See page B15

B



Turning indexable inserts

Chip breakers

Positive



Ceramic

Insert	Description	Applicable chipbreaker range		Dimension (mm)				Angle (°)	Material						Applicable toolholder		
		No. of edges	IC	S	D1	RE	AN		Carbide			Cermet					
								P01010	PR1725	PB930	KW10	PV7005	PV710	PV720		PV730	TN60
<p>TPET Precision / Sharp edge</p>	080201FL-USF	1	3	4.76	2.38	2.3	0.1	11	●	●	●	●	●	●	●	E39 F80~F82 F86	
	080202FR-USF						0.2		●	●	●	●	●	●	●		
	080202FL-USF						0.2		●	●	●	●	●	●	●		●
	110301FR-USF						0.1		●	●	●	●	●	●	●		●
<p>TPET Precision / Sharp edge</p>	110301FL-USF	2	3	6.35	3.18	3.3	0.1	11	●	●	●	●	●	●	E39 F80~F82 F84, F85		
	110302FR-USF						0.1		●	●	●	●	●	●		●	
	110302FL-USF						0.2		●	●	●	●	●	●		●	●
	110302FL-USF						0.2		●	●	●	●	●	●		●	●
<p>TPET Precision / Sharp edge</p>	080202MFR-USF	1	3	4.76	2.38	2.3	<0.2	11	●	●	●	●	●	●	E39 F80~F82 F86		
	080202MFL-USF						<0.2		●	●	●	●	●	●		●	
<p>TPET Precision / Sharp edge</p>	110301MFL-USF	2	3	6.35	3.18	3.3	<0.1	11	●	●	●	●	●	●	E39 F80~F82 F84, F85		
	110302MFR-USF						<0.2		●	●	●	●	●	●		●	
	110302MFL-USF						<0.2		●	●	●	●	●	●		●	●
	110302MFL-USF						<0.2		●	●	●	●	●	●		●	●
<p>TPGT Finishing / Sharp edge</p>	090202AP	3	3	5.56	2.38	2.8	0.2	11	●	●	●	●	●	●	F33, F34 F80~F82 F86		
	090204AP						0.4		●	●	●	●	●	●		●	
	090208AP						0.8		●	●	●	●	●	●		●	●
<p>TPGT Finishing / Sharp edge</p>	110302AP	3	3	6.35	3.18	3.3	0.2	11	●	●	●	●	●	●	E39 F80~F82 F84, F85		
	110304AP						0.4		●	●	●	●	●	●		●	
	110308AP						0.8		●	●	●	●	●	●		●	●
<p>TPGB Without Chipbreaker</p>	080202	-	3	4.76	2.38	2.3	0.2	11	●	●	●	●	●	●	E39 F80~F82 F86		
	080204						0.4		●	●	●	●	●	●		●	
	080208						0.8		●	●	●	●	●	●		●	
	090202	-	3	5.56	2.38	3.2	0.2	11	●	●	●	●	●	F33, F34 F80~F82 F86			
	090204						0.4		●	●	●	●	●		●	●	
	1102005	-	3	6.35	2.38	3.7	0.05	11	●	●	●	●	●	F84 F85			
	110201						0.1		●	●	●	●	●		●	●	
	110202						0.2		●	●	●	●	●		●	●	
	110204						0.4		●	●	●	●	●		●	●	
	1103005	-	3	6.35	3.18	3.3	0.05	11	●	●	●	●	●	E39 F80~F82 F84, F85			
110301	0.1						●		●	●	●	●	●		●		
110302	0.2						●		●	●	●	●	●		●		
110304	0.4						●		●	●	●	●	●		●		
110308	0.8						●		●	●	●	●	●		●		
160304	-	3	9.525	3.18	4.7	0.4	11	●	●	●	●	●	F80~F82 F84				
160308						0.8		●	●	●	●	●		●	●		

Insert whose corner-R(RE) dimension expressed with less than sign (e.g. <0.05, <0.1, <0.2 etc.) indicate models with minus tolerance on corner-R(RE).

Applicable chipbreaker range

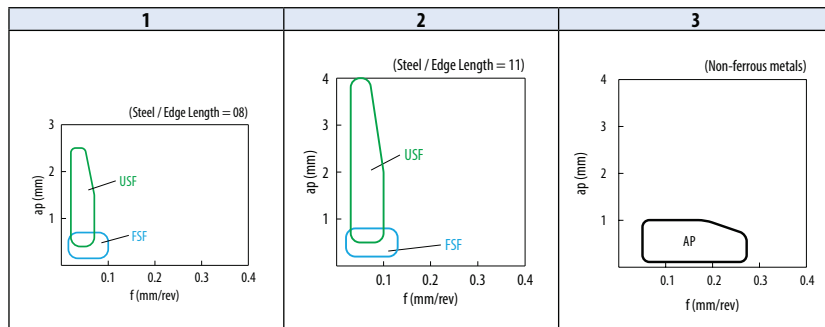

● : Standard item R : Right-hand only L : Left-hand only □ : Check availability

60° Triangle

How to read pages of "Turning inserts" See page B15

Turning indexable inserts

Chip breakers

Positive

C

D

R

S

T

V

W

Ceramic

Insert	Description	Applicable chipbreaker range		Dimension (mm)				Angle (°)	Carbide					Cermet				Applicable toolholder						
		No. of edges	IC	S	RE	AN	CVD					PVD												
							CA310		CA315	CA320	CA4505	CA4515	CA5505	RW10	PV7005	PV710			PV720		PV90	TN60	TN610	TN620
																-	-		-	-				
Finishing	TPGR 090202L-F 090204R-F 090204L-F	1	3	5.56	2.38	0.2 0.4 0.4	11																	
Finishing	TPGR 110302R-A 110302L-A 110304R-A 110304L-A	2	3	6.35	3.18	0.2 0.4 0.4	11																	
Finishing - Medium	TPGR 110304R-B 110304L-B 110308R-B 110308L-B	2	3	6.35	3.18	0.4 0.4 0.8 0.8	11																	
	TPGR 160302R-B 160302L-B 160304R-B 160304L-B 160308R-B 160308L-B					0.2 0.2 0.4 0.4 0.8 0.8																		
Medium	TPGR 160304R-C 160304L-C 160308R-C 160308L-C	3	3	9.525	3.18	0.4 0.4 0.8 0.8	11																	
Cast iron	TPGN 090202 090204	-	3	5.56	2.38	0.2 0.4	11																	
	TPGN 110302 110304 110308	-	3	6.35	3.18	0.2 0.4 0.8	11																	
	TPGN 160304 160308	-	3	9.525	3.18	0.4 0.8	11																	
	TPMN 110304 110308	-	3	6.35	3.18	0.4 0.8	11																	
	TPMN 160304 160308 160312	-	3	9.525	3.18	0.4 0.8 1.2	11																	

Applicable chipbreaker range

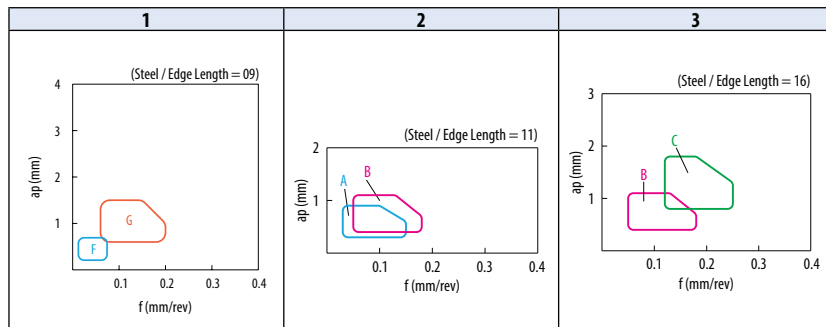

● : Standard item R : Right-hand only L : Left-hand only □ : Check availability

35° Rhombic

How to read pages of "Turning inserts" → See page B15

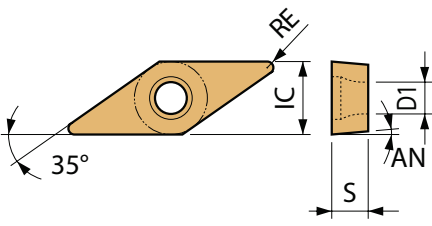

Insert	Description	Applicable chipbreaker range	Dimension (mm)				Angle (°)	Carbide											Cermet				Applicable toolholder				
			No. of edges	IC	S	D1		RE	AN	CVD					PVD			CVD			PVD	-					
										CA02SP	CA510	CA515	CA525	CA530	CA5505	CA5515	CA5525	CA5535	CA6515	CA6525	PR1225			PR1535	PR1725	PR930	CCX
Finishing	VBMT 110302PP 110304PP 110308PP	1	2	6.35	3.18	2.8	0.2 0.4 0.8	5	●●●●●	●●●●●	●●●●●	●●●●●	●●●●●	●●●●●	●●●●●	●●●●●	●●●●●	●●●●●	●●●●●	●●●●●	●●●●●	●●●●●	●●●●●	●●●●●	●●●●●	●●●●●	E40~E43 E58 F90, F91 F94~F99
	VBMT 160404PP 160408PP 160412PP	2	2	9.525	4.76	4.4	0.4 0.8 1.2	5	●●●●●	●●●●●	●●●●●	●●●●●	●●●●●	●●●●●	●●●●●	●●●●●	●●●●●	●●●●●	●●●●●	●●●●●	●●●●●	●●●●●	●●●●●	●●●●●	●●●●●	E41~E43 F90, F91 F94~F99	
Finishing	VBMT 110304GP	1	2	6.35	3.18	2.8	0.4	5	●●●●●	●●●●●	●●●●●	●●●●●	●●●●●	●●●●●	●●●●●	●●●●●	●●●●●	●●●●●	●●●●●	●●●●●	●●●●●	●●●●●	●●●●●	●●●●●	●●●●●	E40~E43 E58 F90, F91 F94~F99	
	VBMT 160404GP 160408GP	2	2	9.525	4.76	4.4	0.4 0.8	5	●●●●●	●●●●●	●●●●●	●●●●●	●●●●●	●●●●●	●●●●●	●●●●●	●●●●●	●●●●●	●●●●●	●●●●●	●●●●●	●●●●●	●●●●●	●●●●●	●●●●●	E41~E43 F90, F91 F94~F99	
Finishing	VBMT 110302VF 110304VF 110308VF	1	2	6.35	3.18	2.8	0.2 0.4 0.8	5	●●●●●	●●●●●	●●●●●	●●●●●	●●●●●	●●●●●	●●●●●	●●●●●	●●●●●	●●●●●	●●●●●	●●●●●	●●●●●	●●●●●	●●●●●	●●●●●	●●●●●	E40~E43 E58 F90, F91 F94~F99	
	VBMT 160402VF 160404VF 160408VF 160412VF	2	2	9.525	4.76	4.4	0.2 0.4 0.8 1.2	5	●●●●●	●●●●●	●●●●●	●●●●●	●●●●●	●●●●●	●●●●●	●●●●●	●●●●●	●●●●●	●●●●●	●●●●●	●●●●●	●●●●●	●●●●●	●●●●●	●●●●●	E41~E43 F90, F91 F94~F99	
Finishing - Medium	VBMT 110304HQ 110308HQ	1	2	6.35	3.18	2.8	0.4 0.8	5	●●●●●	●●●●●	●●●●●	●●●●●	●●●●●	●●●●●	●●●●●	●●●●●	●●●●●	●●●●●	●●●●●	●●●●●	●●●●●	●●●●●	●●●●●	●●●●●	●●●●●	E40~E43 E58 F90, F91 F94~F99	
	VBMT 160404HQ 160408HQ 160412HQ	2	2	9.525	4.76	4.4	0.4 0.8 1.2	5	●●●●●	●●●●●	●●●●●	●●●●●	●●●●●	●●●●●	●●●●●	●●●●●	●●●●●	●●●●●	●●●●●	●●●●●	●●●●●	●●●●●	●●●●●	●●●●●	●●●●●	E41~E43 F90, F91 F94~F99	



Turning indexable inserts

Applicable chipbreaker range

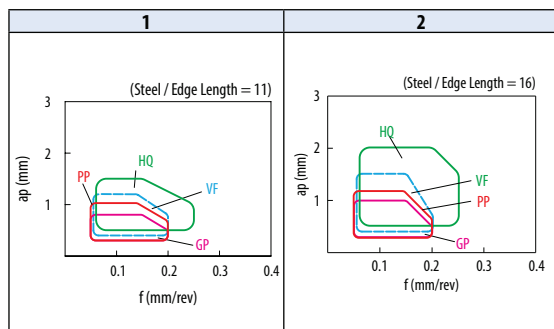

● : Standard item R : Right-hand only L : Left-hand only □ : Check availability

35° Rhombic

How to read pages of "Turning inserts" See page B15

B

Turning indexable inserts

Chip breakers

Positive

C

D

R

S

T

V

W

Ceramic

Insert		Description	Applicable chipbreaker range		Dimension (mm)				Angle (°)	Carbide				Cermet				Applicable toolholder		
					IC	S	D1	RE		AN	PVD		-		PVD		-			
											PR1225	PR1535	PR1705	PR1725	PR830	KW10	PV710		PV770	PV730
Finishing	Precision / Sharp edge	VBET 1103003R-FSF	1	2	6.35	3.18	2.8	0.03	5											
		VBET 1103003L-FSF						0.03												
		VBET 110301R-FSF						0.1												
		VBET 110301L-FSF						0.1												
		VBET 110302R-FSF						0.2												
	VBET 110302L-FSF	0.2																		
	Sharp edge	VBET 1103005MR-FSF	1	2	6.35	3.18	2.8	< 0.05	5											
		VBET 1103005ML-FSF						< 0.05												
		VBET 110301MR-FSF						< 0.1												
		VBET 110301ML-FSF						< 0.1												
VBET 110302MR-FSF		< 0.2																		
VBET 110302ML-FSF	< 0.2																			
Finishing	Sharp edge	VBET 1103005MR-F	1	2	6.35	3.18	2.8	< 0.05	5											
		VBET 1103005ML-F						< 0.05												
		VBET 110301MR-F						< 0.1												
		VBET 110301ML-F						< 0.1												
		VBET 110302MR-F						< 0.2												
	VBET 110302ML-F	< 0.2																		
	Sharp edge	VBGT 1103003R-F	1	2	6.35	3.18	2.8	0.03	5											
		VBGT 1103003L-F						0.03												
		VBGT 110301R-F						0.1												
		VBGT 110301L-F						0.1												
VBGT 110302R-F		0.2																		
VBGT 110302L-F	0.2																			
Sharp edge	VBGT 1103005MR-F	1	2	6.35	3.18	2.8	< 0.05	5												
	VBGT 1103005ML-F						< 0.05													
	VBGT 110301MR-F						< 0.1													
	VBGT 110301ML-F						< 0.1													
	VBGT 110302MR-F						< 0.2													
VBGT 110302ML-F	< 0.2																			

Insert whose corner-R(RE) dimension expressed with less than sign (e.g. <0.05, <0.1, <0.2 etc.) indicate models with minus tolerance on corner-R(RE).

Applicable chipbreaker range

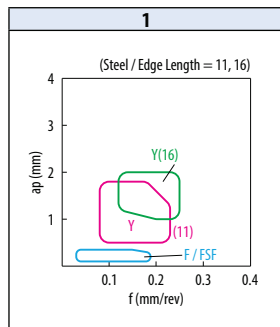

● : Standard item R : Right-hand only L : Left-hand only □ : Check availability

35° Rhombic

How to read pages of "Turning inserts" See page B15

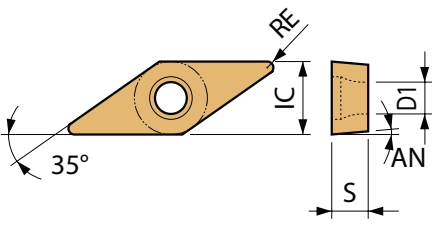

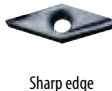
Insert	Description	Applicable chipbreaker range		Dimension (mm)				Angle (°)	Material								Applicable toolholder										
		No. of edges	No. of inserts	IC	S	D1	RE		Carbide				Cermet														
									PR1225	PR1535	PR1705	PR1725	PR830	KW10	PV710	PV770		PV730	TN60	TN610	TN620						
Finishing - Medium  Sharp edge	VBET 1103005MR-Y	1	2	6.35	3.18	2.8	< 0.05	5	●	●	●	●	●	●	●	●	●	●	●	●	E40~E43 E58 F90, F91 F94~F99						
	1103005ML-Y						< 0.05		●	●	●	●	●	●	●	●	●	●	●	●		●	●	●	●		
	110301MR-Y						< 0.1		●	●	●	●	●	●	●	●	●	●	●	●		●	●	●	●	●	
	110301ML-Y						< 0.1		●	●	●	●	●	●	●	●	●	●	●	●		●	●	●	●	●	
	110302MR-Y						< 0.2		●	●	●	●	●	●	●	●	●	●	●	●		●	●	●	●	●	●
	110302ML-Y						< 0.2		●	●	●	●	●	●	●	●	●	●	●	●		●	●	●	●	●	●
	110304MR-Y						< 0.4		●	●	●	●	●	●	●	●	●	●	●	●		●	●	●	●	●	●
110304ML-Y	< 0.4	●	●	●	●	●	●	●	●	●	●	●	●	●	●	●	●	●	●								
Finishing - Medium  Sharp edge	VBGT 1103003R-Y	1	2	6.35	3.18	2.8	0.03	5	●	●	●	●	●	●	●	●	●	●	●	E40~E43 E58 F90, F91 F94~F99							
	1103003L-Y						0.03		●	●	●	●	●	●	●	●	●	●	●		●	●	●	●			
	110301R-Y						0.1		●	●	●	●	●	●	●	●	●	●	●		●	●	●	●	●		
	110301L-Y						0.1		●	●	●	●	●	●	●	●	●	●	●		●	●	●	●	●		
	110302R-Y						0.2		●	●	●	●	●	●	●	●	●	●	●		●	●	●	●	●	●	
	110302L-Y						0.2		●	●	●	●	●	●	●	●	●	●	●		●	●	●	●	●	●	
	110304R-Y						0.4		●	●	●	●	●	●	●	●	●	●	●		●	●	●	●	●	●	
	110304L-Y						0.4		●	●	●	●	●	●	●	●	●	●	●		●	●	●	●	●	●	
	VBGT 160402R-Y	0.2	1	2	9.525	4.76	4.4	0.2	5	●	●	●	●	●	●	●	●	●	●	●	E41~E43 F90, F91 F94~F99						
	160402L-Y	0.2						●		●	●	●	●	●	●	●	●	●	●	●		●	●	●	●		
	160404R-Y	0.4						●		●	●	●	●	●	●	●	●	●	●	●		●	●	●	●	●	
	160404L-Y	0.4						●		●	●	●	●	●	●	●	●	●	●	●		●	●	●	●	●	
	160408R-Y	0.8						●		●	●	●	●	●	●	●	●	●	●	●		●	●	●	●	●	
	160408L-Y	0.8						●		●	●	●	●	●	●	●	●	●	●	●		●	●	●	●	●	
VBGT 1103005MR-Y	1103005ML-Y	1	2	6.35	3.18	2.8	< 0.05	5	●	●	●	●	●	●	●	●	●	●	●	E40~E43 E58 F90, F91 F94~F99							
	110301MR-Y						< 0.05		●	●	●	●	●	●	●	●	●	●	●		●	●	●	●			
	110301ML-Y						< 0.1		●	●	●	●	●	●	●	●	●	●	●		●	●	●	●	●		
	110302MR-Y						< 0.1		●	●	●	●	●	●	●	●	●	●	●		●	●	●	●	●		
	110302ML-Y						< 0.2		●	●	●	●	●	●	●	●	●	●	●		●	●	●	●	●	●	
	110304MR-Y						< 0.2		●	●	●	●	●	●	●	●	●	●	●		●	●	●	●	●	●	
	110304ML-Y						< 0.4		●	●	●	●	●	●	●	●	●	●	●		●	●	●	●	●	●	
	110308MR-Y						< 0.4		●	●	●	●	●	●	●	●	●	●	●		●	●	●	●	●	●	
110308ML-Y	< 0.8	●	●	●	●	●	●	●	●	●	●	●	●	●	●	●	●	●									
VBGT 160402MR-Y	160402ML-Y	1	2	9.525	4.76	4.4	< 0.2	5	●	●	●	●	●	●	●	●	●	●	●	E41~E43 F90, F91 F94~F99							
	160402L-Y						< 0.2		●	●	●	●	●	●	●	●	●	●	●		●	●	●	●			
	160404MR-Y						< 0.4		●	●	●	●	●	●	●	●	●	●	●		●	●	●	●	●		
	160404ML-Y						< 0.4		●	●	●	●	●	●	●	●	●	●	●		●	●	●	●	●		
	160408MR-Y						< 0.8		●	●	●	●	●	●	●	●	●	●	●		●	●	●	●	●	●	
	160408ML-Y						< 0.8		●	●	●	●	●	●	●	●	●	●	●		●	●	●	●	●	●	

Insert whose corner-R(RE) dimension expressed with less than sign (e.g. <0.05, <0.1, <0.2 etc.) indicate models with minus tolerance on corner-R(RE).

Applicable chipbreaker range

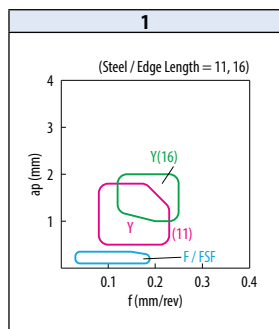

● : Standard item R : Right-hand only L : Left-hand only □ : Check availability

B





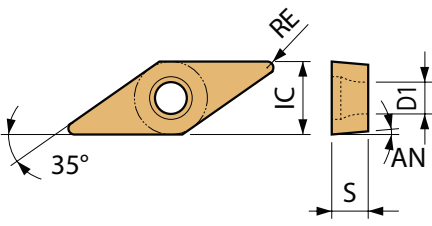

Turning indexable inserts

35° Rhombic

How to read pages of "Turning inserts" See page B15

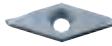

		Material										Carbide			Applicable toolholder
		Material										DLC	PVD	-	
		Material										P01010	PR1535	PR1725	
Insert	Description	Applicable chipbreaker range		Dimension (mm)				Angle (°)	Material				Applicable toolholder		
		No. of edges	No. of inserts	IC	S	D1	RE		AN	P	M	K		N	S
Finishing	 VCET 110301MR-F 110301ML-F 110302MR-F 110302ML-F 110304MR-F 110304ML-F	1	2	6.35	3.18	2.8	< 0.1	7							E44~E46 E59
							< 0.1								
							< 0.2								
							< 0.2								
							< 0.4								
Finishing - Medium Sharp edge	 VCET 1103005MR-Y 1103005ML-Y 110301MR-Y 110301ML-Y 110302MR-Y 110302ML-Y 110304MR-Y 110304ML-Y	1	2	6.35	3.18	2.8	< 0.05	7						E44~E46 E59	
							< 0.05								
							< 0.1								
							< 0.1								
							< 0.2								
Non-Ferrous Metals Finishing / Sharp edge	 VCGT 160404AP	2	2	9.525	4.76	4.4	0.4	7						E41~E43 F90, F91 F94~F99	
 VCGT 160404R-A3 160404L-A3 160408R-A3 160408L-A3	3	2	9.525	4.76	4.4	0.4	7								
						0.4									
						0.8									
Non-Ferrous Metals Finishing - Medium / Sharp edge	 VCGT 160404AH	3	2	9.525	4.76	4.4	0.4	7							

Insert whose corner-R(RE) dimension expressed with less than sign (e.g. <0.05, <0.1, <0.2 etc.) indicate models with minus tolerance on corner-R(RE).

Applicable chipbreaker range

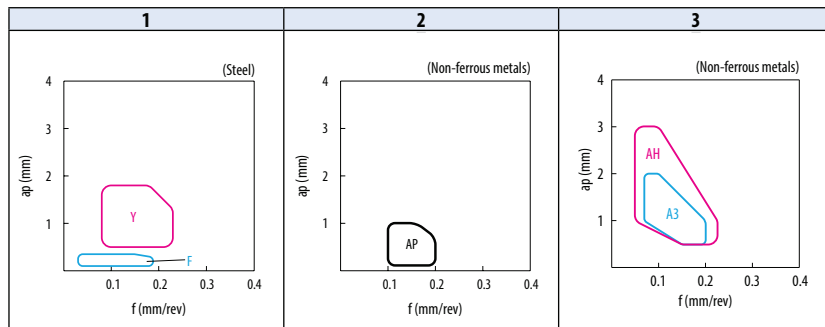

● : Standard item R : Right-hand only L : Left-hand only □ : Check availability

B



Turning indexable inserts

35° Rhombic

How to read pages of "Turning inserts" See page B15

B

Turning indexable inserts

Chip breakers

Positive

C

D

R

S

T

V

W

Ceramic

		Material										Applicable toolholder					
		Free-cutting steel	Carbon steel / Alloy steel	Stainless steel	Gray cast iron	Nodular cast iron	Non-ferrous metals	Heat-resistant alloy	Titanium alloy	Hard materials							
Insert	Description	Applicable chipbreaker range	Dimension (mm)					Angle (°)	Carbide								
			No. of edges	IC	S	D1	RE		AN	DLC		PVD					
								PO1010		PO1025	PR1225	PR1535	PR1705		PR1725	PR8930	
Minute-ap Sharp edge	VPGT 110302CF	1	2	6.35	3.18	2.8	0.2	11									
Minute-ap Polished / Sharp Edge	VPGT 110301MP-CF 110302MP-CF	1	2	6.35	3.18	2.8	< 0.1	11	●	●	●	●	●	●	●	●	E24 E47~E49
							< 0.2		●	●	●	●	●	●	●	●	
Finishing Polished / Sharp edge	VPGT 110301MFP-GF 110302MFP-GF	2	2	6.35	3.18	3	< 0.1	11			●	●	●	●	●	●	E24 E47~E49
							< 0.2		●	●	●	●	●	●	●		
Finishing Polished / Sharp Edge	VPGT 110301MFP-SKS 110302MFP-SKS 110304MFP-SKS	3	2	6.35	3.18	3	< 0.1	11			●	●	●	●	●	●	E24 E47~E49
							< 0.2		●	●	●	●	●	●	●		
							< 0.4		●	●	●	●	●	●	●		
Finishing	VPGT 080201CK 080202CK	4	2	4.76	2.38	2.3	0.1	11									● E48, E49 ● F90, F91
	VPGT 110301CK 110302CK						0.2		● E24 ● E47~E49								
Finishing	VPGT 080201MP-CK 080202MP-CK	4	2	4.76	2.38	2.3	< 0.1	11	●	●	●	●	●	●	●	●	E48, E49 F90, F91
	VPGT 110301MP-CK 110302MP-CK						< 0.2		● E24 ● E47~E49								

Insert whose corner-R(RE) dimension expressed with less than sign (e.g. <0.05, <0.1, <0.2 etc.) indicate models with minus tolerance on corner-R(RE).

Applicable chipbreaker range

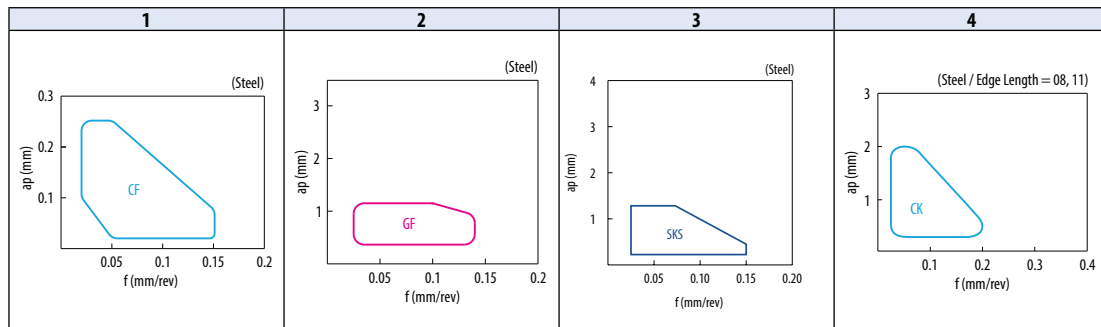



● : Standard item R : Right-hand only L : Left-hand only □ : Check availability

35° Rhombic

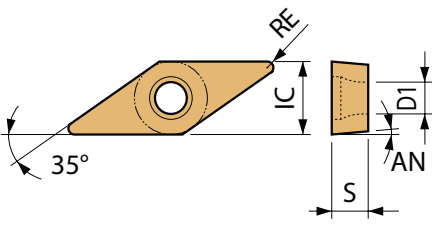
How to read pages of "Turning inserts" See page B15

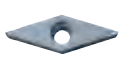

		Material													
		Free-cutting steel													P
		Carbon steel / Alloy steel	☺	☺	☺	☺	☺	☺	☺	☺	☺	☺	☺	☺	
		Stainless steel	☺	☺	☺	☺	☺	☺	☺	☺	☺	☺	☺	☺	M
		Gray cast iron													K
		Nodular cast iron													K
		Non-ferrous metals													N
		Heat-resistant alloy								☺					S
		Titanium alloy								☺					S
		Hard materials													H

Insert	Description	Applicable chipbreaker range		Dimension (mm)				Angle (°)	Carbide				Applicable toolholder	
		No. of edges	No. of edges	IC	S	D1	RE		AN	PVD				
								PR1225		PR1535	PR1725	PR930		TiN60
Finishing  Precision / Sharp edge	VPET 080201R-FSF 080201L-FSF 080202R-FSF 080202L-FSF	1	2	4.76	2.38	2.3	0.1 0.1 0.2 0.2	11		●	●	●	●	E48, E49 F90, F91
	VPET 1103003R-FSF 110301R-FSF 110301L-FSF 110302R-FSF 110302L-FSF	2	2	6.35	3.18	2.8	0.03 0.1 0.1 0.2 0.2	11		●	●	●	●	E24 E47~E49
	VPET 080201MR-FSF 080201ML-FSF 080202MR-FSF 080202ML-FSF	1	2	4.76	2.38	2.3	< 0.1 < 0.1 < 0.2 < 0.2	11	●	●	●	●	E48, E49 F90, F91	
	VPET 1103005MR-FSF 110301MR-FSF 110301ML-FSF 110302MR-FSF 110302ML-FSF	2	2	6.35	3.18	2.8	< 0.05 < 0.1 < 0.1 < 0.2 < 0.2	11	●	●	●	●	E24 E47~E49	
Finishing  Sharp edge	VPET 080201MR-F 080201ML-F 080202MR-F 080202ML-F	1	2	4.76	2.38	2.3	< 0.1 < 0.1 < 0.2 < 0.2	11	●	●	●	●	E48, E49 F90, F91	
	VPET 1103005MR-F 110301MR-F 110302MR-F 110302ML-F	2	2	6.35	3.18	2.8	< 0.05 < 0.1 < 0.2 < 0.2	11	●	●	●	●	E24 E47~E49	

Insert whose corner-R(RE) dimension expressed with less than sign (e.g. <0.05, <0.1, <0.2 etc.) indicate models with minus tolerance on corner-R(RE).

Applicable chipbreaker range

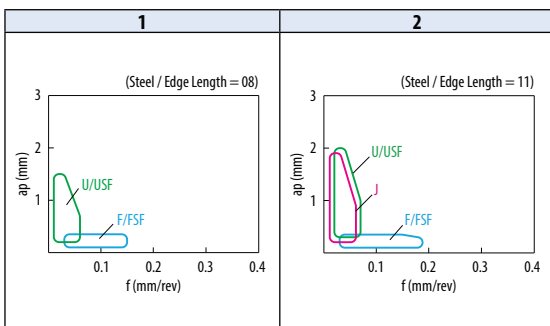

● : Standard item R : Right-hand only L : Left-hand only □ : Check availability

35° Rhombic

How to read pages of "Turning inserts" See page B15

B

Turning indexable inserts

Chip breakers

Positive

C

D

R

S

T

V

W

Ceramic

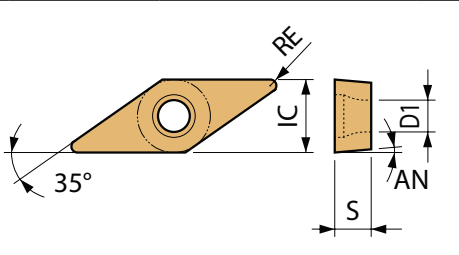

Free-cutting steel																P
Carbon steel / Alloy steel	☺	☺	☺	☺	☺	☺	☺	☺	☺	☺	☺	☺	☺	☺	☺	M
Stainless steel	☺	☺	☺	☺	☺	☺	☺	☺	☺	☺	☺	☺	☺	☺	☺	K
Gray cast iron																N
Nodular cast iron																S
Non-ferrous metals																H
Heat-resistant alloy																
Titanium alloy																
Hard materials																

Insert	Description	Applicable chipbreaker range		Dimension (mm)				Angle (°)	Carbide				Cermet	Applicable toolholder
		No. of edges	No. of inserts	IC	S	D1	RE		PVD					
									PR1225	PR1535	PR1725	PR930		
 Precision / Sharp edge	VPET 080201FR-USF 080201FL-USF 080202FR-USF 080202FL-USF	1	2	4.76	2.38	2.3	0.1 0.1 0.2 0.2	11	●	●	●	●		E48, E49 F90, F91
	VPET 1103003FR-USF 1103003FL-USF 110301FR-USF 110301FL-USF 110302FR-USF 110302FL-USF	2	2	6.35	3.18	2.8	0.03 0.03 0.1 0.1 0.2 0.2	11	●	●	●	●		E24 E47~E49
	VPET 080201MFR-USF 080202MFR-USF 080202MFL-USF	1	2	4.76	2.38	2.3	< 0.1 < 0.2 < 0.2	11	●	●	●	●		E48, E49 F90, F91
	VPET 1103005MFR-USF 110301MFR-USF 110301MFL-USF 110302MFR-USF	2	2	6.35	3.18	2.8	< 0.05 < 0.1 < 0.1 < 0.2	11	●	●	●	●		E24 E47~E49
 Sharp edge	VPET 080201MFR-U 080201MFL-U 080202MFR-U 080202MFL-U	1	2	4.76	2.38	2.3	< 0.1 < 0.1 < 0.2 < 0.2	11	●	●	●	●		E48, E49 F90, F91
	VPET 1103005MFR-U 1103005MFL-U 110301MFR-U 110301MFL-U 110302MFR-U 110302MFL-U	2	2	6.35	3.18	2.8	< 0.05 < 0.05 < 0.1 < 0.1 < 0.2 < 0.2	11	●	●	●	●		E24 E47~E49
 Sharp edge	VPET 1103005MFR-J 110301MFR-J 110301MFL-J 110302MFR-J 110302MFL-J	2	2	6.35	3.18	2.8	< 0.05 < 0.1 < 0.1 < 0.2 < 0.2	11	●	●	●	●		E24 E47~E49

Insert whose corner-R(RE) dimension expressed with less than sign (e.g. <0.05, <0.1, <0.2 etc.) indicate models with minus tolerance on corner-R(RE).

Applicable chipbreaker range

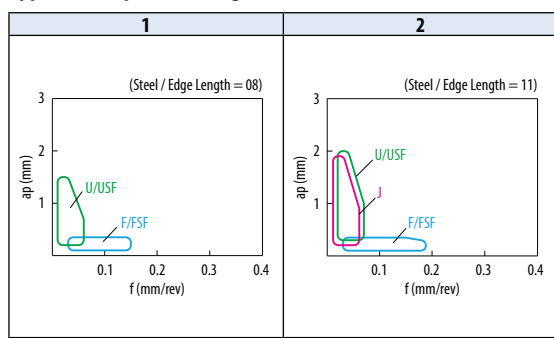

● : Standard item R : Right-hand only L : Left-hand only ☐ : Check availability

80° Trigon

How to read pages of "Turning inserts" See page B15

		Free-cutting steel										Carbon steel / Alloy steel										Stainless steel										Gray cast iron										Nodular cast iron										Non-ferrous metals										Heat-resistant alloy										Titanium alloy										Hard materials									
		P										M										K										N										S										H																																							
Insert	Description	Applicable chipbreaker range	Dimension (mm)				Angle (°)	Carbide					Cermet					Applicable toolholder																																																																									
			No. of edges	IC	S	D1		RE	AN	CVD			PVD		CVD		PVD		-																																																																								
							CA02SP			CA510	CA515	CA525	CA530	CA5515	CA5525	PR1225	PR1535		PR1705	PR1725	PR930	CCY	PV710	PV720	PV730	TN60	TN610	TN620																																																															
Minute ap Polished / Sharp edge	WBGT 060101MPR-CF 060101MPL-CF 060102MPR-CF 060102MPL-CF	1	3	3.97	1.59	2.4	< 0.1 < 0.1 < 0.2 < 0.2	5																					F36 F100~F102																																																														
Finishing Polished / Sharp edge	WBGT 060101MFPR-PF 060101MFPL-PF 060102MFPR-PF 060102MFPL-PF	2	3	3.97	1.59	2.4	< 0.1 < 0.1 < 0.2 < 0.2	5																																																																																			
Finishing	WBMT 060102R-DP 060102L-DP 060104R-DP 060104L-DP	3	3	3.97	1.59	2.3	0.2 0.2 0.4 0.4	5																																																																																			
Finishing Sharp edge	WBET 0601005ML-F 060101MR-F 060101ML-F 060102MR-F 060102ML-F 060104MR-F 060104ML-F	3	3	3.97	1.59	2.3	< 0.05 < 0.1 < 0.1 < 0.2 < 0.2 < 0.4 < 0.4	5																																																																																			
Finishing	WBET 080201MR-F 080201ML-F 080202MR-F 080202ML-F 080204MR-F 080204ML-F	3	3	4.76	2.38	2.3	< 0.1 < 0.1 < 0.2 < 0.2 < 0.4 < 0.4	5																																																																																			

Insert whose corner-R(RE) dimension expressed with less than sign (e.g. <0.05, <0.1, <0.2 etc.) indicate models with minus tolerance on corner-R(RE).

Applicable chipbreaker range

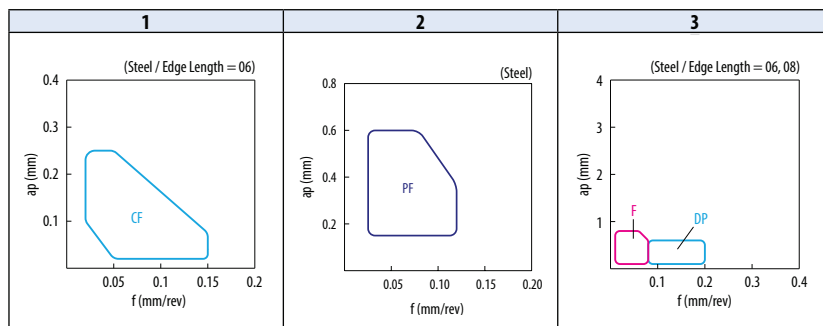

● : Standard item R : Right-hand only L : Left-hand only □ : Check availability

B



Turning indexable inserts

80° Trigon

How to read pages of "Turning inserts" → See page B15

B



Turning indexable inserts

Chip breakers

Positive

C

D

R



S

T

V

W

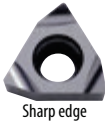
Ceramic

Insert	Description	Applicable chipbreaker range		Dimension (mm)					Angle (°)	Carbide				Applicable toolholder	
		No. of edges	No. of chipbreakers	IC	S	D1	RE	AN		Cermet					
									PR1535	PR1725	PR930	RW10	TN60		
 Sharp edge	WGBT 0601003L-F 060101R-F 060101L-F 060102R-F 060102L-F 060104R-F 060104L-F	1	3	3.97	1.59	2.3	0.03 0.1 0.1 0.2 0.2 0.4 0.4	5		●	●	●	●	F136 F100~F102	
	WGBT 080201L-F 080202R-F 080202L-F 080204R-F 080204L-F	1	3	4.76	2.38	2.3	0.1 0.2 0.2 0.4 0.4	5		●	●	●	●		
	 Sharp edge	WBET 080201MR-P 080201ML-P 080202MR-P 080202ML-P 080204MR-P 080204ML-P	2	3	4.76	2.38	2.3	< 0.1 < 0.1 < 0.2 < 0.2 < 0.4 < 0.4	5	●	●	●	●		
		 Without Chipbreaker	WBGW 060102L	-	3	3.97	1.59	2.3	0.2	5		●			
			WBGW 080202L 080204L	-	3	4.76	2.38	2.3	0.2 0.4	5		●			

Insert whose corner-R(RE) dimension expressed with less than sign (e.g. <0.05, <0.1, <0.2 etc.) indicate models with minus tolerance on corner-R(RE).

Applicable chipbreaker range

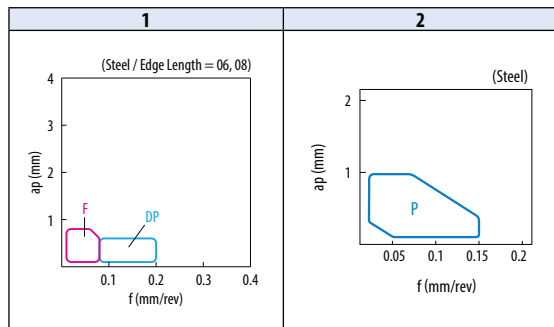

● : Standard item R : Right-hand only L : Left-hand only □ : Check availability

B106

80° Trigon

How to read pages of "Turning inserts" See page B15

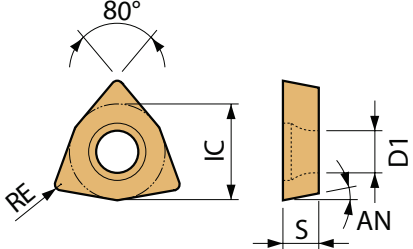

Insert	Description	Applicable chipbreaker range		Dimension (mm)				Angle (°)	Carbide										Cermet			Applicable toolholder				
		No. of edges	IC	S	D1	RE	AN		CVD					PVD		-										
									CA02SP	CA515	CA525	CA530	CA5515	CA5525	CA5535	CA6515	CA6525	PR1705	PR1725	PR930	KW10		CCX	PV710	PV720	PV730
Finishing	WPMT 110204GP	1	3	6.35	2.38	2.8	0.4	11	●	●	●															
	WPMT 160304GP	2	3	9.525	3.18	4.4	0.4	11	●	●	●	●														
Finishing - Medium	WPMT 110202HQ 110204HQ	1	3	6.35	2.38	2.8	0.2 0.4	11	●	●	●	●														
	WPMT 160304HQ 160308HQ	2	3	9.525	3.18	4.4	0.4 0.8	11	●	●	●	●	●	●	●	●	●	●	●	●	●	●	●	●	●	●
Finishing - Medium	WPGT 110202L-Y 110204R-Y 110204L-Y	1	3	6.35	2.38	2.8	0.2 0.4 0.4	11																		
	WPGT 160304R-Y 160304L-Y 160308L-Y	2	3	9.525	3.18	4.4	0.4 0.4 0.8	11																		
	WPGT 110204MR-Y 110204ML-Y	1	3	6.35	2.38	2.8	<0.4	11																		
Cast Iron	WPGW 110202 110204	-	3	6.35	2.38	2.8	0.2 0.4	11																		
	WPGW 160304 160308	-	3	9.525	3.18	4.4	0.4 0.8	11																		

Insert whose corner-R(RE) dimension expressed with less than sign (e.g. <0.05, <0.1, <0.2 etc.) indicate models with minus tolerance on corner-R(RE).

B
Turning indexable inserts

Applicable chipbreaker range

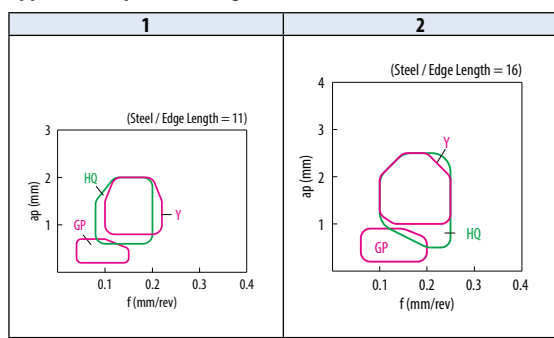

● : Standard item R : Right-hand only L : Left-hand only □ : Check availability

25° Rhombic

How to read pages of "Turning inserts" See page B15

B



Turning indexable inserts

Chip breakers

Positive

C

D

R

S

T

V

W

Ceramic

Insert		Description		No. of edges	Dimension (mm)					Angle (°)	Car-bide	Applicable toolholder
					IC	S	D1	RE	AN			
		ZBMT13T304R-GF-15D										
Finishing		ZBMT	13T302GF 13T304GF 13T308GF	2	6.35	3.97	3.7	0.2 0.4 0.8	5	●●●●	E52, E53 F106~F110	
Finishing		ZBMT	13T304R-GF-15D	2	6.35	3.97	3.7	0.4	5	●●		

● : Standard item R : Right-hand only L : Left-hand only □ : Check availability

Round / SNMF Type

How to read pages of "Turning inserts" See page B15

Insert		Description		Dimension (mm)							Angle (°)	Cermet	Applicable toolholder
				No. of edges	CDX	INSL	IC	S	D1	RE	AN		
				Free-cutting steel								P	
				Carbon steel / Alloy steel									
				Stainless steel								M	
				Gray cast iron									K
				Nodular cast iron									
				Non-ferrous metals								N	
				Heat-resistant alloy									S
				Titanium alloy									
				Hard materials									H
External / Boring / Facing		RCMT 1204M0-BB RCMT 1606M0-BB RPMT 1203M0-BB RPMT 1604M0-BB		-	-	-	12	4.76	4.2	-	7	●	D67
Round Chamfering		SNMF 120406-21 120410-21 120416-21 120421-21 120426-21		8	1.5 3 3.1 3.2 3.3	12.7	-	4.76	-	0.6 1 1.6 2.1 2.6	-	● ● ● ● ●	D68 F115

Tooling for Bearing Machining

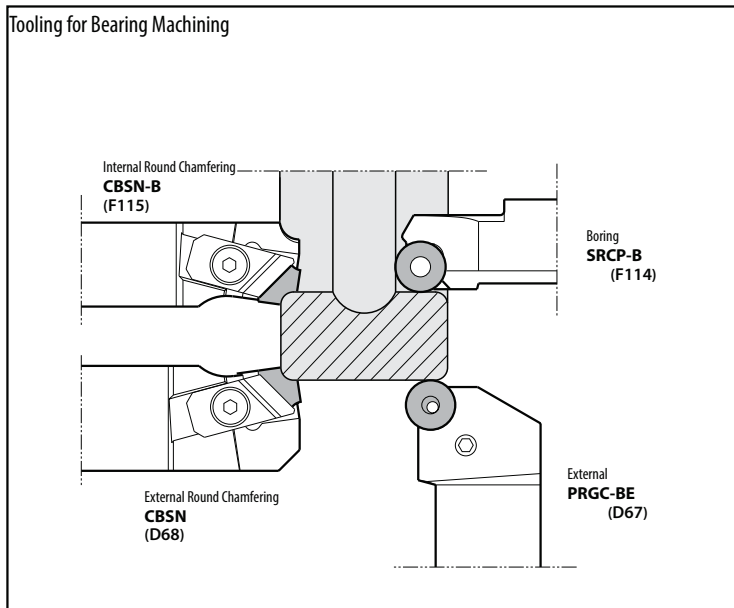

● : Standard item R : Right-hand only L : Left-hand only □ : Check availability

TKFB

How to read pages of "Turning inserts" See page B15

B

Turning indexable inserts

Chip breakers

Positive

C

D

R

S

T

V

W

Ceramic

Insert		Description	No. of edges	Dimension (mm)							Angle (°)		Carbide				Applicable toolholder																																																																																																																																													
				CW	CDX	S	D1	RE	W1	a	θ	PVD																																																																																																																																																		
												PR1225	PR1535	PR1725	KW10																																																																																																																																															
<table border="1"> <tr><td>Free-cutting steel</td><td></td><td></td><td></td><td></td><td></td><td></td><td></td><td></td><td></td><td></td><td></td><td></td><td></td><td></td><td>P</td></tr> <tr><td>Carbon steel / Alloy steel</td><td></td><td></td><td></td><td></td><td></td><td></td><td></td><td></td><td></td><td></td><td></td><td></td><td></td><td></td><td></td></tr> <tr><td>Stainless steel</td><td></td><td></td><td></td><td></td><td></td><td></td><td></td><td></td><td></td><td></td><td></td><td></td><td></td><td></td><td>M</td></tr> <tr><td>Gray cast iron</td><td></td><td></td><td></td><td></td><td></td><td></td><td></td><td></td><td></td><td></td><td></td><td></td><td></td><td></td><td>K</td></tr> <tr><td>Nodular cast iron</td><td></td><td></td><td></td><td></td><td></td><td></td><td></td><td></td><td></td><td></td><td></td><td></td><td></td><td></td><td>K</td></tr> <tr><td>Non-ferrous metals</td><td></td><td></td><td></td><td></td><td></td><td></td><td></td><td></td><td></td><td></td><td></td><td></td><td></td><td></td><td>N</td></tr> <tr><td>Heat-resistant alloy</td><td></td><td></td><td></td><td></td><td></td><td></td><td></td><td></td><td></td><td></td><td></td><td></td><td></td><td></td><td>S</td></tr> <tr><td>Titanium alloy</td><td></td><td></td><td></td><td></td><td></td><td></td><td></td><td></td><td></td><td></td><td></td><td></td><td></td><td></td><td>S</td></tr> <tr><td>Hard materials</td><td></td><td></td><td></td><td></td><td></td><td></td><td></td><td></td><td></td><td></td><td></td><td></td><td></td><td></td><td>H</td></tr> </table>															Free-cutting steel															P	Carbon steel / Alloy steel																Stainless steel															M	Gray cast iron															K	Nodular cast iron															K	Non-ferrous metals															N	Heat-resistant alloy															S	Titanium alloy															S	Hard materials															H
Free-cutting steel															P																																																																																																																																															
Carbon steel / Alloy steel																																																																																																																																																														
Stainless steel															M																																																																																																																																															
Gray cast iron															K																																																																																																																																															
Nodular cast iron															K																																																																																																																																															
Non-ferrous metals															N																																																																																																																																															
Heat-resistant alloy															S																																																																																																																																															
Titanium alloy															S																																																																																																																																															
Hard materials															H																																																																																																																																															
		TKFB 12R15005M 12R28005M 12R28010M	2	1.5 2.8 2.8	2.6 4.6 4.6	8.7 8.7 8.7	5.2 5.2 5.2	< 0.05 < 0.05 < 0.1	3 3 3	0.25 0.3 0.3	- - -	● ● ●	● ● ●	● ● ●	E15 E16																																																																																																																																															
		TKFB 16R38005M 16R38010M	2	3.8	6.3	9.5	5.2	< 0.05 < 0.1	4	0.3	-	● ●	● ●	● ●																																																																																																																																																
		TKFB 12L28005MR 12L28010MR	2	2.8	4.6	8.7	5.2	< 0.05 < 0.1	3	0.3	-	● ●	● ●	● ●																																																																																																																																																
		TKFB 16L38005MR 16L38010MR	2	3.8	6.3	9.5	5.2	< 0.05 < 0.1	4	0.3	-	● ●	● ●	● ●																																																																																																																																																
		TKFB 12R28005P-GQ 12R28015P-GQ	2	2.8	4.6	8.7	5.2	0.05 0.15	3	1.5	74	● ●	● ●	● ●																																																																																																																																																
		TKFB 16R38005P-GQ 16R38015P-GQ	2	3.8	6.3	9.5	5.2	0.05 0.15	4	1.8	72	● ●	● ●	● ●																																																																																																																																																
		TKFB 12R28005-GQ 12R28015-GQ	2	2.8	4.6	8.7	5.2	0.05 0.15	3	1.5	74	● ●	● ●	● ●																																																																																																																																																
		TKFB 16R38005-GQ 16R38015-GQ	2	3.8	6.3	9.5	5.2	0.05 0.15	4	1.8	72	● ●	● ●	● ●																																																																																																																																																

Insert whose corner-R(RE) dimension expressed with less than sign (e.g. <0.05, <0.1, <0.2 etc.) indicate models with minus tolerance on corner-R(RE).

Inserts Identification System (Ref. to Tables 1 and 2)

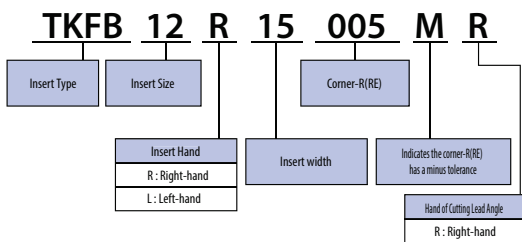

Table 1

Small machining	General purpose	Large machining
TKFB12R15.	TKFB12R28.	TKFB16R38.

Table 2

Toolholder	Right-hand	Toolholder	Left-hand
Insert	Right-hand	Insert	Left-hand
Lead angle	Right-hand	Lead angle	Right-hand

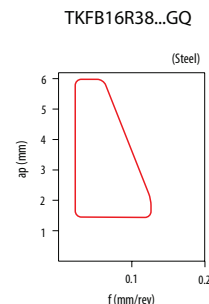
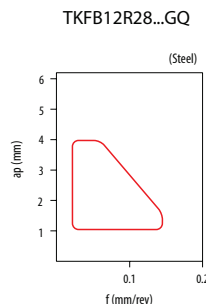
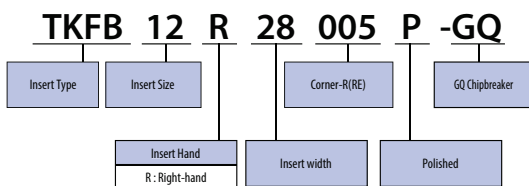

Applicable Chipbreaker Range



● : Standard item R : Right-hand only L : Left-hand only □ : Check availability

TKF-GTP

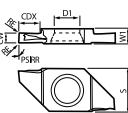
How to read pages of "Turning inserts" See page **B15**

Insert	Description	No. of edges	Dimension (mm)							Angle (°)	Carbide	Applicable toolholder
			CW	CDX	S	D1	RE	W1	PSIRR			
											PR1535 PR1725	
												P
												M
												K
												N
												S
												H
	 TKF 12R200-GTP	2	2	4.3	8.7	5.2	0.08	3	0	● ●		E15 E16
	 TKF 16R300-GTP Plunge and turn	2	3	5.8	9.5	5.2	0.08	4	0	● ●		

Applicable Chipbreaker Range

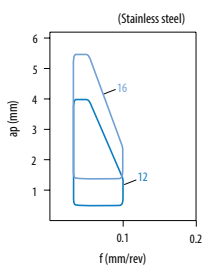
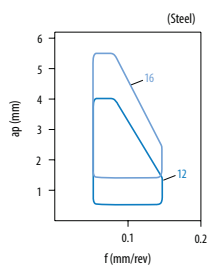

● : Standard item R : Right-hand only L : Left-hand only □ : Check availability



ABS / ABW

How to read pages of "Turning inserts" See page B15

B



Turning indexable inserts

Chip breakers

Negative

C

D

R

S

T

V

W

Ceramic

Insert		Description	No. of edges	Dimension (mm)	Carbide						Cermet	Applicable toolholder																																																																																																																				
					RE	PVD																																																																																																																										
						PR1225	PR1705	PR1725	PR930	KW10			TC60																																																																																																																			
<table border="1"> <tr> <td>Free-cutting steel</td> <td></td> <td></td> <td></td> <td></td> <td></td> <td></td> <td></td> <td></td> <td></td> <td></td> <td></td> <td>P</td> </tr> <tr> <td>Carbon steel / Alloy steel</td> <td>☺</td> <td></td> <td>☺</td> <td>☺</td> <td></td> <td></td> <td></td> <td></td> <td></td> <td></td> <td></td> <td>M</td> </tr> <tr> <td>Stainless steel</td> <td>☺</td> <td></td> <td>☺</td> <td>☺</td> <td></td> <td></td> <td></td> <td></td> <td></td> <td></td> <td></td> <td>K</td> </tr> <tr> <td>Gray cast iron</td> <td></td> <td></td> <td></td> <td></td> <td></td> <td></td> <td></td> <td></td> <td>☺</td> <td></td> <td></td> <td>N</td> </tr> <tr> <td>Nodular cast iron</td> <td></td> <td></td> <td></td> <td></td> <td></td> <td></td> <td></td> <td></td> <td>☺</td> <td></td> <td></td> <td>S</td> </tr> <tr> <td>Non-ferrous metals</td> <td></td> <td></td> <td></td> <td></td> <td></td> <td></td> <td></td> <td></td> <td>☺</td> <td></td> <td></td> <td>H</td> </tr> <tr> <td>Heat-resistant alloy</td> <td></td> <td></td> <td></td> <td></td> <td></td> <td></td> <td></td> <td></td> <td></td> <td></td> <td></td> <td></td> </tr> <tr> <td>Titanium alloy</td> <td></td> <td></td> <td></td> <td></td> <td></td> <td></td> <td></td> <td></td> <td></td> <td></td> <td></td> <td></td> </tr> <tr> <td>Hard materials</td> <td></td> <td></td> <td></td> <td></td> <td></td> <td></td> <td></td> <td></td> <td></td> <td></td> <td></td> <td></td> </tr> </table>												Free-cutting steel												P	Carbon steel / Alloy steel	☺		☺	☺								M	Stainless steel	☺		☺	☺								K	Gray cast iron									☺			N	Nodular cast iron									☺			S	Non-ferrous metals									☺			H	Heat-resistant alloy													Titanium alloy													Hard materials												
Free-cutting steel												P																																																																																																																				
Carbon steel / Alloy steel	☺		☺	☺								M																																																																																																																				
Stainless steel	☺		☺	☺								K																																																																																																																				
Gray cast iron									☺			N																																																																																																																				
Nodular cast iron									☺			S																																																																																																																				
Non-ferrous metals									☺			H																																																																																																																				
Heat-resistant alloy																																																																																																																																
Titanium alloy																																																																																																																																
Hard materials																																																																																																																																
		ABS 15R4005M 15R4015M	2	< 0.05 < 0.15	● ● ● ●	● ● ● ●						E20																																																																																																																				
		ABS 15R4005 15R4015	2	0.05 0.15			● ● ● ●	● ● ● ●				E21																																																																																																																				
		ABW 15R4005M 15R4015M	2	< 0.05 < 0.15	● ● ● ●	● ● ● ●						E22																																																																																																																				
		ABW 15R4005 15R4015	2	0.05 0.15			● ● ● ●	● ● ● ●				E22																																																																																																																				
		ABW 23R5005M 23R5015M	2	< 0.05 < 0.15	● ● ● ●	● ● ● ●						E22																																																																																																																				
		ABW 23R5005 23R5015	2	0.05 0.15			● ● ● ●	● ● ● ●				E22																																																																																																																				

Insert whose corner-R(RE) dimension expressed with less than sign (e.g. <0.05, <0.1, <0.2 etc.) indicate models with minus tolerance on corner-R(RE).

● : Standard item R : Right-hand only L : Left-hand only ☐ : Check availability

80° Rhombic

How to read pages of "Turning inserts" See page B15

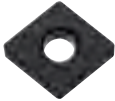
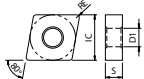
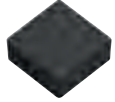
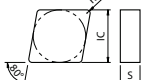
Cutting edge preparation			Material compatibility												Applicable toolholder		
Symbol	Specification	Example	Gray cast iron (with scale)	Gray cast iron (without scale)	Nodular cast iron (with scale)	Nodular cast iron (without scale)	Heat-resistant alloy	Hard materials	CVD	PVD	Ceramic						
			Edge preparation type	No. of edges	IC	S	D1	RE	C7050	A66N	PT600M	Ag5	KA30	KS6015	KS6040	KS6050	
			Dimension (mm)					Ceramic									
 	CNGA	120412S01025	S01025	4	12.7	4.76	5.16	1.2						●			D8~D10 F116 F125 F126
	CNGA	120404S01525 120408S01525 120412S01525	S01525	4	12.7	4.76	5.16	0.4 0.8 1.2	●	●	●						
	CNGA	120404S02025 120408S02025 120412S02025	S02025	4	12.7	4.76	5.16	0.4 0.8 1.2	●	●	●						
	CNGA	120404T02025 120408T02025 120412T02025	T02025	4	12.7	4.76	5.16	0.4 0.8 1.2	●	●	●	●	●	●	●	●	
	CNGA	120404S03030 120408S03030 120412S03030	S03030	4	12.7	4.76	5.16	0.4 0.8 1.2	●	●	●						
	CNMA	120408S03030 120412S03030	S03030	4	12.7	4.76	5.16	0.8 1.2	●	●							
	 	CNGN	120408T01020	T01020	4	12.7	4.76	-	0.8						●		
CNGN		120412S01025	S01025	4	12.7	4.76	-	1.2					●				
CNGN		120408T02025 120412T02025 120416T02025	T02025	4	12.7	4.76	-	0.8 1.2 1.6	●	●	●				●		
CNGN		120708S01525 120712S01525	S01525	4	12.7	7.94	-	0.8 1.2	●	●							
CNGN		120704T02025 120708T02025 120712T02025 120716T02025	T02025	4	12.7	7.94	-	0.4 0.8 1.2 1.6			●	●	●	●			
CNGN		160712T02025 160716T02025	T02025	4	15.875	7.94	-	1.2 1.6			●	●					
CNMN		120708T02025	T02025	4	12.7	7.94	-	0.8			●						

● : Standard item R : Right-hand only L : Left-hand only □ : Check availability

55° Rhombic

How to read pages of "Turning inserts" See page B15

B



Turning indexable inserts

Chip breakers

Negative

C

D

R

S

T

V

W

Ceramic

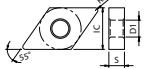
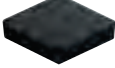
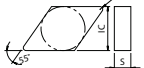
Cutting edge preparation			Gray cast iron (with scale)				Gray cast iron (without scale)				Nodular cast iron (with scale)				Nodular cast iron (without scale)				Heat-resistant alloy				Hard materials			
Symbol	Specification	Example																								
S	Chamfered and R-honed	S01525 0.15mm × 25° chamfered and R-honed																								
T	Chamfered	T02025 0.20mm × 25° chamfered																								
Insert	Description	Edge preparation type	No. of edges	Dimension (mm)				Ceramic			Applicable toolholder															
				IC	S	D1	RE	PVD	-																	
 	DNGA 150404S01525 150408S01525	S01525	4	12.7	4.76	5.16	0.4 0.8	● ●	-	D13~D17 F118, F130 F132~F134																
	DNGA 150404S02025 150408S02025	S02025	4	12.7	4.76	5.16	0.4 0.8	● ●	-																	
	DNGA 150404T02025 150408T02025 150412T02025	T02025	4	12.7	4.76	5.16	0.4 0.8 1.2	● ● ●	-																	
	DNGA 150408S03030	S03030	4	12.7	4.76	5.16	0.8	●	-																	
	DNGA 150604T02025 150608T02025 150612T02025	T02025	4	12.7	6.35	5.16	0.4 0.8 1.2	● ● ●	-		D13~D17 F118															
 	DNGN 150704S01525 150708S01525 150712S01525	S01525	4	12.7	7.94	-	0.4 0.8 1.2	● ● ●	-	D50																
	DNGN 150708S02025	S02025	4	12.7	7.94	-	0.8	●	-																	
	DNGN 150704T02025 150708T02025 150712T02025 150716T02025	T02025	4	12.7	7.94	-	0.4 0.8 1.2 1.6	● ● ● ●	-																	

● : Standard item R : Right-hand only L : Left-hand only □ : Check availability

75° Rhombic

How to read pages of "Turning inserts" See page B15

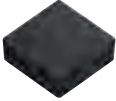
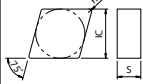
Cutting edge preparation				Gray cast iron (with scale)		Gray cast iron (without scale)		Nodular cast iron (with scale)		Nodular cast iron (without scale)		Heat-resistant alloy		Hard materials		
Symbol	Specification	Example														
S	Chamfered and R-honed	S01525	0.15mm × 25° chamfered and R-honed													
T	Chamfered	T02025	0.20mm × 25° chamfered													
Insert	Description	Edge preparation type	No. of edges	Dimension (mm)			Cera-mic		Applicable toolholder							
				IC	S	RE	A66N	A65								
 	ENGN 130708S01525 ENGN 130704T02025 130708T02025 130712T02025 130716T02025 130720T02025	S01525	4	12.7	7.94	0.8	●	-	D51 F145							
	T02025	4	12.7	7.94	0.4 0.8 1.2 1.6 2	● ● ● ● ●										

B



Turning indexable inserts

● : Standard item R : Right-hand only L : Left-hand only □ : Check availability

Round

How to read pages of "Turning inserts" See page B15

B



Turning indexable inserts

Chip breakers

Negative





Ceramic

Cutting edge preparation				Material compatibility										Applicable toolholder				
Symbol	Specification	Example		Gray cast iron (with scale)	Gray cast iron (without scale)	Nodular cast iron (with scale)	Nodular cast iron (without scale)	Heat-resistant alloy	Hard materials	Al6N	P1600M	Ag5	KS6015		KS6030	KS6040	KS6050	
				Edge preparation type	Dimension (mm)		Ceramic											
					IC	S	PVD											
E	R-honed	E005	R0.05mm honed														K	
K	Double chamfered	K15015	1.5mm × 15° chamfered															
S	Chamfered and R-honed	S01525	0.15mm × 25° chamfered and R-honed															
T	Chamfered	T02025	0.20mm × 25° chamfered															
																	S	
																		H
Insert	Description	Edge preparation type	Dimension (mm)		Ceramic							Applicable toolholder						
			IC	S	PVD													
					Al6N	P1600M	Ag5	KS6015	KS6030	KS6040	KS6050							
	RNGN 090300T01020	T01020	9.525	3.18													D61	
	RNGN 090400S01525	S01525	9.525	4.76	●													
	RNGN 090400S02025	S02025	9.525	4.76		●												
	RNGN 090400T02025	T02025	9.525	4.76			●	●										
	RNGN 120400E003	E003	12.7	4.76									●				D58 D61	
	RNGN 120400T01020	T01020	12.7	4.76									●					
	RNGN 120400S01525	S01525	12.7	4.76	●													
	RNGN 120400S02025	S02025	12.7	4.76		●												
	RNGN 120400T02025	T02025	12.7	4.76			●	●	●						●			
	RNGN 120700E003	E003	12.7	7.94									●					
	RNGN 120700E005	E005	12.7	7.94											●			
	RNGN 120700T01020	T01020	12.7	7.94										●	●			
	RNGN 120700K15015	K15015	12.7	7.94			●											
	RNGN 120700S01525	S01525	12.7	7.94	●													
	RNGN 120700S02025	S02025	12.7	7.94		●												
	RNGN 120700T02025	T02025	12.7	7.94			●	●	●						●			
	RNGN 150700S01525	S01525	15.875	7.94	●												D58	
	RNGN 150700S02025	S02025	15.875	7.94		●												
	RNGN 150700T02025	T02025	15.875	7.94			●											
	RNGN 190700E003	E003	19.05	7.94											●			-
RNGN 190700T01020	T01020	19.05	7.94											●	●			
RNGN 250700E003	E003	25.4	7.94											●			-	

● : Standard item R : Right-hand only L : Left-hand only □ : Check availability

90° Square

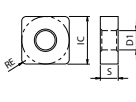
How to read pages of "Turning inserts" See page B15

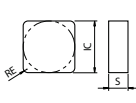
Cutting edge preparation			Material compatibility										Applicable toolholder					
Symbol	Specification	Example	Gray cast iron (with scale)	Gray cast iron (without scale)	Nodular cast iron (with scale)	Nodular cast iron (without scale)	Heat-resistant alloy	Hard materials	CVD	PVD	Ceramic							
			Edge preparation type	No. of edges	IC	S	D1	RE	C57050	A66N	PT600M	Ag5	KA30	KS6015	KS6040	KS6050		
 	SNGA	120408S01525 120412S01525	S01525	8	12.7	4.76	5.16	0.8 1.2	●	●							D19~D21 F136	
	SNGA	120408S02025 120412S02025	S02025	8	12.7	4.76	5.16	0.8 1.2		●	●							
	SNGA	120408T02025 120412T02025 120416T02025	T02025	8	12.7	4.76	5.16	0.8 1.2 1.6	●	●	●	●	●	●	●	●		
	SNMA	120408S03030	S03030	8	12.7	4.76	5.16	0.8		●								
 	SNGN	120412T01020	T01020	8	12.7	4.76	-	1.2							●		D52~D54 D63 D64	
	SNGN	120408S01025 120412S01025 120416S01025 120420S01025	S01025	8	12.7	4.76	-	0.8 1.2 1.6 2				●	●	●	●			
	SNGN	120408S01525 120412S01525 120416S01525	S01525	8	12.7	4.76	-	0.8 1.2 1.6	●	●								
	SNGN	120408S02025 120412S02025 120416S02025	S02025	8	12.7	4.76	-	0.8 1.2 1.6		●	●							
	SNGN	120404T02025 120408T02025 120412T02025 120416T02025 120420T02025	T02025	8	12.7	4.76	-	0.4 0.8 1.2 1.6 2	●	●	●	●	●	●	●	●		
	SNGN	120704S01525 120708S01525 120712S01525 120716S01525 120720S01525	S01525	8	12.7	7.94	-	0.4 0.8 1.2 1.6 2	●	●	●	●	●	●	●	●		
	SNGN	120708S02025 120712S02025 120716S02025 120720S02025	S02025	8	12.7	7.94	-	0.8 1.2 1.6 2		●	●	●	●	●	●	●		
	SNGN	120704T02025 120708T02025 120712T02025 120716T02025 120720T02025	T02025	8	12.7	7.94	-	0.4 0.8 1.2 1.6 2		●	●	●	●	●	●	●		
	SNMN	120716T02025	T02025	8	12.7	7.94	-	1.6			●							
	SNGN	150712T02025 150716T02025	T02025	8	15.875	7.94	-	1.2 1.6			●							D52 D53

● : Standard item R : Right-hand only L : Left-hand only □ : Check availability



60° Triangle

How to read pages of "Turning inserts" See page B15

B



Turning indexable inserts

Chip breakers

Negative



Ceramic

Cutting edge preparation			Material compatibility											Applicable toolholder			
Symbol	Specification	Example	Gray cast iron (with scale)	Gray cast iron (without scale)	Nodular cast iron (with scale)	Nodular cast iron (without scale)	Heat-resistant alloy	Hard materials	Ceramic								
			Edge preparation type	No. of edges	Dimension (mm)				Ceramic								
					IC	S	D1	RE	PVD		-						
									AG6N	PT600M	AG5	KA30	KS6015	KS6050	KT66		
		TNGA 160408T00520	T00520	6	9.525	4.76	3.81	0.8								D22~D25 D27 D28 F120 F137 F138	
		TNGA 160404S01525 160408S01525 160412S01525	S01525	6	9.525	4.76	3.81	0.4 0.8 1.2	●								
		TNGA 160404S02025 160408S02025 160412S02025	S02025	6	9.525	4.76	3.81	0.4 0.8 1.2	●	●							
		TNGA 160404T02025 160408T02025 160412T02025	T02025	6	9.525	4.76	3.81	0.4 0.8 1.2	●	●	●	●	●	●	●		
		TNGA 160408S03030	S03030	6	9.525	4.76	3.81	0.8	●								
		TNGN 110304T00520 110308T00520 110312T00520	T00520	6	6.35	3.18	-	0.4 0.8 1.2	●	●	●						D66 F146
		TNGN 160404T00520 160408T00520 160412T00520	T00520	6	9.525	4.76	-	0.4 0.8 1.2	●	●	●						
		TNGN 160404S01025 160408S01025 160412S01025	S01025	6	9.525	4.76	-	0.4 0.8 1.2	●			●					D56
		TNGN 160404S01525 160408S01525 160412S01525	S01525	6	9.525	4.76	-	0.4 0.8 1.2	●	●							
		TNGN 160404S02025 160408S02025 160412S02025	S02025	6	9.525	4.76	-	0.4 0.8 1.2	●	●							
TNGN 160404T02025 160408T02025 160412T02025	T02025	6	9.525	4.76	-	0.4 0.8 1.2	●	●	●	●	●	●	●				
TNGN 160704T02025 160708T02025 160712T02025	T02025	6	9.525	7.94	-	0.4 0.8 1.2	●	●	●								

● : Standard item R : Right-hand only L : Left-hand only □ : Check availability

35° Rhombic

How to read pages of "Turning inserts" See page B15

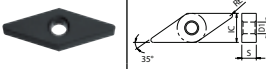
Cutting edge preparation												
Symbol	Specification	Example										
S	Chamfered and R-honed	S01525 0.15mm × 25° chamfered and R-honed										
T	Chamfered	T02025 0.20mm × 25° chamfered										
			Gray cast iron (with scale)									
			Gray cast iron (without scale)									
			Nodular cast iron (with scale)									
			Nodular cast iron (without scale)									
			Heat-resistant alloy									
			Hard materials									
Insert	Description	Edge preparation type	No. of edges	Dimension (mm)				Ceramic			Applicable toolholder	
				IC	S	D1	RE	PVD -				
								Ag6N	PT600M	Ag5		
	VNGA 160404S01525 160408S01525	S01525	4	9.525	4.76	3.81	0.4 0.8	● ●	-	-	D30~D39	
	VNGA 160404S02025 160408S02025	S02025	4	9.525	4.76	3.81	0.4 0.8	● ●	-	-		
	VNGA 160404T02025 160408T02025 160412T02025	T02025	4	9.525	4.76	3.81	0.4 0.8 1.2	● ● ●	● ●	-		

B



Turning indexable inserts

● : Standard item R : Right-hand only L : Left-hand only □ : Check availability

Round

How to read pages of "Turning inserts" See page B15

B



Turning indexable inserts

Chip breakers

Positive



Ceramic

Cutting edge preparation				Gray cast iron (with scale)			K
Symbol				Gray cast iron (without scale)			
Specification				Nodular cast iron (with scale)			
Example				Nodular cast iron (without scale)			
Symbol	Specification	Example		Heat-resistant alloy			S
E	R-honed	E003	R0.03mm honed	Hard materials			H
T	Chamfered	T01020	0.10mm × 20° chamfered				
Insert	Description	Edge preparation type	Dimension (mm)		Angle (°)		Applicable toolholder
			IC	S	AN	Ceramic	
	RPGN 090300E003	E003	9.525	3.18	11	●	-
	RPGN 090300T01020	T01020	9.525	3.18	11	●	
	RPGN 120400E003	E003	12.7	4.76	11	●	
	RPGN 120400T01020	T01020	12.7	4.76	11	●	

● : Standard item R : Right-hand only L : Left-hand only □ : Check availability

Square

How to read pages of "Turning inserts" See page B15

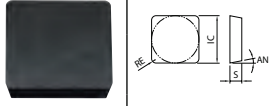
Cutting edge preparation			Gray cast iron (with scale)		Gray cast iron (without scale)		Nodular cast iron (with scale)		Nodular cast iron (without scale)		Heat-resistant alloy		Hard materials	
Symbol	Specification	Example												
S	Chamfered and R-honed	S00820 0.08mm × 20° chamfered and R-honed												
T	Chamfered	T00820 0.08mm × 20° chamfered												
Insert	Description	Edge preparation type	No. of edges	Dimension (mm)			Angle (°)	Cera- mic		Applicable toolholder				
				IC	S	RE		AN	PVD		-			
	SPGN 090308S00820	S00820	4	9.525	3.18	0.8	11	●	-	F112				
	SPGN 090308T00820	T00820	4	9.525	3.18	0.8	11	●	-					
	SPGN 120308S00820	S00820	4	12.7	3.18	0.8	11	●	-					
	SPGN 120308T00820 120312T00820	T00820	4	12.7	3.18	0.8 1.2	11	● ●	- -					



Turning indexable inserts

● : Standard item R : Right-hand only L : Left-hand only □ : Check availability

Triangle

How to read pages of "Turning inserts" See page B15

B



Turning indexable inserts

Chip breakers

Positive







Ceramic

Cutting edge preparation			Gray cast iron (with scale)				Gray cast iron (without scale)				Nodular cast iron (with scale)				Nodular cast iron (without scale)				Heat-resistant alloy				Hard materials			
Symbol	Specification	Example																								
S	Chamfered and R-honed	S00820	0.08mm × 20° chamfered and R-honed																							
T	Chamfered	T00820	0.08mm × 20° chamfered																							
Insert	Description	Edge preparation type	No. of edges	Dimension (mm)			Angle (°)	Ceramic			Applicable toolholder															
				IC	S	RE		AN	PVD	-																
	TBGN 060104S00820 060108S00820	S00820	3	3.97	1.59	0.4 0.8	5	●	●	●	-	-														
	TPGN 090204T00820 090208T00820	T00820	3	5.56	2.38	0.4 0.8	11	●	●	●	-	-														
	TPGN 110304S00820 110308S00820	S00820	3	6.35	3.18	0.4 0.8	11	●	●	●	-	-														
	TPGN 110304T00820 110308T00820	T00820	3	6.35	3.18	0.4 0.8	11	●	●	●	●	F113														
	TPGN 160304S00820 160308S00820 160312S00820	S00820	3	9.525	3.18	0.4 0.8 1.2	11	●	●	●	●	-														
	TPGN 160304T00820 160308T00820	T00820	3	9.525	3.18	0.4 0.8	11	●	●	●	●	-														

●: Standard item R: Right-hand only L: Left-hand only □: Check availability

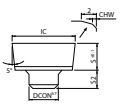
Inserts for high hardened roll

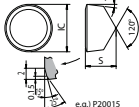
How to read pages of "Turning inserts" See page B15

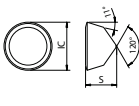
Cutting edge preparation												
Symbol	Specification	Example										
E	R-honed	E005	R0.05mm honed									
K	Double chamfered	K20003	2.0mm × 3° chamfered									
P	Double chamfered and R-honed	P20015	2.0mm × 15° chamfered and R-honed									
S	Chamfered and R-honed	S01020	0.10mm × 20° chamfered and R-honed									
T	Chamfered	T01020	0.10mm × 20° chamfered									
Insert	Description	Edge preparation type	Dimension (mm)					Ceramic			Applicable toolholder	
			IC	DCON	S	S2	CHW	PVD				
		RBG 16K20003	K20003	16	8	8	5	0.2	●			-
		RCGX 060600E005	E005	6.35	-	6.35	-	-	●			-
		RCGX 060600T01020	T01020	6.35	-	6.35	-	-	●	●		-
		RCGX 090700T01020	T01020	9.525	-	8	-	-	●	●		-
		RCGX 090700P20015	P20015	9.525	-	8	-	-	●			-
		RCGX 120700E003	E003	12.7	-	8	-	-	●			-
		RCGX 120700T01020	T01020	12.7	-	8	-	-	●			-
		RCGX 120700P20015	P20015	12.7	-	8	-	-	●			-
		RPGX 060600E003	E003	6.35	-	6.35	-	-	●			-
		RPGX 060600T01020	T01020	6.35	-	6.35	-	-	●			-
		RPGX 090700E003	E003	9.525	-	8	-	-	●			-
		RPGX 090700T01020	T01020	9.525	-	8	-	-	●			-
		RPGX 120700E003	E003	12.7	-	8	-	-	●			-

Turning indexable inserts

● : Standard item R : Right-hand only L : Left-hand only □ : Check availability

Grooving inserts

How to read pages of "Turning inserts" See page B15

B



Turning indexable inserts

Chip breakers

Grooving



Ceramic

Cutting edge preparation			Material compatibility										Applicable toolholder	
Symbol	Specification	Example											K	
S	Chamfered and R-honed	S01020 0.10mm × 20° chamfered and R-honed											● ○	
T	Chamfered	T01020 0.10mm × 20° chamfered											● ○	
			Gray cast iron (with scale)										● ○	
			Gray cast iron (without scale)										● ○	
			Nodular cast iron (with scale)										● ○	
			Nodular cast iron (without scale)										● ○	
			Heat-resistant alloy										S	
			Hard materials										○ ● H	
Insert	Description	Edge preparation type	No. of edges	Dimension (mm)				Tolerance		Ceramic			Applicable toolholder	
				CW	S	RE	INSL	CW min.	CW max.	PVD				
										Al6N	P1600M	Al6S		
	GH 4020-05	S01020 T01020	2	4	7.5	0.5	20	-0.05	+0.05	●	●	●	G62 G63 G93	
	GH 5020-05	S01020 T01020	2	5	7.5	0.5	20	-0.05	+0.05	●	●	●		
	GH 6020-05	T01020	2	6	7.5	0.5	20	-0.05	+0.05	●	●	●		
	GH 7020-05	T01020	2	7	7.5	0.5	20	-0.05	+0.05	●	●	●		

● : Standard item R : Right-hand only L : Left-hand only □ : Check availability

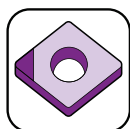

CBN Lineup		C2
Negative inserts	80° Rhombic	C8
	55° Rhombic	C10
	90° Square	C12
	60° Triangle	C13
	35° Rhombic	C14
	80° Trigon	C15
	80° Rhombic / Solid	C16
	Round / Solid	C17
	90° Square / Solid	C18
Positive inserts	60° Triangle / Solid	C19
	80° Rhombic	C20
	55° Rhombic	C22
	60° Triangle	C23
	35° Rhombic	C26
Grooving inserts	80° Trigon	C28
	GBA	C29
	GDGS	C30
	GMN	C31
Solid bar	EZB-NB	C32
PCD Lineup		C33
Negative inserts	80° Rhombic	C34
	55° Rhombic	C35
	60° Triangle	C36
	35° Rhombic	C37
	80° Trigon	C38
Positive inserts	80° Rhombic	C39
	55° Rhombic	C42
	90° Square	C43
	60° Triangle	C44
	35° Rhombic	C49
Grooving inserts	80° Trigon	C51
	GBA/TGF	C52
	GV/GVF	C53
	GDGS	C54
	GMN	C55
	GMGW	C56
Solid bar	TKF	C57
	EZB-NB	C58
	VNBR-NB	C59
	VNGR-NB	C60
Milling inserts	Available inserts	C62

Identification system (Turning insert / CBN)

C N G A 12 04 04 S01225 ME

Turning Indexable Inserts Identification System* See B2

Insert type	Description	Edge preparation	Manufacturer's option	Edge length	Number of edges	Re-grinding
Negative	CNGA120404MEF	F	MEF	Short (Small edge)	2	Not recommended
	CNGA120404ME4	S01225	ME4		4 (Multi edge double-sided)	
	CNGA120404S01225ME		ME		2	
	CNGA120404S00545MEP	S00545	MEP		2	
	CNGA120404S01225SE	S01225	SE		1	
	CNMN120404S02020	S02020	Without indication (Only KBN900)	Long	Multi edge	Possible
Positive	CCMW09T304MEF	F	MEF	Short (Small edge)	2	Not recommended
	CCMW09T304T00815ME	T00815	ME		2	
	CCMW09T304S01225MES	S01225	MES		2	
	CCMW09T304T00815SE	T00815	SE		1	

About re-grinding

- Re-grinding is possible for inserts without any indication in manufacturer's option. Regrinding can not be available depending on the edge condition.
- Re-grinding is not recommended for inserts with manufacturer's symbol like "ME" or "SE"

Edge preparation identification system

Edge preparation				
Symbol	Cutting edge spec.	Example		Shape
F	Sharp edge	F	Sharp edge	
E	Honed cutting edge	E008	R0.08 mm honed cutting edge	
T	Chamfered cutting edge	T01215	0.12 mm x 15° chamfered cutting edge	
S	Chamfered and honed cutting edge	S01225	0.12 mm x 25° chamfered and honed cutting edge	

Features of chamfer width and angle

Chamfer width and angle

Small ←→ Large

Cutting force	Good ←→ Poor
Wear resistance	Good ←→ Poor
Fracture resistance	Poor ←→ Good
Application	Continuous ←→ Interruption

Chamfered cutting edge (chamfered + honed)

Standard cutting edge preparation

Negative type (machining of hard materials)

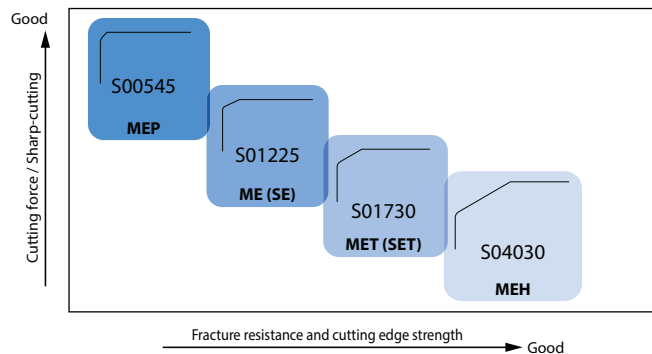

Positive type (machining of hard materials)

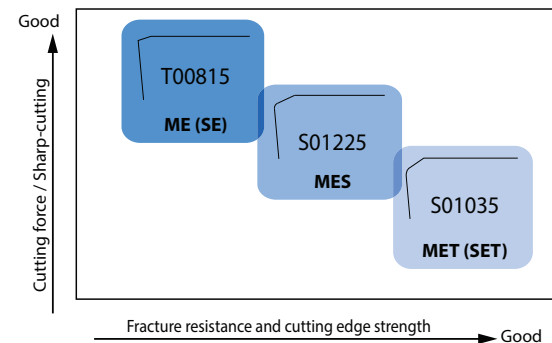

Manufacturer's option	Edge preparation		Application and features
MEP	S00545	0.05 mm x 45°+ Honed cutting edge	High speed, continuous cut. Excellent crater wear resistance.
ME	S01225	0.12 mm x 25°+ Honed cutting edge	General purpose.
MET	S01730	0.17 mm x 30°+ Honed cutting edge	Superior fracture resistance.
MEH	S04030	0.40 mm x 30°+ Honed cutting edge	Interrupted high feed machining. Prevention of flaking.

Manufacturer's option	Edge preparation		Application and features
ME	T00815	0.08 mm x 15°	Chamfered type. Sharp-cutting oriented, less burring.
MES	S01225	0.12 mm x 25°+ Honed cutting edge	General purpose.
MET	S01035	0.10 mm x 35°+ Honed cutting edge	Interrupted machining. Stable machining oriented.

CBN inserts for machining hardened material

H chipbreaker series

Unique molded chipbreaker provides excellent chip control when machining hardened material. 3 Chipbreaker styles for a wide range of machining applications.



Chipbreaker	Application	Recommended cutting range
<p>HH</p> <p>1st Recommendation</p>	<p>Hardened steel finishing</p> <p>55HRC or more</p>	<p>Small D.O.C.</p> <p>$a_p = 0.1 \sim 0.3 \text{ mm}$</p>
<p>HL</p>	<p>Hardened steel finishing</p> <p>55HRC or less</p>	
<p>HD</p>	<p>Removing carburized layer</p> <p>From carburized layer to unhardened layer</p>	<p>Large D.O.C.</p> <p>$a_p = 0.3 \sim 0.7 \text{ mm}$</p>

MEGACOAT CBN

Properties of PVD coating

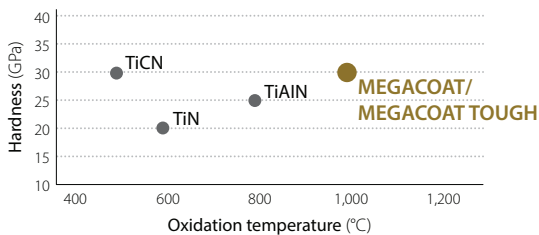

Advantages of MEGACOAT

Long tool life and stable machining due to superior heat-resistance and hardness.

Stability improvement through prevention of crater wear (oxidation, diffusional wear).

High thermal stability and surface smoothness provide excellent surface finish.

New Coated CBN for Machining Hardened Material

KBN020

Long tool life and stable machining results with wear resistance and fracture resistance.

Supports a wide range of applications and reduces the cost of machining hardened materials.

1 Combination of New coating technology and high content CBN provides exceptional wear resistance and fracture resistance

Wear Resistance

New coating "MEGACOAT TOUGH" suppresses layer peeling.

Excellent wear resistance

Wear Resistance Comparison (In-house evaluation)

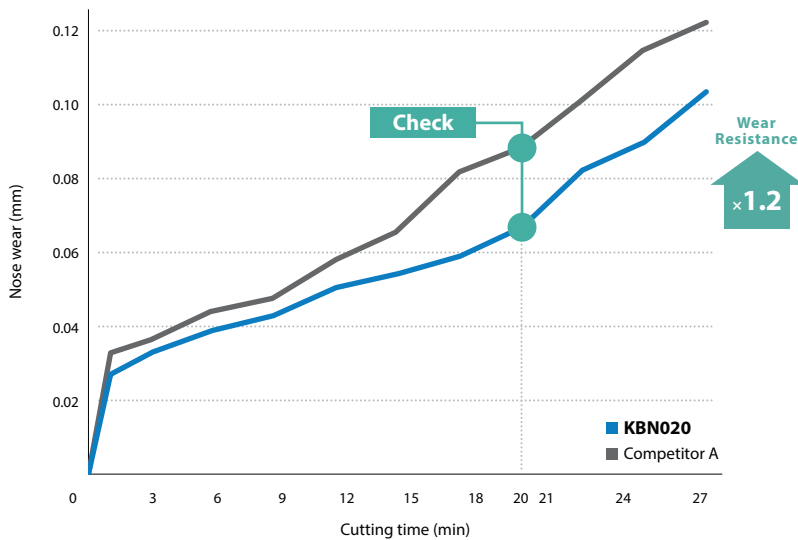

Cutting conditions: Vc = 150 m/min, ap = 0.2 mm, f = 0.1 mm/rev, Wet
Workpiece: 15CrMo4 60HRC

KBN020



Competitor A

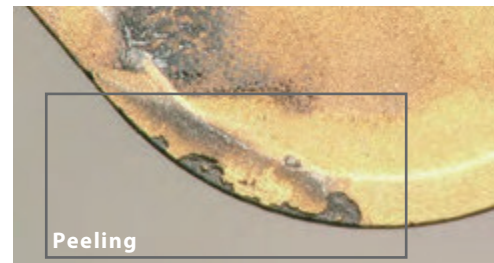

Fracture Resistance

High content CBN and high purity TiN binder improves strength of CBN.

Excellent fracture resistance

Continuous to Interrupted Machining Comparison (In-house evaluation)

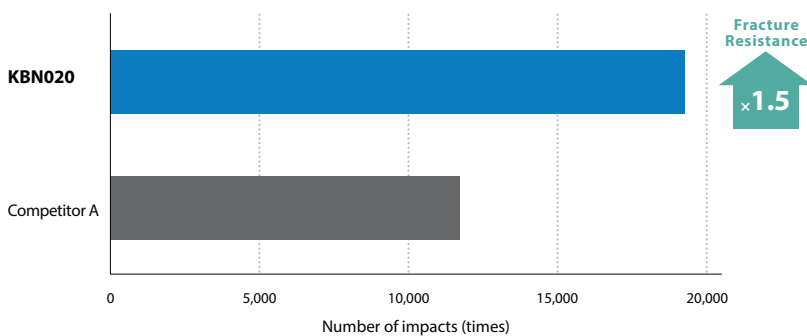

Cutting conditions: Vc = 150 m/min, ap = 0.2 mm, f = 0.2 mm/rev, Dry
Workpiece: 15CrMo4 60HRC

2 Newly Developed Coating "MEGACOAT TOUGH"

Features

An adhesion layer is laminated between the high wear resistance layer and the CBN.
Reduces layer peeling to achieve long tool life and stable machining.



CBN & PCD Tools

High Wear Resistance Layer with TiAlN + Oxidation Resistance Components.
Suppresses oxidation/diffusional wear

Check New Technology

Interlayer for stress relief

High adhesion layer

Two layers dedicated to CBN.
Improved adhesion between CBN and high wear resistant layer.
Suppressed layer peeling.

High content CBN with high purity TiN binder
Improved CBN strength

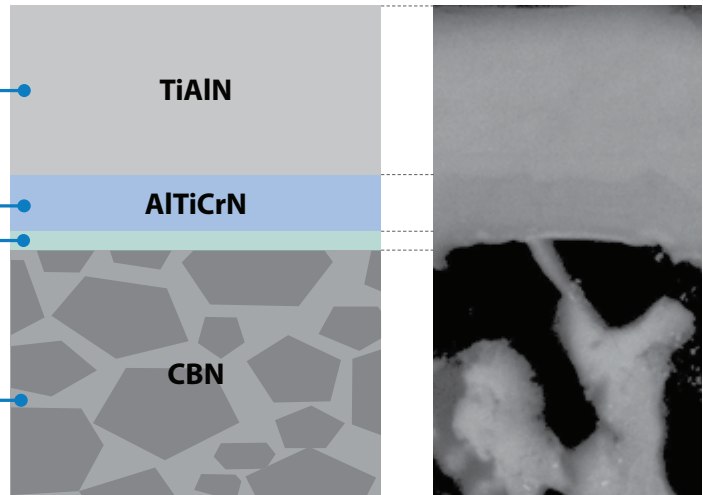

Layer image

Solution for Automotive Parts

CVT Shaft

Workpiece

17Cr3

Insert

DNGA150404S01225ME

Applications

External finishing

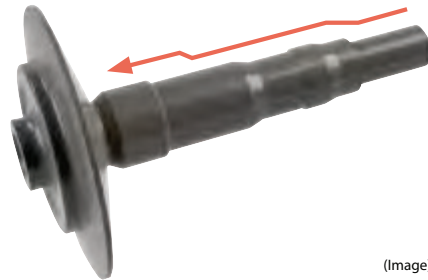
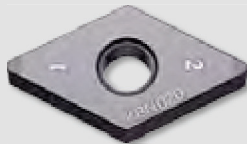

(Image)

Sun Gear

Workpiece

C45 (Carburizing and quenching)

Insert

CCMW09T308S01035MET

Applications

Boring finishing for spline part (Interruption)

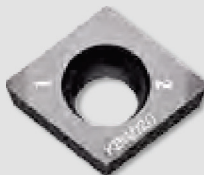

(Image)

Application map

Hard materials

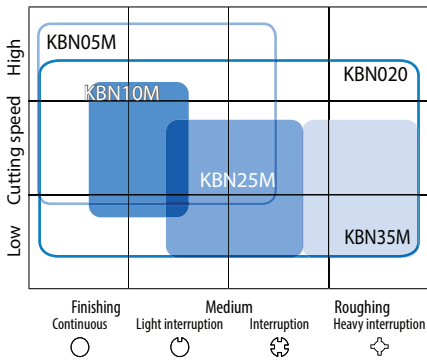

Hybrid grain structure (KBN05M)

Mixed structure of micro grain CBN and coarse grain CBN

CBN that possess High hardness, toughness and thermal resistance characteristics

CBN structure

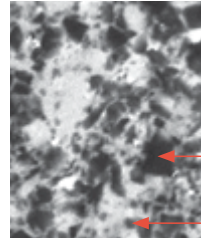

Coarse grain CBN

Micro grain CBN



Heat diffusion is promoted by coarse grain CBN
High thermal conductivity

- KBN020** : 1st recommended grade for a wide range of application from continuous (high speed finishing) to interrupted machining.
- KBN05M** : Applicable for continuous (high speed finishing) to interrupted machining. With chipbreaker Inserts are available.
- KBN25M** : High stability for general machining.
- KBN35M** : Honeycomb structure CBN (Superior fracture resistance in heavy interrupted machining).

Roll materials (Chilled cast iron)

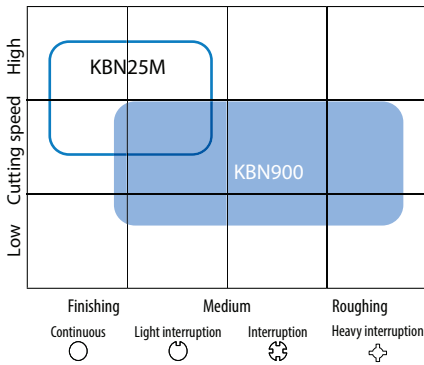

Sintered steel

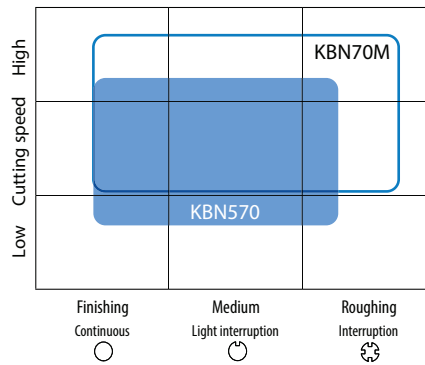

Cast iron

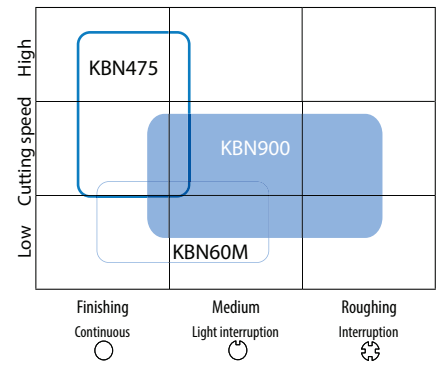

Recommended cutting conditions

Workpiece material	Hardness	Applications		Recommended insert grade	Cutting conditions		
					Vc: (m/min)	ap: (mm)	f: (mm/rev)
Hardened steel	Over 55HRC	General finishing	Continuous ~ Interruption	KBN020	80 - 150 - 200	0.05 - 0.2 - 0.5	0.05 - 0.2 - 0.45
		HH chipbreaker for hardened steel finishing	Continuous ~ Interruption	KBN05M	100 - 150 - 200	0.1 - 0.2 - 0.3	0.1 - 0.15 - 0.25
		High efficient stable machining	Light interruption ~ Interruption	KBN020	80 - 150 - 200	0.05 - 0.2 - 0.5	0.05 - 0.2 - 0.45
		Interruption (Small ap)	Interruption ~ Heavy interruption	KBN020	80 - 130 - 180	0.05 - 0.2 - 0.5	0.05 - 0.2 - 0.4
		Heavy machining	Continuous ~ Interruption	KBN900	70 - 90 - 110	0.5 - 1.0 - 2.0	0.05 - 0.1 - 0.2
	Under 55HRC	HL chipbreaker for hardened steel finishing	Continuous ~ Interruption	KBN05M	100 - 150 - 200	0.1 - 0.2 - 0.3	0.1 - 0.15 - 0.25
		Finishing	Continuous	*PT600M	60 - 80 - 120	0.2 - 0.5 - 0.7	0.05 - 0.1 - 0.15
Gray cast iron	Under 250HB	Finishing	Continuous ~ Light interruption	KBN475	400 - 800 - 1,200	0.05 - 0.2 - 0.5	0.1 - 0.2 - 0.3
		Finishing	Continuous ~ Light interruption	KBN60M	300 - 500 - 700	0.05 - 0.2 - 0.5	0.1 - 0.2 - 0.3
		High efficient finishing	Continuous ~ Light interruption	KBN900	500 - 900 - 1,200	0.1 - 0.5 - 1.0	0.05 - 0.1 - 0.2
		Heavy machining	Continuous ~ interruption	KBN900	500 - 700 - 900	0.5 - 1.5 - 3.0	0.1 - 0.3 - 0.5
Roll materials (Chilled cast iron)	Over 55HRC	Finishing	Continuous ~ interruption	KBN25M	80 - 120 - 160	0.05 - 0.3 - 0.5	0.05 - 0.08 - 0.1
		Heavy machining	Continuous ~ interruption	KBN900	70 - 90 - 110	0.3 - 0.7 - 1.0	0.05 - 0.1 - 0.15
Sintered steel	-	Finishing	Continuous ~ Light interruption	KBN570	50 - 150 - 250	0.05 - 0.15 - 0.25	0.03 - 0.1 - 0.2
	-	Finishing	Continuous ~ Interruption	KBN70M	100 - 200 - 250	0.05 - 0.2 - 0.3	0.05 - 0.15 - 0.25

*PT600M: MEGACOAT on Al₂O₃+TiC ceramic

Case studies

20Cr4 (58HRC)	
<ul style="list-style-type: none"> • Gear • External, facing & chamfering • Vc = 130 m/min • ap = 0.6 mm • f = 0.12 mm/rev • Wet • CNGA120408S01225ME (KBN05M) 	
KBN05M	300 pcs/edge
Competitor C	200 pcs/edge
<ul style="list-style-type: none"> • KBN05M achieved 1.5 times longer tool life than competitor C. • Its longer tool life contributes to cost-cutting. 	
Evaluation by the user	

15CrMo (55HRC)	
<ul style="list-style-type: none"> • Stator • Boring • Vc = 170 m/min • ap = 0.4 mm • f = 0.1 mm/rev • Wet • CNGA120408S01225ME (KBN05M) 	
KBN05M	600 pcs/edge
Competitor D	300 pcs/edge
<ul style="list-style-type: none"> • KBN05M achieved twice longer tool life than competitor D. • Its longer tool life contributes to cost-cutting. 	
Evaluation by the user	

20Cr4 (58HRC)	
<ul style="list-style-type: none"> • Pulley • Facing (Continuous) • Vc = 120 m/min • ap = 0.15 ~ 0.2 mm • f = 0.24 mm/rev • Wet • DNGA120408S00545MEP (KBN05M) 	
KBN05M-MEP (Edge preparation: 0.05 × 45°)	150 pcs/edge
KBN05M-ME (Edge preparation: 0.12 × 25°)	100 pcs/edge
Competitor E	100 pcs/edge
<ul style="list-style-type: none"> • Tool life of KBN05M-ME type (Edge prep.: 0.12 × 25° chamfered + R honed) is same as comp. E's. • KBN05M-MEP (Edge prep.: 0.05 × 45° chamfered + R honed) type achieved 1.5 times longer tool life, preventing crater wear. 	
Evaluation by the user	

Chromium steel (61~65HRC)	
<ul style="list-style-type: none"> • Gear • External & facing (Interrupted) • Vc = 120 m/min • ap = 0.15 mm • f = 0.1~0.15 mm/rev (External) • Wet • CNGA120408S04030MEH (KBN05M) 	
KBN05M-MEH (Edge preparation: 0.40 × 30°)	150 pcs/edge
Competitor F	100 pcs/edge
<ul style="list-style-type: none"> • Compared to competitor F, KBN05M-MEH type (Edge prep.: 0.40 × 30° chamfered + R honed) achieved 1.5 times longer tool life. • No chipping in interrupted machining, and improved productivity. Competitor F's cutting edge got many chipping. • Feed rate could be increased from 0.15 to 0.25 mm/rev in facing. • Achieved cycle time and cost reduction. 	
Evaluation by the user	

Chromium Molybdenum Hardened Steel (55 ~ 62HRC)	
<ul style="list-style-type: none"> • Pinion • Vc = 130 m/min • ap = 0.05 mm • f = 0.08 mm/rev • Dry • CNGM120408ME-HH (KBN05M) 	
KBN05M HH Chipbreaker	70 pcs/edge
Competitor G	30 pcs/edge
<p>The HH chipbreaker maintained 2.3 times longer tool life than Competitor F. The molded chipbreaker provided stable chip control.</p>	
Evaluation by the user	

17Cr3 (59HRC)	
<ul style="list-style-type: none"> • Clutch • Vc = 100 m/min • ap = 0.15 mm • f = 0.10 mm/rev • Wet • WNGA080408S01225ME (KBN020) 	
KBN020	650 pcs/edge
Competitor H	400 pcs/edge
<p>KBN020 can be stable machining and long tool life.</p>	
Evaluation by the user	

80° Rhombic

How to read pages of "Turning inserts" See page B15

Cutting edge preparation				Material compatibility										Applicable toolholder													
Symbol	Specification	Example												K													
F	Sharp edge	F	Sharp edge																								
E	R-honed	E008	R0.08mm honed																								
T	Chamfered	T01215	0.12mm x 15° chamfered																								
S	Chamfered and R-honed	S01225	0.12mm x 25° chamfered and R-honed											H													
				Hard materials (Roughing)										-													
				Hard materials (Finishing)																							
				Hard materials (Chip control)																							
				Sintered steel										-													
Insert	Description	Edge preparation type	No. of edges	Dimension (mm)					CBN							Applicable toolholder											
				IC	S	D1	RE	LE	PVD				-														
									KBN020	KBN05M	KBN10M	KBN25M	KBN35M	KBN60M	KBN70M		KBN475	KBN510	KBN525	KBN570							
	CNGA 120404S01215MEW 120408S01215MEW 120412S01215MEW With Wiper Edge	S01225	2	12.7	4.76	5.16	0.4	2.6	0.8	2.5	1.2	2.5	●	●	●	●	●	●	●	●	●	●	●	D8~D10 F116 F125 F126			
	CNGA 120404S00545MEP 120408S00545MEP 120412S00545MEP 120416S00545MEP 120420S00545MEP 120424S00545MEP Finishing	S00545	2	12.7	4.76	5.16	0.4	2.6	0.8	2.6	1.2	2.5	1.6	3.4	2	3.4	2.4	3.3	●	●	●	●	●		●		
	CNGA 120404MEF 120408MEF 120412MEF Sharp edge	F	2	12.7	4.76	5.16	0.4	2.6	0.8	2.6	1.2	2.5	●	●	●	●	●	●	●	●	●	●	●				
	CNGA 120404ME4 120408ME4 120412ME4 Double-sided	S01225	4	12.7	4.76	5.16	0.4	2.6	0.8	2.6	1.2	2.5	●	●	●	●	●	●	●	●	●	●	●				
	CNGA 120404T01215ME 120408T01215ME 120412T01215ME T01215	T01215	2	12.7	4.76	5.16	0.4	2.6	0.8	2.6	1.2	2.5	●	●	●	●	●	●	●	●	●	●	●		●		
	CNGA 120402S01225ME 120404S01225ME 120408S01225ME 120412S01225ME 120416S01225ME 120420S01225ME 120424S01225ME S01225	S01225	2	12.7	4.76	5.16	0.2	2.6	0.4	2.6	0.8	2.6	1.2	2.5	1.6	3.4	2	3.4	2.4	3.3	●	●	●		●	●	●
	CNGA 120404S01730MET 120408S01730MET 120412S01730MET 120416S01730MET 120420S01730MET 120424S01730MET Tough	S01730	2	12.7	4.76	5.16	0.4	2.6	0.8	2.6	1.2	2.5	1.6	3.4	2	3.4	2.4	3.3	●	●	●	●	●		●	●	
	CNGA 120404S04030MEH 120408S04030MEH 120412S04030MEH 120416S04030MEH 120420S04030MEH 120424S04030MEH Interruption	S04030	2	12.7	4.76	5.16	0.4	2.6	0.8	2.6	1.2	2.5	1.6	3.4	2	3.4	2.4	3.3	●	●	●	●	●		●	●	

● : Standard item R : Right-hand only L : Left-hand only □ : Check availability



CBN & PCD Inserts are sold in 1 piece boxes

CBN & PCD Tools

- CBN
- PCD
- Negative
- C
- D
- S
- T
- V
- W
- Solid
- Grooving

80° Rhombic

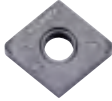
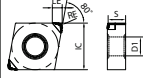
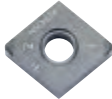
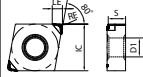
How to read pages of "Turning inserts" See page B15

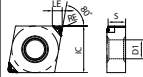
Cutting edge preparation				Gray cast iron (with scale)		Gray cast iron (without scale)		Nodular cast iron (with scale)		Hard materials (Roughing)		Hard materials (Finishing)		Hard materials (Chip control)		Sintered steel	
Symbol	Specification	Example		K		H		-									
F	Sharp edge	F	Sharp edge														
E	R-honed	E008	R0.08mm honed														
T	Chamfered	T01215	0.12mm × 15° chamfered														
S	Chamfered and R-honed	S01225	0.12mm × 25° chamfered and R-honed														
Insert	Description	Edge preparation type	No. of edges	Dimension (mm)					CBN	PVD	Applicable toolholder						
				IC	S	D1	RE	LE									
	 Hardened steel Finishing (55HRC or more)	CNGM	120404ME-HH 120408ME-HH 120412ME-HH	E	2	12.7	4.76	5.16	0.4 0.8 1.2	2.6 2.6 2.5	● ● ●	D8~D10 F116 F125 F126					
	 Hardened steel Finishing (55HRC or less)	CNGM	120404ME-HL 120408ME-HL 120412ME-HL	E	2	12.7	4.76	5.16	0.4 0.8 1.2	2.6 2.6 2.5	● ● ●						
	 Removing the Carburized Layer	CNGM	120404ME-HD 120408ME-HD 120412ME-HD	S01235	2	12.7	4.76	5.16	0.4 0.8 1.2	2.6 2.6 2.5	● ● ●						





CBN & PCD Tools

● : Standard item R : Right-hand only L : Left-hand only □ : Check availability

CBN & PCD Inserts are sold in 1 piece boxes

55° Rhombic

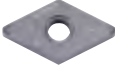
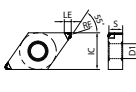
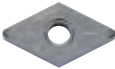
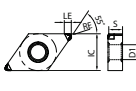
How to read pages of "Turning inserts" See page B15

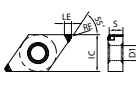
Cutting edge preparation				Gray cast iron (with scale)		Gray cast iron (without scale)		Nodular cast iron (with scale)		Hard materials (Roughing)		Hard materials (Finishing)		Hard materials (Chip control)		Sintered steel	
Symbol	Specification	Example		K		H		-									
F	Sharp edge	F	Sharp edge														
E	R-honed	E008	R0.08mm honed														
T	Chamfered	T01215	0.12mm × 15° chamfered														
S	Chamfered and R-honed	S01225	0.12mm × 25° chamfered and R-honed														
Insert	Description	Edge preparation type	No. of edges	Dimension (mm)					CBN	PVD	Applicable toolholder						
				IC	S	D1	RE	LE									
	 <p>DNGM 150404ME-HH 150408ME-HH 150412ME-HH</p> <p>Hardened steel Finishing (55HRC or more)</p>	E	2	12.7	4.76	5.16	0.4 0.8 1.2	2.6 2.2 1.9	● ● ●	D13~D17 F118, F130 F132~F134							
	 <p>DNGM 150404ME-HL 150408ME-HL 150412ME-HL</p> <p>Hardened steel Finishing (55HRC or less)</p>	E	2	12.7	4.76	5.16	0.4 0.8 1.2	2.6 2.2 1.9	● ● ●								
	 <p>DNGM 150404ME-HD 150408ME-HD 150412ME-HD</p> <p>Removing the Carburized Layer</p>	S01235	2	12.7	4.76	5.16	0.4 0.8 1.2	2.6 2.2 1.9	● ● ●								







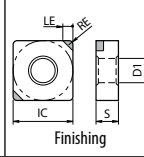

● : Standard item R : Right-hand only L : Left-hand only □ : Check availability

CBN & PCD Inserts are sold in 1 piece boxes

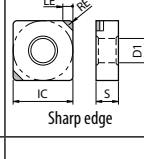
90° Square

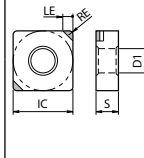
How to read pages of "Turning inserts" See page B15

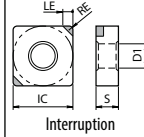
Cutting edge preparation				Material compatibility										Applicable toolholder				
Symbol	Specification	Example		Gray cast iron (with scale)		Gray cast iron (without scale)		Nodular cast iron (with scale)		Hard materials (Roughing)		Hard materials (Finishing)		Hard materials (Chip control)		Sintered steel		Applicable toolholder
F	Sharp edge	F	Sharp edge															
E	R-honed	E008	R0.08mm honed								*							
T	Chamfered	T01215	0.12mm x 15° chamfered															
S	Chamfered and R-honed	S01225	0.12mm x 25° chamfered and R-honed															
Insert	Description	Edge preparation type	No. of edges	Dimension (mm)					CBN					Applicable toolholder				
				IC	S	D1	RE	LE	PVD		-							
									KBN020	KBN05M	KBN25M	KBN35M	KBN475		KBN525			
	 Finishing	SNGA	120408S00545MEP 120412S00545MEP	S00545	2	12.7	4.76	5.16	0.8 1.2	1.8 2.2	●	●						D19~D21 F136
	 Sharp edge	SNGA	120408MEF 120412MEF	F	2	12.7	4.76	5.16	0.8 1.2	1.8 2.2					●	●		
		SNGA	120408T01215ME 120412T01215ME	T01215	2	12.7	4.76	5.16	0.8 1.2	1.8					●	●		
		SNGA	120404S01225ME 120408S01225ME 120412S01225ME	S01225	2	12.7	4.76	5.16	0.4 0.8 1.2	1.8	●	●	●	●		●	●	
		SNGA	120404S01730MET 120408S01730MET 120412S01730MET	S01730	2	12.7	4.76	5.16	0.4 0.8 1.2	1.8 1.8 2.2	●	●	●	●	●	●	●	
	 Interruption	SNGA	120408S04030MEH 120412S04030MEH	S04030	2	12.7	4.76	5.16	0.8 1.2	1.8 2.2	●	●						

C

CBN & PCD Tools

CBN

PCD

Negative

C

D

S

T

V

W

Solid











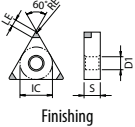

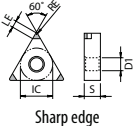
Grooving

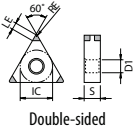
● : Standard item R : Right-hand only L : Left-hand only □ : Check availability

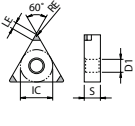
CBN & PCD Inserts are sold in 1 piece boxes

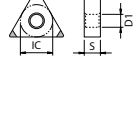
60° Triangle

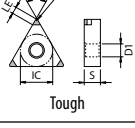
How to read pages of "Turning inserts" See page B15

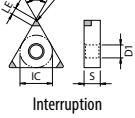
Cutting edge preparation			Material/Preparation										K					
Symbol	Specification	Example											H					
F	Sharp edge	F Sharp edge																
E	R-honed	E008 R0.08mm honed																
T	Chamfered	T01215 0.12mm x 15° chamfered																
S	Chamfered and R-honed	S01225 0.12mm x 25° chamfered and R-honed																
			Hard materials (Roughing)										-					
			Hard materials (Finishing)															
			Hard materials (Chip control)										-					
			Sintered steel															
Insert	Description	Edge preparation type	No. of edges	Dimension (mm)					CBN								Applicable toolholder	
				IC	S	D1	RE	LE	PVD				-					
	 Finishing	TNGA	160404S00545MEP 160408S00545MEP 160412S00545MEP	S00545	3	9.525	4.76	3.81	0.4 0.8 1.2	2.7 2.4 2.1	● ● ●							
	 Sharp edge	TNGA	160404MEF 160408MEF 160412MEF	F	3	9.525	4.76	3.81	0.4 0.8 1.2	2.7 2.4 2.1							● ● ●	
	 Double-sided	TNGA	160404ME6 160408ME6 160412ME6	S01225	6	9.525	4.76	3.81	0.4 0.8 1.2	2.7 2.4 2.1	● ● ●							
	 T01215	TNGA	160404T01215ME 160408T01215ME 160412T01215ME	T01215	3	9.525	4.76	3.81	0.4 0.8 1.2	2.7 2.4 2.1							● ● ●	D22~D25 D27, D28 F120 F137 F138
	 S01225	TNGA	160401S01225ME 160402S01225ME 160404S01225ME 160408S01225ME 160412S01225ME	S01225	3	9.525	4.76	3.81	0.1 0.2 0.4 0.8 1.2	2.9 2.8 2.7 2.4 2.1	● ● ● ● ●	● ● ● ● ●						
	 Tough	TNGA	160404S01730MET 160408S01730MET 160412S01730MET	S01730	3	9.525	4.76	3.81	0.4 0.8 1.2	2.7 2.4 2.1	● ● ●	● ● ●						●
	 Interruption	TNGA	160404S04030MEH 160408S04030MEH 160412S04030MEH	S04030	3	9.525	4.76	3.81	0.4 0.8 1.2	2.7 2.4 2.1	● ● ●							



CBN & PCD Tools

● : Standard item R : Right-hand only L : Left-hand only □ : Check availability

CBN & PCD Inserts are sold in 1 piece boxes

35° Rhombic

How to read pages of "Turning inserts" See page B15





Cutting edge preparation												K						
Symbol	Specification	Example												H				
F	Sharp edge	F	Sharp edge															
E	R-honed	E008	R0.08mm honed															
T	Chamfered	T01215	0.12mm x 15° chamfered															
S	Chamfered and R-honed	S01225	0.12mm x 25° chamfered and R-honed															
Gray cast iron (with scale)																		
Gray cast iron (without scale)																		
Nodular cast iron (with scale)																		
Hard materials (Roughing)																		
Hard materials (Finishing)																		
Hard materials (Chip control)																		
Sintered steel																		
Insert	Description	Edge preparation type	No. of edges	Dimension (mm)					CBN									Applicable toolholder
				IC	S	D1	RE	LE	PVD			-						
									KBN020	KBN05M	KBN10M	KBN25M	KBN35M	KBN60M	KBN70M	KBN475	KBN510	
 Finishing	VNGA 160404S00545MEP 160408S00545MEP	S00545	2	9.525	4.76	3.81	0.4 0.8	2 1.8										
 Sharp edge	VNGA 160404MEF 160408MEF	F	2	9.525	4.76	3.81	0.4 0.8	2 1.8										
 Double-sided	VNGA 160404ME4 160408ME4	S01225	4	9.525	4.76	3.81	0.4 0.8	2 1.8										
 Tough	VNGA 160404T01215ME 160408T01215ME	T01215	2	9.525	4.76	3.81	0.4 0.8	2 1.8										D30~D39
 Interruption	VNGA 160401S01225ME 160402S01225ME 160404S01225ME 160408S01225ME	S01225	2	9.525	4.76	3.81	0.1 0.2 0.4 0.8	2.6 2.3 2 1.8										
 Interruption	VNGA 160404S01730MET 160408S01730MET	S01730	2	9.525	4.76	3.81	0.4 0.8	2 1.8										
 Interruption	VNGA 160404S04030MEH 160408S04030MEH	S04030	2	9.525	4.76	3.81	0.4 0.8	2 1.8										

●: Standard item R: Right-hand only L: Left-hand only □: Check availability

CBN & PCD Inserts are sold in 1 piece boxes

80° Trigon

How to read pages of "Turning inserts" See page B15

Cutting edge preparation				Material										Applicable toolholder			
Symbol	Specification	Example		Material										Applicable toolholder			
F	Sharp edge	F	Sharp edge	Gray cast iron (with scale)											K		
E	R-honed	E008	R0.08mm honed	Gray cast iron (without scale)													
T	Chamfered	T01215	0.12mm × 15° chamfered	Nodular cast iron (with scale)													
S	Chamfered and R-honed	S01225	0.12mm × 25° chamfered and R-honed	Hard materials (Roughing)											H		
				Hard materials (Finishing)													
				Hard materials (Chip control)													
				Sintered steel										-			
Insert	Description	Edge preparation type	No. of edges	Dimension (mm)					CBN								
				IC	S	D1	RE	LE	PVD								
									KBN020	KBN05M	KBN25M	KBN35M	KBN60M	KBN475	KBN525		
	WNGA 080404MEF 080408MEF	F	3	12.7	4.76	5.16	0.4 0.8	2 2.6									D43~D46 F140 F142 F143
	WNGA 080404T01215ME 080408T01215ME	T01215	3	12.7	4.76	5.16	0.4 0.8	2 2.6									
	WNGA 080404S01225ME 080408S01225ME 080412S01225ME	S01225	3	12.7	4.76	5.16	0.4 0.8 1.2	2 2.6 2.5	●	●	●	●	●	●	●		
	WNGA 080404S01730MET 080408S01730MET 080412S01730MET	S01730	3	12.7	4.76	5.16	0.4 0.8 1.2	2 2.6 2.5	●	●	●	●	●	●	●		



● : Standard item R : Right-hand only L : Left-hand only □ : Check availability

CBN & PCD Inserts are sold in 1 piece boxes

80° Rhombic / Solid

How to read pages of "Turning inserts" ➔ See page B15

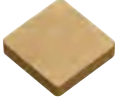
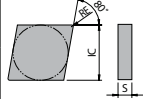
Cutting edge preparation				Gray cast iron (with scale)		✘		K
Symbol	Specification	Example		Gray cast iron (without scale)		✘		
F	Sharp edge	F	Sharp edge	Nodular cast iron (with scale)		✘		
E	R-honed	E008	R0.08mm honed	Hard materials (Roughing)		-		H
T	Chamfered	T01215	0.12mm × 15° chamfered	Hard materials (Finishing)		●		
S	Chamfered and R-honed	S01225	0.12mm × 25° chamfered and R-honed	Hard materials (Chip control)		-		
				Sintered steel				-
Insert	Description	Edge preparation type	No. of edges	Dimension (mm)			CBN	Applicable toolholder
				IC	S	RE		
 	CNMM 090308S02020 090312S02020	S02020	4	9.525	3.18	0.8 1.2	● ●	D60
	CNMM 120412S02020 120416S02020	S02020	4	12.7	4.76	1.2 1.6	● ●	D49



- C
- CBN & PCD Tools
- CBN
- PCD
- Negative
- C
- D
- S
- T
- V
- W
- Solid
- Grooving

● : Standard item R : Right-hand only L : Left-hand only □ : Check availability

CBN & PCD Inserts are sold in 1 piece boxes

Round / Solid

How to read pages of "Turning inserts" See page B15

Cutting edge preparation				Gray cast iron (with scale)		✖	K	
Symbol	Specification	Example		Gray cast iron (without scale)				✖
F	Sharp edge	F	Sharp edge	Nodular cast iron (with scale)				
E	R-honed	E008	R0.08mm honed	Hard materials (Roughing)		●	H	
T	Chamfered	T01215	0.12mm × 15° chamfered	Hard materials (Finishing)				
S	Chamfered and R-honed	S01225	0.12mm × 25° chamfered and R-honed	Hard materials (Chip control)				
				Sintered steel				-
Insert	Description	Edge preparation type	Dimension (mm)		CBN	PVD	Applicable toolholder	
			IC	S				KBN900
 	RNMN 090300S02020	S02020	9.525	3.18	●	D61		
	RNMN 120300S02020	S02020	12.7	3.18	●			
	RNMN 120400S02020	S02020	12.7	4.76	●		D58, D61	



CBN & PCD Tools

● : Standard item R : Right-hand only L : Left-hand only □ : Check availability

CBN & PCD Inserts are sold in 1 piece boxes

90° Square / Solid

How to read pages of "Turning inserts" See page B15

Cutting edge preparation				Gray cast iron (with scale)			✖		K
Symbol	Specification	Example		Gray cast iron (without scale)			✖		
F	Sharp edge	F	Sharp edge	Nodular cast iron (with scale)					
E	R-honed	E008	R0.08mm honed	Hard materials (Roughing)					
T	Chamfered	T01215	0.12mm × 15° chamfered	Hard materials (Finishing)			●		
S	Chamfered and R-honed	S01225	0.12mm × 25° chamfered and R-honed	Hard materials (Chip control)					
				Sintered steel					
Insert	Description	Edge preparation type	No. of edges	Dimension (mm)			CBN	Applicable toolholder	
				IC	S	RE			
	SNMN 090308S02020	S02020	8	9.525	3.18	0.8	●	D63, D64	
	090312S02020								
	SNMN 120308S02020	S02020	8	12.7	3.18	0.8	●		
	120312S02020								
	SNMN 120412S02020	S02020	8	12.7	4.76	1.2	●		D52~D54 D63, D64
	120416S02020								
120420S02020									

- C
- CBN & PCD Tools
- CBN
- PCD
- Negative
- C
- D
- S
- T
- V
- W
- Solid
- Grooving

● : Standard item R : Right-hand only L : Left-hand only □ : Check availability

CBN & PCD Inserts are sold in 1 piece boxes

60° Triangle / Solid

How to read pages of "Turning inserts" See page B15

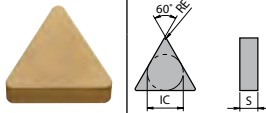
Cutting edge preparation				Gray cast iron (with scale)		Gray cast iron (without scale)		Nodular cast iron (with scale)		Hard materials (Roughing)		Hard materials (Finishing)		Hard materials (Chip control)		Sintered steel	
Symbol	Specification	Example		K		H		-		-		-		-		-	
F	Sharp edge	F	Sharp edge														
E	R-honed	E008	R0.08mm honed														
T	Chamfered	T01215	0.12mm × 15° chamfered														
S	Chamfered and R-honed	S01225	0.12mm × 25° chamfered and R-honed														
Insert	Description	Edge preparation type	No. of edges	Dimension (mm)			CBN	PVD	Applicable toolholder								
				IC	S	RE											
	TNMM 110308S02020	S02020	6	6.35	3.18	0.8	●	D66, F146									
	TNMM 160408S02020 160412S02020	S02020	6	9.525	4.76	0.8 1.2	● ●	D56									



CBN & PCD Tools

● : Standard item R : Right-hand only L : Left-hand only □ : Check availability

CBN & PCD Inserts are sold in 1 piece boxes

80° Rhombic

How to read pages of "Turning inserts" See page B15



CBN & PCD Tools

CBN

PCD

Positive



Solid

Grooving

Cutting edge preparation			Material Compatibility										K									
Symbol	Specification	Example																				
F	Sharp edge	F Sharp edge																				
E	R-honed	E008 R0.08mm honed																				
T	Chamfered	T01215 0.12mm x 15° chamfered																				
S	Chamfered and R-honed	S01225 0.12mm x 25° chamfered and R-honed																				
Edge preparation type			Dimension (mm)					CBN										Applicable toolholder				
No. of edges	IC	S	D1	RE	LE	PVD							-									
						KBN020	KBN05M	KBN10M	KBN25M	KBN35M	KBN60M	KBN70M	KBN475	KBN510	KBN525	KBN570						
		CCMW 09T304MEF 09T308MEF	F	2	9.525	3.97	4.4	0.4 0.8	1.9 1.8												E26~E28 E54 F60~F62 F122	
		CCMW 060202T00815ME 060204T00815ME 060208T00815ME	T00815	2	6.35	2.38	2.8	0.2 0.4 0.8	1.9 1.9 1.8	●	●	●	●	●	●	●	●	●	●	●	E26, E27, E28	
		CCMW 09T302T00815ME 09T304T00815ME 09T308T00815ME	T00815	2	9.525	3.97	4.4	0.2 0.4 0.8	1.9 1.9 1.8	●	●	●	●	●	●	●	●	●	●	●	●	E26~E28, E54 F60~F62 F122
		CCMW 060204S01225MES 060208S01225MES	S01225	2	6.35	2.38	2.8	0.4 0.8	1.9 1.8	●	●											E26, E28, E54 F31, F32 F60~F62
		CCMW 09T304S01225MES 09T308S01225MES	S01225	2	9.525	3.97	4.4	0.4 0.8	1.9 1.8	●	●										E26~E28, E54 F60~F62 F122	
		CCMW 09T304S01035MET 09T308S01035MET	S01035	2	9.525	3.97	4.4	0.4 0.8	1.9 1.8	●	●	●	●	●	●							E26~E28 E54 F60~F62 F122
		CCMW 030102T00815SE 030104T00815SE	T00815	1	3.5	1.4	1.9	0.2 0.4	1.4		●	●									F31 F32 F60 F62	
		CCMW 040102T00815SE 040104T00815SE	T00815	1	4.3	1.8	2.3	0.2 0.4	1.4		●	●										F31 F32 F60 F62
		CCMW 060202T00815SE 060204T00815SE	T00815	1	6.35	2.38	2.8	0.2 0.4	1.9				●									E26, E28, E54 F31, F32 F60~F62
		CCMW 09T302T00815SE 09T304T00815SE	T00815	1	9.525	3.97	4.4	0.2 0.4	1.9													
		CCMW 030102S01035SET 030104S01035SET	S01035	1	3.5	1.4	1.9	0.2 0.4	1.4		●	●										F31 F32 F60 F62
		CCMW 040102S01035SET 040104S01035SET	S01035	1	4.3	1.8	2.3	0.2 0.4	1.4		●	●										F31 F32 F60 F62
		CCMW 060204S01035SET	S01035	1	6.35	2.38	2.8	0.4	1.9													E26, E28, E54 F31, F32 F60~F62
		CCMW 09T304S01035SET	S01035	1	9.525	3.97	4.4	0.4	1.9													

● : Standard item R : Right-hand only L : Left-hand only □ : Check availability

CBN & PCD Inserts are sold in 1 piece boxes

C20

80° Rhombic

How to read pages of "Turning inserts" See page B15

Cutting edge preparation				Material Compatibility Matrix												Applicable toolholder			
Symbol	Specification	Example		Gray cast iron (with scale)	Gray cast iron (without scale)	Nodular cast iron (with scale)	Hard materials (Roughing)	Hard materials (Finishing)	Hard materials (Chip control)	Sintered steel	IC	S	D1	RE	LE		CBN PVD	CBN -	
F	Sharp edge	F	Sharp edge																K
E	R-honed	E008	R0.08mm honed																
T	Chamfered	T01215	0.12mm x 15° chamfered																-
S	Chamfered and R-honed	S01225	0.12mm x 25° chamfered and R-honed																
Insert	Description	Edge preparation type	No. of edges	Dimension (mm)					CBN										
				IC	S	D1	RE	LE	PVD					-					
		CPGB 080204T00815ME	T00815	2	7.94	2.38	3.5	0.4	1.9	●	●	●				●	●		F64 F65
		CPGB 090302T00815ME	T00815	2	9.525	3.18	4.5	0.2	1.9	●	●	●				●	●		
		090304T00815ME						0.4	1.9	●	●	●				●	●		
		090308T00815ME						0.8	2.5							●	●		
	 General purpose	CPGB 090304S01225MES	S01225	2	9.525	3.18	4.5	0.4	1.9	●	●								
		090308S01225MES						0.8	2.5	●	●								
	 Tough	CPGB 080204S01035MET	S01035	2	7.94	2.38	3.5	0.4	1.9	●		●							
		080208S01035MET						0.8	2.2	●		●							
		CPGB 090304S01035MET	S01035	2	9.525	3.18	4.5	0.4	1.9	●	●	●							
		090308S01035MET						0.8	2.5	●	●	●							
		CPGB 080202T00815SE	T00815	1	7.94	2.38	3.5	0.2	1.9								●	●	
		080204T00815SE						0.4									●	●	
		CPGB 090302T00815SE	T00815	1	9.525	3.18	4.5	0.2	1.9								●	●	
		090304T00815SE						0.4									●	●	



CBN & PCD Tools

● : Standard item R : Right-hand only L : Left-hand only □ : Check availability

CBN & PCD Inserts are sold in 1 piece boxes

55° Rhombic

How to read pages of "Turning inserts" See page B15

Cutting edge preparation				Gray cast iron (with scale)												Gray cast iron (without scale)												K																							
Symbol	Specification	Example		Nodular cast iron (with scale)												Hard materials (Roughing)												Hard materials (Finishing)												H											
F	Sharp edge	F	Sharp edge	Hard materials (Chip control)												Sintered steel												-																							
E	R-honed	E008	R0.08mm honed	Sintered steel												Sintered steel												-																							
T	Chamfered	T01215	0.12mm × 15° chamfered	Sintered steel												Sintered steel												-																							
S	Chamfered and R-honed	S01225	0.12mm × 25° chamfered and R-honed	Sintered steel												Sintered steel												-																							

Insert	Description	Edge preparation type	No. of edges	Dimension (mm)					CBN										Applicable toolholder					
				IC	S	D1	RE	LE	PVD					-										
									KBN020	KBN05M	KBN10M	KBN25M	KBN35M	KBN60M	KBN70M	KBN475	KBN510	KBN525		KBN570				
	DCMW 11T304MEF 11T308MEF	F	2	9.525	3.97	4.4	0.4	1.7																E23, E29~E32, E34 E35, E55, E56 F66~F68 F70~F72 F74~F76, F123
	DCMW 070202T00815ME 070204T00815ME 070208T00815ME	T00815	2	6.35	2.38	2.8	0.2	1.9	•	•	•	•	•	•									E29, E31, E34 E35, E55, E56 F66~F68 F70~F72 F74~F76	
	DCMW 11T302T00815ME 11T304T00815ME 11T308T00815ME 11T312T00815ME	T00815	2	9.525	3.97	4.4	0.2	1.9	•	•	•	•	•	•	•								E23, E29~E32, E34 E35, E55, E56 F66~F68 F70~F72 F74~F76, F123	
	DCMW 11T302S01225MES 11T304S01225MES 11T308S01225MES	S01225	2	9.525	3.97	4.4	0.2	1.9	•	•													E23, E29~E32, E34 E35, E55, E56 F66~F68 F70~F72 F74~F76, F123	
	DCMW 070202S01035MET 070204S01035MET 070208S01035MET	S01035	2	6.35	2.38	2.8	0.2	1.9	•	•	•												E29, E31, E34 E35, E55, E56 F66~F68 F70~F72 F74~F76	
	DCMW 11T302S01035MET 11T304S01035MET 11T308S01035MET 11T312S01035MET	S01035	2	9.525	3.97	4.4	0.2	1.9	•	•	•	•											E23, E29~E32, E34 E35, E55, E56 F66~F68 F70~F72 F74~F76, F123	
	DCMW 070202T00815SE 070204T00815SE	T00815	1	6.35	2.38	2.8	0.2	1.9			•												E29, E31, E34 E35, E55, E56 F66~F68 F70~F72 F74~F76	
	DCMW 11T302T00815SE 11T304T00815SE	T00815	1	9.525	3.97	4.4	0.2	1.9															E23, E29~E32, E34 E35, E55, E56 F66~F68 F70~F72 F74~F76, F123	
	DCMW 070204S01035SET	S01035	1	6.35	2.38	2.8	0.4	1.7															E29, E31, E34 E35, E55, E56 F66~F68 F70~F72 F74~F76	
	DCMW 11T302S01035SET 11T304S01035SET	S01035	1	9.525	3.97	4.4	0.2	1.9															E23, E29~E32, E34 E35, E55, E56 F66~F68 F70~F72 F74~F76, F123	

● : Standard item R : Right-hand only L : Left-hand only □ : Check availability

CBN & PCD Inserts are sold in 1 piece boxes

60° Triangle

How to read pages of "Turning inserts" See page B15

Cutting edge preparation				Material/Preparation													K	
Symbol	Specification	Example															H	
F	Sharp edge	F	Sharp edge															
E	R-honed	E008	R0.08mm honed															
T	Chamfered	T01215	0.12mm x 15° chamfered															
S	Chamfered and R-honed	S01225	0.12mm x 25° chamfered and R-honed															
				Hard materials (Roughing)													H	
				Hard materials (Finishing)														
				Hard materials (Chip control)														
				Sintered steel													-	
Insert	Description	Edge preparation type	No. of edges	Dimension (mm)					CBN							Applicable toolholder		
				IC	S	D1	RE	LE	PVD			-						
								KBN020	KBN05M	KBN10M	KBN25M	KBN35M	KBN60M	KBN475	KBN510	KBN525	KBN570	
	TPGB 110304MEF 110308MEF	F	3	6.35	3.18	3.5	0.4 0.8	2.1 1.8										E39 F80~F82 F84, F85
	TPGB 110302T00815ME 110304T00815ME 110308T00815ME	T00815	3	6.35	3.18	3.5	0.2 0.4 0.8	2.3 2.1 1.8	●	●	●	●	●	●	●	●	●	E39 F80~F82 F84, F85
	TPGB 160304T00815ME 160308T00815ME	T00815	3	9.525	3.18	4.5	0.4 0.8	1.8 1.5	●	●	●	●	●	●	●	●	●	F80~F82 F84
	TPGB 110304S01225MES 110308S01225MES	S01225	3	6.35	3.18	3.5	0.4 0.8	2.1 1.8	●	●	●	●	●	●	●	●	●	E39 F80~F82 F84, F85
	TPGB 110302S01035MET 110304S01035MET 110308S01035MET	S01035	3	6.35	3.18	3.5	0.2 0.4 0.8	2.3 2.1 1.8	●	●	●	●	●	●	●	●	●	E39 F80~F82 F84, F85
	TPGB 160304S01035MET 160308S01035MET	S01035	3	9.525	3.18	4.5	0.4 0.8	1.8 1.5	●	●	●	●	●	●	●	●	●	F80~F82 F84
	TPGB 080202T00815SE 080204T00815SE	T00815	1	4.76	2.38	2.5	0.2 0.4	1.8 1.6		●	●	●	●	●	●	●	●	E39 F80~F82, F86
	TPGB 090202T00815SE 090204T00815SE	T00815	1	5.56	2.38	3	0.2 0.4	1.8 1.6	●	●	●	●	●	●	●	●	●	F33, F34 F80~F82, F86
	TPGB 110302T00815SE 110304T00815SE 110308T00815SE	T00815	1	6.35	3.18	3.5	0.2 0.4 0.8	1.9 1.8 1.5	●	●	●	●	●	●	●	●	●	E39 F80~F82 F84, F85
	TPGB 160302T00815SE 160304T00815SE	T00815	1	9.525	3.18	4.5	0.2 0.4	1.9 1.8	●	●	●	●	●	●	●	●	●	F80~F82 F84
	TPGB 080202S01035SET 080204S01035SET	S01035	1	4.76	2.38	2.5	0.2 0.4	1.8 1.6		●	●	●	●	●	●	●	●	E39 F80~F82, F86
	TPGB 090202S01035SET 090204S01035SET	S01035	1	5.56	2.38	3	0.2 0.4	1.8 1.6	●	●	●	●	●	●	●	●	●	F33, F34 F80~F82, F86
	TPGB 110304S01035SET 110308S01035SET	S01035	1	6.35	3.18	3.5	0.4 0.8	1.8 1.5	●	●	●	●	●	●	●	●	●	E39, F80~F82 F84, F85
	TPGB 160304S01035SET	S01035	1	9.525	3.18	4.5	0.4	1.8	●	●	●	●	●	●	●	●	●	F80~F82 F84

● : Standard item R : Right-hand only L : Left-hand only □ : Check availability

CBN & PCD Inserts are sold in 1 piece boxes



CBN & PCD Tools

60° Triangle

How to read pages of "Turning inserts" See page B15

Cutting edge preparation				Material										Applicable toolholder
Symbol	Specification	Example												K
F	Sharp edge	F	Sharp edge											
E	R-honed	E008	R0.08mm honed											H
T	Chamfered	T01215	0.12mm x 15° chamfered											
S	Chamfered and R-honed	S01225	0.12mm x 25° chamfered and R-honed											-
				Sintered steel										-
Insert	Description	Edge preparation type	No. of edges	Dimension (mm)					CBN			Applicable toolholder		
				IC	S	D1	RE	LE	PVD					
									KBN020	KBN10M	KBN25M			
	TPGW 160404T00815ME 160408T00815ME	T00815	3	9.525	4.76	4.4	0.4 0.8	1.8 1.5		●				
	TPGW 160404S01035MET 160408S01035MET Tough	S01035	3	9.525	4.76	4.4	0.4 0.8	1.8 1.5	●	●	●			
	TPGW 160404T00815SE	T00815	1	9.525	4.76	4.4	0.4	1.8				●		









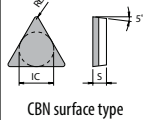

CBN & PCD Tools
 CBN
 PCD
 Positive
 C
 D
 S
 T
 V
 W
 Solid
 Grooving

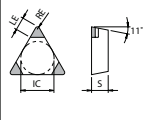
● : Standard item R : Right-hand only L : Left-hand only □ : Check availability

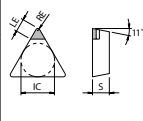
CBN & PCD Inserts are sold in 1 piece boxes

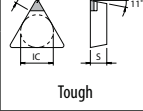
60° Triangle

How to read pages of "Turning inserts" ➔ See page B15

Cutting edge preparation				Material										Applicable toolholder
Symbol	Specification	Example												K
F	Sharp edge	F	Sharp edge											
E	R-honed	E008	R0.08mm honed											H
T	Chamfered	T01215	0.12mm x 15° chamfered											
S	Chamfered and R-honed	S01225	0.12mm x 25° chamfered and R-honed											
				Sintered steel										-
Insert	Description	Edge preparation type	No. of edges	Dimension (mm)				CBN			Applicable toolholder			
				IC	S	RE	LE	PVD	-					
	 CBN surface type	TBGN	060102T00815 060104T00815 060108T00815	T00815	3	3.97	1.59	0.2 0.4 0.8	-				-	
		TPGN	110304T00815ME	T00815	3	6.35	3.18	0.4	2.5				●	
		TPGN	110304T00815SE	T00815	1	6.35	3.18	0.4	2.5				●	
		TPGN	160302T00815SE 160304T00815SE 160308T00815SE	T00815	1	9.525	3.18	0.2 0.4 0.8	2.6 2.4 2.1				● ● ●	
	 Tough	TPGN	110304S01035SET	S01035	1	6.35	3.18	0.4	2.5				●	
		TPGN	160304S01035SET	S01035	1	9.525	3.18	0.4	2.4				●	



CBN & PCD Tools

● : Standard item R : Right-hand only L : Left-hand only □ : Check availability

CBN & PCD Inserts are sold in 1 piece boxes

35° Rhombic

How to read pages of "Turning inserts" See page B15

Cutting edge preparation			Material compatibility										Applicable toolholder									
Symbol	Specification	Example	Gray cast iron (with scale)	Gray cast iron (without scale)	Nodular cast iron (with scale)	Hard materials (Roughing)	Hard materials (Finishing)	Hard materials (Chip control)	Sintered steel	C												
Insert	Description	Edge preparation type	No. of edges	Dimension (mm)					CBN													
				IC	S	D1	RE	LE	PVD					-								
										KBN020	KBN05M	KBN10M	KBN25M	KBN35M	KBN60M	KBN70M	KBN475	KBN510	KBN525	KBN570		
	VBGW 110304MEF 110308MEF	F	2	6.35	3.18	2.8	0.4 0.8	2 1.7									●	●			E40~E43, E58 F90, F91 F94~F99	
	VBGW 160404MEF 160408MEF	F	2	9.525	4.76	4.4	0.4 0.8	2 1.7									●	●			E41~E43 F90, F91 F94~F99	
	VBGW 110302T00815ME 110304T00815ME 110308T00815ME	T00815	2	6.35	3.18	2.8	0.2 0.4 0.8	2.4 2 1.7	●	●	●	●	●	●	●	●	●	●	●	●	E40~E43, E58 F90, F91 F94~F99	
	VBGW 160402T00815ME 160404T00815ME 160408T00815ME	T00815	2	9.525	4.76	4.4	0.2 0.4 0.8	2.4 2 1.7	●	●	●	●	●	●	●	●	●	●	●	●	E41~E43 F90, F91 F94~F99	
	VBGW 110304S01225MES 110308S01225MES	S01225	2	6.35	3.18	2.8	0.4 0.8	2 1.7	●	●							●	●			E40~E43, E58 F90, F91 F94~F99	
	VBGW 160404S01225MES 160408S01225MES	S01225	2	9.525	4.76	4.4	0.4 0.8	2 1.7	●	●							●	●			E41~E43 F90, F91 F94~F99	
	VBGW 110302S01035MET 110304S01035MET 110308S01035MET	S01035	2	6.35	3.18	2.8	0.2 0.4 0.8	2.4 2 1.7	●	●	●	●	●	●	●	●		●			E40~E43, E58 F90, F91 F94~F99	
	VBGW 160402S01035MET 160404S01035MET 160408S01035MET	S01035	2	9.525	4.76	4.4	0.2 0.4 0.8	2.4 2 1.7	●	●	●	●	●	●	●	●		●			E41~E43 F90, F91 F94~F99	
	VBGW 110302T00815SE 110304T00815SE	T00815	1	6.35	3.18	2.8	0.2 0.4	2.8 2.4			●	●					●	●			E40~E43, E58 F90, F91 F94~F99	
	VBGW 160402T00815SE 160404T00815SE 160408T00815SE	T00815	1	9.525	4.76	4.4	0.2 0.4 0.8	2.4 2 1.7			●						●	●	●	●	E41~E43 F90, F91 F94~F99	
	VBGW 110304S01035SET 110308S01035SET	S01035	1	6.35	3.18	2.8	0.4 0.8	2 1.7				●						●			E40~E43, E58 F90, F91 F94~F99	
	VBGW 160404S01035SET 160408S01035SET	S01035	1	9.525	4.76	4.4	0.4 0.8	2 1.7										●	●		E41~E43 F90, F91 F94~F99	

● : Standard item R : Right-hand only L : Left-hand only □ : Check availability

CBN & PCD Inserts are sold in 1 piece boxes

C

CBN & PCD Tools

CBN

PCD

Positive

C

D

S

T

V

W

Solid

Grooving

35° Rhombic

How to read pages of "Turning inserts" See page B15

Cutting edge preparation				Material compatibility										K	
Symbol	Specification	Example													
F	Sharp edge	F	Sharp edge												
E	R-honed	E008	R0.08mm honed												
T	Chamfered	T01215	0.12mm × 15° chamfered												
S	Chamfered and R-honed	S01225	0.12mm × 25° chamfered and R-honed												
				Gray cast iron (with scale)										K	
				Gray cast iron (without scale)											
				Nodular cast iron (with scale)											
				Hard materials (Roughing)										H	
				Hard materials (Finishing)											
				Hard materials (Chip control)											
				Sintered steel											
Insert	Description	Edge preparation type	No. of edges	Dimension (mm)					CBN						Applicable toolholder
				IC	S	D1	RE	LE	PVD			-			
									KBN020	KBN05M	KBN10M	KBN25M	KBN60M	KBN475	
	 VCGW 080202T00815ME 080204T00815ME 080208T00815ME	T00815	2	4.76	2.38	2.3	0.2 0.4 0.8	2 2 1.7	● ● ●	● ● ●	● ● ●	● ● ●	● ● ●	E59 F90, F91 F94~F99	
	 VCGW 080202S01035MET 080204S01035MET 080208S01035MET Tough	S01035	2	4.76	2.38	2.3	0.2 0.4 0.8	2 2 1.7	● ● ●	● ● ●	● ● ●	● ● ●			
	 VCGW 080202T00815SE 080204T00815SE	T00815	1	4.76	2.38	2.3	0.2 0.4	2.4 2	● ●	● ●	● ●	● ●	● ●		
	 VCGW 080204S01035SET 080208S01035SET Tough	S01035	1	4.76	2.38	2.3	0.4 0.8	2 1.8				● ●			





CBN & PCD Tools

● : Standard item R : Right-hand only L : Left-hand only □ : Check availability

CBN & PCD Inserts are sold in 1 piece boxes

80° Trigon

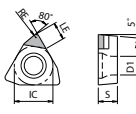
How to read pages of "Turning inserts" See page B15

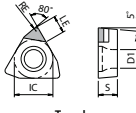
Cutting edge preparation				Material										Applicable toolholder
Symbol	Specification	Example												K
F	Sharp edge	F	Sharp edge											
E	R-honed	E008	R0.08mm honed											H
T	Chamfered	T01215	0.12mm × 15° chamfered											
S	Chamfered and R-honed	S01225	0.12mm × 25° chamfered and R-honed											
				Sintered steel										
Insert	Description	Edge preparation type	No. of edges	Dimension (mm)					CBN			Applicable toolholder		
				IC	S	D1	RE	LE	PVD	-				
 	WBGW 060102T00815L-SE 060104T00815L-SE	T00815	1	3.97	1.59	2.3	0.2 0.4	1.9	●	●	●	F36 F100~F102		
	WBGW 080202T00815L-SE 080204T00815L-SE	T00815	1	4.76	2.38	2.3	0.2 0.4	2.3	●	●	●			
  <p>Tough</p>	WBGW 060102S01035LSET 060104S01035LSET	S01035	1	3.97	1.59	2.3	0.2 0.4	1.9	●	●	●			
	WBGW 080202S01035LSET 080204S01035LSET	S01035	1	4.76	2.38	2.3	0.2 0.4	2.3	●	●	●			

- C
- CBN & PCD Tools
- CBN
- PCD
- Positive
- C
- D
- S
- T
- V
- W
- Solid
- Grooving

● : Standard item R : Right-hand only L : Left-hand only □ : Check availability

CBN & PCD Inserts are sold in 1 piece boxes

GBA

How to read pages of "Turning inserts" See page B15

Cutting edge preparation																K		
Symbol	Specification	Example																
F	Sharp edge	F	Sharp edge															
E	R-honed	E008	R0.08mm honed															
T	Chamfered	T01215	0.12mm x 15° chamfered															
S	Chamfered and R-honed	S01225	0.12mm x 25° chamfered and R-honed															
				Hard materials (Roughing)												H		
				Hard materials (Finishing)														
				Hard materials (Chip control)														
				Sintered steel												-		
Insert	Description	Edge preparation type	No. of edges	Dimension (mm)								Tolerance		CBN		Applicable toolholder		
				CW	CDX	IC	S	D1	RE	LE	CW min.	CW max.	KBN510	KBN525				
	GBA43R 125-020 150-020 200-020 250-020 300-020	E008	1	1.25	2													G13~G17 G89
				1.5	3.5						-0.03	+0.03	●	●				
				2	3.5								●	●				
				2.5	4	12.7	4.76	5.5	0.2	1.9			●	●				
				3	4								●	●				
	GBA43L 125-020 150-020 200-020 250-020 300-020	1.25	2															
		1.5	3.5						-0.03	+0.03	●	●						
		2	3.5								●	●						
		2.5	4								●	●						
		3	4								●	●						

Right-hand shown
CDX shows available grooving depth.



CBN & PCD Tools

● : Standard item R : Right-hand only L : Left-hand only □ : Check availability

CBN & PCD Inserts are sold in 1 piece boxes

GDGS

How to read pages of "Turning inserts" See page B15

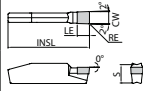
Cutting edge preparation														K	
Symbol	Specification	Example												H	
F	Sharp edge	F	Sharp edge												
E	R-honed	E008	R0.08mm honed												
T	Chamfered	T01215	0.12mm x 15° chamfered												
S	Chamfered and R-honed	S01225	0.12mm x 25° chamfered and R-honed												
				Hard materials (Roughing)											
				Hard materials (Finishing)											
				Hard materials (Chip control)											
				Sintered steel										-	
Insert	Description	Edge preparation type	No. of edges	Dimension (mm)					Tolerance		CBN		Applicable toolholder		
				CW	S	RE	INSL	LE	CW min.	CW max.	PVD	-			
  External Grooving	GDGS 2020N-020NB	E008	1	2	4.3	0.2	20	2.9	-0.03	+0.03	●	-	G34~G42		
		E002									●	-			
	GDGS 3020N-040NB	E008	1	3	4.3	0.4	20	2.9	-0.03	+0.03	●	-	G34~G42		
		E002									●	-			
	GDGS 4020N-040NB	E008	1	4	4.3	0.4	20	2.9	-0.03	+0.03	●	-	G34~G42		
		E002									●	-			
	GDGS 5020N-040NB	E008	1	5	4.3	0.4	20	2.9	-0.03	+0.03	●	-	G34 G40~G42		
		E002									●	-			
	GDGS 6020N-040NB	E008	1	6	4.3	0.4	20	2.9	-0.03	+0.03	●	-	G34 G40~G42		



 CBN & PCD Tools



 CBN



 PCD



 Positive



 C



 D



 S



 T



 V



 W

 Solid





 Grooving

● : Standard item R : Right-hand only L : Left-hand only □ : Check availability

CBN & PCD Inserts are sold in 1 piece boxes

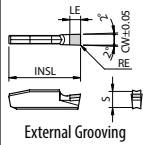
GMN

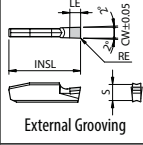
How to read pages of "Turning inserts" See page B15

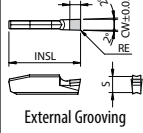
Cutting edge preparation														K	
Symbol	Specification	Example												H	
F	Sharp edge	F	Sharp edge												
E	R-honed	E008	R0.08mm honed												
T	Chamfered	T01215	0.12mm x 15° chamfered												
S	Chamfered and R-honed	S01225	0.12mm x 25° chamfered and R-honed												
				Hard materials (Roughing)											
				Hard materials (Finishing)											
				Hard materials (Chip control)											
				Sintered steel											
Insert	Description	Edge preparation type	No. of edges	Dimension (mm)					Tolerance		CBN		Applicable toolholder		
				CW	S	RE	INSL	LE	CW min.	CW max.	KBN510	KBN525			
	 External Grooving	GMN 2	E008	1	2	4.3	0.2	20	2.9	-0.05	+0.05	●	●	G55 G57	
	 External Grooving	GMN 3	E008	1	3	4.3	0.4	20	2.9	-0.05	+0.05	●	●	G55~G58	
	 External Grooving	GMN 4	E008	1	4	4.3	0.4	20	2.9	-0.05	+0.05	●	●		



● : Standard item R : Right-hand only L : Left-hand only □ : Check availability

CBN & PCD Inserts are sold in 1 piece boxes

EZB-NB (Boring)

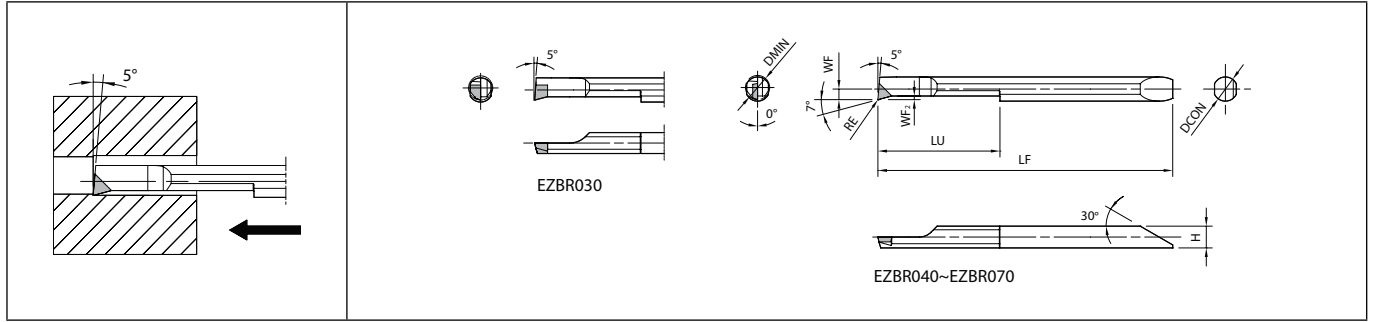

Right-hand shown

Dimensions

How to read pages of "Turning inserts" See page B15

Cutting edge preparation				Material										Tolerance (mm)		Applicable sleeve	
Symbol	Specification	Example												CBN	PVD	F38~F43	
F	Sharp edge	F	Sharp edge	Gray cast iron (with scale)										●		K	
E	R-honed	E008	R0.08mm honed	Gray cast iron (without scale)												K	
T	Chamfered	T01215	0.12mm x 15° chamfered	Nodular cast iron (with scale)												K	
S	Chamfered and R-honed	S01225	0.12mm x 25° chamfered and R-honed	Hard materials (Roughing)										●		H	
				Hard materials (Finishing)												H	
				Hard materials (Chip control)												H	
				Sintered steel												-	
Description	Edge preparation type	No. of edges	Dimension (mm)									Tolerance (mm)		CBN	PVD	Applicable sleeve F38~F43	
			DMIN	DCON	H	LF	LU	WF	WF ₂	RE	RE min.	RE max.					
EZBR 030030-003NB	T00815	1	3	3	2.6	38.8	13	1.25	0.3	0.035	-0.015	+0.015	●		EZH030...		
EZBR 040040-003NB	T00815	1	4	4	3.6	48.8	20	1.75	0.5	0.035	-0.015	+0.015	●		EZH040...		
EZBR 050050-003NB	T00815	1	5	5	4.6	58.1	25	2.25	0.5	0.035	-0.015	+0.015	●		EZH050...		
EZBR 060060-003NB	T00815	1	6	6	5.6	66.1	30	2.75	0.5	0.035	-0.015	+0.015	●		EZH060...		
EZBR 070070-003NB	T00815	1	7	7	6.6	74.1	35	3.25	0.5	0.035	-0.015	+0.015	●		EZH070...		

●: Standard item R: Right-hand only L: Left-hand only □: Check availability

CBN & PCD Inserts are sold in 1 piece boxes

CBN & PCD Tools

CBN

PCD

Positive

C

D

S

T

V

W

Solid

Grooving

Identification system (Turning insert / PCD)

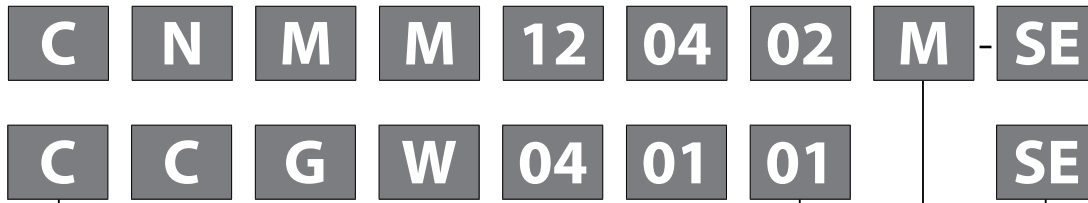

Turning Indexable Inserts Identification System [See B2](#)

Insert type	Description	Manufacture's option 1	Manufacture's option 2	Series name	Edge length	Number of edges	Re-grinding
Negative	CNMM120402M-SE	M (Indicates the tool is for negative inserts/toolholders)	SE	Small edge	Short (Small edge)	1	Not recommended
	CNMM120402M-NE		NE	New value edge	Long (85% length compared with no Indication's cutting edge)	1	Possible
	CNMM120402M		Without indication	-	Long	1	
Positive	CCGW040101SE	-	SE	Small edge	Short (Small edge)	1	Not recommended
	CCGW040101NE		NE	New value edge	Long (85% length compared with no Indication's cutting edge)	1	Possible
	CCGW040101		Without indication	-	Long	1	

- No edge preparation symbols for PCD inserts. Most of the PCD inserts' edge prep. are sharp edge.
- "M" in manufacturer's option 1 indicates the inserts are applicable to negative toolholders.

About re-grinding:

- Re-grinding is possible with the inserts with "NE" and no symbol in manufacturer's option 2.
- Re-grinding can not be available depending on the edge condition.
- Re-grinding is not recommended for inserts with "SE" in manufacturer's option 2.

Application map

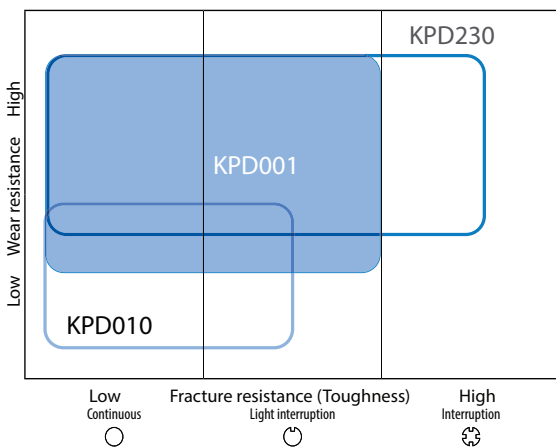

Grades	Applications	Features
KPD001 Average grain size under 0.5 μm	<ul style="list-style-type: none"> • High speed machining of non-ferrous metals and brass • High speed machining of plastics • Machining of carbide 	<ul style="list-style-type: none"> • The world highest level micro-grain diamond • High edge strength, and superior to wear resistance, fracture resistance and edge sharpening performance
KPD010 Average grain size 10 μm	<ul style="list-style-type: none"> • High speed machining of non-ferrous metals and brass • High speed machining of plastics • Machining of carbide 	<ul style="list-style-type: none"> • Good balance of wear resistance and flexural strength • General purpose
KPD230 Mixture of fine grain with average grain size 2~30 μm and coarse grain	<ul style="list-style-type: none"> • High speed machining of non-ferrous metals and brass • High speed machining of plastics 	<ul style="list-style-type: none"> • High density PCD with mixture of coarse and fine grains features excellent abrasive wear resistance and fracture resistance
KPD250 Average grain size 25 μm Made to order	<ul style="list-style-type: none"> • High speed machining of high silicon aluminium alloy • Machining of carbide 	<ul style="list-style-type: none"> • Coarse grain PCD • Ave. grain size 25 μm • Superior to wear resistance

Recommended cutting conditions

Workpiece material	Insert grades		Cutting conditions				Remarks
	KPD001	KPD010	Vc (m/min)	ap (mm)		f (mm/rev)	
				Small edge and positive inserts	Negative inserts		
Aluminum alloys Zinc alloys	●	○	300 ~ 1,500	~1.0	~2.0	0.03 ~ 0.5	Both: Dry and coolant
Copper, Brass, Bronze	●	○	300 ~ 1,000	~1.0	~2.0	0.03 ~ 0.5	
Magnesium alloys	●	○	400 ~ 1,200	~1.0	~2.0	0.03 ~ 0.5	
Carbide	●	○	10 ~ 30	~0.3	~0.3	0.03 ~ 0.1	
Titanium alloys	●	○	100 ~ 200	~1.0	~2.0	0.05 ~ 0.2	Coolant
Glass fiber reinforced plastics Carbon fiber	●	○	100 ~ 600	~1.0	~2.0	0.05 ~ 0.5	Dry
Silica filling plastic Particle board	●	○	400 ~ 800	~1.0	~2.0	0.05 ~ 0.5	

●: 1st Recommendation ○: 2nd Recommendation

80° Rhombic

How to read pages of "Turning inserts" See page B15

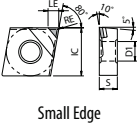
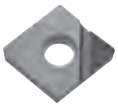
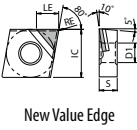
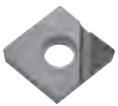
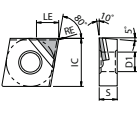
Cutting edge preparation			Non-ferrous metals (with interruption)		Non-ferrous metals (without interruption)		Titanium alloys (with interruption)		Titanium alloys (without interruption)		PCD		Applicable toolholder
			●	●	●	●	●	●	●	●	●	●	
PCD all items	F	Sharp edge											
Insert	Description	Edge preparation type	No. of edges	Dimension (mm)					PCD				
				IC	S	D1	RE	LE	KP001	KP010			
	 Small Edge CNMM 120402M-SE 120404M-SE 120408M-SE	F	1	12.7	4.76	5.16	0.2 0.4 0.8	2.8 2.8 2.7	●● ●● ●●		D8~D10 F116 F125 F126		
	 New Value Edge CNMM 120402M-NE 120404M-NE 120408M-NE	F	1	12.7	4.76	5.16	0.2 0.4 0.8	5.1 5 4.9	● ● ●				
	 CNMM 120402M 120404M 120408M 120412M	F	1	12.7	4.76	5.16	0.2 0.4 0.8 1.2	5.8 5.8 5.7 5.6	●● ●● ●● ●●				

C

CBN & PCD Tools

CBN

PCD

Negative

C

D

S

T

V

W

Solid

Grooving

● : Standard item R : Right-hand only L : Left-hand only □ : Check availability

CBN & PCD Inserts are sold in 1 piece boxes

55° Rhombic

How to read pages of "Turning inserts" See page B15

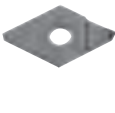
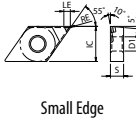
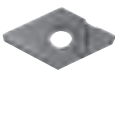
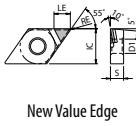
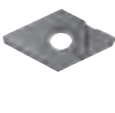
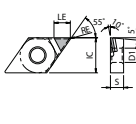
Cutting edge preparation			Non-ferrous metals (with interruption)		Non-ferrous metals (without interruption)		Titanium alloys (with interruption)		Titanium alloys (without interruption)		PCD		Applicable toolholder
			PCD all items	F	Sharp edge	●	●	●	●	●	●	●	
Insert	Description	Edge preparation type	No. of edges	Dimension (mm)					PCD		Applicable toolholder		
				IC	S	D1	RE	LE	KP001	KP010			
	 Small Edge DNMM 150402M-SE 150404M-SE 150408M-SE	F	1	12.7	4.76	5.16	0.2 0.4 0.8	2.8 2.6 2.2	● ● ●	● ● ●	D13~D17 F118, F130 F132~F134		
	 New Value Edge DNMM 150402M-NE 150404M-NE 150408M-NE	F	1	12.7	4.76	5.16	0.2 0.4 0.8	5.2 5 4.6	● ● ●	● ● ●			
	 DNMM 150402M 150404M 150408M	F	1	12.7	4.76	5.16	0.2 0.4 0.8	5.9 5.8 5.4	● ● ●	● ● ●			



CBN & PCD Tools

● : Standard item R : Right-hand only L : Left-hand only □ : Check availability

CBN & PCD Inserts are sold in 1 piece boxes

60° Triangle

How to read pages of "Turning inserts" See page B15

Cutting edge preparation					Non-ferrous metals (with interruption)					●		N	
PCD all items			F		Non-ferrous metals (without interruption)					●			
Sharp edge					Titanium alloys (with interruption)					●		S	
					Titanium alloys (without interruption)					●			
Insert	Description	Edge preparation type	No. of edges	Dimension (mm)					PCD	Applicable toolholder			
				IC	S	D1	RE	LE					
				KPD001						KPD010			
	<p>Small Edge</p>	TNMM	160402M-SE 160404M-SE 160408M-SE	F	1	9.525	4.76	3.81	0.2 0.4 0.8	2.7 2.6 2.3	●● ●● ●●	D22~D25 D27, D28 F120 F137 F138	
	<p>New Value Edge</p>	TNMM	160402M-NE 160404M-NE 160408M-NE	F	1	9.525	4.76	3.81	0.2 0.4 0.8	3.2 3.1 2.8	● ● ●		
		TNMM	160402M 160404M 160408M 160412M	F	1	9.525	4.76	3.81	0.2 0.4 0.8 1.2	3.8 3.6 3.3 3	●● ●● ●● ●		

C

CBN & PCD Tools

CBN

PCD

Negative

C

D

S

T

V

W

Solid

Grooving

● : Standard item R : Right-hand only L : Left-hand only □ : Check availability

CBN & PCD Inserts are sold in 1 piece boxes

35° Rhombic

How to read pages of "Turning inserts" See page B15

Cutting edge preparation					Non-ferrous metals (with interruption)					●		N
					Non-ferrous metals (without interruption)					●		
PCD all items	F	Sharp edge			Titanium alloys (with interruption)					●		S
					Titanium alloys (without interruption)					●		
Insert	Description	Edge preparation type	No. of edges	Dimension (mm)					PCD	Applicable toolholder		
				IC	S	D1	RE	LE			KP001 KP010	
	VNMM 160402M-SE 160404M-SE 160408M-SE Small Edge	F	1	9.525	4.76	3.81	0.2 0.4 0.8	2.9 2.5 1.6	● ● ● ● ● ●	D30~D39		
	VNMM 160402M-NE 160404M-NE 160408M-NE Value Edge New	F	1	9.525	4.76	3.81	0.2 0.4 0.8	4.7 4.2 3.4	● ● ● ● ● ●			
	VNMM 160402M 160404M 160408M	F	1	9.525	4.76	3.81	0.2 0.4 0.8	5.3 4.8 4	● ● ● ● ● ●			



● : Standard item R : Right-hand only L : Left-hand only □ : Check availability

CBN & PCD Inserts are sold in 1 piece boxes

80° Trigon

How to read pages of "Turning inserts" See page B15

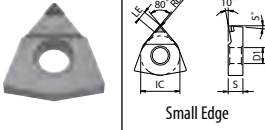
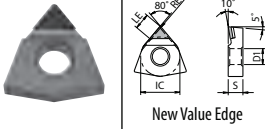
Cutting edge preparation			Non-ferrous metals (with interruption)					Non-ferrous metals (without interruption)		Titanium alloys (with interruption)		Titanium alloys (without interruption)		N	
PCD all items	F	Sharp edge												S	
Insert	Description	Edge preparation type	No. of edges	Dimension (mm)					PCD	Applicable toolholder					
				IC	S	D1	RE	LE							
										KPD001	KPD010				
	WNMM 080402M-SE 080404M-SE 080408M-SE	F	1	12.7	4.76	5.16	0.2 0.4 0.8	2.8 2.8 2.7	● ● ●	● ● ●	D43~D46 F140 F142 F143				
	WNMM 080402M-NE 080404M-NE	F	1	12.7	4.76	5.16	0.2 0.4	5	● ●	● ●					

C

CBN & PCD Tools

CBN

PCD

Negative Positive

C

D

S

T

V

W

Solid



Grooving

● : Standard item R : Right-hand only L : Left-hand only □ : Check availability

CBN & PCD Inserts are sold in 1 piece boxes

80° Rhombic

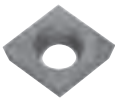
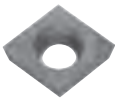
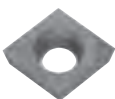
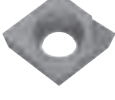
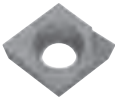
How to read pages of "Turning inserts" See page B15

Cutting edge preparation			Non-ferrous metals (with interruption)							N	
PCD all items			Non-ferrous metals (without interruption)							S	
F			Titanium alloys (with interruption)							S	
Sharp edge			Titanium alloys (without interruption)							S	
Insert	Description	Edge preparation type	No. of edges	Dimension (mm)					PCD	Applicable toolholder	
				IC	S	D1	RE	LE			
● : Standard item R : Right-hand only L : Left-hand only □ : Check availability											
	CCGW 040101SE 040102SE 040104SE	F	1	4.3	1.8	2.3	0.1 0.2 0.4	1.3	● ● ●	F31, F32 F60, F62	
	CCGW 060201SE 060202SE 060204SE	F	1	6.35	2.38	2.8	0.1 0.2 0.4	2.3	● ● ●	E26, E28, E54 F31, F32 F60~F62	
	CCGW 09T302SE 09T304SE 09T308SE	F	1	9.525	3.97	4.4	0.2 0.4 0.8	2.7	● ● ●	E26~E28, E54 F60~F62 F122	
	CCGW 040101NE 040102NE	F	1	4.3	1.8	2.3	0.1 0.2	1.7 1.6	● ●	F31, F32 F60, F62	
	CCGW 060201NE 060202NE 060204NE	F	1	6.35	2.38	2.8	0.1 0.2 0.4	3.1 3 3	● ● ●	E26, E28, E54 F31, F32 F60~F62	
	CCGW 09T301NE 09T302NE 09T304NE 09T308NE	F	1	9.525	3.97	4.4	0.1 0.2 0.4 0.8	3.4 3.4 3.4 3.3	● ● ● ●	E26~E28, E54 F60~F62 F122	
	CCGW 040101 040102 040104	F	1	4.3	1.8	2.3	0.1 0.2 0.4	1.9	● ● ●	F31, F32 F60, F62	
	CCGW 060201 060202 060204	F	1	6.35	2.38	2.8	0.1 0.2 0.4	3.5	● ● ●	E26, E28, E54 F31, F32 F60~F62	
	CCGW 09T301 09T302 09T304 09T308	F	1	9.525	3.97	4.4	0.1 0.2 0.4 0.8	3.8 3.8 3.7 3.6	● ● ● ●	E26~E28, E54 F60~F62 F122	
	CCMT 060202SE 060204SE	F	1	6.35	2.38	2.8	0.2 0.4	2.2	● ●	E26, E28, E54 F31, F32 F60~F62	
	CCMT 09T301SE 09T302SE 09T304SE 09T308SE	F	1	9.525	3.97	4.4	0.1 0.2 0.4 0.8	2.7	● ● ● ●	E26~E28, E54 F60~F62 F122	
	CCMT 060201NE 060202NE 060204NE	F	1	6.35	2.38	2.8	0.1 0.2 0.4	2.8	● ● ●	E26, E28, E54 F31, F32 F60~F62	
	CCMT 09T301NE 09T302NE 09T304NE 09T308NE	F	1	9.525	3.97	4.4	0.1 0.2 0.4 0.8	3.4 3.4 3.4 3.3	● ● ● ●	E26~E28, E54 F60~F62 F122	
	CCMT 060201 060202 060204	F	1	6.35	2.38	2.8	0.1 0.2 0.4	3.3 3.3 3.2	● ● ●	E26, E28, E54 F31, F32 F60~F62	
	CCMT 09T301 09T302 09T304 09T308	F	1	9.525	3.97	4.4	0.1 0.2 0.4 0.8	3.9 3.9 3.9 3.8	● ● ● ●	E26~E28, E54 F60~F62 F122	



CBN & PCD Inserts are sold in 1 piece boxes

80° Rhombic

How to read pages of "Turning inserts" See page B15

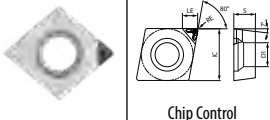
Cutting edge preparation								Non-ferrous metals (with interruption)		●		N	
PCD all items			F					Sharp edge		●		Non-ferrous metals (without interruption)	
								Titanium alloys (with interruption)		●		S	
								Titanium alloys (without interruption)		●			
Insert	Description	Edge preparation type	No. of edges	Dimension (mm)					PCD	Applicable toolholder			
				IC	S	D1	RE	LE					
	CCMT 09T302APD 09T304APD 09T308APD	F	1	9.525	3.97	4.4	0.2 0.4 0.8	2.7	KPD001	● E26~E28, E54 ● F60~F62 ● F122			

C

CBN & PCD Tools

CBN

PCD

Positive

C

D

S

T

V

W

Solid

Grooving

● : Standard item R : Right-hand only L : Left-hand only □ : Check availability

CBN & PCD Inserts are sold in 1 piece boxes

80° Rhombic

How to read pages of "Turning inserts" See page B15

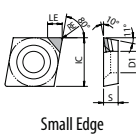
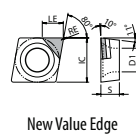
Cutting edge preparation			Non-ferrous metals (with interruption)										N	
			Non-ferrous metals (without interruption)										S	
PCD all items			Titanium alloys (with interruption)										S	
F			Titanium alloys (without interruption)										S	
Sharp edge														
Insert	Description	Edge preparation type	No. of edges	Dimension (mm)					PCD	Applicable toolholder				
				IC	S	D1	RE	LE						
										KPD001	KPD010			
	CPMH 090302SE 090304SE	F	1	9.525	3.18	4.5	0.2 0.4	2.7	●	●	F64 F65			
	CPMH 080202NE 080204NE	F	1	7.94	2.38	3.5	0.2 0.4	3.2	●	●				
	CPMH 090301NE 090302NE 090304NE 090308NE	F	1	9.525	3.18	4.5	0.1 0.2 0.4 0.8	3.4 3.4 3.4 3.3	●	●				
	CPMH 080201 080202 080204	F	1	7.94	2.38	3.5	0.1 0.2 0.4	3.7	●	●				
	CPMH 090301 090302 090304 090308	F	1	9.525	3.18	4.5	0.1 0.2 0.4 0.8	4 3.9 3.9 3.8	●	●				
										●		●		



● : Standard item R : Right-hand only L : Left-hand only □ : Check availability

CBN & PCD Inserts are sold in 1 piece boxes

55° Rhombic

How to read pages of "Turning inserts" See page B15

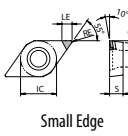
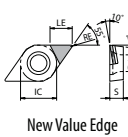
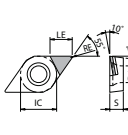
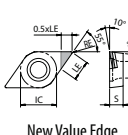
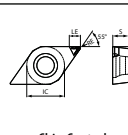
Cutting edge preparation			Non-ferrous metals (with interruption)					N		
PCD all items			Non-ferrous metals (without interruption)					S		
F			Titanium alloys (with interruption)					S		
Sharp edge			Titanium alloys (without interruption)					S		
Insert	Description	Edge preparation type	No. of edges	Dimension (mm)					PCD	Applicable toolholder
				IC	S	D1	RE	LE		
KPD001 KPD010										
	DCMT 070201SE 070202SE 070204SE	F	1	6.35	2.38	2.8	0.1 0.2 0.4	2.7	● ● ●	E29, E31, E34 E35, E55, E56 F66~F68 F70~F72 F74~F76
	DCMT 11T301SE 11T302SE 11T304SE 11T308SE	F	1	9.525	3.97	4.4	0.1 0.2 0.4 0.8	2.7	● ● ● ●	E23, E29~E32, E34 E35, E55, E56 F66~F68 F70~F72 F74~F76, F123
	DCMT 070201NE 070202NE 070204NE	F	1	6.35	2.38	2.8	0.1 0.2 0.4	3.4 3.4 3.2	● ● ●	E29, E31, E34 E35, E55, E56 F66~F68 F70~F72 F74~F76
	DCMT 11T301NE 11T302NE 11T304NE 11T308NE	F	1	9.525	3.97	4.4	0.1 0.2 0.4 0.8	3.4 3.3 3.2 2.8	● ● ● ●	E23, E29~E32, E34 E35, E55, E56 F66~F68 F70~F72 F74~F76, F123
	DCMT 070201 070202 070204	F	1	6.35	2.38	2.8	0.1 0.2 0.4	4 3.9 3.7	● ● ● ●	E29, E31, E34 E35, E55, E56 F66~F68 F70~F72 F74~F76
	DCMT 11T301 11T302 11T304 11T308	F	1	9.525	3.97	4.4	0.1 0.2 0.4 0.8	4 3.9 3.7 3.3	● ● ● ● ●	E23, E29~E32, E34 E35, E55, E56 F66~F68 F70~F72 F74~F76, F123
	DCMT 070202R-NE 070202L-NE 070204R-NE 070204L-NE	F	1	6.35	2.38	2.8	0.2 0.2 0.4 0.4	3.3 3.3 3.2 3.2	● ● ● ●	E29, E31, E34 E35, E55, E56 F66~F68 F70~F72 F74~F76
	DCMT 11T302R-NE 11T302L-NE 11T304R-NE 11T304L-NE	F	1	9.525	3.97	4.4	0.2 0.2 0.4 0.4	3.3 3.3 3.2 3.2	● ● ● ●	E23, E29~E32, E34 E35, E55, E56 F66~F68 F70~F72 F74~F76, F123
	DCMT 11T302APD 11T304APD 11T308APD	F	1	9.525	3.97	4.4	0.2 0.4 0.8	2.7	● ● ●	E23, E29~E32, E34 E35, E55, E56 F66~F68 F70~F72 F74~F76, F123

● : Standard item R : Right-hand only L : Left-hand only □ : Check availability

CBN & PCD Inserts are sold in 1 piece boxes

C

CBN & PCD Tools

CBN

PCD

Positive

C

D

S

T

V



W

Solid

Grooving

90° Square

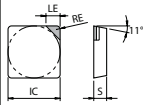
How to read pages of "Turning inserts" See page B15

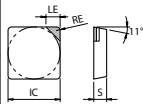
Cutting edge preparation			Non-ferrous metals (with interruption)				Non-ferrous metals (without interruption)		Titanium alloys (with interruption)		Titanium alloys (without interruption)		N	
PCD all items	F	Sharp edge	Titanium alloys (with interruption)				Titanium alloys (without interruption)		S		S		S	
Insert	Description	Edge preparation type	No. of edges	Dimension (mm)				PCD	Applicable toolholder					
				IC	S	RE	LE							
				KPD001										
		SPGN	120304NE	F	1	12.7	3.18	0.4	3.6	●	F112			
		SPGN	120304	F	1	12.7	3.18	0.4	4.2	●				





CBN & PCD Tools

● : Standard item R : Right-hand only L : Left-hand only □ : Check availability

CBN & PCD Inserts are sold in 1 piece boxes

60° Triangle

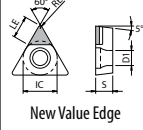
How to read pages of "Turning inserts" See page B15

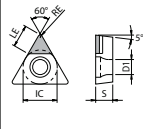
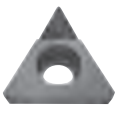
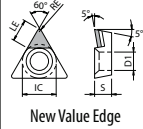
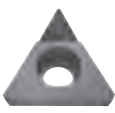
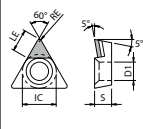
Cutting edge preparation					Non-ferrous metals (with interruption)					●		N	
PCD all items			F		Non-ferrous metals (without interruption)					●			
Sharp edge					Titanium alloys (with interruption)					●		S	
					Titanium alloys (without interruption)					●			
Insert	Description	Edge preparation type	No. of edges	Dimension (mm)					PCD	Applicable toolholder			
				IC	S	D1	RE	LE					
										KPD001	KPD010		
	 New Value Edge	TBGW	060102NE 060104NE	F	1	3.97	1.59	2.4	0.2 0.4	2.1 1.9	●	●	F33, F34 F80~F82 F86, F87
		TBGW	060102 060104	F	1	3.97	1.59	2.4	0.2 0.4	2.4 2.2	●	●	
	 New Value Edge	TBMT	060101NE 060102NE 060104NE 060108NE	F	1	3.97	1.59	2.4	0.1 0.2 0.4 0.8	2.2 2.1 2 1.7	●	●	
		TBMT	060102 060104 060108	F	1	3.97	1.59	2.4	0.2 0.4 0.8	2.5 2.3 2	●	●	

C

CBN & PCD Tools

CBN

PCD

Positive

C

D

S

T

V

W

Solid







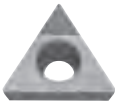
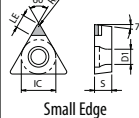

Grooving

● : Standard item R : Right-hand only L : Left-hand only □ : Check availability

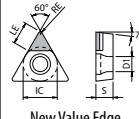
CBN & PCD Inserts are sold in 1 piece boxes

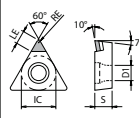
60° Triangle

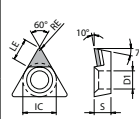
How to read pages of "Turning inserts" See page B15

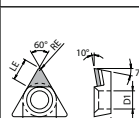
Cutting edge preparation			Non-ferrous metals (with interruption)		Non-ferrous metals (without interruption)		Titanium alloys (with interruption)		Titanium alloys (without interruption)		N	
											PCD all items	F
Insert	Description	Edge preparation type	No. of edges	Dimension (mm)					PCD	Applicable toolholder		
				IC	S	D1	RE	LE				
											KP001	KP010
	 Small Edge	TCGW	110302SE 110304SE	F	1	6.35	3.18	2.8	0.2 0.4	2.5 2.4	● ●	E38
	 New Value Edge	TCGW	110302NE 110304NE	F	1	6.35	3.18	2.8	0.2 0.4	3.3 3.2	● ●	
	 Small Edge	TCMT	110301SE 110302SE 110304SE	F	1	6.35	3.18	2.8	0.1 0.2 0.4	2.6 2.5 2.4	● ● ●	
	 New Value Edge	TCMT	080202NE	F	1	4.76	2.38	2.5	0.2	2.1	●	
		TCMT	110302NE	F	1	6.35	3.18	2.8	0.2	3.4	●	
	 Small Edge	TCMT	080202 080204	F	1	4.76	2.38	2.5	0.2 0.4	2.4 2.2	● ●	



● : Standard item R : Right-hand only L : Left-hand only □ : Check availability

CBN & PCD Inserts are sold in 1 piece boxes

60° Triangle

How to read pages of "Turning inserts" See page B15

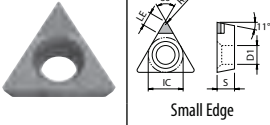
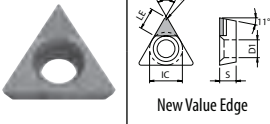
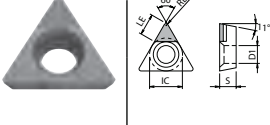
Cutting edge preparation		Non-ferrous metals (with interruption)		Non-ferrous metals (without interruption)		Titanium alloys (with interruption)		Titanium alloys (without interruption)		N	
		PCD all items	F	Sharp edge							S
Insert	Description	Edge preparation type	No. of edges	Dimension (mm)					PCD	Applicable toolholder	
				IC	S	D1	RE	LE			
										KPD001 KPD010	
	TPGB 090202SE 090204SE 090208SE	F	1	5.56	2.38	3.2	0.2 0.4 0.8	2.1	● ● ●	F33, F34 F80~F82, F86	
	TPGB 110301SE 110302SE 110304SE	F	1	6.35	3.18	3.3	0.1 0.2 0.4	2.7 2.6 2.5	●● ●● ●●	E39 F80~F82 F84, F85	
	TPGB 160302SE 160304SE	F	1	9.525	3.18	4.7	0.2 0.4	2.6 2.4	●● ●●	F80~F82 F84	
	TPGB 080202NE 080204NE 080208NE	F	1	4.76	2.38	2.3	0.2 0.4 0.8	2.2 2.1 1.8	● ● ●	E39 F80~F82, F86	
	TPGB 090202NE 090204NE	F	1	5.56	2.38	3.2	0.2 0.4	2.7 2.6	● ●	F33, F34 F80~F82, F86	
	TPGB 110302NE 110304NE 110308NE	F	1	6.35	3.18	3.3	0.2 0.4 0.8	3.4 3.3 3	● ●● ●●	E39 F80~F82 F84, F85	
	TPGB 160304NE 160308NE	F	1	9.525	3.18	4.7	0.4 0.8	3.2 2.9	● ●	F80~F82 F84	
	TPGB 080202 080204	F	1	4.76	2.38	2.3	0.2 0.4	2.6 2.4	●● ●●	E39 F80~F82, F86	
	TPGB 090202 090204	F	1	5.56	2.38	3.2	0.2 0.4	3.2 3	● ●●	F33, F34 F80~F82, F86	
	TPGB 110302 110304 110308	F	1	6.35	3.18	3.3	0.2 0.4 0.8	3.9 3.7 3.4	●● ●● ●	E39 F80~F82 F84, F85	

C

CBN & PCD Tools

CBN

PCD

Positive

C

D

S

T

V

W

Solid







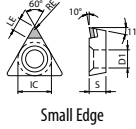

Grooving

● : Standard item R : Right-hand only L : Left-hand only □ : Check availability

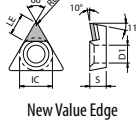
CBN & PCD Inserts are sold in 1 piece boxes

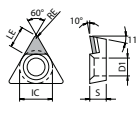
60° Triangle

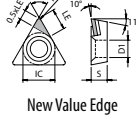
How to read pages of "Turning inserts" See page B15

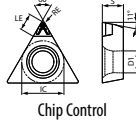
Cutting edge preparation			Non-ferrous metals (with interruption)							●		N
			Non-ferrous metals (without interruption)							●		
PCD all items			F							●		S
Sharp edge			●							●		
Insert	Description	Edge preparation type	No. of edges	Dimension (mm)					PCD	Applicable toolholder		
				IC	S	D1	RE	LE				
										KPD001	KPD010	
  Small Edge	TPMH 080202SE 080204SE	F	1	4.76	2.38	2.3	0.2 0.4	2 1.8	● ●	E39 F80~F82, F86		
	TPMH 090202SE 090204SE	F	1	5.56	2.38	3.2	0.2 0.4	2.4 2.2	● ●	F33, F34 F80~F82, F86		
	TPMH 110301SE 110302SE 110304SE	F	1	6.35	3.18	3.3	0.1 0.2 0.4	2.7 2.6 2.5	● ● ●	E39 F80~F82 F84, F85		
	TPMH 160302SE 160304SE	F	1	9.525	3.18	4.7	0.2 0.4	2.6 2.4	● ●	F80~F82 F84		
  New Value Edge	TPMH 080201NE 080202NE 080204NE	F	1	4.76	2.38	2.3	0.1 0.2 0.4	2.3 2.2 2.1	● ● ●	E39 F80~F82, F86		
	TPMH 090201NE 090202NE 090204NE 090208NE	F	1	5.56	2.38	3.2	0.1 0.2 0.4 0.8	2.7 2.6 2.5 2.2	● ● ● ●	F33, F34 F80~F82, F86		
	TPMH 110301NE 110302NE 110304NE 110308NE	F	1	6.35	3.18	3.3	0.1 0.2 0.4 0.8	3.4 3.3 3.2 2.9	● ● ● ●	E39 F80~F82 F84, F85		
	TPMH 160304NE 160308NE	F	1	9.525	3.18	4.7	0.4 0.8	3.3 3	● ●	F80~F82 F84		
 	TPMH 080202 080204	F	1	4.76	2.38	2.3	0.2 0.4	2.5 2.3	● ●	E39 F80~F82, F86		
	TPMH 090201 090202 090204	F	1	5.56	2.38	3.2	0.1 0.2 0.4	3 2.9 2.8	● ● ●	F33, F34 F80~F82, F86		
	TPMH 110301 110302 110304 110308	F	1	6.35	3.18	3.3	0.1 0.2 0.4 0.8	3.9 3.9 3.7 3.4	● ● ● ●	E39 F80~F82 F84, F85		
	TPMH 160302 160304 160308	F	1	9.525	3.18	4.7	0.2 0.4 0.8	4 3.8 3.6	● ● ●			
  New Value Edge	TPMH 110302L-NE 110304L-NE	F	1	6.35	3.18	3.3	0.2 0.4	3.8 3.6	● ●	E39 F80~F82 F84, F85		
  Chip Control	TPMT 110302APD 110304APD 110308APD	F	1	6.35	3.18	3.3	0.2 0.4 0.8	2.6 2.5 2.5	● ● ●	E39 F80~F82 F84, F85		





● : Standard item R : Right-hand only L : Left-hand only □ : Check availability

CBN & PCD Inserts are sold in 1 piece boxes

60° Triangle

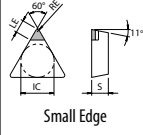
How to read pages of "Turning inserts" See page B15

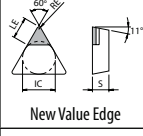
Cutting edge preparation					Non-ferrous metals (with interruption)				●		N	
PCD all items			F		Non-ferrous metals (without interruption)				●			
Sharp edge					Titanium alloys (with interruption)				●		S	
					Titanium alloys (without interruption)				●			
Insert	Description	Edge preparation type	No. of edges	Dimension (mm)				PCD	Applicable toolholder			
				IC	S	RE	LE					
								KPD001 KPD010				
  <p>Small Edge</p>	TPGN 110301SE 110302SE 110304SE	F	1	6.35	3.18	0.1 0.2 0.4	2.6 2.5 2.4	● ● ●	F113			
	TPGN 160301SE 160302SE 160304SE	F	1	9.525	3.18	0.1 0.2 0.4	2.6 2.6 2.4	● ● ●				
	TPGN 160304NE 160308NE	F	1	9.525	3.18	0.4 0.8	3.2 2.9	● ●				
  <p>New Value Edge</p>	TPGN 110302 110304	F	1	6.35	3.18	0.2 0.4	3.9 3.7	● ●				
	TPGN 160304 160308	F	1	9.525	3.18	0.4 0.8	3.7 3.4	● ●				

C

CBN & PCD Tools

CBN

PCD

Positive

C

D

S

T

V

W

Solid





Grooving

● : Standard item R : Right-hand only L : Left-hand only □ : Check availability

CBN & PCD Inserts are sold in 1 piece boxes

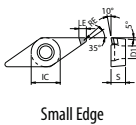
35° Rhombic

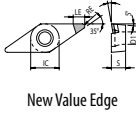
How to read pages of "Turning inserts" See page B15

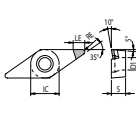
Cutting edge preparation			Non-ferrous metals (with interruption)		Non-ferrous metals (without interruption)		Titanium alloys (with interruption)		Titanium alloys (without interruption)		N		S	
			PCD all items	F	Sharp edge									
Insert	Description	Edge preparation type	No. of edges	Dimension (mm)					PCD	Applicable toolholder				
				IC	S	D1	RE	LE						
										KPD001	KPD010			
  Small Edge	VBMT 110301SE	F	1	6.35	3.18	2.8	0.1	2.5	●	E40~E43 E58 F90, F91 F94~F99				
	110302SE						0.2	2.3	●					
	110304SE						0.4	1.9	●					
	110308SE						0.8	1.9	●					
	VBMT 160401SE	F	1	9.525	4.76	4.4	0.1	2.7	●	E41~E43 F90, F91 F94~F99				
	160402SE						0.2	2.5	●					
	160404SE						0.4	2.1	●					
	160408SE						0.8	2	●					
  New Value Edge	VBMT 110301NE	F	1	6.35	3.18	2.8	0.1	2.6	●	E40~E43 E58 F90, F91 F94~F99				
	110302NE						0.2	2.4	●					
	110304NE						0.4	2	●					
	110308NE						0.8	3.1	●					
	VBMT 160401NE	F	1	9.525	4.76	4.4	0.1	2.8	●	E41~E43 F90, F91 F94~F99				
	160402NE						0.2	2.6	●					
	160404NE						0.4	2.2	●					
	160408NE						0.8	3	●					
 	VBMT 110301	F	1	6.35	3.18	2.8	0.1	3	●●	E40~E43 E58 F90, F91 F94~F99				
	110302						0.2	2.8	●●					
	110304						0.4	2.4	●●					
	110308						0.8	3.5	●●					
	VBMT 160401	F	1	9.525	4.76	4.4	0.1	3.2	●●	E41~E43 F90, F91 F94~F99				
	160402						0.2	3	●●					
	160404						0.4	2.6	●●					
	160408						0.8	3.5	●●					



● : Standard item R : Right-hand only L : Left-hand only □ : Check availability

CBN & PCD Inserts are sold in 1 piece boxes

35° Rhombic

How to read pages of "Turning inserts" See page B15

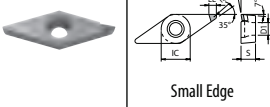
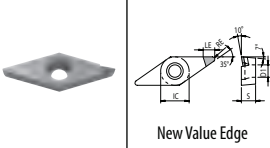
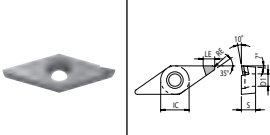
Cutting edge preparation		Non-ferrous metals (with interruption)		Non-ferrous metals (without interruption)		Titanium alloys (with interruption)		Titanium alloys (without interruption)		PCD		Applicable toolholder
		PCD all items	F	Sharp edge								
Insert	Description	Edge preparation type	No. of edges	Dimension (mm)					PCD	KPB001 KPB010		
				IC	S	D1	RE	LE				
	VCMT 080202SE 080204SE 080208SE	F	1	4.76	2.38	2.3	0.2 0.4 0.8	1.4	● ● ●		E59 F90, F91 F94~F99	
	VCMT 080201NE 080202NE 080204NE 080208NE	F	1	4.76	2.38	2.3	0.1 0.2 0.4 0.8	1.7 1.7 1.8 1.9	● ● ● ●			
	VCMT 080201 080202 080204 080208	F	1	4.76	2.38	2.3	0.1 0.2 0.4 0.8	2 2 2.1 2.2	● ● ● ●			

C
CBN & PCD Tools

CBN
PCD
Positive

C
D
S
T
V
W

Solid
Grooving

● : Standard item R : Right-hand only L : Left-hand only □ : Check availability

CBN & PCD Inserts are sold in 1 piece boxes

80° Trigon

How to read pages of "Turning inserts" See page B15

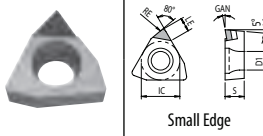
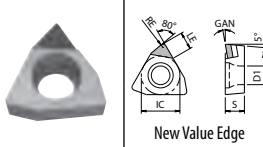
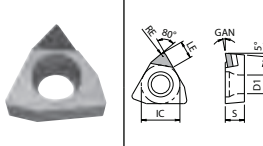
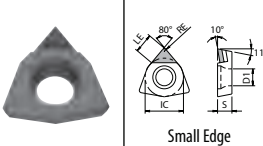
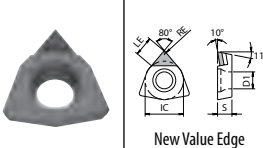
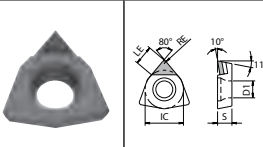
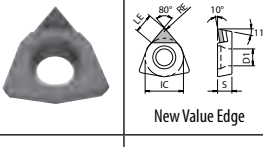
Cutting edge preparation			Non-ferrous metals (with interruption)										●	N		
PCD all items			F	Sharp edge	Non-ferrous metals (without interruption)										●	S
Titanium alloys (with interruption)			●	S	Titanium alloys (without interruption)										●	S
Insert	Description	Edge preparation type	No. of edges	Dimension (mm)					PCD	Applicable toolholder						
				IC	S	D1	RE	LE								
										KPD001	KPD010					
	WBMT 060102L-SE	F	1	3.97	1.59	2.3	0.2	1.3	●	F36 F100~F102						
	WBMT 080202L-SE	F	1	4.76	2.38	2.3	0.2	1.6	●							
	WBMT 060101L-NE	F	1	3.97	1.59	2.3	0.1	1.7	●							
	WBMT 060102L-NE	F	1	3.97	1.59	2.3	0.2	1.6	●							
	WBMT 060104L-NE	F	1	3.97	1.59	2.3	0.4	1.6	●							
	WBMT 080202L-NE	F	1	4.76	2.38	2.3	0.2	2.1	●							
	WBMT 080204L-NE	F	1	4.76	2.38	2.3	0.4	2.1	●							
	WBMT 060101L	F	1	3.97	1.59	2.3	0.1	1.9	●							
	WBMT 060102L	F	1	3.97	1.59	2.3	0.2	1.9	●							
	WBMT 060104L	F	1	3.97	1.59	2.3	0.4	1.9	●							
	WBMT 080202L	F	1	4.76	2.38	2.3	0.2	2.4	●							
	WBMT 080204L	F	1	4.76	2.38	2.3	0.4	2.3	●							
	WPMT 110202SE	F	1	6.35	2.38	2.8	0.2	2.1	●	F100~F102						
	WPMT 110202NE	F	1	6.35	2.38	2.8	0.2	2.7	●							
	WPMT 110202	F	1	6.35	2.38	2.8	0.2	3.1	●							







CBN & PCD Tools

● : Standard item R : Right-hand only L : Left-hand only □ : Check availability

CBN & PCD Inserts are sold in 1 piece boxes

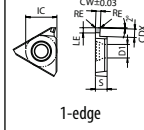
GBA/TGF

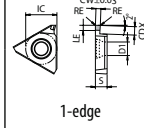
How to read pages of "Turning inserts" See page B15

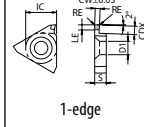
Cutting edge preparation			Non-ferrous metals (with interruption)										N			
PCD all items			F										Sharp edge		S	
Insert	Description	Edge preparation type	No. of edges	Dimension (mm)							Tolerance		PCD	Applicable toolholder		
				CW	CDX	IC	S	D1	RE	LE	CW min.	CW max.			KPD001	KPD010
  1-edge	GBA32R 125-010	F	1	1.25	2	9.525	3.18	4.4	0.1	1.7	-0.03	+0.03	●	●		
	150-010			1.5	2								●	●		
	200-010			2	2.5								●	●		
  1-edge	GBA43R 125-010	F	1	1.25	2	12.7	4.76	5.5	0.1	1.9	-0.03	+0.03	●	●		
	150-010			1.5	3.5								●	●		
	200-010			2	3.5								●	●		
	250-010			2.5	4								●	●		
	300-010			3	4								●	●		
	GBA43L 125-010			1.25	2								●	●		
150-010	1.5	3.5	●	●												
200-010	2	3.5	●	●												
250-010	2.5	4	●	●												
300-010	3	4	●	●												
  1-edge	TGF32R 125-010	F	1	1.25	2	9.525	3.18	4.6	0.1	1.7	-0.03	+0.03	<input type="checkbox"/>	KTGFR....-16		
	150-010			1.5	2								<input type="checkbox"/>	KTGFR....-16F		
	200-010			2	2.5								<input type="checkbox"/>	S...-KTGFL16		

CDX shows available grooving depth.
Right-hand shown

● : Standard item R : Right-hand only L : Left-hand only : Check availability

CBN & PCD Inserts are sold in 1 piece boxes

C

CBN & PCD Tools

CBN

PCD

Positive

C

D

S

T

V

W

Solid

Grooving

GV/GVF

How to read pages of "Turning inserts" See page B15

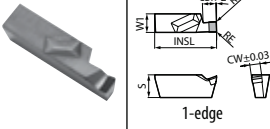
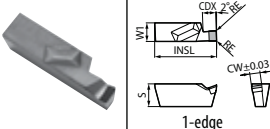
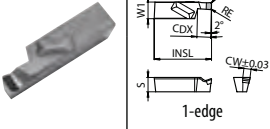
Cutting edge preparation			Non-ferrous metals (with interruption)										N	
PCD all items			Non-ferrous metals (without interruption)										S	
F			Titanium alloys (with interruption)										S	
Sharp edge			Titanium alloys (without interruption)										S	
Insert	Description	Edge preparation type	No. of edges	Dimension (mm)							Tolerance		PCD	Applicable toolholder
				CW	CDX	S	RE	INSL	W1	CW min.	CW max.	KPD010		
	GVR 145-020A 200-020A	F	1	1.45 2	2.3	5	0.2	12	4	-0.03	+0.03	● ●	G86~G88	
	GVR 200-020B 250-020B	F	1	2 2.5	3.2	5.5	0.2	15	4.5	-0.03	+0.03	● ●		
	GVFR 250-020B 300-020B 400-020B	F	1	2.5 3 4	4.8 4.8 5.3	5	0.2	20	5.8	-0.03	+0.03	● ● ●	G127~G130 G133	
	GVFL 250-020B 300-020B 400-020B			2.5 3 4	4.8 4.8 5.3							● ● ●		
	GVFR 350-040C			F	1							3.5		6.8

CDX shows available grooving depth.
Right-hand shown



GDGS

How to read pages of "Turning inserts" See page B15

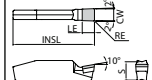
Cutting edge preparation			Non-ferrous metals (with interruption)										●	N	
PCD all items			F	Sharp edge										● <th colspan="1">Non-ferrous metals (without interruption)</th>	Non-ferrous metals (without interruption)
														● <th colspan="1">Titanium alloys (with interruption)</th>	Titanium alloys (with interruption)
														● <th colspan="1">Titanium alloys (without interruption)</th>	Titanium alloys (without interruption)
Insert	Description	Edge preparation type	No. of edges	Dimension (mm)					Tolerance		PCD	Applicable toolholder			
				CW	S	RE	INSL	LE	CW min.	CW max.					
 	GDGS 2020N-020NB	F	1	2	4.3	0.2	20	2.9	-0.03	+0.03	●	G34~G42			
	GDGS 3020N-020NB	F	1	3	4.3	0.2	20	2.9	-0.03	+0.03	●				
	GDGS 4020N-020NB	F	1	4	4.3	0.2	20	2.9	-0.03	+0.03	●				
	GDGS 5020N-020NB	F	1	5	4.3	0.2	20	2.9	-0.03	+0.03	●	G34 G40~G42			
	GDGS 6020N-020NB	F	1	6	4.3	0.2	20	2.9	-0.03	+0.03	●				

C

CBN & PCD Tools

CBN

PCD

Positive

C

D

S

T

V

W

Solid







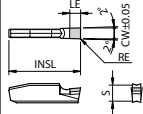

Grooving

● : Standard item R : Right-hand only L : Left-hand only □ : Check availability

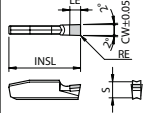
CBN & PCD Inserts are sold in 1 piece boxes

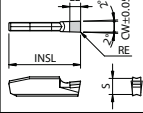
GMN

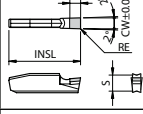
How to read pages of "Turning inserts" See page B15

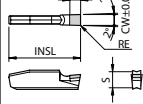
Cutting edge preparation			Non-ferrous metals (with interruption)										N	
PCD all items			Non-ferrous metals (without interruption)										S	
F			Titanium alloys (with interruption)										S	
Sharp edge			Titanium alloys (without interruption)										S	
Insert	Description	Edge preparation type	No. of edges	Dimension (mm)					Tolerance		PCD		Applicable toolholder	
				CW	S	RE	INSL	LE	CW min.	CW max.	KPDD01	KPDD10		
		GMN 2	F	1	2	4.3	0.2	20	2.9	-0.05	+0.05	●	●	G55 G57
		GMN 3	F	1	3	4.3	0.2	20	2.9	-0.05	+0.05	●	●	G55~G58
		GMN 4	F	1	4	4.3	0.2	20	2.9	-0.05	+0.05	●	●	
		GMN 5	F	1	5	4.3	0.2	20	2.9	-0.05	+0.05	●	●	
		GMN 6	F	1	6	4.3	0.2	20	2.9	-0.05	+0.05	●	●	G56 G57



● : Standard item R : Right-hand only L : Left-hand only □ : Check availability

CBN & PCD Inserts are sold in 1 piece boxes

GMGW

How to read pages of "Turning inserts" See page B15

Cutting edge preparation		Non-ferrous metals (with interruption)										●	N
		Non-ferrous metals (without interruption)										●	
GMGW	R-honed	Titanium alloys (with interruption)										●	S
		Titanium alloys (without interruption)										●	
Insert	Description	Edge preparation type	No. of edges	Dimension (mm)					Tolerance		PCD	KPD001	Applicable toolholder
				CW	S	RE	INSL	LE	CW min.	CW max.			
	GMGW 6030-30R	F	1	6	5.5	3	30	4.5	-0.03	+0.03	●	G67	
	GMGW 8030-40R	F	1	8	5.5	4	30	6	-0.03	+0.03	●		
	GMGW 8030-40R-HR	F	1	8	5.5	4	30	5	-0.03	+0.03	●		

GMGW inserts are exclusively used for KGMW toolholder. It cannot be used for other toolholder because of its different installation angle.
 GMGW inserts Edge Preparation : R-honed Cutting Edge.

C

CBN & PCD Tools

CBN

PCD

Positive

C

D

S

T

V

W

Solid





Grooving

● : Standard item R : Right-hand only L : Left-hand only □ : Check availability

CBN & PCD Inserts are sold in 1 piece boxes

TKF

How to read pages of "Turning inserts" See page B15

Cutting edge preparation			Non-ferrous metals (with interruption)														●	N		
PCD all items			F	Sharp edge	Non-ferrous metals (without interruption)														●	N
					Titanium alloys (with interruption)														●	S
					Titanium alloys (without interruption)														●	S
Insert	Description	Edge preparation type	No. of edges	Dimension (mm)										Angle (°)	Tolerance				PCD	Applicable toolholder
				CW	CDX	S	S1	D1	RE	LE	W1	PSIR%	CW min.		CW max.	RE (+/-) min.	RE (+/-) max.			
	TKF12R 200-AGT 250-AGT	F	1	2 2.5	4.8	8.7	8.3	5	0.1	4.2	3	0	-0.03	+0.03	-0.05	0	●	E15 E16		
	TKF12R 200-AS TKF12L 200-AS TKF12R 250-AS	F	1	2 2 2.5	5	8.7	7.3	5	0.1	5.3	3	0	-0.03	+0.03	-0.05	0	●			
	TKF16R 250-AS TKF16L 250-AS	F	1	2.5	8	9.5	8	5	0.1	6.3	4	0	-0.03	+0.03	-0.05	0	●			
	TKF12R 150-NB 200-NB 250-NB	F	1	1.5 2 2.5	3.5 4 4	8.7	8.3	5	0.1	2 3 3	3	0	-0.03	+0.03	-0.05	0	●			

Right-hand shown



● : Standard item R : Right-hand only L : Left-hand only □ : Check availability

CBN & PCD Inserts are sold in 1 piece boxes

EZB-NB (Boring)

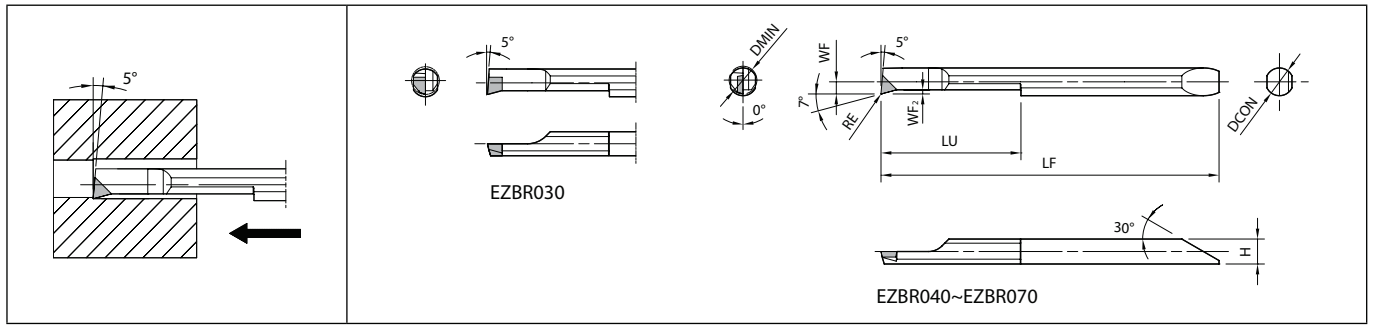

Right-hand shown

Dimensions

How to read pages of "Turning inserts" See page B15

Cutting edge preparation			Non-ferrous metals (with interruption)		●		N						
PCD all items			Non-ferrous metals (without interruption)		●		S						
F			Titanium alloys (with interruption)		●								
Sharp edge			Titanium alloys (without interruption)		●								
Description	No. of edges	Dimension (mm)								Tolerance (mm)		PCD	Applicable sleeve F39 F41 F43
		DMIN	DCON	H	LF	LU	WF	WF ₂	RE	RE min.	RE max.		
EZBR 040040-003NB	1	4	4	3.6	48.8	20	1.75	0.5	0.035	-0.015	+0.015	●	EZH040...
EZBR 050050-003NB	1	5	5	4.6	58.1	25	2.25	0.5	0.035	-0.015	+0.015	●	EZH050...
EZBR 060060-003NB	1	6	6	5.6	66.1	30	2.75	0.5	0.035	-0.015	+0.015	●	EZH060...
EZBR 070070-003NB	1	7	7	6.6	74.1	35	3.25	0.5	0.035	-0.015	+0.015	●	EZH070...

- CBN
- PCD
- Positive
- C
- D
- S
- T
- V
- W
- Solid
- Grooving

● : Standard item R : Right-hand only L : Left-hand only □ : Check availability

CBN & PCD Inserts are sold in 1 piece boxes

VNB-NB (Boring)

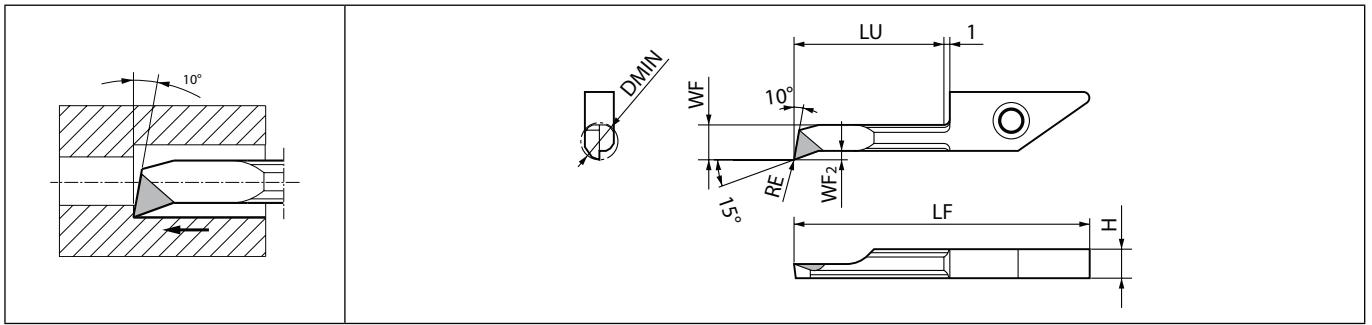

Right-hand shown

Dimensions

How to read pages of "Turning inserts" See page B15

Cutting edge preparation			Dimension (mm)						PCD	Applicable toolholder
PCD all items	F	Sharp edge	DMIN	H	LF	LU	WF	WF ₂	RE	
									●	F48~F51
									●	
									●	
									●	
									●	F48~F51
									●	
									●	
									●	
									●	F48~F51
									●	



● : Standard item R : Right-hand only L : Left-hand only □ : Check availability

CBN & PCD Inserts are sold in 1 piece boxes

VNG

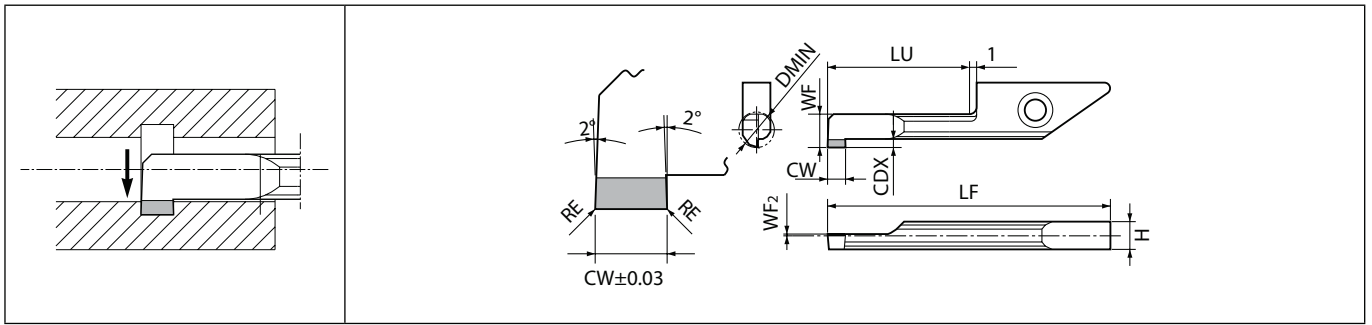

Right-hand shown

Dimensions

How to read pages of "Turning inserts" See page B15

Cutting edge preparation			Non-ferrous metals (with interruption)											●	N		
PCD all items			F	Sharp edge	Non-ferrous metals (without interruption)											●	S
					Titanium alloys (with interruption)											●	
					Titanium alloys (without interruption)											●	
Description	No. of edges	Dimension (mm)											Tolerance (mm)		PCD	Applicable toolholder	
		DMIN	CW	CDX	H	LF	LU	WF	WF ₂	RE	CW min.	CW max.	RPD001				
VNGR 0410-11NB	1	4	1	0.8	3.9	30.8	11	3.5	0.1	0.05	-0.03	+0.03	MTO	F48~F51			
VNGR 0420-11NB			2										MTO				
VNGR 0510-11NB	1	5	1	1	3.9	30.8	11	4.4	0.1	0.05	-0.03	+0.03	MTO				
VNGR 0520-11NB			2										MTO				
VNGR 0720-20NB	1	7	2	2	3.9	39.8	20	6.2	0.3	0.05	-0.03	+0.03	MTO				

CDX shows available grooving depth.

C

CBN & PCD Tools

CBN

PCD

Positive

C

D

S

T

V

W

Solid

Grooving

● : Standard item R : Right-hand only L : Left-hand only □ : Check availability MTO : Made to order

CBN & PCD Inserts are sold in 1 piece boxes

VNFG

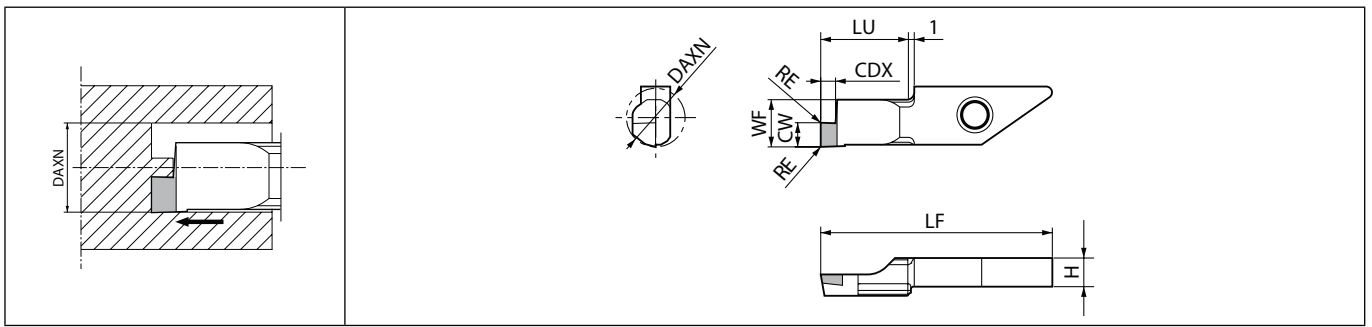

Right-hand shown

Dimensions

How to read pages of "Turning inserts" See page B15

Cutting edge preparation			Non-ferrous metals (with interruption)		Non-ferrous metals (without interruption)		Titanium alloys (with interruption)		Titanium alloys (without interruption)		PCD		Applicable toolholder
PCD all items	F	Sharp edge	●		●		●		●		N		
			●		●		●		●		S		
Description	No. of edges	External dia. of the groove (mm)		Dimension (mm)								IPD001	
		DAXN (min.)	DAXX (max.)	CW	CDX	H	LF	LU	WF	RE			
VNFGR 0830-10NB	1	8 (0)	∞ (∞)	3	3	3.9	29.6	10	7.3	0.05	MT0		F48 F50 F51

CDX shows available grooving depth.

External dia. of the groove DAXN (0) means that you can make the initial groove within DAXN ~ DAXX and then widen it to the center.

Available inserts

How to read pages of "Turning inserts" See page B15

Cutting edge preparation			Non-ferrous metals (with interruption)											Non-ferrous metals (without interruption)			N		
PCD all items			F	Sharp edge	Titanium alloys (with interruption)											Titanium alloys (without interruption)			S
Insert	Description	No. of edges	Dimension (mm)											Angle (°)		PCD			Applicable toolholder
			IC	S	D1	RE	INSL	LE	BCH	BS	W1	AN	AS	KPD001	KPD010	KPD230			
	SDKN 1203AUFN-NE	1	12.7	3.18	-	-	-	3.1	0.5	1.2	-	15	23	●			-		
	SEEN 1203AFFN-NE 1203AFFN	1	12.7	3.18	-	-	-	3 3.5	0.5	1.4	-	20	25	●	●		-		
	TEEN 1603PTFR-NE 1603PTFR	1	9.525	3.18	-	-	-	4.1 4.7	0.6	1.4	-	20	22	●	●		-		
	BDGT 11T302FR 11T304FR 11T308FR	1	-	3.8	2.8	0.2 0.4 0.8	11.5	3.8	-	-	6.7	13	18	●	●	●	M64~M68		
	BDGT 11T302FR-LE 11T304FR-LE 11T308FR-LE	1	-	3.8	2.8	0.2 0.4 0.8	11.5	5.2	-	-	6.7	13	18	●	●	●			
	BDMT 11T302FR 11T304FR	1	-	3.8	2.8	0.2 0.4	11	3.6	-	-	6.7	13	18	●	●	●			
	BDMT 170402FR 170404FR	1	-	4.9	4.4	0.2 0.4	17	4.4	-	-	9.6	13	18	●	●	●	M65~M68		
	NDCW 150302FRX-NE	1	-	3.18	4.4	0.2	15	5.1	-	-	9.525	-	15	●			M149		
NDCW 150302FRX	1	-	3.18	4.4	0.2	15	5.7	-	-	9.525	-	15	●	●					

Handed insert shows Right-hand

● : Standard item R : Right-hand only L : Left-hand only □ : Check availability

CBN & PCD Inserts are sold in 1 piece boxes

C

CBN & PCD Tools

CBN

PCD

Positive

C

D

S

T

V

W

Solid

Grooving

D

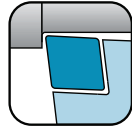

Introduction		D2
Toolholders for general purpose		D8
CN insert	DCLN/DCLN-JCT/PCLN	D8
DN insert	DDJN/DDJN-JCT/DDHN	D13
	PDJN/PDHN	D16
SN insert	DSBN/PSBN	D19
	PSKN/PSSN/PSDN	D20
TN insert	DTGN/PTGN/PTFN	D22
	WTJN/WTKN/WTEN	D27
VN insert	DVLN/DVLN-JCT/DVFN/DVFN-JCT/DVVN/DVVN-JCT	D30
	MVLN/MVFN	D36
	PVLN/PVFN/PVFN	D38
RC insert	PRGC/PRXC	D40
RN insert	PRGN	D42
WN Insert	DWLN/DWLN-JCT/PWLN/WWLN	D43
Toolholders for ceramic inserts		D48
CN insert	CCLN	D49
DN insert	CDJN	D50
EN insert	CELN	D51
SN insert	CSRN/CS-N/CSKN/CSYN/CSSN/CSDN	D52
TN insert	CTJN/CTUN	D56
RN insert	CRSN/CRDN	D58
Toolholders for solid CBN inserts		D60
CNMN insert	CCRN-A/CCLN-A	D60
RNMN insert	CRSN-A/CRDN-A	D61
SNMN insert	CSRN-A/CSKN-A/CSSN-A/CSDN-A	D63
TNMN insert	CTJN-A	D66
Toolholders for bearing machining		D67
RCMT insert	PRGC-BE	D67
SNMF insert	CBSN	D68
Recommended cutting conditions		D69

Great for high pressure coolant

Double Clamp-JCT

D

1 Superior chip control performance

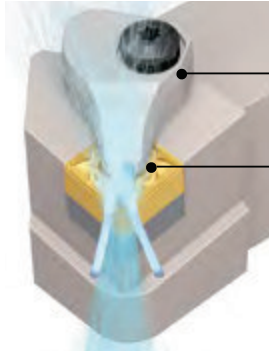

Double Clamp

Firm insert clamp and easy to use in single operations
High-density coolant supply close to the cutting edge

Unique Nozzle Shape

Provides coolant to a wide area of the insert surface

Chip control comparison (Internal Evaluation)

Double Clamp-JCT



Competitor A



Cutting Conditions: $V_c = 150$ m/min, $a_p = 0.5$ mm, Wet, CNMG120408 Type. Workpiece: 15CrMo4 External Turning

2 Longer tool life and high speed machining

Coolant is also directed from two directions towards the flank face of the insert to ensure even cooling action
Longer tool life and high-speed machining with improved wear resistance

Alloy steel (34CrMo4)

After Machining 42.2 min

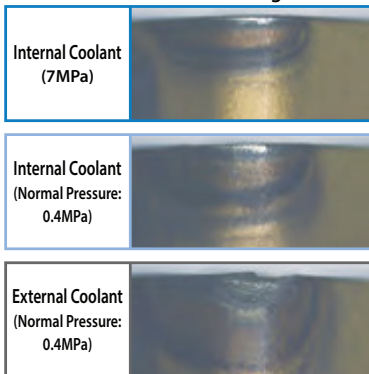

UP
Abrasion Resistance

Heat-resistant alloys (Inconel®718)

After Machining 3 min

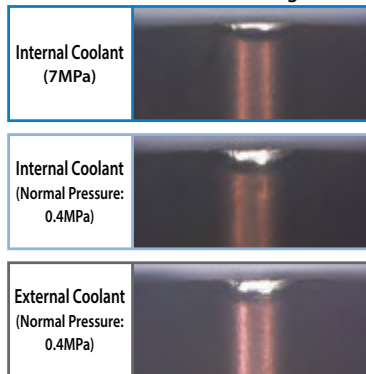

UP
Abrasion Resistance

Cutting Conditions: $V_c = 250$ m/min, $a_p = 2$ mm, $f = 0.3$ mm/rev, Wet, CNMG120408 Type. External Turning

Cutting Conditions: $V_c = 80$ m/min, $a_p = 0.5$ mm, $f = 0.15$ mm/rev, Wet, CNMG120408 Type. External Turning

Using internal coolant improves wear-resistance in alloy steel and heat-resistant alloys
High-pressure coolant is more effective

External turning toolholders identification system (Square shank)

Clamping system	
A	Back clamp
C	Top clamp
D	Double clamp
M	Multi lock
P	Pin lock or lever lock
S	Screw clamp
W	Wedge lock

Insert shape	
C	80° Rhombic
D	55° Rhombic
R	Round
S	90° Square
T	60° Triangle
V	35° Rhombic
W	80° Trigon

Hand of tool	
R	Right-hand
L	Left-hand
N	Neutral

Shank height
Shank height (mm)

Shank width
Shank width (mm)

Manufacturer's option
Optional mark or number

D

C

L

N





R

20

20

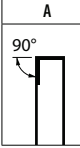
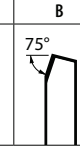
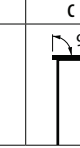
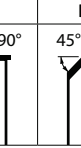
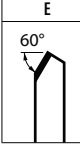
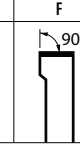
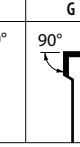
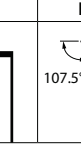
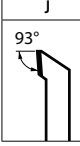
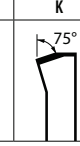
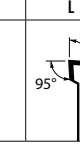
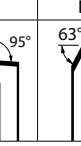
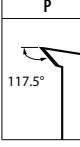
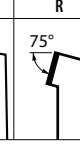

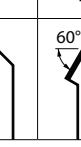
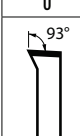
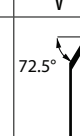

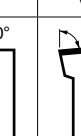

K

- 12

Cutting edge angle			
A 90° 	B 75° 	C 90° 	D 45° 
E 60° 	F 90° 	G 90° 	H 107.5° 
J 93° 	K 75° 	L 95° 	N 63° 
P 117.5° 	R 75° 	S 45° 	T 60° 
U 93° 	V 72.5° 	W 60° 	Y 85° 

Insert relief angle	
	
B	5° Positive
C	7° Positive
D	15° Positive
E	20° Positive
N	0° Negative
P	11° Positive

Toolholder length					
	(mm)				
A	32	J	110	R	200
B	40	JX	120	S	250
C	50	K	125	T	300
D	60	L	140	U	350
E	70	M	150	V	400
F	80	N	160	W	450
G	90	P	170	Y	500
H	100	Q	180	X	Special

Insert size	
	
	
	

External turning

- Specification may change without any prior notice.
- Due to the installation size constraints on the machine, the toolholder length of some products may not match with the symbol.

External Turning Toolholders

	CN..	WN..	TN..	DN..	RC..		RN..	VN..
Applicable Insert Shape								
Applications	External / Facing			External / Facing / Copying				External / Facing / Copying / Undercutting
Cutting Edge Angle	95°			105°	107.5°	Special		117.5°
Lever Lock (Pin Lock)								
See Page	D10	D45		D17	D40	D40	D42	D38
Wedge Lock Multi Lock								
See Page		D46	D27					
Double Clamp (Coolant-through holders)								
See Page	D8/D9	D43 /D44		D15				D32 /D33

Toolholders for Ceramic Tools

Applications	External / Facing			External / Copying		External / Chamfering	External / Facing / Chamfering	
Cutting Edge Angle	95°	97.5°	Special	93°	Special	45°	45°	
Top Clamp								
See Page	D49	D51	D58	D50	D58	D54	D54	

Toolholders for Solid CBN Tools

Applications	External / Facing		External / Copying	External / Chamfering	External / Facing / Chamfering	External		
Cutting Edge Angle	95°	Special	Special	45°	45°	75°		93°
Top Clamp								
See Page	D60	D61	D61	D64	D64	D60	D63	D66

VN..		DN..		SN..	TN..	SN..	SN..	TN..	SN..	TN..
External / Copying		External / Chamfering		External / Facing / Chamfering	External		Facing			
72.5°	95°	93°	45°	60°	45°	75°	91°	15°	-1°	
D39	D38	D16	D21		D20	D19	D24	D20	D25	
D37	D36	D27	D28							
D34 / D35	D30 / D31	D13 / D14				D19	D22 / D23			

External			Facing		
75°	85°	93°	5°	15°	-3°
D52	D52	D56	D53	D53	D56

Toolholders for Bearing Machining

Facing	Applications	External	Applications	Round Chamfering
15°	Cutting Edge Angle	Special	Cutting Edge Angle	Special
	Lever Lock		Top Clamp	
D63	See Page	D67	See Page	D68

Clamping systems

D



External turning

Series	Design	Features
Top clamp (C)		<ul style="list-style-type: none"> • Rigid clamping • Negative Insert: Medium to heavy machining (Mainly for ceramic insert) • Positive Insert: Low cutting force
Double clamp (D)		<ul style="list-style-type: none"> • Firmly clamp the insert in two directions with one action.
Pin lock (P)		<ul style="list-style-type: none"> • Easy insert replacement
Screw clamp (S)		<ul style="list-style-type: none"> • Simple mechanism • Fewer parts • Finishing to medium machining

Series	Design	Features
Multi lock (M)		<ul style="list-style-type: none"> • Combination of top clamp and pin lock • Rigid clamping • Heavy machining
Lever lock (P)		<ul style="list-style-type: none"> • Easy insert replacement • General use
Wedge lock (W)		<ul style="list-style-type: none"> • Rigid clamping • Heavy machining

Lever lock: With shim (left) and without shim (right)

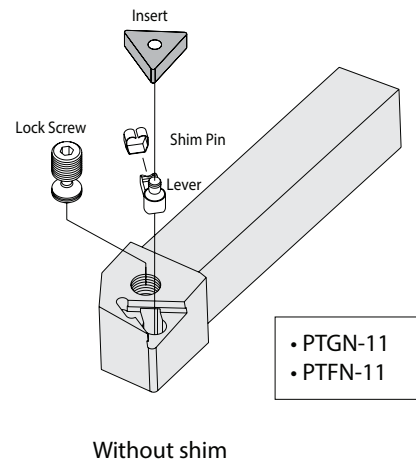
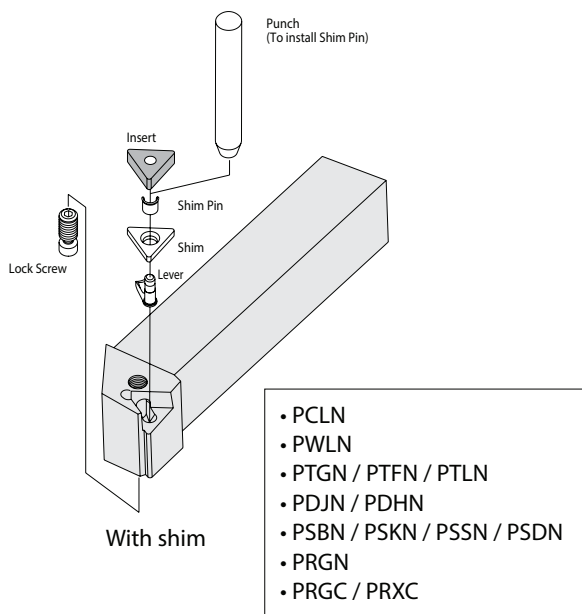

Double clamp

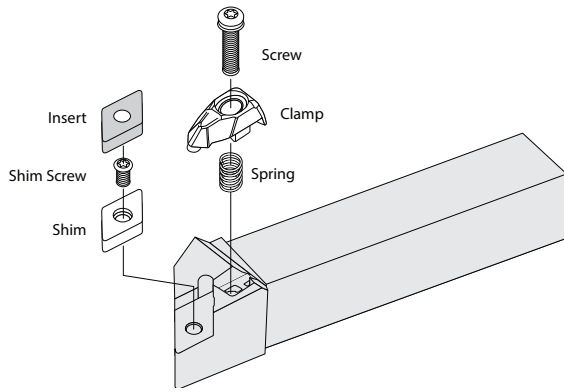

- DCLN
- DDJN / DDHN
- DSBN
- DTGN
- DVLN / DVPN / DVVN
- DWLN

Wedge lock

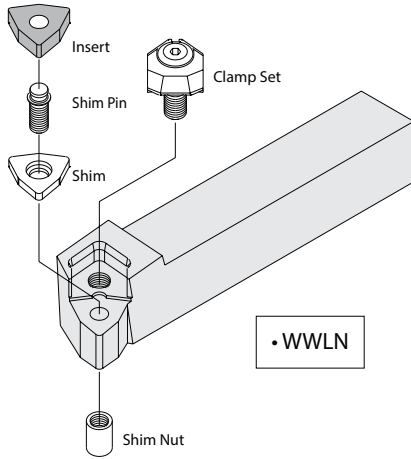

- WWLN

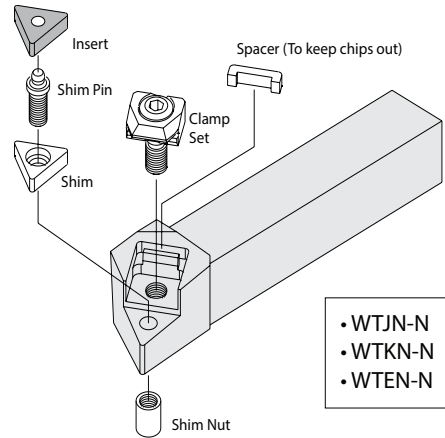

- WTJN-N
- WTKN-N
- WTEN-N

Multi lock

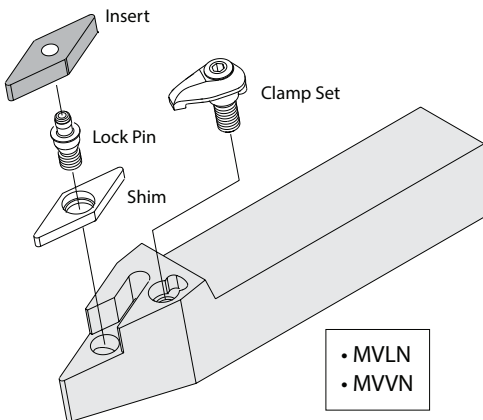

- MVLN
- MVVN

Top clamp

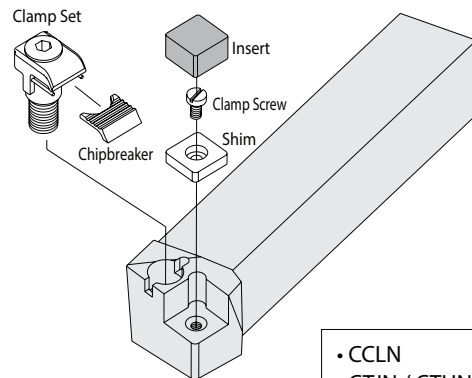

- CCLN
 - CTJN / CTUN
 - CDHN / CDJN
 - CELN
 - CSRN / CS-N / CSKN
 - CSYN / CSSN / CSDN
 - *CRSN / *CRDN
- *Chipbreaker is not included



External turning



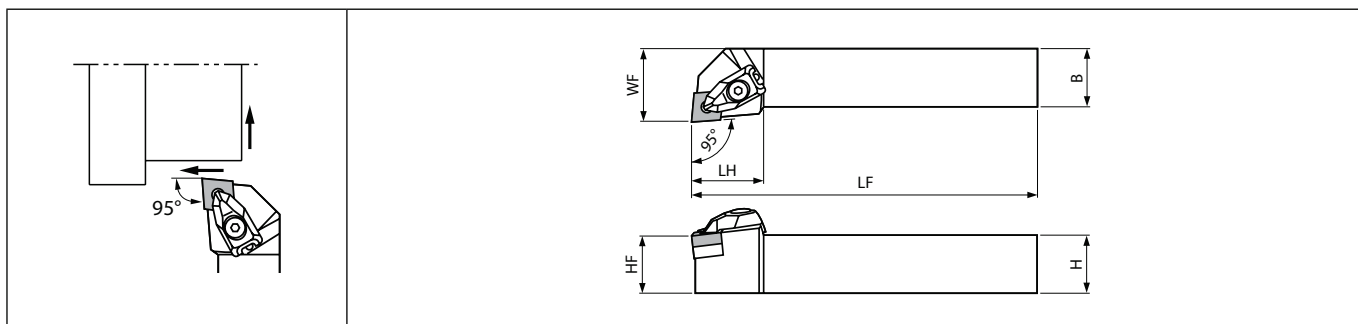











DCLN (External turning / External facing)



Right-hand shown

External turning

Toolholder dimensions

Description	Availability		Dimension (mm)							Standard corner-R(RE)	Side rake angle (°)	Inclination angle (°)	Spare parts						Applicable inserts
													Clamp	Screw (for clamp)	Spring	Wrench (for clamp)	Shim	Screw (for shim)	
	R	L	H	B	LH	HF	LF	WF											
DCLN% 2020K-12	●	●	20	20	33	20	125	25	0.8	-6	-6								CN□A1204... CN□G1204... CN□M1204...
2525M-12	●	●	25	25	32	25	150	32											

When using inserts whose corner-R(RE) is greater than 1.6 mm, additional modifications to the shim are necessary in order to prevent workpiece and shim from interfering each other.

When using the inserts with SX chipbreaker, prepare a shim (-C type) separately.

Wrench (FT-15) is sold separately.

Recommended tightening torque : 3.9N·m

● : Standard item R : Right-hand only L : Left-hand only □ : Check availability

DCLN-JCT (External turning / External facing, Coolant-through holders)

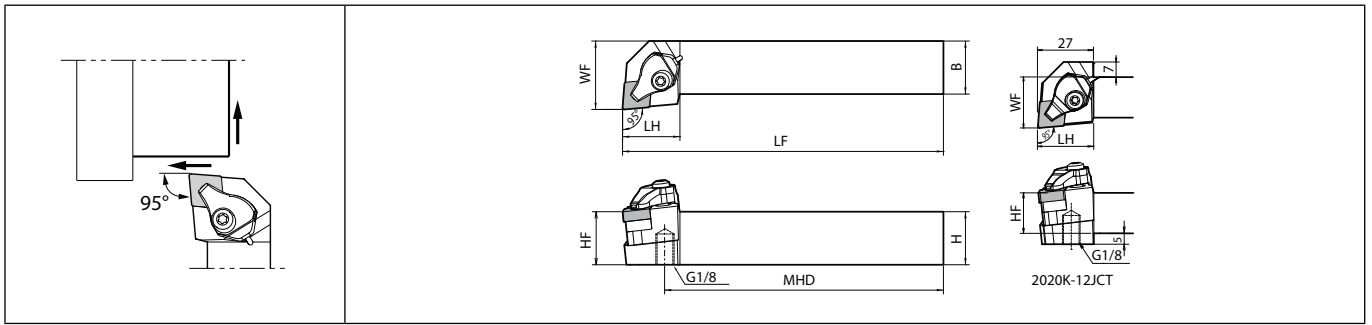

Right-hand shown | with coolant supply | Applicable Pressure : ~30MPa

Toolholder dimensions

Description	Availability		Dimension (mm)								Standard corner-R(RE)	Coolant hole	Side rake angle (°)	Inclination angle (°)	Spare parts						Applicable inserts
															Clamp	Pipe connection	Screw (for clamp)	Screw (for shim)	Shim	Spring	
	R	L	H	B	LH	MHD	HF	LF	WF												
DCLN [®] 2020K-12JCT	●	●	20	20	27	109	20	125	25	0.8	Yes	-6	-6	CP-3D- [®] / _L -JCT	FP-12	CS-3D-TR	SB-4085TR	DC-44 (DC-44-C*)	SP-3D	FT-15	CN□A1204... CN□G1204... CN□M1204...
2525M-12JCT	●	●	25	25		134	25	150	32												

When using inserts whose corner-R(RE) is greater than 1.6 mm, additional modifications to the shim are necessary in order to prevent workpiece and shim from interfering each other.

When using the inserts with SX chipbreaker, prepare a shim (-C type) separately.

Clamp : CP-3D-R-JCT for Right-hand Toolholder, CP-3D-L-JCT for Left-hand Toolholder.

Please see page D12 for piping parts of coolant-through holders.

Only the O-ring (SS-035) included with the pipe connection can be ordered.

Recommended tightening torque : 3.9N·m



External turning

PCLN (External turning / External facing)

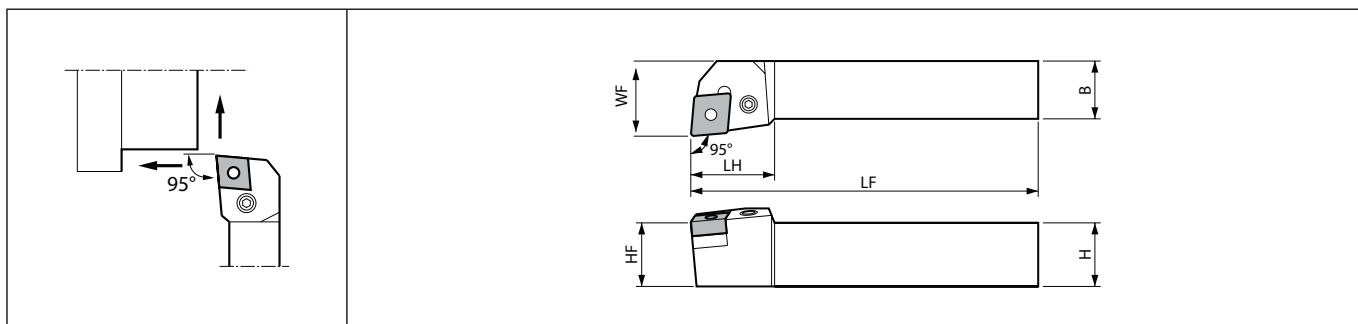

Right-hand shown

Toolholder dimensions

Description	Availability		Dimension (mm)							Standard corner-R(RE)	Side rake angle (°)	Inclination angle (°)	Spare parts						Applicable inserts
													Lever	Lock screw	Punch	Shim pin	Shim	Wrench	
	R	L	H	B	LH	HF	LF	WF											
PCLN%L 1616H-09	●	●	16	16		16	100	20	0.8	-6	-6	LL-1N	LS-1N	PC-1	LSP-1	LC-32N	-	FH-2.5	CNG0904...
2020K-09	●	●	20	20	22	20	125	25											
2525M-09	●	●	25	25		25	150	32											
PCLN%L 2020H-12	●		20	20	27	20	100	25	0.8	-6	-6	LL-2N	LS-2N	PC-2	LSP-2	LC-42N (LC-42N-C*) (LC-42N-20*)	LW-3	-	CNA1204... CNG1204... CNM1204...
2020K-12	●	●				25	150	32											
2525M-12	●	●				25	150	32											
3225P-12	●	●				32	170	40											
PCLN%L 2525M-16	●	●	25	25	32	25	150	32	0.8	-6	-6	LL-5N	LS-4N	-	LSP-3	LC-53N (LC-53N-C*)	LW-3	-	CNMG1606... CNMM1606...
3232P-16	●	●	32	32		32	170	40											
PCLN%L 3232P-19	●	●	32	32	40	32	170	40	1.6	-6	-6	LL-6	LS-5	-	LSP-4	LC-63 (LC-63-C*)	LW-4	-	CNMG1906... CNMM1906...

When using inserts whose corner-R(RE) is greater than 1.6 mm, please purchase a shim and use it in order to prevent workpiece and shim from interfering each other.

When using the inserts with SX chipbreaker, prepare a shim (-C type) separately.

● : Standard item R : Right-hand only L : Left-hand only □ : Check availability

Applicable inserts

Applications	Finishing	Finishing	Finishing - Medium	Finishing - Medium	Finishing	Finishing	Finishing - Medium	Finishing - Medium
Insert								
Chipbreaker type	WF	WP	WE	WQ	PP	GP	PQ	HQ
Page	B16	B16	B16	B16	B16	B16	B16	B17
Applications	Finishing - Medium	Finishing - Medium	Medium	Medium - Roughing	Medium - Roughing	Medium - Roughing	Medium - Roughing	Medium - Roughing
Insert								
Chipbreaker type	CQ	CJ	TN-V	GS	PG	PS	PT	GT
Page	B17	B17	B17	B17	B17	B18	B18	B18
Applications	Roughing	Roughing	Roughing	Finishing	Medium	Medium - Roughing	Medium - Roughing	Low carbon steel
Insert								
Chipbreaker type	STD	PH	PX	P/L-S	R/L	P/L-25R	Z	XF
Page	B18	B18	B19	B23	B23	B23	B23	B19
Applications	Low carbon steel	Low carbon steel	Low carbon steel	Finishing - Medium	Medium - Roughing	Stainless steel / Heat-resistant alloys	Stainless steel / Heat-resistant alloys	Stainless steel / Heat-resistant alloys
Insert								
Chipbreaker type	XP	XQ	XS	SK	FP-TK	TK	MQ	MS
Page	B19	B19	B19	B19	B19	B20	B20	B20
Applications	Stainless steel / Heat-resistant alloys	Cast iron	Cast iron	Cast iron	Cast iron	Cast iron	Cast iron	Cast iron
Insert								
Chipbreaker type	MU	KQ	KG	KH	C	ZS	GC	No CB
Page	B20	B21	B21	B21	B22	B22	B22	B22
Applications	Cast iron / Hard materials	Non-Ferrous Metals	Non-Ferrous Metals	Non-Ferrous Metals	Heat-resistant alloys	Heat-resistant alloys	Heat-resistant alloys	Hard materials / Cast iron
Insert								
Chipbreaker type	Ceramic	P/L-A3	AH	PCD	SQ	SG	P/L-SX	CBN
Page	B113	B23	B23	C34	B20	B21	B21	C8
Applications	Hard materials	Hard materials	Hard materials					
Insert								
Chipbreaker type	HH	HL	HD					
Page	C9	C9	C9					

Recommended cutting conditions  D69~D70

D



External turning

Easy connection with high pressure hose and joint

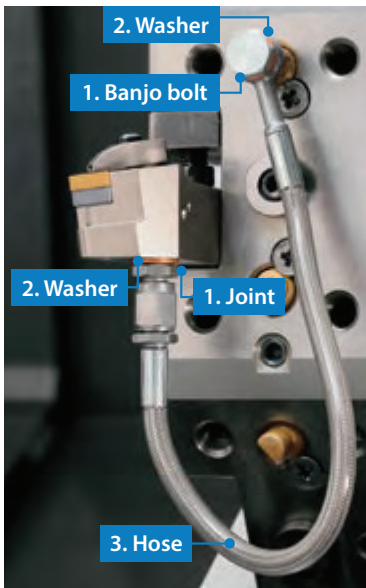

- Even without a high pressure pump, internal coolant can be used at a normal pressure
- Banjo bolt available for angled hose connection. Can be used in a variety of machines

Piping installation guide

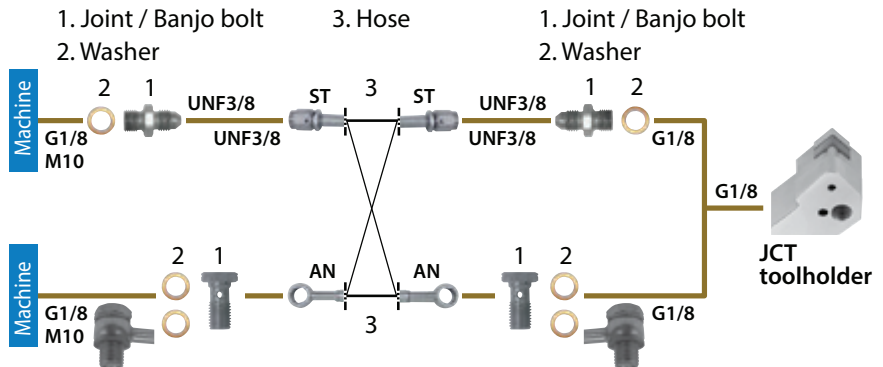

Piping parts

Optional piping parts available (sold separately)
Choose from parts below to match your machine specifications

1. Joint / Banjo bolt × 2 2. Washer × 2-4 3. Hose × 1

1. Joint / Banjo bolt

Applicable pressure: ~ 30 MPa

Shape	Description	Availability	Thread standard	
			Thread connection to the machine	
	J-G1/8-UNF3/8	●	G1/8	
	J-M10X1.5-UNF3/8	●	M10X1.5	
Banjo bolt (For the angle hose)	BB-G1/8	●	G1/8	
	BB-M10X1.5	●	M10X1.5	

2. Washer

Applicable pressure: ~ 30 MPa

Shape	Description	Availability
	WS-10	●

* Use 2 washers for a banjo bolt

3. Hose

Applicable pressure: ~ 30 MPa

Shape	Description	Availability	Thread standard		Dimensions (mm)
					L
	HS-ST-ST-200	●	UNF3/8	UNF3/8	200
	HS-ST-ST-250	●			250
	HS-ST-AN-200	●	UNF3/8	Banjo bolt	200
	HS-ST-AN-250	●			250
	HS-AN-AN-200	●	Banjo bolt	Banjo bolt	200
	HS-AN-AN-250	●			250

Precautions

1. Make sure machine door is completely closed before use of these parts.
2. Use appropriate seal for the male thread of the piping parts and make sure the connection is secure. Use plugs to seal off unused coolant holes.
3. Connect and fasten the coolant hose firmly.
4. The use of copper washers may cause leakage but will have no effect on the performance.
5. Commercial piping parts can be used if the thread standards are same. Check the applicable pressure before use.
6. Regularly changing the coolant filter is recommended.

● : Std. Item

D





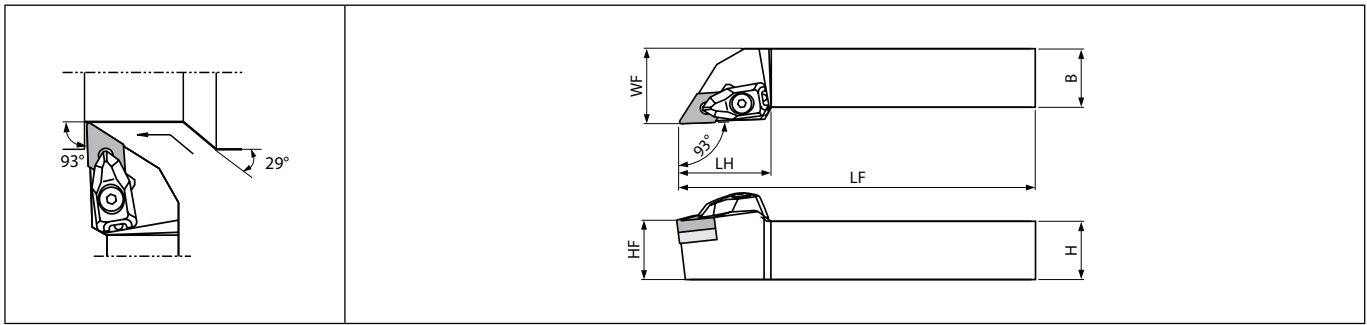

External turning

DDJN (External turning / External copying)



Right-hand shown

Toolholder dimensions

Description	Availability		Dimension (mm)							Standard corner-R(RE)	Side rake angle (°)	Inclination angle (°)	Spare parts						Applicable inserts
													Clamp	Screw (for clamp)	Spring	Wrench (for clamp)	Shim	Screw (for shim)	
	R	L	H	B	LH	HF	LF	WF											
DDJN%L 2020K-1504	●	●	20	20	39	20	125	25	0.8	-6	-6	CP-3D	CS-3D	SP-3D	LW-3	DD-44 (DD-43*)	SB-4085TR	FT-15	DN□A1504...
2525M-1504	●	●	25	25		25	150	32								DN□G1504...			
2020K-1506	●	●	20	20	39	20	125	25	0.8	-6	-6					DD-43 (DD-44*)			DN□A1506...
2525M-1506	●	●	25	25		25	150	32								DN□G1506...			

Shims indicated * are not included with the toolholder. To change insert thickness, please purchase it separately.

When using inserts whose corner-R(RE) is greater than 1.6 mm, additional modifications to the shim are necessary in order to prevent workpiece and shim from interfering each other.

When using the insert with WF chipbreaker, tool edge offset or program corrections are required on R34 and R35.

Wrench (FT-15) is sold separately.

Recommended tightening torque : 3.9N·m



External turning

DDJN-JCT (External turning / External copying, Coolant-through holders)

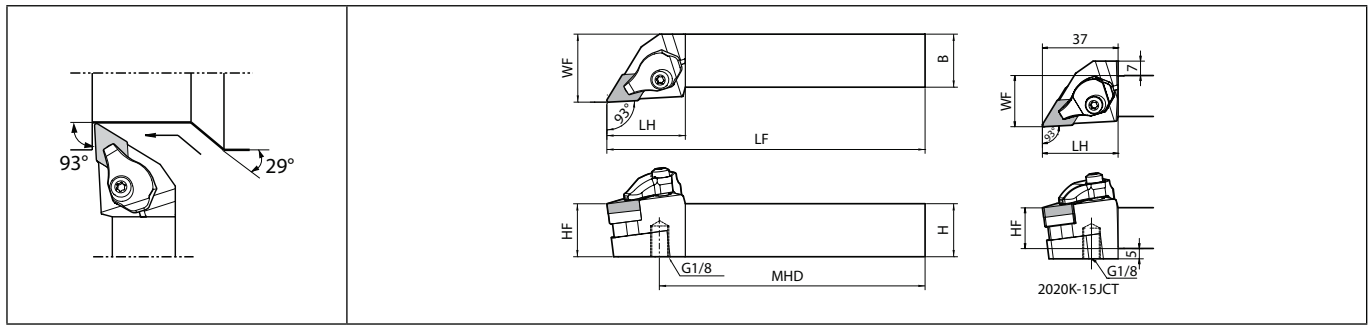

Right-hand shown | with coolant supply | Applicable Pressure : ~30MPa

Toolholder dimensions

Description	Availability		Dimension (mm)								Standard corner-R(RE)	Coolant hole	Side rake angle (°)	Inclination angle (°)	Spare parts							Applicable inserts		
															Clamp	Pipe connection	Screw (for clamp)	Screw	Shim	Spring	Wrench			
	R	L	H	B	LH	MHD	HF	LF	WF															
DDJN%L 2020K-15JCT	●	●	20	20	37	101	20	125	25	0.8	Yes	-6	-7	CP-4D- ^R /L-JCT	FP-12	CS-3D-TR	SB-4085TR	DD-44 (DD-43*)	SP-3D	FT-15	DN□A1504...	DN□G1504...	DN□M1504...	DN□X1504...
2525M-15JCT	●	●	25	25		126	25	150	32															

Shims indicated * are not included with the toolholder. To change insert thickness, please purchase it separately.

When using inserts whose corner-R(RE) is greater than 1.6 mm, additional modifications to the shim are necessary in order to prevent workpiece and shim from interfering each other.

When using the insert with WF chipbreaker, tool edge offset or program corrections are required on **R34** and **R35**.

Please see page **D12** for piping parts of coolant-through holders.

Clamp : CP-4D-R-JCT for Right-hand Toolholder, CP-4D-L-JCT for Left-hand Toolholder.

Only the O-ring (SS-035) included with the pipe connection can be ordered.

Recommended tightening torque : 3.9N·m

● : Standard item R : Right-hand only L : Left-hand only □ : Check availability



DDHN (External turning / External facing / External copying)

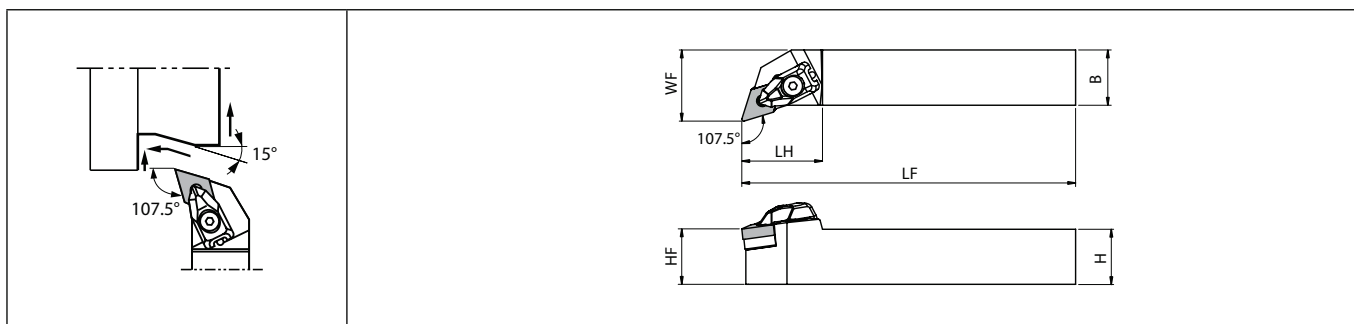

Right-hand shown

Toolholder dimensions

Description	Availability		Dimension (mm)							Standard corner-R(RE)	Side rake angle (°)	Inclination angle (°)	Spare parts						Applicable inserts						
													Clamp	Screw (for clamp)	Spring	Wrench (for clamp)	Shim	Screw (for shim)		Wrench* (for shim)					
	R	L	H	B	LH	HF	LF	WF																	
DDHN%L 2020K-1504	●	●	20	20	37	20	125	25	0.8	-6	-6	CP-3D	CS-3D	SP-3D	LW-3	DD-44 (DD-43*)	SB-4085TR	FT-15	DN□A1504...						
2525M-1504	●	●	25	25		25	150	32											DN□G1504...						
2020K-1506	●	●	20	20	37	20	125	25	0.8	-6	-6					CP-3D			CS-3D	SP-3D	LW-3	DD-43 (DD-44*)	SB-4085TR	FT-15	DN□A1506...
2525M-1506	●	●	25	25		25	150	32																	DN□G1506...
																									DN□M1506...

Shims indicated * are not included with the toolholder. To change insert thickness, please purchase it separately.

When using inserts whose corner-R(RE) is greater than 1.6 mm, additional modifications to the shim are necessary in order to prevent workpiece and shim from interfering each other.

Wrench (FT-15) is sold separately.

The insert with WF chipbreaker is not applicable for DDHN type toolholder.

Recommended tightening torque : 3.9N·m



PDJN (External turning / External copying)

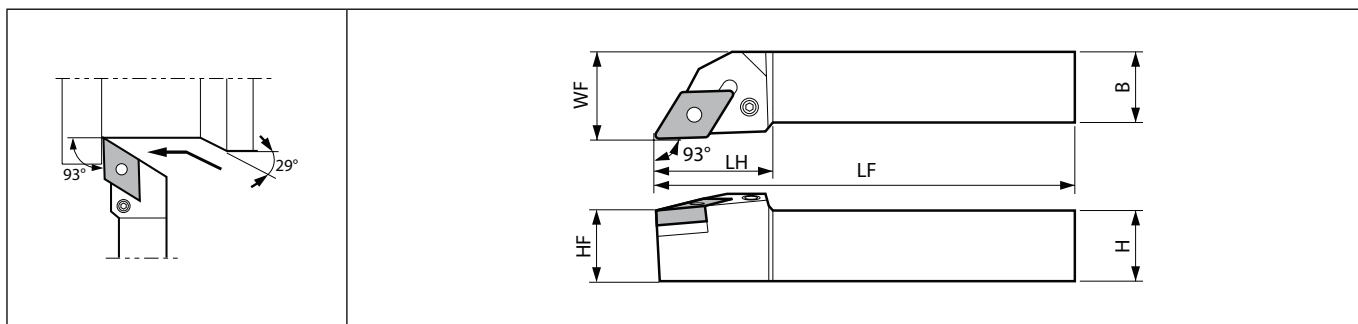

Right-hand shown

Toolholder dimensions

Description	Availability		Dimension (mm)							Standard corner-R(RE)	Side rake angle (°)	Inclination angle (°)	Spare parts						Applicable inserts	
													Lever	Lock screw	Punch	Shim pin	Shim	Wrench		Wrench
	R	L	H	B	LH	HF	LF	WF												
PDJN% 1616H-11	●	●	16	16		16	100	20	0.4	-6	-7	LL-1DN	LS-1N	PC-1	LSP-1	LD-32N	-	FH-2.5	DN□G1104...	
2020K-11	●	●	20	20	28	20	125	25												
2525M-11	●	●	25	25		25	150	32												
PDJN% 2020K-15	●	●	20	20		20	125	25	0.8	-6	-7	LL-3N	LS-2N	PC-2	LSP-2	LD-42 (LD-42-20*)	LW-3	-	DN□A1504...	
2525M-15	●	●	25	25	36	25	150	32								LD-42 (LD-42-20*)			DN□G1504...	
3225P-15	●	●	32	32		32	170	32				LD-42 (LD-43**) (LD-43-20**)	DN□M1504...							
2525M-15U	●	●	25	25	34	25	150	32				LD-4	LS-3	LD-42 (LD-43**) (LD-43-20**)	DN□A1506...					
3232P-15U	●	●	32	32	36	32	170	40											DN□M1506...	
																				DNMX1506...

When using inserts whose corner-R(RE) is greater than 1.6 mm, please purchase a shim* and use it in order to prevent workpiece and shim from interfering each other.

Shim : PDJN%L-15U ... LD-42 is attached to PDJN%L-15U. When using DN□1504 type insert, please purchase LD-43 (or LD-43-20 when using inserts whose corner-R(RE) is greater than 1.6mm) separately.

When using the insert with WF chipbreaker, tool edge offset or program corrections are required on R34 and R35.

● : Standard item R : Right-hand only L : Left-hand only □ : Check availability





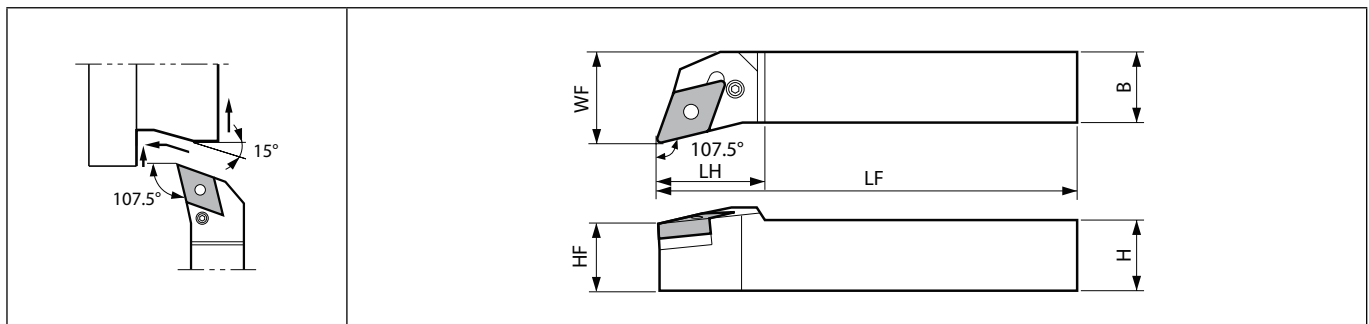



PDHN (External turning / External facing / External copying)



Right-hand shown

Toolholder dimensions

Description	Availability		Dimension (mm)							Standard corner-R(RE)	Side rake angle (°)	Inclination angle (°)	Spare parts						Applicable inserts
													Lever	Lock screw	Punch	Shim pin	Shim	Wrench	
	R	L	H	B	LH	HF	LF	WF											
PDHN%L 2020K-15	●	●	20	20	35	20	125	25	0.8	-6	-6	LL-4	LS-3	PC-2	LSP-2	LD-43 (LD-43-20*) (LD-42**) (LD-42-20**)	LW-3	DN□A1504... DN□G1504... DN□M1504...	
2525M-15	●	●	25	25	34	25	150	32											

When using inserts whose corner-R(RE) is greater than 1.6 mm, please purchase a shim* and use it in order to prevent workpiece and shim from interfering each other.
 Shim : PDHN ...LD-43 is attached to PDHN. When using DN□1506 type Insert, please purchase LD-42 (or LD-42-20 when using inserts whose corner-R(RE) is greater than 1.6mm) separately.
 The insert with WF chipbreaker is not applicable for PDHN type toolholder.

● : Standard item R : Right-hand only L : Left-hand only □ : Check availability



External turning

Applicable inserts (DDJN / DDJN-JCT / DDHN / PDJN / PDHN)

Applications	Finishing	Finishing	Finishing	Finishing - Medium	Finishing - Medium	Finishing - Medium	Finishing - Medium	Medium
Insert								
Chipbreaker type	WF*	PP	GP	PQ	HQ	CQ	CJ	TN-V
Page	B24	B24	B24	B24	B25	B25	B25	B25
Applications	Medium - Roughing	Medium - Roughing	Medium - Roughing	Medium - Roughing	Medium - Roughing	Roughing	Roughing	Roughing
Insert								
Chipbreaker type	GS	PG	PS	PT	GT	STD	PH	PX
Page	B25	B26	B26	B26	B26	B27	B27	B27
Applications	Finishing	Medium	Low carbon steel	Low carbon steel	Low carbon steel	Low carbon steel	Finishing - Medium	Large ap
Insert								
Chipbreaker type	P/L-S	R/L	XF	XP	XQ	XS	SK	R-LD
Page	B31	B31	B27	B27	B27	B27	B28	B28
Applications	Medium - Roughing	Stainless steel / Heat-resistant alloys	Stainless steel / Heat-resistant alloys	Stainless steel / Heat-resistant alloys	Stainless steel / Heat-resistant alloys	Cast iron	Cast iron	Cast iron
Insert								
Chipbreaker type	FP-TK	TK	MQ	MS	MU	KQ	KG	KH
Page	B28	B28	B28	B29	B29	B30	B30	B30
Applications	Cast iron	Cast iron	Cast iron	Cast iron	Cast iron / Hard materials	Non-Ferrous Metals	Non-Ferrous Metals	Non-Ferrous Metals
Insert								
Chipbreaker type	C	ZS	GC	No CB	Ceramic	P/L-A3	AH	PCD
Page	B30	B30	B30	B31	B114	B31	B31	C35
Applications	Heat-resistant alloys	Heat-resistant alloys	Hard materials / Cast iron	Hard materials	Hard materials	Hard materials		
Insert								
Chipbreaker type	SQ	SG	CBN	HH	HL	HD		
Page	B29	B29	C10	C11	C11	C11		

When using the insert with WF chipbreaker, tool edge offset or program corrections are required on R34 and R35.
The insert with WF chipbreaker is not applicable for DDHN type and PDHN type toolholder.

Recommended cutting conditions  D69~D70

D

External turning

DSBN (External turning)

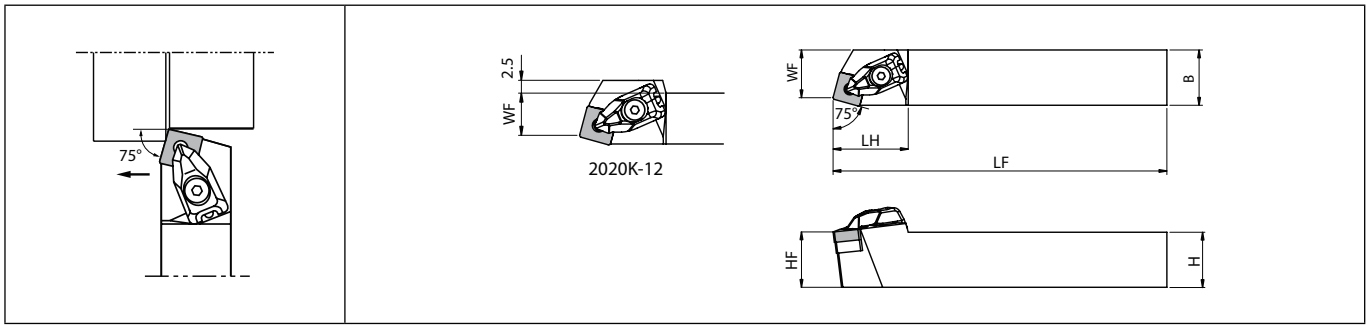

Right-hand shown

Toolholder dimensions

Description	Availability		Dimension (mm)							Standard corner-R(RE)	Side rake angle (°)	Inclination angle (°)	Spare parts						Applicable inserts
													Clamp	Screw (for clamp)	Spring	Wrench (for clamp)	Shim	Screw (for shim)	
	R	L	H	B	LH	HF	LF	WF											
DSBN%L 2020K-12	●	●	20	20	34	20	125	17	0.8	-4	-7								SN□A1204... SN□G1204... SN□M1204...
2525M-12	●	●	25	25		25	150	22				CP-3D	CS-3D	SP-3D	LW-3	DS-44	SB-4085TR	FT-15	

Wrench (FT-15) is sold separately.

When using inserts whose corner-R(RE) is greater than 1.6 mm, additional modifications to the shim are necessary in order to prevent workpiece and shim from interfering each other.

Recommended tightening torque : 3.9N·m

PSBN (External turning)

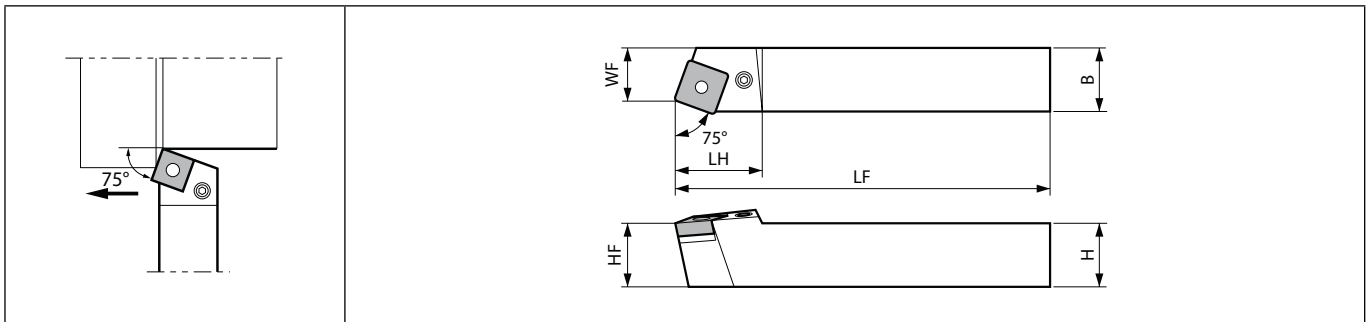

Right-hand shown

Toolholder dimensions

Description	Availability		Dimension (mm)							Standard corner-R(RE)	Side rake angle (°)	Inclination angle (°)	Spare parts						Applicable inserts
													Lever	Lock screw	Punch	Shim pin	Shim	Wrench	
	R	L	H	B	LH	HF	LF	WF											
PSBN%L 2020K-12	●	●	20	20	27	20	125	17	0.8	-4	-7							SN□A1204... SN□G1204... SN□M1204...	
2525M-12	●	●	25	25	24	25	150	22				LL-2N	LS-2N	PC-2	LSP-2	LS-42	LW-3		

When using inserts whose corner-R(RE) is greater than 1.6 mm, additional modifications to the shim are necessary in order to prevent workpiece and shim from interfering each other.

● : Standard item R : Right-hand only L : Left-hand only □ : Check availability

D



External turning

PSKN (External facing)

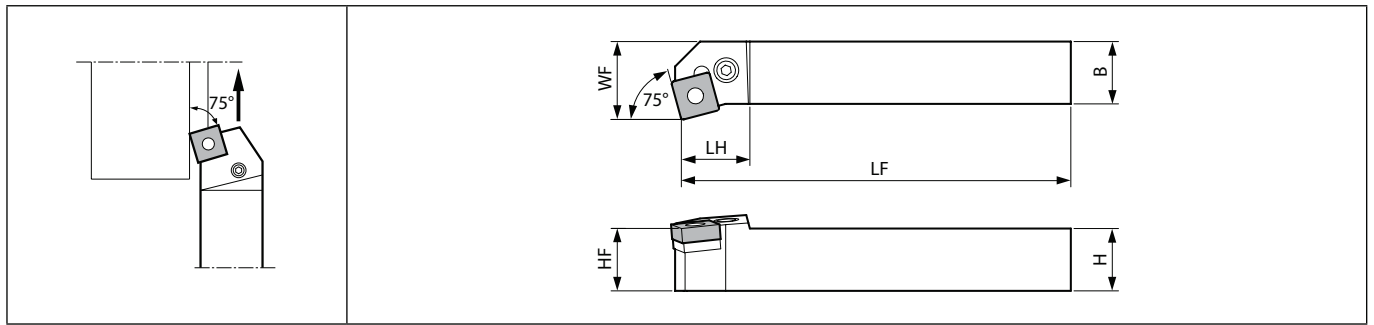

Right-hand shown

Toolholder dimensions

Description	Availability		Dimension (mm)							Standard corner-R(RE)	Side rake angle (°)	Inclination angle (°)	Spare parts						Applicable inserts
													Lever	Lock screw	Punch	Shim pin	Shim	Wrench	
	R	L	H	B	LH	HF	LF	WF											
PSKN%L 2020K-12	●	●	20	20	22.5	20	125	25	0.8	-4	-7	LL-2N	LS-2N	PC-2	LSP-2	LS-42	LW-3	SN□A1204... SN□G1204... SN□M1204...	
2525M-12	●	●	25	25		25	150	32				LL-2N	LS-2N	PC-2	LSP-2	LS-42	LW-3		

When using inserts whose corner-R(RE) is greater than 1.6 mm, additional modifications to the shim are necessary in order to prevent workpiece and shim from interfering each other.
 PSKN%L : Left-hand Insert for Right-hand Toolholder, Right-hand Insert for Left-hand Toolholder.

PSSN (External turning / External facing / External chamfering)

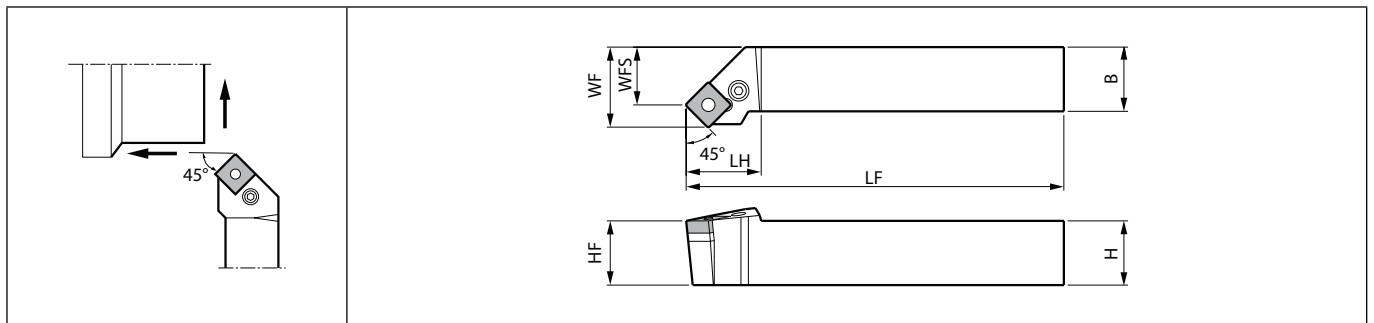

Right-hand shown

Toolholder dimensions

Description	Availability		Dimension (mm)								Standard corner-R(RE)	Side rake angle (°)	Inclination angle (°)	Spare parts							Applicable inserts
														Lever	Lock screw	Punch	Shim pin	Shim	Wrench	Wrench	
	R	L	H	B	LH	HF	LF	WF	WFS												
PSSN%L 1616H-09	●	●	16	16	22	16	100	20	13.6	0.8	-8	0	LL-1N	LS-1N	PC-1	LSP-1	LS-32	-	FH-2.5	SN□G0903...	
PSSN%L 2020K-12 2525M-12	●	●	20	20	29	20	125	25	16.4	0.8	-8	0	LL-2N	LS-2N	PC-2	LSP-2	LS-42	LW-3	-	SN□A1204... SN□G1204... SN□M1204...	
	●	●	25	25		25	150	32	23.4				LL-2N	LS-2N	PC-2	LSP-2	LS-42	LW-3	-		

When using inserts whose corner-R(RE) is greater than 1.6 mm, additional modifications to the shim are necessary in order to prevent workpiece and shim from interfering each other.
 PSSN%L: When using handed inserts, For External Turning, Right-hand Insert for Right-hand Toolholder, Left-hand Insert for Left-hand Toolholder.
 For Facing, Left-hand Insert for Right-hand Toolholder, Right-hand Insert for Left-hand Toolholder.

● : Standard item R : Right-hand only L : Left-hand only □ : Check availability

PSDN (External turning / External chamfering)

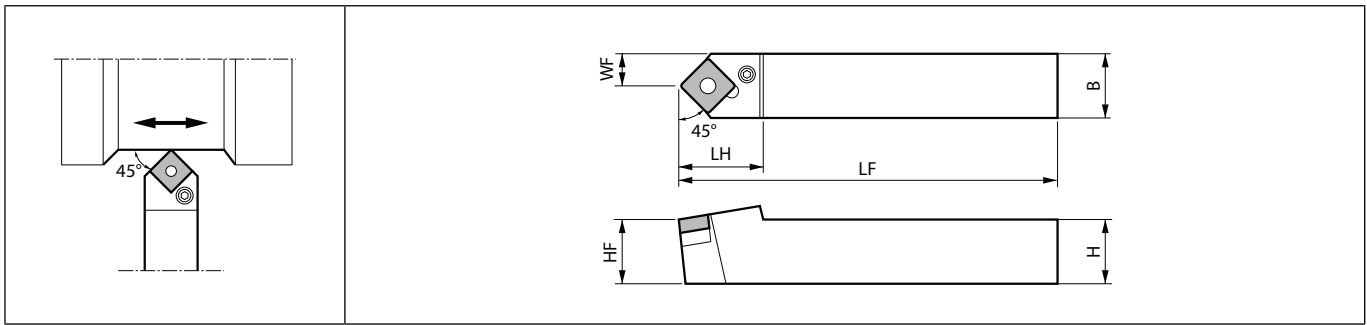

Toolholder dimensions

Description	Availability		Dimension (mm)					Standard corner-R(RE)		Spare parts							Applicable inserts
	N	H	B	LH	HF	LF	WF	Standard corner-R(RE)	Back rake angle (°)	Lever	Lock screw	Punch	Shim pin	Shim	Wrench	Wrench	
PSDNN 1616H-09	●	16	16	21	16	100	8	0.8	-8.5	LL-1N	LS-1N	PC-1	LSP-1	LS-32	-	FH-2.5	SN□G0903...
PSDNN 2020K-12 2525M-12	●	20	20	30	20	125	10	0.8	-8.5	LL-2N	LS-2N	PC-2	LSP-2	LS-42	LW-3	-	SN□A1204... SN□G1204... SN□M1204...
	●	25	25		25	150	12.5										

When using inserts whose corner-R(RE) is greater than 1.6 mm, additional modifications to the shim are necessary in order to prevent workpiece and shim from interfering each other.

Applicable inserts (DSBN / PSBN / PSKN / PSSN / PSDN)

Applications	Finishing - Medium	Finishing - Medium	Medium - Roughing	Medium - Roughing	Medium - Roughing	Roughing	Roughing	Roughing
Insert								
Chipbreaker type	PQ	HQ	PG	PS	PT	STD	PH	PX
Page	B34	B34	B34	B34	B34	B34	B35	B35
Applications	Finishing - Medium	Medium - Roughing	Medium - Roughing	Low carbon steel	Low carbon steel	Low carbon steel	Stainless steel / Heat-resistant alloys	Stainless steel / Heat-resistant alloys
Insert								
Chipbreaker type	♯/L-B	♯/L-C	♯/L-2SR	XP	XQ	XS	MQ	MS
Page	B37	B37	B37	B35	B35	B35	B36	B36
Applications	Cast iron	Cast iron	Cast iron	Cast iron	Cast iron	Cast iron	Cast iron / Hard materials	Heat-resistant alloys
Insert								
Chipbreaker type	KG	KH	C	ZS	GC	No CB	Ceramic	SG
Page	B36	B36	B36	B37	B37	B37	B117	B36
Applications	Hard materials / Cast iron							
Insert								
Chipbreaker type	CBN							
Page	C12							

Recommended cutting conditions Ⓢ D69~D70

● : Standard item R : Right-hand only L : Left-hand only □ : Check availability

D







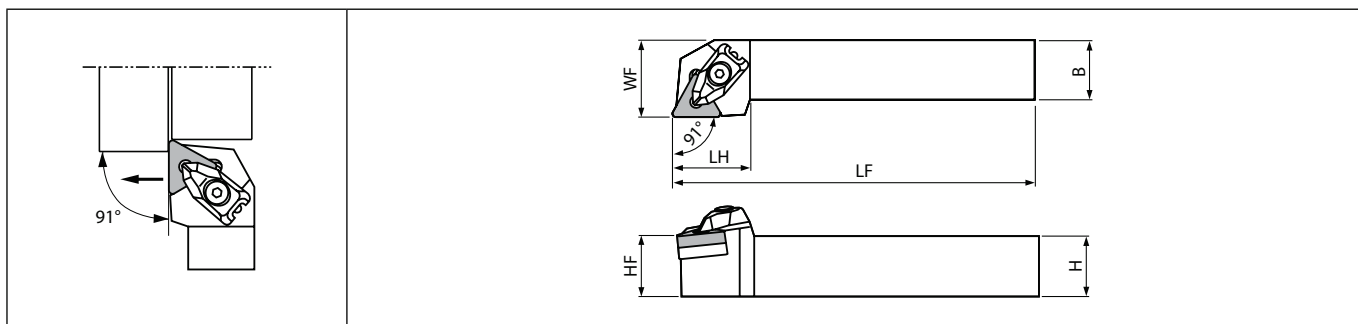









External turning

DTGN (External turning)



Right-hand shown

Toolholder dimensions

Description	Availability		Dimension (mm)								Standard corner-R(RE)	Side rake angle (°)	Inclination angle (°)	Spare parts						Applicable inserts
														Clamp	Screw (for clamp)	Screw	Shim	Spring	Wrench	
	R	L	H	B	LH	HF	LF	WF												
DTGN [®] L 2020K-16	●	●	20	20	25	20	125	25	0.8	-6	-6								TN□A1604... TN□G1604... TN□M1604... TN□X1604...	
2525M-16	●	●	25	25		25	150	32												CP-2D

When using inserts whose corner-R(RE) is greater than 1.6 mm, additional modifications to the shim are necessary in order to prevent workpiece and shim from interfering each other.

When using the insert with WF chipbreaker, tool edge offset or program corrections are required on R34 and R35.

Wrench (FT-10) is sold separately.

Recommended tightening torque : 1.7N·m

● : Standard item R : Right-hand only L : Left-hand only □ : Check availability

D

External turning

DTGN-JCT (External turning, Coolant-through holders)

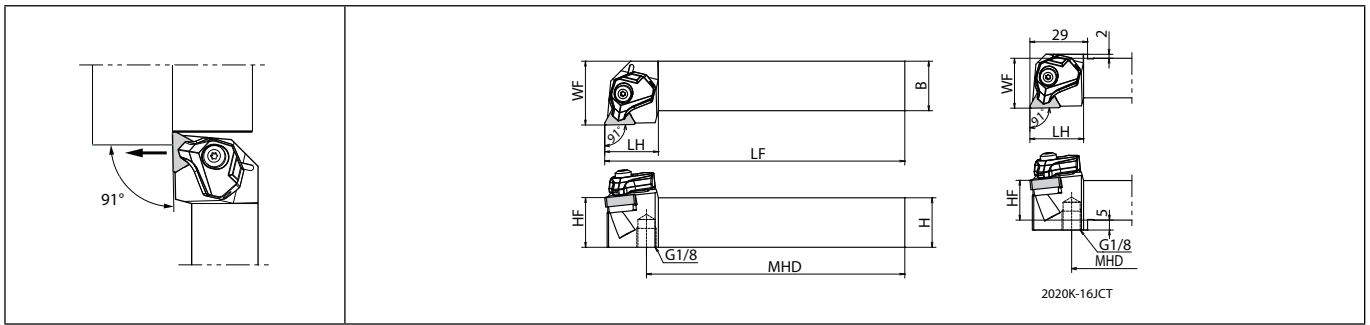

Right-hand shown | with coolant supply | Applicable Pressure : ~30MPa

Toolholder dimensions

Description	Availability		Dimension (mm)							Standard corner-R(RE)	Coolant hole	Side rake angle (°)	Inclination angle (°)	Applicable inserts
	R	L	H	B	LH	MHD	HF	LF	WF					
DTGN ⁹⁰ 2020K-16JCT	●	●	20	20	27	104	20	125	25	0.8	Yes	-6	-6	TN□A1604..., TN□G1604... TN□M1604..., TNMX1604...
2525M-16JCT	●	●	25	25		129	25	150	32					

Description	Spare parts							
	Clamp	Screw (for clamp)	Spring	Wrench (for clamp)	Shim	Screw (for shim)	Wrench* (for shim)	Pipe connection
DTGN ⁹⁰ 2020K-16JCT								
2525M-16JCT	CP-2D- ⁹⁰ L-JCT	CS-3D-TR	SP-3D	FT-15	DT-32	SB-3080TR	FT-10	FP-12

When using inserts whose corner-R(RE) is greater than 1.6 mm, additional modifications to the shim are necessary in order to prevent workpiece and shim from interfering each other.

When using the insert with WF chipbreaker, tool edge offset or program corrections are required on **R34** and **R35**.

Wrench (FT-10) is sold separately.

Please see page **D12** for piping parts of coolant-through holders.

Only the O-ring (SS-035) included with the pipe connection can be ordered.

Recommended tightening torque : 3.9N·m



External turning

● : Standard item R : Right-hand only L : Left-hand only □ : Check availability

PTGN (External turning)

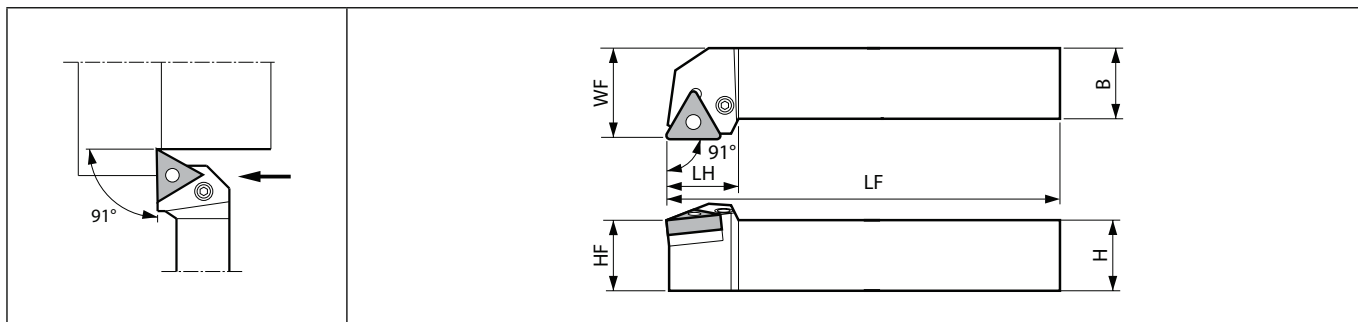

Right-hand shown

Toolholder dimensions

Description	Availability		Dimension (mm)							Standard corner-R(RE)	Side rake angle (°)	Inclination angle (°)	Spare parts							Applicable inserts	
	R	L	H	B	LH	HF	LF	WF	Lever				Lock screw	Punch	Shim pin	Shim pin	Shim	Wrench	Wrench		
PTGN% 1212F-11	●	●	12	12	18	12	80	16	0.8	-6	-6	LL-03N	LS-03N	-	-	P-03	-	FH-2	TNGG/A1103...		
1616H-11	●		16	16		16	100	20				LL-03TN	LS-03SN	-	-	P-03S	-	-	FH-2.5	TNGG1104... TNMG1104...	
2020K-11	●	●	20	20	22	20	125	25													
2525M-11	●	●	25	25		25	150	32													
PTGN% 1616H-16	●	●	16	16		16		20	0.8	-6	-6	LL-1N	LS-1N	PC-1	LSP-1	-	LT-32N (LT-32N-20*)	-	FH-2.5	TN□A1604... TN□G1604... TN□M1604... TNMX1604...	
2020H-16	●				24	20	100	20													
2020K-16	●	●	20	20		20	125	25													
2525M-16	●	●	25	25		25	150	32													
PTGN% 2525M-22	●	●	25	25	29	25	150	32	0.8	-6	-6	LL-2N	LS-2N	PC-2	LSP-2	-	LT-42N (LT-42N-20*)	LW-3	-	TN□G2204... TN□M2204...	

When using inserts whose corner-R(RE) is greater than 1.6 mm, please purchase a shim* and use it in order to prevent workpiece and shim from interfering each other.

When using the insert with WF chipbreaker, tool edge offset or program corrections are required on R34 and R35.

PTGN% 1212F-11 : TNGA1103 and TNGG1103 type Inserts are applicable.

● : Standard item R : Right-hand only L : Left-hand only □ : Check availability

PTFN (External facing)

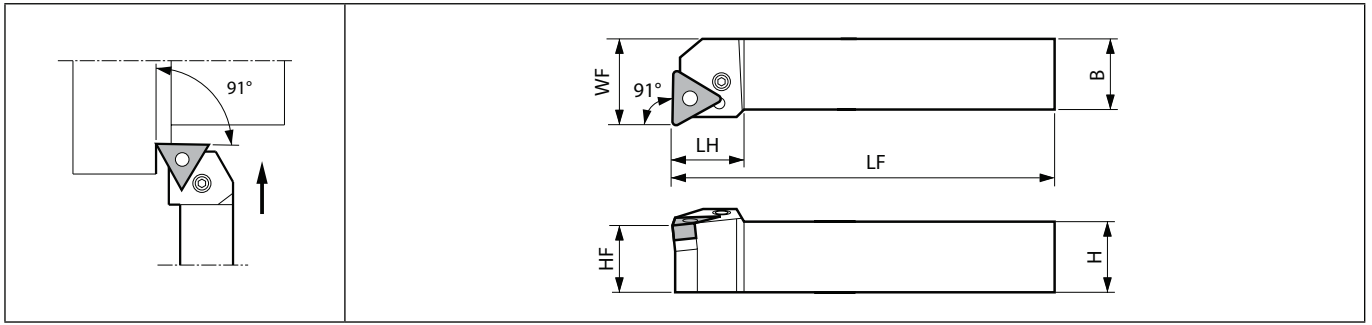

Right-hand shown

Toolholder dimensions

Description	Availability		Dimension (mm)							Standard corner-R(RE)	Side rake angle (°)	Inclination angle (°)	Spare parts							Applicable inserts	
													Lever	Lock screw	Punch	Shim pin	Shim pin	Shim	Wrench		Wrench
	R	L	H	B	LH	HF	LF	WF													
PTFN% 1212F-11 1616H-11 2020K-11 2525M-11	●	●	12	12	15	12	80	16	0.8	-6	-6	LL-03N	LS-03N	-	-	P-03	-	FH-2	TN□□1103...		
	●	●	16	16	-	16	100	20				LL-03TN	LS-03SN	-	-	P-03S	-	-	FH-2.5	TN□□1104...	
	●	●	20	20	22.5	20	125	25				-	-	-	-	-	-	-	-	-	-
	●	●	25	25	-	25	150	32				-	-	-	-	-	-	-	-	-	-
PTFN% 2020K-16 2525M-16	●	●	20	20	22	20	125	25	0.8	-6	-6	LL-1N	LS-1N	PC-1	LSP-1	-	LT-32N (LT-32N-20*)	-	FH-2.5	TN□A1604... TN□G1604... TN□M1604... TNMX1604...	
	●	●	25	25	23	25	150	32				-	-	-	-	-	-	-	-	-	-
PTFN% 2525M-22	●	●	25	25	28	25	150	32	0.8	-6	-6	LL-2N	LS-2N	PC-2	LSP-2	-	LT-42N (LT-42N-20*)	LW-3	-	TN□G2204... TN□M2204...	

When using inserts whose corner-R(RE) is greater than 1.6 mm, please purchase a shim* and use it in order to prevent workpiece and shim from interfering each other.

When using the insert with WF chipbreaker, tool edge offset or program corrections are required on R34 and R35.

PTFN% 1212F-11 : TNGA1103 and TNGG1103 type inserts are applicable.

PTFN% : Left-hand Insert for Right-hand Toolholder, Right-hand Insert for Left-hand Toolholder.

● : Standard item R : Right-hand only L : Left-hand only □ : Check availability



External turning

Applicable inserts (DTGN / DTGN-JCT / PTGN / PTFN)

Applications	Finishing	Finishing	Finishing	Finishing - Medium	Finishing - Medium	Finishing - Medium	Medium - Roughing	Medium - Roughing
Insert								
Chipbreaker type	WF	PP	GP	PQ	HQ	CQ	GS	PG
Page	B39	B39	B39	B39	B39	B39	B40	B40
Applications	Medium - Roughing	Medium - Roughing	Medium - Roughing	Roughing	Roughing	Roughing	Finishing	Finishing
Insert								
Chipbreaker type	PS	PT	GT	STD	PH	PX	%L-SSF	%L-S
Page	B40	B40	B40	B40	B41	B41	B45	B45
Applications	Finishing - Medium	Medium - Roughing	Medium - Roughing	Medium - Roughing	Low carbon steel	Low carbon steel	Low carbon steel	Low carbon steel
Insert								
Chipbreaker type	%L-B	%L-C	R/L	%L-25R	XF	XP	XQ	XS
Page	B45	B46	B46	B46	B41	B41	B41	B41
Applications	Finishing - Medium	Large ap	Medium - Roughing	Stainless steel / Heat-resistant alloys	Stainless steel / Heat-resistant alloys	Stainless steel / Heat-resistant alloys	Stainless steel / Heat-resistant alloys	Stainless steel
Insert								
Chipbreaker type	SK	R-LD	FP-TK	TK	MQ	MS	MU	%L-ST
Page	B42	B42	B42	B42	B42	B42	B42	B43
Applications	Cast iron	Cast iron	Cast iron	Cast iron	Cast iron	Cast iron	Cast iron	Cast iron / Hard materials
Insert								
Chipbreaker type	KQ	KG	KH	C	ZS	GC	No CB	Ceramic
Page	B43	B43	B43	B43	B43	B43	B44	B118
Applications	Non-Ferrous Metals	Non-Ferrous Metals	Non-Ferrous Metals	Heat-resistant alloys	Hard materials / Cast iron			
Insert								
Chipbreaker type	%L-A3	AH	PCD	SG	CBN			
Page	B44	B44	C36	B43	C13			

Recommended cutting conditions ➔ D69~D70

D

External turning

WTJN (External turning / External copying)

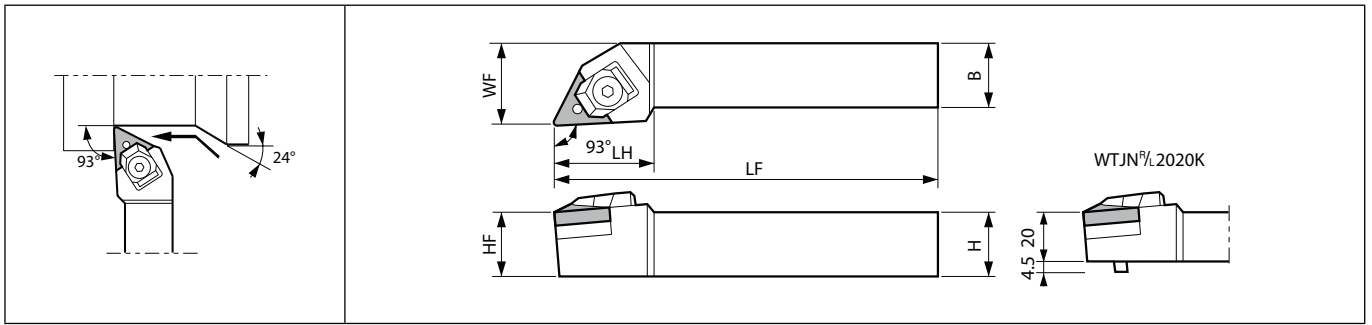

Right-hand shown

Toolholder dimensions

Description	Availability		Dimension (mm)							Standard corner-R(RE)	Side rake angle (°)	Inclination angle (°)	Spare parts						Applicable inserts					
													Clamp set	Nut	Shim pin	Shim	Spacer	Wrench						
	R	L	H	B	LH	HF	LF	WF																
WTJN%/. 2020K-16N	●	●	20	20	32	20	125	25	0.8	-6	-6		WCS-1N		WN-1		WP-1S		WTN-33 (WTN-33-20*)		WSP-1		LW-3	TN□A1604... TN□G1604... TN□M1604...
2525M-16N	●	●	25	25		25	150	32																

When using inserts whose corner-R(RE) is greater than 1.6 mm, please purchase a shim* and use it in order to prevent workpiece and shim from interfering each other.
In wedge lock, use of ceramic insert other than silicon nitride insert is not recommended due to strong restrain force.

WTKN (External turning / External facing / External copying)

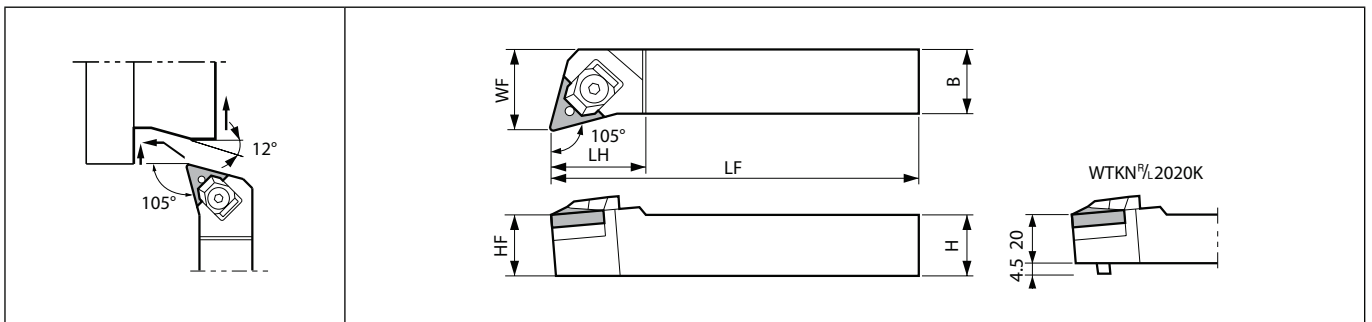

Right-hand shown

Toolholder dimensions

Description	Availability		Dimension (mm)							Standard corner-R(RE)	Side rake angle (°)	Inclination angle (°)	Spare parts						Applicable inserts					
													Clamp set	Nut	Shim pin	Shim	Spacer	Wrench						
	R	L	H	B	LH	HF	LF	WF																
WTKN%/. 2020K-16N	●	●	20	20	32	20	125	25	0.8	-6	-6		WCS-1N		WN-1		WP-1S		WTN-33 (WTN-33-20*)		WSP-1		LW-3	TN□A1604... TN□G1604... TN□M1604...
2525M-16N	●	●	25	25		25	150	32																

When using inserts whose corner-R(RE) is greater than 1.6 mm, please purchase a shim* and use it in order to prevent workpiece and shim from interfering each other.
In wedge lock, use of ceramic insert other than silicon nitride insert is not recommended due to strong restrain force.

● : Standard item R : Right-hand only L : Left-hand only □ : Check availability



External turning

WTEN (External turning / External chamfering)

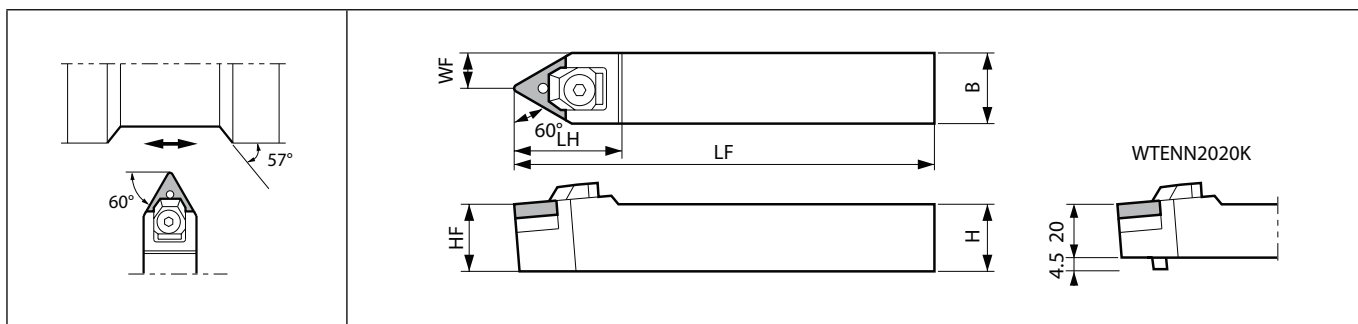

External turning









































Toolholder dimensions

Description	Availability	Dimension (mm)							Standard corner-R(RE)	Back rake angle (°)	Spare parts						Applicable inserts
		N	H	B	LH	HF	LF	WF			Clamp set	Nut	Shim pin	Shim	Spacer	Wrench	
					32	20	125	10									
WTENN 2020K-16N	●	20	20		20	125	10	0.8	-8.5							TN□A1604... TN□G1604... TN□M1604...	
2525M-16N	●	25	25		25	150	12.5			WCS-1N	WN-1	WP-1S	WTN-33 (WTN-33-20*)	WSP-1	LW-3		

When using inserts whose corner-R(RE) is greater than 1.6 mm, please purchase a shim* and use it in order to prevent workpiece and shim from interfering each other. In wedge lock, use of ceramic insert other than silicon nitride insert is not recommended due to strong restrain force.

● : Standard item R : Right-hand only L : Left-hand only □ : Check availability

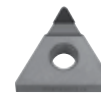
Applicable inserts (WTJN / WTKN / WTEN)

Applications	Finishing	Finishing	Finishing - Medium	Finishing - Medium	Finishing - Medium	Medium - Roughing	Medium - Roughing	Medium - Roughing
Insert								
Chipbreaker type	PP	GP	PQ	HQ	CQ	GS	PG	PS
Page	B39	B39	B39	B39	B39	B40	B40	B40
Applications	Medium - Roughing	Medium - Roughing	Roughing	Roughing	Roughing	Finishing	Finishing	Finishing - Medium
Insert								
Chipbreaker type	PT	GT	STD	PH	PX	1/2-SSF	1/2-S	1/2-B
Page	B40	B40	B40	B41	B41	B45	B45	B45
Applications	Medium - Roughing	Medium - Roughing	Low carbon steel	Low carbon steel	Low carbon steel	Low carbon steel	Finishing - Medium	Large ap
Insert								
Chipbreaker type	1/2-C	1/2-25R	XF	XP	XQ	XS	SK	R-LD
Page	B46	B46	B41	B41	B41	B41	B42	B42
Applications	Medium - Roughing	Stainless steel / Heat-resistant alloys	Stainless steel / Heat-resistant alloys	Stainless steel / Heat-resistant alloys	Stainless steel / Heat-resistant alloys	Stainless steel	Cast iron	Cast iron
Insert								
Chipbreaker type	FP-TK	TK	MQ	MS	MU	1/2-ST	KQ	KG
Page	B42	B42	B42	B42	B42	B43	B43	B43
Applications	Cast iron	Cast iron	Cast iron	Cast iron	Cast iron	Non-Ferrous Metals	Non-Ferrous Metals	Non-Ferrous Metals
Insert								
Chipbreaker type	KH	C	ZS	GC	No CB	1/2-A3	AH	PCD
Page	B43	B43	B43	B43	B44	B44	B44	C36
Applications	Heat-resistant alloys	Hard materials / Cast iron						
Insert								
Chipbreaker type	SG	CBN						
Page	B43	C13						

D



External turning

Recommended cutting conditions  D69~D70



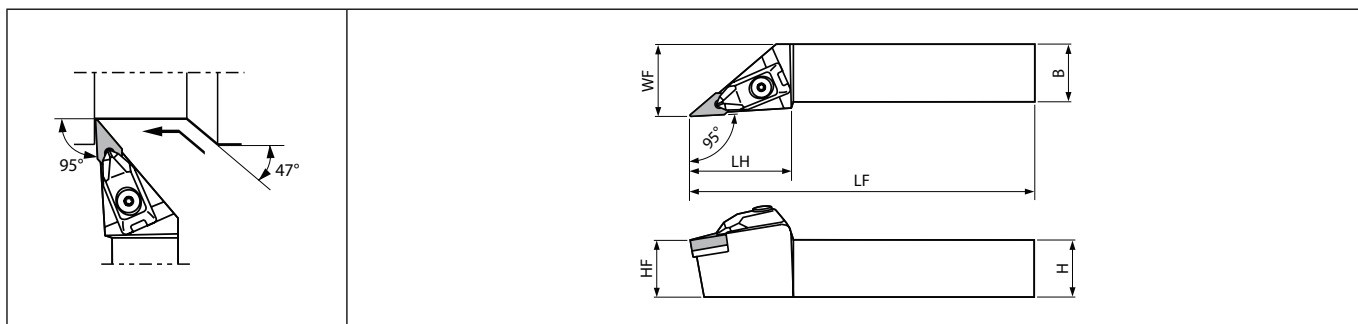











DVLN (External turning / External copying)



Right-hand shown

External turning

Toolholder dimensions

Description	Availability		Dimension (mm)							Standard corner-R(RE)	Side rake angle (°)	Inclination angle (°)	Spare parts						Applicable inserts
													Clamp	Screw (for clamp)	Spring	Wrench (for clamp)	Shim	Screw (for shim)	
	R	L	H	B	LH	HF	LF	WF											
DVLN%L 2020K-16	●	●	20	20	45	20	125	25	0.8	-6	-9								VN□A1604...
2525M-16	●	●	25	25		25	150	32				CP-5D	CS-5D	SP-5D	LW-3	DV-33	SB-4085TR	FT-15	VN□G1604...

When using inserts whose corner-R(RE) is greater than 1.2 mm, additional modifications to the shim are necessary in order to prevent workpiece and shim from interfering each other.

Wrench (FT-15) is sold separately.

Recommended tightening torque : 3.0N·m

● : Standard item R : Right-hand only L : Left-hand only □ : Check availability

DVLN-JCT (External turning / External copying, Coolant-through holders)

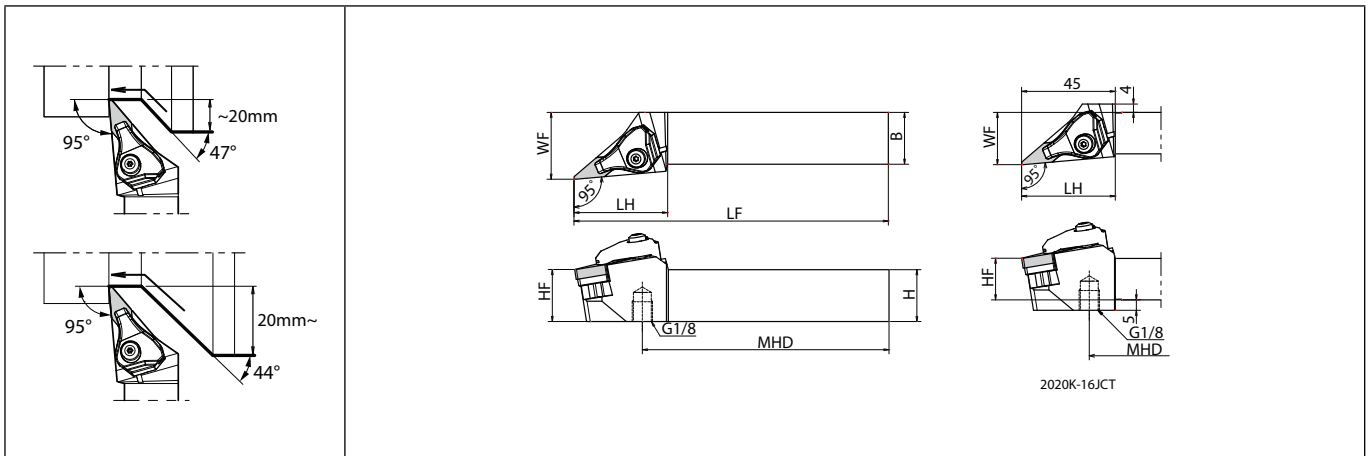

Right-hand shown | with coolant supply | Applicable Pressure : ~30MPa



Toolholder dimensions

Description	Availability		Dimension (mm)							Standard corner-R(RE)	Coolant hole	Side rake angle (°)	Inclination angle (°)	Applicable inserts
	R	L	H	B	LH	MHD	HF	LF	WF					
DVLNR 2020K-16JCT	●		20	20	45	92.5	20	125	25	0.8	Yes	-6	-9	VN□A1604... VN□G1604... VN□M1604...
DVLNL 2020K-16JCT		●				88.5								
DVLNR 2525M-16JCT	●		25	25	117.5	25	150	32						
DVLNL 2525M-16JCT		●			113.5									

Description	Spare parts						
	Clamp	Pipe connection	Screw (for clamp)	Screw	Shim	Spring	Wrench
	DVLN%L 2020K-16JCT 2525M-16JCT						
	CP-5D-JCT	FP-12	CS-3D-TR	SB-4085TR	DV-33	SP-3D	FT-15

When using inserts whose corner-R(RE) is greater than 1.2 mm, additional modifications to the shim are necessary in order to prevent workpiece and shim from interfering each other. The washer may protrude from the holder. To prevent interference, additional modifications to the washer may be required.

Only the O-ring (SS-035) included with the pipe connection can be ordered.

Please see page D12 for piping parts of coolant-through holders.

Recommended tightening torque : 3.9N·m





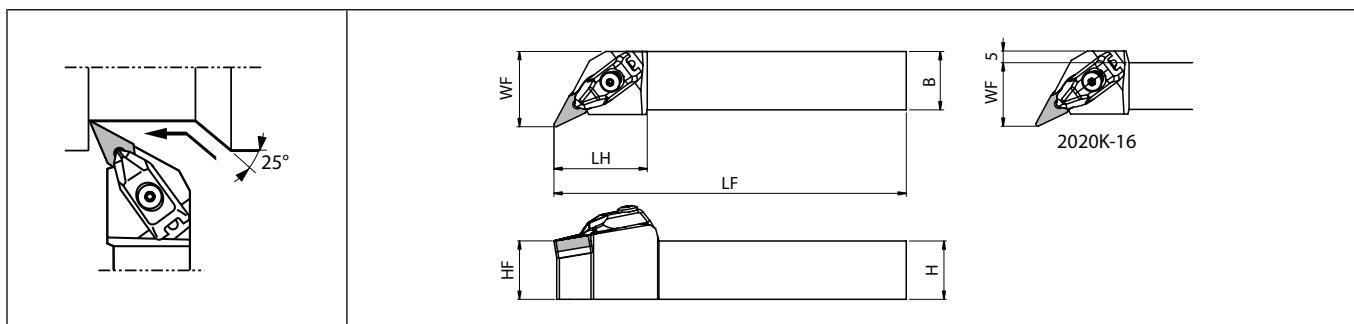

● : Standard item R : Right-hand only L : Left-hand only □ : Check availability

DVPN (External turning / External facing / External copying / Undercutting)



Right-hand shown

Toolholder dimensions

Description	Availability		Dimension (mm)							Standard corner-R(RE)	Side rake angle (°)	Inclination angle (°)	Spare parts						Applicable inserts
													Clamp	Screw (for clamp)	Spring	Wrench (for clamp)	Shim	Screw (for shim)	
	R	L	H	B	LH	HF	LF	WF											
DVPN%L 2020K-16	●	●	20	20	40	20	125	27	0.8	-13	-10	CP-5D	CS-5D	SP-5D	LW-3	DV-33	SB-4085TR	FT-15	VN□A1604...
2525M-16	●	●	25	25		25	150	32				VN□G1604...	VN□M1604...						

When using inserts whose corner-R(RE) is greater than 1.2 mm, additional modifications to the shim are necessary in order to prevent workpiece and shim from interfering each other.

Wrench (FT-15) is sold separately.

Recommended tightening torque : 3.0N·m

● : Standard item R : Right-hand only L : Left-hand only □ : Check availability

DVPN-JCT (External turning / External facing / External copying / Undercutting, Coolant-through holders)

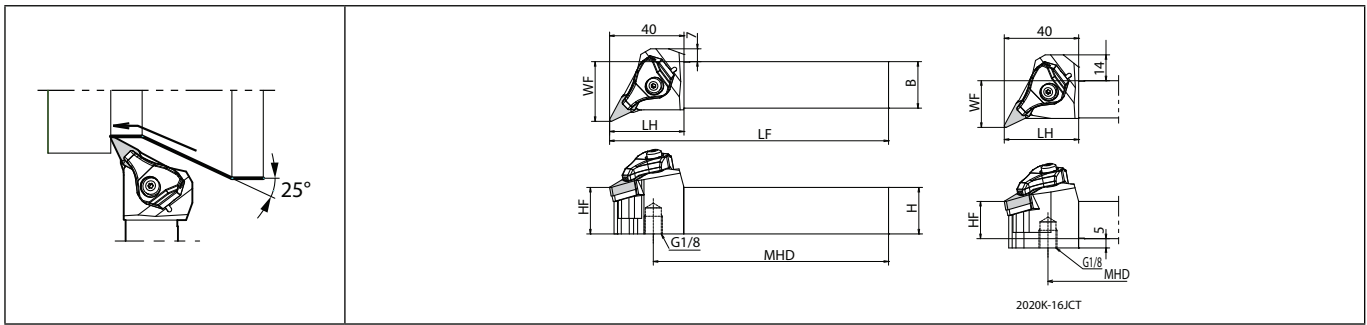

Right-hand shown | with coolant supply | Applicable Pressure : ~30MPa

Toolholder dimensions

Description	Availability		Dimension (mm)							Standard corner-R(RE)	Coolant hole	Side rake angle (°)	Inclination angle (°)	Applicable inserts
	R	L	H	B	LH	MHD	HF	LF	WF					
DVPNR 2020K-16JCT	●		20	20	40	101.5	20	125	25	0.8	Yes	-13	-10	VN□A1604... VN□G1604... VN□M1604...
DVPNL 2020K-16JCT		●				93.5								
DVPNR 2525M-16JCT	●		25	25	40	126.5	25	150	32					
DVPNL 2525M-16JCT		●				118.5								

Description	Spare parts						
	Clamp	Pipe connection	Screw (for clamp)	Screw	Shim	Spring	Wrench
	DVPN ^{R/L} 2020K-16JCT 2525M-16JCT						
	CP-5D-JCT	FP-12	CS-3D-TR	SB-4085TR	DV-33	SP-3D	FT-15

When using inserts whose corner-R(RE) is greater than 1.2 mm, additional modifications to the shim are necessary in order to prevent workpiece and shim from interfering each other. The washer may protrude from the holder. To prevent interference, additional modifications to the washer may be required. Only the O-ring (SS-035) included with the pipe connection can be ordered. Please see page D12 for piping parts of coolant-through holders. Recommended tightening torque : 3.9N·m







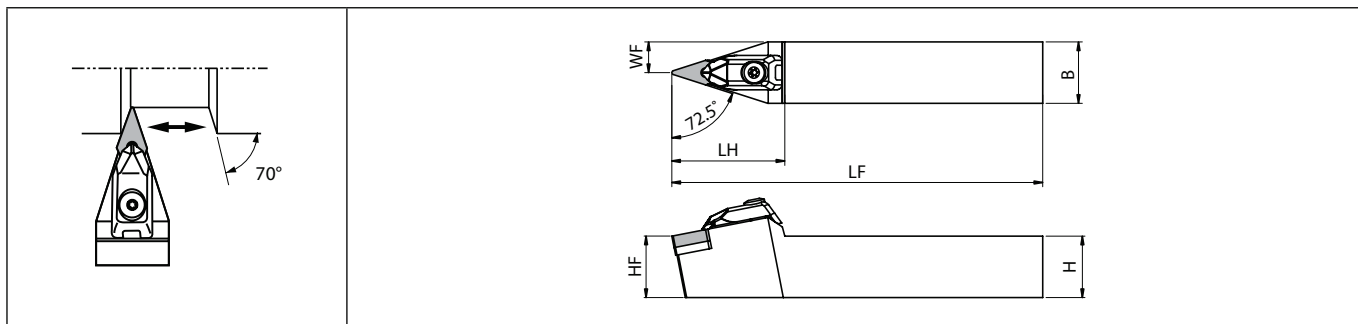









External turning

DVVN (External turning / External copying)



External turning

Toolholder dimensions

Description	Availability	Dimension (mm)							Standard corner-R(RE)	Back rake angle (°)	Spare parts						Applicable inserts	
		N	H	B	LH	HF	LF	WF			Clamp	Screw (for clamp)	Spring	Wrench (for clamp)	Shim	Screw (for shim)		Wrench* (for shim)
																		
DVVNN 2020K-16 2525M-16	●	20	20	46	20	125	10	0.8	-11								VN□A1604... VN□G1604... VN□M1604...	
	●	25	25		25	150	12.5			CP-5D	CS-5D	SP-5D	LW-3	DV-33	SB-4085TR	FT-15		

When using inserts whose corner-R(RE) is greater than 1.2 mm, additional modifications to the shim are necessary in order to prevent workpiece and shim from interfering each other.
 Wrench (FT-15) is sold separately.
 Recommended tightening torque : 3.0N·m

● : Standard item R : Right-hand only L : Left-hand only □ : Check availability

DVVN-JCT (External turning / External copying, Coolant-through holders)

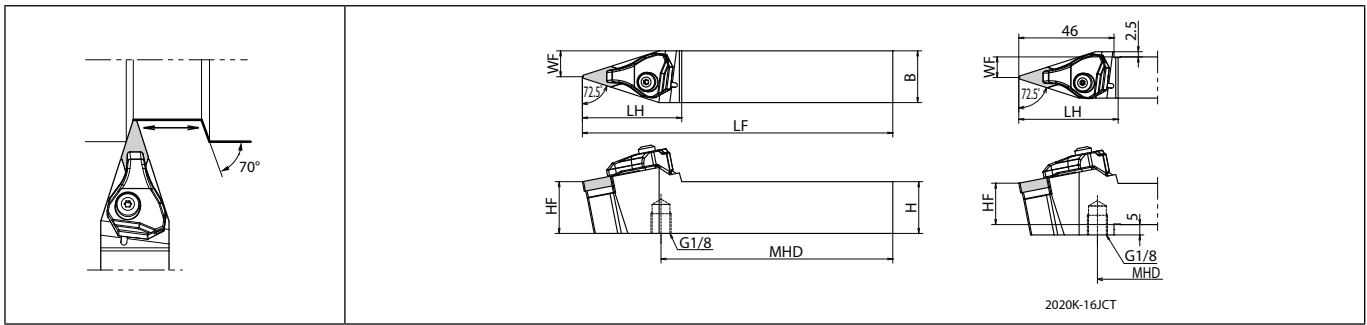

with coolant supply | Applicable Pressure : ~30MPa

Toolholder dimensions

Description	Availability		Dimension (mm)						Standard corner-R(RE)	Coolant hole	Back rake angle (°)	Applicable inserts
	N	H	B	LH	MHD	HF	LF	WF				
DVVNN 2020K-16JCT	●	20	20	48	87	20	125	10	0.8	Yes	-11	VN□A1604..., VN□G1604... VN□M1604...
2525M-16JCT	●	25	25		112	25	150	12.5				

Description	Spare parts						
	Clamp	Pipe connection	Screw (for clamp)	Screw	Shim	Spring	Wrench
DVVNN 2020K-16JCT 2525M-16JCT							
	CP-5D-JCT	FP-12	CS-3D-TR	SB-4085TR	DV-33	SP-3D	FT-15

When using inserts whose corner-R(RE) is greater than 1.2 mm, additional modifications to the shim are necessary in order to prevent workpiece and shim from interfering each other. The washer may protrude from the holder. To prevent interference, additional modifications to the washer may be required. Only the O-ring (SS-035) included with the pipe connection can be ordered. Please see page **D12** for piping parts of coolant-through holders. Recommended tightening torque : 3.9N·m



External turning

MVLN (External turning / External copying)

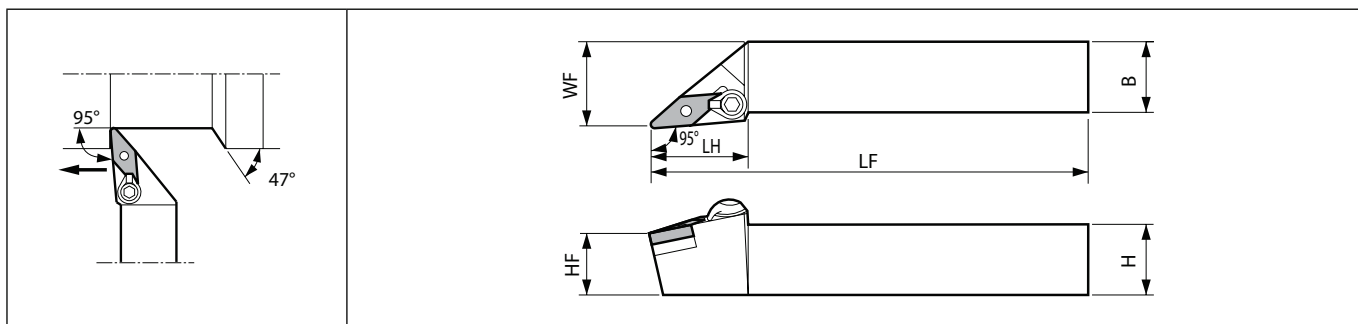

Right-hand shown

External turning

Toolholder dimensions

Description	Availability		Dimension (mm)							Standard corner-R(RE)	Side rake angle (°)	Inclination angle (°)	Spare parts					Applicable inserts
													Clamp set	Wrench (for clamp set)	Lock pin	Shim	Wrench (for shim)	
	R	L	H	B	LH	HF	LF	WF										
MVLN [°] L 2020K-16	●	●	20	20	38	20	125	25	0.8	-6	-9		FH-2.5	TS-35	MVN-32	FH-2	VN□A1604... VN□G1604... VN□M1604...	
2525M-16	●	●	25	25		25	150	32					FH-2.5	TS-35	MVN-32	FH-2		

When using inserts whose corner-R(RE) is greater than 1.2 mm, additional modifications to the shim are necessary in order to prevent workpiece and shim from interfering each other.

Clamp Set : CPS-5R for Right-hand Toolholder, CPS-5L for Left-hand Toolholder.

Clamp set : CPS-5R has Right-hand thread.

When clamping the insert, turn the screw in the arrow direction (clockwise).

When removing the insert, turn the screw away from the arrow (counterclockwise).

Clamp set : CPS-5L has Left-hand thread.

When clamping the insert, turn the screw in the arrow direction (counterclockwise).

When removing the insert, turn the screw away from the arrow (clockwise).

● : Standard item R : Right-hand only L : Left-hand only □ : Check availability

MVVN (External turning / External copying)

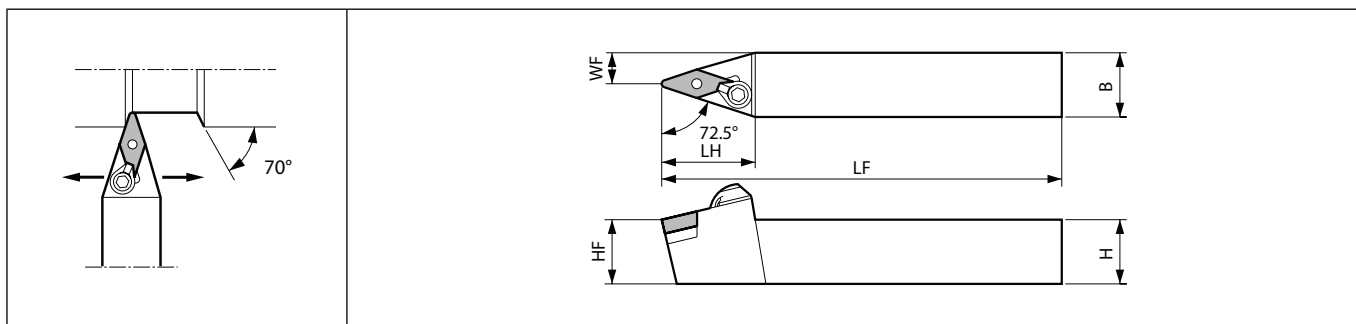

Toolholder dimensions

Description	Availability		Dimension (mm)					Standard corner-R(RE)	Back rake angle (°)	Spare parts					Applicable inserts
	N	H	B	LH	HF	LF	WF			Clamp set	Wrench	Lock pin	Shim	Wrench	
	MVVNN 2020K-16	●	20	20	39	20	125			10	0.8	-11			
2525M-16	●	25	25	39	25	150	12.5			CPS-5R	FH-2.5	TS-3S	MVN-32	FH-2	

When using inserts whose corner-R(RE) is greater than 1.2 mm, additional modifications to the shim are necessary in order to prevent workpiece and shim from interfering each other.

Clamp set : CPS-5R has Right-hand thread.

When clamping the insert, turn the screw in the arrow direction (clockwise).

When removing the insert, turn the screw away from the arrow (counterclockwise).





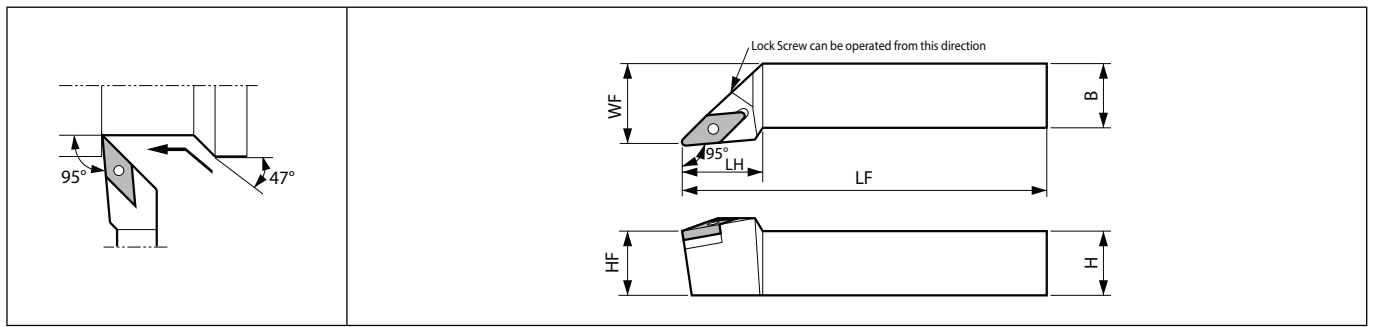

PVLN (External turning / External copying)



Right-hand shown

Toolholder dimensions

Description	Availability		Dimension (mm)							Standard corner-R(RE)	Side rake angle (°)	Inclination angle (°)	Spare parts				Applicable inserts
	R	L	H	B	LH	HF	LF	WF	Lock pin				Lock screw	Shim	Wrench		
																	
PVLN%L 2525M-16Q	●	●	25	25	37	25	150	32	0.8	-6	-9	LP-6S	LS-15	KVN-32	LW-3	VN□A1604..., VN□G1604... VN□M1604...	



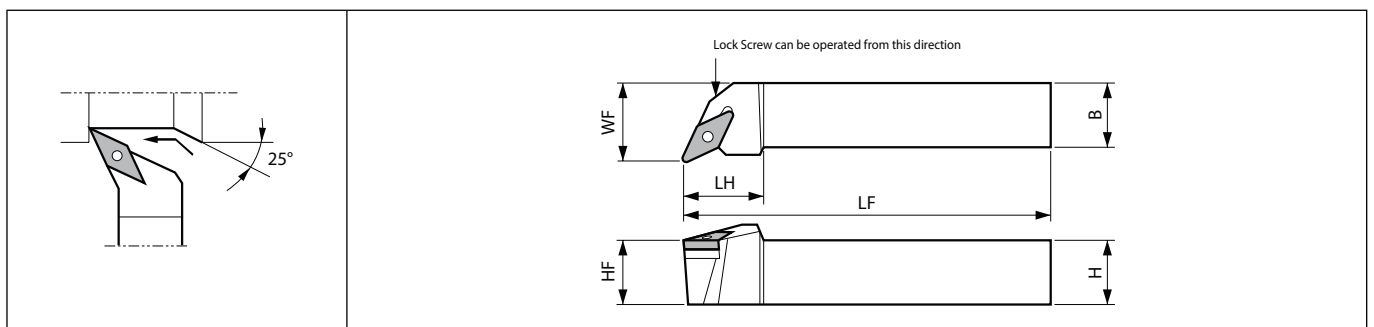

When using inserts whose corner-R(RE) is greater than 1.2 mm, additional modifications to the shim are necessary in order to prevent workpiece and shim from interfering each other.

PVPN (External turning / External facing / External copying / Undercutting)



Right-hand shown

Toolholder dimensions

Description	Availability		Dimension (mm)							Standard corner-R(RE)	Side rake angle (°)	Inclination angle (°)	Spare parts				Applicable inserts
	R	L	H	B	LH	HF	LF	WF	Lock pin				Lock screw	Shim	Wrench		
																	
PVPN%L 2020K-16Q	●	●	20	20	30	20	125	25	0.8	-13	-10	LP-2S	LS-11	KVN-32	LW-3	VN□A1604..., VN□G1604... VN□M1604...	
2525M-16Q	●	●	25	25		25	150	32				LP-6S					

When using inserts whose corner-R(RE) is greater than 1.2 mm, additional modifications to the shim are necessary in order to prevent workpiece and shim from interfering each other.

● : Standard item R : Right-hand only L : Left-hand only □ : Check availability

PVVN (External turning / External copying)

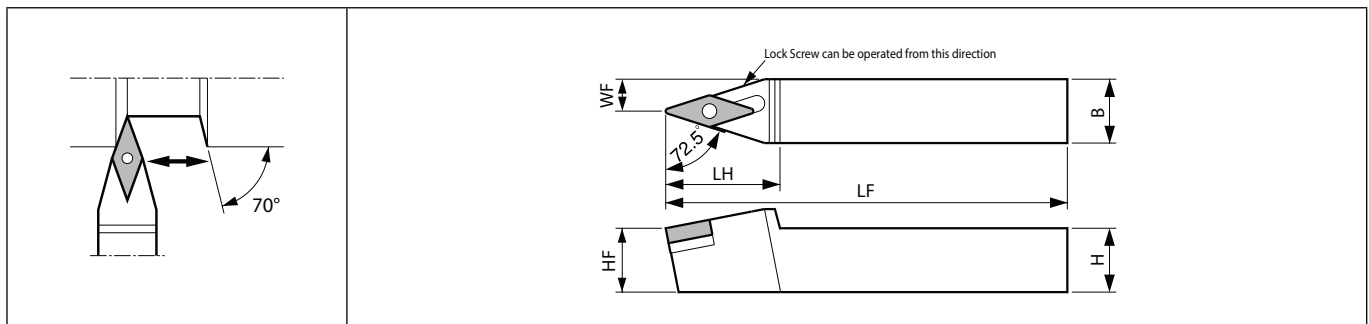

Toolholder dimensions

Description	Availability		Dimension (mm)					Standard corner-R(RE)	Back rake angle (°)	Spare parts				Applicable inserts
	N	H	B	LH	HF	LF	WF			Lock pin	Lock screw	Shim	Wrench	
	PVVNN 2020K-16Q	●	20	20	35	20	125			10	0.8	-11	LP-2S	
2525M-16Q	●	25	25	40	25	150	12.5			LP-6S				VN□M1604...

When using inserts whose corner-R(RE) is greater than 1.2 mm, additional modifications to the shim are necessary in order to prevent workpiece and shim from interfering each other.

Applicable inserts

Applications	Finishing	Finishing	Finishing - Medium	Finishing - Medium	Finishing - Medium	Finishing - Medium	Medium	Roughing
Insert								
Chipbreaker type	PP	GP	VC	VF	PQ	HQ	TN-V	STD
Page	B47	B47	B47	B47	B47	B47	B47	B47
Applications	Finishing - Medium	Finishing	Medium	Stainless steel / Heat-resistant alloys	Stainless steel / Heat-resistant alloys	Stainless steel / Heat-resistant alloys	Cast iron	Cast iron
Insert								
Chipbreaker type	SK	S	R/L	MQ	MS	MU	KG	KH
Page	B48	B49	B49	B48	B48	B48	B48	B48
Applications	Cast iron	Cast iron / Hard materials	Non-Ferrous Metals	Heat-resistant alloys	Hard materials / Cast iron			
Insert								
Chipbreaker type	No CB	Ceramic	PCD	SG	CBN			
Page	B49	B119	C37	B48	C14			

Recommended cutting conditions ➔ D69~D70

● : Standard item R : Right-hand only L : Left-hand only □ : Check availability

PRGC (External turning / External facing / External copying)

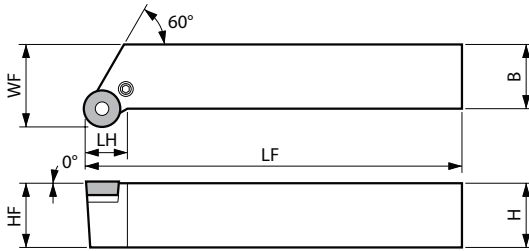
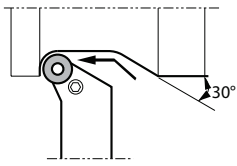

Right-hand shown

Toolholder dimensions

Description	Availability		Dimension (mm)							Side rake angle (°)	Inclination angle (°)	Spare parts						Applicable inserts
												Lever	Lock screw	Punch	Shim pin	Shim	Wrench	
	R	L	H	B	LH	HF	LF	WF										
PRGC%L 2020K-10	●	●	20	20	15	20	125	25	0	0							RCX1003M0	
2525M-10	●	●	25	25		25	150	32										
PRGC%L 2020K-12	●	●	20	20	14	20	125	25	0	0							RCMX1204M0	
2525M-12	●	●	25	25	17	25	150	32										

PRXC (External turning / External facing / External copying)

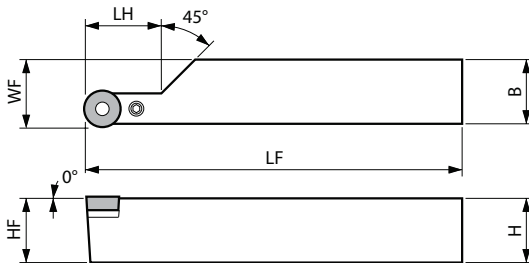
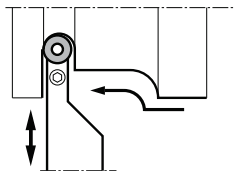



Right-hand shown

Toolholder dimensions

Description	Availability		Dimension (mm)							Side rake angle (°)	Inclination angle (°)	Spare parts						Applicable inserts
												Lever	Lock screw	Punch	Shim pin	Shim	Wrench	
	R	L	H	B	LH	HF	LF	WF										
PRXC%L 2020K-10	●	●	20	20	25	20	125	20.5	0	0							RCX1003M0	
2525M-10	●	●	25	25	30	25	150	25.5										
2525Q-10	●	●					180											
PRXC%L 2525M-12	●	●	25	25	30	25	150	25.7	0	0							RCMX1204M0	

● : Standard item R : Right-hand only L : Left-hand only □ : Check availability

Applicable inserts

Applications	Medium	Non-Ferrous Metals
Insert		
Chipbreaker type	STD	AQ
Page	B81	B81

Recommended cutting conditions  D69~D70



External turning

PRGN (External turning / External facing / External copying)

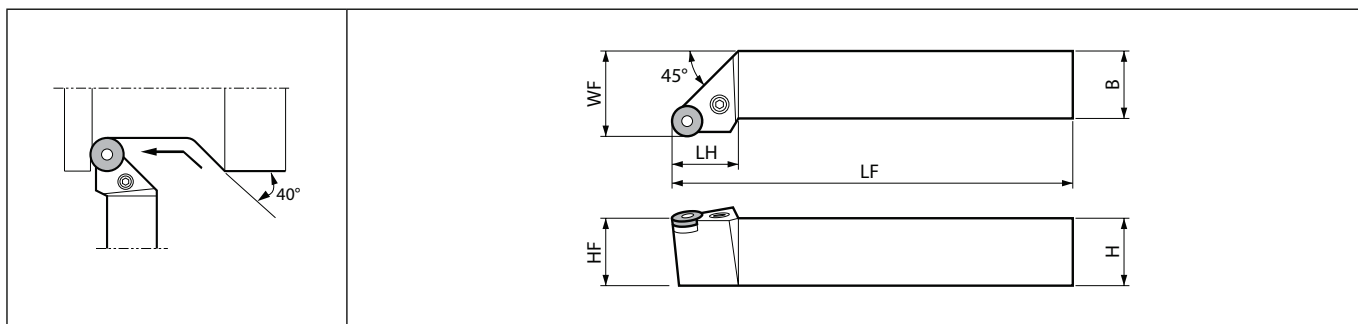

Right-hand shown

External turning

Toolholder dimensions

Description	Availability		Dimension (mm)								Side rake angle (°)		Inclination angle (°)		Spare parts							Applicable inserts
															Lever	Lock screw	Punch	Shim pin	Shim	Wrench	Wrench	
	R	L	H	B	LH	HF	LF	WF														
PRGN%L 2020K-09	●	●	20	20	19	20	125	25	-6	-6	LL-1N	LS-1N	PC-1	LSP-1	LR-80	-	FH-2.5	RNMG090300				
PRGN%L 2525M-12	●	●	25	25	26	25	150	32	-6	-6	LL-2N	LS-2N	PC-2	LSP-2	LR-81	LW-3	-	RNMG120400				

Applicable inserts

Applications	Medium - Roughing
Insert	
Chipbreaker type	STD
Page	B33

Recommended cutting conditions D69~D70

● : Standard item R : Right-hand only L : Left-hand only □ : Check availability

DWLN (External turning / External facing)

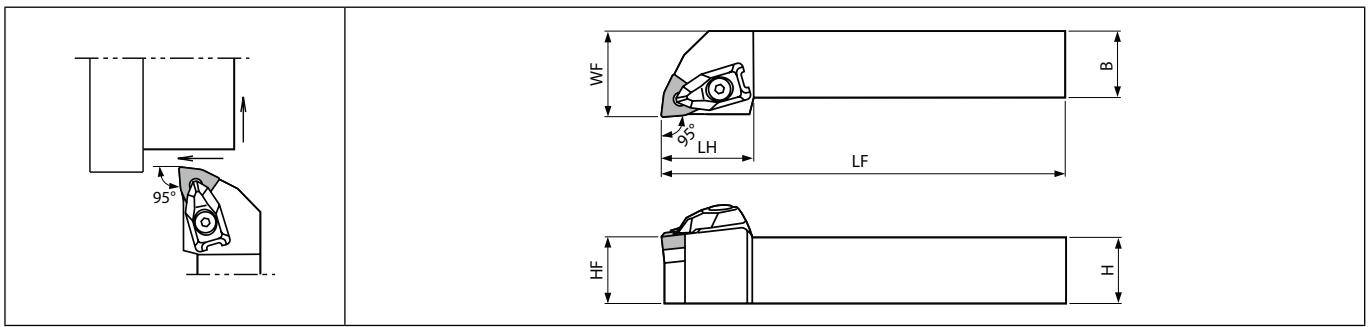















Right-hand shown



External turning

Toolholder dimensions

Description	Availability		Dimension (mm)							Standard corner-R(RE)	Side rake angle (°)	Inclination angle (°)	Spare parts						Applicable inserts
													Clamp	Screw (for clamp)	Spring	Wrench (for clamp)	Shim	Screw (for shim)	
	R	L	H	B	LH	HF	LF	WF											
DWLN%L 2020K-08	●	●	20	20	34	20	125	25	0.8	-6	-6								WN□A0804...
2525M-08	●	●	25	25		25	150	32											WN□G0804...

Wrench (FT-15) is sold separately.

Recommended tightening torque : 3.9N·m

DWLN-JCT (External turning / External facing, Coolant-through holders)

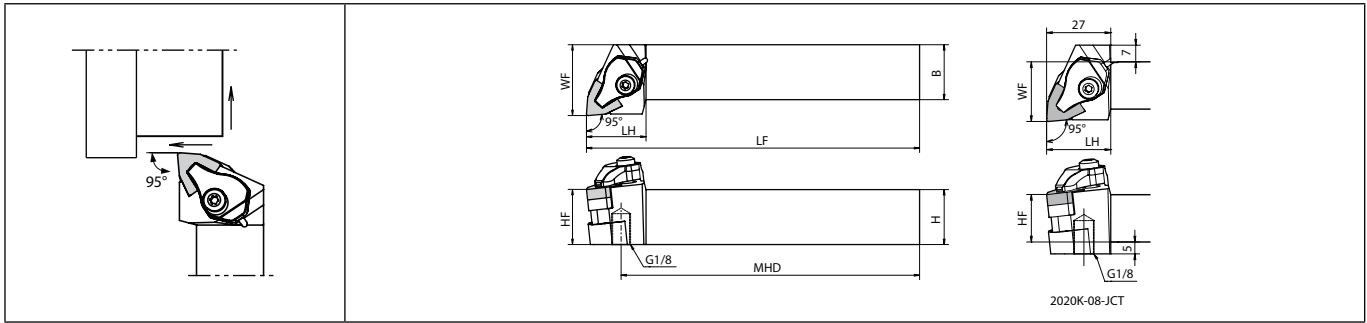

Right-hand shown | with coolant supply | Applicable Pressure : ~30MPa

Toolholder dimensions

Description	Availability		Dimension (mm)							Standard corner-R(RE)	Coolant hole	Side rake angle (°)	Inclination angle (°)	Applicable inserts
	R	L	H	B	LH	MHD	HF	LF	WF					
DWLN [®] L 2020K-08JCT	●	●	20	20	27	109	20	125	25	0.8	Yes	-6	-6	WN□A0804..., WN□G0804...
2525M-08JCT	●	●	25	25		134	25	150	32					WN□M0804...

Description	Spare parts						
	Clamp	Pipe connection	Screw (for clamp)	Screw	Shim	Spring	Wrench
DWLN [®] L 2020K-08JCT							
2525M-08JCT	CP-3D- [®] L-JCT	FP-12	CS-3D-TR	SB-4085TR	DW-44	SP-3D	FT-15

Clamp : CP-3D-R-JCT for Right-hand Toolholder, CP-3D-L-JCT for Left-hand Toolholder.

Please see page D12 for piping parts of coolant-through holders.

Only the O-ring (SS-035) included with the pipe connection can be ordered.

Recommended tightening torque : 3.9N·m





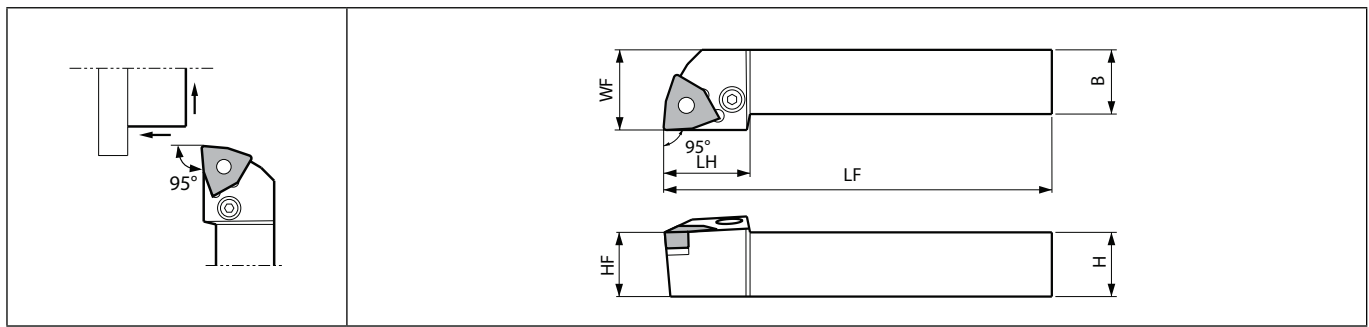

● : Standard item R : Right-hand only L : Left-hand only □ : Check availability

PWLN (External turning / External facing)



Right-hand shown

Toolholder dimensions

Description	Availability		Dimension (mm)							Standard corner-R(RE)	Side rake angle (°)	Inclination angle (°)	Spare parts						Applicable inserts
													Lever	Lock screw	Punch	Shim pin	Shim	Wrench	
	R	L	H	B	LH	HF	LF	WF											
PWLN ⁹⁰ 1616H-06 2020K-06 2525M-06	●	●	16	16	22	16	100	20	0.8	-6	-6	LL-1N	LS-1N	PC-1	LSP-1	LW-32N	-	FH-2.5	WN□G0604...
	●	●	20	20		20	125	25											
	●	●	25	25		25	150	32											
PWLN ⁹⁰ 2020K-08 2525M-08	●	●	20	20	26	20	125	25	0.8	-6	-6	LL-2N	LS-2N	PC-2	LSP-2	LW-42N	LW-3	-	WN□A0804... WN□G0804... WN□M0804...
	●	●	25	25		25	150	32											
	●	●	25	25		25	150	32											

When using inserts whose corner-R(RE) is greater than 1.6 mm, additional modifications to the shim are necessary in order to prevent workpiece and shim from interfering each other.



External turning





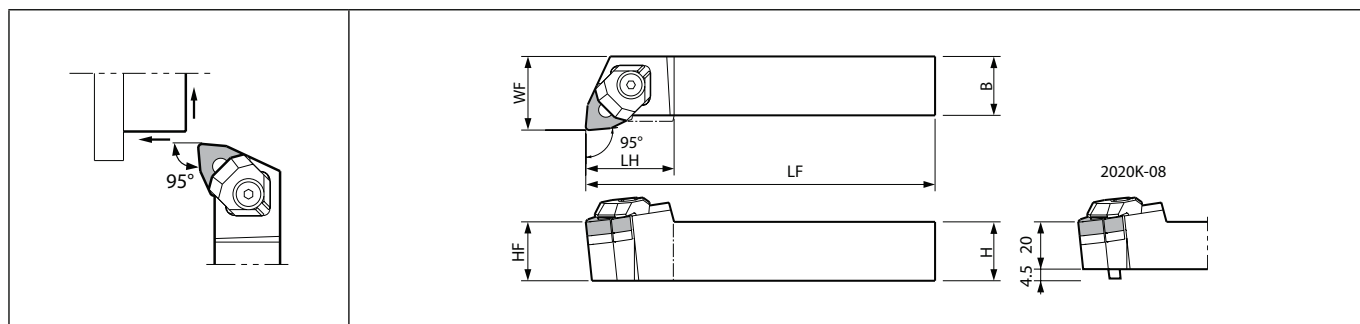

● : Standard item R : Right-hand only L : Left-hand only □ : Check availability

WWLN (External turning / External facing)



Right-hand shown

Toolholder dimensions



























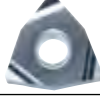
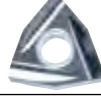







Description	Availability		Dimension (mm)							Standard corner-R(RE)	Side rake angle (°)	Inclination angle (°)	Spare parts					Applicable inserts
													Clamp set	Nut	Shim pin	Shim	Wrench	
	R	L	H	B	LH	HF	LF	WF										
WWLN ^{R/L} 2020K-08	●	●	20	20	30	20	125	25	1.2	-6	-6		WN-1	WP5X15	WWN-42	LW-3	WN□A0804..., WN□G0804... WN□M0804...	
2525M-08	●	●	25	25		25	150	32										

In wedge lock, use of ceramic insert other than silicon nitride insert is not recommended due to strong restrain force.

External turning

● : Standard item R : Right-hand only L : Left-hand only □ : Check availability

Applicable inserts (DWLN / DWLN-JCT / PWLN / WWLN)

Applications	Finishing	Finishing	Finishing - Medium	Finishing - Medium	Finishing	Finishing	Finishing - Medium	Finishing - Medium
Insert								
Chipbreaker type	WF	WP	WE	WQ	PP	GP	PQ	HQ
Page	B50	B50	B50	B50	B50	B50	B50	B51
Applications	Finishing - Medium	Finishing - Medium	Medium - Roughing	Medium - Roughing	Medium - Roughing	Medium - Roughing	Medium - Roughing	Roughing
Insert								
Chipbreaker type	CQ	CJ	GS	PG	PS	PT	GT	STD
Page	B51	B51	B51	B51	B51	B51	B52	B52
Applications	Roughing	Finishing	Medium	Low carbon steel	Low carbon steel	Low carbon steel	Stainless steel / Heat-resistant alloys	Stainless steel / Heat-resistant alloys
Insert								
Chipbreaker type	PH	%L-S	R/L	XP	XQ	XS	TK	MQ
Page	B52	B54	B54	B52	B52	B52	B52	B53
Applications	Stainless steel / Heat-resistant alloys	Stainless steel / Heat-resistant alloys	Cast iron	Cast iron	Cast iron	Cast iron	Cast iron	Cast iron
Insert								
Chipbreaker type	MS	MU	KQ	KG	KH	C	ZS	GC
Page	B53	B53	B53	B53	B53	B54	B54	B54
Applications	Cast iron	Non-Ferrous Metals	Non-Ferrous Metals	Heat-resistant alloys	Hard materials / Cast iron			
Insert								
Chipbreaker type	No CB	AH	PCD	SG	CBN			
Page	B54	B54	C38	B53	C15			

In wedge lock, use of ceramic insert other than silicon nitride insert is not recommended due to strong restraint force.







Recommended cutting conditions  D69~D70



External turning

Selection guide for ceramic inserts

Select the suitable ceramic insert and specifications from the table below:

Insert shape	Corner-R (RE)	f (mm/rev)										ap (mm)
		0.10	0.15	0.20	0.25	0.30	0.35	0.40	0.45	0.50	0.60	
 RN	-	→										0.3~4
 SN	2.0	→										0.3~4
	1.6	→										
 EN	1.2	→										
	0.8	→										
 CN	0.4	→										
 TN	1.6	→										0.3~2
	1.2	→										
 DN	0.8	→										
Chamfer		0.05mm x 20°		(0.1~0.2)mm x (20°~25°)				0.3mm x 30°				-
Insert thickness		7.94mm										-

(GG25, Cutting edge angle: 0°~15°)

D

External turning

CCLN (External turning / External facing)

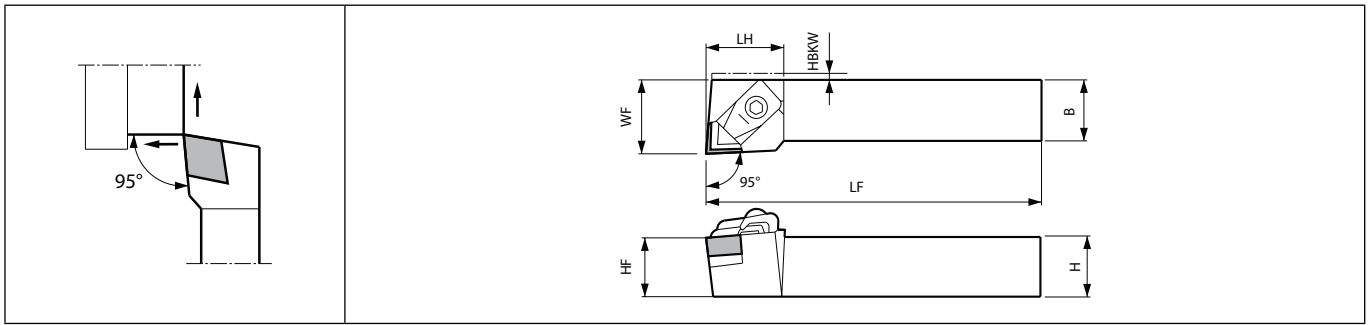

Right-hand shown



External turning

Toolholder dimensions

Description	Availability		Dimension (mm)								Standard corner-R(RE)	Side rake angle (°)	Inclination angle (°)	Spare parts					Applicable inserts
														Chipbreaker	Clamp set	Shim screw	Shim	Wrench	
	R	L	H	B	LH	HF	HBKW	LF	WF										
CCLN [°] L 2020K-12	●	●	20	20		20	5	125	27	0.8	-6	-6	CB-16	CE-010	M3X8 (M3X12*)	SP-441 (SP-443*)	LW-4	CN□N1207... (CN□N1204...*)	
2525M-12	●	●	25	25	32	25	-	150	32										
CCLN [°] L 3225P-16	●	●	32	25	35	32	-	170	32	0.8	-6	-6	CB-17	CE-220	M4X10	SP-454	LW-4	CNGN1607...	

Shims indicated * are not included with the toolholder. When using CN□N1204 type insert, please purchase shim (SP-443) and screw (M3X12) separately.

Applicable inserts

Applications	Cast iron / Hard materials	Hard materials / Cast iron
Insert		
Type	Ceramic	CBN
Page	B113	C16

Recommended cutting conditions D69~D70

● : Standard item R : Right-hand only L : Left-hand only □ : Check availability

CDJN (External turning / External copying / Back turning)

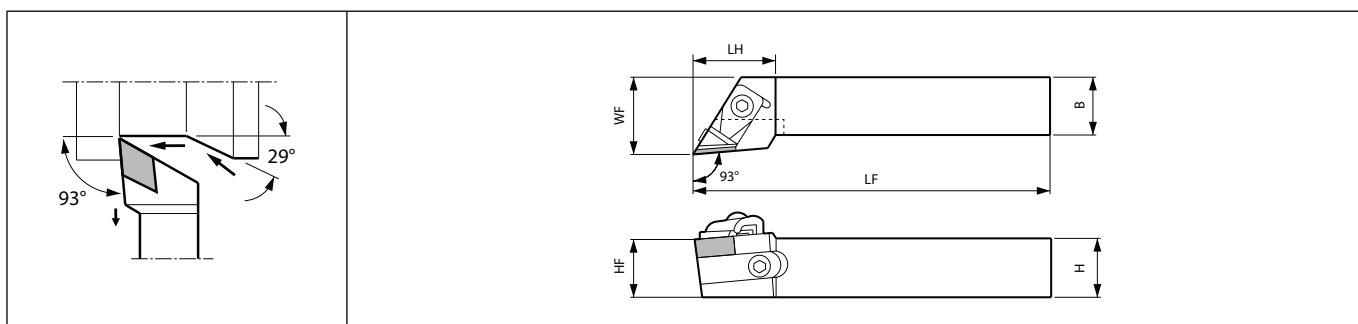

Right-hand shown

Toolholder dimensions

Description	Availability		Dimension (mm)							Standard corner-R(RE)	Side rake angle (°)	Inclination angle (°)	Spare parts					Applicable inserts
	R	L	H	B	LH	HF	LF	WF	Chipbreaker				Clamp bolt	Clamp set	Shim	Wrench		
	CDJN ¹⁾ 2525M-15 3225P-15	●	●	25	25	32	25	150	32				0.8	-5	-8			

Chipbreaker : CB-14 for Right-hand Toolholder, CB-15 for Left-hand Toolholder.

Shim : 556CR for Right-hand Toolholder, 556CL for Left-hand Toolholder.

Applicable inserts

Applications	Cast iron / Hard materials
Insert	
Type	Ceramic
Page	B114

Recommended cutting conditions D69~D70

● : Standard item R : Right-hand only L : Left-hand only □ : Check availability

CELN (External turning / External facing)

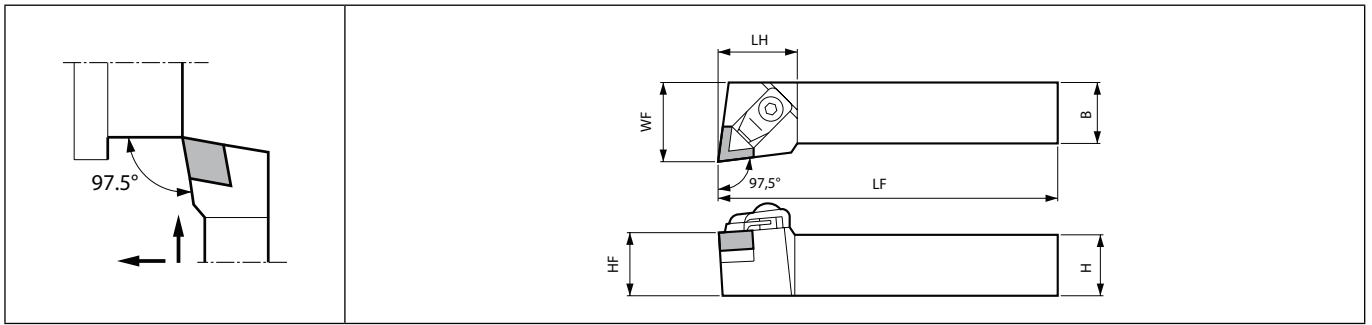

Right-hand shown



External turning

Toolholder dimensions

Description	Availability		Dimension (mm)							Standard corner-R(RE)	Side rake angle (°)	Inclination angle (°)	Spare parts					Applicable inserts
													Chipbreaker	Clamp set	Shim screw	Shim	Wrench	
	R	L	H	B	LH	HF	LF	WF										
CELN%L 2525M-13	●	●	25	25	32	25	150	32	0.8	-6	-6						ENGN1307...	

Applicable inserts

Applications	Cast iron / Hard materials
Insert	
Type	Ceramic
Page	B115

Recommended cutting conditions D69~D70

● : Standard item R : Right-hand only L : Left-hand only □ : Check availability

CSRN (External turning)

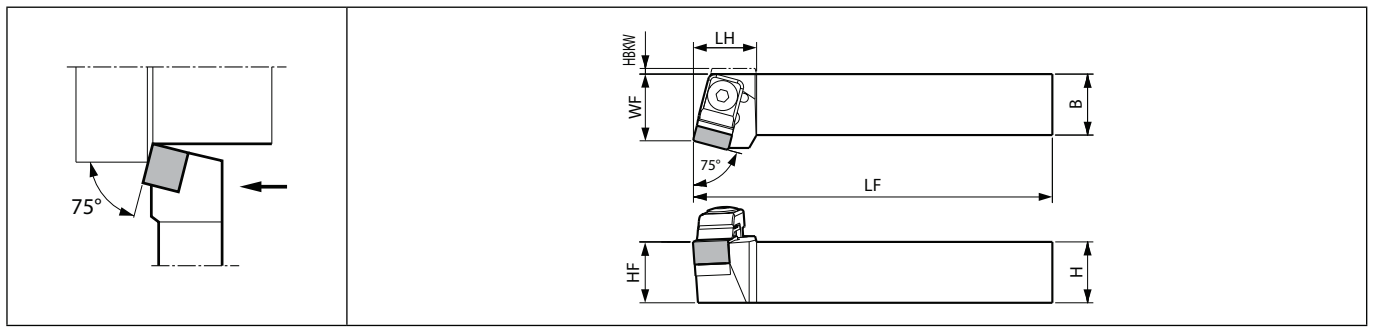

Right-hand shown

Toolholder dimensions

Description	Availability		Dimension (mm)								Standard corner-R(RE)	Side rake angle (°)	Inclination angle (°)	Spare parts					Applicable inserts
														Chipbreaker	Clamp set	Clamp set	Shim screw	Shim	
	R	L	H	B	LH	HF	HBKW	LF	WF										
CSRN%L 2020K-12	●	●	20	20	22	20	2	125	22	0.8	-6	-4		CE-020	-	M3X8 (M3X12*)	SP-141 (SP-143*)	LW-4	SN□N1207... (SN□N1204...*)
2525M-12	●	●	25	25		25	-	150	27										
3225P-12	●	●	32	25		32	-	170	27										
CSRN%L 3225P-15	●	●	32	25	30	32	-	170	32.4	1.2	-6	-4		-	CE-220	M4X10	SP-162	LW-4	SNGN1507...
4040R-15	●	●	40	40		40	-	200	43										

Shims indicated * are not included with the toolholder. When using SN□N1204 type insert, please purchase shim (SP-143) and screw (M3X12) separately.

CS-N (External turning)

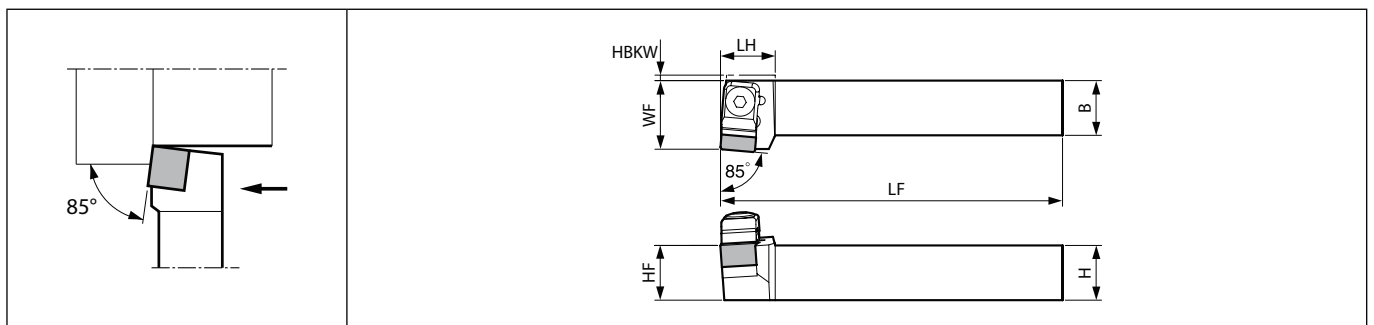

Right-hand shown

Toolholder dimensions

Description	Availability		Dimension (mm)								Standard corner-R(RE)	Side rake angle (°)	Inclination angle (°)	Spare parts					Applicable inserts
														Chipbreaker	Clamp set	Shim screw	Shim	Wrench	
	R	L	H	B	LH	HF	LF	WF											
CS-N%L 2525M-12	●	●	25	25	20	25	150	32	0.8	-6	-4		CE-020	M3X8 (M3X12*)	SP-141 (SP-143*)	LW-4	SN□N1207... (SN□N1204...*)		

Shims indicated * are not included with the toolholder. When using SN□N1204 type insert, please purchase shim (SP-143) and screw (M3X12) separately.

● : Standard item R : Right-hand only L : Left-hand only □ : Check availability

CSKN (External facing)

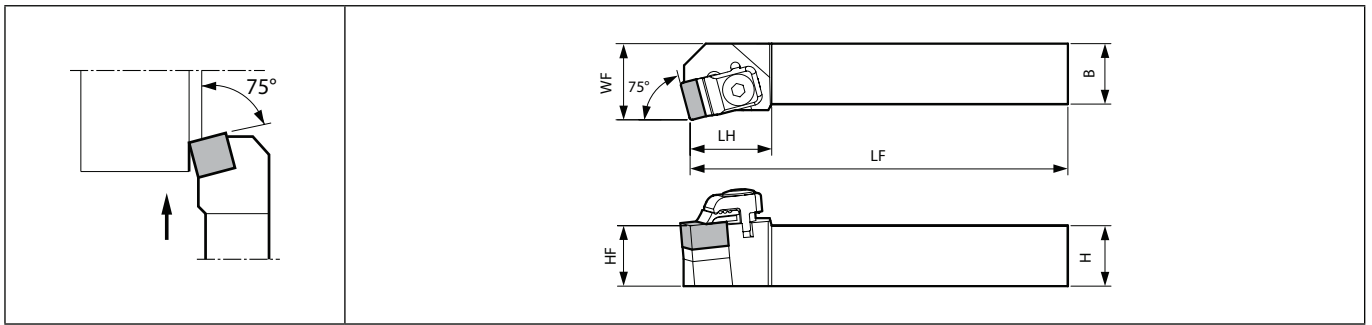

Right-hand shown

Toolholder dimensions

Description	Availability		Dimension (mm)							Standard corner-R(RE)	Side rake angle (°)	Inclination angle (°)	Spare parts						Applicable inserts
													Chipbreaker	Clamp set	Clamp set	Shim screw	Shim	Wrench	
	R	L	H	B	LH	HF	LF	WF											
CSKN%L 2020K-12	●		20	20	27	20	125	25	0.8	-6	-4	CB-11	CE-020	-	M3X8 (M3X12*)	SP-141 (SP-143*)	LW-4	SN□N1207... (SN□N1204...*)	
2525M-12	●	●	25	25		25	150	32											
CSKNR 3225P-15	●		32	25	37	32	170	32	1.2	-6	-4	CB-51	-	CE-220	M4X10	SP-162	LW-4	SNGN1507...	

Shims indicated * are not included with the toolholder. When using SN□N1204 type insert, please purchase shim (SP-143) and screw (M3X12) separately.

CSYN (External facing)

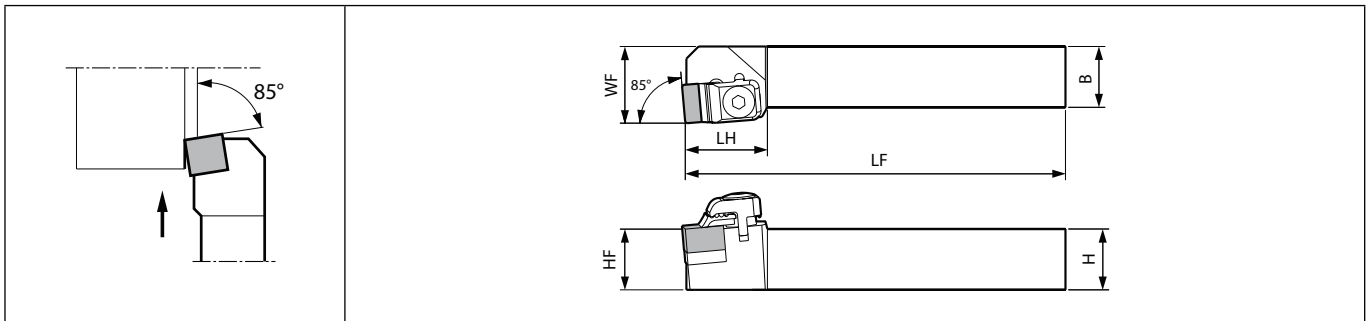

Right-hand shown

Toolholder dimensions

Description	Availability		Dimension (mm)							Standard corner-R(RE)	Side rake angle (°)	Inclination angle (°)	Spare parts					Applicable inserts
													Chipbreaker	Clamp set	Shim screw	Shim	Wrench	
	R	L	H	B	LH	HF	LF	WF										
CSYN%L 2525M-12	●	●	25	25	27	25	150	32	0.8	-6	-4	CB-11	CE-020	M3X8 (M3X12*)	SP-141 (SP-143*)	LW-4	SN□N1207... (SN□N1204...*)	

Shims indicated * are not included with the toolholder. When using SN□N1204 type insert, please purchase shim (SP-143) and screw (M3X12) separately.

● : Standard item R : Right-hand only L : Left-hand only □ : Check availability



CSSN (External turning / External facing / Chamfering)

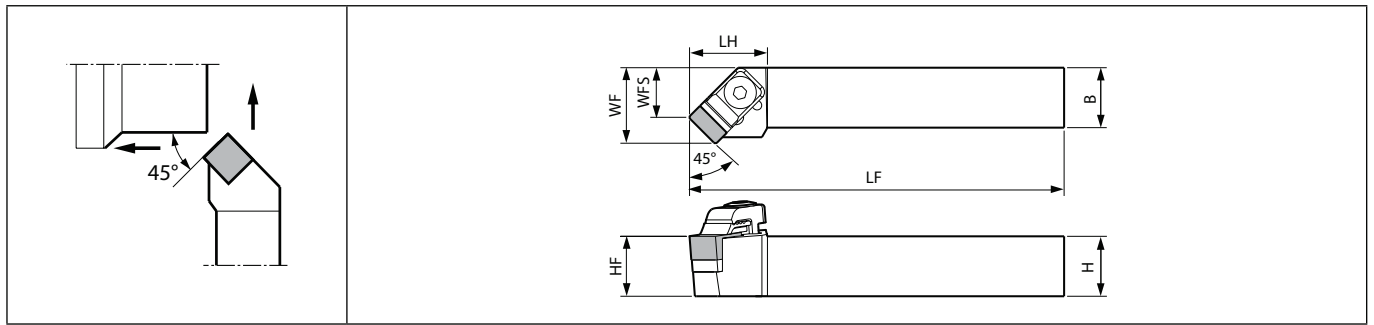

Right-hand shown

Toolholder dimensions

Description	Availability		Dimension (mm)							Standard corner-R(RE)	Standard rake angle (°)	Side rake angle (°)	Inclination angle (°)	Spare parts					Applicable inserts
	R	L	H	B	LH	HF	LF	WF	WFS					Chipbreaker	Clamp set	Shim screw	Shim	Wrench	
	CSSN%L 2020K-12	●		20	20	26	20	125	25					16	0.8	-6	0	CB-11	
2525M-12	●	●	25	25	25		150	32	23										

Shims indicated * are not included with the toolholder. When using SN□N1204 type insert, please purchase shim (SP-143) and screw (M3X12) separately.

CSDN (External turning / Chamfering)

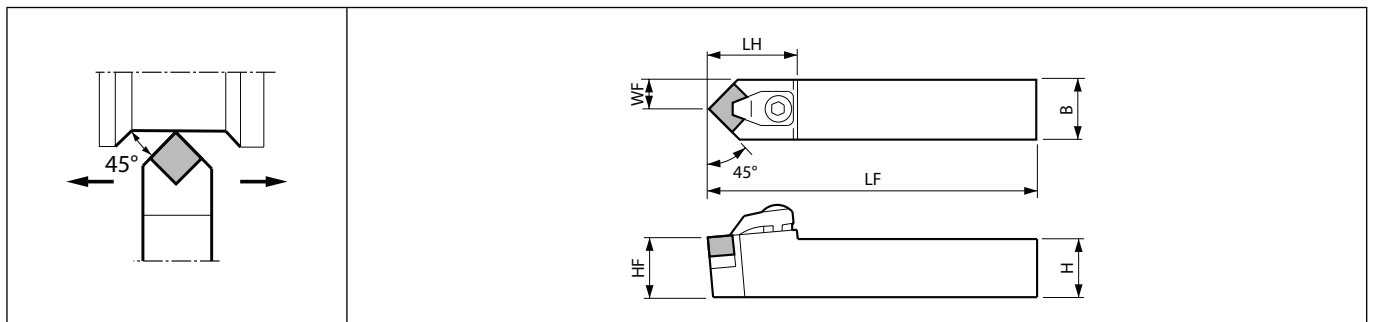

Toolholder dimensions

Description	Availability		Dimension (mm)							Standard corner-R(RE)	Back rake angle (°)	Spare parts				Applicable inserts
	N	H	B	LH	HF	LF	WF	Clamp set	Shim screw			Shim	Wrench			
	CSDNN 2020K-12	●	20	20		20	125	10	0.8			-8.5	CE-040	M3X8 (M3X12*)	SP-141 (SP-143*)	
2525M-12	●	25		32	25	150	12.5									
3225P-12	●	32	25		32	170										



Shims indicated * are not included with the toolholder. When using SN□N1204 type insert, please purchase shim (SP-143) and screw (M3X12) separately.

D

External turning





● : Standard item R : Right-hand only L : Left-hand only □ : Check availability

Applicable inserts

Applications	Cast iron / Hard materials	Cast iron	Hard materials / Cast iron
Type	Ceramic	Coated carbide	CBN
Insert			
Toolholder			
CSR ^N /L ...-12	SNGN1207..(SNGN1204..) SNMN1207..	(SNMN1204..)	(SNMN1204..)
CSR ^N /L ...-15	SNGN1507..	-	-
CS-N ^N /L ...-12	SNGN1207..(SNGN1204..) SNMN1207..	(SNMN1204..)	(SNMN1204..)
CSKN ^N /L ...-12	SNGN1207..(SNGN1204..) SNMN1207..	(SNMN1204..)	(SNMN1204..)
CSKN ^N /L ...-15	SNGN1507..	-	-
CSYN ^N /L ...-12	SNGN1207..(SNGN1204..) SNMN1207..	(SNMN1204..)	(SNMN1204..)
CSSN ^N /L ...-12	SNGN1207..(SNGN1204..) SNMN1207..	(SNMN1204..)	(SNMN1204..)
CSDNN ...-12	SNGN1207..(SNGN1204..) SNMN1207..	(SNMN1204..)	(SNMN1204..)
Page	B117	B38	C18

Recommended cutting conditions  D69~D70

Spare parts (When using as toolholder for CBN tools (KBN900), please purchase separately.)

Applications	Hard materials / Cast iron	Spare parts		
Type	CBN	Clamp set	Shim	Shim screw
Insert				
Toolholder				
CSR ^N /L ...-12	(SNMN1204..)	CE-030A	SP-143	M3X12
CSR ^N /L ...-15	-	-	-	-
CS-N ^N /L ...-12	(SNMN1204..)	CE-030A	SP-143	M3X12
CSKN ^N /L ...-12	(SNMN1204..)	CE-030A	SP-143	M3X12
CSKN ^N /L ...-15	-	-	-	-
CSYN ^N /L ...-12	(SNMN1204..)	CE-030A	SP-143	M3X12
CSSN ^N /L ...-12	(SNMN1204..)	CE-030A	SP-143	M3X12
CSDNN ...-12	(SNMN1204..)	*-	SP-143	M3X12

* CSDNN...-12 : Clamp Set CE-040 is used continuously.



External turning

CTJN (External turning)

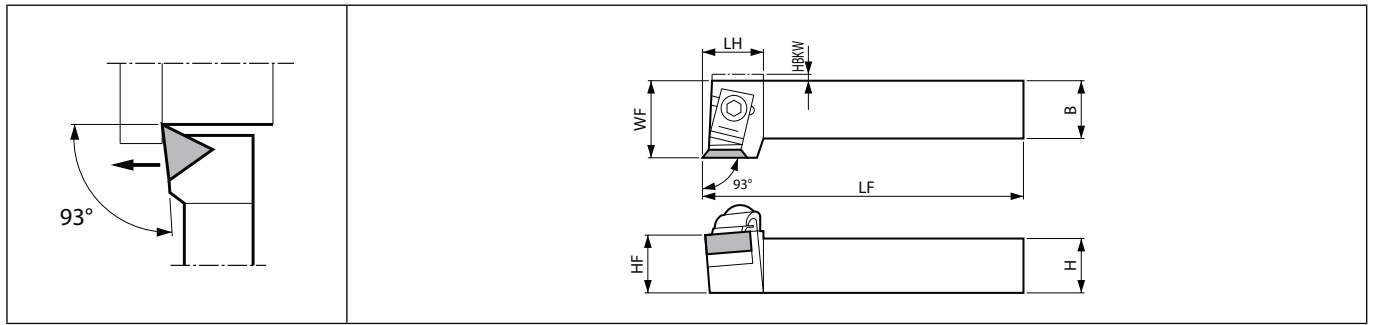

Right-hand shown

Toolholder dimensions

Description	Availability		Dimension (mm)							Standard corner-R(RE)	Side rake angle (°)	Inclination angle (°)	Spare parts					Applicable inserts
	R	L	H	B	LH	HF	HBKW	LF	WF				Chipbreaker	Clamp set	Shim screw	Shim	Wrench	
	CTJN%L 2020K-16 2525M-16	●	●	20	20	21	20	2	125				25	0.8	-6	-4		

Chipbreaker : CB-12 for Right-hand Toolholder, CB-13 for Left-hand Toolholder.

Shims indicated * are not included with the toolholder. When using TN□N1604 type insert, please purchase shim (SP-223) and screw (M3X12) separately.

CTUN (External facing)

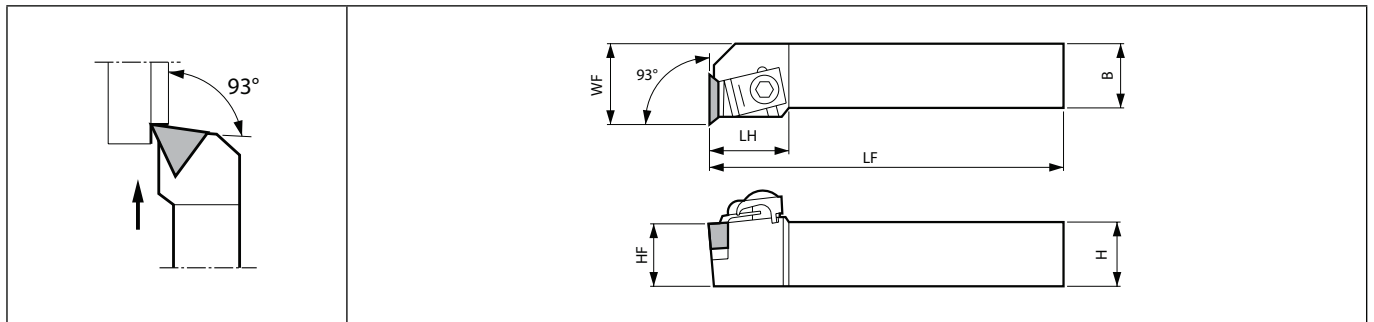

Right-hand shown

Toolholder dimensions



Description	Availability		Dimension (mm)							Standard corner-R(RE)	Side rake angle (°)	Inclination angle (°)	Spare parts					Applicable inserts
	R	L	H	B	LH	HF	LF	WF	Chipbreaker				Clamp set	Shim screw	Shim	Wrench		
	CTUN%L 2020K-16 2525M-16		●	20	20	27	20	125	25				0.8	-6	-4			

Chipbreaker : CB-13 for Right-hand Toolholder, CB-12 for Left-hand Toolholder.

Shims indicated * are not included with the toolholder. When using TN□N1604 type insert, please purchase shim (SP-223) and screw (M3X12) separately.

● : Standard item R : Right-hand only L : Left-hand only □ : Check availability

Applicable inserts (CTJN / CTUN)

Applications	Cast iron / Hard materials	Hard materials / Cast iron
Insert		
Type	Ceramic	CBN
Page	B118	C19

Recommended cutting conditions  D69~D70



External turning

CRSN (External turning / External facing)

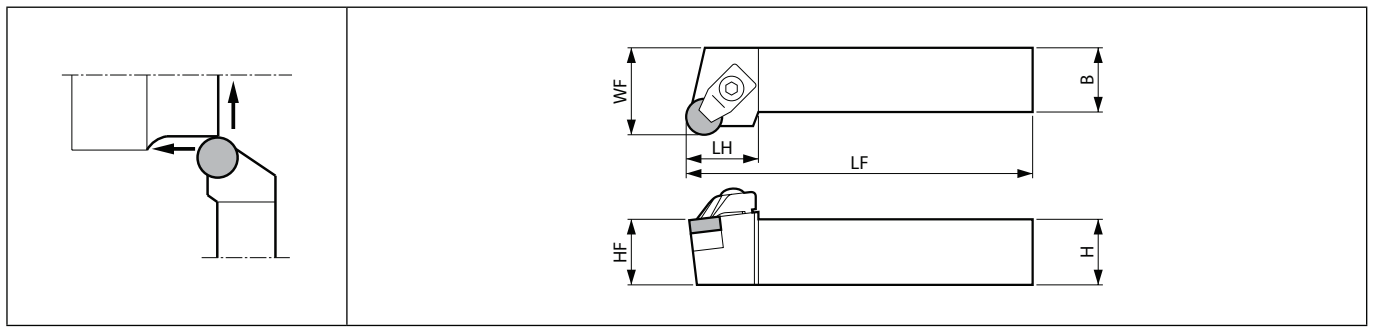

Right-hand shown

D

External turning

Toolholder dimensions

Description	Availability		Dimension (mm)							Side rake angle (°)	Inclination angle (°)	Spare parts				Applicable inserts			
	R	L	H	B	LH	HF	LF	WF	Clamp set			Shim screw	Shim	Wrench					
	CRSN%L 2020K-12	●	●	20	20		20	125	25										
2525M-12	●	●	25		26	25	150												
3225P-12	●	●	32	25		32	170	32											

Shims indicated * are not included with the toolholder. When using RN□N1204 type insert, please purchase shim (SP-843) and screw (M3X12) separately.

CRDN (External turning / External copying)

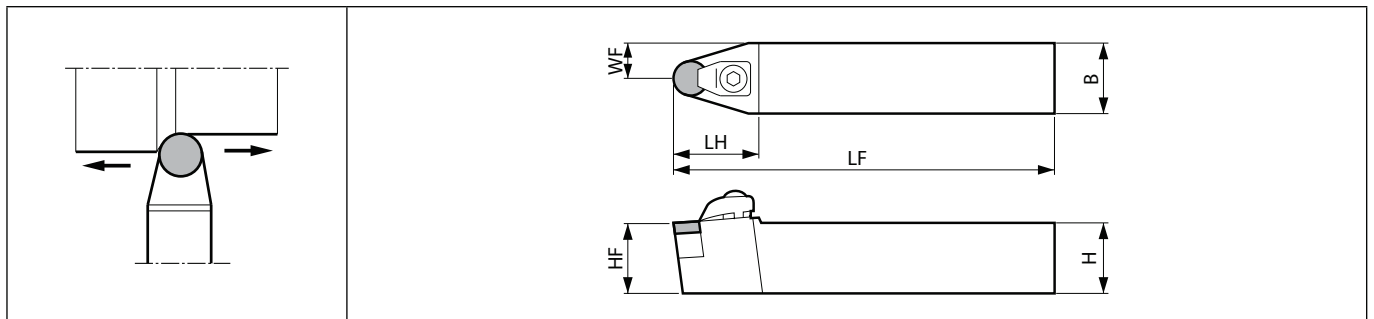



Toolholder dimensions

Description	Availability		Dimension (mm)							Back rake angle (°)	Spare parts				Applicable inserts				
	N	H	B	LH	HF	LF	WF	Clamp set	Shim screw		Shim	Wrench							
	CRDNN 2020K-12	●	20	20		20	125	10											
2525M-12	●	25		28	25	150													
3225P-12	●	32	25		32	170	12.5												
CRDNN 3232P-15	●	32	32		32	170	16												
4040R-15	●	40	40	35	40	200	20												

Shims indicated * are not included with the toolholder. When using RN□N1204 type insert, please purchase shim (SP-843) and screw (M3X12) separately.





● : Standard item R : Right-hand only L : Left-hand only □ : Check availability

Applicable inserts

Applications	Cast iron / Hard materials	Hard materials / Cast iron
Type	Ceramic	CBN
Insert		
Toolholder		
CRSN [®] /L ...-12	RNGN120700 (RNGN120400)	(RNMN120400)
CRDNN ...-12	RNGN120700 (RNGN120400)	(RNMN120400)
CRDNN ...-15	RNGN150700	-
Page	B116	C17

Recommended cutting conditions  D69~D70

Spare parts (When using as toolholder for CBN tools (KBN900), please purchase separately.)

Applications	Hard materials / Cast iron	Spare parts		
Type	CBN	Clamp set	Shim	Shim screw
Insert				
Toolholder				
CRSN [®] /L ...-12	(RNMN120400)	CE-030A	SP-843	M3X12
CRDNN ...-12	(RNMN120400)	CE-030A	SP-843	M3X12
CRDNN ...-15	-	-	-	-



External turning

CCRN-A (External turning)

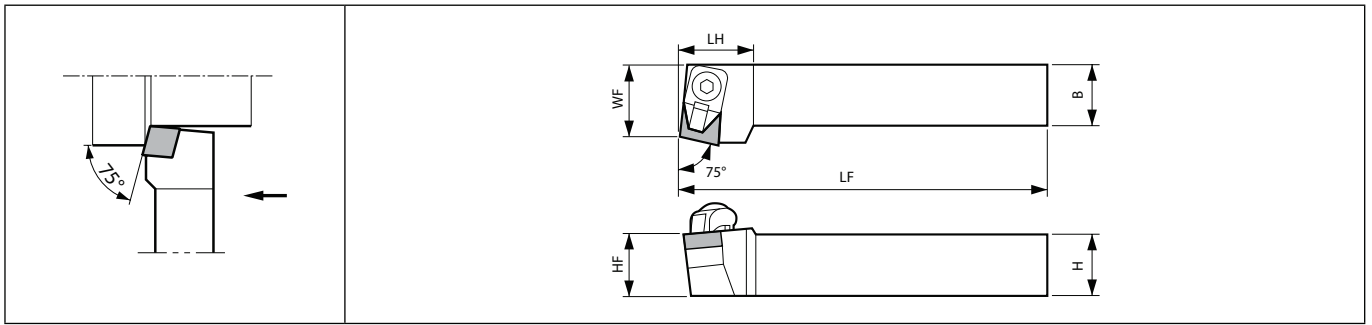

Right-hand shown

Toolholder dimensions

Description	Availability		Dimension (mm)							Standard corner-R(RE)	Side rake angle (°)	Inclination angle (°)	Spare parts				Applicable inserts
	R	L	H	B	LH	HF	LF	WF	Clamp set				Shim screw	Shim	Wrench		
	CCRN%L 2525M-09A	●		25	25	27	25	150	27				0.8	-6	-6	CE-030A	

CCLN-A (External turning / External facing)

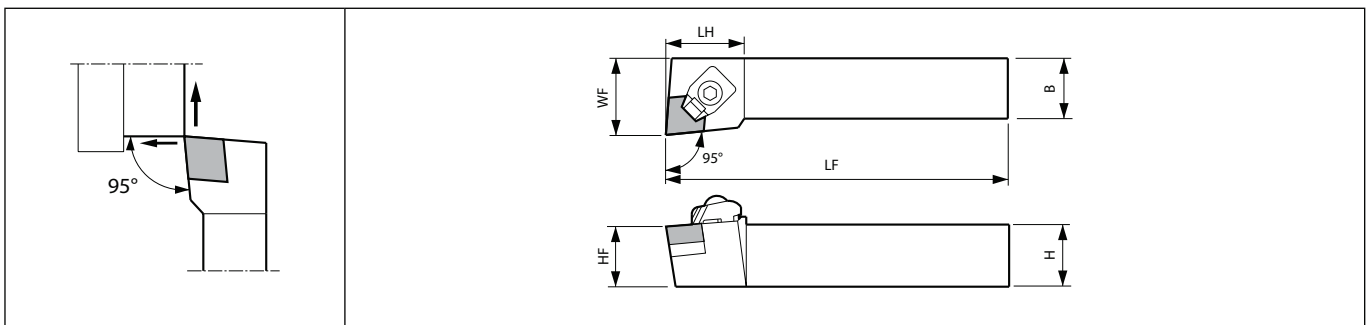

Right-hand shown

Toolholder dimensions

Description	Availability		Dimension (mm)							Standard corner-R(RE)	Side rake angle (°)	Inclination angle (°)	Spare parts				Applicable inserts
	R	L	H	B	LH	HF	LF	WF	Clamp set				Shim screw	Shim	Wrench		
	CCLN%L 2525M-09A	●	●	25	25	28	25	150	32				0.8	-5	-5	CE-030A	

For CNMN1204 Insert toolholder, see page D49

Applicable inserts

Applications	Hard materials / Cast iron
Insert	
Type	CBN
Page	C16

Recommended cutting conditions D69~D70

● : Standard item R : Right-hand only L : Left-hand only □ : Check availability

CRSN-A (External turning / External facing)

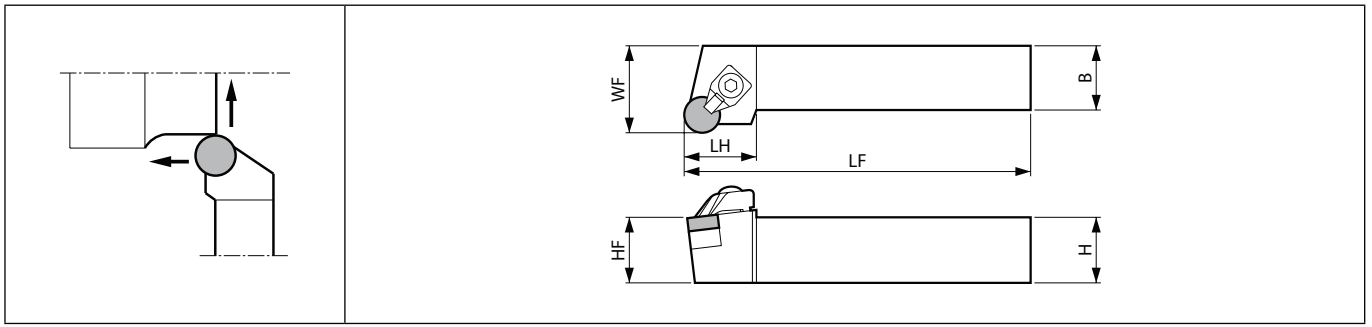

Right-hand shown

Toolholder dimensions

Description	Availability		Dimension (mm)							Side rake angle (°)	Inclination angle (°)	Spare parts						Applicable inserts
												Clamp set	Shim screw	Shim screw	Shim	Shim	Wrench	
	R	L	H	B	LH	HF	LF	WF										
CRSN%L 2525M-09A 3225P-09A	●	●	25	25	26	25	150	32	-6	-6	CE-030A	-	HH3X12	SP-829 (SP-826*)	-	LW-4	RNMN0903... (RNGN0904...*)	
CRSN%L 2525M-12A 3225P-12A	●	●	25	25	26	25	150	32	-6	-6	CE-030A	BH3X12	-	-	SP-849 (SP-843***) (SP-841***)	LW-4	RNMN1203... (RN□N1204...***) (RNGN1207...***)	

When using RNGN0904 type insert, please purchase shim (SP-826) separately.
 When using RN□N1204 type insert, please purchase shim (SP-843) separately.
 When using RNGN1207 type insert, please purchase shim (SP-841) separately.

CRDN-A (External turning / External copying)

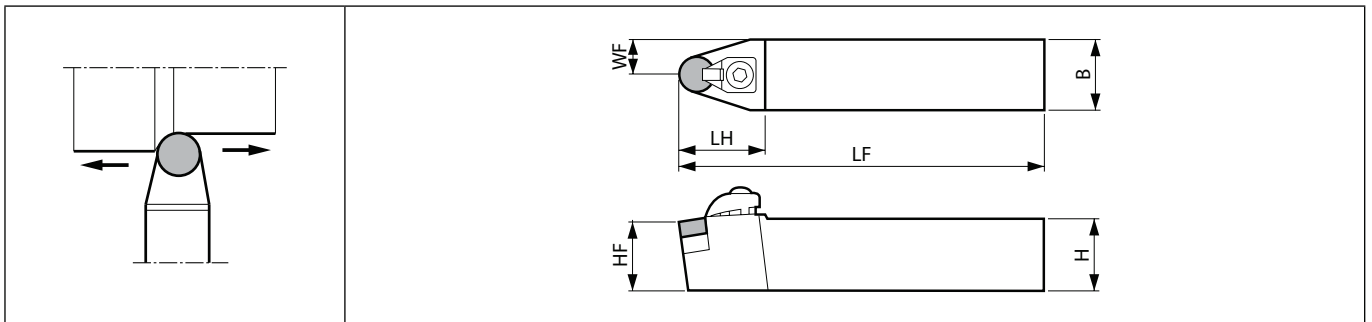

Toolholder dimensions

Description	Availability		Dimension (mm)							Back rake angle (°)	Spare parts						Applicable inserts
											Clamp set	Shim screw	Shim screw	Shim	Shim	Wrench	
	N	H	B	LH	HF	LF	WF										
CRDNN 2525M-09A 3225P-09A	●	25	25	29	25	150	12.5	-8.5	CE-030A	-	HH3X12	SP-829 (SP-826*)	-	LW-4	RNMN0903... (RNGN0904...*)		
CRDNN 2525M-12A 3225P-12A	●	25	25	28	25	150	12.5	-8.5	CE-030A	BH3X12	-	-	SP-849 (SP-843***) (SP-841***)	LW-4	RNMN1203... (RN□N1204...***) (RNGN1207...***)		



When using RNGN0904 type insert, please purchase shim (SP-826) separately.
 When using RN□N1204 type insert, please purchase shim (SP-843) separately.
 When using RNGN1207 type insert, please purchase shim (SP-841) separately.

● : Standard item R : Right-hand only L : Left-hand only □ : Check availability





External turning

Applicable inserts

Applications	Hard materials / Cast iron	Cast iron / Hard materials
Type	CBN	Ceramic
Insert		
Toolholder		
CRSN [®] /L ...-09A	RNMN090300	(RNGN090400)
CRSN [®] /L ...-12A	RNMN120300 (RNMN120400)	(RNGN120400) (RNGN120700)
CRDNN ...-09A	RNMN090300	(RNGN090400)
CRDNN ...-12A	RNMN120300 (RNMN120400)	(RNGN120400) (RNGN120700)
Page	C17	B116

Recommended cutting conditions  D69~D70

Spare parts (When using as toolholder for Ceramic tools, please purchase separately.)

Applications	Cast iron / Hard materials	Spare parts	
Type	Ceramic	Shim	Shim screw
Insert			
Toolholder			
CRSN [®] /L ...-09A	(RNGN090400)	SP-826	-
CRSN [®] /L ...-12A	(RNGN120400)	SP-843	M3X12
	(RNGN120700)	SP-841	M3X8
CRDNN ...-09A	(RNGN090400)	SP-826	-
CRDNN ...-12A	(RNGN120400)	SP-843	M3X12
	(RNGN120700)	SP-841	M3X8

D



External turning

CSRN-A (External turning)

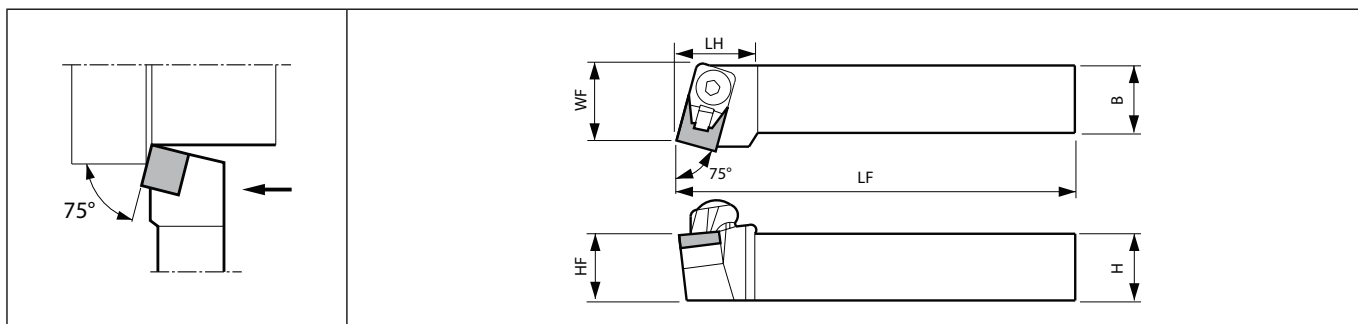

Right-hand shown



External turning

Toolholder dimensions

Description	Availability		Dimension (mm)							Standard corner-R(RE)	Side rake angle (°)	Inclination angle (°)	Spare parts				Applicable inserts
	R	L	H	B	LH	HF	LF	WF	Clamp set				Shim screw	Shim	Wrench		
	CSRN%L 2525M-12A	●	●	25	25	22	25	150	27				0.8	-6	-4		

When using SN□N1204 type insert, please purchase shim (SP-143) separately.

CSKN-A (External facing)

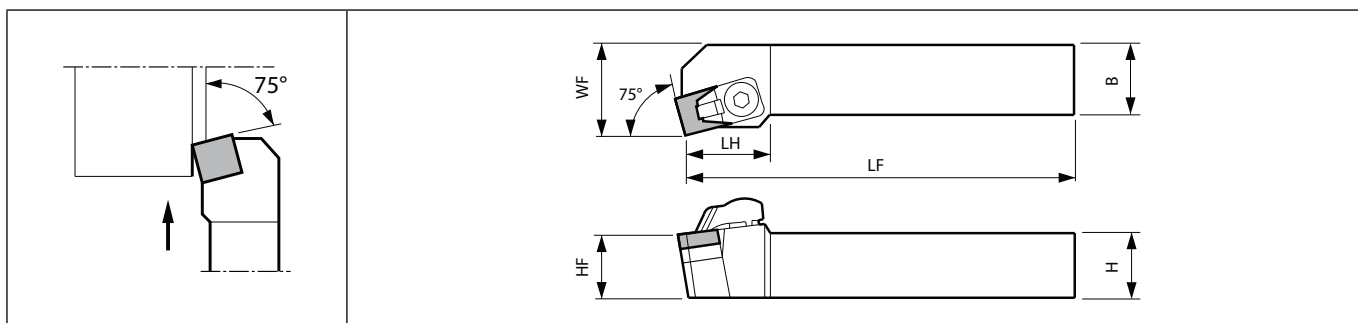

Right-hand shown

Toolholder dimensions

Description	Availability		Dimension (mm)							Standard corner-R(RE)	Side rake angle (°)	Inclination angle (°)	Spare parts				Applicable inserts
	R	H	B	LH	HF	LF	WF	Clamp set	Shim screw				Shim	Wrench			
	CSKNR 2525M-09A	●		25	25	27	25	150	32				0.8	-6	-4		

● : Standard item R : Right-hand only L : Left-hand only □ : Check availability

CSSN-A (External turning / External facing / Chamfering)

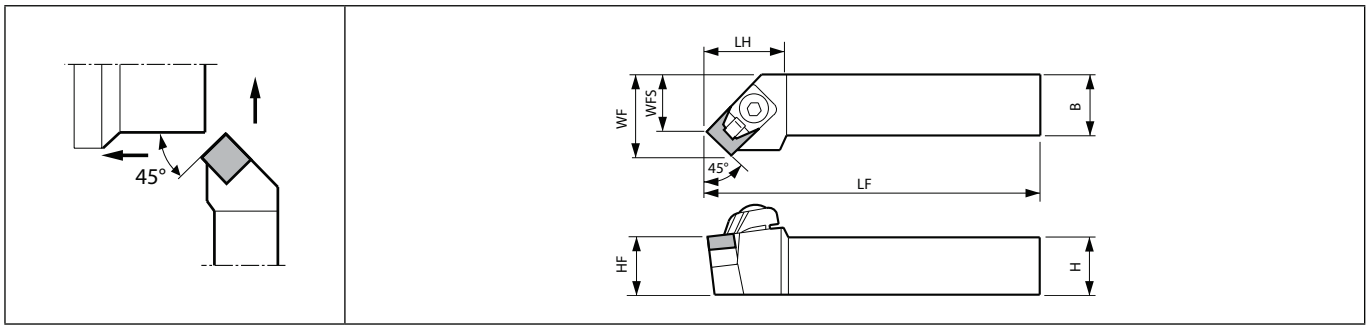

Right-hand shown

Toolholder dimensions

Description	Availability		Dimension (mm)								Standard corner-R(RE)		Side rake angle (°)		Inclination angle (°)		Spare parts						Applicable inserts
																	Clamp set	Shim screw	Shim screw	Shim	Shim	Wrench	
	R	L	H	B	LH	HF	LF	WF	WFS	Standard corner-R(RE)	Side rake angle (°)	Inclination angle (°)											
CSSN%L 2525M-09A	●	●	25	25	26	25	150	32	25	0.8	-6	0	CE-030A	-	HH3X12	SP-129	-	LW-4	SNMN0903...				
CSSN%L 2525M-12A	●	●	25	25	26	25	150	32	23	0.8	-6	0	CE-030A	BH3X12	-	-	SP-148 (SP-143*) (SP-141*)	LW-4	SNMN1203... (SN□N1204...*) (SN□N1207...*)				

When using SN□N1204 type insert, please purchase shim (SP-143) separately. When using SN□N1207 type insert, please purchase shim (SP-141) separately.

CSDN-A (External turning / Chamfering)

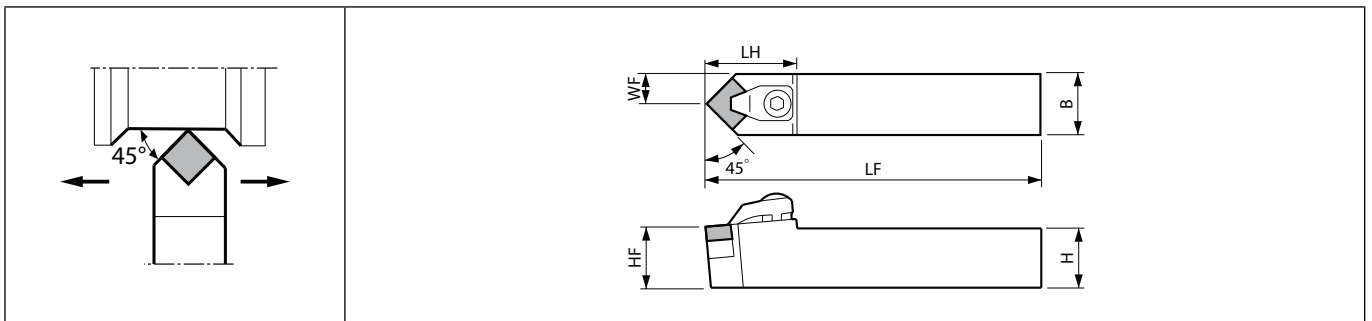



Toolholder dimensions

Description	Availability		Dimension (mm)							Standard corner-R(RE)		Back rake angle (°)		Spare parts						Applicable inserts
														Clamp set	Shim screw	Shim screw	Shim	Shim	Wrench	
	N	H	B	LH	HF	LF	WF	Standard corner-R(RE)	Back rake angle (°)											
CSDNN 2525M-09A	●		25	25	32	25	150	12.5	0.8	-8.5	CE-040	-	HH3X12	SP-129	-	LW-4	SNMN0903...			
CSDNN 2525M-12A	●		25	25	32	25	150	12.5	0.8	-8.5	CE-040	BH3X12	-	-	SP-148 (SP-143*) (SP-141*)	LW-4	SNMN1203... (SN□N1204...*) (SN□N1207...*)			

When using SN□N1204 type insert, please purchase shim (SP-143) separately. When using SN□N1207 type insert, please purchase shim (SP-141) separately.

● : Standard item R : Right-hand only L : Left-hand only □ : Check availability

Applicable inserts





Applications	Hard materials / Cast iron	Cast iron	Cast iron / Hard materials
Type	CBN	Coated carbide	Ceramic
Insert			
Toolholder			
CSRN [®] /L ...-12A	SNMN1203.. (SNMN1204..)	(SNMN1204..)	(SNGN1204..)(SNMN1204..) (SNGN1207..)(SNMN1207..)
CSKN [®] /L ...-09A	SNMN0903..	-	-
CSSN [®] /L ...-09A	SNMN0903..	-	-
CSSN [®] /L ...-12A	SNMN1203.. (SNMN1204..)	(SNMN1204..)	(SNGN1204..)(SNMN1204..) (SNGN1207..)(SNMN1207..)
CSDNN ...-09A	SNMN0903..	-	-
CSDNN ...-12A	SNMN1203.. (SNMN1204..)	(SNMN1204..)	(SNGN1204..)(SNMN1204..) (SNGN1207..)(SNMN1207..)
Page	C18	B38	B117

Recommended cutting conditions  D69~D70



External turning

Spare parts (When using as toolholder for Ceramic tools, please purchase separately.)

Applications	Cast iron / Hard materials	Spare parts			
Type	Ceramic	Chipbreaker	Clamp set	Shim	Shim screw
Insert					
Toolholder					
CSRN [®] /L ...-12A	(SNGN1204..)(SNMN1204..) (SNGN1207..)(SNMN1207..)	CB-11	CE-020	SP-143 SP-141	M3X12 M3X8
CSKN [®] /L ...-09A	-	-	-	-	-
CSSN [®] /L ...-09A	-	-	-	-	-
CSSN [®] /L ...-12A	(SNGN1204..)(SNMN1204..) (SNGN1207..)(SNMN1207..)	CB-11	CE-020	SP-143 SP-141	M3X12 M3X8
CSDNN ...-09A	-	-	-	-	-
CSDNN ...-12A	(SNGN1204..)(SNMN1204..) (SNGN1207..)(SNMN1207..)	-	-	SP-143 SP-141	M3X12 M3X8

CTJN-A (External turning)

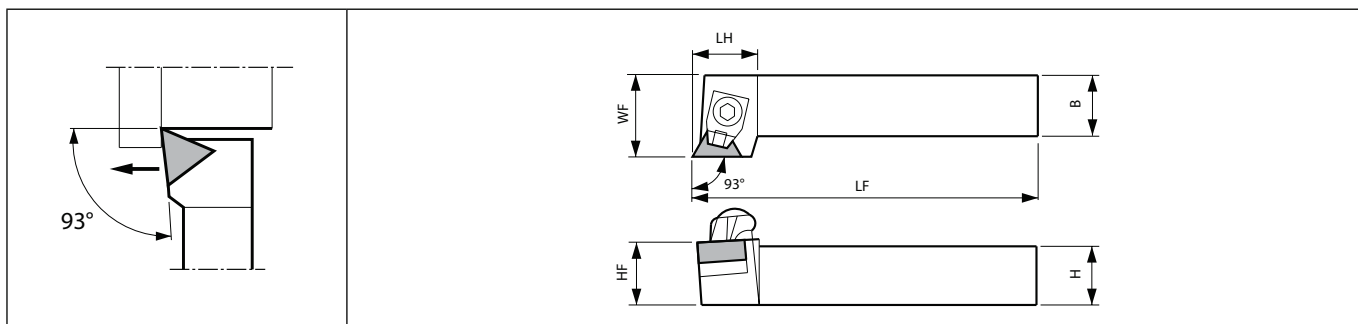

Right-hand shown

External turning

Toolholder dimensions

Description	Availability		Dimension (mm)							Standard corner-R(RE)	Side rake angle (°)	Inclination angle (°)	Spare parts				Applicable inserts
	R	L	H	B	LH	HF	LF	WF	Clamp set				Shim screw	Shim	Wrench		
	CTJN [°] L 2525M-11A	●	●	25	25	22	25	150	32				0.8	-6	-4		

For TNMN1604 Insert toolholder, see page D56.

Applicable inserts

Applications	Hard materials / Cast iron	Cast iron / Hard materials
Insert		
Type	CBN	Ceramic
Page	C19	B118

Recommended cutting conditions ➔ D69~D70

● : Standard item R : Right-hand only L : Left-hand only □ : Check availability

PRGC-BE (External turning)

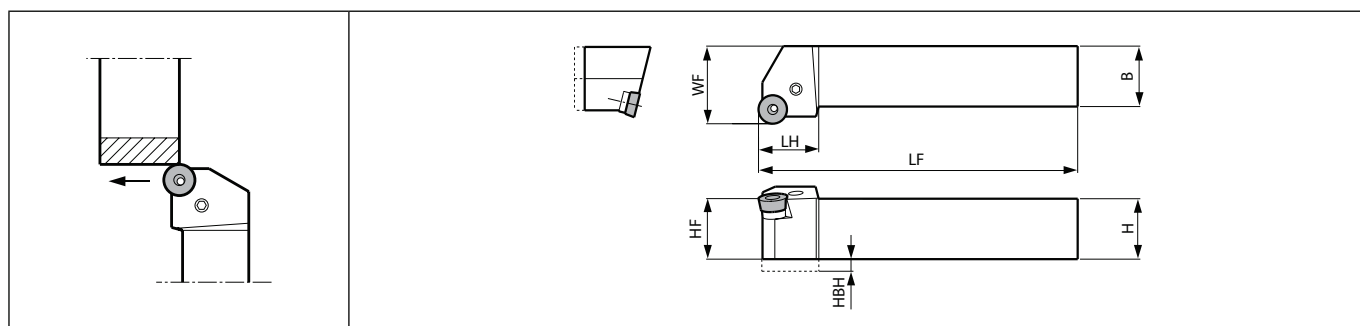





Right-hand shown





External turning

Toolholder dimensions

Description	Availability	Dimension (mm)						Spare parts						Applicable inserts
								Lever	Lock screw	Punch	Shim pin	Shim	Wrench	
		R	H	B	LH	HF	LF	WF						
PRGCR 2525M-12BE	●	25	25	25	25	150	32	LL-1CN	LS-1N	PC-1	LSP-1	LR-12C	FH-2.5	RCMT1204M0-BB

Applicable inserts

Applications	Finishing
Insert	
Chipbreaker type	BB
Page	B109

Recommended cutting conditions  D69~D70

● : Standard item R : Right-hand only L : Left-hand only □ : Check availability



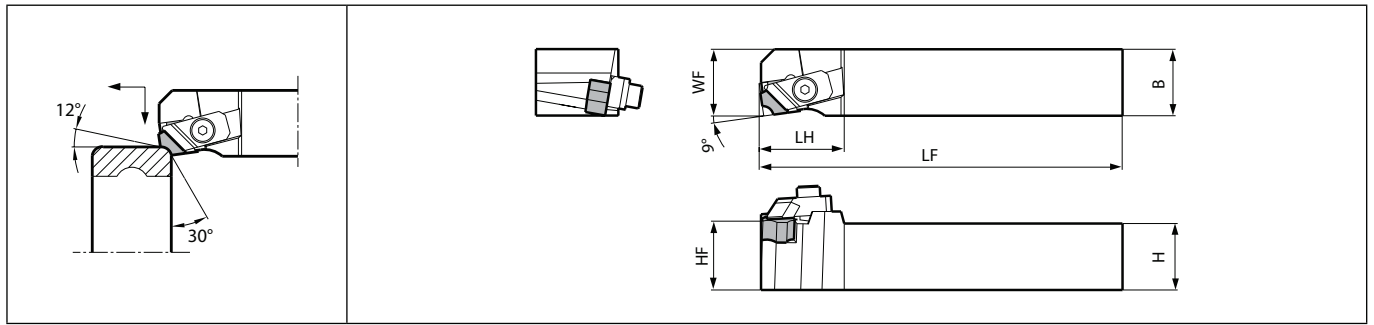

CBSN (External round chamfering)



Right-hand shown

External turning

Toolholder dimensions

Description	Availability		Dimension (mm)							Spare parts				Applicable inserts
										Clamp set	Shim screw	Shim	Wrench	
	R	L	H	B	LH	HF	LF	WF						
CBSN ^{R/L} 2020K-12	●	●	20	20	32	20	125	20	CP-RC ^{R/L}	SP3X8	SP-RC	LW-5	SNMF1204..-21	
2525M-12	●	●	25	25		25	150	25						

Clamp Set : CP-RCR for Right-hand Toolholder, CP-RCL for Left-hand Toolholder.

Applicable inserts

Applications	Finishing
Insert	
Chipbreaker type	21
Page	B109

Recommended cutting conditions  D69~D70

Tooling for bearing machining

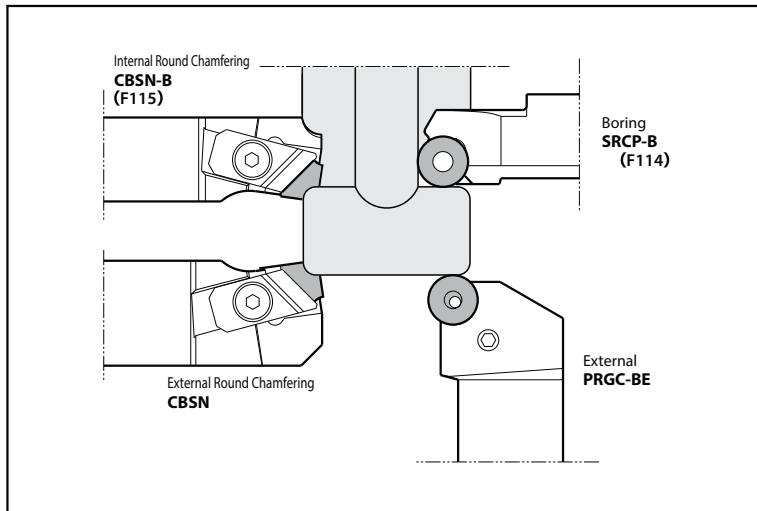

● : Standard item R : Right-hand only L : Left-hand only □ : Check availability

External turning - Negative insert

ap indicates radius

ISO Classification	Workpiece material	Hardness	Cutting range	Applications	Recommended chipbreaker	Recommended insert grade	Corner-R(RE)	Lower Limit - Recommendation - Upper Limit		
								Vc (m/min)	ap (mm)	f (mm/rev)
P	Low carbon steel Low carbon alloy	HB ≤ 300	Finishing (High Speed Machining)	Continuous	XP	CCX	0.8	300 - 600 - 800	0.2 - 0.5 - 0.7	0.07 - 0.12 - 0.2
			Finishing (Small ap)	Continuous Interruption	XF	PV710 PV720	0.4 0.8	250 - 350 - 520 240 - 320 - 480	0.05 - 0.12 - 0.6 0.05 - 0.15 - 0.6	0.03 - 0.1 - 0.22 0.04 - 0.12 - 0.25
			Finishing (Gloss Oriented)	Continuous Interruption	XP	TN610 TN620	0.4 0.8	250 - 320 - 400 240 - 310 - 370	0.2 - 0.5 - 0.7 0.2 - 0.5 - 0.7	0.07 - 0.12 - 0.2 0.07 - 0.12 - 0.2
			Finishing (Tool Life Oriented)	Continuous Interruption	XP	PV710 PV720	0.4 0.8	250 - 300 - 370 240 - 290 - 340	0.2 - 0.5 - 0.7 0.2 - 0.5 - 0.7	0.07 - 0.12 - 0.2 0.07 - 0.12 - 0.2
			Finishing - Medium (Gloss Oriented)	Continuous Interruption	XQ	TN610 TN620	0.4 0.8	250 - 320 - 400 240 - 280 - 340	0.5 - 1.0 - 1.5 0.5 - 1.0 - 1.5	0.17 - 0.25 - 0.3 0.17 - 0.25 - 0.3
			Finishing - Medium (Tool Life Oriented)	Continuous Interruption	XQ	PV710 PV720	0.8 0.8	250 - 300 - 370 240 - 280 - 340	0.5 - 1.0 - 1.5 0.5 - 1.0 - 1.5	0.17 - 0.25 - 0.3 0.17 - 0.25 - 0.3
			Medium - Roughing	Continuous Interruption	XS	PV720 CA515	0.8 0.8	220 - 260 - 320 160 - 210 - 260	0.8 - 1.5 - 2.0 0.8 - 1.5 - 2.0	0.25 - 0.3 - 0.4 0.25 - 0.3 - 0.4
			Roughing	Continuous Interruption	PG	CA515 CA025P	0.8 1.2	180 - 220 - 260 150 - 200 - 240	1.0 - 2.5 - 3.5 1.0 - 2.5 - 3.5	0.2 - 0.3 - 0.4 0.2 - 0.3 - 0.4
			Medium - Roughing High Feed Rate	Continuous Interruption	PT	CA515 CA025P	0.8 1.2	150 - 200 - 240 120 - 180 - 220	1.5 - 3.0 - 4.5 1.5 - 3.0 - 4.5	0.25 - 0.35 - 0.45 0.25 - 0.35 - 0.45
			Roughing High Feed Rate	Continuous Interruption	PH	CA515 CA025P	1.2 1.6	150 - 200 - 240 120 - 180 - 220	2.0 - 5.0 - 8.0 2.0 - 5.0 - 8.0	0.4 - 0.6 - 0.8 0.3 - 0.5 - 0.7
			Roughing (Low Cutting Force)	Continuous Interruption	PX (Single-sided)	CA515 CA025P	1.2 1.6	150 - 200 - 240 120 - 180 - 220	2.0 - 5.0 - 8.0 2.0 - 5.0 - 8.0	0.4 - 0.6 - 0.8 0.3 - 0.5 - 0.7
	Medium carbon steel Medium carbon alloy	HB ≤ 300	Finishing (Time Oriented)	Continuous Interruption	WF (Wiper)	PV710 CA515	0.8 0.8	200 - 250 - 320 160 - 220 - 280	0.3 - 0.5 - 1.0 0.3 - 0.5 - 1.0	0.2 - 0.3 - 0.4 0.2 - 0.3 - 0.4
			Finishing - Medium (Time Oriented)	Continuous Interruption	WE (Wiper)	PV710 CA025P	0.8 0.8	180 - 220 - 280 130 - 180 - 240	1.0 - 2.0 - 3.0 1.0 - 2.0 - 3.0	0.2 - 0.3 - 0.4 0.2 - 0.3 - 0.4
			Finishing (High Speed Machining)	Continuous	PP	CCX	0.8	200 - 300 - 450	0.2 - 0.5 - 1.5	0.04 - 0.16 - 0.28
			Finishing (Gloss Oriented)	Continuous Interruption	PP	TN610	0.4 0.8	200 - 250 - 320 180 - 230 - 300	0.2 - 0.5 - 1.5 0.2 - 0.5 - 1.5	0.04 - 0.16 - 0.28 0.05 - 0.2 - 0.35
			Finishing (Tool Life Oriented)	Continuous Interruption	PP	PV710 PV720	0.4 0.8	200 - 250 - 320 200 - 240 - 290	0.2 - 0.5 - 1.5 0.2 - 0.5 - 1.5	0.04 - 0.16 - 0.28 0.05 - 0.2 - 0.35
			Finishing - Medium (Gloss Oriented)	Continuous Interruption	PQ	TN610 TN620	0.8 1.2	180 - 230 - 300 160 - 220 - 260	0.5 - 1.5 - 2.5 0.5 - 1.5 - 2.5	0.1 - 0.2 - 0.3 0.1 - 0.17 - 0.25
			Finishing - Medium (Tool Life Oriented)	Continuous Interruption	PQ	PV710 CA025P	0.8 0.8	160 - 210 - 280 140 - 200 - 240	0.5 - 1.5 - 2.5 0.5 - 1.5 - 2.5	0.1 - 0.2 - 0.3 0.1 - 0.17 - 0.25
			Medium - Roughing	Continuous Interruption	PG	CA515 CA025P	0.8 1.2	150 - 200 - 240 120 - 160 - 200	1.0 - 2.5 - 3.5 1.0 - 2.5 - 3.5	0.2 - 0.3 - 0.4 0.2 - 0.3 - 0.4
			Medium - Roughing High Feed Rate	Continuous Interruption	PT	CA515 CA025P	0.8 1.2	120 - 180 - 230 100 - 150 - 200	1.5 - 3.0 - 4.5 1.5 - 3.0 - 4.5	0.25 - 0.35 - 0.45 0.25 - 0.35 - 0.45
			Roughing High Feed Rate	Continuous Interruption	PH	CA515 CA025P	1.2 1.6	120 - 180 - 230 100 - 150 - 200	2.0 - 5.0 - 8.0 2.0 - 5.0 - 8.0	0.4 - 0.6 - 0.8 0.3 - 0.5 - 0.7
			Roughing (Low Cutting Force)	Continuous Interruption	PX (Single-sided)	CA515 CA025P	1.2 1.6	120 - 180 - 230 100 - 150 - 200	2.0 - 5.0 - 8.0 2.0 - 5.0 - 8.0	0.4 - 0.6 - 0.8 0.3 - 0.5 - 0.7
	High carbon alloy	HB ≤ 280	Finishing (High Speed Machining)	Continuous	PP	CCX	0.8	200 - 300 - 400	0.2 - 0.5 - 1.5	0.04 - 0.16 - 0.28
			Finishing (Gloss Oriented)	Continuous Interruption	PP	TN610 TN620	0.4 0.8	150 - 200 - 280 140 - 180 - 240	0.2 - 0.5 - 1.5 0.2 - 0.5 - 1.5	0.04 - 0.16 - 0.28 0.05 - 0.2 - 0.35
			Finishing (Tool Life Oriented)	Continuous Interruption	PP	PV710 CA515	0.4 0.8	120 - 180 - 260 100 - 150 - 200	0.2 - 0.5 - 1.5 0.2 - 0.5 - 1.5	0.04 - 0.16 - 0.28 0.05 - 0.2 - 0.35
			Finishing - Medium	Continuous Interruption	PQ	CA515 CA025P	0.8 0.8	120 - 160 - 220 100 - 140 - 180	0.5 - 1.5 - 2.5 0.5 - 1.5 - 2.5	0.15 - 0.25 - 0.3 0.15 - 0.2 - 0.25
			Medium - Roughing	Continuous Interruption	PG	CA515 CA025P	0.8 0.8	120 - 150 - 200 100 - 130 - 180	1.0 - 2.0 - 3.0 1.0 - 2.0 - 3.0	0.2 - 0.3 - 0.5 0.15 - 0.2 - 0.3
			Medium - Roughing High Feed Rate	Continuous Interruption	PT	CA515 CA025P	0.8 1.2	100 - 140 - 180 80 - 120 - 160	1.5 - 3.0 - 4.5 1.5 - 3.0 - 4.5	0.25 - 0.35 - 0.45 0.25 - 0.35 - 0.45
			Roughing High Feed Rate	Continuous Interruption	PH	CA515 CA025P	1.2 1.6	100 - 140 - 180 80 - 120 - 160	2.0 - 5.0 - 8.0 2.0 - 5.0 - 8.0	0.4 - 0.6 - 0.8 0.3 - 0.5 - 0.7
			Roughing (Low Cutting Force)	Continuous Interruption	PX (Single-sided)	CA515 CA025P	1.2 1.6	100 - 140 - 180 80 - 120 - 160	2.0 - 5.0 - 8.0 2.0 - 5.0 - 8.0	0.4 - 0.6 - 0.8 0.3 - 0.5 - 0.7



External turning

External turning - Negative insert

ap indicates radius

ISO Classification	Workpiece material	Hardness	Cutting range	Applications	Recommended chipbreaker	Recommended insert grade	Corner-R(RE)	Lower limit - Recommendation - Upper limit		
								Vc (m/min)	ap (mm)	f (mm/rev)
M	Stainless steel (Austenitic related)	HB ≤ 220	Finishing (Gloss Oriented)	Continuous	PQ	TN620	0.8	120 - 160 - 200	0.5 - 1.0 - 1.5	0.08 - 0.15 - 0.2
				Interruption			0.8	100 - 120 - 150	0.5 - 1.0 - 1.5	0.05 - 0.1 - 0.15
			Finishing	Continuous	MQ	CA6515	0.4	120 - 180 - 240	0.5 - 1.0 - 1.5	0.08 - 0.15 - 0.2
				Interruption		CA6525	0.8	100 - 160 - 220	0.5 - 1.0 - 1.5	0.05 - 0.1 - 0.15
			Medium - Roughing (Chip Control Oriented)	Continuous	MS	CA6515	0.4	120 - 160 - 200	1.0 - 2.0 - 3.0	0.1 - 0.2 - 0.3
				Interruption		CA6525	0.8	80 - 140 - 180	1.0 - 2.0 - 3.0	0.2 - 0.3 - 0.4
			Medium - Roughing (Sharpness Oriented)	Continuous	MU	CA6515	0.4	120 - 160 - 200	1.0 - 2.0 - 3.0	0.15 - 0.25 - 0.35
				Interruption		CA6525	0.8	80 - 140 - 180	1.0 - 2.0 - 3.0	0.15 - 0.25 - 0.3
	Roughing	Continuous	Standard	CA6515	0.8	100 - 140 - 180	1.0 - 2.0 - 4.0	0.2 - 0.3 - 0.4		
		Interruption		CA6525	1.2	80 - 120 - 150	1.0 - 2.0 - 4.0	0.2 - 0.3 - 0.4		
	Stainless steel (Precipitation hardening)	HB ≤ 300	Finishing (Gloss Oriented)	Continuous	PQ	TN620	0.8	100 - 120 - 150	0.5 - 1.0 - 1.5	0.05 - 0.1 - 0.15
				Interruption			0.8	80 - 100 - 120	0.5 - 1.0 - 1.5	0.05 - 0.08 - 0.1
			Finishing	Continuous	MQ	CA6515	0.4	100 - 120 - 150	0.5 - 1.0 - 1.5	0.08 - 0.15 - 0.2
				Interruption		CA6525	0.8	80 - 100 - 120	0.5 - 1.0 - 1.5	0.05 - 0.1 - 0.15
			Medium - Roughing (Chip Control Oriented)	Continuous	MS	CA6515	0.4	100 - 120 - 150	1.0 - 1.5 - 2.0	0.1 - 0.15 - 0.25
				Interruption		CA6525	0.8	80 - 100 - 120	1.0 - 2.0 - 3.0	0.1 - 0.15 - 0.2
Medium - Roughing (Sharpness Oriented)			Continuous	MU	CA6515	0.4	100 - 120 - 150	1.0 - 1.5 - 2.0	0.1 - 0.15 - 0.25	
			Interruption		CA6525	0.8	80 - 100 - 120	1.0 - 2.0 - 3.0	0.1 - 0.15 - 0.2	
Roughing	Continuous	Standard	CA6515	0.8	80 - 100 - 120	1.0 - 2.0 - 3.0	0.2 - 0.3 - 0.4			
	Interruption		CA6525	1.2	60 - 80 - 100	1.0 - 2.0 - 4.0	0.2 - 0.3 - 0.4			
K	Gray cast iron	HB ≤ 250	High Speed Machining	Continuous	Without chipbreaker	KBN475	0.8	400 - 800 - 1200	0.05 - 0.2 - 0.5	0.1 - 0.2 - 0.3
				Continuous		KBN900	1.2	500 - 900 - 1200	0.1 - 0.5 - 1.0	0.05 - 0.1 - 0.2
				Interruption		KBN900	1.2	500 - 700 - 900	0.5 - 1.0 - 1.5	0.05 - 0.1 - 0.2
			Finishing (Gloss Oriented)	Continuous	Standard	PV7005	0.8	300 - 350 - 400	0.5 - 1.0 - 1.5	0.1 - 0.2 - 0.3
				Interruption		PV720	0.8	150 - 200 - 300	0.5 - 1.0 - 1.5	0.08 - 0.15 - 0.2
			Finishing (Ceramic)	Continuous	Without chipbreaker	KA30	1.2	300 - 500 - 700	0.3 - 0.5 - 1.0	0.1 - 0.2 - 0.3
				Continuous		PT600M	0.8	300 - 450 - 600	0.3 - 0.5 - 1.0	0.1 - 0.2 - 0.3
			Medium (Ceramic)	Continuous		CS7050	1.2	300 - 450 - 550	1.0 - 2.0 - 3.0	0.15 - 0.25 - 0.35
				Interruption		KS6050	1.2	250 - 400 - 500	1.0 - 2.0 - 3.0	0.15 - 0.2 - 0.3
			Medium	Continuous	KH	CA310	0.8	200 - 250 - 300	0.5 - 2.0 - 2.5	0.1 - 0.2 - 0.3
	Interruption			CA315	1.2	150 - 200 - 250	0.5 - 2.0 - 2.5	0.08 - 0.15 - 0.2		
	Roughing	Continuous	KH	CA310	0.8	200 - 250 - 300	1.0 - 2.0 - 4.0	0.2 - 0.3 - 0.4		
		Interruption		CA315	1.2	150 - 200 - 250	1.0 - 2.0 - 4.0	0.2 - 0.3 - 0.4		
	Nodular cast iron	HB ≤ 270	High Speed Machining	Continuous	Without chipbreaker	KBN60M	0.4	200 - 300 - 400	0.1 - 0.3 - 0.5	0.1 - 0.15 - 0.2
				Continuous		PT600M	0.8	200 - 250 - 350	0.1 - 0.5 - 1.0	0.1 - 0.2 - 0.4
			Finishing (Gloss Oriented)	Continuous	Standard	PV7005	0.8	150 - 250 - 300	0.5 - 1.0 - 1.5	0.1 - 0.2 - 0.3
Interruption					PV720	0.8	120 - 200 - 250	0.5 - 1.0 - 1.5	0.08 - 0.15 - 0.2	
Medium			Continuous	KG	CA310	0.8	150 - 200 - 250	0.5 - 2.0 - 2.5	0.1 - 0.2 - 0.3	
			Interruption		CA315	1.2	120 - 180 - 220	0.5 - 2.0 - 2.5	0.08 - 0.15 - 0.2	
Roughing	Continuous	KG	CA315	0.8	150 - 200 - 250	1.0 - 2.0 - 4.0	0.2 - 0.3 - 0.4			
	Interruption	KH	CA320	1.2	120 - 180 - 220	1.0 - 2.0 - 4.0	0.2 - 0.3 - 0.4			
N	Non-ferrous metals Copper alloy Aluminum Aluminum alloys	HB ≤ 100	High Speed Machining (Rainbow Surface Gross)	Continuous	Without chipbreaker	KPD001	0.4	300 - 800 - 2000	0.05 - 0.5 - 1.0	0.05 - 0.1 - 0.15
				Continuous						
			Finishing (Long Tool Life)	Continuous	A3	PDL025	0.4	400 - 500 - 700	0.5 - 1.0 - 2.0	0.1 - 0.2 - 0.25
				Interruption			0.8	400 - 500 - 700	0.5 - 1.0 - 2.0	0.1 - 0.2 - 0.25
			Finishing	Continuous	A3	KW10	0.8	400 - 500 - 700	0.5 - 1.0 - 2.0	0.1 - 0.2 - 0.25
				Interruption			0.8	400 - 500 - 700	0.5 - 1.0 - 2.0	0.1 - 0.2 - 0.25
Medium	Continuous	AH	KW10	0.8	200 - 300 - 500	1.0 - 2.0 - 3.5	0.1 - 0.3 - 0.4			
	Interruption			0.8	200 - 300 - 500	1.0 - 2.0 - 3.5	0.1 - 0.3 - 0.4			
S	Titanium alloys	HB ≤ 400	Precision Finishing (Rainbow Surface Gross)	Continuous	Without chipbreaker	KPD001	0.4	100 - 150 - 180	0.05 - 0.3 - 0.5	0.03 - 0.1 - 0.15
				Interruption			0.4	70 - 120 - 150	0.05 - 0.3 - 0.5	0.03 - 0.07 - 0.1
			Finishing	Continuous	MQ	SW05	0.4	40 - 70 - 100	0.2 - 0.5 - 1.0	0.05 - 0.2 - 0.3
				Interruption			0.4	40 - 70 - 100	0.2 - 0.5 - 1.0	0.05 - 0.15 - 0.2
			Medium	Continuous	MU	SW05	0.8	40 - 60 - 80	0.5 - 1.0 - 3.0	0.1 - 0.25 - 0.35
	Interruption				0.8	40 - 60 - 80	0.5 - 1.0 - 3.0	0.1 - 0.2 - 0.3		
	Heat-resistant alloys	HB ≤ 350	Finishing	Continuous	MQ	PR005S	0.4	30 - 55 - 90	0.2 - 0.3 - 1.0	0.05 - 0.08 - 0.15
				Interruption		PR015S	0.8	25 - 45 - 70	0.2 - 0.5 - 1.0	0.05 - 0.1 - 0.2
			Medium	Continuous	SQ	PR005S	0.8	30 - 55 - 90	0.3 - 0.5 - 1.5	0.1 - 0.17 - 0.35
				Interruption		PR015S	0.8	25 - 45 - 70	0.3 - 0.5 - 1.5	0.1 - 0.17 - 0.35
Roughing			Continuous	SX	PR005S	-	30 - 55 - 90	0.5 - 2.0 - 4.0	0.15 - 0.3 - 0.45	
	Interruption		PR015S	-	25 - 45 - 70	0.5 - 2.0 - 4.0	0.15 - 0.3 - 0.45			
H	Hardened steel Hard materials	40-50 HRC	Finishing	Continuous	PQ	CA515	0.8	60 - 100 - 120	0.1 - 0.3 - 0.5	0.05 - 0.08 - 0.1
				Interruption	Standard		0.8	30 - 50 - 70	0.1 - 0.3 - 0.5	0.05 - 0.08 - 0.1
		40-50 HRC	Finishing	Continuous	Without chipbreaker	PT600M	0.8	60 - 80 - 100	0.2 - 0.5 - 0.7	0.05 - 0.1 - 0.15
				Interruption			1.2	30 - 40 - 60	0.2 - 0.5 - 0.7	0.05 - 0.1 - 0.15
		50-65 HRC	Finishing	Continuous	ME	KBN05M	0.8	100 - 150 - 200	0.05 - 0.3 - 0.5	0.05 - 0.08 - 0.1
				Interruption	MET		1.2	90 - 140 - 180	0.05 - 0.3 - 0.5	0.05 - 0.08 - 0.1
		50-68 HRC	Medium	Continuous	Without chipbreaker	KBN900	1.2	80 - 100 - 120	0.5 - 1.0 - 2.0	0.05 - 0.1 - 0.2
				Interruption			Radius	70 - 90 - 110	0.3 - 0.7 - 1.0	0.05 - 0.1 - 0.15



External turning



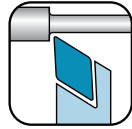



E



Introduction		E2
Toolholders for back turning		E12
TKFB insert	TKF	E14
	KTKF / KTKF Goose-neck holder	E15
ABS15 insert	AABS-40F/SABS-40F	E20
ABW15 insert	AABW-40F/SABW-40F	E21
ABW23 insert	AABW-50F/SABW-50F	E22
Goose-neck toolholders		E23
DC insert	SDJC	E23
VP insert	SVLP	E24
External toolholders		E26
CC insert	ACLC-FF	E26
	SCLC-FF/SCLC-FFJCTM	E27
	SCLC	E28
DC insert	ADJC-FF	E29
	SDJC-FFJCTM	E30
	SDJC	E31
	SDJC-FF-Y	E32
	SDJC-FF	E33
	SDNC-F	E35
	SDNC	E36
DP insert	SDLP-FF	E37
TC/TP insert	STGC	E38
	STGP	E39
VB/VC insert	AVJB-FF/SVJB-FF/SVJB-FFJCTM/SVJB/SVPB/SVVB	E40
	SVJC-FF/SVLC-FF	E44
	SVPC-FF/SVVC	E45
VP insert	SVJP-FF/SVJP-FFJCTM/SVLP-FF/SVPP-FF	E47
ZB insert	SZLB/SZPB/SZVBN	E52
External sleeve holder		E54
CC insert	S...SCLC	E54
DC insert	S...SDUC/S...SDLC	E55
VB/VC insert	S...SVUB/S...SVUC	E58
Toolholders for small double sided tooling		E60
CN insert	SCLN-FF (without offset)	E60
DN insert	SDLN-FF (without offset)	E61
TN insert	STLN-FF (without offset)	E62
Toolholders for double sided tooling for automatic lathes		E63
CN insert	PCLN-FF (without offset)	E63
TN insert	PTLN-FF (without offset)	E64
Recommended cutting conditions		E65

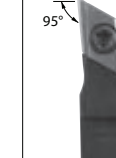

Summary of External Turning

External / Copying

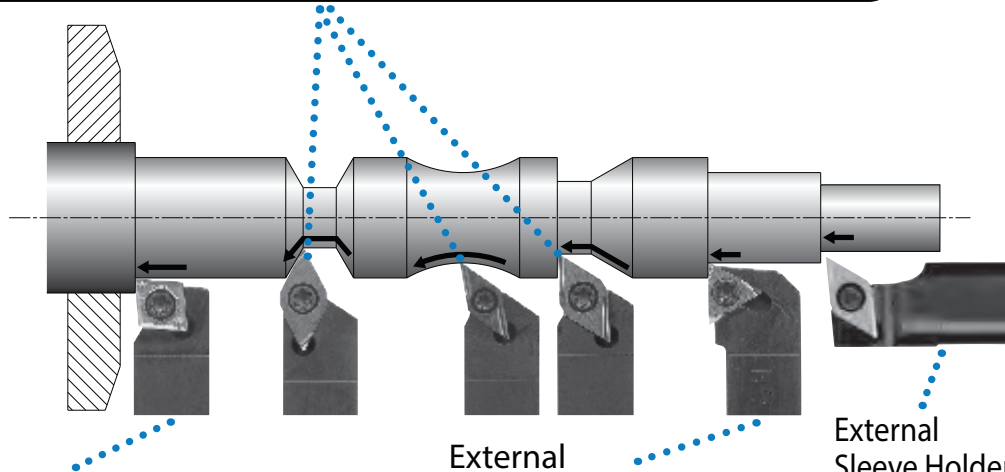

						
ADJC-FF	SDJC-FF(JCTM) SDJC-FF-Y	SDJC	SDLC-FF SDLP-FF	SDLN-FF	SDNC-F	SDNC
Back Clamp Without Offset	Screw Clamp Without Offset	Screw Clamp	Screw Clamp Without Offset	Screw Clamp Without Offset	Screw Clamp	Screw Clamp
➔ E29	➔ E29, E30, E32	➔ E31	➔ E34, E37	➔ E61	➔ E35	➔ E35

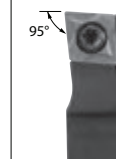

External / Facing

			
ACLCL-FF	SCLC-FF(JCTM)	SCLC	SCLN-FF
Back Clamp Without Offset	Screw Clamp Without Offset	Screw Clamp	Screw Clamp Without Offset
➔ E26	➔ E26, E27	➔ E28	➔ E60

External

	
STGC(P)	STLN-FF
Screw Clamp	Screw Clamp Without Offset
➔ E38, E39	➔ E62

External Sleeve Holder

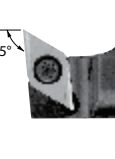

S-SDLC
Screw Clamp Shank Dia. ø12~ø25.4
➔ E56

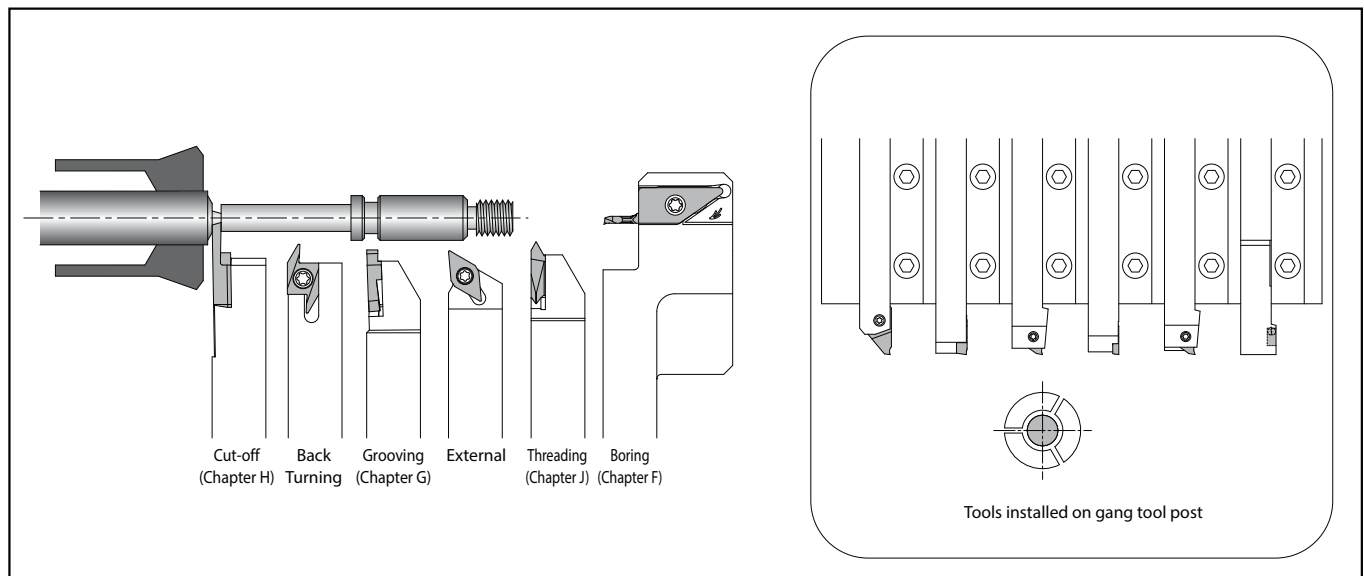
Tooling example (1) CNC Automatic lathe (Gang Type)

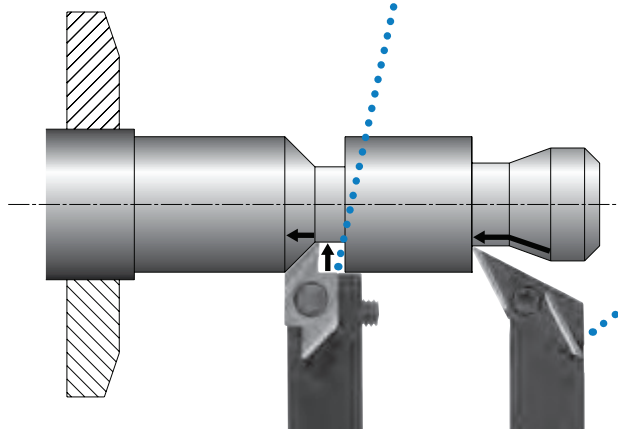

Back Turning

AABS-40F	SABS-40F	AABW-40F	SABW-40F	AABW-50F	SABW-50F	KTKF
Back Clamp Edge Width : 2.8 ap : ~4.0	Screw Clamp Edge Width : 2.8 ap : ~4.0	Back Clamp Edge Width : 4.7 ap : ~4.0	Screw Clamp Edge Width : 4.7 ap : ~4.0	Back Clamp Edge Width : 4.7 ap : ~5.0	Screw Clamp Edge Width : 4.7 ap : ~5.0	Screw Clamp Edge Width : 1.5~3.8 Max. ap : 1.8~5.5



External / Facing / Copying / Undercutting

SVPB	SVPP-FF
Screw Clamp	Screw Clamp Without Offset

Tooling example (2) CNC Automatic lathe (Gang Type)

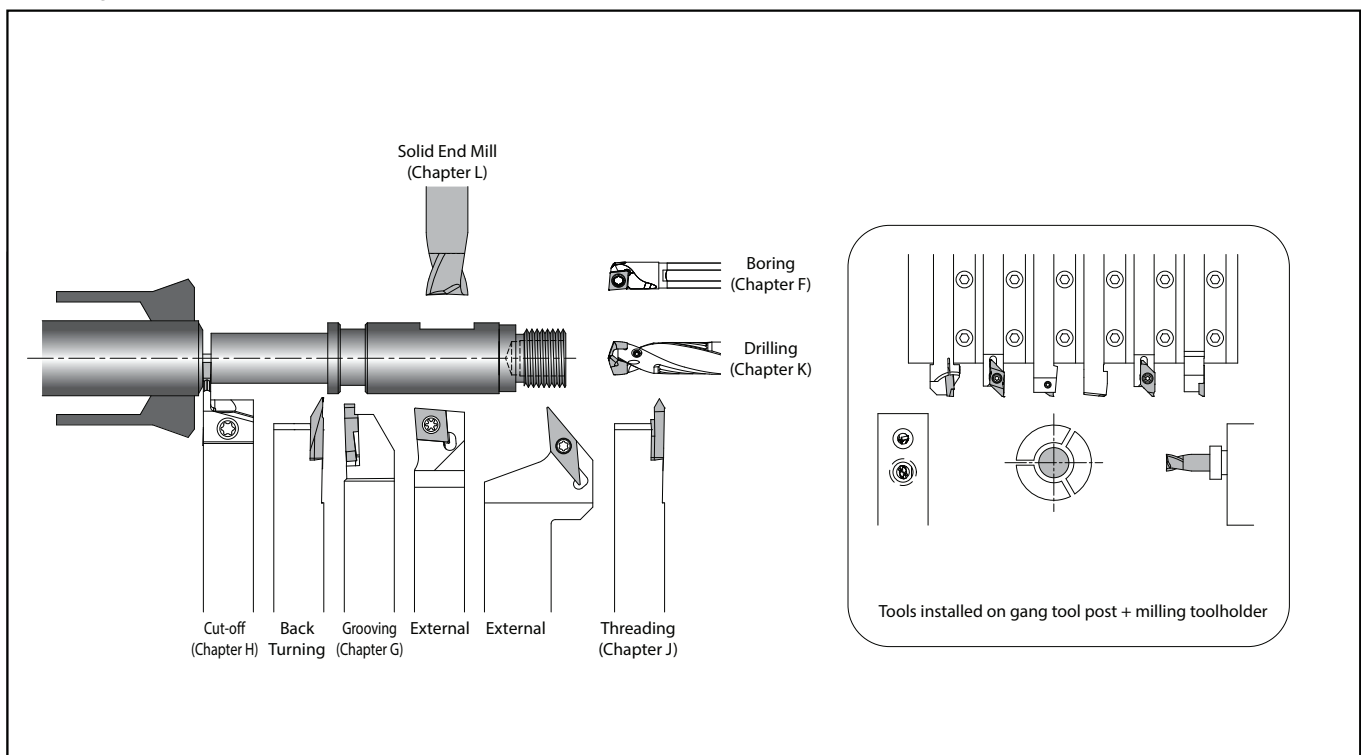

How to use goose-neck holder for swiss tool automatic lathe (Gang type tool post)



Goose-neck holder is applicable to automatic lathes whose toolholder does not move to longitudinal direction (Z-axis direction).

E

Swiss tool automatic lathe (Guide bush system)

In case of machining with the conventional toolholder

Goose-neck Holder is applicable to automatic lathe that toolholder does not move to longitudinal direction (Z-axis direction)

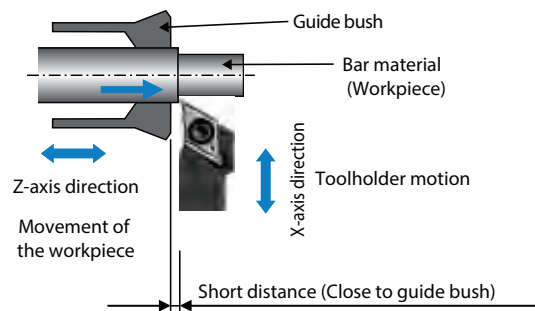

Problems of machining with the conventional toolholder

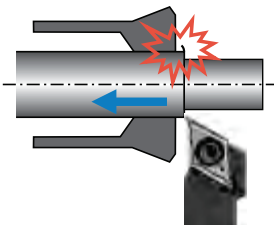

Case 1
During multiple passes, when bar material returns into guide bush, the burr contacts and breaks guide bush.

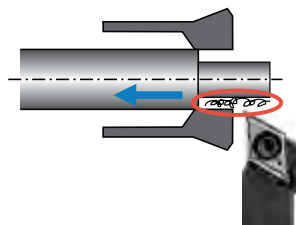

Case 2
The workpiece burr contacts the guide bush and causes dimensional variation.

Case 3
During multiple passes, when bar material returns into guide bush, the chips contacts and breaks guide bush.

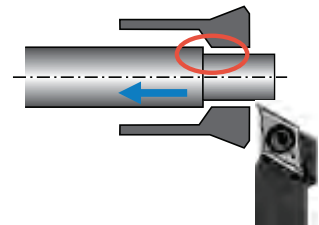

Case 4
Bar material deviation from the guide bush disables machining.

Problems of toolholder Installation

When using a conventional toolholder

1. Additional space is required for an adapter.
2. Toolholder's handling is difficult due to limited space.
3. Necessary to buy an adapter.
4. An adapter may interfere with the next tool post.

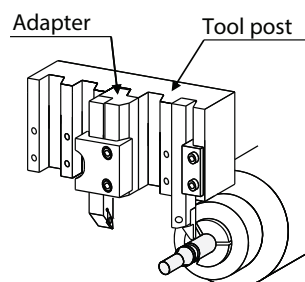

Advantages of goose-neck holder

When using goose-neck holder

1. Machining precision improves by additional finishing process.
2. Chips do not come into the guide bush.
3. Better chip control due to large chip evacuation space.

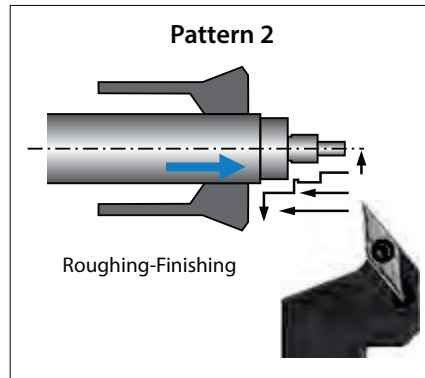
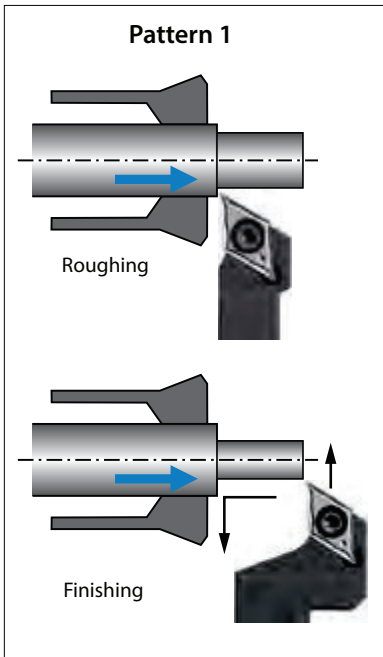

Available for roughing and finishing with one Goose-neck holder.

Available for machining after roughing without returning bar material into guide bush, preventing damages and improving precision.

For better chip control

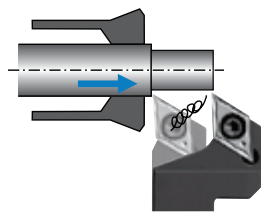

Optimum cutting edge position and large space for efficient chip evacuation.

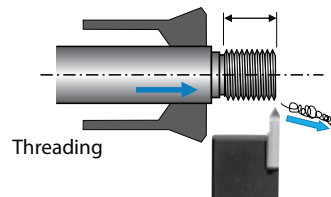

With conventional threading toolholders, chip biting into guide bush can cause damages on threads.

Advantages of Toolholder installation - When using a goose-neck holder

1. Maximum number of toolholders can be attached.
2. No interference with next tool post.

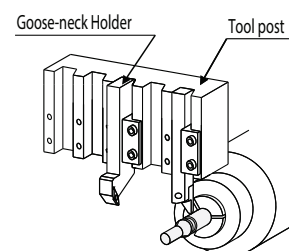

Summary of External Turning

External Sleeve Holder

S-SCLC	S-SDUC	S-SDLC	S-SVUB(C)
Screw Clamp Shank Dia. $\phi 12 \sim \phi 25.4$	Screw Clamp Shank Dia. $\phi 14 \sim \phi 25.4$	Screw Clamp Shank Dia. $\phi 12 \sim \phi 25.4$	Screw Clamp Shank Dia. $\phi 12 \sim \phi 25.4$

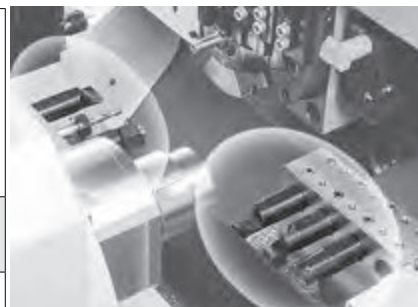

For Tooling Layout and Automatic Lathe List by Manufacturer, See Page

● Finishing by Sleeve Holder

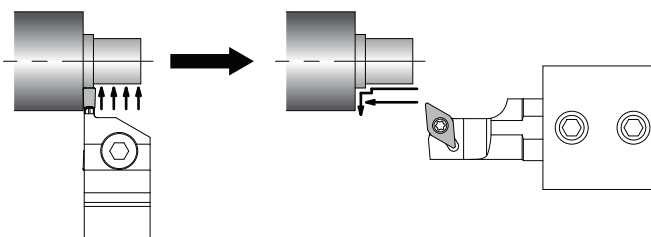

- 1) Roughing by grooving toolholder
- 2) Finishing by Sleeve Holder improves chip control and reduces cutting time

Small tools

Tooling Example (3) CNC Automatic lathe (Opposed Gang Type)

- External / Facing
- External / Copying
- Grooving
- Threading
- Boring

(Chapter G) (Chapter J) (Chapter F)

For Tooling Layout and Automatic Lathe List by Manufacturer, See Page

Toolholders for Small Double Sided Tooling (Screw Clamp)

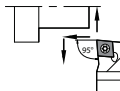
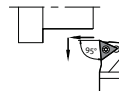
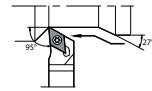

Applications	External / Facing	External / Up Facing	External / Copying
Cutting Edge Angle	95°	95°	95°
Screw Clamp (Without Offset)	 SCLN	 STLN	 SDLN
See Page	E60	E62	E61

Newly designed negative inserts (double-sided) enable high productivity and stability by economical doubled insert edge numbers
Sharp cutting equivalent to positive inserts (single-sided)

Toolholder for Double Sided Tooling for Automatic Lathe (Lever Lock, Without Offset)

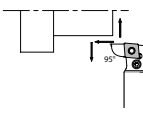
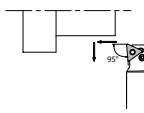

Applications	External / Facing	External / Up Facing
Cutting Edge Angle	95°	95°
Lever Lock (Without Offset)	 PCLN-FF	 PTLN-FF
See Page	E63	E64

The lever lock type is available for small parts machining for external machining

Tooling Example (4)

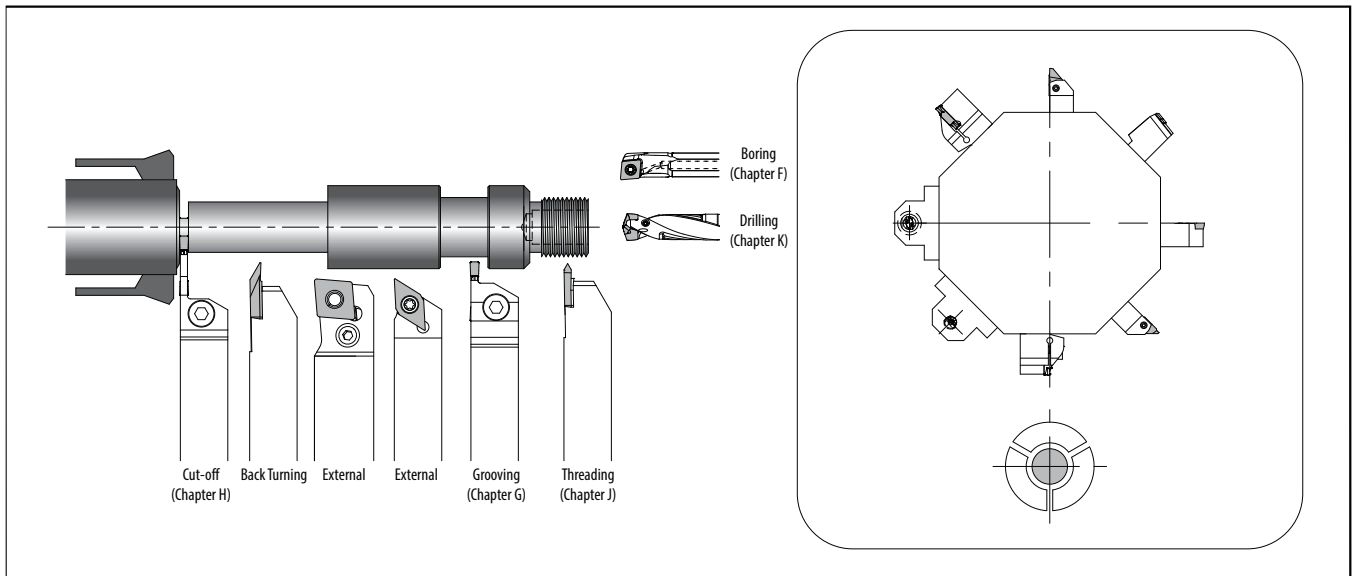

For Tooling Layout and Automatic Lathe List by Manufacturer, See Page [R46~R54](#)



JCTM Series direct coolant holder for small parts machining

JCTM Series

Applicable to different supply styles.

Supports internal coolant with/without piping system.

Lineup of turning, grooving (KGBF), and cut-off (KGD/KTKF) holders

E



Small tools

1 Using internal coolant to enhance tool performance



CG Image

Challenges

- Difficulty in automatic operation due to sudden chip entanglement
- Insert change is not enough to extend tool life

Solution

- The JCTM series is compatible with internal coolant supply system in a wide range of machines and also works under normal pressure
- Reduces down time by improving chip control and reduces cost by extending tool life

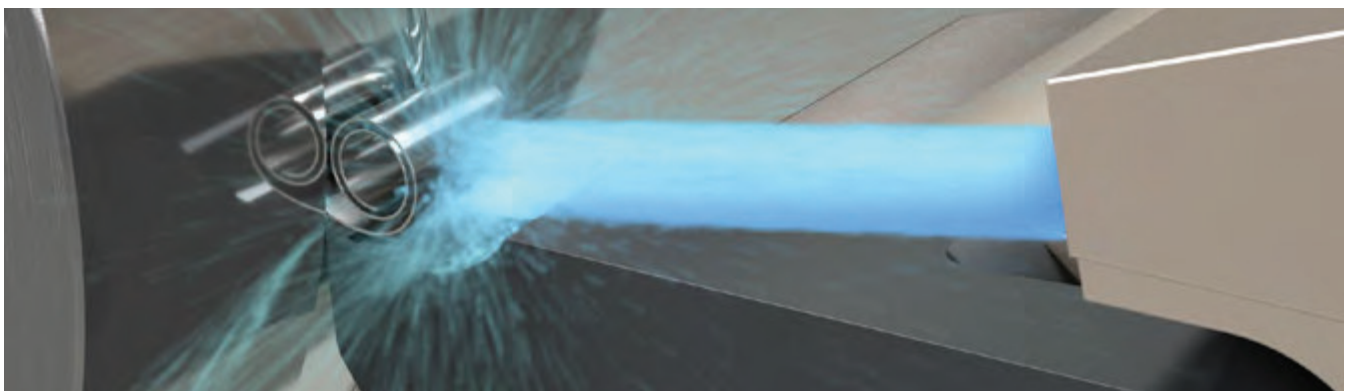

CG Image

Switching to internal coolant toolholder reduces chip entanglement

Internal coolant (2.5 MPa)

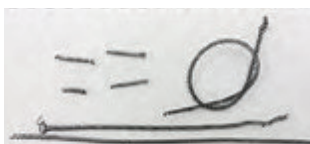

External coolant



Pin Alloy tool steel (SKS 93, JIS)

$V_c = 180 \text{ m/min}$, $a_p = 1.4 \text{ mm}$

$f = 0.13 \text{ mm/rev}$, wet

SDJC / DCMT11T304 type (User evaluation)

2 Applicable to different supply styles. Supports internal coolant with/without piping system

Internal coolant without piping

*When the tool turret supports direct coolant



Coolant is supplied directly from tool turret into the holder. No need for piping just by installing tools

Applicable to wide range of machines

The tool turret is optional. Please contact our company sales representative for details.

- CITIZEN MACHINERY CO., LTD. (L20, D25, M32)
- STAR MICRONICS CO., LTD. (SB-R series, SR series, SV series)
- TSUGAMI CORPORATION (S205/206-II □16 type, S205A/206A-II □16 type)

Compatible with various machine including the above. Toolholders can be customized as well.

(Random order)
Based on Kyocera survey in January 2021

E
Small tools

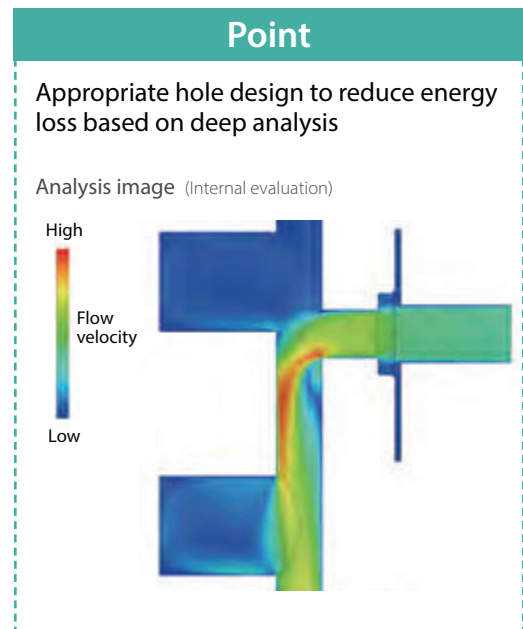
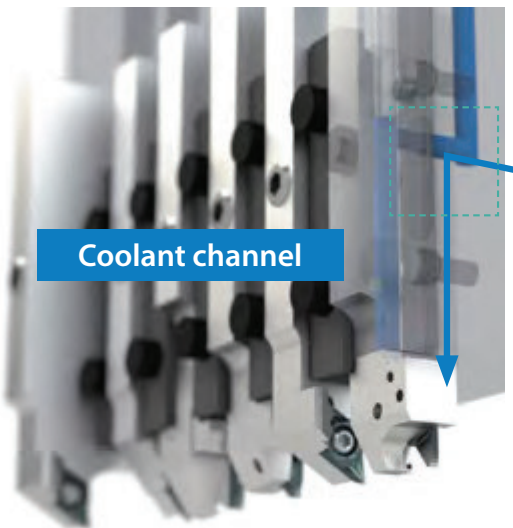

Internal coolant with piping

Compatible with internal coolant on any machine with standard piping parts

Commercial piping parts are available when using at normal pressure

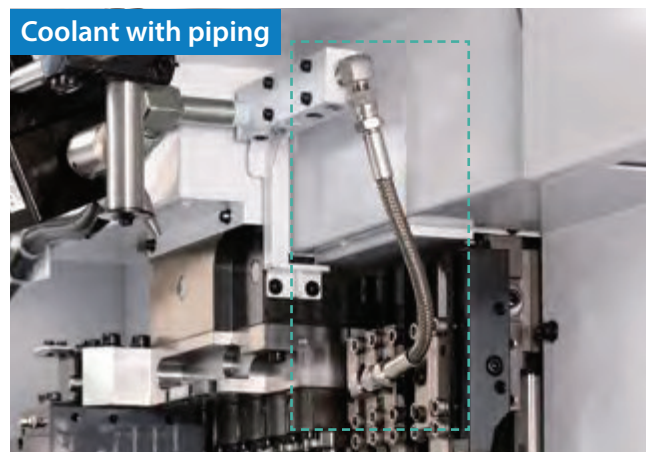

3 Large lineup for various tooling operations

Turning Screw clamp - JCTM

➔ P5

E
Small tools



- **Double coolant holes**
Provide coolant toward the rake face of the insert
(V Type □12: Single hole)
- **Lineup**
SCLC-JCTM / SDJC-JCTM
SVJB-JCTM / SVJP-JCTM

Coolant supply structure comparison (Internal evaluation) (Image)

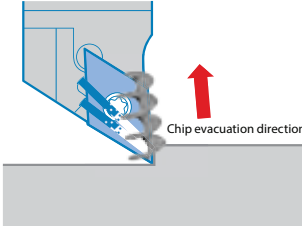
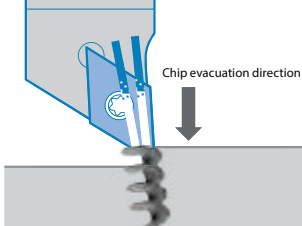
Screw clamp- JCTM	Competitor A
Discharges coolant toward the rake surface of insert	Discharges coolant down onto the chip forcing the chip into the part
	
Chip control performance ✓ Provides stable chip curls	Chip control performance Chip becomes unstable
Cooling effect ✓ The cutting edge stays cool	Cooling effect Chip can prevent coolant supply to edges

External grooving KGBF-JCTM

➔ P7





- **Provides coolant toward the rake surface of insert**
- **Specification**
Edge width: 0.25 -3 mm
Ground chipbreaker/3D GL Chipbreaker
Maximum groove depth: 3 mm

Coolant discharging comparison (Internal evaluation)

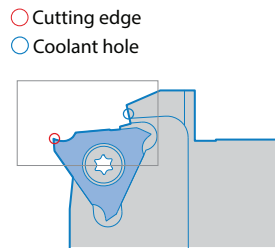
Small chips and better cooling of the insert leads to longer tool life.



KGBF-JCTM	Competitor B
	
Coolant spread: Narrow Coolant density: High (Without insert)	Coolant spread: Wide Coolant density: Low (Without insert)

Square shank identification system (small tools)

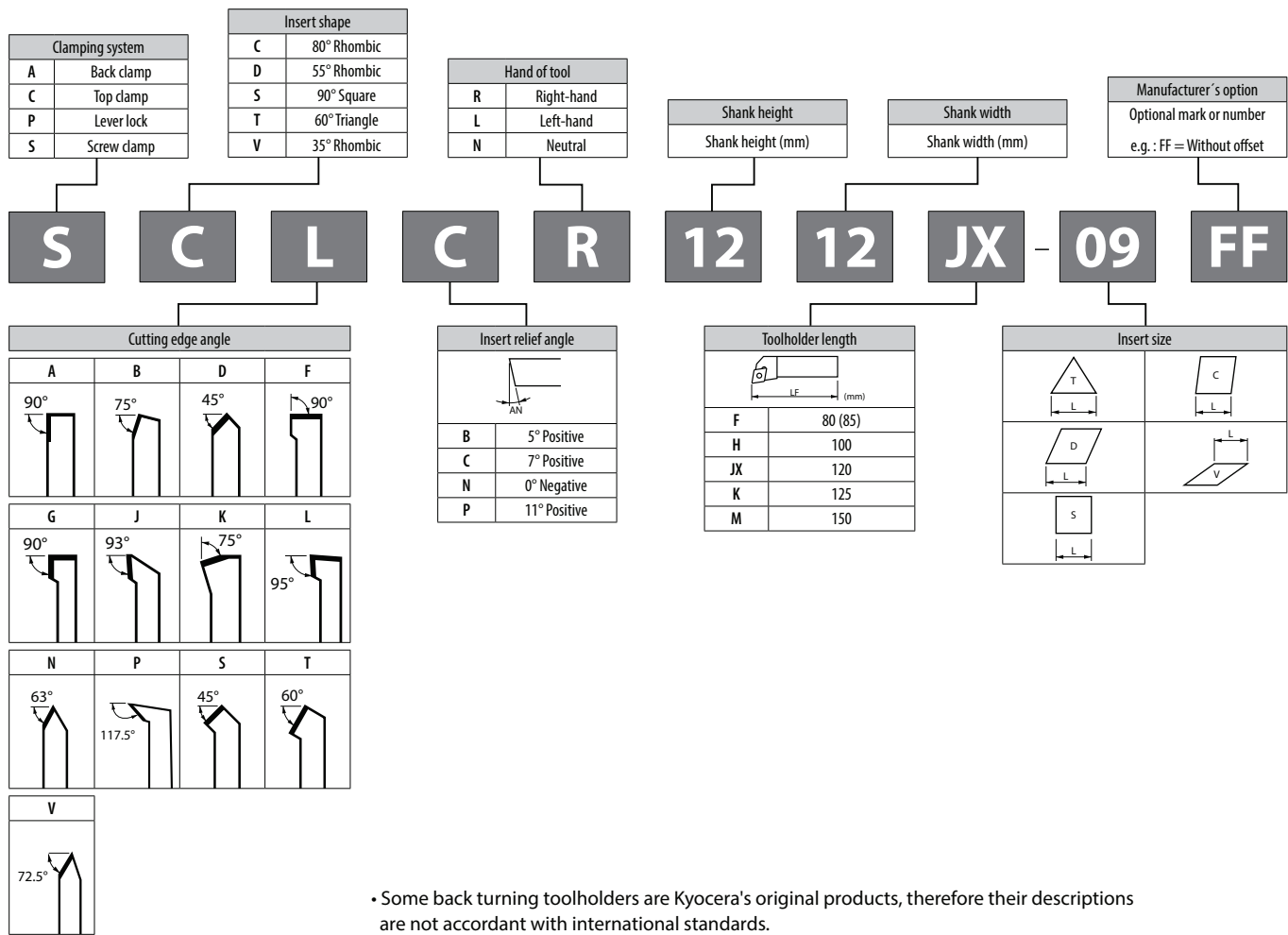

E
Small tools

External sleeve holder identification system

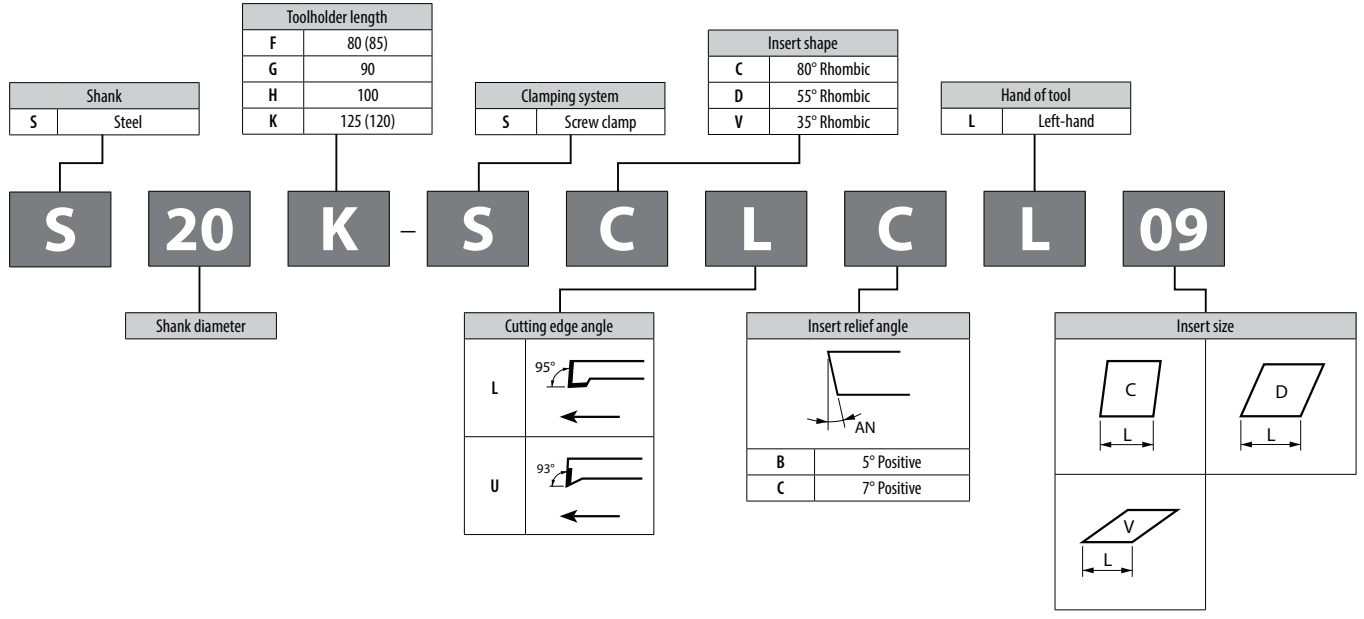

- Specification may change without any prior notice.
- Due to the installation size constraints on the machine, the toolholder length of some products may not match with the symbol.

TKF / TKFB

Insert		Description	No. of edges	Dimension (mm)							Angle (°)		Carbide			Applicable toolholder E15, E16
				CW	CDX	S	D1	RE	W1	a	PSIR%	θ	PVD	-	KV710	
				Carbon steel / Alloy steel							☺ ☹		☹ ☹ ☹			P
				Stainless steel							☺ ☹		☹ ☹ ☹			M
				Gray cast iron							☺ ☹		☹ ☹ ☹			K
				Non-ferrous metals							☺ ☹		☹ ☹ ☹			N
		TKFB 12R15005M	2	1.5	2.6	8.7	5.2	< 0.05	3	0.25	-	-	● ● ● ●	● ● ● ●	KTKFR...-12 KTKFR...-12-Y	
		TKFB 12R28005M	2	2.8	4.6	8.7	5.2	< 0.05	3	0.3	-	-	● ● ● ●	● ● ● ●		
TKFB 12R28010M	2	2.8	4.6	8.7	5.2	< 0.1	3	0.3	-	-	-	● ● ● ●	● ● ● ●			
		TKFB 16R38005M	2	3.8	6.3	9.5	5.2	< 0.05	4	0.3	-	-	● ● ● ●	● ● ● ●	KTKFR...-16	
		TKFB 16R38010M	2	3.8	6.3	9.5	5.2	< 0.1	4	0.3	-	-	● ● ● ●	● ● ● ●		
		TKFB 12L28005MR	2	2.8	4.6	8.7	5.2	< 0.05	3	0.3	-	-	● ● ● ●	● ● ● ●	KTKFL...-12	
		TKFB 12L28010MR	2	2.8	4.6	8.7	5.2	< 0.1	3	0.3	-	-	● ● ● ●	● ● ● ●		
		TKFB 16L38005MR	2	3.8	6.3	9.5	5.2	< 0.05	4	0.3	-	-	● ● ● ●	● ● ● ●	KTKFL...-16	
		TKFB 16L38010MR	2	3.8	6.3	9.5	5.2	< 0.1	4	0.3	-	-	● ● ● ●	● ● ● ●		
		TKFB 12R28005P-GQ	2	2.8	4.6	8.7	5.2	0.05	3	1.5	-	74	● ● ● ●	● ● ● ●	KTKFR...-12 KTKFR...-12-Y	
		TKFB 12R28015P-GQ	2	2.8	4.6	8.7	5.2	0.15	3	1.5	-	74	● ● ● ●	● ● ● ●		
		TKFB 16R38005P-GQ	2	3.8	6.3	9.5	5.2	0.05	4	1.8	-	72	● ● ● ●	● ● ● ●	KTKFR...-16	
		TKFB 16R38015P-GQ	2	3.8	6.3	9.5	5.2	0.15	4	1.8	-	72	● ● ● ●	● ● ● ●		
		TKFB 12R28005-GQ	2	2.8	4.6	8.7	5.2	0.05	3	1.5	-	74	● ● ● ●	● ● ● ●	KTKFR...-12 KTKFR...-12-Y	
		TKFB 12R28015-GQ	2	2.8	4.6	8.7	5.2	0.15	3	1.5	-	74	● ● ● ●	● ● ● ●		
		TKFB 16R38005-GQ	2	3.8	6.3	9.5	5.2	0.05	4	1.8	-	72	● ● ● ●	● ● ● ●	KTKFR...-16	
		TKFB 16R38015-GQ	2	3.8	6.3	9.5	5.2	0.15	4	1.8	-	72	● ● ● ●	● ● ● ●		
		TKF 12R200-GTP	2	2	4.3	8.7	5	0.08	3	-	0	-	● ● ● ●	● ● ● ●	KTKFR...-12 KTKFR...-12-Y	
		TKF 16R300-GTP	2	3	5.8	9.5	5	0.08	4	-	0	-	● ● ● ●	● ● ● ●		

Recommended cutting conditions E67

Small tools

Inserts Identification System (Ref. to Tables 1 and 2)

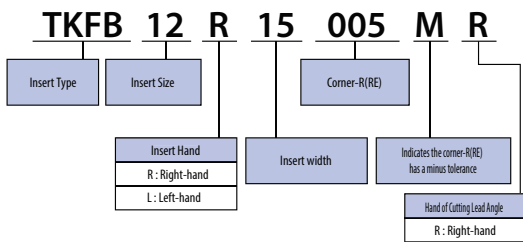

Small machining	General purpose	Large machining
 TKFB12R15.	 TKFB12R28.	 TKFB16R38.

Table 2	
Toolholder	Right-hand / Left-hand
Insert	Right-hand / Left-hand
Lead angle	Right-hand / Left-hand

Applicable Chipbreaker Range

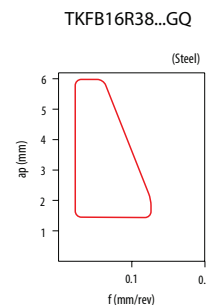
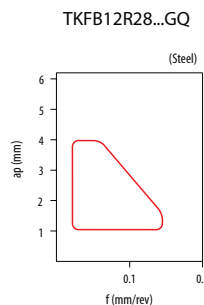
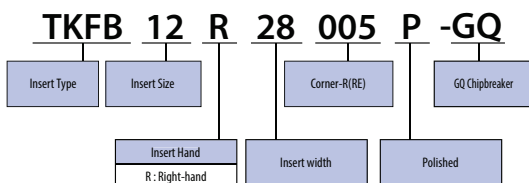

● : Standard item R : Right-hand only L : Left-hand only □ : Check availability

GTP chipbreaker - Grooving and Turning Available

Cutting Time Comparison (Internal evaluation)

Competitor A
Multiple Grooves and a Finishing Pass
Workpiece Material : C45(ø25)

TKF12R200-GTP
Grooving and Turning
Workpiece Material : C45(ø25)

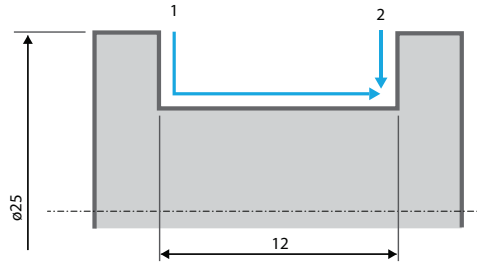
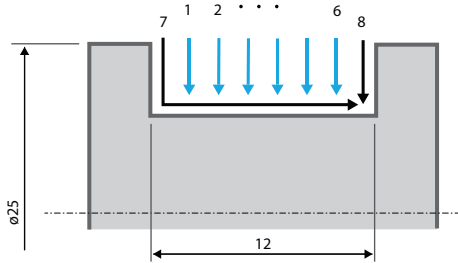

Cutting Conditions: Multiple Grooves
Vc=100m/min
ap=3.5mm, f=0.10mm/rev

Cutting Conditions: Finishing
Vc=100m/min
ap=0.5mm, f=0.05mm/rev

Cutting Conditions: Grooving and Turning
Vc=100m/min
ap=4mm, f=0.05mm/rev

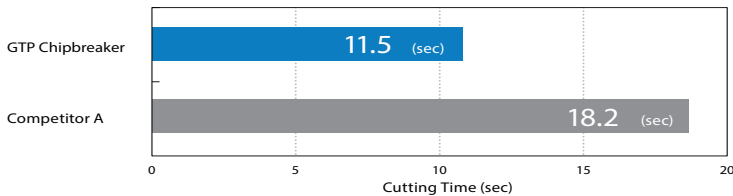

GTP chipbreaker required fewer machining paths than Competitor

Cutting Time Reduction



Chip Control Comparison (Internal evaluation)

Grooving

f (mm/rev)	0.05	0.07	0.10
TKF12R 200-GTP			
Competitor B			

Cutting Conditions: Vc=100m/min, ap=4mm, Wet
Workpiece Material: S45C(ø25)

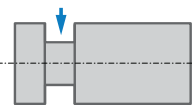

Recommended Chipbreaker Range (Steel)

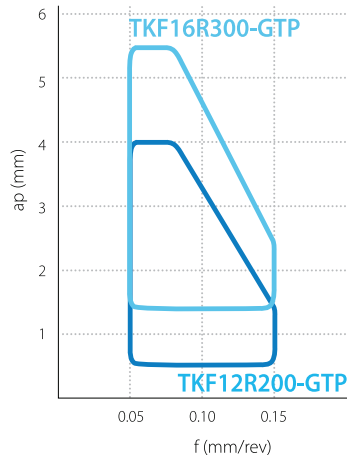

Recommended Chipbreaker Range (SUS)

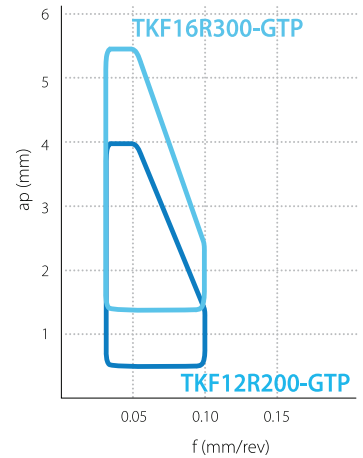

Caution for machining

Ramping

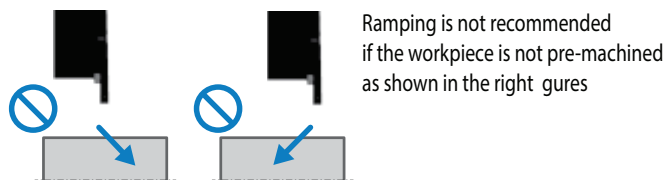

Tips for Ramping

Step grooving is required before ramping. (Refer to the gure below)

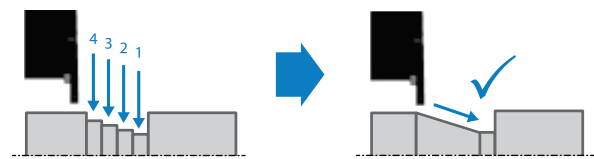

Back Turning

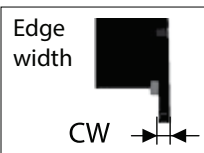
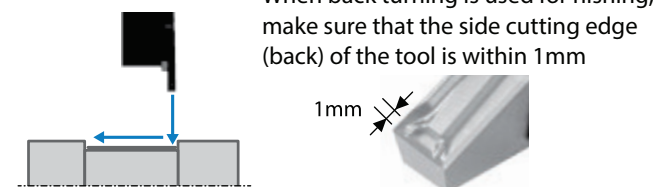

Back turning is not recommended on the tapered surface.



TKF

Insert		Description		Material											Tolerance				PCD	Applicable toolholder E15, E16		
				Carbon steel / Alloy steel											Stainless steel						K	N
				Stainless steel											Gray cast iron							
Non-ferrous metals															P							
				Dimension (mm)												Angle (°)						KPD001
				No. of edges	CW	CDX	S	S1	D1	RE	LE	W1	PSIR ^{90°} /L	CW min.	CW max.	RE (+/-) min.	RE (+/-) max.					
		TKF12R	150-NB	1	1.5	3.5	8.7	8.3	5	0.1	2	3	3	0	-0.03	+0.03	-0.05	0	●	KTKFR...-12 KTKFR...-12-Y		
			200-NB	1	2	4	8.7	8.3	5	0.1	3	3	0	-0.03	+0.03	-0.05	0	●				
			250-NB	1	2.5	4	8.7	8.3	5	0.1	3	3	0	-0.03	+0.03	-0.05	0	●				
		TKF12R	200-AGT	1	2	4.8	8.7	8.3	5	0.1	4.2	3	0	-0.03	+0.03	-0.05	0	●	KTKFR...-12 KTKFR...-12-Y			
			250-AGT	1	2.5	4.8	8.7	8.3	5	0.1	4.2	3	0	-0.03	+0.03	-0.05	0	●				
		TKF12R	200-AS	1	2	5	8.7	7.3	5	0.1	5.3	3	0	-0.03	+0.03	-0.05	0	●	KTKF ^{90°} /L...-12 KTKFR...-12-Y			
			250-AS	1	2.5	5	8.7	7.3	5	0.1	5.3	3	0	-0.03	+0.03	-0.05	0	●				
		TKF12L	200-AS	1	2	5	8.7	7.3	5	0.1	5.3	3	0	-0.03	+0.03	-0.05	0	●				
		TKF16R	250-AS	1	2.5	8	9.5	8	5	0.1	6.3	4	0	-0.03	+0.03	-0.05	0	●				
			TKF16L	250-AS	1	2.5	8	9.5	8	5	0.1	6.3	4	0	-0.03	+0.03	-0.05	0	●	KTKF ^{90°} /L...-16		

Recommended cutting conditions E67

Inserts Identification System

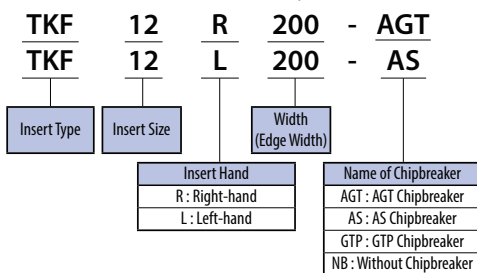

Applicable Range

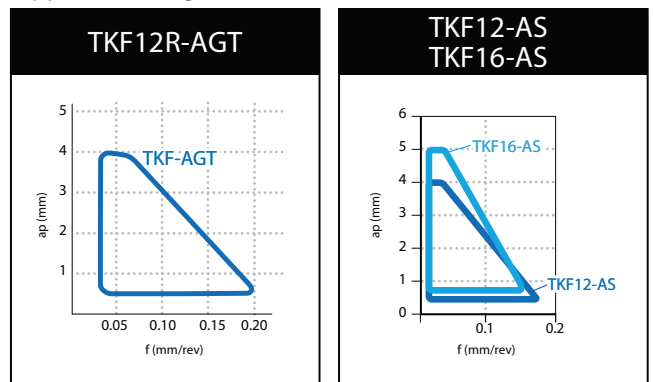

* PCD Inserts for turning and grooving

* Not recommended for cut-off

Note 1) The cutting edge of the TKF-AS / -ASR will be 1 mm lower than the center line when attached to the KTKF toolholder (Ref. to Fig. 2).

Adjust the height by making NC lathe parameter settings or inserting a plate.

2) If the 1 mm adjustment is not possible, use the TKF...-AGT/TKF...-NB. (Ref. to Fig. 3)

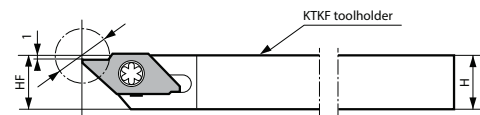

Fig. 2 When a TKF-AS / -ASR insert is attached (The cutting edge is 1mm lower than the center line)

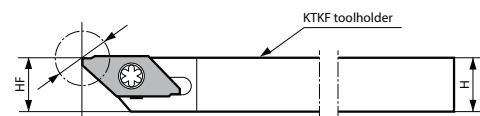
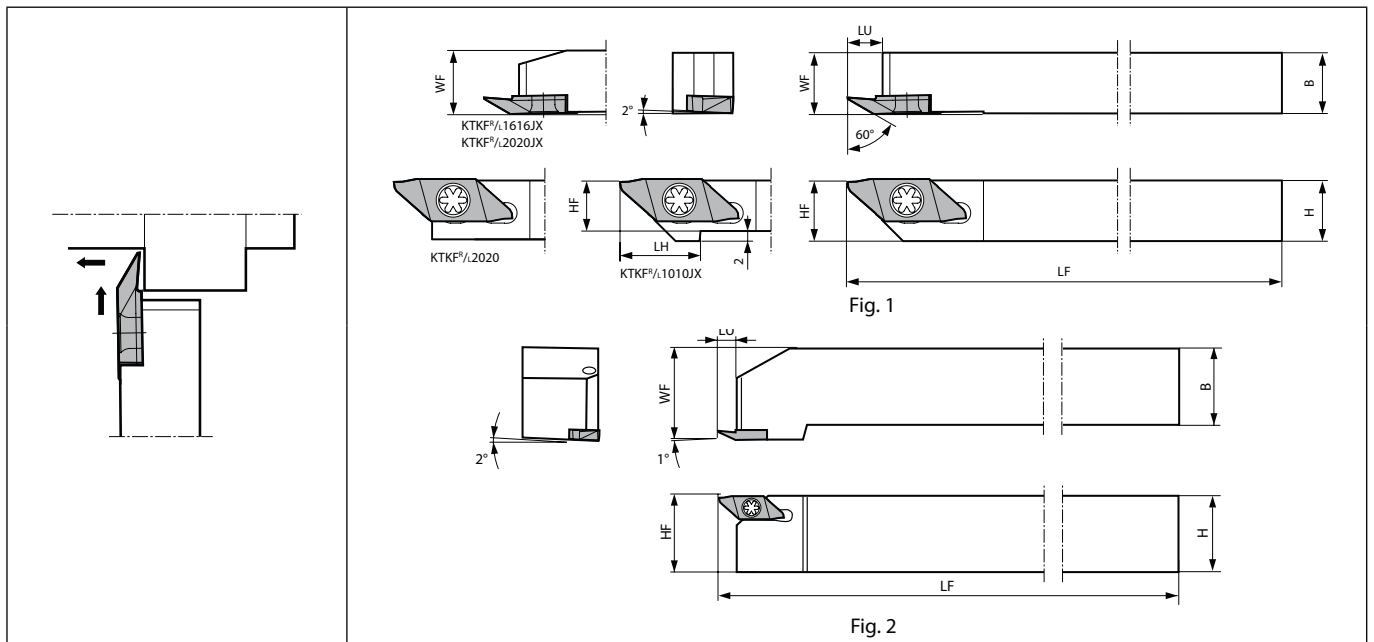

Fig. 3 When a TKF-NB insert is attached

● : Standard item R : Right-hand only L : Left-hand only □ : Check availability

CBN & PCD Inserts are sold in 1 piece boxes

KTKF (Back turning)



Right-hand shown | Right-hand Insert for Right-hand Toolholder, Left-hand Insert for Left-hand Toolholder.

E
Small tools

Toolholder dimensions

Description	Availability		Dimension (mm)								Fig.	Spare parts		Applicable inserts E12, E14
												Screw	Wrench	
	R	L	H	B	LH	HF	LF	LU	WF					
KTKF%/L 1010JX-12 1212F-12 1212JX-12 1616JX-12 2020JX-12 2525M-12	●	●	10	10	15	10	120	10	1	6	SB-4590TRWN	FT-10	TKF12%/... TKFB12%/...	
	●	●	12	12		12	85	12	1					
	●	●	16	16	-	16	120	16	1					
	●	●	20	20		20	120	20	1					
	●	●	25	25		25	150	30	2					
	●	●	20	20		20	120	20	1					
KTKF%/L 1010JX-16 1212F-16 1212JX-16 1616JX-16 2020JX-16 2525M-16	●	●	10	10	20	10	120	10	1	8	SB-4590TRWN	FT-10	TKF16%/... TKFB16%/...	
	●	●	12	12		12	85	12	1					
	●	●	16	16	-	16	120	16	1					
	●	●	20	20		20	120	20	1					
	●	●	25	25		25	150	30	2					
	●	●	20	20		20	120	20	1					

LU shows the distance from the toolholder to the cutting edge.
See Page H15 for internal coolant type (coolant-through holders)

● : Standard item R : Right-hand only L : Left-hand only □ : Check availability

KTKF (Back turning , Goose-neck holder)

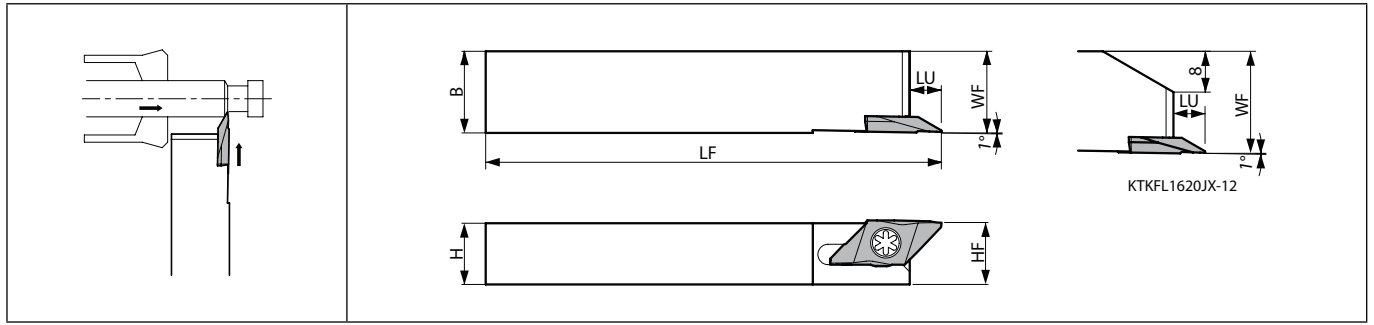

Left-hand shown | Left-hand Insert for Left-hand Toolholder.

E



Small tools

Toolholder dimensions

Description	Availability	Dimension (mm)							Spare parts		Applicable inserts ➔ E12, E14
		L	H	B	HF	LF	LU	WF	Screw	Wrench	
KTKFL 1216JX-12 1620JX-12	●	12	16	12	12	120	6	16	SB-4590TRWN	FT-10	TKF12L... TKFB12L...

LU shows the distance from the toolholder to the cutting edge.

KTKF-Y (Back turning , Y-axis toolholder)

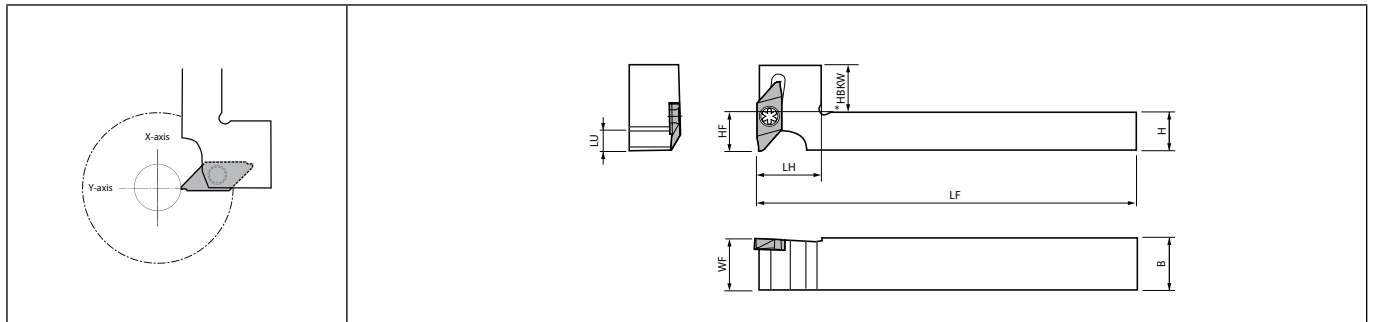

Right-hand shown | Right-hand Insert for Right-hand Toolholder.

Toolholder dimensions

Description	Availability	Dimension (mm)								Spare parts		Applicable inserts ➔ E12, E14
		R	H	B	LH	HF	HBKV	LF	WF	Screw	Wrench	
KTKFR 1216JX-12-Y 1616JX-12-Y	●	12	16	20	12	15	120	16	SB-4590TRWN	FT-10	TKF12R... TKFB12R...	

LU shows the distance from the toolholder to the cutting edge.

● : Standard item R : Right-hand only L : Left-hand only □ : Check availability

Precautions for using Y-axis toolholder

Do not use Y-axis toolholders side by side to prevent interference. (Only two Y-axis holder can be used at the same time)

With interference

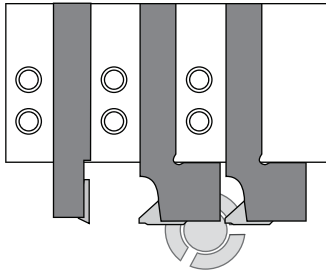

Without interference

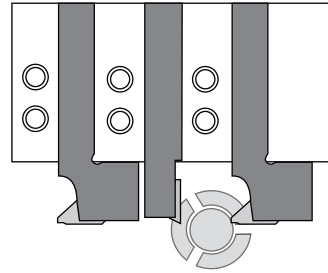

Standard toolholders may be mounted between two Y-axis toolholders

When changing the tool, set the retracted position with reference to the cutting edge of the Y-axis holder. (When exchanging from tool B to D)

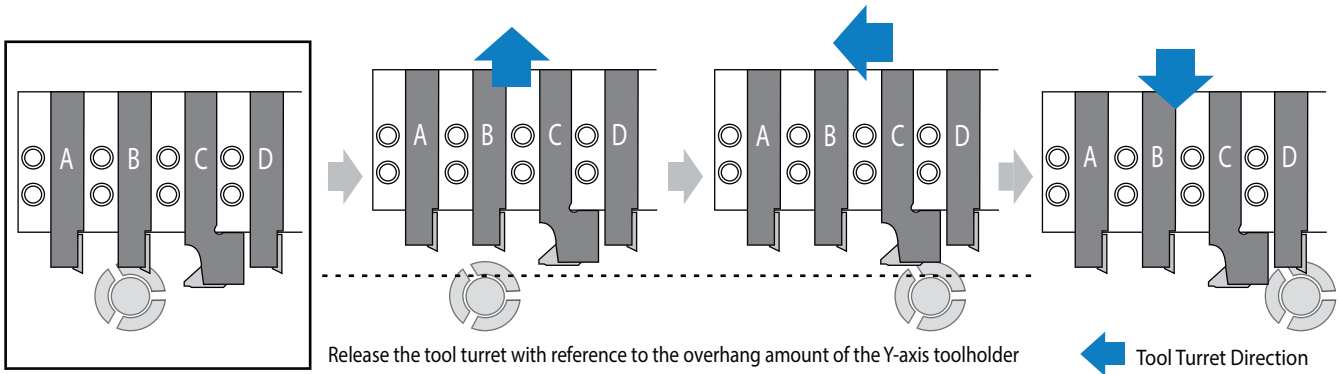

E



Small tools

Note that using other toolholders together will result in different outside diameters

(Unit : mm)

Y-axis Toolholder Overhang	Examples	Overhang amount L			
		Available outside cutting diameter (φ)	20	22	25
20		A	Without Restriction	Without Restriction	Without Restriction
		B	13.0	13.0	13.0
		C	Without Restriction	Without Restriction	Without Restriction
25		A	38.0	58.0	Without Restriction
		B	14.9	13.6	13.0
		C	45.0	60.0	Without Restriction

Toolholders for back turning - TKFB insert

How to select back turning toolholder hand

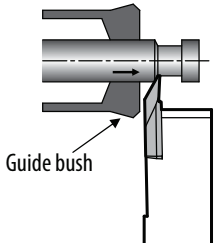
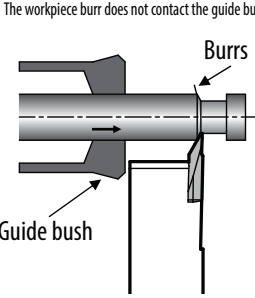
<p>Right-hand</p>	 <p>Guide bush</p>	<ul style="list-style-type: none"> • Machining near the guide bush is possible • Narrow cutting edge width of TKFB12R15005M • Optimum for small parts and high precision machining
<p>Left-hand</p>	<p>The workpiece burr does not contact the guide bush.</p>  <p>Burrs</p> <p>Guide bush</p>	<ul style="list-style-type: none"> • Machining with a distance from guide bush • Good chip control due to large space between the guide bush and the tool. • Excellent chip control in roughing and finishing (plural passes) • Stable accuracy of external diameter dimension: <ul style="list-style-type: none"> • When burrs occur, if a left-hand toolholder is used, it is not necessary to return workpiece into guide bush in finishing. • Also, left-hand toolholders prevent guide bush wear caused by chip biting.

E

Small tools

Workpiece movement and tool hand selection - in roughing and finishing

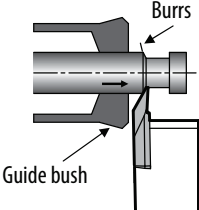
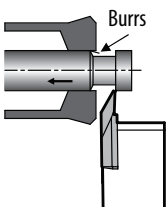
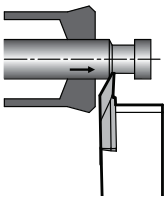
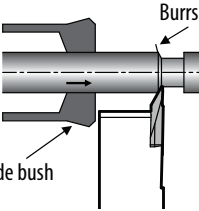
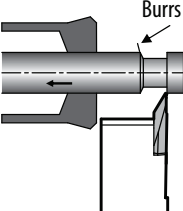
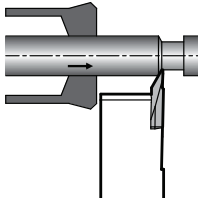
	Roughing	Workpiece position after roughing	Finishing
<p>Right-hand</p>	 <p>Burrs</p> <p>Guide bush</p>	 <p>Burrs</p>	
<p>Left-hand</p>	 <p>Burrs</p> <p>Guide bush</p>	 <p>Burrs</p>	

* Good dimension accuracy: If a left-hand toolholder is used, burrs on workpiece generated in roughing do not damage the guide bush in finishing.

Chip control improvement in back turning

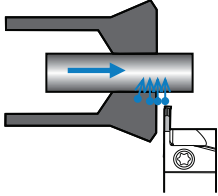
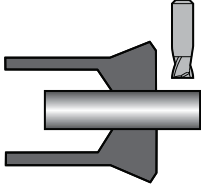
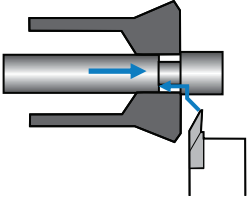
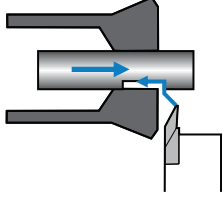
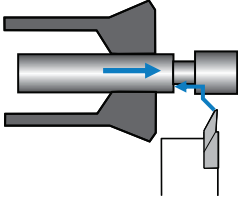
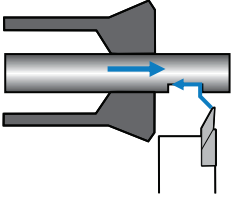
	Chip control improvement by tool pass changes - 1	Chip control improvement by tool pass changes - 2
Roughing	<p>Roughing with grooving tools</p> <p>1. GMM2420-020MW (Grooving)</p> 	<p>Pre-Stage machining is processed with solid end mill</p> <p>1. Solid end mill</p> 
Finishing (Countermeasures 1) Use right-hand toolholder	<p>When using TKFB12R28010M (for back turning / right hand)</p>  <p><u>Advantages:</u></p> <ul style="list-style-type: none"> • Good surface roughness <p><u>Disadvantages:</u></p> <ul style="list-style-type: none"> • If a machining pass is long, the guide bush can not support the workpiece. 	<p>When using TKFB12R28010M (for back turning / right hand)</p>  <p><u>Advantages:</u></p> <ol style="list-style-type: none"> 1. Minimal deflection in long machining passes 2. Chips are broken into small pieces, though the workpiece material is sticky <p><u>Disadvantages:</u></p> <ul style="list-style-type: none"> • The pre-stage machining may cause fractures, because of interrupted machining
Finishing (Countermeasures 2) Use left-hand toolholder	<p>When using TKFB12L28010M (for back turning / left hand)</p>  <p><u>Advantages:</u></p> <ol style="list-style-type: none"> 1. Good surface roughness 2. High precision machining if the machined portion does not contact the guide bush. <p><u>Disadvantages:</u></p> <ul style="list-style-type: none"> • If a machining pass is long, the guide bush can not support the workpiece. 	<p>When using TKFB12L28010M (for back turning / left hand)</p>  <p><u>Advantages:</u></p> <ol style="list-style-type: none"> 1. Minimal deflection in long machining passes 2. Chips are broken into small pieces, though the workpiece material is sticky. 3. High precision machining if the machined portion does not contact the guide bush. <p><u>Disadvantages:</u></p> <ul style="list-style-type: none"> • The pre-stage machining may cause fractures, because of interrupted machining.

E



Small tools

Countermeasure against peeled surface in face back turning

When peeled surface occurs on the workpiece face, please apply the countermeasures below.

Countermeasures 1 Face finishing

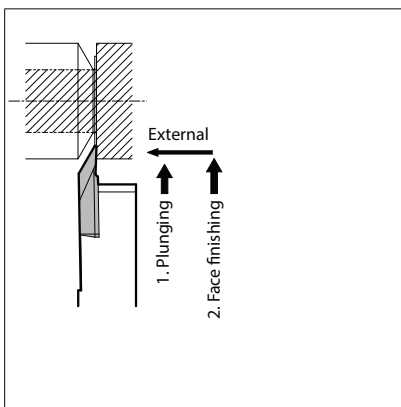

Countermeasures 2 Face finishing after grooving

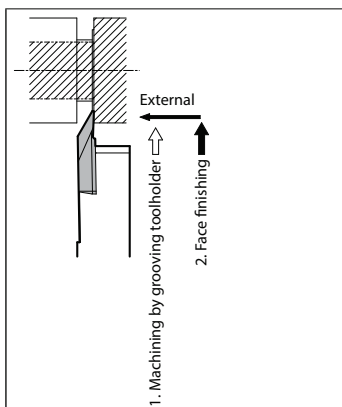

AABS-40F (Back turning / Edge width : 2.8mm, Max. depth : 4mm)

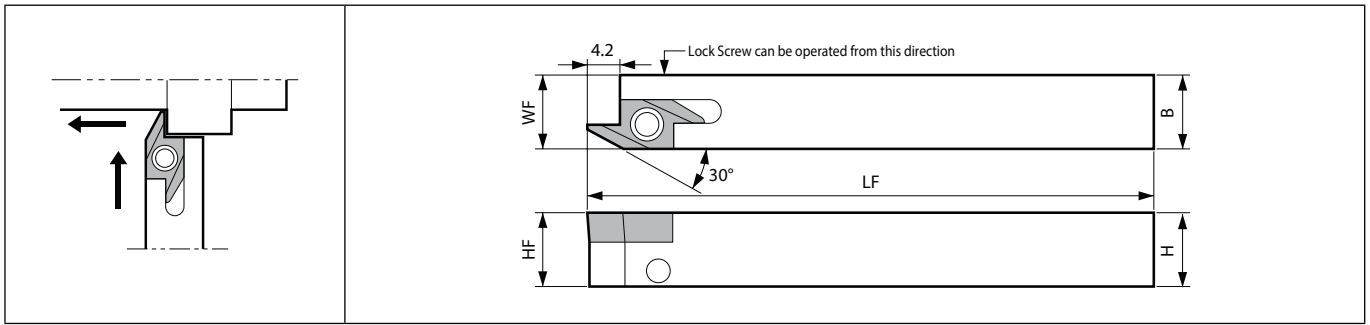

Toolholder dimensions

Description	Availability		Dimension (mm)				Standard corner-R(RE)	Spare parts			Applicable inserts ➔ B112
	R	H	B	HF	LF	WF		Anchor pin	Lock screw	Wrench	
AABSR 1010JX-40F	●	10	10	10	10.2	0.15	LPA-11	HSB4X8R	FH-2	ABS15R40...	
1212JX-40F	●	12	12	12	120		LPA-13				
1616JX-40F	●	16	16	16	16.2		LPA-17				

SABS-40F (Back turning / Edge width : 2.8mm, Max. depth : 4mm)

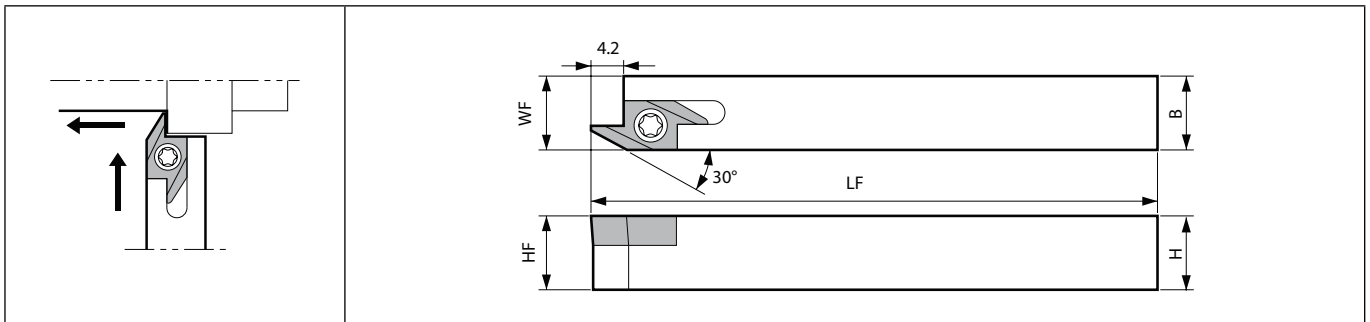

Toolholder dimensions

Description	Availability		Dimension (mm)				Standard corner-R(RE)	Spare parts		Applicable inserts ➔ B112
	R	H	B	HF	LF	WF		Screw	Wrench	
SABSR 1010JX-40F	●	10	10	10	120	0.15	SB-3080TR	FT-10	ABS15R40...	
1212F-40F	●	12	12	12	85					
1212JX-40F	●				120					
1616JX-40F	●	16	16	16	16.2					
2020K-40F	●	20	20	20	125					20.2

Applicable inserts

Applications	Back turning
Insert	
Type	ABS15
Page	B112

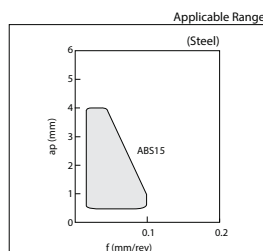

Recommended cutting conditions ➔ E67

● : Standard item R : Right-hand only L : Left-hand only □ : Check availability

AABW-40F (Back turning / Edge width : 4.7mm, Max. depth : 4mm)

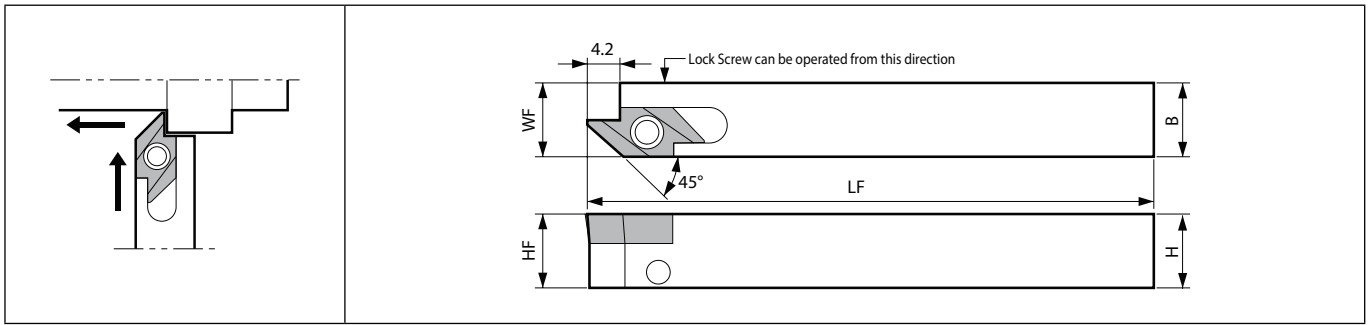

Toolholder dimensions

Description	Availability		Dimension (mm)				Standard corner-R(RE)	Spare parts			Applicable inserts ➔ B112
	R	H	B	HF	LF	WF		Anchor pin	Lock screw	Wrench	
	AABWR	1010JX-40F	●	10	10	10		10.2	0.15	LPA-11	
	1212JX-40F	●	12	12	12	120	12.2	LPA-13			
	1616JX-40F	●	16	16	16	16.2	16.2	LPA-17			

SABW-40F (Back turning / Edge width : 4.7mm, Max. depth : 4mm)

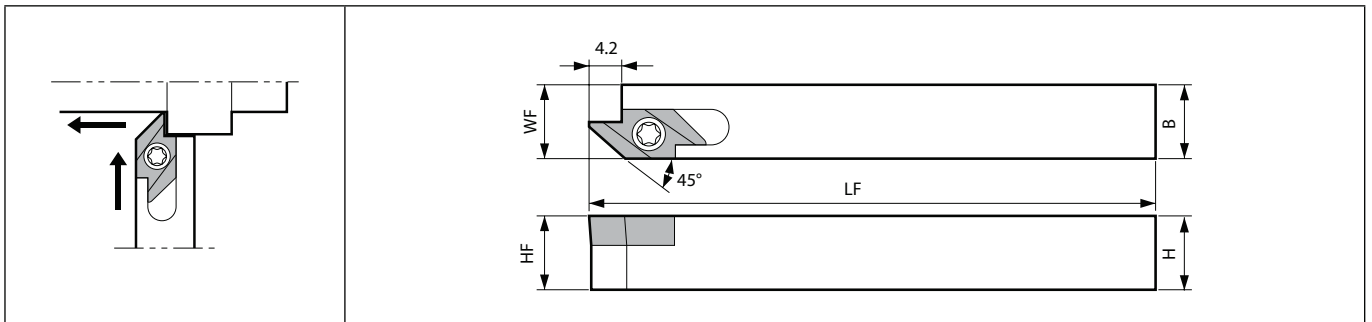

Toolholder dimensions

Description	Availability		Dimension (mm)				Standard corner-R(RE)	Spare parts		Applicable inserts ➔ B112
	R	H	B	HF	LF	WF		Screw	Wrench	
	SABWR	1010JX-40F	●	10	10	10		10.2	0.15	
	1212JX-40F	●	12	12	12	120	12.2			
	1616JX-40F	●	16	16	16	16.2	16.2			
	2020K-40F	●	20	20	20	125	20.2			

Applicable inserts

Applications	Back turning
Insert	
Type	ABW15
Page	B112

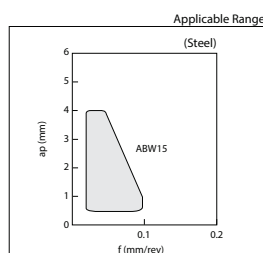

Recommended cutting conditions ➔ E67

● : Standard item R : Right-hand only L : Left-hand only □ : Check availability

AABW-50F (Back turning / Edge width : 4.7mm, Max. depth : 5mm)

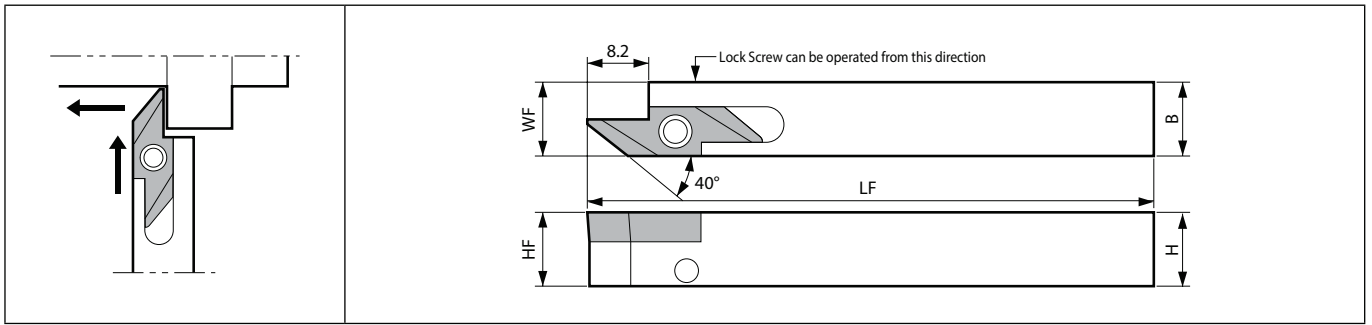

E

Toolholder dimensions

Description	Availability		Dimension (mm)				Standard corner-R(RE)	Spare parts			Applicable inserts ➔ B112
	R	H	B	HF	LF	WF		Anchor pin	Lock screw	Wrench	
	AABWR	1010JX-50F	●	10	10	10		10.2	0.15	LPA-11	
	1212JX-50F	●	12	12	12	12.2	LPA-13				
	1616JX-50F	●	16	16	16	16.2	LPA-17				

SABW-50F (Back turning / Edge width : 4.7mm, Max. depth : 5mm)

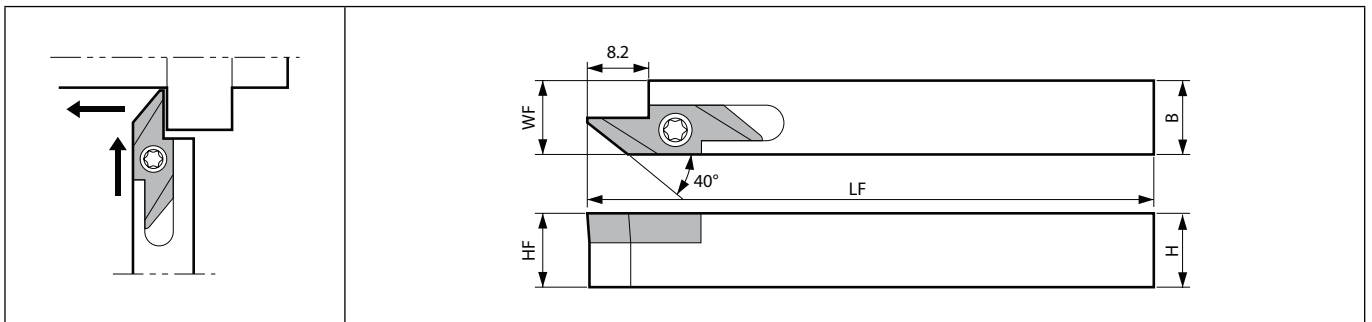

Toolholder dimensions

Description	Availability		Dimension (mm)				Standard corner-R(RE)	Spare parts		Applicable inserts ➔ B112
	R	H	B	HF	LF	WF		Screw	Wrench	
	SABWR	1010JX-50F	●	10	10	10		10.2	0.15	
	1212JX-50F	●	12	12	12	12.2				
	1616JX-50F	●	16	16	16	16.2				
	2020K-50F	●	20	20	20	20.2				

Applicable inserts

Applications	Back turning
Insert	
Type	ABW23
Page	B112

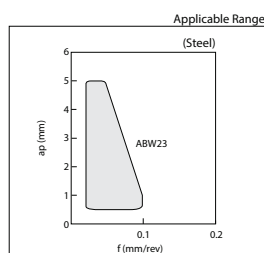

Recommended cutting conditions ➔ E67

● : Standard item R : Right-hand only L : Left-hand only □ : Check availability

SDJC (External turning / External copying)

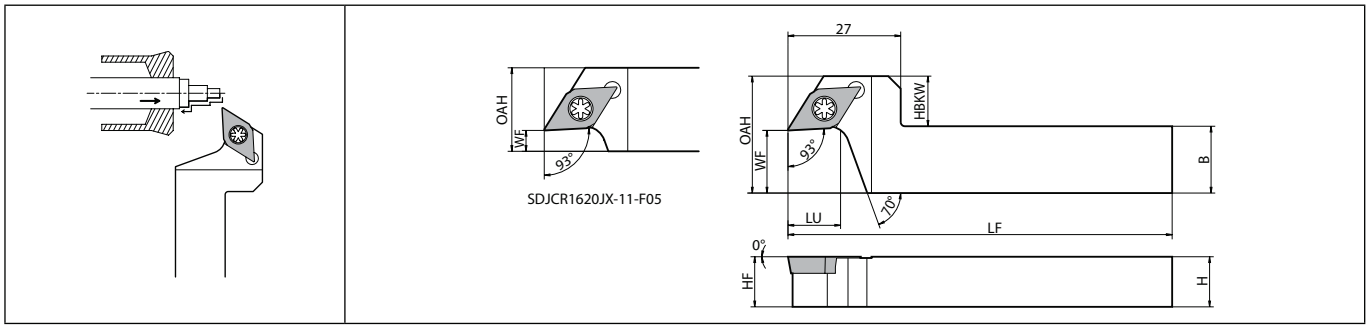

Right-hand shown

Toolholder dimensions

Description	Availability	Dimension (mm)									Standard corner-R(RE)	Spare parts		Applicable inserts
		R	H	B	OAH	HF	HBKW	LF	LU	WF		Screw	Wrench	
SDJCR 1216JX-11-F05 1216JX-11-F15 1620JX-11-F05 1620JX-11-F15	● ● ● ●	12 16	16 20	18 20 28	12 16 8	2 -	120	12.6	5 15 5 15	0.2	SB-4085TR	FT-15	DC□T11T3... DC□W11T3... DC□X11T3...	

For WP chipbreaker, cutting edge offsets or program corrections are required on R36 and R37.

Applicable inserts

Applications	Minute ap	Finishing	Finishing	Finishing	Finishing	Finishing - Medium	Finishing	Finishing
Insert								
Chip Breaker Type	CF	GF	SKS	SK	CK	GQ	WP	¾-WP
Page	B68	B68	B68	B68	B68	B69	B69	B69
Applications	Finishing	Finishing	Finishing - Medium	Finishing - Medium	Medium	Medium	Finishing	Finishing
Insert								
Chip Breaker Type	PP	GP	GK	HQ	STD	MF	¾-F	¾-FSF
Page	B69	B69	B70	B70	B70	B70	B72, B73	B72
Applications	Low feed	Low feed	Low feed	Low feed	Low carbon steel	Low carbon steel	Stainless steel / Heat-resistant alloys	Cast iron
Insert								
Chip Breaker Type	¾-U	¾-USF	¾-J	¾-JSF	XP	XQ	MQ	No CB
Page	B74~B76	B74	B77	B76	B71	B71	B71	B78
Applications	Non-Ferrous Metals	Non-Ferrous Metals	Non-Ferrous Metals	Non-Ferrous Metals	Non-Ferrous Metals	Hard materials		
Insert								
Chip Breaker Type	AP	¾-A3	AH	PCD	APD	CBN		
Page	B78	B78	B78	C42	C42	C22		

Recommended cutting conditions E65, E66

● : Standard item R : Right-hand only L : Left-hand only □ : Check availability

E



Small tools

SVLP (External turning / External copying)

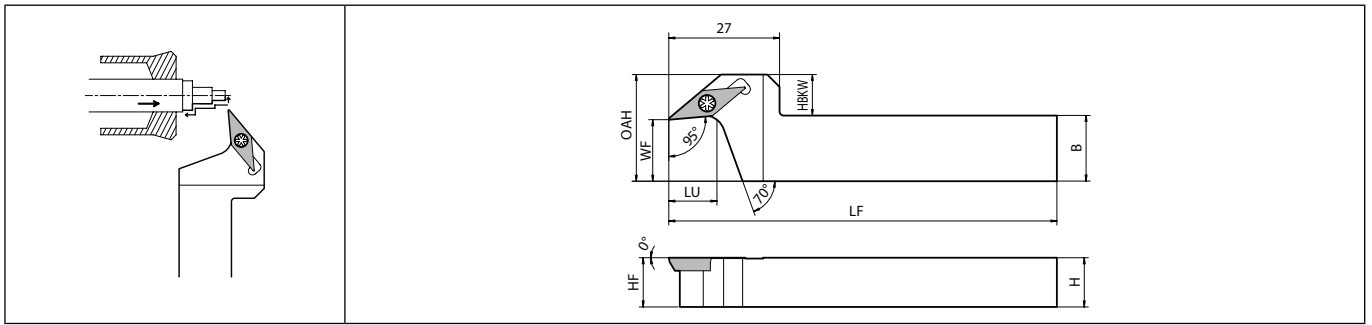

Right-hand shown









E

Toolholder dimensions

Description	Availability		Dimension (mm)								Standard corner-R(RE)	Spare parts		Applicable inserts
	R	H	B	OAH	HF	HBKW	LF	LU	WF	Screw		Wrench		
	SVLPR 1216JX-11-F15 1620JX-11-F15	●	12 16	16 20	26 16	12 6	10	120	12	15		0.2		

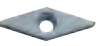
Small tools

Applicable inserts

Applications	Minute ap	Finishing	Finishing	Finishing	Finishing	Finishing	Low feed	Low feed
Insert								
Chip Breaker Type	CF	GF	SKS	CK	°/-F	°/-FSF	°/-U	°/-USF
Page	B102	B103	B103	B102	B102-B103	B102	B104	B104
Applications	Low feed							
Insert								
Chip Breaker Type	°/-J							
Page	B103							

Recommended cutting conditions  E65, E66

● : Standard item R : Right-hand only L : Left-hand only □ : Check availability

Goose-neck holder is available for multiple passes at roughing and finishing

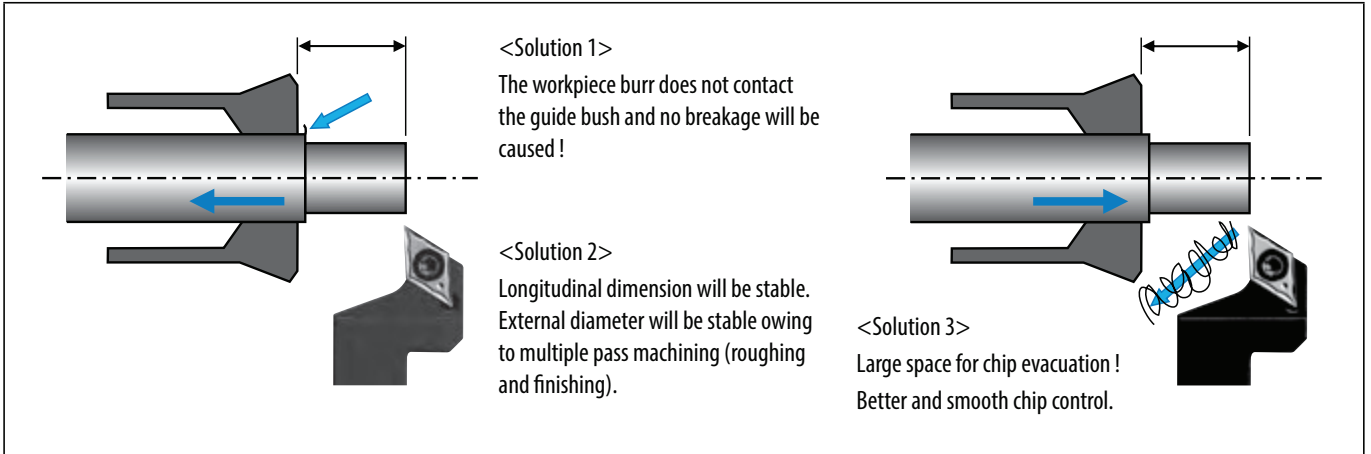

<Solution 1>
The workpiece burr does not contact the guide bush and no breakage will be caused!

<Solution 2>
Longitudinal dimension will be stable. External diameter will be stable owing to multiple pass machining (roughing and finishing).

<Solution 3>
Large space for chip evacuation!
Better and smooth chip control.

One toolholder for complex shape workpiece

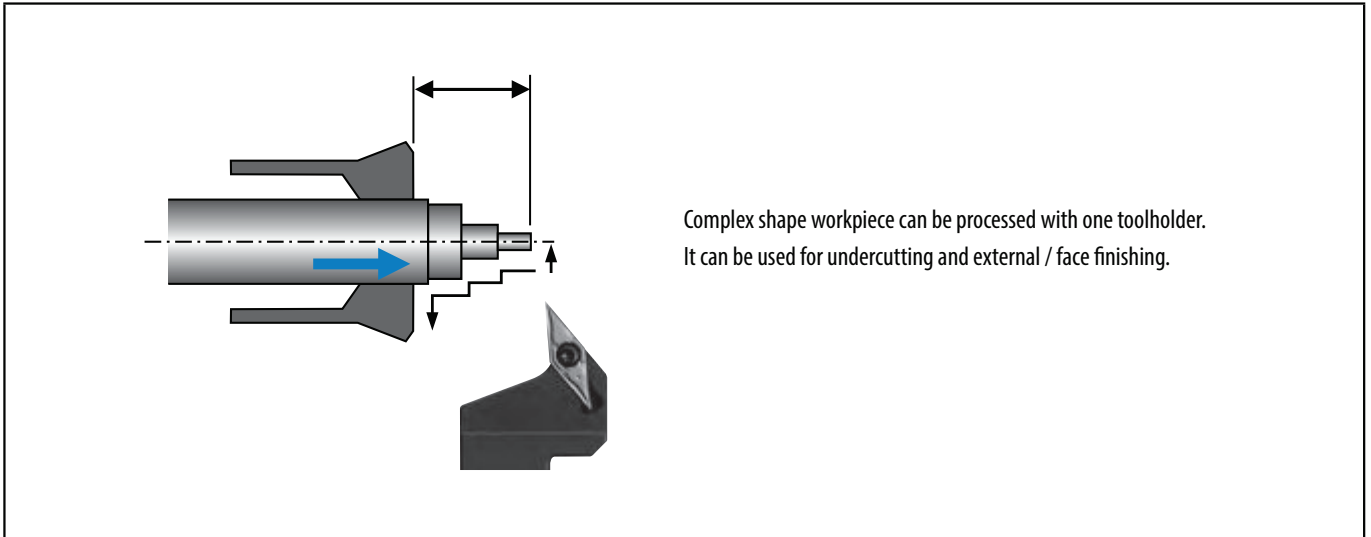

Complex shape workpiece can be processed with one toolholder.
It can be used for undercutting and external / face finishing.

ACLC-FF (External turning / External facing , Back clamp, Without offset)

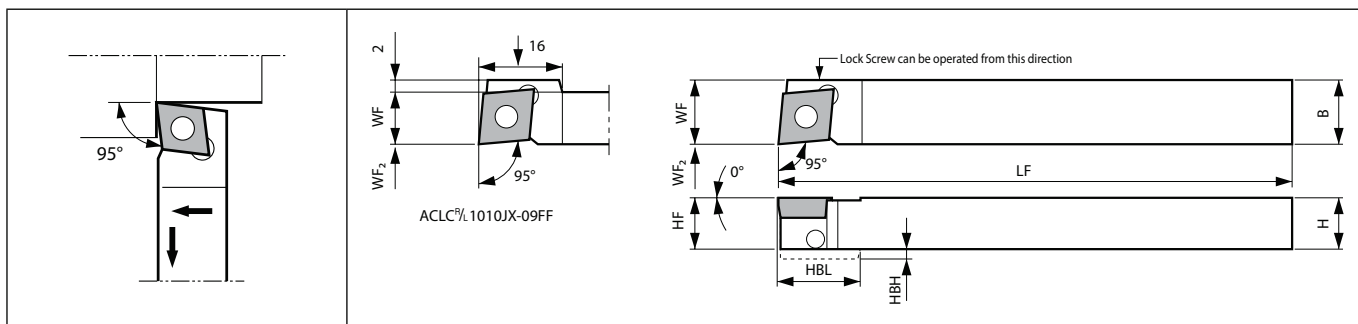

Right-hand shown

Toolholder dimensions

Description	Availability		Dimension (mm)										Standard corner-R(RE)	Spare parts			Applicable inserts
	R	L	H	B	HF	HBH	HBL	LF	WF	WF2	Anchor pin	Lock screw		Wrench			
ACLC% 1010JX-06FF	●	●	10	10	10	-	-	120	10	0	0.2	LPF-11	HSB4X8%	FH-2	CC□T0602... CC□W0602...		
ACLC% 1010JX-09FF	●	●	10	10	10	2	16		10		0.2	LPF-13	HSB4X8%	FH-2	CC□T09T3... CC□W09T3...		
1212JX-09FF	●	●	12	12	12	-	-	120	12			LPF-17					
1616JX-09FF	●	●	16	16	16	-	-		16								

Lock Screw : HSB4X8R for Right-hand Toolholder, HSB4X8L for Left-hand Toolholder.

SCLC-FF (External turning / External facing , Screw clamp, Without offset)

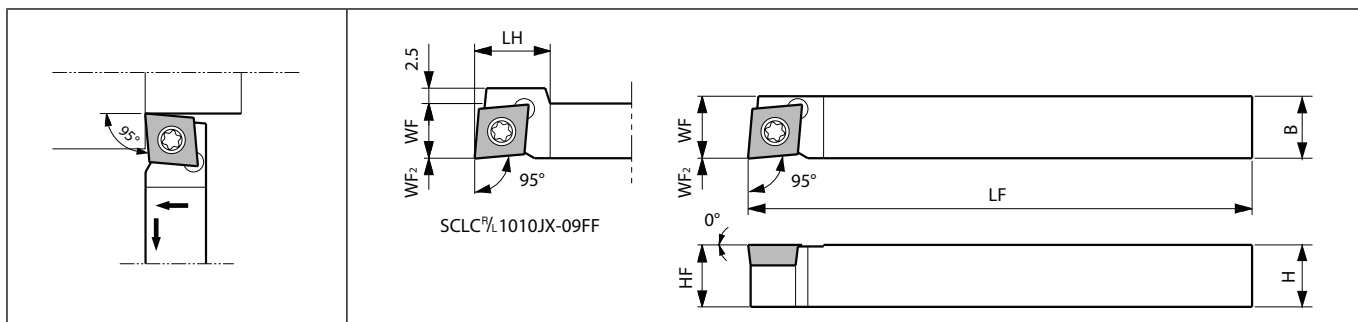

Right-hand shown

Toolholder dimensions

Description	Availability		Dimension (mm)										Standard corner-R(RE)	Spare parts			Applicable inserts
	R	L	H	B	LH	HF	LF	WF	WF2	Screw	Wrench	Wrench					
SCLC% 0808F-06FF	●	●	8	8		8	85	8			0.2	SB-2570TR	-	FT-8	CC□T0602... CC□W0602...		
1010JX-06FF	●	●	10	10	-	10	120	10									
SCLC% 1010JX-09FF	●	●	10	10	15	10	120	10		0.2	SB-4085TR	FT-15	-	CC□T09T3... CC□W09T3...			
1212F-09FF	●	●					85	12									
1212JX-09FF	●	●	12	12		12		12									
1616JX-09FF	●	●	16	16		16		120	16								
2020JX-09FF	●	●	20	20		20		20									

● : Standard item R : Right-hand only L : Left-hand only □ : Check availability

SCLC-FFJCTM (External turning / External facing , Screw clamp, Without offset, Coolant-through holder)

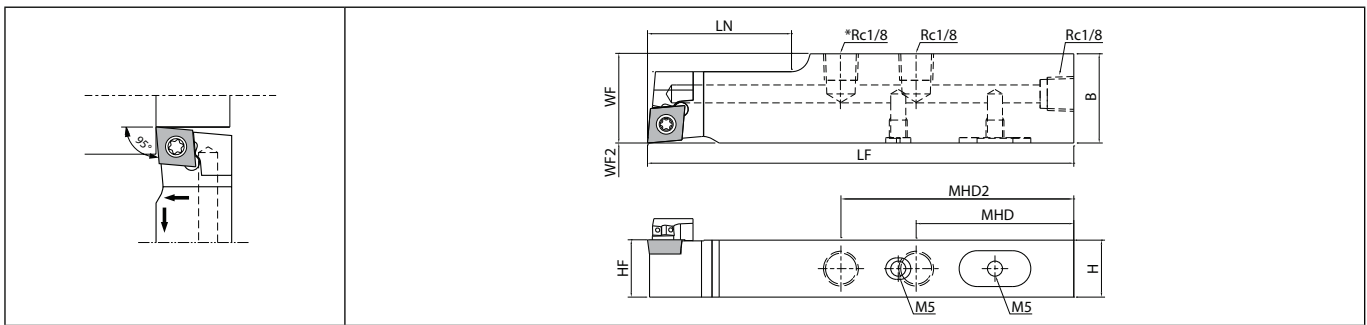

Right-hand shown | SCLCR12...: 2-Rc1/8

Toolholder dimensions

Description	Availability		Dimension (mm)								Standard corner-R(RE)	Coolant hole	Spare parts				Applicable inserts
	R	H	B	MHD	MHD2	HF	LF	LN	WF	WF2			Plug	Plug	Screw	Wrench	
SCLCR 1218JX-09FFJCTM	●	12	18	54	-	12		28	18		0.2	Yes	GP-1	HS5X4LP	SB-4085TR	FT-15	CC□T09T3... CC□W09T3...
1625JX-09FFJCTM	●	16	25	44	65	16	120	40	25								
2025JX-09FFJCTM	●	20				20											

Please see page H16 and H17 for piping parts of coolant-through holders.



Small tools

● : Standard item R : Right-hand only L : Left-hand only □ : Check availability

SCLC (External turning / External facing , Screw clamp)

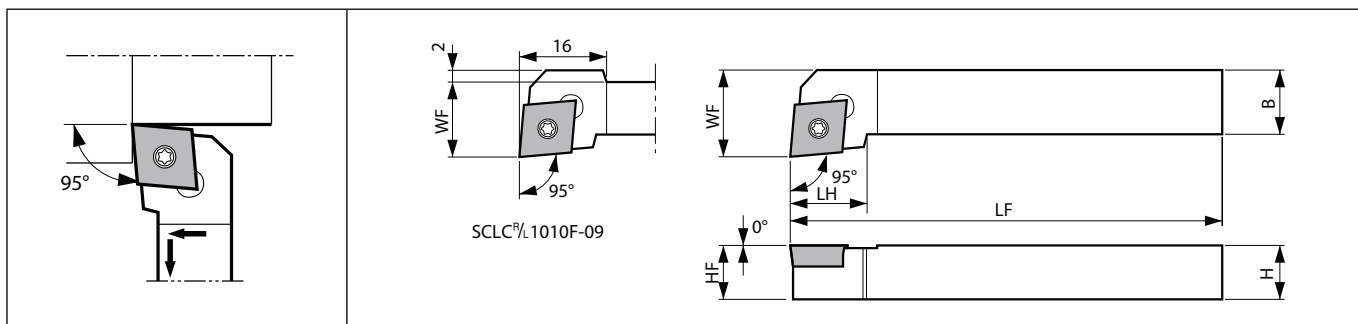

Right-hand shown

Toolholder dimensions

Description	Availability		Dimension (mm)							Standard corner-R(RE)	Spare parts				Applicable inserts
	R	L	H	B	LH	HF	LF	WF	Screw		Wrench	Wrench	Wrench		
SCLC% 1010F-06	●	●	10	10	9	10	80	12	0.2	SB-2570TR	-	FT-8	-	CC T0602... CC W0602...	
SCLC% 1010F-09	●	●	10	10	14	10	80	14	0.2	SB-4085TR	FT-15	-	-	CC T09T3... CC W09T3...	
1212H-09	●	●	12	12	12	12	100	16							
1616H-09	●	●	16	16	15	16	20	20							
2020K-09	●	●	20	20	20	20	125	25							
2525M-09	●	●	25	25	22	25	150	32							
SCLC% 1616H-12	●	●	16	16	20	16	100	20	0.4	SB-5090TR	-	-	LTW-20	CC T1204...	
2020K-12	●	●	20	20	22	20	125	25							
2525M-12	●	●	25	25	25	25	150	32							

Applicable inserts (ACLC-FF / SCLC-FF / SCLC-FFJCTM / SCLC)

Applications	Finishing	Finishing	Finishing	Finishing	Finishing	Finishing - Medium	Finishing	Finishing
Insert								
Chip Breaker Type	PF	GF	SKS	SK	CK	GQ	WP	PP
Page	B58	B58	B59	B59	B59	B59	B60	B60
Applications	Finishing - Medium	Finishing - Medium	Medium	Medium	Low feed	Low feed	Stainless steel / Heat-resistant alloys	Cast iron
Insert								
Chip Breaker Type	GK	HQ	STD	MF	%-U	%-J	MQ	No CB
Page	B60	B60	B60	B61	B63-B65	B65	B61	B66
Applications	Non-Ferrous Metals	Non-Ferrous Metals	Non-Ferrous Metals	Non-Ferrous Metals	Non-Ferrous Metals	Hard materials		
Insert								
Chip Breaker Type	AP	%-A3	AH	PCD	APD	CBN		
Page	B66	B66	B66	C39	C40	C20		

Recommended cutting conditions E65, E66

● : Standard item R : Right-hand only L : Left-hand only □ : Check availability

ADJC-FF (External turning / External copying , Back clamp, Without offset)

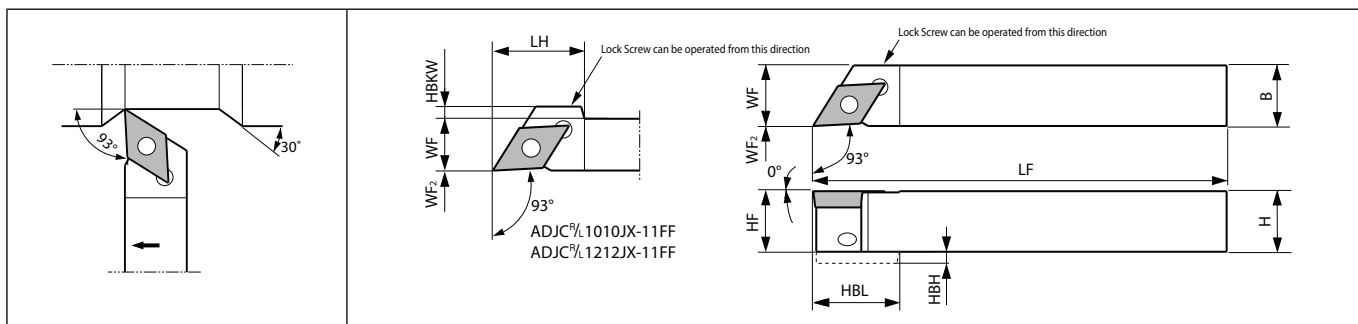

Right-hand shown

Toolholder dimensions

Description	Availability		Dimension (mm)										Standard corner-R(RE)	Spare parts			Applicable inserts
														Anchor pin	Lock screw	Wrench	
	R	L	H	B	LH	HF	HBH	HBKW	HBL	LF	WF	WF2					
ADJC% 1010JX-07FF	●	●	10	10	-	10	-	-	-	120	10	0	0.2	LPF-11	HSB4X8%	FH-2	DC□T0702... DC□W0702... DC□X0702...
ADJC% 1010JX-11FF 1212JX-11FF 1616JX-11FF	●	●	10	10	20	10	2	3	20	120	10	0	0.2	LPF-13	HSB4X8%	FH-2	DC□T11T3... DC□W11T3... DC□X11T3...
	●	●	12	12		12	1	12	12								
	●	●	16	16	-	16	-	-	16	16							

Lock Screw : HSB4X8R for Right-hand Toolholder, HSB4X8L for Left-hand Toolholder.
For WP chipbreaker, cutting edge offsets or program corrections are required on **R36** and **R37**.

SDJC-FF (External turning / External copying, Screw clamp, Without offset)

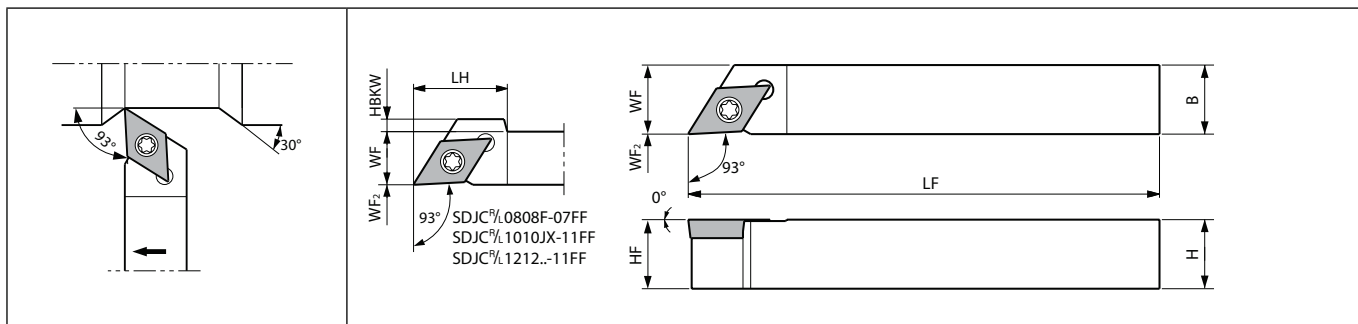

Right-hand shown

Toolholder dimensions

Description	Availability		Dimension (mm)										Standard corner-R(RE)	Spare parts			Applicable inserts
														Screw	Wrench	Wrench	
	R	L	H	B	LH	HF	HBKW	LF	WF	WF2							
SDJC% 0808F-07FF 1010JX-07FF	●	●	8	8	14	8	0.5	85	8	0	0.2	SB-2570TR	-	FT-8	DC□T0702... DC□W0702... DC□X0702...		
	●	●	10	10	-	10	-	120	10								
SDJC% 1010JX-11FF 1212F-11FF 1212JX-11FF 1616JX-11FF 2020JX-11FF	●	●	10	10	20	10	3	120	10	0	0.2	SB-4085TR	FT-15	-	DC□T11T3... DC□W11T3... DC□X11T3...		
	●	●	12	12		12	1	85	12								
	●	●	16	16	-	16	-	120	16								
	●	●	20	20	-	20	-	20	20								

For WP chipbreaker, cutting edge offsets or program corrections are required on **R36** and **R37**.

● : Standard item R : Right-hand only L : Left-hand only □ : Check availability



Small tools

SDJC-FFJCTM (External turning / External copying, Screw clamp, Without offset, Coolant-through holder)

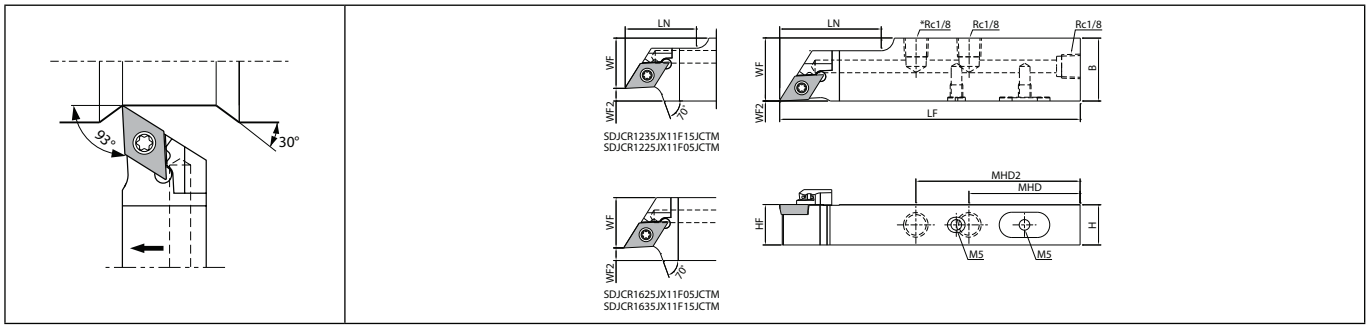

Right-hand shown | SDJCR12...:2-Rc1/8

E

Toolholder dimensions

Description	Availability	Dimension (mm)										Standard corner-R(RE)	Coolant hole	Spare parts				Applicable inserts
		R	H	B	MHD	MHD2	HF	LF	LN	WF	WF2			Plug	Plug	Screw	Wrench	
SDJCR 1218JX-11FFJCTM	●	12	18	54	-	12		28	18		0	0.2	Yes	GP-1	HSSX4LP	SB-4085TR	FT-15	DC□T11T3... DC□W11T3... DC□X11T3...
SDJCR 1625JX-11FFJCTM	●	16	25	44	65	16	120	40	25									
SDJCR 2025JX-11FFJCTM	●	20				20												
SDJCR 1225JX11F05JCTM	●	12	25	54	-	12		28		5		0.2	Yes	GP-1	HSSX4LP	SB-4085TR	FT-15	DC□T11T3... DC□W11T3... DC□X11T3...
SDJCR 1235JX11F15JCTM	●		35				120			15								
SDJCR 1625JX11F05JCTM	●		25							5								
SDJCR 1635JX11F15JCTM	●	16	35	44	65	16		-		15								

Please see page H16 and H17 for piping parts of coolant-through holders.
For WP chipbreaker, cutting edge offsets or program corrections are required on R36 and R37.

Small tools

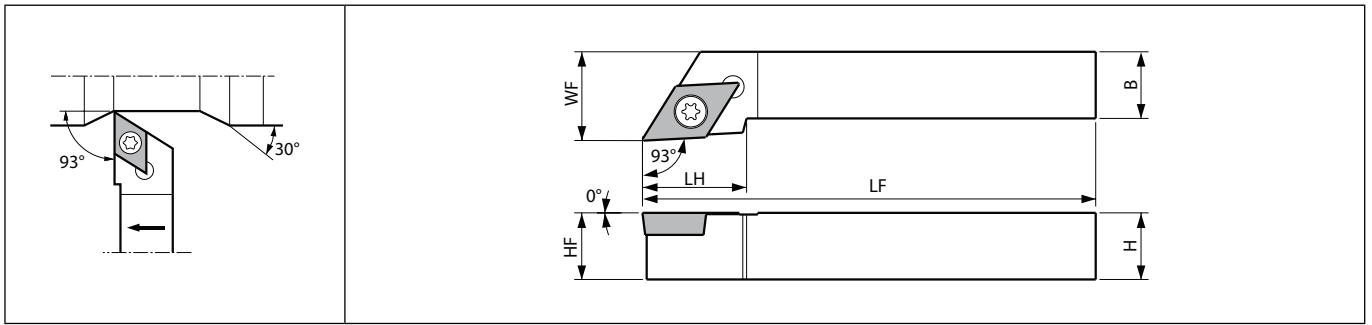

● : Standard item R : Right-hand only L : Left-hand only □ : Check availability

SDJC (External turning / External copying , Screw clamp)



Right-hand shown

Toolholder dimensions

Description	Availability		Dimension (mm)							Standard corner-R(RE)	Spare parts			Applicable inserts
											Screw	Wrench	Wrench	
	R	L	H	B	LH	HF	LF	WF						
SDJC ^{R/L} 1010F-07	●	●	10	10	12	10	80	12	0.2	SB-2570TR	-	FT-8	DC□T0702... DC□W0702... DC□X0702...	
SDJC ^{R/L} 1010F-11	●	●	10	10	18	10	80	12	0.2	SB-4085TR	FT-15	-	DC□T11T3... DC□W11T3... DC□X11T3...	
1212H-11	●	●	12	12		12	100	16						
1616H-11	●	●	16	16		16	125	20						
2020K-11	●	●	20	20		20	150	25						
2525M-11	●	●	25	25	23	25	150	32						

For WP chipbreaker, cutting edge offsets or program corrections are required on R36 and R37.



Small tools

SDJC-FF-Y (External turning / External copying , Y-axis toolholder)

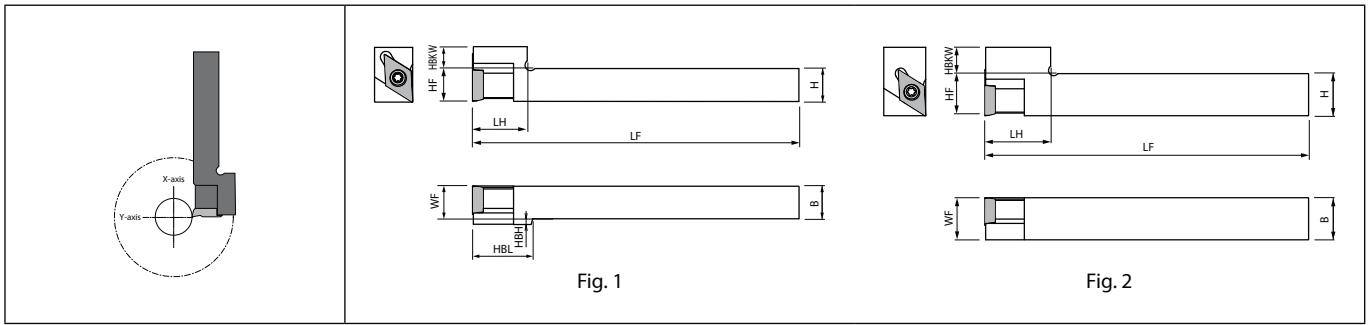

Right-hand shown | Right-hand Insert for Right-hand Toolholder.

E

Toolholder dimensions

Description	Availability		Dimension (mm)									Fig.	Coolant hole	Spare parts		Applicable inserts
	R	H	B	LH	HF	HBH	HBKW	HBL	LF	WF	Screw			Wrench		
SDJCR 1212JX-11FF-Y	●	12	12	20	12	2	8	22	120	12	1	No	SB-4085TR	FT-15	DC□T11T3... DC□W11T3... DC□X11T3...	
1616JX-11FF-Y	●	16	16	25	16	-	10	-	-	16	2					

For WP chipbreaker, cutting edge offsets or program corrections are required on R36 and R37.

Applicable inserts (ADJC-FF / SDJC-FF / SDJC-FFJCTM / SDJC / SDJC-FF-Y)

Applications	Minute ap	Finishing	Finishing	Finishing	Finishing	Finishing - Medium	Finishing	Finishing
Insert								
Chip Breaker Type	CF	GF	SKS	SK	CK	GQ	WP	1/2-WP
Page	B68	B68	B68	B68	B68	B69	B69	B69
Applications	Finishing	Finishing	Finishing - Medium	Finishing - Medium	Medium	Medium	Finishing	Finishing
Insert								
Chip Breaker Type	PP	GP	GK	HQ	STD	MF	1/2-F	1/2-FSF
Page	B69	B69	B70	B70	B70	B70	B72, B73	B72
Applications	Low feed	Low feed	Low feed	Low feed	Low carbon steel	Low carbon steel	Stainless steel / Heat-resistant alloys	Cast iron
Insert								
Chip Breaker Type	1/2-U	1/2-USF	1/2-J	1/2-JSF	XP	XQ	MQ	No CB
Page	B74~B76	B74	B77	B76	B71	B71	B71	B78
Applications	Non-Ferrous Metals	Non-Ferrous Metals	Non-Ferrous Metals	Non-Ferrous Metals	Non-Ferrous Metals	Hard materials		
Insert								
Chip Breaker Type	AP	1/2-A3	AH	PCD	APD	CBN		
Page	B78	B78	B78	C42	C42	C22		

Recommended cutting conditions

● : Standard item R : Right-hand only L : Left-hand only □ : Check availability

Small tools

Precautions for using Y-axis toolholder

Do not use Y-axis toolholders side by side to prevent interference. (Only two Y-axis holder can be used at the same time)

With interference

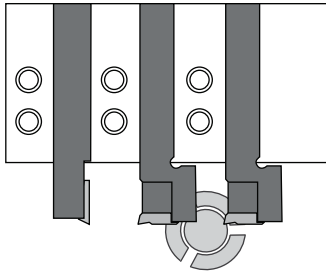

Without interference

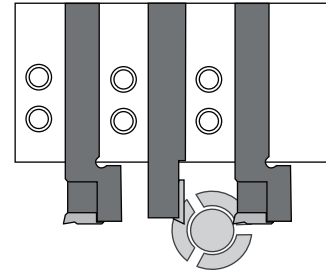

Standard toolholders may be mounted between two Y-axis toolholders

When changing the tool, set the retracted position with reference to the cutting edge of the Y-axis holder. (When exchanging from tool B to D)

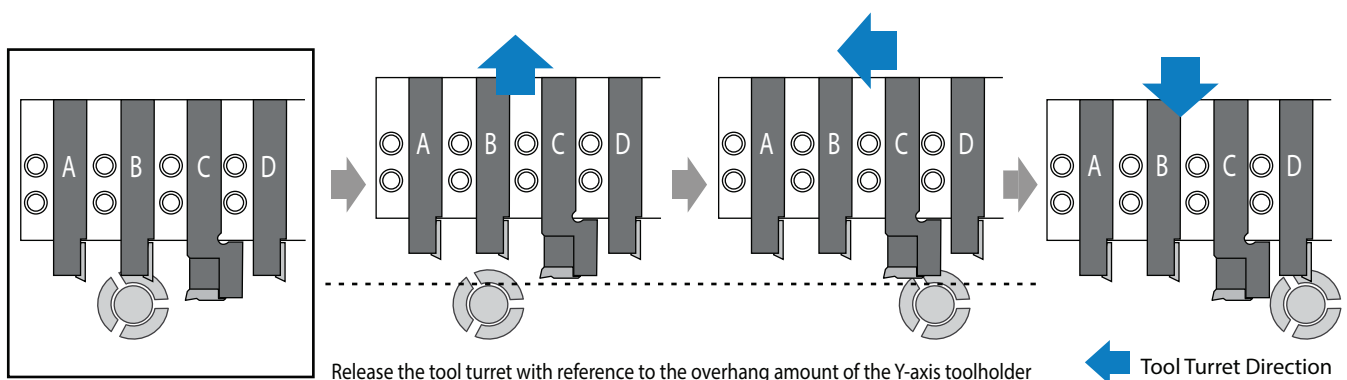

Release the tool turret with reference to the overhang amount of the Y-axis toolholder

Tool Turret Direction

E
Small tools

Note that using other toolholders together will result in different outside diameters

(Unit : mm)

Y-axis Toolholder Overhang	Examples	Overhang amount L			
		Available outside cutting diameter (φ)	20	22	25
20		A	Without Restriction	Without Restriction	Without Restriction
		B	13.0	13.0	13.0
		C	Without Restriction	Without Restriction	Without Restriction
25		A	38.0	58.0	Without Restriction
		B	14.9	13.6	13.0
		C	45.0	60.0	Without Restriction

SDLC-FF (External turning / External copying, Screw clamp, Without offset)

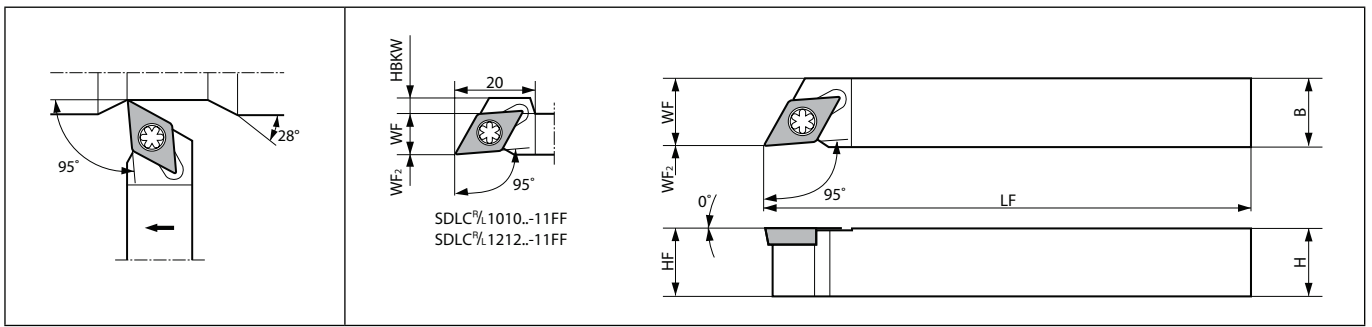

Right-hand shown

Toolholder dimensions

Description	Availability		Dimension (mm)							Standard corner-R(RE)	Spare parts			Applicable inserts
	R	L	H	B	HF	HBKW	LF	WF	Screw		Wrench	Wrench		
SDLC%L 1010JX-07FF 1212F-07FF 1212JX-07FF 1616JX-07FF	●	●	10	10	10		120	10	0	0.2	SB-2570TR	-	FT-8	DC□T0702... DC□W0702...
	●	●	12	12	12	-	85	12						
	●	●	16	16	16		120	16						
	●	●	16	16	16		120	16						
SDLC%L 1010F-11FF 1010JX-11FF 1212F-11FF 1212JX-11FF 1616H-11FF 1616JX-11FF	●		10	10	10	4	80	10	0	0.2	SB-4085TR	FT-15	-	DC□T11T3... DC□W11T3...
	●	●	12	12	12	2	85	12						
	●	●	12	12	12	2	120	12						
	●	●	16	16	16	-	100	16						
	●	●	16	16	16	-	100	16						
	●	●	16	16	16	-	120	16						

SDXC (External turning / External facing / External copying)

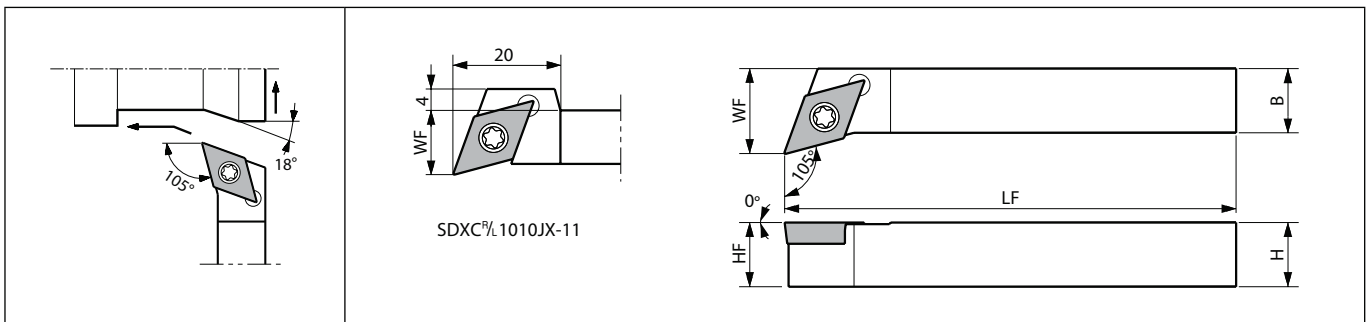

Right-hand shown

Toolholder dimensions

Description	Availability		Dimension (mm)							Standard corner-R(RE)	Spare parts			Applicable inserts
	R	L	H	B	HF	LF	WF	Screw	Wrench		Wrench			
SDXC%L 1010JX-07	●	●	10	10	10	120	12	0.2	SB-2570TR	-	FT-8	DC□T0702... DC□W0702...		
SDXC%L 1010JX-11 1212JX-11 1616JX-11	●	●	10	10	10	12	16	0.2	SB-4085TR	FT-15	-	DC□T11T3... DC□W11T3...		
	●	●	12	12	12	120	16							
	●	●	16	16	16	20	20							

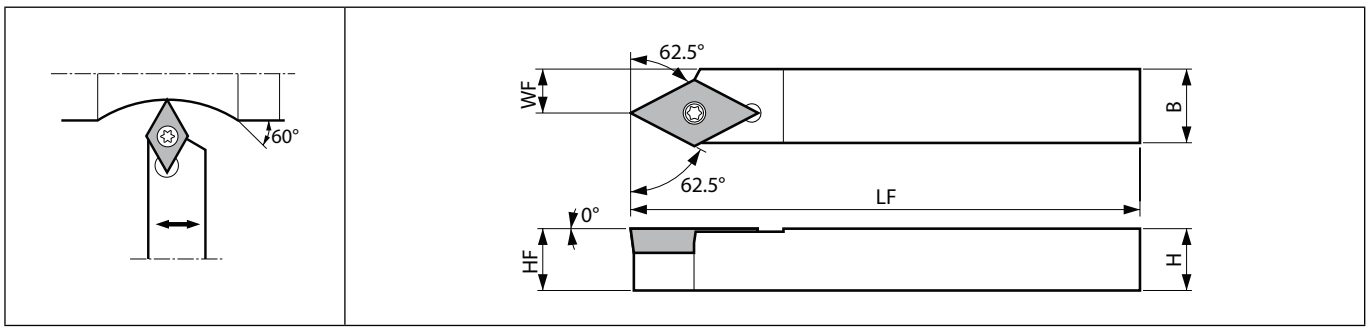

● : Standard item R : Right-hand only L : Left-hand only □ : Check availability

SDNC-F (External turning / External copying)



Right-hand shown

Toolholder dimensions

Description	Availability		Dimension (mm)					Standard corner-R(RE)	Spare parts			Applicable inserts
	R	L	H	B	HF	LF	WF		Screw	Wrench		
												
SDNC% 1010JX-07F	●		10	10	10	120	7	0.2	SB-2570TR	FT-8		DC□T0702... DC□W0702...



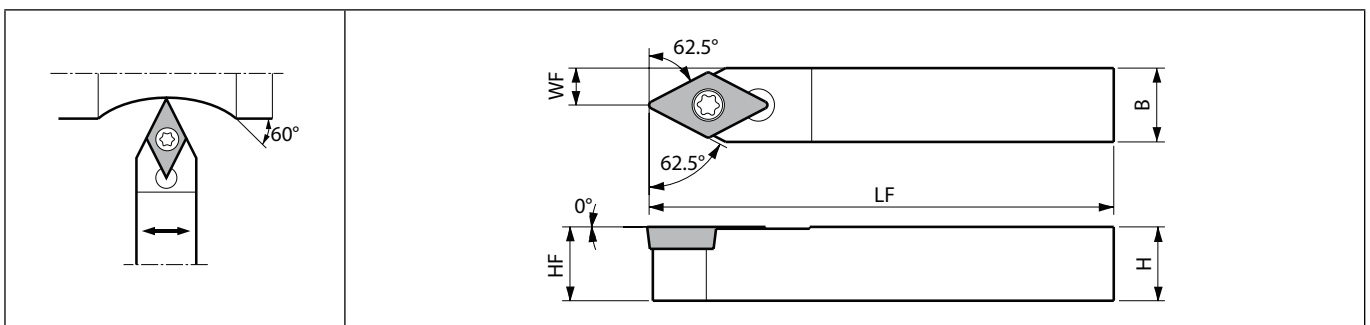

Small tools

SDNC (External turning / External copying)











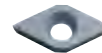

Toolholder dimensions

Description	Availability	Dimension (mm)					Standard corner-R(RE)	Spare parts			Applicable inserts	
		N	H	B	HF	LF		WF	Screw	Wrench		Wrench
												
SDNCN 0808F-07	●	8	8	8	85	4	0.2	SB-2570TR	-	FT-8	DC□T0702... DC□W0702...	
1010JX-07	●	10	10	10	120	5						
1212JX-07	●	12	12	12	120	6						
SDNCN 1010F-11	●	10	10	10	80	5	0.2	SB-4085TR	FT-15	-	DC□T11T3... DC□W11T3...	
1010JX-11	●					120						
1212F-11	●	12	12	12	85	6						
1212JX-11	●				120							
1616H-11	●	16	16	16	100	8						
1616JX-11	●				120							

● : Standard item R : Right-hand only L : Left-hand only □ : Check availability

Applicable inserts (SDLC-FF / SDXC / SDNC-F / SDNC)

Applications	Minute ap	Finishing	Finishing	Finishing	Finishing	Finishing - Medium	Finishing	Finishing
Insert								
Chip Breaker Type	CF	GF	SKS	SK	CK	GQ	PP	GP
Page	B68	B68	B68	B68	B68	B69	B69	B69
Applications	Finishing - Medium	Finishing - Medium	Medium	Medium	Finishing	Finishing	Low feed	Low feed
Insert								
Chip Breaker Type	GK	HQ	STD	MF	P/L-F	P/L-FSF	P/L-U	P/L-USF
Page	B70	B70	B70	B70	B72, B73	B72	B74~B76	B74
Applications	Low feed	Low feed	Low carbon steel	Low carbon steel	Stainless steel / Heat-resistant alloys	Cast iron	Non-Ferrous Metals	Non-Ferrous Metals
Insert								
Chip Breaker Type	P/L-J	P/L-JSF	XP	XQ	MQ	No CB	AP	P/L-A3
Page	B77	B76	B71	B71	B71	B78	B78	B78
Applications	Non-Ferrous Metals	Non-Ferrous Metals	Non-Ferrous Metals	Hard materials				
Insert								
Chip Breaker Type	AH	PCD	APD	CBN				
Page	B78	C42	C42	C22				

E

Small tools

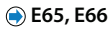

Recommended cutting conditions 

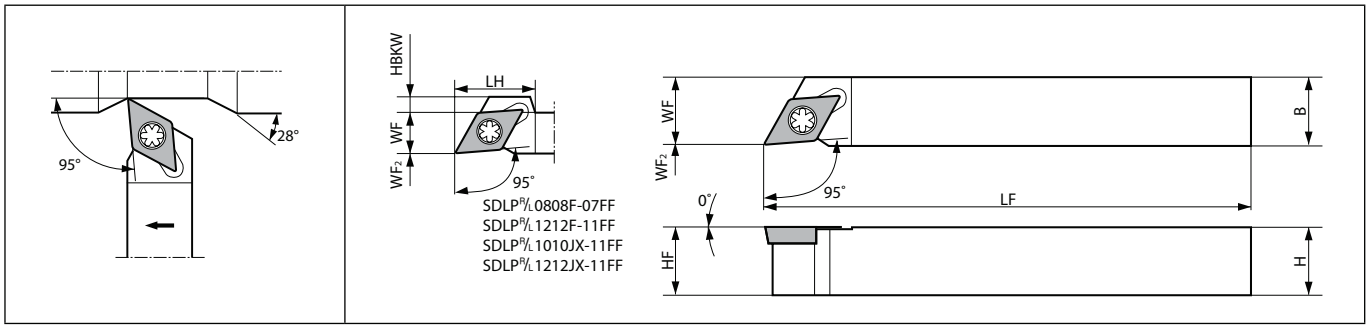
SDLP-FF (External turning / External copying, Screw clamp, Without offset)





Right-hand shown

Toolholder dimensions

Description	Availability		Dimension (mm)									Standard corner-R(RE)	Spare parts			Applicable inserts
													Screw	Wrench	Wrench	
	R	L	H	B	LH	HF	HBKW	LF	WF	WF2						
SDLP% 0808F-07FF 1010JX-07FF	●	●	8	8	14	8	0.5	85	8	0	0.2	SB-2570TR	-	FT-8	DPET0702...	
SDLP% 1010JX-11FF 1212JX-11FF 1616JX-11FF	●	●	10	10	20	10	4	10	10	0	0.2	SB-4085TR	FT-15	-	DPET11T3...	

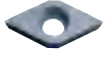
Applicable inserts

Applications	Finishing	Low feed
Insert		
Chip Breaker Type	%L-FSF	%L-USF
Page	B79	B79

Recommended cutting conditions  E65, E66

● : Standard item R : Right-hand only L : Left-hand only □ : Check availability

E



Small tools

STGC (External turning)

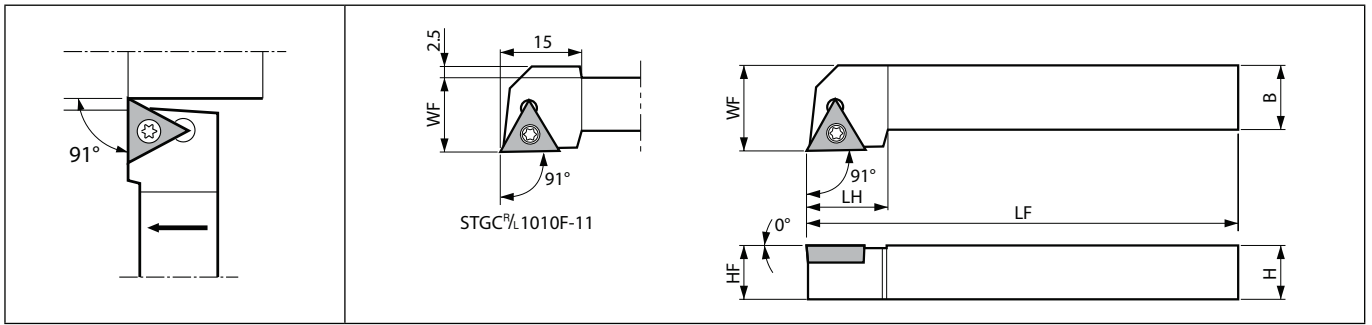

Right-hand shown

E



Small tools

Toolholder dimensions

Description	Availability		Dimension (mm)							Standard corner-R(RE)	Spare parts		Applicable inserts
											Screw	Wrench	
	R	L	H	B	LH	HF	LF	WF					
STGC 90 L 0808E-08	●		8	8	12	8	70	10	0.2	SB-2050TR	FT-6	TC T0802... TC W0802...	
1010F-08	●	●	10	10		10	80	12					
STGC 90 L 1010F-11	●	●	10	10	15	10	80	14	0.4	SB-2570TR	FT-8	TC T1103... TC W1103...	
1212H-11	●	●	12	12		12	100	16					
1616H-11	●	●	16	16		16	20	20					
2020K-11	●	●	20	20		20	125	25					
2525M-11	●	●	25	25		20	25	150					32

Applicable inserts

Applications	Low feed	Low feed	Cast iron	Non-Ferrous Metals	Non-Ferrous Metals
Insert					
Chip Breaker Type	90°-U	90°-USF	No CB	90°-A3	PCD
Page	B86	B85	B87	B87	C45

Recommended cutting conditions E65, E66

● : Standard item R : Right-hand only L : Left-hand only □ : Check availability

STGP (External turning)

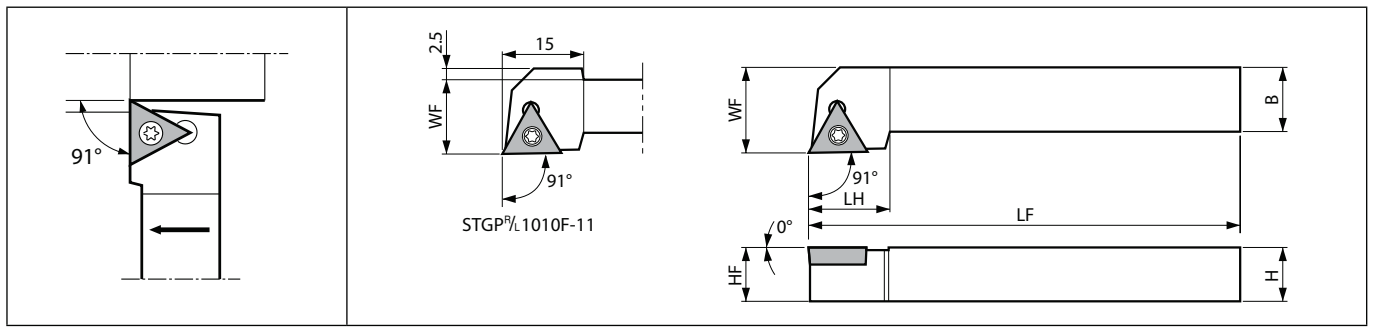

Right-hand shown

Toolholder dimensions

Description	Availability		Dimension (mm)							Standard corner-R(RE)	Spare parts		Applicable inserts
											Screw	Wrench	
	R	L	H	B	LH	HF	LF	WF					
STGPR 0808E-08	●		8	8	12	8	70	10	0.2	SB-2050TR	FT-6	TP□B0802..., TP□H0802... TP□T0802...	
STGP% 1010F-11	●	●	10	10		10	80	14	0.2	SB-3080TR	FT-10	TP□B1103... TP□H1103... TP□T1103...	
1212H-11	●	●	12	12	15	12	100	16					
1616H-11	●	●	16	16		16	20						

Applicable inserts

Applications	Minute ap	Finishing	Finishing	Finishing - Medium	Finishing	Finishing	Low feed	Medium
Insert								
Chip Breaker Type	CF	PP	GP	HQ	R/L	%L-FSF	%L-USF	%L-H
Page	B88	B88	B89	B89	B90, B91	B92	B94	B93
Applications	Low carbon steel	Low carbon steel	Cast iron	Non-Ferrous Metals	Non-Ferrous Metals	Non-Ferrous Metals	Hard materials	
Insert								
Chip Breaker Type	XP	XQ	No CB	AP	PCD	APD	CBN	
Page	B89	B89	B94	B94	C46, C47	C47	C23	

Recommended cutting conditions E65, E66

● : Standard item R : Right-hand only L : Left-hand only □ : Check availability



AVJB-FF (External turning / External copying, Back clamp, Without offset)

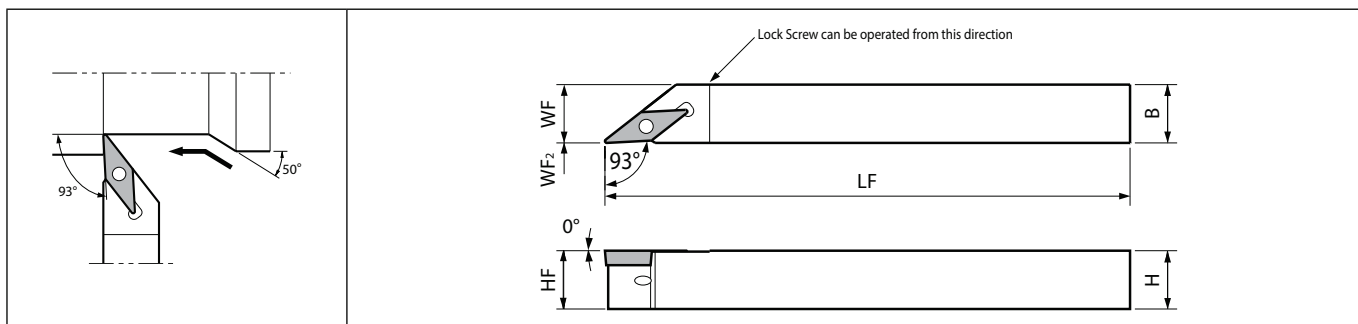

Right-hand shown

E

Toolholder dimensions

Description	Availability		Dimension (mm)							Standard corner-R(RE)	Spare parts			Applicable inserts
	R	L	H	B	HF	LF	WF	WF2	Anchor pin		Lock screw	Wrench		
	AVJB ^{5%} L	1010JX-11FF	●	●	10	10	10		10			0.4	LPF-11	
	1212JX-11FF	●	●	12	12	12	120	12			LPF-1113			
	1616JX-11FF	●	●	16	16	16		16			LPF-1117			

Lock Screw : HSB4X8R for Right-hand Toolholder, HSB4X8L for Left-hand Toolholder.

SVJB-FF (External turning / External copying, Screw clamp, Without offset)

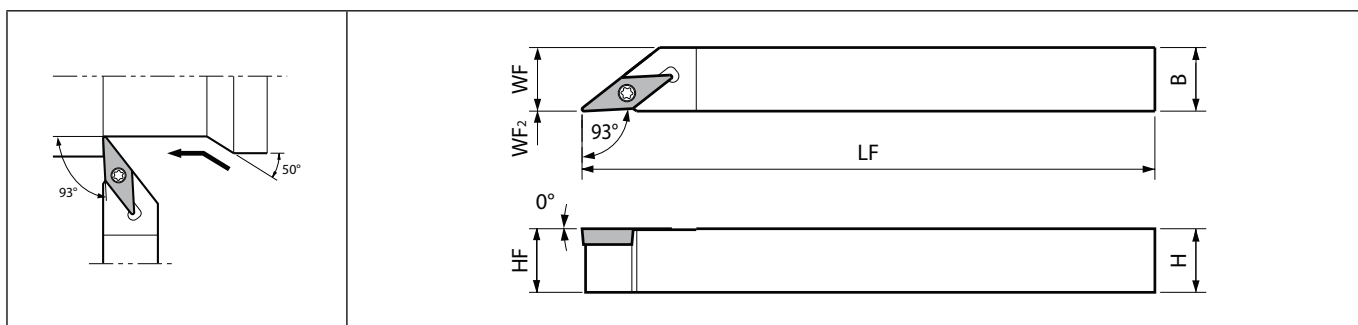

Right-hand shown

Toolholder dimensions

Description	Availability		Dimension (mm)							Standard corner-R(RE)	Spare parts		Applicable inserts
	R	L	H	B	HF	LF	WF	WF2	Screw		Wrench		
	SVJB ^{5%} L	1010JX-11FF	●	●	10	10	10		10			0.4	
	1212JX-11FF	●	●	12	12	12	120	12					
	1616JX-11FF	●	●	16	16	16		16					
	2020JX-11FF	●	●	20	20	20		20					

● : Standard item R : Right-hand only L : Left-hand only □ : Check availability



Small tools

SVJB-FFJCTM (External turning / External copying, Screw clamp, Without offset, Coolant-through holder)

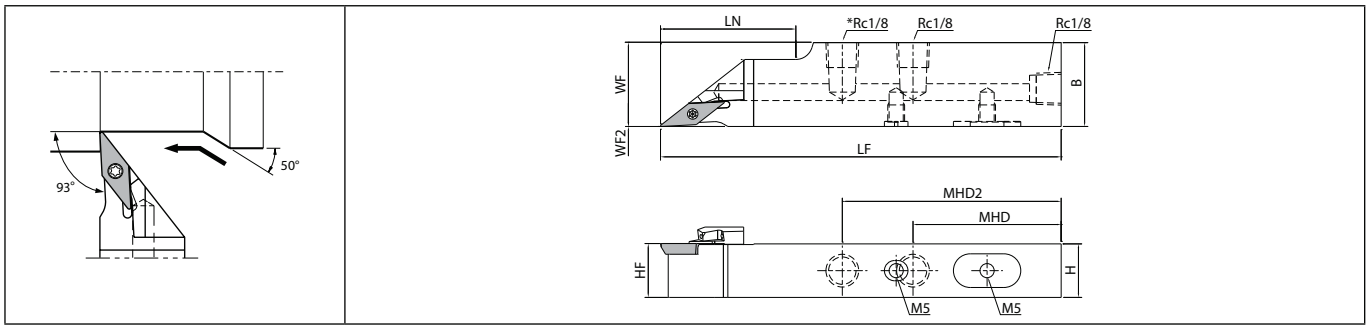

Right-hand shown | SVJBR12...: 2-Rc1/8

Toolholder dimensions

Description	Availability		Dimension (mm)								Standard corner-R(RE)	Coolant hole	Spare parts				Applicable inserts
	R	H	B	MHD	MHD2	HF	LF	LN	WF	WF2			Plug	Plug	Screw	Wrench	
	SVJBR 1218JX-11FFJCTM	●	12	18	54	-	12	28	18	0			0.4	Yes	GP-1	HS5X4LP	
1625JX-11FFJCTM	●	16	25	44	65	16	120	40	25								
2025JX-11FFJCTM	●	20				20											

Please see page H16 and H17 for piping parts of coolant-through holders.

SVJB (External turning / External copying, Screw clamp)

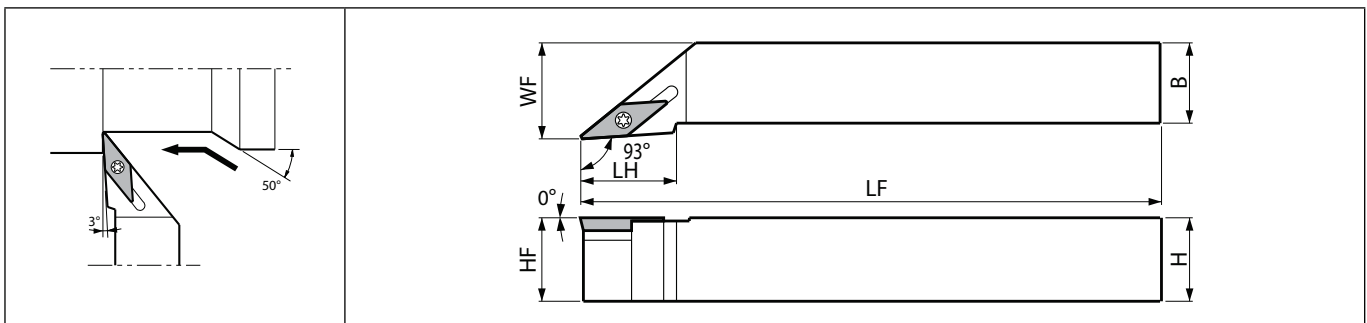

Right-hand shown

Toolholder dimensions

Description	Availability		Dimension (mm)							Standard corner-R(RE)	Spare parts						Applicable inserts
	R	L	H	B	LH	HF	LF	WF	Screw		Wrench	Wrench	Shim screw	Shim	Wrench		
	SVJB%L 2020K-11	●	●	20	20	30	20	125	25		0.4	SB-2570TR	-	FT-8	-	-	
2525M-11	●	●	25	25	35	25	150	32									
SVJB%L 2020K-16N	●	●	20	20	30	20	125	25	0.8	SB-4012STRN	FT-15	-	SS-4N	SVN-32N (SVN-32S*)	LW-4	VB□T1604..., VB□W1604... VC□T1604...	
2525M-16N	●	●	25	25	30	25	150	32									

When using inserts whose corner-R(RE) is 0.2 or 0.4mm, shim (SVN-32S) is recommended (sold separately).

● : Standard item R : Right-hand only L : Left-hand only □ : Check availability

E



Small tools

SVPB (External turning / External facing / External copying / Undercutting, Screw clamp)

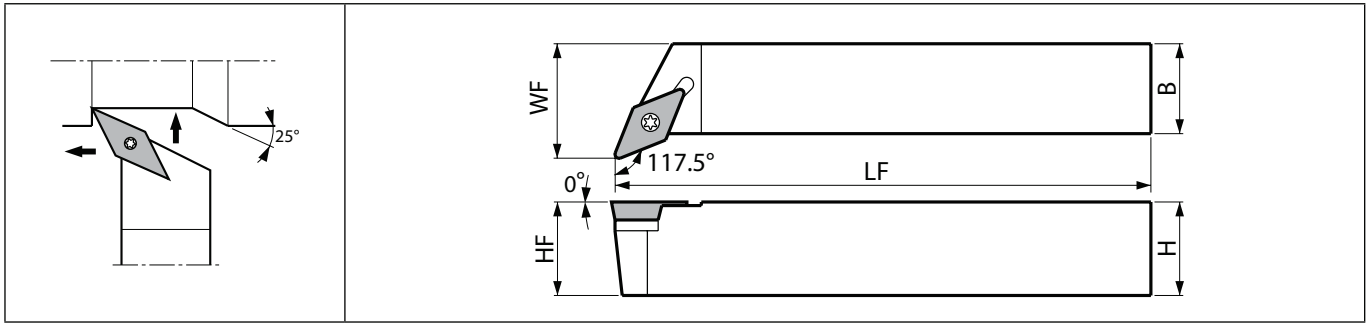

Right-hand shown

E



Small tools

Toolholder dimensions

Description	Availability		Dimension (mm)						Standard corner-R(RE)	Spare parts						Applicable inserts
										Screw	Wrench	Wrench	Shim screw	Shim	Wrench	
	R	L	H	B	HF	LF	WF									
SVPB% 1010JX-11 1212JX-11 1616JX-11 2020K-11 2525M-11	●	●	10	10	10		14.5	0.4		-	FT-8	-	-	-	-	VB□T1103... VB□W1103...
	●	●	12	12	12	120	16.5									
	●	●	16	16	16		20.5									
	●	●	20	20	20	125	25									
	●	●	25	25	25	150	32									
SVPB% 2020K-16N 2525M-16N	●	●	20	20	20	125	25	0.8		FT-15	-	SS-4N	SVN-32N (SVN-32S*)	LW-4	VB□T1604...; VB□W1604... VC□T1604...	
	●	●	25	25	25	150	32									

When using inserts whose corner-R(RE) is 0.2 or 0.4mm, shim (SVN-32S) is recommended (sold separately).

Undercutting diameter of SVPB

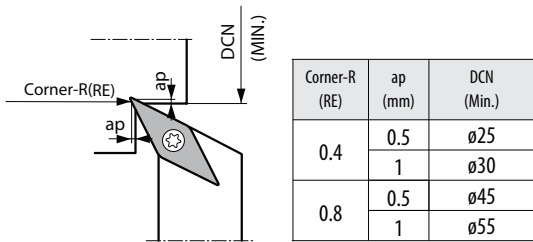

● : Standard item R : Right-hand only L : Left-hand only □ : Check availability

SVVB (External turning / External copying)

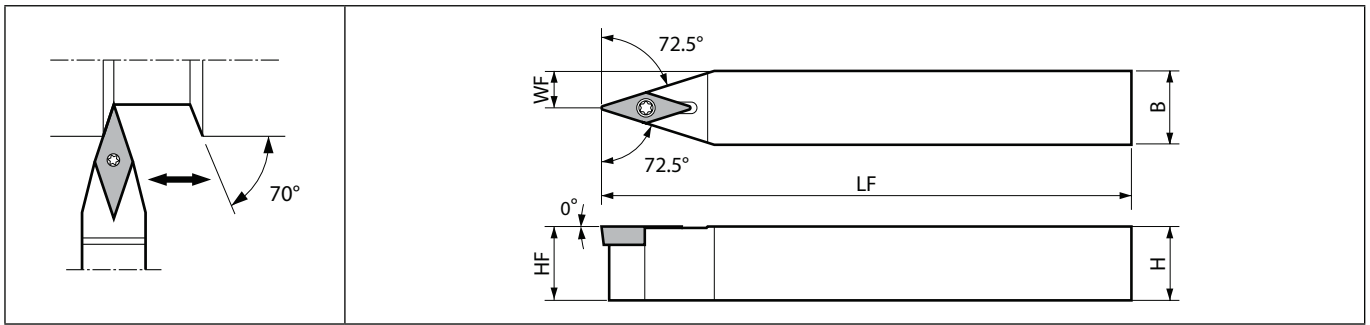

Toolholder dimensions

Description	Availability	Dimension (mm)						Standard corner-R(RE)	Spare parts						Applicable inserts
									Screw	Wrench	Wrench	Shim screw	Shim	Wrench	
		N	H	B	HF	LF	WF								
SVVBN 1010F-11 1010JX-11 1212F-11 1212JX-11 1616H-11 1616JX-11 2020K-11 2525M-11	●	10	10	10	80	5	0.4	SB-2570TR	-	FT-8	-	-	-	-	VB-T1103... VB-W1103...
	●				120										
	●	12	12	12	85	6									
	●				120										
	●	16	16	16	100	8									
	●				120										
	●	20	20	20	125	10									
	●	25	25	25	150	12.5									
SVVBN 2020K-16N 2525M-16N	●	20	20	20	125	10	0.8	SB-40125TRN	FT-15	-	SS-4N	SVN-32N (SVN-32S*)	LW-4	VB-T1604..., VB-W1604... VC-T1604...	
	●	25	25	25	150	12.5									

When using inserts whose corner-R(RE) is 0.2 or 0.4mm, shim (SVN-32S) is recommended (sold separately).

Applicable inserts (AVJB-FF / SVJB-FF / SVJB-FFJCTM / SVJB / SVPB / SVVB)

Applications	Finishing	Finishing	Finishing	Finishing - Medium	Finishing	Finishing	Finishing - Medium	Non-Ferrous Metals
Insert								
Chip Breaker Type	PP	GP	VF	HQ	F/L-F	F/L-FSF	F/L-Y	PCD
Page	B97	B97	B97	B97	B98	B98	B99	C49
Applications	Hard materials							
Insert								
Chip Breaker Type	CBN							
Page	C26							

Recommended cutting conditions E65, E66

● : Standard item R : Right-hand only L : Left-hand only □ : Check availability

SVJC-FF (External turning / External copying, Screw clamp, Without offset)

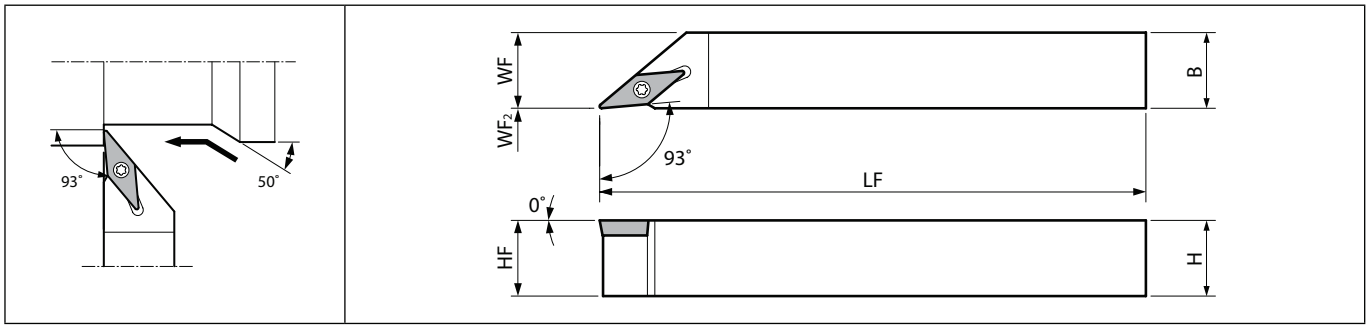

Right-hand shown

E

Toolholder dimensions

Description	Availability		Dimension (mm)							Standard corner-R(RE)	Spare parts		Applicable inserts
	R	L	H	B	HF	LF	WF	WF2	Screw		Wrench		
	SVJC%	●	●	10	10	10	120	10					
1212F-11FF	●	●	12	12	12	85	12	0	0.2	SB-2570TR	FT-8	VC□T1103...	
1212JX-11FF	●	●											
1616JX-11FF	●	●	16	16	16	120	16						
2020JX-11FF	●	●	20	20	20		20						

SVLC-FF (External turning / External copying, Screw clamp, Without offset)

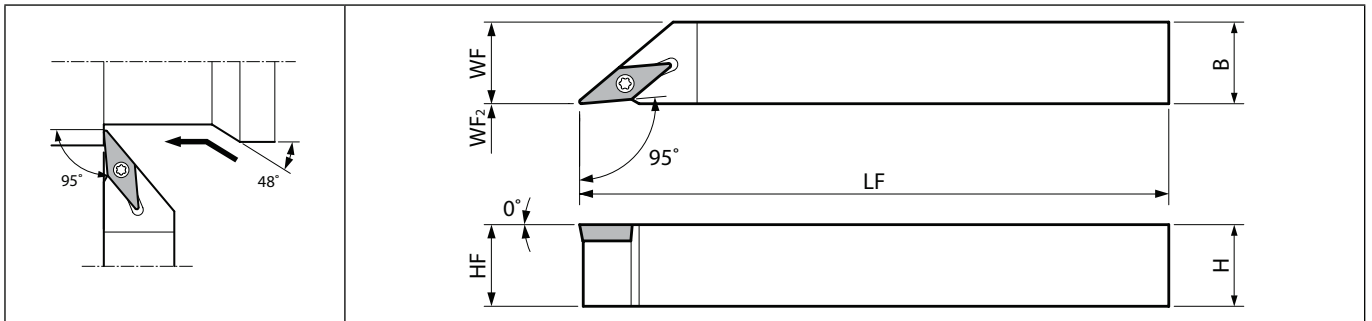

Right-hand shown

Toolholder dimensions

Description	Availability		Dimension (mm)							Standard corner-R(RE)	Spare parts		Applicable inserts
	R	L	H	B	HF	LF	WF	WF2	Screw		Wrench		
	SVLC%	●	●	12	12	12	85	12	0		0.2	SB-2570TR	
1212F-11FF	●	●											
1212JX-11FF	●	●	16	16	16	120	16						
1616JX-11FF	●	●											

● : Standard item R : Right-hand only L : Left-hand only □ : Check availability

Small tools

SVPC-FF (External turning / External facing / External copying / Undercutting, Screw clamp, Without offset)

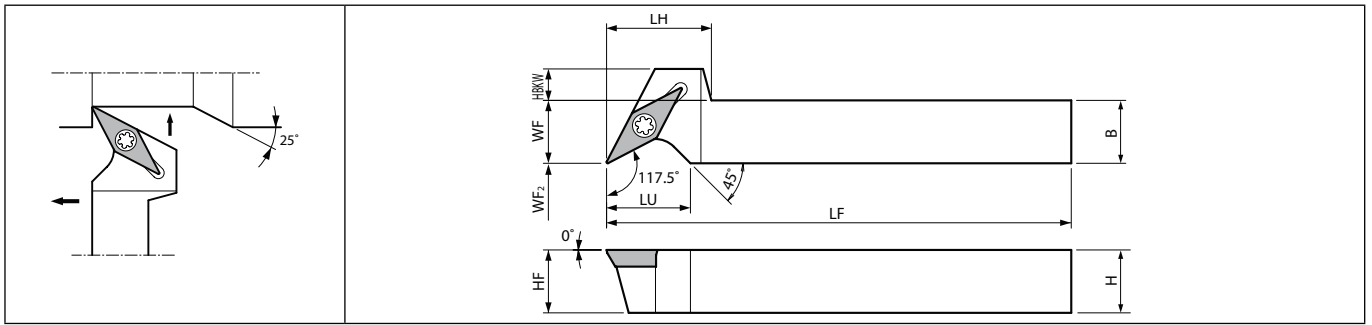

Right-hand shown

Toolholder dimensions

Description	Availability	Dimension (mm)										Spare parts		Applicable inserts	
		R	H	B	LH	HF	HBKW	LF	LU	WF	WF2	Standard corner-R(RE)	Screw		Wrench
		● 10 ● 12 ● 16	10 12 16	10 12 16	20 20 20	10 12 16	8 6 2	120 85 120	16 16 20	10 12 16	0 0 0	0.2 0.2 0.2	 SB-2570TR		 FT-8

E



Small tools

Undercutting diameter of SVPC-FF

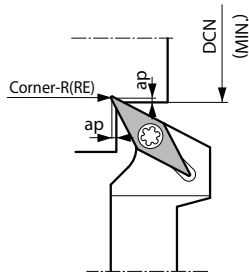

Corner-R (RE)	ap (mm)	DCN (Min.)
0.2	0.5	ø20
	0.7	ø25

● : Standard item R : Right-hand only L : Left-hand only □ : Check availability

SVVC (External turning / External copying)

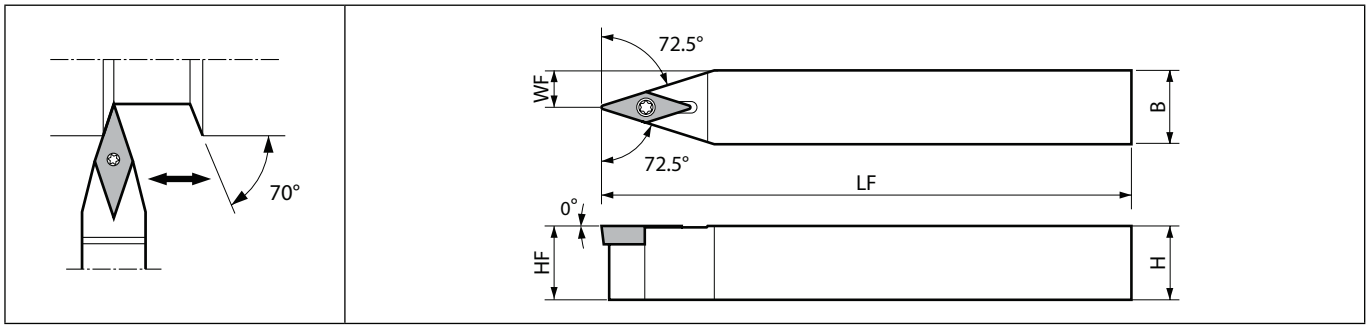



E



Small tools

Toolholder dimensions

Description	Availability	Dimension (mm)						Standard corner-R(RE)	Spare parts		Applicable inserts
		N	H	B	HF	LF	WF		Screw	Wrench	
											
SVVCN 1010JX-11	●	10	10	10			5	0.2	SB-2570TR	FT-8	VC□T1103...
1212JX-11	●	12	12	12	120	6					
1616JX-11	●	16	16	16		8					

Applicable inserts (SVJC-FF / SVLC-FF / SVPC-FF / SVVC)

Applications	Minute ap	Finishing	Finishing	Finishing	Finishing - Medium
Insert					
Chip Breaker Type	CF	GF	SKS	φ/L-F	φ/L-Y
Page	B100	B100	B100	B101	B101

Recommended cutting conditions  E65, E66

● : Standard item R : Right-hand only L : Left-hand only □ : Check availability

SVJP-FF (External turning / External copying, Screw clamp, Without offset)

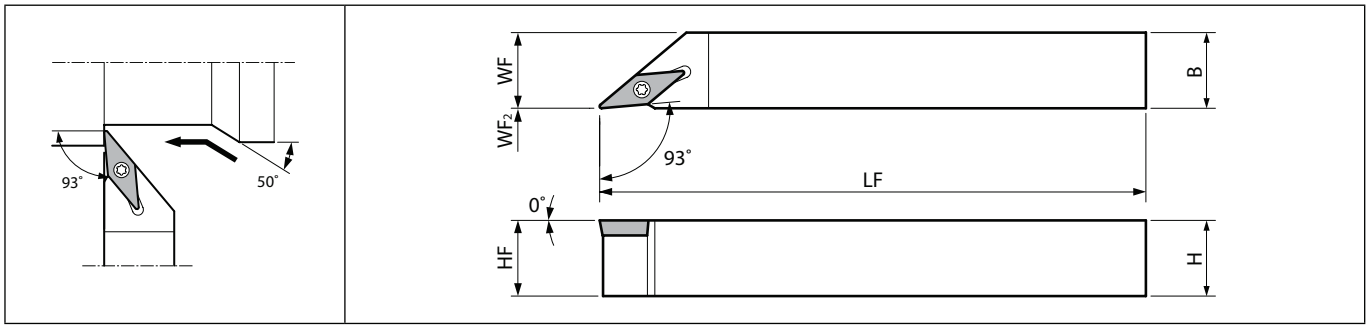

Right-hand shown

Toolholder dimensions

Description	Availability		Dimension (mm)							Standard corner-R(RE)	Spare parts		Applicable inserts
	R	L	H	B	HF	LF	WF	WF2	Screw		Wrench		
	SVJPP/L	●	●	12	12	12	85	12	0		0.2	SB-2570TR	
1212F-11FF	●	●	12	12	12	85	12	0	0.2	SB-2570TR	FT-8	VP□T1103...	
1212JX-11FF	●	●	16	16	16	120	16	0	0.2	SB-2570TR	FT-8	VP□T1103...	
1616JX-11FF	●	●	20	20	20	120	20	0	0.2	SB-2570TR	FT-8	VP□T1103...	
2020JX-11FF	●	●	20	20	20	120	20	0	0.2	SB-2570TR	FT-8	VP□T1103...	



Small tools

SVJP-FFJCTM (External turning / External copying, Screw clamp, Without offset, Coolant-through holder)

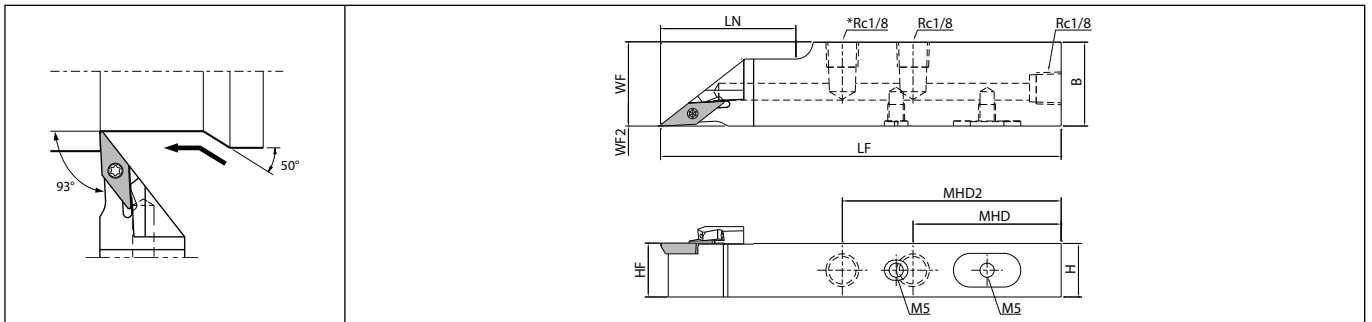

Right-hand shown | SVJPR12...: 2-Rc1/8

Toolholder dimensions

Description	Availability		Dimension (mm)									Standard corner-R(RE)	Coolant hole	Spare parts				Applicable inserts
	R	L	H	B	MHD	MHD2	HF	LF	LN	WF	WF2			Plug	Plug	Screw	Wrench	
	SVJPR	●	●	12	18	54	-	12	28	18	0			0.2	Yes	GP-1	H55X4LP	
1218JX-11FFJCTM	●	●	16	25	44	65	16	120	40	25	0	0.2	Yes	GP-1	H55X4LP	SB-2570TR	FT-8	VP□T1103...
1625JX-11FFJCTM	●	●	20	25	44	65	16	120	40	25	0	0.2	Yes	GP-1	H55X4LP	SB-2570TR	FT-8	VP□T1103...
2025JX-11FFJCTM	●	●	20	25	44	65	16	120	40	25	0	0.2	Yes	GP-1	H55X4LP	SB-2570TR	FT-8	VP□T1103...

Please see page H16 and H17 for piping parts of coolant-through holders.

● : Standard item R : Right-hand only L : Left-hand only □ : Check availability

SVLP-FF (External turning / External copying, Screw clamp, Without offset)

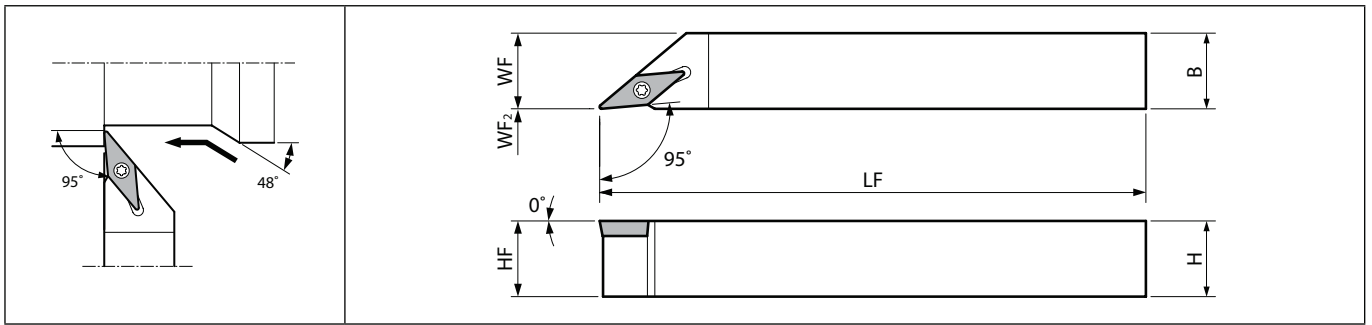



Right-hand shown

E



Small tools

Toolholder dimensions

Description	Availability		Dimension (mm)							Standard corner-R(RE)	Spare parts		Applicable inserts
											Screw	Wrench	
	R	L	H	B	HF	LF	WF	WF2					
SVLP ^{P/L} 1010JX-08FF 1212F-08FF 1212JX-08FF 1616JX-08FF	●	●	10	10	10	120	10	0	0.1	SB-2050TR	FT-6	VP□T0802...	
	●	●	12	12	12	85	12						
	●	●	12	12	12	120	12						
	●	●	16	16	16	16	16						
SVLP ^{P/L} 1212F-11FF 1212JX-11FF 1616JX-11FF	●	●	12	12	12	85	12	0	0.2	SB-2570TR	FT-8	VP□T1103...	
	●	●				120							
	●	●				16							16

●: Standard item R: Right-hand only L: Left-hand only □: Check availability

SVPP-FF (External turning / External facing / External copying / Undercutting, Screw clamp, Without offset)

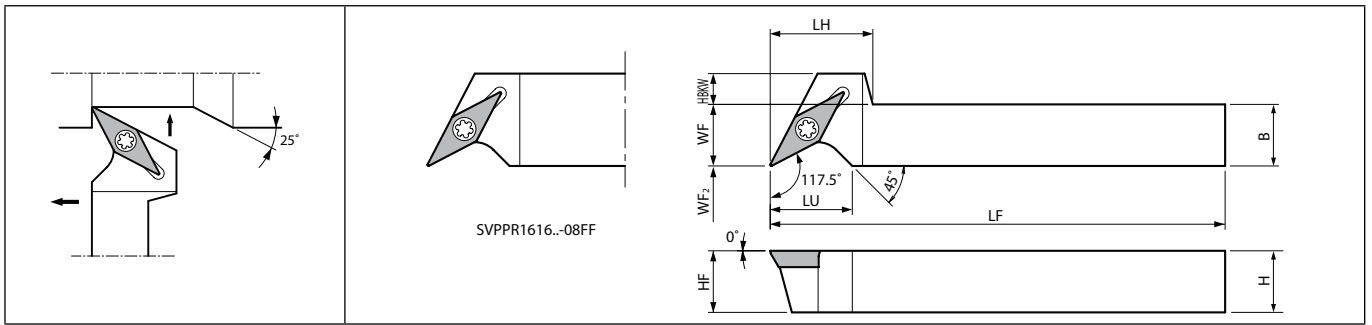

Right-hand shown

Toolholder dimensions

Description	Availability	Dimension (mm)										Standard corner-R(RE)	Spare parts		Applicable inserts
		R	H	B	LH	HF	HBKW	LF	LU	WF	WF2		Screw	Wrench	
SVPPR 1010JX-08FF 1212F-08FF 1212JX-08FF 1616JX-08FF	●	10	10		10	4	120		10			0.1	SB-2050TR	FT-6	VP□T0802...
	●	12	12	16	12	2	85	12	12	0					
	●	16	16	-	16	-	120		16						
	●	16	16	-	16	-	120		16						
SVPPR 1010JX-11FF 1212F-11FF 1212JX-11FF 1616JX-11FF	●	10	10		10	8	120		10			0.2	SB-2570TR	FT-8	VP□T1103...
	●	12	12	20	12	6	85	16	12	0					
	●	16	16		16	2	120		16						
	●	16	16		16	2	120		16						

Undercutting diameter of SVPP-FF

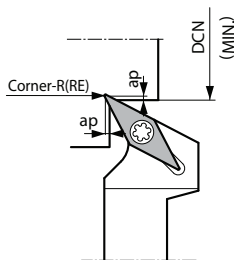

Corner-R (RE)	ap (mm)	DCN (Min.)
0.2	0.5	ø20
	1	ø25

Applicable inserts (SVJP-FF / SVJP-FFJCTM / SVLP-FF / SVPP-FF)

Applications	Minute ap	Finishing	Finishing	Finishing	Finishing	Finishing	Low feed	Low feed
Insert								
Chip Breaker Type	CF	SKS	CK	GF	¾-F	¾-FSF	¾-U	¾-USF
Page	B102	B102	B102	B102	B103	B103	B104	B104
Applications	Low feed							
Insert								
Chip Breaker Type	¾-J							
Page	B104							

Recommended cutting conditions E65, E66

● : Standard item R : Right-hand only L : Left-hand only □ : Check availability

E
Small tools

25° Insert Profiling Tools

ZBMT Series

Unique clamping structure and a wide lineup of external toolholders and boring bars. High precision and stable machining in a wide range of applications including copying, undercutting, tapering, V-slotting, spherical machining, and more.

1 Newly Developed Unique-Clamping Mechanism Achieves a Higher Rigidity

Side Lock Mechanism

Unique design holds insert at 2 points
Safe even for insert with small tip angle that is difficult to mount



Indentations for screw clamp are designed into the insert's body
Uses a large screw size (M4)

Insert Displacement During Facing Comparison (Internal evaluation)

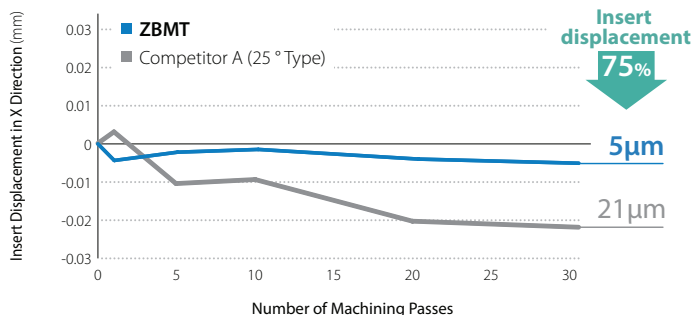

Cutting Conditions : Vc = 230 m/min, ap = 0.3 mm, f = 0.15 mm/rev, Wet Workpiece SCM435
*The above figures are not guaranteed. It depends on cutting conditions.

Check

- By controlling insert displacement,
- Machining precision is stabilized and long tool life is enable
 - Reduces defect rate due to sudden dimensional deviation

Provides High Quality and Stable Machining in Various Machining Applications

Excellent Performance in Various Machining Applications including Copying, Undercutting, Tapering, V-Slotting, Spherical Machining, etc.

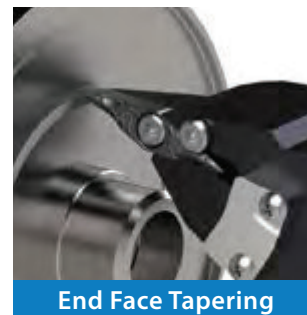

CG images

E

Small tools

2 Unique Holder Design to Meet Customers' Needs

Both boring bars and external toolholders are compatible with internal coolant.

Uses a clamp with a small thickness that does not prevent chip flow

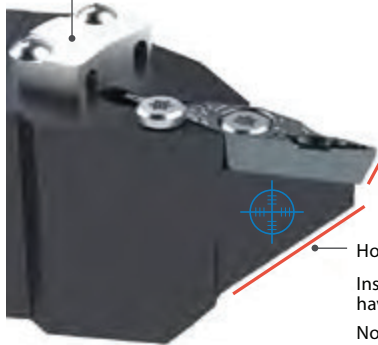

Unique Double Coolant Hole Design

Supplies coolant directly to the cutting edge and provides improved chip evacuation and long tool life (Coolant discharge direction: Fine adjustment possible)

*Though coolant stream hits side clamp screw, machining performance is not affected
*Pressure resistance: ~ 3 MPa

Fine Tuned and Adjustable
± 4° Adjustable Oscillation

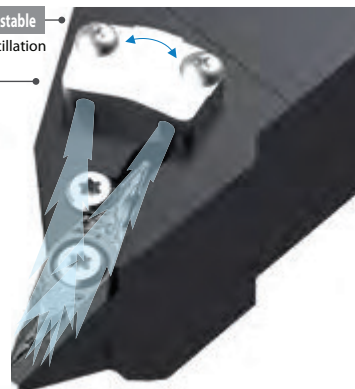

Easy to use for Facing

Insert corner :
2-Step Positive Type (20°)

Holder: Tapered shape
Inserts and toolholders
have a unique end shape

No additional machining is required when trying to avoid interference with workpiece.

Effective for facing applications



3 New GF Chipbreaker for ZBMT Reduces Chip Control Issues at minute D.O.C.

GF Chipbreaker

Solving chip control issues leads to high-quality surface finishes

The thin molded chipbreaker extends near the corner and reliably controls chips even in narrow spaces

Two-step dot

Responds to chip fluctuation

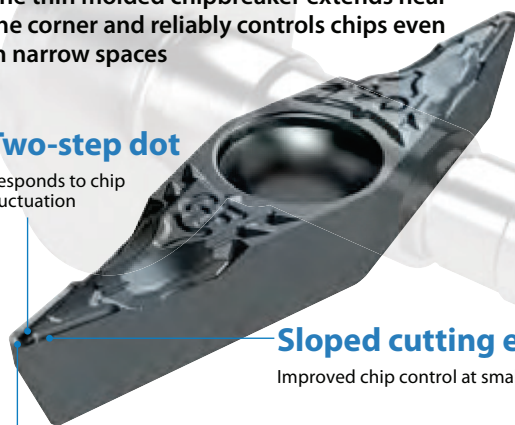

Sloped cutting edge

Improved chip control at small D.O.C.

Mortar-shaped chipbreaker

Low resistance and excellent chip control even in ductile workpieces

Chip control comparison
(Internal evaluation)



GF Chipbreaker



Competitor A (25° Type)

Cutting Conditions : Vc = 230 m/min, f = 0.15 mm/rev, ap = 0.2 - 0.5 mm, Wet Workpiece SCM435 Facing

15° Inserts are also available upon customer requests

To avoid holder interference, additional modifications is required as shown in the figure on the right. Also, as shown in the figure below, special order for holders may be required depending on machining application.

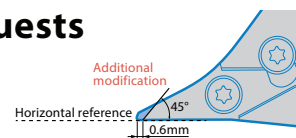

Examples

When using the toolholder in reverse mounting position



When using the toolholder in normal mounting position

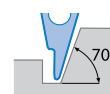

* Holder: Special order specification



15° inserts are developed relative to 25° inserts
Helps avoid interference and supports a wider range of machining application

Corner-R 0.4

Double-blade design for turning and back turning

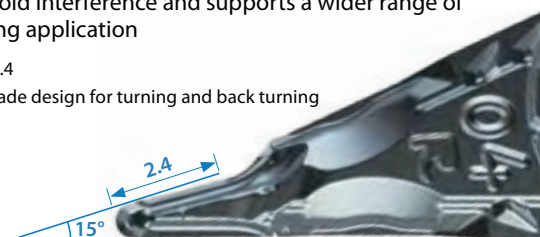

E



Small tools

SZLB (External turning / External copying, Screw clamp, Coolant-through holder)

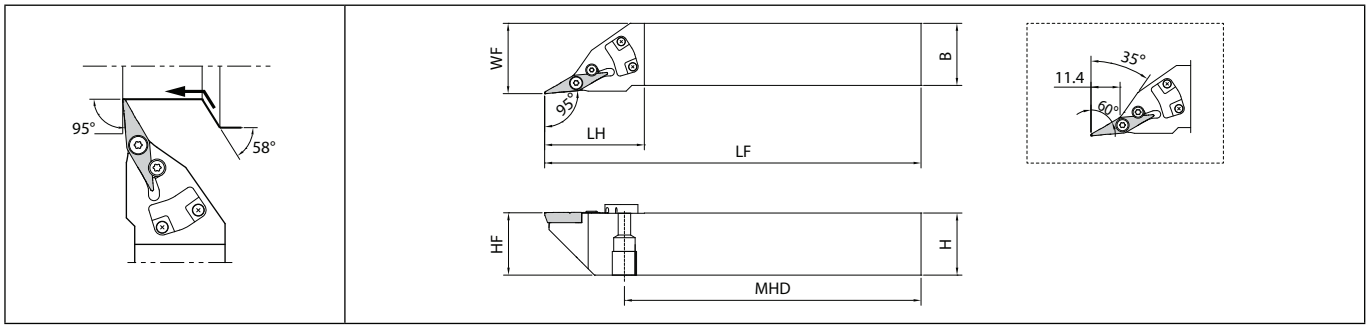

Right-hand shown | ZBMT13T304R-GF-15D is applicable to Right-hand Toolholder. | Applicable Pressure : ~3MPa

E

Toolholder dimensions

Description	Availability		Dimension (mm)							Standard corner-R(RE)	Coolant hole	Spare parts				Applicable inserts
	R	L	H	B	LH	MHD	HF	LF	WF			Clamper screw	Clamper	Screw	Wrench	
	SZLB% 2020K-13C 2525M-13C	●	●	20	20	40	92.6	20	125			23	0.4	Yes	BH2X6	

Please see page D12 for piping parts of coolant-through holders.

SZPB (External turning / External facing / External copying / Undercutting, Screw clamp, Coolant-through holder)

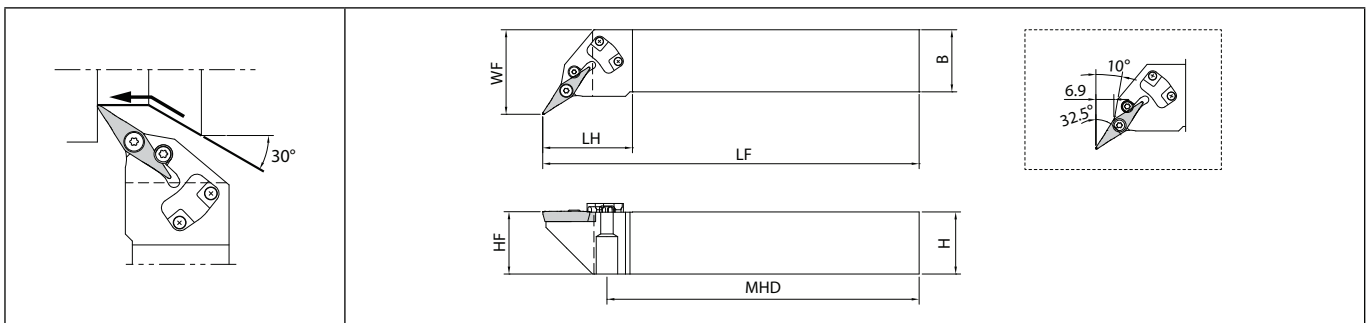

Right-hand shown | Applicable Pressure : ~3MPa

Toolholder dimensions

Description	Availability		Dimension (mm)							Standard corner-R(RE)	Coolant hole	Spare parts				Applicable inserts
	R	L	H	B	LH	MHD	HF	LF	WF			Clamper screw	Clamper	Screw	Wrench	
	SZPB% 2020K-13C 2525M-13C	●	●	20	20	37	95	20	125			27.2	0.4	Yes	BH2X6	

Please see page D12 for piping parts of coolant-through holders.

● : Standard item R : Right-hand only L : Left-hand only □ : Check availability

Small tools

SZVB (External turning / External copying, Screw clamp, Coolant-through holder)

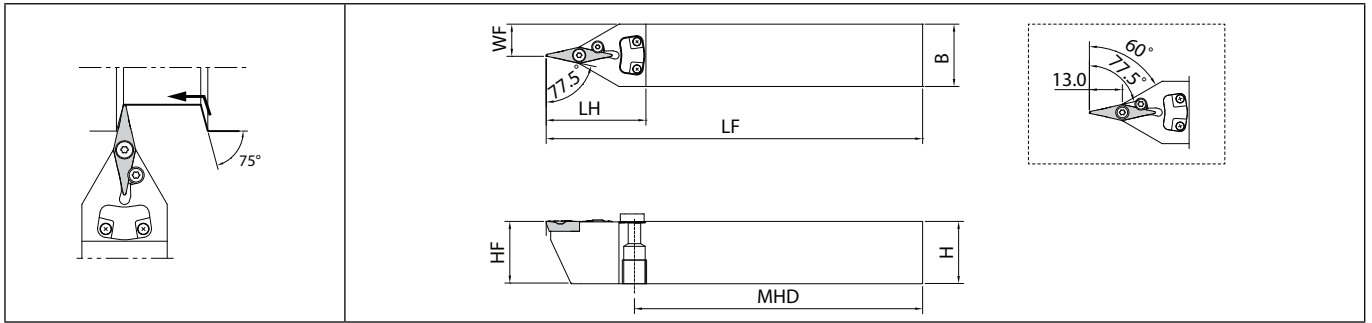

Applicable Pressure : ~3MPa

Toolholder dimensions

Description	Availability		Dimension (mm)							Standard corner-R(RE)	Coolant hole	Spare parts				Applicable inserts
	N	H	B	LH	MHD	HF	LF	WF	Clamper screw			Clamper	Screw	Wrench		
SZVBN 2020K-13C	●	20	20	40	89.6	20	125	10	0.4	Yes					ZBMT13T3...	
2525M-13C	●	25	25		114.6	25	150	12.5								

Please see page D12 for piping parts of coolant-through holders.

Applicable inserts

Applications	Finishing	Finishing
Insert		
Chip Breaker Type	GF	R-GF-15D
Page	B108	B108

R-GF-15D inserts are only for the right-hand toolholders of SZLB.

Recommended cutting conditions [E68](#)

Instructions

When mounting the insert (Tightening torque: 1.2 N · m)



1. Tighten the main screw with the insert pressed against the contact surface with fingertips.



2. Tighten the side screw to complete the installation.

When removing the insert

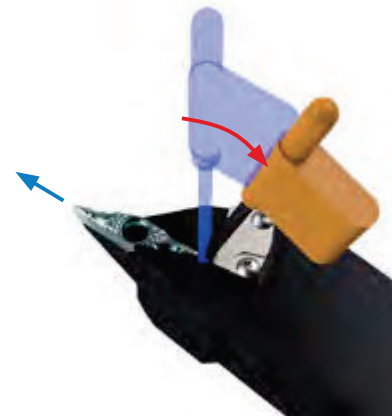

Remove the two screws and put the wrench into the gap at the back end of the insert. It can be easily removed by pushing out the insert as shown above.

● : Standard item R : Right-hand only L : Left-hand only □ : Check availability

S-SCLC (External turning / External facing)

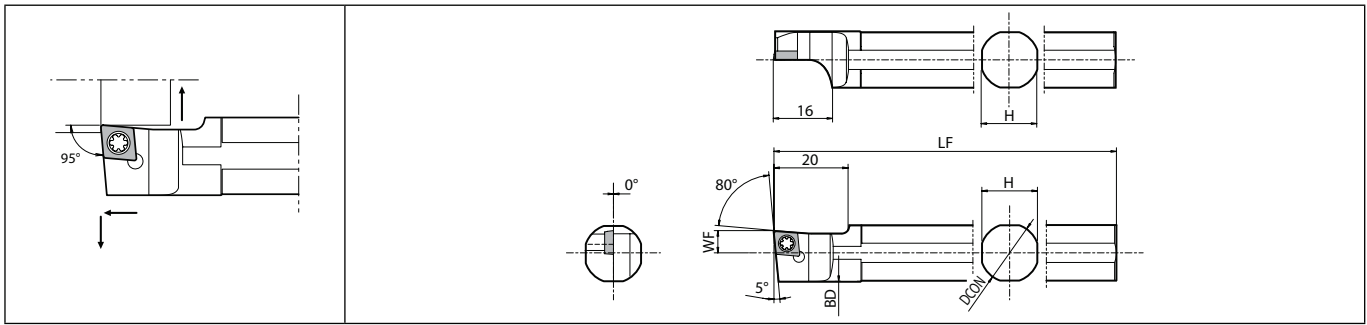

Left-hand shown | Right-hand Insert for Left-hand Toolholder.

E

Toolholder dimensions

Description	Availability	Dimension (mm)						Standard corner-R(RE)	Spare parts			Applicable inserts
		L	DCON	H	BD	LF	WF		Screw	Wrench	Wrench	
S12F- SCLCL06	●	12	11	13.4	80	6	0.4	SB-2560TR	-	FT-8	CC-T0602... CC-W0602...	
S14H- SCLCL06	●	14	13	100								
S15F- SCLCL06	●	15.875	15	15.4	85							
S16F- SCLCL06	●	16			90							
S19G- SCLCL06	●	19.05	17	18.4	120							
S19K- SCLCL06	●				120							
S20G- SCLCL06	●	20	18	19.4	90							
S20K- SCLCL06	●				120							
S19G- SCLCL09	●	19.05	17	18.4	90	10	0.4	SB-4065TR	FT-15	-	CC-T09T3... CC-W09T3...	
S19K- SCLCL09	●				120							
S20G- SCLCL09	●	20	18	19.4	90							
S20K- SCLCL09	●				120							
S25.0H- SCLCL09	●	25	23	24.4	100							
S25K- SCLCL09	●	25.4			120							

Small tools

Applicable inserts

Applications	Finishing	Finishing	Finishing	Finishing	Finishing	Finishing - Medium	Finishing	Finishing
Insert								
Chip Breaker Type	PF	GF	SKS	SK	CK	GQ	WP	PP
Page	B58	B58	B59	B59	B59	B59	B60	B60
Applications	Finishing - Medium	Finishing - Medium	Medium	Medium	Low feed	Low feed	Stainless steel / Heat-resistant alloys	Cast iron
Insert								
Chip Breaker Type	GK	HQ	STD	MF	P/L-U	P/L-J	MQ	No CB
Page	B60	B60	B60	B61	B63-B65	B65	B61	B66
Applications	Non-Ferrous Metals	Non-Ferrous Metals	Non-Ferrous Metals	Non-Ferrous Metals	Non-Ferrous Metals	Hard materials		
Insert								
Chip Breaker Type	AP	P/L-A3	AH	PCD	APD	CBN		
Page	B66	B66	B66	C39	C40	C20		

Recommended cutting conditions E65, E66

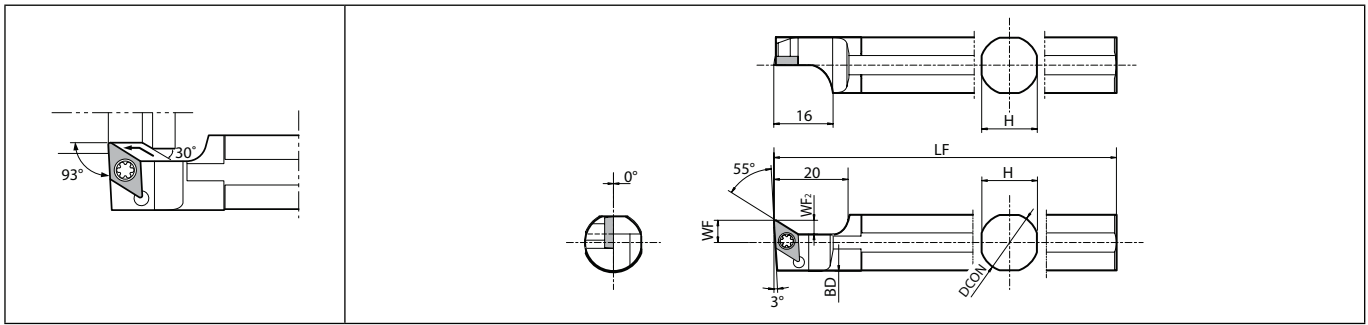

● : Standard item R : Right-hand only L : Left-hand only □ : Check availability

S-SDUC (External turning / External copying)



Left-hand shown | Right-hand Insert for Left-hand Toolholder.

Toolholder dimensions

Description	Availability	Dimension (mm)						Standard corner-R(RE)	Spare parts			Applicable inserts	
		L	DCON	H	BD	LF	WF		WF2	Screw	Wrench		Wrench
													
S14H- SDUCL07	●	14	13	13.4	100	6	3.8	0.4	SB-2560TR	-	FT-8	DC□T0702... DC□W0702... DC□X0702...	
S15F- SDUCL07	●	15.875	15	15.4	85								
S19G- SDUCL07	●	19.05	17	18.4	90								
S19K- SDUCL07	●			120									
S20G- SDUCL07	●	20	18	19.4	90								
S20K- SDUCL07	●			120									
S19G- SDUCL11	●	19.05	17	18.4	90	10	5.8	0.4	SB-4085TR	FT-15	-	DC□T11T3... DC□W11T3... DC□X11T3...	
S19K- SDUCL11	●			120									
S20G- SDUCL11	●	20	18	19.4	90								
S20K- SDUCL11	●			120									
S22K- SDUCL11	●	22	20	21.4	100								
S25.0H- SDUCL11	●	25	23	24.4	100								
S25K- SDUCL11	●	25.4		24.8	120								

For WP chipbreaker, cutting edge offsets or program corrections are required on R36 and R37.



Small tools

S-SDLC (External turning / External copying)

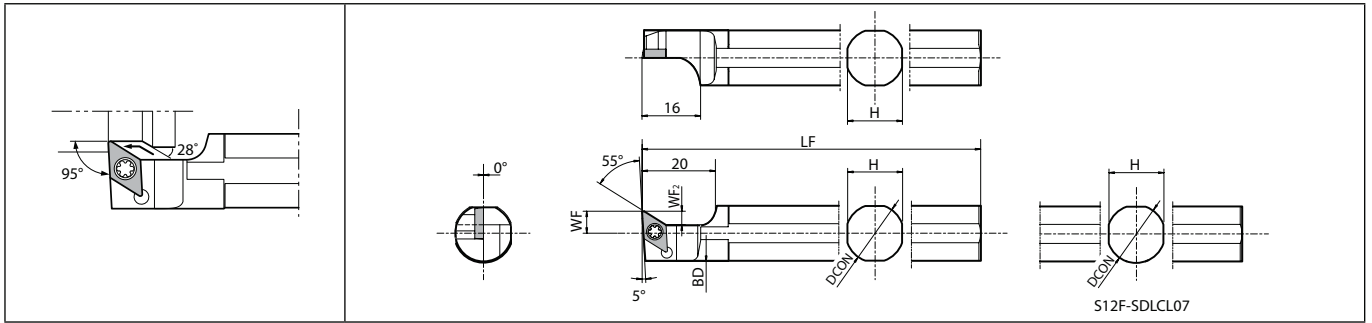



Left-hand shown | Right-hand Insert for Left-hand Toolholder.

E



Small tools

Toolholder dimensions

Description	Availability	Dimension (mm)							Standard corner-R(RE)	Spare parts			Applicable inserts
		L	DCON	H	BD	LF	WF	WF2		Screw	Wrench	Wrench	
													
S12F- SDLCL07	●	12	11	13.4	80	6	3.8	0.4	SB-2560TR	-	FT-8	DC□T0702... DC□W0702...	
S14H- SDLCL07	●	14	13	100									
S15F- SDLCL07	●	15.875	15	85									
S16F- SDLCL07	●	16											
S19G- SDLCL07	●	19.05	17	90									
S19K- SDLCL07	●		18.4	120									
S20G- SDLCL07	●	20	18	90									
S20K- SDLCL07	●		19.4	120									
S19G- SDLCL11	●	19.05	17	90	10	5.8	0.4	SB-4085TR	FT-15	-	DC□T11T3... DC□W11T3...		
S19K- SDLCL11	●		18.4	120									
S20G- SDLCL11	●	20	18	90									
S20K- SDLCL11	●		19.4	120									
S22K- SDLCL11	●	22	20	21.4									
S25.0H- SDLCL11	●	25	23	24.4									
S25K- SDLCL11	●	25.4	23	24.8									
				100									
				120									

● : Standard item R : Right-hand only L : Left-hand only □ : Check availability

Applicable inserts (S-SDUC / S-SDLC)

Applications	Minute ap	Finishing	Finishing	Finishing	Finishing	Finishing - Medium	Finishing	Finishing
Insert								
Chip Breaker Type	CF	GF	SKS	SK	CK	GQ	WP*	P/L-WP*
Page	B68	B68	B68	B68	B68	B69	B69	B69
Applications	Finishing	Finishing	Finishing - Medium	Finishing - Medium	Medium	Medium	Finishing	Finishing
Insert								
Chip Breaker Type	PP	GP	GK	HQ	STD	MF	P/L-F	P/L-FSF
Page	B69	B69	B70	B70	B70	B70	B72, B73	B72
Applications	Low feed	Low feed	Low feed	Low feed	Low carbon steel	Low carbon steel	Stainless steel / Heat-resistant alloys	Cast iron
Insert								
Chip Breaker Type	P/L-U	P/L-USF	P/L-J	P/L-JSF	XP	XQ	MQ	No CB
Page	B74~B76	B74	B77	B76	B71	B71	B71	B78
Applications	Non-Ferrous Metals	Non-Ferrous Metals	Non-Ferrous Metals	Non-Ferrous Metals	Non-Ferrous Metals	Hard materials		
Insert								
Chip Breaker Type	AP	P/L-A3	AH	PCD	APD	CBN		
Page	B78	B78	B78	C42	C42	C22		

For WP chipbreaker, cutting edge offsets or program corrections are required on R36 and R37. (S-SDLC cannot be used)

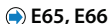
Recommended cutting conditions  E65, E66

E



Small tools

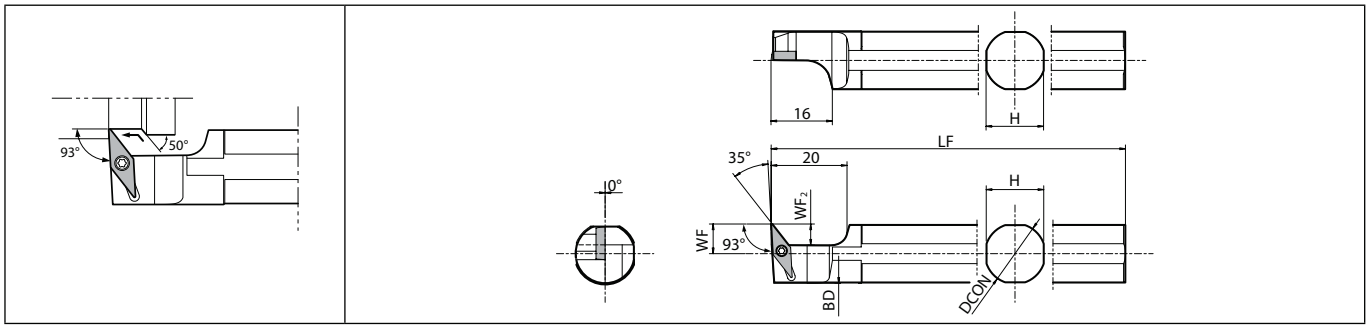

S-SVUB (External turning / External copying)



Left-hand shown | Right-hand Insert for Left-hand Toolholder.







E

Toolholder dimensions

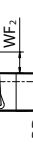
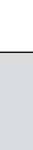
Description	Availability	Dimension (mm)						Standard corner-R(RE)	Coolant hole	Spare parts		Applicable inserts	
		L	DCON	H	BD	LF	WF			WF ₂	Screw		Wrench
													
S19G- SVUBL11	●	19.05	17	18.4	90	10.5	8	0.4	No	SB-2570TR	FT-8	VB-T1103... VB-W1103...	
S19K- SVUBL11	●												20
S20G- SVUBL11	●	25	23	24.4	100								
S20K- SVUBL11	●												25.4
S25.0H- SVUBL11	●	25.4	24.8	120									
S25K- SVUBL11	●												

Small tools

Applicable inserts

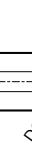
Applications	Finishing	Finishing	Finishing	Finishing - Medium	Finishing	Finishing	Finishing - Medium	Non-Ferrous Metals
Insert								
Chip Breaker Type	PP	GP	VF	HQ	⁹ /L-F	⁹ /L-FSF	⁹ /L-Y	PCD
Page	B97	B97	B97	B97	B98	B98	B99	C49
Applications	Hard materials							
Insert								
Chip Breaker Type	CBN							
Page	C26							

Recommended cutting conditions  E65, E66

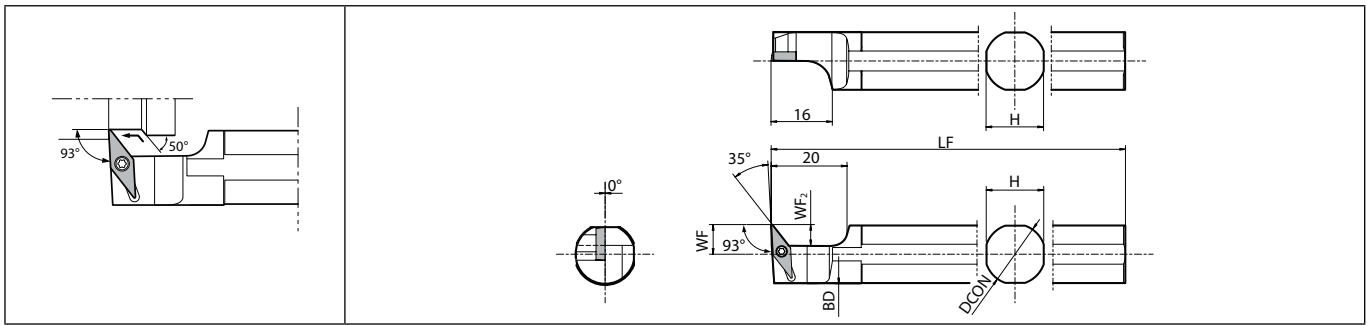

● : Standard item R : Right-hand only L : Left-hand only □ : Check availability

S-SVUC (External turning / External copying)



Left-hand shown | Right-hand Insert for Left-hand Toolholder.







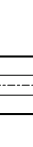
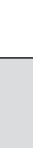

Toolholder dimensions

Description	Availability	Dimension (mm)							Standard corner-R(RE)	Coolant hole	Spare parts		Applicable inserts
		L	DCON	H	BD	LF	WF	WF2			Screw	Wrench	
													
S12F- SVUCL08	●	12	11	13.4	80	7.5	5.5	0.4	No	SB-2050TR	FT-6	VC□T0802... VC□W0802...	
S14H- SVUCL08	●	14	13	100									
S15F- SVUCL08	●	15.875	15	15.4	85	8							
S16F- SVUCL08	●	16											
S19G- SVUCL11	●	19.05	17	18.4	90	120	10.5	8	0.2	No	SB-2570TR	FT-8	VC□T1103...
S19K- SVUCL11	●												
S20G- SVUCL11	●	20	18	19.4	90	120							
S20K- SVUCL11	●												
S25.0H- SVUCL11	●	25	23	24.4	100	120							
S25K- SVUCL11	●	25.4					24.8						

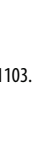
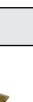

Small tools

Applicable inserts

Applications	Minute ap	Finishing	Finishing	Finishing	Finishing	Finishing - Medium	Finishing	Finishing - Medium
Insert								
Chip Breaker Type	CF	GF	SKS	PP	VF	HQ	¾-L-F	¾-L-Y
Page	B100	B100	B100	B100	B100	B100	B101	B101
Applications	Non-Ferrous Metals	Hard materials						
Insert								
Chip Breaker Type	PCD	CBN						
Page	C50	C27						

Recommended cutting conditions  E65, E66

● : Standard item R : Right-hand only L : Left-hand only □ : Check availability

SCLN-FF (External turning / External facing, Screw clamp, Without offset)

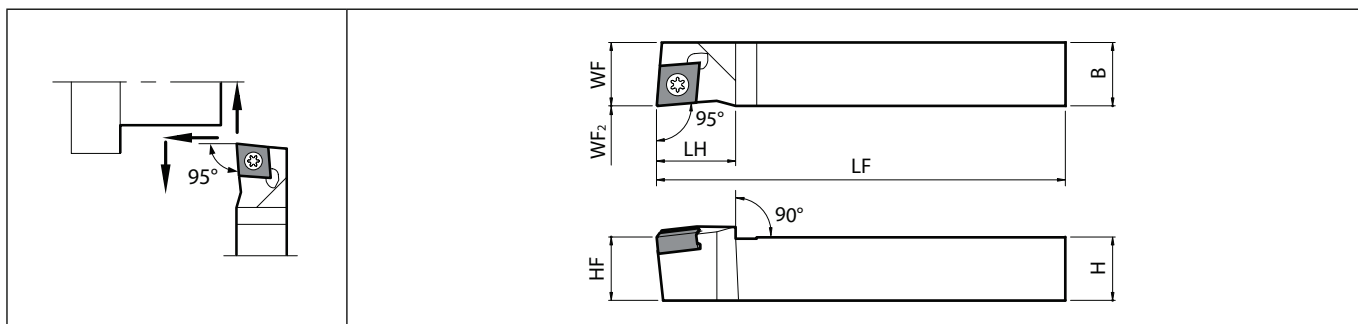

Right-hand shown

E

Toolholder dimensions

Description	Availability		Dimension (mm)							Standard corner-R(RE)	Side rake angle (°)	Inclination angle (°)	Spare parts		Applicable inserts
	R	H	B	LH	HF	LF	WF	WF2	Screw				Wrench		
	SCLNR 1010K-07FF	●	10	10		10	120	10							
1212F-07FF	●	12	12	15	12	85	12	0	0.2	-6	-6	SB-3080TR	LTW-10SS		
1212K-07FF	●														
1616K-07FF	●	16	16		16	120	16								

Applicable inserts

Applications	Finishing - Medium	Medium - Roughing	Finishing	Low feed
Insert				
Chip Breaker Type	SK	GK	R-F	R-U
Page	B55	B55	B55	B55

Recommended cutting conditions E62

● : Standard item R : Right-hand only L : Left-hand only □ : Check availability

Small tools

SDLN-FF (External turning / External copying, Screw clamp, Without offset)

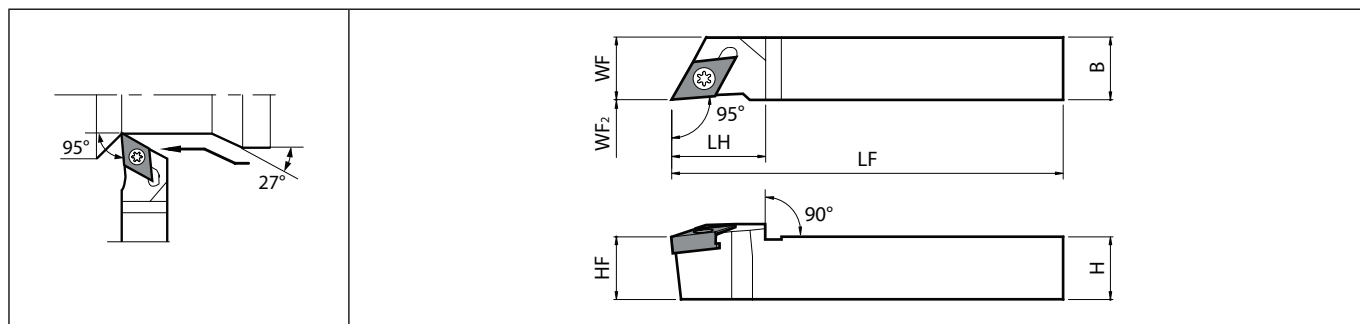

Right-hand shown

Toolholder dimensions

Description	Availability	Dimension (mm)								Standard corner-R(RE)	Side rake angle (°)	Inclination angle (°)	Spare parts		Applicable inserts
		R	H	B	LH	HF	LF	WF	WF2				Screw	Wrench	
		● 10 10 ● 12 12 18 ● 12 12 12 85 ● 16 16 16 120 ● 16 16 16 16	0	0.2	-6	-7	SB-3080TR	LTW-10SS	DN□U0803...						

Applicable inserts

Applications	Finishing - Medium	Medium - Roughing	Finishing	Low feed
Insert				
Chip Breaker Type	SK	GK	R-F	R-U
Page	B56	B56	B56	B56

Recommended cutting conditions E62

STLN-FF (External turning, Screw clamp, Without offset)

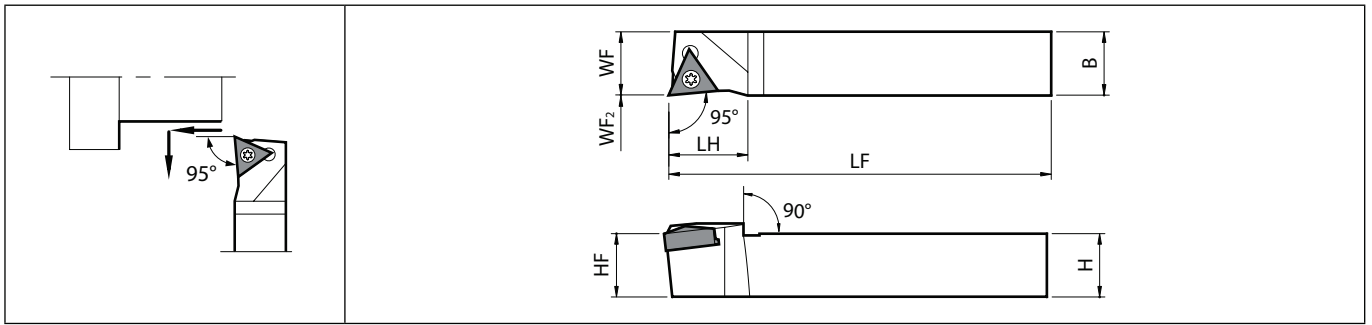

Right-hand shown

E

Toolholder dimensions

Description	Availability		Dimension (mm)							Standard corner-R(RE)	Side rake angle (°)	Inclination angle (°)	Spare parts		Applicable inserts
	R	H	B	LH	HF	LF	WF	WF2	Screw				Wrench		
	STLNR 1010K-09FF	●	10	10		10	120	10							
1212F-09FF	●	12	12	15	12	85	12	0	0.2	-6	-7	SB-2570TR	LTW-8SS		
1212K-09FF	●														
1616K-09FF	●	16	16		16	120	16								

Applicable inserts

Applications	Finishing	Low feed
Insert		
Chip Breaker Type	R-F	R-U
Page	B57	B57

Recommended cutting conditions

Workpiece material	PR1225	PR1535	PR1705	PR1725
Free-cutting steel	-	-	● Vc = 100 m/min 60 ~ 150	☺ Vc = 100 m/min 60 ~ 150
Carbon steel / Alloy steel	☺ Vc = 100 m/min 60 ~ 150	☺ Vc = 100 m/min 60 ~ 150	☺ Vc = 130 m/min 60 ~ 220	● Vc = 130 m/min 60 ~ 200
Stainless steel	☺ Vc = 80 m/min 50 ~ 150	● Vc = 100 m/min 60 ~ 180	-	☺ Vc = 100 m/min 80 ~ 150

● : Continuous to light interruption: 1st recommendation
 ☺ : Continuous to light interruption: 2nd recommendation

● : Standard item R : Right-hand only L : Left-hand only ☐ : Check availability

Small tools

PCLN-FF (External turning / External facing, Without offset)

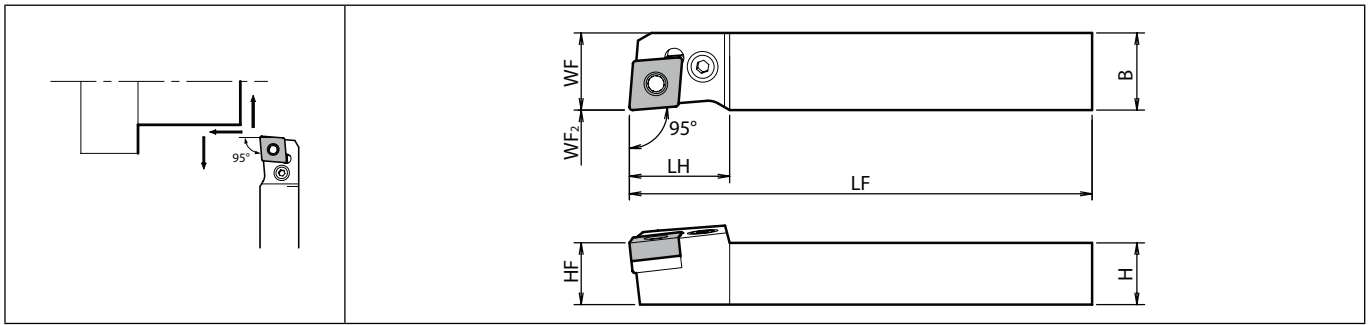

Right-hand shown

Toolholder dimensions

Description	Availability		Dimension (mm)							Standard corner-R(RE)	Side rake angle (°)	Inclination angle (°)	Spare parts						Applicable inserts
	R	H	B	LH	HF	LF	WF	WF2	Lever				Lock screw	Punch	Shim pin	Shim	Wrench		
	PCLNR 1620JX-12FF 2020JX-12FF	● 16 ● 20	16 20	20	26	16 20	120	20	0				0.8	-6	-6	LL-2N	LS-2N	PC-2	

Applicable inserts

Applications	Finishing - Medium	Medium - Roughing
Insert		
Chip Breaker Type	SK	FP-TK
Page	B19	B19

Recommended cutting conditions E62

PTLN-FF (External turning, Without offset)

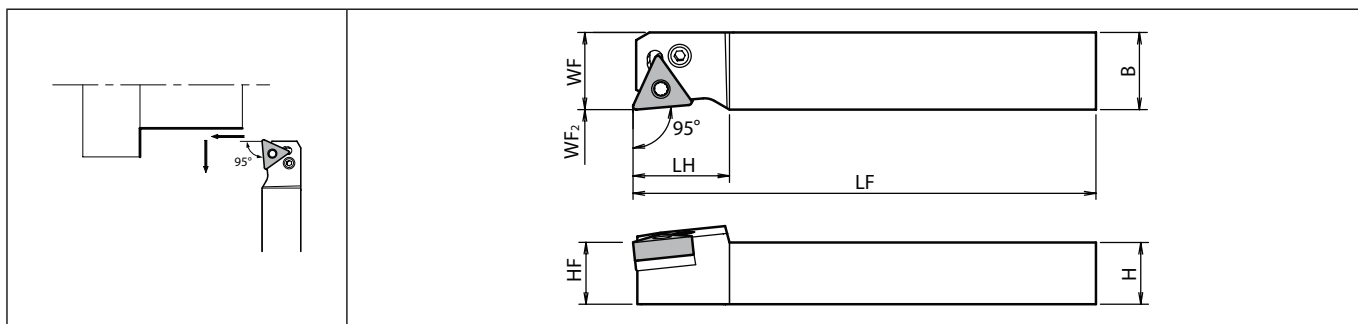

Right-hand shown

Toolholder dimensions

Description	Availability		Dimension (mm)							Standard corner-R(RE)	Side rake angle (°)	Inclination angle (°)	Spare parts						Applicable inserts
	R	H	B	LH	HF	LF	WF	WF2	Lever				Lock screw	Punch	Shim pin	Shim	Wrench		
	PTLNR 1620JX-16FF 2020JX-16FF	● 16 ● 20	16 20	20 24	16 20	120	20	0	0.8				-6	-6	LL-1N	LS-1N	PC-1	LSP-1	

When using inserts whose corner-R(RE) is greater than 1.6 mm, please purchase a shim* and use it in order to prevent workpiece and shim from interfering each other.

Applicable inserts

Applications	Finishing - Medium	Medium - Roughing	Large ap
Insert			
Chip Breaker Type	SK	FP-TK	R-LD
Page	B42	B42	B42

Recommended cutting conditions E62

● : Standard item R : Right-hand only L : Left-hand only □ : Check availability

External turning (positive insert) - cutting diameter under $\varnothing 16\text{mm}$

ISO classification	Workpiece material	Hardness	Cutting range	Applications	Chipbreaker	Insert grade	Corner-R (RE)	Lower limit - Recommendation - Upper limit		
								Vc (m/min)	ap (mm)	f (mm/rev)
P *	Low carbon steel Low carbon alloy	HB \leq 300	Precision finishing	Continuous	F	PR1725	0.05	100 - 150 - 200	0.05 - 0.07 - 0.15	0.03 - 0.05 - 0.1
				Interruption		PR1725	0.2	80 - 120 - 160	0.05 - 0.1 - 0.2	0.03 - 0.1 - 0.15
			Precision finishing Molded chipbreaker	Continuous	CF	PR1725	0.2	100 - 150 - 200	0.02 - 0.05 - 0.1	0.02 - 0.05 - 0.12
				Interruption						
			Finishing	Continuous	SKS	PR1725	0.2	100 - 140 - 180	0.2 - 0.5 - 1.0	0.05 - 0.1 - 0.2
	Interruption			PR1725	0.4	80 - 120 - 160	0.2 - 0.5 - 1.0	0.05 - 0.1 - 0.2		
	Medium carbon steel Medium carbon alloy	HB \leq 330	Precision finishing	Continuous	F	PR1725	0.05	100 - 150 - 200	0.05 - 0.07 - 0.15	0.03 - 0.05 - 0.1
				Interruption		PR1725	0.2	80 - 120 - 160	0.05 - 0.1 - 0.2	0.03 - 0.1 - 0.15
			Precision finishing Molded chipbreaker	Continuous	CF	PR1725	0.2	100 - 150 - 200	0.02 - 0.05 - 0.1	0.02 - 0.05 - 0.12
				Interruption						
			Finishing	Continuous	SKS	PR1725	0.2	100 - 140 - 180	0.2 - 0.5 - 1.0	0.05 - 0.1 - 0.2
	Interruption			PR1725	0.4	80 - 120 - 160	0.2 - 0.5 - 1.0	0.05 - 0.1 - 0.2		
	High carbon alloy	HB \leq 280	Precision finishing	Continuous	F	PR1725	0.05	100 - 150 - 200	0.05 - 0.07 - 0.15	0.03 - 0.05 - 0.1
				Interruption		PR1725	0.2	80 - 120 - 160	0.05 - 0.1 - 0.2	0.03 - 0.1 - 0.15
			Precision finishing Molded chipbreaker	Continuous	CF	PR1725	0.2	100 - 150 - 200	0.02 - 0.05 - 0.1	0.02 - 0.05 - 0.12
Interruption										
Finishing			Continuous	SKS	PR1725	0.2	100 - 140 - 180	0.2 - 0.5 - 1.0	0.05 - 0.1 - 0.2	
	Interruption		PR1725	0.4	80 - 120 - 160	0.2 - 0.5 - 1.0	0.05 - 0.1 - 0.2			
M	Stainless steel (Austenitic related)	HB \leq 220	Finishing	Continuous	SKS	PR1725	0.2	80 - 100 - 120	0.1 - 0.3 - 0.5	0.03 - 0.05 - 0.1
				Interruption		PR1535	0.4	60 - 80 - 100	0.3 - 0.5 - 1.0	0.05 - 0.1 - 0.15
	Medium	Continuous	SK	PR1725	0.2	80 - 100 - 120	0.5 - 1.5 - 3.0	0.03 - 0.08 - 0.12		
		Interruption		PR1535	0.4	60 - 80 - 100	0.5 - 1.0 - 2.0	0.05 - 0.1 - 0.15		
		Interruption								
Stainless steel (Precipitation Hardening)	HB \leq 300	Finishing	Continuous	SKS	PR1725	0.2	40 - 60 - 80	0.1 - 0.3 - 0.5	0.03 - 0.05 - 0.1	
			Interruption		PR1535	0.4	30 - 50 - 70	0.3 - 0.5 - 1.0	0.05 - 0.1 - 0.15	
Medium	Continuous	SK	PR1725	0.2	40 - 60 - 80	0.5 - 1.0 - 2.0	0.03 - 0.08 - 0.12			
	Interruption		PR1535	0.4	30 - 50 - 70	0.5 - 1.0 - 1.5	0.05 - 0.1 - 0.15			

* For machining free-cutting steels, such as SUM, etc. use PR1705 at Vc = 200 m/min or less.
For ap and f, refer to specs for low carbon steels.

External turning (positive insert) - cutting diameter under $\phi 16\text{mm}$

ISO classification	Workpiece material	Hardness	Cutting range	Applications	Chipbreaker	Insert grade	Corner-R (RE)	Lower limit - Recommendation - Upper limit		
								Vc (m/min)	ap (mm)	f (mm/rev)
K	Gray cast iron	$\text{HB} \leq 250$	Finishing	Continuous	Standard	CA310	0.4	100 - 120 - 150	0.2 - 0.5 - 1.0	0.1 - 0.15 - 0.2
				Interruption		CA315	0.4	80 - 100 - 120	0.2 - 0.5 - 1.0	0.05 - 0.1 - 0.15
		Medium	Continuous	Standard	CA310	0.4	100 - 120 - 150	0.5 - 1.0 - 2.0	0.1 - 0.15 - 0.2	
			Interruption		CA315	0.8	80 - 100 - 120	0.5 - 1.0 - 2.0	0.05 - 0.1 - 0.15	
	Nodular cast iron	$\text{HB} \leq 270$	Finishing	Continuous	Standard	CA310	0.4	80 - 100 - 120	0.2 - 0.5 - 1.0	0.1 - 0.15 - 0.2
				Interruption		CA315	0.4	60 - 80 - 100	0.2 - 0.5 - 1.0	0.05 - 0.1 - 0.15
Medium	Continuous	Standard	CA310	0.4	80 - 100 - 120	0.5 - 1.0 - 2.0	0.1 - 0.15 - 0.2			
	Interruption		CA315	0.8	60 - 80 - 100	0.5 - 1.0 - 2.0	0.05 - 0.1 - 0.15			
N	Non-ferrous metals Copper alloy Aluminum Aluminum alloys (Si10% or less) etc.	$\text{HB} \leq 100$	High speed machining (Rainbow surface gloss)	Continuous	Without chipbreaker	KPD001	0.2	150 - 250 - 350	0.05 - 0.1 - 0.3	0.05 - 0.1 - 0.15
				Interruption						
			Finishing (Long tool life)	Continuous	F	PDL025	0.2	100 - 150 - 200	0.05 - 0.3 - 0.5	0.02 - 0.07 - 0.1
				Interruption		PDL025	0.4	100 - 150 - 200	0.05 - 0.3 - 0.5	0.02 - 0.07 - 0.1
			Finishing	Continuous	F	KW10	0.2	100 - 150 - 200	0.05 - 0.3 - 0.5	0.02 - 0.07 - 0.1
				Interruption		KW10	0.4	100 - 150 - 200	0.05 - 0.3 - 0.5	0.02 - 0.07 - 0.1
Medium	Continuous	U	KW10	0.2	100 - 150 - 200	0.2 - 0.5 - 1.5	0.03 - 0.1 - 0.2			
	Interruption		KW10	0.4	100 - 150 - 200	0.2 - 0.5 - 1.5	0.03 - 0.1 - 0.2			
S	Titanium alloys	$\text{HB} \leq 400$	Precision finishing (Rainbow surface gloss)	Continuous	Without chipbreaker	KPD001	0.2	100 - 120 - 150	0.05 - 0.1 - 0.3	0.03 - 0.07 - 0.1
				Interruption		KPD001	0.4	70 - 100 - 120	0.05 - 0.1 - 0.3	0.03 - 0.07 - 0.1
			Medium	Continuous	F, U	KW10	0.4	30 - 50 - 70	0.1 - 0.5 - 1.0	0.03 - 0.1 - 0.2
	Heat-resistant alloys	$\text{HB} \leq 350$	Finishing	Continuous	F, U without chipbreaker	KW10	0.4	10 - 30 - 50	0.1 - 0.3 - 0.5	0.03 - 0.05 - 0.1
				Interruption		KW10	0.8	10 - 30 - 50	0.2 - 0.5 - 0.7	0.03 - 0.05 - 0.1
			Finishing	Continuous	MQ	PR1535	0.4	40 - 60 - 80	0.1 - 0.3 - 0.5	0.03 - 0.05 - 0.1
Interruption			PR1535	0.8	40 - 60 - 80	0.1 - 0.3 - 0.5	0.03 - 0.05 - 0.1			
	Hardened steel Hard materials	40 ~ 50 HRC	Finishing	Continuous	GK	PR1725	0.2	40 - 60 - 80	0.1 - 0.3 - 0.5	0.02 - 0.07 - 0.1
Interruption					PR1725	0.4	40 - 60 - 80	0.1 - 0.3 - 0.5	0.02 - 0.07 - 0.1	
Interruption	50 ~ 68 HRC	Finishing	Continuous	ME	KBN05M	0.2	80 - 120 - 150	0.1 - 0.3 - 0.5	0.02 - 0.07 - 0.1	
			Interruption	MET	KBN05M	0.4	60 - 100 - 120	0.1 - 0.3 - 0.5	0.02 - 0.07 - 0.1	

E

Small tools

Back Turning - cutting diameter under $\phi 16\text{mm}$

KTKF

Workpiece material		MEGACOAT NANO PLUS		MEGACOAT NANO		MEGACOAT		Remarks
		PR1725		PR1535		PR1225		
		Grooving	Turning	Grooving	Turning	Grooving	Turning	
Carbon steel / Alloy steel	Vc (m/min)	★ 60 ~ 200		☆ 60 ~ 150		☆ 60 ~ 150		Coolant
	f (mm/rev)	0.01 ~ 0.03	0.02 ~ 0.15	0.01 ~ 0.03	0.02 ~ 0.15	0.01 ~ 0.03	0.02 ~ 0.15	
Stainless steel	Vc (m/min)	☆ 60 ~ 150		★ 60 ~ 130		☆ 60 ~ 130		
	f (mm/rev)	0.01 ~ 0.02	0.02 ~ 0.1	0.01 ~ 0.02	0.02 ~ 0.1	0.01 ~ 0.02	0.02 ~ 0.1	

Workpiece material		Carbide		PCD		Remarks
		KW10		KPD001		
		Grooving	Turning	Grooving	Turning	
Cast iron	Vc (m/min)	50 ~ 100		-		Coolant
	f (mm/rev)	0.01 ~ 0.02	0.02 ~ 0.15	-		
Aluminum	Vc (m/min)	200 ~ 450		200 ~ 500		
	f (mm/rev)	0.01 ~ 0.03	0.02 ~ 0.15	0.01 ~ 0.03	0.02 ~ 0.12	
Brass	Vc (m/min)	100 ~ 200		100 ~ 350		
	f (mm/rev)	0.01 ~ 0.05	0.02 ~ 0.2	0.01 ~ 0.05	0.02 ~ 0.15	

GTP

Workpiece Material		MEGACOAT NANO PLUS		MEGACOAT NANO		Remarks
		PR1725		PR1535		
		Grooving	Turning	Grooving	Turning	
Carbon Steel / Alloy Steel	Vc (m/min)	★ 60 ~ 200		☆ 60 ~ 150		Coolant
	f (mm/rev)	0.03 ~ 0.07	0.05 ~ 0.15	0.03 ~ 0.07	0.05 ~ 0.15	
Stainless Steel	Vc (m/min)	☆ 60 ~ 150		★ 60 ~ 130		
	f (mm/rev)	0.02 ~ 0.05	0.03 ~ 0.10	0.02 ~ 0.05	0.03 ~ 0.10	

KTKF (GQ chipbreaker)

Workpiece material		MEGACOAT NANO PLUS		MEGACOAT NANO		MEGACOAT		Remarks
		PR1725		PR1535		PR1225		
		Grooving	Turning	Grooving	Turning	Grooving	Turning	
Carbon steel / Alloy steel	Vc (m/min)	★ 60 ~ 200		☆ 60 ~ 150		☆ 60 ~ 150		Coolant
	f (mm/rev)	0.01 ~ 0.04	0.02 ~ 0.15	0.01 ~ 0.04	0.02 ~ 0.15	0.01 ~ 0.04	0.02 ~ 0.15	
Stainless steel	Vc (m/min)	☆ 60 ~ 150		★ 60 ~ 130		☆ 60 ~ 130		
	f (mm/rev)	0.01 ~ 0.03	0.02 ~ 0.1	0.01 ~ 0.03	0.02 ~ 0.1	0.01 ~ 0.03	0.02 ~ 0.1	

AGT

Workpiece		PCD		Remarks
		KPD001		
		Grooving	Turning	
Aluminum alloy	Vc (m/min)	200 ~ 500		Coolant
	f (mm/rev)	0.03 ~ 0.15	0.03 ~ 0.20	
Brass	Vc (m/min)	100 ~ 350		
	f (mm/rev)	0.03 ~ 0.15	0.03 ~ 0.20	

ABS15, ABW15, ABW23

Workpiece Material		MEGACOAT NANO PLUS				MEGACOAT		PVD coated carbide		Remarks
		PR1725		PR1705		PR1225		PR930		
		Grooving	Turning	Grooving	Turning	Grooving	Turning	Grooving	Turning	
Carbon steel / Alloy steel	Vc (m/min)	★ 60 ~ 180		☆ 80 ~ 200		☆ 60 ~ 150		☆ 80 ~ 100		Coolant
	f (mm/rev)	0.02	0.02 ~ 0.07	0.02	0.02 ~ 0.07	0.02	0.02 ~ 0.07	0.02	0.02 ~ 0.07	
Stainless steel	Vc (m/min)	☆ 30 ~ 130		☆ 40 ~ 150		★ 40 ~ 120		☆ 30 ~ 50		
	f (mm/rev)	0.02	0.02 ~ 0.05	0.02	0.02 ~ 0.05	0.02	0.02 ~ 0.05	0.02	0.02 ~ 0.05	

Workpiece material		Carbide		Remarks
		KW10		
		Grooving	Turning	
Aluminum	Vc (m/min)	150 ~ 200		Coolant
	f (mm/rev)	0.02	0.02 ~ 0.10	
Brass	Vc (m/min)	100 ~ 160		
	f (mm/rev)	0.03	0.02 ~ 0.15	

★: 1st recommendation

☆: 2nd recommendation

ZBMT

Workpiece material	Insert tip angle	Corner-R (RE)	Insert Grade	Vc (m/min)	ap (mm)	f (mm/rev)
Carbon Steel / Alloy Steel	25°	0.2	PR1725	60 - 150 - 200	0.2 - 0.3 - 1.5	0.05 - 0.10 - 0.15
			PR1535	60 - 120 - 180	0.2 - 0.3 - 1.5	0.05 - 0.10 - 0.15
		0.4 / 0.8	PR1725	60 - 150 - 200	0.2 - 0.3 - 2.0	0.05 - 0.15 - 0.25
			PR1535	60 - 120 - 180	0.2 - 0.3 - 2.0	0.05 - 0.15 - 0.25
	15°	0.4	PR1725	60 - 150 - 200	0.2 - 0.3 - 1.0	0.05 - 0.10 - 0.15
			PR1535	60 - 120 - 180	0.2 - 0.3 - 1.0	0.05 - 0.10 - 0.15
Stainless Steel	25°	0.2	PR1725	60 - 150 - 180	0.2 - 0.3 - 1.0	0.05 - 0.10 - 0.15
			PR1535	60 - 120 - 150	0.2 - 0.3 - 1.0	0.05 - 0.10 - 0.15
		0.4 / 0.8	PR1725	60 - 150 - 180	0.2 - 0.3 - 1.0	0.05 - 0.15 - 0.25
			PR1535	60 - 120 - 150	0.2 - 0.3 - 1.0	0.05 - 0.15 - 0.25
	15°	0.4	PR1725	60 - 150 - 180	0.2 - 0.3 - 1.0	0.05 - 0.10 - 0.15
			PR1535	60 - 120 - 150	0.2 - 0.3 - 1.0	0.05 - 0.10 - 0.15
Cast Iron	25°	0.2	PR1725	60 - 150 - 180	0.2 - 0.3 - 1.5	0.05 - 0.10 - 0.15
		0.4 / 0.8	PR1725	60 - 150 - 180	0.2 - 0.3 - 2.0	0.05 - 0.15 - 0.25
	15°	0.4	PR1725	60 - 150 - 180	0.2 - 0.3 - 1.0	0.05 - 0.10 - 0.15

When using machining at ap 1.5 mm or more, reduce the feed by about 50%.

E

Small tools

Boring/Facing Available Cutting Diameter and Maximum D.O.C.



Standard Corner-R 0.4 (RE)

Cutting Dia.	Depth (mm)
ø30	0.5
ø50	1.5
ø65	3.0
ø80	6.0
ø100	10.0
ø150	14.0

SZPB Type Cutting Diameter for Undercutting

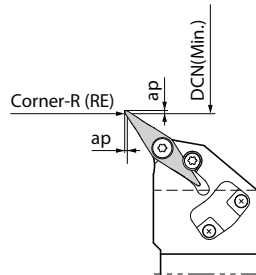

Corner-R (RE)	ap (mm)	DCN (Min.)
0.2	0.5	ø30
	1	ø35
0.4	0.5	ø30
	1	ø35
0.8	0.5	ø110
	1	ø150

How to Modify Toolholder when Using 15° Insert

When using 15° insert, additional modification is required for the holder to avoid interference.

Recommended Additional Modification

- Set the edge of insert bearing surface at the end of the holder at horizontal reference shown below.
- Modify the holder to 0.6 mm from the tip at an angle of not less than 45 degrees from the horizontal.

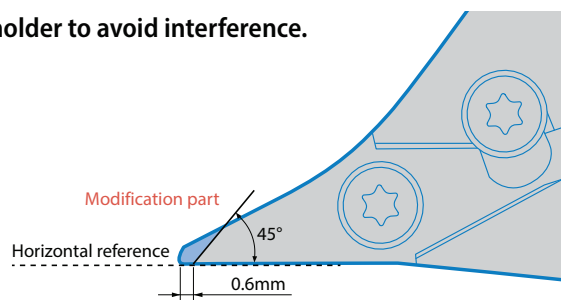

F



Introduction		F2
Solid tip bars for micro boring		F16
EZ Bars		F16
EZ Bar PLUS		F31
EZ Bar sleeves		F38
System Tip-Bars		F44
Twin-Bars		F56
Dynamic-Bars		F60
CC insert		F60
CP insert		F64
DC insert		F66
JC insert		F78
TB/TP insert		F80
TC insert		F88
VB/VC/VP insert		F90
WB/WP insert		F100
ZB insert		F106
Borings bars (screw clamp / top clamp)		F111
SP insert	S-SSKP/S-CSKP	F111
TP insert	S-CTUP	F113
Bearing machining		F114
RPMT insert	SRCP-B	F114
SNMF insert	CBSN-B	F115
AD Bars		F116
CN insert	HA-PCLN	F116
DN insert	HA-PDUN	F118
TN insert	HA-PTFN	F120
CC insert	HA-SCLC	F122
DC insert	HA-SDUC	F123
Boring adapter for AD Bars	AD type with dampener system	F124
Boring bars for negative type inserts		F125
CN insert		F125
DN insert		F128
SN insert		F136
TN insert		F137
WN insert		F140
Boring bars for ceramic inserts		F145
EN insert	S- CELN	F145
Boring bars for CBN inserts		F146
TN insert	S-CTUN-A	F146
Technical information		F147
Recommended cutting conditions		F152

Dynamic Bar

The Dynamic Bar achieves superior chip evacuation

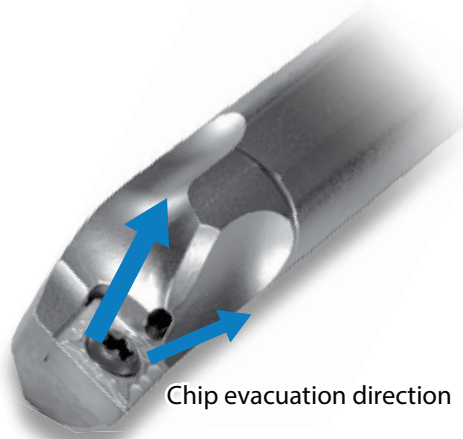

Chip evacuation direction

Superior chip evacuation (External coolant)

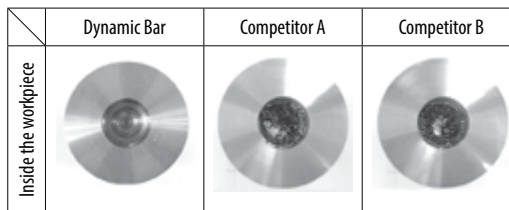

In the products of competitor A and B chips remain inside the workpiece, but chips from the Dynamic Bar are all evacuated from the workpiece.

F

Boring

Comparison of pocket length

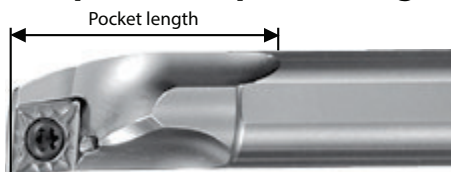

Description	Pocket length (mm)	
	Dynamic Bar	Competitor A
A16-SCLPR09-18 type	37	29
A20-SCLCR09-22 type	48	32

Chip evacuation direction

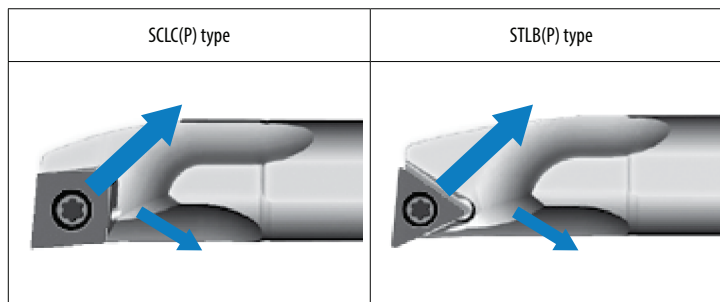

Better evacuation by backward chip flow

High rigidity and chattering resistance are ensured by using a special alloy and with help of stress analysis technology.

Comparison of vibration tendency

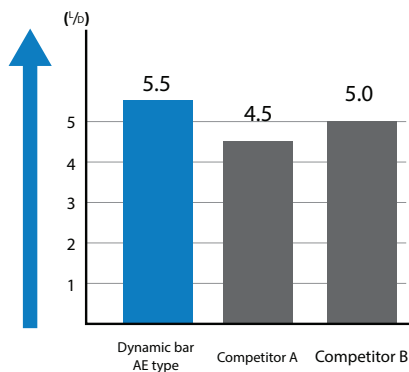

Maximum toolholder overhang length (L/D)

Cutting conditions	
15CrMo4	f = 0.1 mm/rev
Vc = 150 m/min	S16-SCLPR09 type
ap = 0.5 mm	CPMH090304L-Y

Comparison of surface finish

Vibration of the Dynamic Bar was minimal even at high cutting speeds, enabling stable machining.

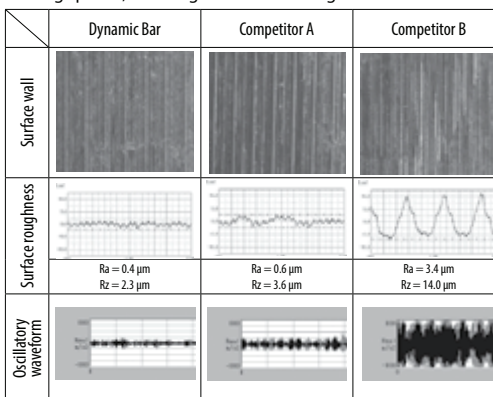

Cutting conditions	
15CrMo4	Vc=210m/min
ap=0.5mm	f=0.1mm/rev
A16Q-SCLPR09-18 type	CPMT090304XP (PV7020)
L/D=4	External coolant

Direction of vibration measurement

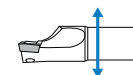

AD Bars interchangeable head boring bars with anti-vibration dampener system

The AD (Advanced Dampener) system enables a maximum overhang of 6 times L/D. Highly efficient machining: The anti-vibration dampener effect enables large cutting-depths and high feed rates. Applicable for a variety of machining conditions due to the interchangeable head design.

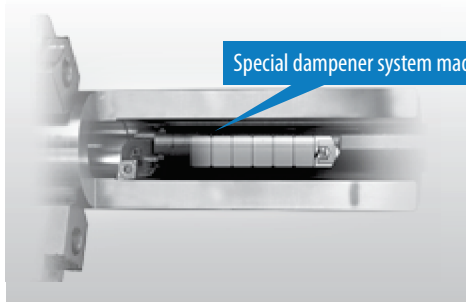

Special dampener system made from heavy metal



How to exchange heads



1. Align hole positions



2. Tighten 3 bolts to attach the head

For lever lock type Interchangeable head, use 2 short bolts for upper side and 1 long bolt for lower side. HA32 SCLC[®]/L.09-40 and HA32 SDUC[®]/L.11-40 use HH5X20 for all 3 bolts.

Possible machining area: Guide-Line for overhang length of AD Bars

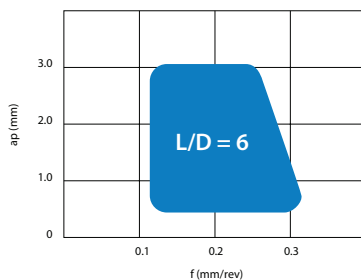

34CrMo4
Vc = 150 m/min
ap = 0.5~3 mm
f = 0.1~0.3 mm/rev
TNMG160408

Double clamp boring bars for negative inserts

Stable machining is realized in double clamp and direction adjustment mechanism coolant hole.

Improved clamping rigidity

Firmly clamp the insert in two directions with one action. Along with improving the accuracy of the insert position, long tool life can be achieved.



Direction adjustment mechanism coolant hole

Discharge direction of coolant is adjustment flexible focusing on coolant to edge reliably builds up
Not applicable to high-pressure coolant



Nozzle setting

Wrench etc. that enters 2.5 or less holes are used, and adjust.



Small Internal Machining

EZ Bar Series

Selecting the proper tool in a simple step. Easy adjustment and high precision
Four chipbreakers for a wide range of machining applications

1 Large Tooling Lineup. Select the proper tool in a simple step

F

Boring

Internal Turning

Supports wide range of Internal Machining Applications

Boring **EZB**

Chipbreakers

H  1st Recommendation / General Purpose
Extended reach type available
Tough Edge (General Purpose) **PR1725**

G  **NEW** Excellent Chip Control Performance
Chip Control Oriented **PR1725**

F  Finishing / Sharpness Oriented
Low Cutting Force **PR1725**

NB  GW05 Insert Grade for Aluminum Machining Available
Without Chipbreaker

45 Degree Chamfering

EZBC

Copying

EZBP

APMX 0.3 ~ 1.0 mm
Compatible with 45 degree copying

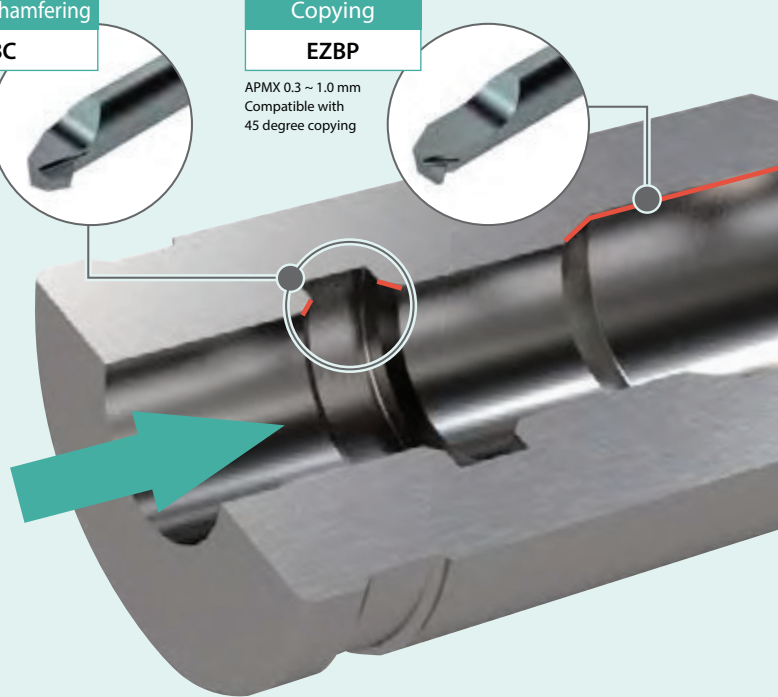

90 Degree Lead Angle

EZBF

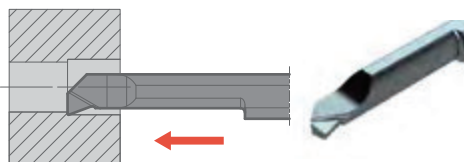

Back Boring

EZBT

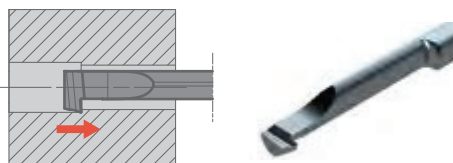

Internal Facing • Internal Profiling

EZVB

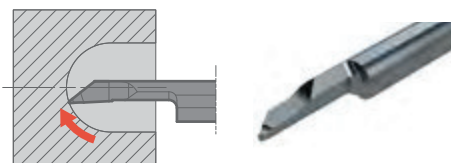

2 Easy Adjustment and High Precision

For CT sleeves with coolant holes and HP sleeves with positioning function, the overhang length can be set by moving adjustment pins

Check

Smooth coolant flow due to special head design



Coolant-Through : EZH-CT

Check

High precision design by contacting the bar end (Slant) with the adjustment pin

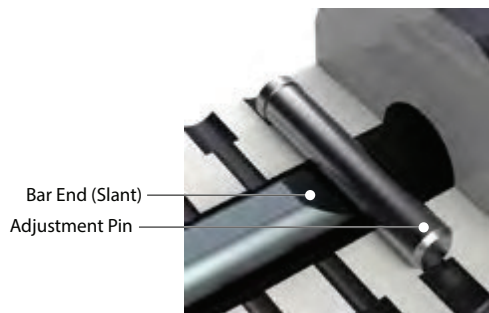

Bar End (Slant)
Adjustment Pin

With EZ Adjust Structure : EZH-CT, EZH-HP



Overhang Length

Adjustment Pin is Moveable



3 Select the HP bar for high precision and the ST bar for cost reduction for Boring (tolerances are different)

HP (EZB-HP)

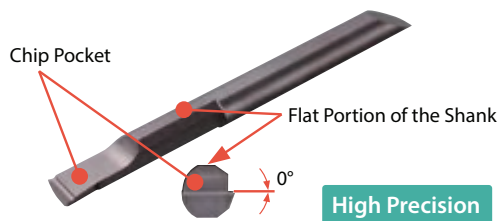

High Precision

ST (EZB-ST)

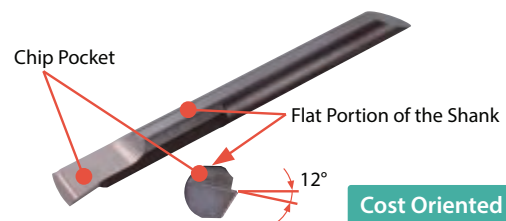

Cost Oriented

Bar Tolerance

	Bar Tolerance	Offset (WF)	Longitudinal Direction (L)	Cutting Edge Height (Y)	Min. Bore Dia.
	HP	± 0.025 mm	± 0.05 mm	+ 0.05 mm / 0 mm	Same as Shank Dia.
	ST	± 0.06 mm	± 0.1 mm	+ 0.06 mm / 0 mm	Different from Shank Dia.

4 Chipbreakers and New PVD Coating PR 1725 for a Wide Range of Machining Processes

H Chipbreaker (Without Lead Angle)
1st Recommendation / General Purpose

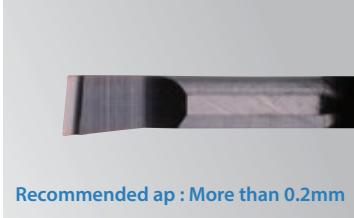

F Chipbreaker (With Lead Angle)
Finishing / Sharpness Oriented



NB Chipbreaker (without Chipbreaker)
Non-ferrous Metal Machining

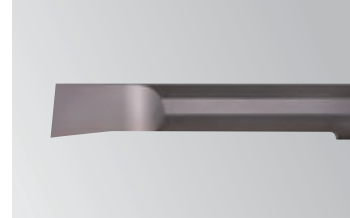

PR1725 Available
GW05 Insert Grade for Aluminum Machining Available
Left-hand Available (HP Type)

PR1725 Available

PCD.CBN Inserts Available
GW05 Insert Grade for Aluminum Machining Available

NEW **G Chipbreaker (With Lead Angle)**
Chip Control Oriented

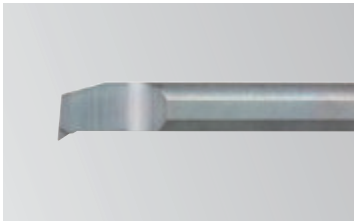

PR1725 Available

Applicable Chipbreaker Range

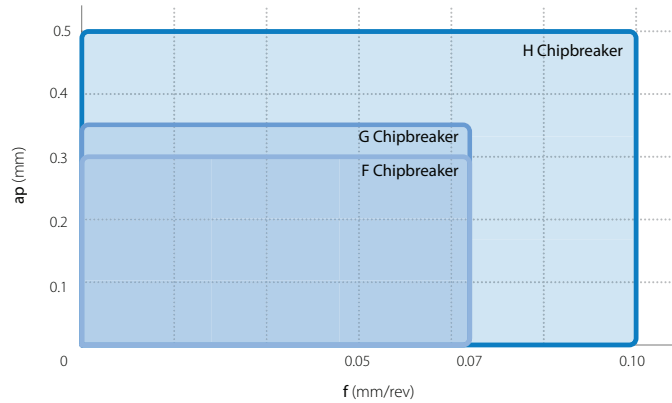

Check Cutting Performance Comparison

Chip Control Comparison

Stable Chip Curls and Good Chip Breaking

G Chipbreaker

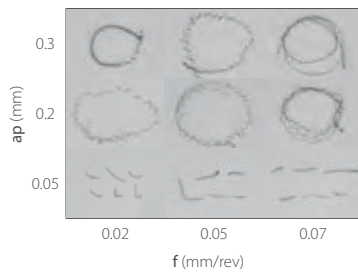

Competitor (With Lead Angle)

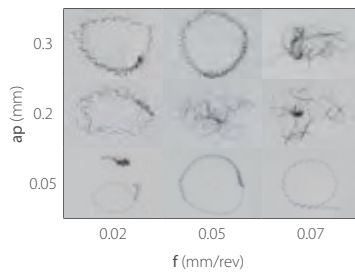

Cutting Conditions: Vc = 80 m/min, Wet Workpiece: C45 (Internal evaluation)

Surface Finish Comparison

Excellent Surface Finish

G Chipbreaker

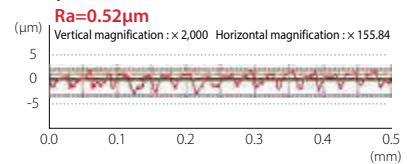

Competitor (With Lead Angle)

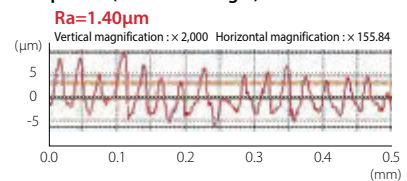

Using Tool : RE = 0.05 mm, Shank Diameter ϕ 4 (Internal evaluation)

F

Boring

Sleeve

Point Large Tooling Lineup that can be Customized for Your Machining Demands

How to select sleeves

Select between three types of sleeves

EZH-CT

With EZ Adjust Structure
Coolant-Through



EZH-HP

With EZ Adjust Structure



EZH-ST

Without EZ Adjust Structure



Point The EZ Bar prevents deviation with high-rigidity clamping

The adjustment pin prevents the bar from rotating during machining

EZ Bar

Fixed by screws from above

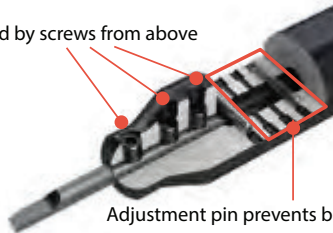

Adjustment pin prevents bar rotation

Competitor

Fixed by screws from above

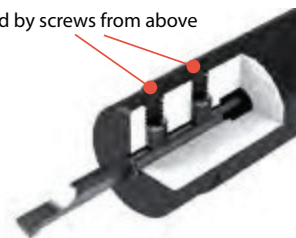

Cutting Diameter Deviation Comparison (Internal Evaluation)

EZ Bar

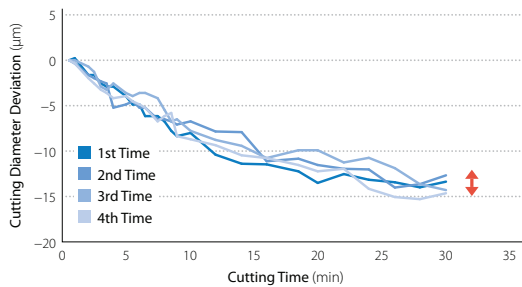

Competitor A

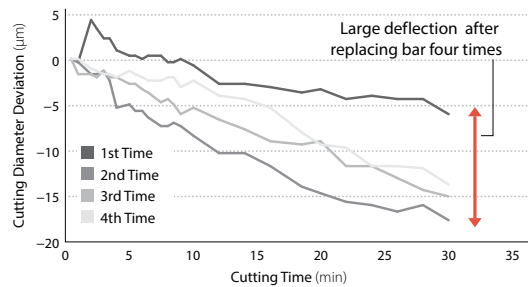

Cutting conditions : Vc = 66 m/min, ap = 0.1 mm, f = 0.02 mm/rev, Wet (Oil-based) Workpiece : SK4

EZ Bar PLUS

High Precision Solid Bar with Convenience of Indexable Inserts
Reduce Machining Costs



Indexable EZ Bar
Minimum Bore Diameter 5 mm

Point Minimum Bore Diameter
5 mm

Carbide or steel bars can be selected depending on the machining purpose

Point Reduces Installing Times
by 1/3

The EZ adjust structure features much lower mounting times compared to conventional boring bars

How to select bars and sleeves for each application

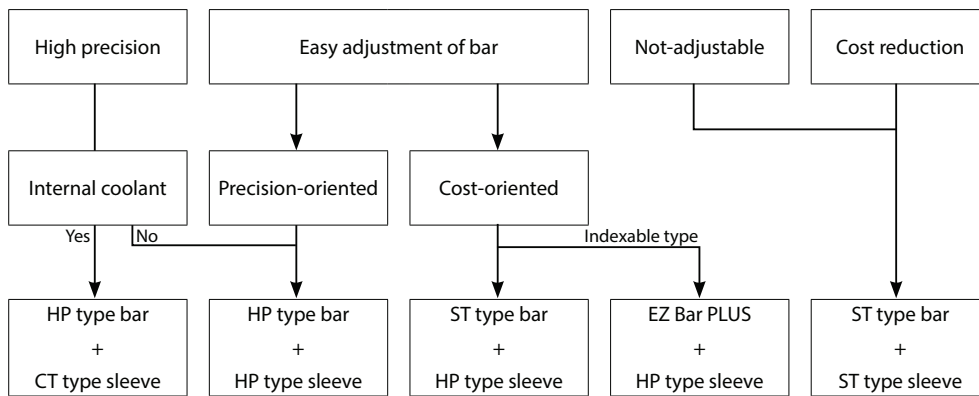

Excellent repeat accuracy by the combination of HP bar + CT / HP sleeve

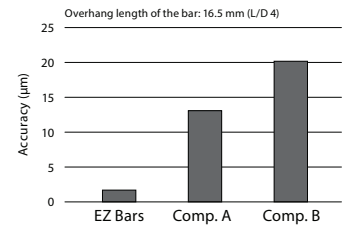
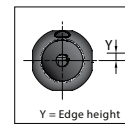

F



Boring

EZH-CT type sleeve (high precision / with coolant hole)

Kyocera's unique EZ adjust structure and internal coolant system improve dimensional accuracy and surface

Coolant discharge system of EZH-CT

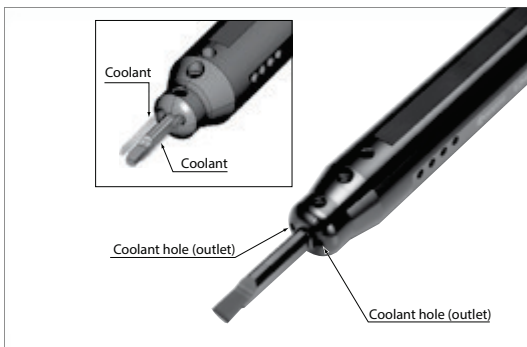

Structure of EZH-CT

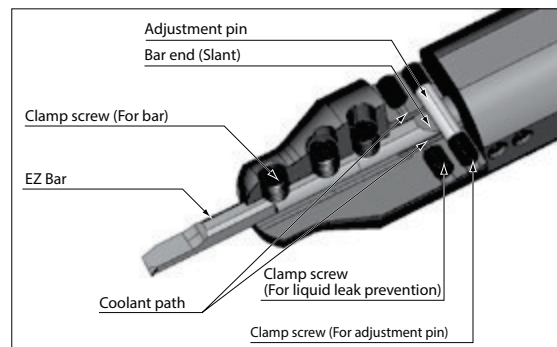

How to mount EZ Bars (EZH-CT sleeve)

How to use adjustment pin and prevent liquid leak (Fig. 1)

- Put the adjustment pin into the hole according to the overhang length. Push it into the sleeve, using the wrench (LW-1.5).
- Tighten the clamp screw for the adjustment pin "HS3x3P" or "HS3x4P" using the wrench "LW-1.5" from the both sides of the sleeve.
- Put the clamp screws "HS3x3P" or "HS3x4P" into the holes for liquid leak prevention, using the wrench "LW-1.5" and fix them from the both sides of the sleeve.

How to fix bar (Fig. 2)

- With the chip pocket upward, set the bar into the sleeve. Press the slant of the end of the bar with the adjustment pin. Make sure that the bar does not move (Fig. 3)
- Tighten the clamp screw with wrench (LW-2) and fix the bar. Use LW-1.5 if shank dia. is 3 mm or less

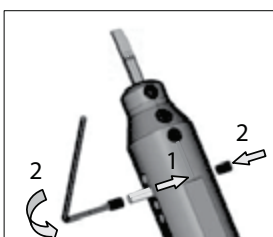

Fig. 1: How to use adjustment pin

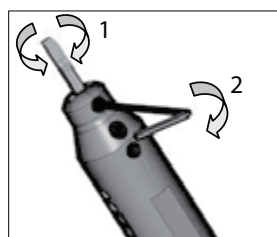

Fig. 2: How to fix bar

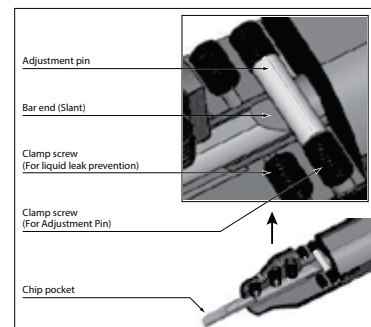
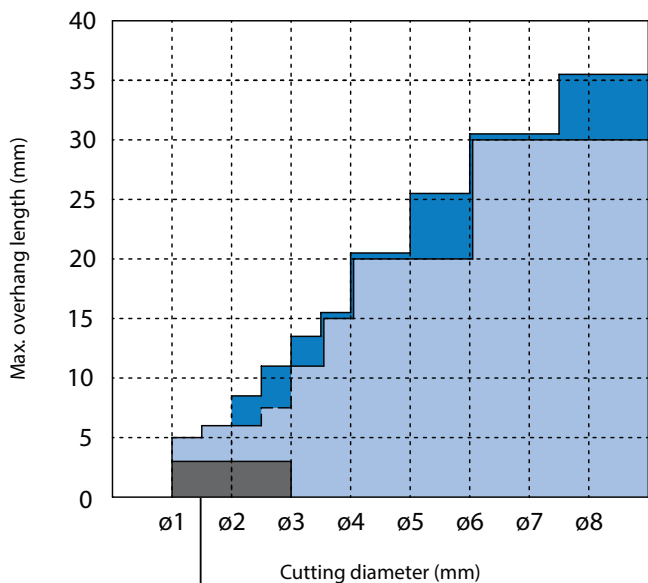

Fig. 3: Fixed bar

Guide for usage (Adjustable overhang type)

Solid tip-bars type: Min. bore diameter $\phi 1$ ~



Easy adjustment and high precision - EZ Bars

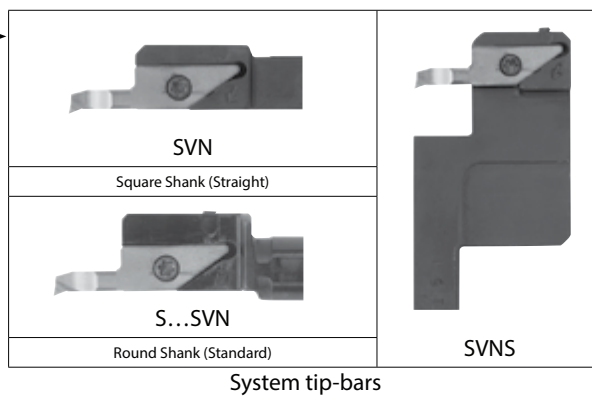
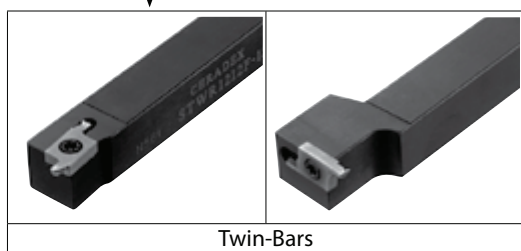

Guide line for overhang length of boring bar - Workpiece material: C45

Overhang Length (L / D)	Shank Material
3	Steel
4	Steel (Dynamic Bar)
5	Excellent
5.5	Excellent (Dynamic Bar)
6	AD bars (with anti-vibration dampener system)
7	Carbide

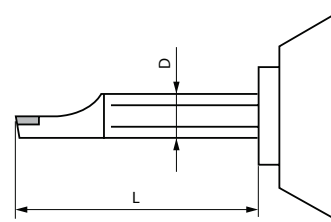

Carbide shank boring bar

Short shank series

Short shank types with length of 1/2 and 2/3 of standard type are available. (-1/2 or -2/3 is shown at the end of the description). When installing on machines, no additional machining (to change toolholder length) is required.



Boring bar identification system (round shank)

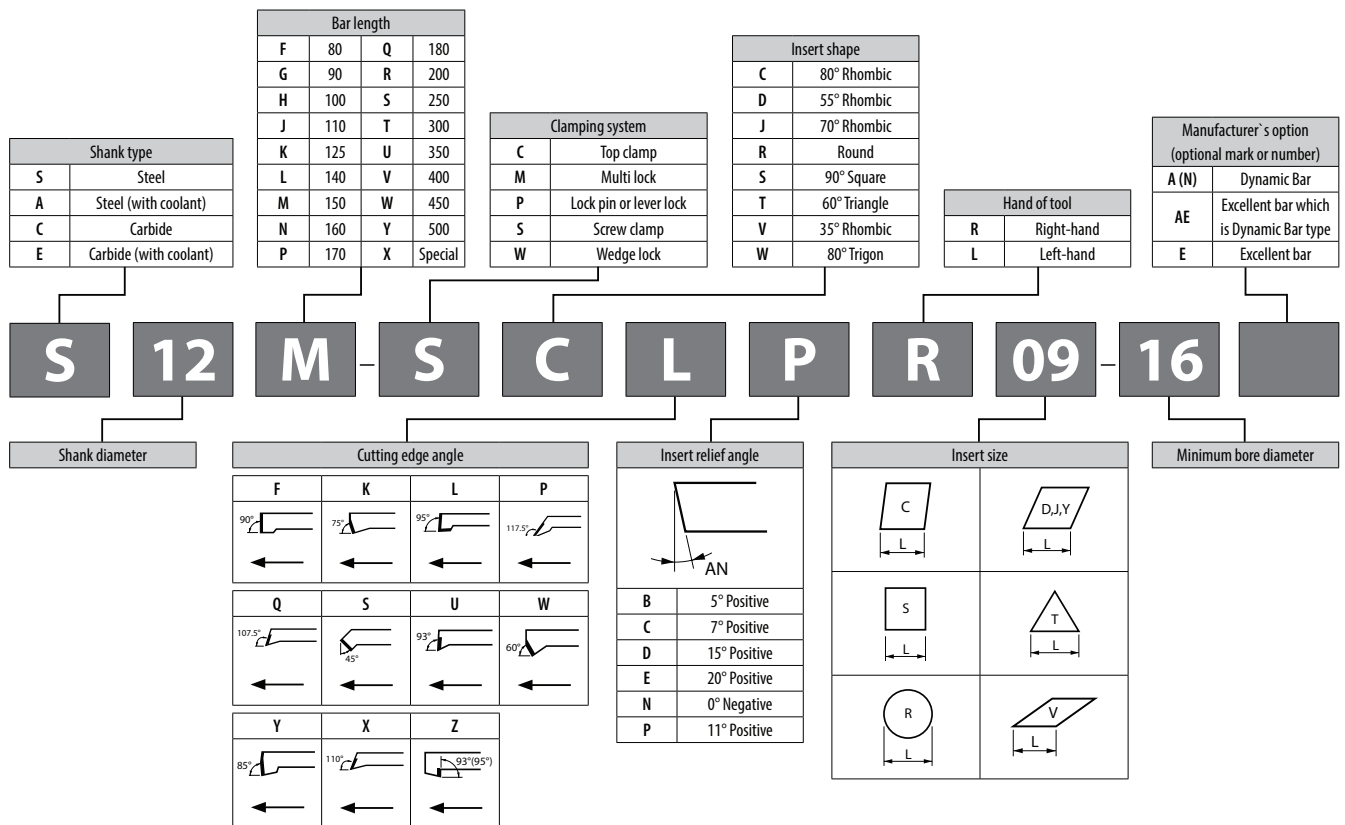

Solid Tip-Bars for Micro Boring

Applications	Solid Tip-Bars Type	Shape	Shank Type Max. Overhang Length (L/D)	Min. Bore Dia. DMIN													See Page for Toolholders	Summary		
				1	1.5	2	2.5	3	3.5	4	4.5	5	5.5	6	6.5	7			7.5	8
Boring	EZB-HP EZ Bars ⊙ F16~F19		Solid L/D≈~5	●	●	●	●	●	●	●	●	●	●	●	●	●		F38~F43		
	EZB-HP-LT EZ Bars (Long Type) ⊙ F17		Solid	●	●	●	●	●	●	●	●	●	●	●	●	●				
	EZB-ST EZ Bars ⊙ F20, F21		Solid L/D≈~5	●	●	●	●	●	●	●	●	●	●	●	●	●	●			
	EZB-NB EZ Bars (PR1225 / GW05) ⊙ F22		Solid L/D≈~5	●	●	●	●	●	●	●	●	●	●	●	●	●	●			
	EZB-NB EZ Bars CBN PCD ⊙ F22		Solid				●	●	●	●	●	●	●	●	●	●		F38~F43		
			Solid L/D≈~5				●	●	●	●	●	●	●	●	●	●	●			
	TWB Twin-Bars ⊙ F56		Solid	●	●	●	●	●	●	●	●	●	●	●	●	●	●	F56, F57		
	TWBT Twin-Bars ⊙ F58		Solid	●	●	●	●	●	●	●	●	●	●	●	●	●	●	F59		
	VNB-S System Tip-Bars ⊙ F44		Solid	●	●	●	●	●	●	●	●	●	●	●	●	●	●	F48~F51		
	VNB System Tip-Bars ⊙ F45, F46		Solid	●	●	●	●	●	●	●	●	●	●	●	●	●	●	F48~F51		
VNBX-S System Tip-Bars ⊙ F52		Solid	●	●	●	●	●	●	●	●	●	●	●	●	●	●	F53~F55			
90° Lead Angle	EZBF ⊙ F24		Solid				●	●	●	●	●	●	●	●	●	●	F38~F43			
	Copying	EZBP ⊙ F26		Solid		●	●	●	●	●	●	●	●	●	●	●	●	F38~F43		
EZVB EZ Bars ⊙ F28			Solid				●	●	●	●	●	●	●	●	●	●	F38~F43			
Back Boring	EZBT EZ Bars ⊙ F30		Solid						●	●	●	●	●	●	●	●	F39, F41, F43			
	VNBT System Tip-Bars ⊙ F47		Solid						●	●	●	●	●	●	●	●	F48~F51			
45° Chamfering	EZBC ⊙ F27		Solid							●	●	●	●	●	●	●	F39, F41, F43			

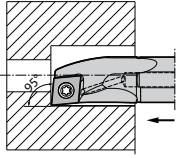
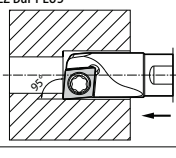
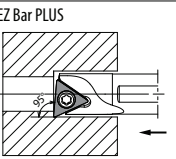
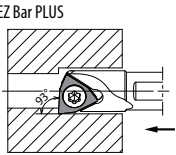

Dynamic Bar / EZ Bar PLUS

Applications	Shape	Boring Bar Type	Shank Type Max. Overhang Length (L/D)	Coolant Hole		Min. Bore Dia. DMIN																				See Page for Toolholders				
				Yes	No	5	6	7	8	10	12	13	14	16	18	20	22	23	25	26	27	30	31	32	34		40	50		
Boring / Internal Facing		A...SCLC-AE	Excellent L/D=~5.5	●						●	●		●	●						●									F60	
		S...SCLC-AE	Excellent L/D=~5.5	○	●	●	●																						F61	
		S...SCLC-A	Steel L/D=~4	○						●	●		●	●		●						●							F62	
		C...SCLC-AN	Carbide L/D=~7	○	●	●	●																							
		E...SCLC-A(N)	Carbide L/D=~7	●						●	●		●	●		●						●								
		A...SCLP-AE	Excellent L/D=~5.5	●								●	●	●	●		●					●								F64
		S...SCLP-A	Steel L/D=~4	○								●	●	●	●		●					●								F65
		E...SCLP-A(N)	Carbide L/D=~7	●								●	●	●	●		●					●								
		S...SCLC-EZ(P)	Steel L/D=~3	○	●	●	●	●																					F31	
		C...SCLC-EZ(P)	Carbide L/D=~5	○	●	●	●	●																					F32	
		A...STLP-AE	Excellent	●							●	●		●	●	●		●			●								F80	
		S...STLB-AE	L/D=~5.5	○				●																					F81	
		S...STLB(P)-A	Steel L/D=~4	○					●	●	●		●	●	●		●					●							F82	
		E...STLP-A(N)	Carbide	●						●	●		●	●	●		●				●									
		C...STLB-AN	L/D=~7	○					●																					
		A...STLC-AE	Excellent L/D=~5.5	●							●	●		●	●		●													F88
	S...STLC-A	Steel L/D=~4	○								●	●		●	●		●												F89	
		S...STLB(P)-EZP	Steel L/D=~3	○					●	●																			F33	
		C...STLB(P)-EZP	Carbide L/D=~5	○					●	●																			F34	
		S...SWUB-AE	Excellent L/D=~5.5	○	●	●	●																						F100	
		A...SWUB(P)-AE	Excellent L/D=~5.5	●							●	●		●	●		●												F101	
S...SWUB(P)-A		Steel L/D=~4	○		●	●	●	●	●	●	●	●	●	●	●	●	●	●	●	●	●	●	●	●	●	●	●	●	F102	
C...SWUB-AN		Carbide L/D=~7	○		●	●	●																							
	E...SWUB(P)-A(N)	Carbide L/D=~7	●							●	●		●	●		●				●										
	S...SWUB-EZP	Steel L/D=~3	○		●	●	●																					F36		
	C...SWUB-EZP	Carbide L/D=~5	○		●	●	●																							

F

Boring

Dynamic Bar

Applications	Shape	Boring Bar Type	Shank Type Max. Overhang Length (L/D)	Coolant Hole		Min. Bore Dia. DMIN																				See Page for Toolholders					
				Yes	No	5	6	7	8	10	12	13	14	16	18	20	22	23	25	26	27	30	31	32	34		40	50			
Copying		A...SDUC-AE	Excellent L/D~5.5	●											●	●		●	●			●						F66 F67 F68			
		S...SDUC-A	Steel L/D~4	○												●	●		●	●			●								
		E...SDUC-A	Carbide L/D~7	●												●	●		●	●			●								
		A...SZLB-AE	Excellent L/D~5.5	●																				●			●		F109		
		A...SDQC-AE	Excellent L/D~5.5	●												●	●		●	●			●								F70 F71 F72
		S...SDQC-A	Steel L/D~4	○												●	●		●	●			●								
	E...SDQC-A	Carbide L/D~7	●												●	●		●	●			●									
		A...SVJB(C)-AE	Excellent L/D~5.5	●																										F90 F91	
		A...SVJP-AE	Excellent L/D~5.5	●																											
		S...SVJB(C)-A	Steel L/D~4	○																											
		S...SVJP-A	Steel L/D~4	○																										F90 F91	
		A...SZJB-AE	Excellent L/D~5.5	●																											F106
		A...SZXB-AE	Excellent L/D~5.5	●																											
	A...SZQB-AE	Excellent L/D~5.5	●																											F107	
		A...SVPC(B)-AE	Excellent L/D~5.5	●																											F108
		S...SVPC(B)-A	Steel L/D~4	○																											
		E...SVPC(B)-A	Carbide L/D~7	●																											
		A...SVUB(C)-AE	Excellent L/D~5.5	●																										F94 F95	
		S...SVUB(C)-A	Steel L/D~4	○																											
		E...SVUB(C)-A	Carbide L/D~7	●																											
		A...SVZB(C)-AE	Excellent L/D~5.5	●																										F96 F97	
		S...SVZB(C)-A	Steel L/D~4	○																											
		E...SVZB(C)-A	Carbide L/D~7	●																											
		A...SDZC-AE	Excellent L/D~5.5	●																										F98 F99	
S...SDZC-A		Steel L/D~4	○																												
E...SDZC-A		Carbide L/D~7	●																												
	A...SVZB(C)-AE	Excellent L/D~5.5	●																										F98 F99		
	S...SVZB(C)-A	Steel L/D~4	○																												
	E...SVZB(C)-A	Carbide L/D~7	●																												
	A...SZZB-AE	Excellent L/D~5.5	●																										F110		
	A...SDZC-AE	Excellent L/D~5.5	●																												
	S...SDZC-A	Steel L/D~4	○																												

For Min. Bore Dia. DMIN, the figure under ● may be applied depending on the toolholder type.



Boring Bars

Applications	Boring Bar Type	Shape	Shank Type Max. Overhang Length (L/D)	Coolant Hole		Insert Type	Min. Bore Dia. DMIN													See Page for Toolholders							
				Yes	No		5	6	7	8	10	12	14	16	18	20	25	30	32		40	50	63				
Boring / Internal Facing	A...DCLN12		Steel L/D≈3	●		Negative																●	●	●	F125		
	S...PCLN○○		Steel L/D≈3		○	Negative																●	●	●	F126		
	A...PCLN09		Steel L/D≈3	●		Negative																●	●	●			
	A...DWLN08		Steel L/D≈3	●		Negative																	●	●	●	F142	
	S...PWLN○○		Steel L/D≈3		○	Negative																	●	●	●	F140	
	A...PWLN06		Steel L/D≈3	●		Negative																	●	●	●	F140	
	S...WWLN08-E		Excellent L/D≈5		○	Negative																	●	●	●	F143	
	C...STXP(B)		Carbide L/D≈7		○	Positive			●	●	●															F86	
	C...SJLC		Carbide L/D≈7		○	Positive	●																			F78	
Copying	S...STWP-E		Excellent L/D≈5		○	Positive					●		●		●	●		●							F84 F85		
	S...STWP		Steel L/D≈3		○	Positive					●		●		●	●											
	A...DDUN15		Steel L/D≈3	●		Negative																	●	●	●	F130	
	S...PDUN11		Steel L/D≈3		○	Negative																	●	●	●	F128	
	A...PDUN11		Steel L/D≈3	●		Negative																	●	●	●		
	S...PDUN15		Steel L/D≈3		○	Negative																	●	●	●	F132	
	S...PDQN15		Steel L/D≈3		○	Negative																	●	●	●	F133	
Back copying	C...STZB		Carbide L/D≈7		○	Positive					●														F87		
	C...SJZC		Carbide L/D≈7		○	Positive	●																		F79		
	S...PDZN15		Steel L/D≈3		○	Negative																	●	●	●	F134	
Boring	S...CTUP		Steel L/D≈3		○	Positive							●		●	●		●	●			●	●	●	F113		
	A...DTFN○○		Steel L/D≈3	●		Negative																	●	●	●	F137	
	S...PTUN○○		Steel L/D≈3		○	Negative																	●	●	●	F138	
	A...PTUN11		Steel L/D≈3	●		Negative																	●	●	●		
	A...DSKN12		Steel L/D≈3	●		Negative																		●	●	●	F136
	S...SSKP		Steel L/D≈3		○	Positive																	●			F111 F112	
	S...CSKP		Steel L/D≈3		○	Positive																	●	●	●		

For Min. Bore Dia. DMIN, the figure under ● may be applied depending on the toolholder type.



Boring

AD Bars Interchangeable Head Boring Bars with Anti-vibration Dampener System

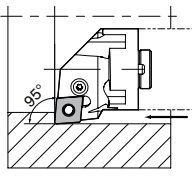
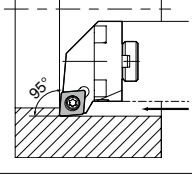
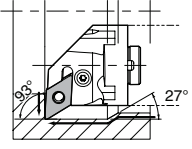
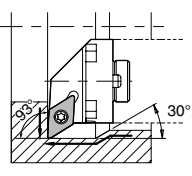
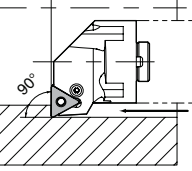
Applications	Boring Bar Type	Shape	Shank Type Max. Overhang Length (L/D)	Coolant Hole		Insert Type	Min. Bore Dia. DMIN													See Page for Toolholders							
				Yes	No		7	8	10	12	14	16	18	20	25	30	32	40	43		50	63					
Boring / Internal facing	HA-PCLN12		Anti-vibration Dampener System L/D ~ 5.5	●		Negative													●				●		F116		
	HA-SCLC09		Anti-vibration Dampener System L/D ~ 6	●		Positive														●					F122		
Copying	HA-PDUN15		Anti-vibration Dampener System L/D ~ 6	●		Negative																	●	●	●	F118	
	HA-SDUC11		Anti-vibration Dampener System L/D ~ 6	●		Positive																		●		F123	
Boring	HA-PTFN16		Anti-vibration Dampener System L/D ~ 6	●		Negative																		●	●	●	F120

F



Boring

Boring Toolholders for Bearing Machining (Square Shank)

Applications	Boring Bar Type	Shape	Min. Bore Dia. DMIN						See Page for Toolholders
			20	25	30	32	40	50	
Boring	SRCP-B		●				●		F114

Applications	Boring Bar Type	Shape	Min. Bore Dia. DMIN						See Page for Toolholders
			20	25	30	32	40	50	
Round-Chamfering	CBSN-B		●						F115

Boring Bars for Ceramic / Solid CBN Tools (L/D ~ 3)

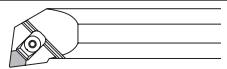
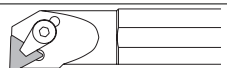
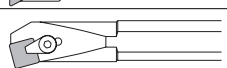
Applications	Boring Bar Type	Shape	Min. Bore Dia. DMIN							See Page for Toolholders	
			16	18	20	25	30	32	40		50
Boring / Internal Facing	S-CELN									●	F145
Boring	S-CTUP		●		●	●	●	●	●	●	F113
	S-CSKP				●	●	●				F112

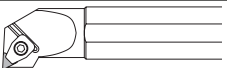
Applications	Boring Bar Type	Shape	Min. Bore Dia. DMIN						See Page for Toolholders	
			20	25	30	32	40	50		
Boring	S-CTUN-A				●					F146

For Min. Bore Dia. ϕA , the figure under ● may be applied depending on the toolholder type.

EZB-HP (H Chipbreaker) (Boring)

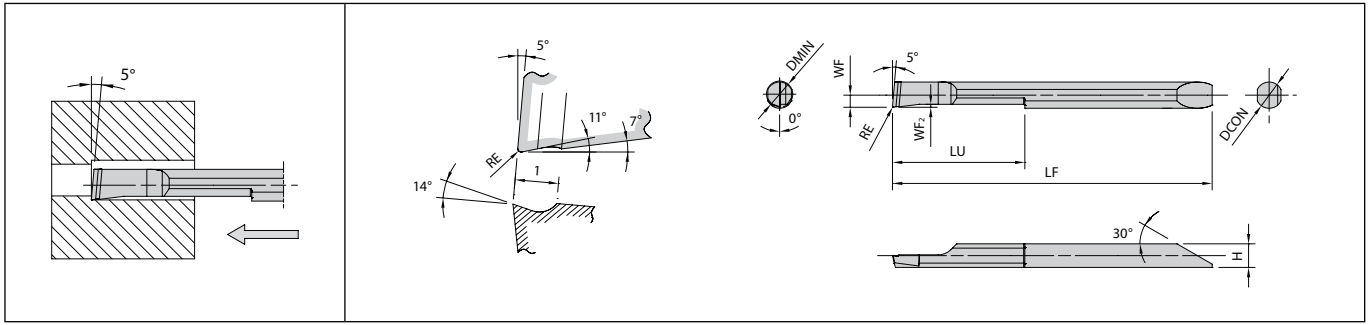

Right-hand shown | Without lead angle | Tough edge (General purpose)

F

Dimensions

Description	No. of edges	Dimension (mm)										Tolerance (mm)			Carbide				Applicable sleeve F38~F43
		DMIN	DCON	H	LF	LU	WF	WF ₂	RE	RE min.	RE max.	PVD		-					
												PR1225	PR1725	GW05					
												R	L	R	R				
EZB [°] L 020020HP-008H	1	2	2	1.8	32	8	0.85	0.25	0.08	-0.015	+0.015	●	●	●	●	EZH020...			
EZB [°] L 025025HP-008H 025025HP-015H	1	2.5	2.5	2.3	35	10.5	1.1	0.25	0.08 0.15	-0.015 -0.02	+0.015 +0.02	●	●	●	●	EZH025...			
EZB [°] L 030030HP-008H 030030HP-015H	1	3	3	2.7	38.9	13	1.35	0.3	0.08 0.15	-0.015 -0.02	+0.015 +0.02	●	●	●	●	EZH030...			
EZB [°] L 035035HP-008H 035035HP-015H	1	3.5	3.5	3.2	41.9	15	1.6	0.4	0.08 0.15	-0.015 -0.02	+0.015 +0.02	●	●	●	●	EZH035...			
EZB [°] L 040040HP-008H 040040HP-015H	1	4	4	3.6	48.8	20	1.85	0.4	0.08 0.15	-0.015 -0.02	+0.015 +0.02	●	●	●	●	EZH040...			
EZB [°] L 045045HP-008H 045045HP-015H	1	4.5	4.5	4.1	51.1	22.5	2.1	0.5	0.08 0.15	-0.015 -0.02	+0.015 +0.02	●	●	●	●	EZH045...			
EZB [°] L 050050HP-008H 050050HP-015H	1	5	5	4.6	58.1	25	2.35	0.5	0.08 0.15	-0.015 -0.02	+0.015 +0.02	●	●	●	●	EZH050...			
EZB [°] L 060060HP-008H 060060HP-015H	1	6	6	5.6	66.1	30	2.85	0.6	0.08 0.15	-0.015 -0.02	+0.015 +0.02	●	●	●	●	EZH060...			
EZB [°] L 070070HP-008H 070070HP-015H	1	7	7	6.3	73.8	35	3.3	0.7	0.08 0.15	-0.015 -0.02	+0.015 +0.02	●	●	●	●	EZH070...			
EZB [°] L 080080HP-008H 080080HP-015H	1	8	8	7.2	84.8	40	3.75	0.8	0.08 0.15	-0.015 -0.02	+0.015 +0.02	●	●	●	●	EZH080...			

Tolerance : Offset ±0.025 mm (of the reference pin), overall length ±0.05 mm, edge height +0.05/0 mm

Recommended cutting conditions F23

EZ Bars Identification System

EZ	B	R	020	020	HP	-	008	H
Symbol of EZ Bars	Applications B : Boring Bars	Insert Hand R : Right-hand L : Left-hand	Min. Bore Dia. 020 : 2mm 025 : 2.5mm ⋮	Shank Dia. 020 : 2mm 025 : 2.5mm ⋮	Symbol of Precision HP : High Precision ST : Standard		Corner-R(RE) 008 : 0.08mm 015 : 0.15mm ⋮	Name of Chipbreaker H : Without lead angle G : With lead angle F : With lead angle NB : Without chipbreaker

● : Standard item R : Right-hand only L : Left-hand only □ : Check availability

EZ bars are sold in 1 piece boxes

EZB-HP-LT (H Chipbreaker) (Boring)

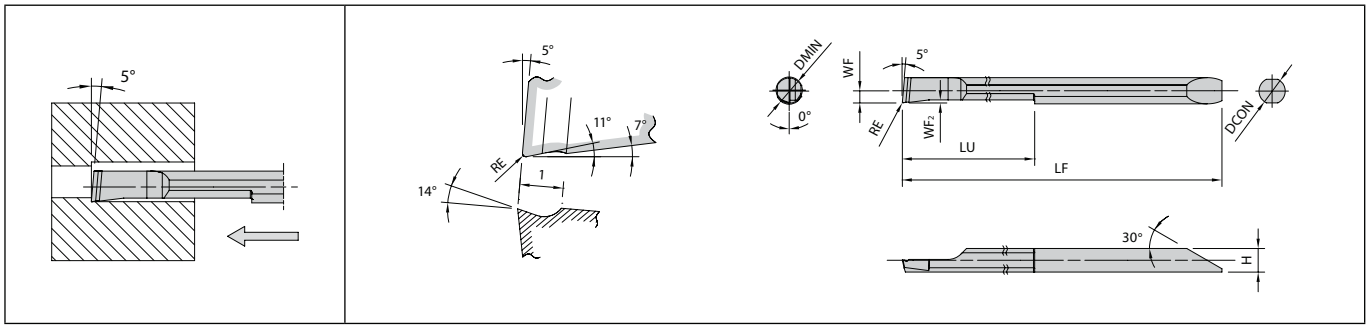

Dimensions

Description	No. of edges	Dimension (mm)								Overhang length (mm)				Tolerance (mm)		Carbide	Applicable sleeve F38~F43	
		DMIN	DCON	H	LF	LU	WF	WF ₂	RE	#1	#2	#3	#4	RE min.	RE max.	PVD		
																		PR1225
EZBR 020020HP-008H-LT	1	2	2	1.8	36	12	0.85	0.08	0.25	12.5	8.5	-	-	-0.015	+0.015	●	EZH020...	
025025HP-008H-LT	1	2.5	2.5	2.3	39.5	15	1.1			15.5	11.5	-	-			●	EZH025...	
030030HP-008H-LT	1	3	3	2.7	47.9	18	1.35			0.3	22.5	18.5	14.5			-	●	EZH030...
035035HP-008H-LT	1	3.5	3.5	3.2	51.9	21	1.6			0.4	25.5	21.5	17.5			-	●	EZH035...
040040HP-008H-LT	1	4	4	3.6	60.8	28	1.85			0.4	32.5	28.5	24.5			20.5	●	EZH040...
050050HP-008H-LT	1	5	5	4.6	73.1	35	2.35			0.5	40.5	35.5	30.5			25.5	●	EZH050...
060060HP-008H-LT	1	6	6	5.6	83.1	42	2.85			0.6	47.5	42.5	37.5			32.5	●	EZH060...

Tolerance : Offset ±0.025 mm (of the reference pin), overall length ±0.05 mm, edge height +0.05/0 mm
 EZBR..H-LT : Inserts need to be modified for overhang length #1 in italics (DCON = 3 - 6 mm).

Recommended cutting conditions F23



EZB-HP (G Chipbreaker) (Boring)

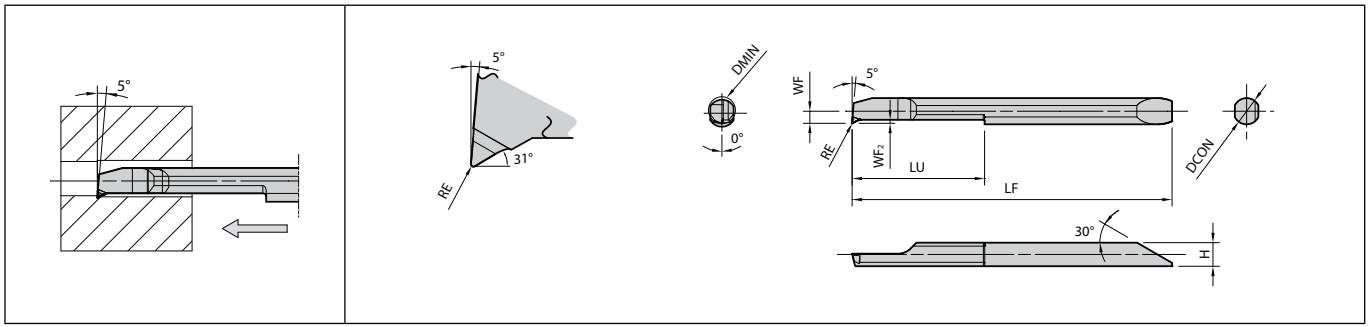

Right-hand shown | With lead angle | Chip control oriented

F

Dimensions

Description	No. of edges	Dimension (mm)									Tolerance (mm)			Carbide	Applicable sleeve F38~F43
		DMIN	DCON	H	LF	LU	WF	WF ₂	RE	RE min.	RE max.	PR1725	R		
EZBR 020020HP-005G	1	2	2	1.65	31.8	8	0.55	0.25	0.05	-0.01	+0.01	●	EZH020...		
EZBR 025025HP-005G 025025HP-015G	1	2.5	2.5	2.15	34.8	10.5	0.8	0.3	0.05 0.15	-0.01 -0.02	+0.01 +0.02	● ●	EZH025...		
EZBR 030030HP-005G 030030HP-015G	1	3	3	2.5	38.7	13	1.05	0.4	0.05 0.15	-0.01 -0.02	+0.01 +0.02	● ●	EZH030...		
EZBR 035035HP-005G 035035HP-015G	1	3.5	3.5	3	41.7	15	1.3	0.5	0.05 0.15	-0.01 -0.02	+0.01 +0.02	● ●	EZH035...		
EZBR 040040HP-005G 040040HP-015G	1	4	4	3.45	48.7	20	1.55	0.5	0.05 0.15	-0.01 -0.02	+0.01 +0.02	● ●	EZH040...		
EZBR 045045HP-005G 045045HP-015G	1	4.5	4.5	3.95	50.9	22.5	1.8	0.7	0.05 0.15	-0.01 -0.02	+0.01 +0.02	● ●	EZH045...		
EZBR 050050HP-005G 050050HP-015G	1	5	5	4.3	57.8	25	2.05	0.7	0.05 0.15	-0.01 -0.02	+0.01 +0.02	● ●	EZH050...		
EZBR 060060HP-005G 060060HP-015G	1	6	6	5.15	65.7	30	2.55	0.9	0.05 0.15	-0.01 -0.02	+0.01 +0.02	● ●	EZH060...		
EZBR 070070HP-005G 070070HP-015G	1	7	7	6.15	73.7	35	3.05	1	0.05 0.15	-0.01 -0.02	+0.01 +0.02	● ●	EZH070...		
EZBR 080080HP-005G 080080HP-015G	1	8	8	7.1	84.8	40	3.55	1	0.05 0.15	-0.01 -0.02	+0.01 +0.02	● ●	EZH080...		

Tolerance : Offset ±0.025 mm (of the reference pin), overall length ±0.05 mm, edge height +0.05/0 mm

Recommended cutting conditions ● F23

● : Standard item R : Right-hand only L : Left-hand only □ : Check availability

EZ bars are sold in 1 piece boxes

EZB-HP (F Chipbreaker) (Boring)

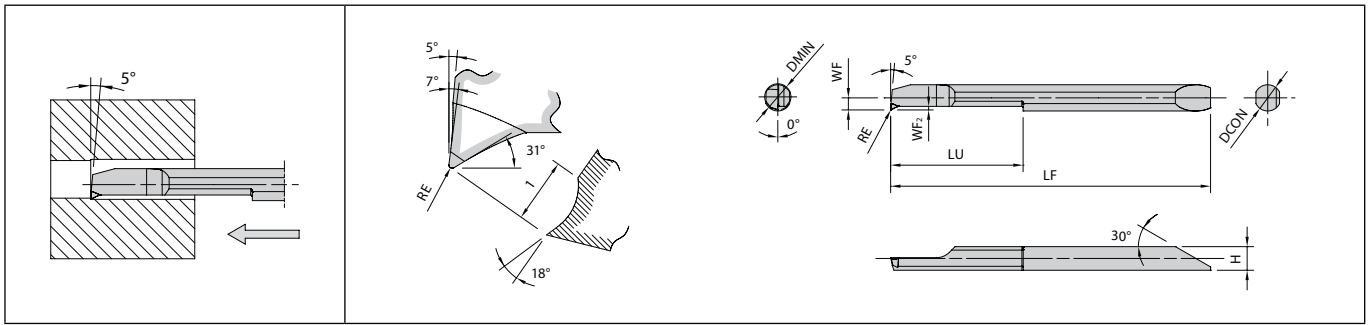

Right-hand shown | With lead angle | Sharp cutting (For finishing)

Dimensions

Description	No. of edges	Dimension (mm)									Tolerance (mm)			Carbide		Applicable sleeve F38~F43
		DMIN	DCON	H	LF	LU	WF	WF ₂	RE	RE min.	RE max.	PVD				
												PR1225	PR1725			
												R	R			
EZBR 020020HP-005F	1	2	2	1.8	32	8	0.85	0.25	0.05	-0.01	+0.01	●	●	EZH020...		
EZBR 025025HP-005F 025025HP-015F	1	2.5	2.5	2.3	35	10.5	1.1	0.3	0.05 0.15	-0.01 -0.02	+0.01 +0.02	●	●	EZH025...		
EZBR 030030HP-005F 030030HP-015F	1	3	3	2.7	38.9	13	1.35	0.4	0.05 0.15	-0.01 -0.02	+0.01 +0.02	●	●	EZH030...		
EZBR 035035HP-005F 035035HP-015F	1	3.5	3.5	3.2	41.9	15	1.6	0.5	0.05 0.15	-0.01 -0.02	+0.01 +0.02	●	●	EZH035...		
EZBR 040040HP-005F 040040HP-015F	1	4	4	3.6	48.8	20	1.85	0.5	0.05 0.15	-0.01 -0.02	+0.01 +0.02	●	●	EZH040...		
EZBR 045045HP-005F 045045HP-015F	1	4.5	4.5	4.1	51.1	22.5	2.1	0.7	0.05 0.15	-0.01 -0.02	+0.01 +0.02	●	●	EZH045...		
EZBR 050050HP-005F 050050HP-015F	1	5	5	4.6	58.1	25	2.35	0.7	0.05 0.15	-0.01 -0.02	+0.01 +0.02	●	●	EZH050...		
EZBR 060060HP-005F 060060HP-015F	1	6	6	5.6	66.1	30	2.85	0.9	0.05 0.15	-0.01 -0.02	+0.01 +0.02	●	●	EZH060...		
EZBR 070070HP-005F 070070HP-015F	1	7	7	6.3	73.8	35	3.3	1	0.05 0.15	-0.01 -0.02	+0.01 +0.02	●	●	EZH070...		
EZBR 080080HP-005F 080080HP-015F	1	8	8	7.2	84.8	40	3.75	1	0.05 0.15	-0.01 -0.02	+0.01 +0.02	●	●	EZH080...		

Tolerance : Offset ±0.025 mm (of the reference pin), overall length ±0.05 mm, edge height +0.05/0 mm

Recommended cutting conditions F23



EZB-ST (H Chipbreaker) (Boring)

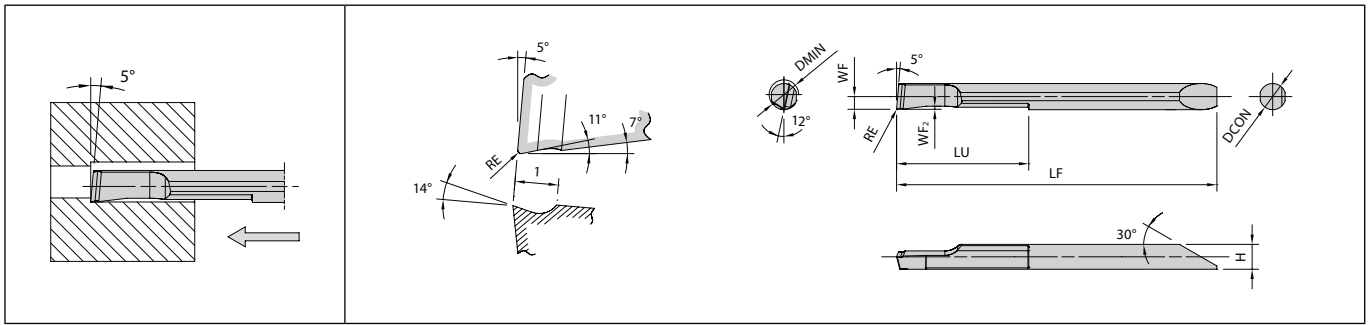

Right-hand shown | Without lead angle | Tough edge (General purpose)

F

Dimensions

Description	No. of edges	Dimension (mm)										Tolerance (mm)			Carbide		Applicable sleeve ● F38~F43
		DMIN	DCON	H	LF	LU	WF	WF ₂	RE	RE min.	RE max.	PVD					
												PR1225	PR1725				
												R	R				
EZBR 020017ST-008H	1	2	1.7	1.5	27.3	7	0.79	0.19	0.08	-0.015	+0.015	●	●	EZH017...			
EZBR 025020ST-008H 025020ST-015H	1	2.5	2	1.82	32	8	0.94	0.16	0.08 0.15	-0.015 -0.02	+0.015 +0.02	●	●	EZH020...			
EZBR 030025ST-008H 030025ST-015H	1	3	2.5	2.3	35	10.5	1.19	0.15	0.08 0.15	-0.015 -0.02	+0.015 +0.02	●	●	EZH025...			
EZBR 035030ST-008H 035030ST-015H	1	3.5	3	2.8	39	13	1.44	0.18	0.08 0.15	-0.015 -0.02	+0.015 +0.02	●	●	EZH030...			
EZBR 040035ST-008H 040035ST-015H	1	4	3.5	3.3	42	15	1.69	0.24	0.08 0.15	-0.015 -0.02	+0.015 +0.02	●	●	EZH035...			
EZBR 045040ST-008H 045040ST-015H	1	4.5	4	3.8	49	20	1.94	0.27	0.08 0.15	-0.015 -0.02	+0.015 +0.02	●	●	EZH040...			
EZBR 055050ST-008H 055050ST-015H	1	5.5	5	4.8	58.2	25	2.44	0.33	0.08 0.15	-0.015 -0.02	+0.015 +0.02	●	●	EZH050...			
EZBR 065060ST-008H 065060ST-015H	1	6.5	6	5.8	66.2	30	2.94	0.38	0.08 0.15	-0.015 -0.02	+0.015 +0.02	●	●	EZH060...			
EZBR 075070ST-008H 075070ST-015H	1	7.5	7	6.8	74.2	35	3.44	0.44	0.08 0.15	-0.015 -0.02	+0.015 +0.02	●	●	EZH070...			

Tolerance : Offset ±0.06 mm , overall length ±0.1 mm, edge height +0.06/0 mm

Recommended cutting conditions ● F23

● : Standard item R : Right-hand only L : Left-hand only □ : Check availability

EZ bars are sold in 1 piece boxes

EZB-ST (F Chipbreaker) (Boring)

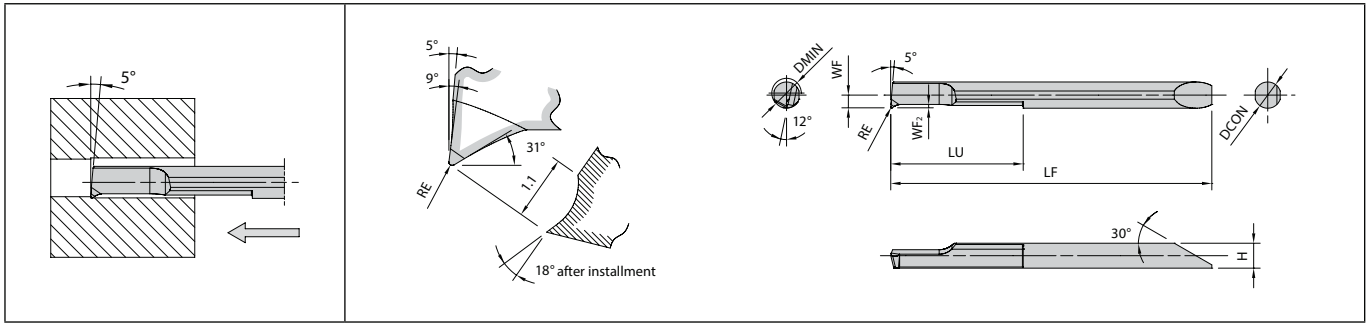

Right-hand shown | With lead angle | Sharp cutting (For finishing)

Dimensions

Description	No. of edges	Dimension (mm)										Tolerance (mm)			Carbide		Applicable sleeve F38~F43
		DMIN	DCON	H	LF	LU	WF	WF ₂	RE	RE min.	RE max.	PVD					
												PR1225	PR1725				
												R	R				
EZBR 020017ST-005F	1	2	1.7	1.5	27.3	7	0.79	0.2	0.05	-0.01	+0.01	●	●	EZH017...			
EZBR 025020ST-005F 025020ST-015F	1	2.5	2	1.82	32	8	0.94	0.16	0.05 0.15	-0.01 -0.02	+0.01 +0.02	●	●	EZH020...			
EZBR 030025ST-005F 030025ST-015F	1	3	2.5	2.3	35	10.5	1.19	0.2	0.05 0.15	-0.01 -0.02	+0.01 +0.02	●	●	EZH025...			
EZBR 035030ST-005F 035030ST-015F	1	3.5	3	2.8	39	13	1.44	0.26	0.05 0.15	-0.01 -0.02	+0.01 +0.02	●	●	EZH030...			
EZBR 040035ST-005F 040035ST-015F	1	4	3.5	3.3	42	15	1.69	0.33	0.05 0.15	-0.01 -0.02	+0.01 +0.02	●	●	EZH035...			
EZBR 045040ST-005F 045040ST-015F	1	4.5	4	3.8	49	20	1.94	0.31	0.05 0.15	-0.01 -0.02	+0.01 +0.02	●	●	EZH040...			
EZBR 055050ST-005F 055050ST-015F	1	5.5	5	4.8	58.2	25	2.44	0.45	0.05 0.15	-0.01 -0.02	+0.01 +0.02	●	●	EZH050...			
EZBR 065060ST-005F 065060ST-015F	1	6.5	6	5.8	66.2	30	2.94	0.59	0.05 0.15	-0.01 -0.02	+0.01 +0.02	●	●	EZH060...			
EZBR 075070ST-005F 075070ST-015F	1	7.5	7	6.8	74.2	35	3.44	0.65	0.05 0.15	-0.01 -0.02	+0.01 +0.02	●	●	EZH070...			

Tolerance : Offset ±0.06 mm , overall length ±0.1 mm, edge height +0.06/0 mm

Recommended cutting conditions F23



EZB-NB (Boring)

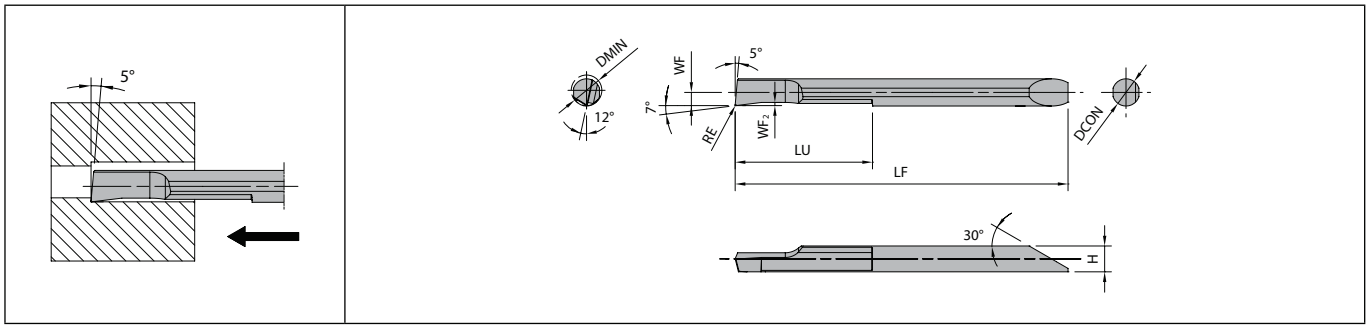

Right-hand shown

F

Dimensions

Description	No. of edges	Dimension (mm)									Tolerance (mm)		Carbide		Applicable sleeve F38~F43
		DMIN	DCON	H	LF	LU	WF	WF ₂	RE	RE min.	RE max.	PVD	-		
												PR1225	GW05		
												R	R		
EZBR 020017-005NB	1	2	1.7	1.5	27.3	7	0.79	0.2	0.05	-0.015	+0.015	●	●	EZH017...	
EZBR 025020-005NB	1	2.5	2	1.82	32	8	0.94	0.16	0.05	-0.015	+0.015	●	●	EZH020...	
EZBR 030025-005NB	1	3	2.5	2.3	35	10.5	1.19	0.16	0.05	-0.015	+0.015	●	●	EZH025...	
EZBR 035030-005NB	1	3.5	3	2.8	39	13	1.44	0.19	0.05	-0.015	+0.015	●	●	EZH030...	
EZBR 040035-005NB	1	4	3.5	3.3	42	15	1.69	0.25	0.05	-0.015	+0.015	●	●	EZH035...	
EZBR 045040-005NB	1	4.5	4	3.8	49	20	1.94	0.28	0.05	-0.015	+0.015	●	●	EZH040...	
EZBR 055050-005NB	1	5.5	5	4.8	58.2	25	2.44	0.33	0.05	-0.015	+0.015	●	●	EZH050...	
EZBR 065060-005NB	1	6.5	6	5.8	66.2	30	2.94	0.39	0.05	-0.015	+0.015	●	●	EZH060...	
EZBR 075070-005NB	1	7.5	7	6.8	74.2	35	3.44	0.45	0.05	-0.015	+0.015	●	●	EZH070...	

Recommended cutting conditions F23

EZB-NB (Boring)

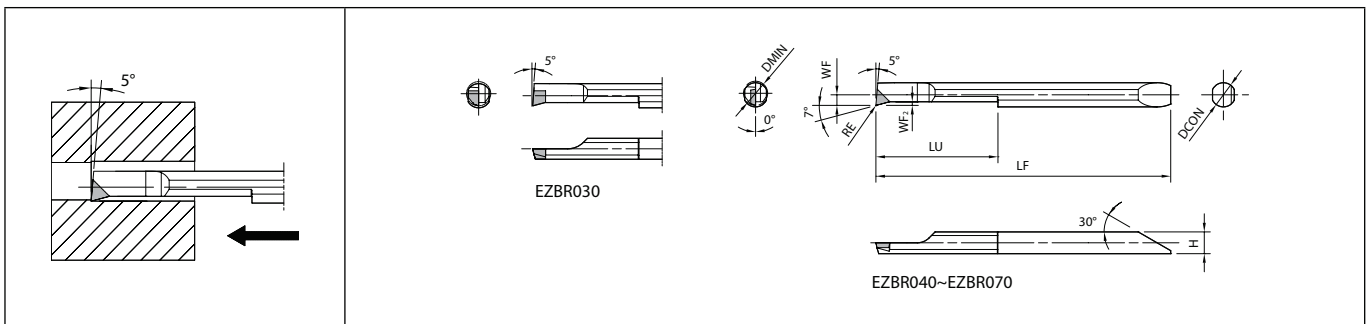

Right-hand shown

Dimensions

Description	No. of edges	Dimension (mm)									Tolerance (mm)		CBN	PCD	Applicable sleeve F38~F43
		DMIN	DCON	H	LF	LU	WF	WF ₂	RE	RE min.	RE max.	PVD	-		
												KBN05M	KPD001		
												R	R		
EZBR 030030-003NB	1	3	3	2.6	38.8	13	1.25	0.3	0.035	-0.015	+0.015	●		EZH030...	
EZBR 040040-003NB	1	4	4	3.6	48.8	20	1.75	0.5	0.035	-0.015	+0.015	●	●	EZH040...	
EZBR 050050-003NB	1	5	5	4.6	58.1	25	2.25	0.5	0.035	-0.015	+0.015	●	●	EZH050...	
EZBR 060060-003NB	1	6	6	5.6	66.1	30	2.75	0.5	0.035	-0.015	+0.015	●	●	EZH060...	
EZBR 070070-003NB	1	7	7	6.6	74.1	35	3.25	0.5	0.035	-0.015	+0.015	●	●	EZH070...	

KBN05M edge preparation : T00815 (0.08mm x 15° Chamfered cutting edge)

KPD001 edge preparation : F (Sharp edge)

Recommended cutting conditions F23

● : Standard item R : Right-hand only L : Left-hand only □ : Check availability

EZ bars are sold in 1 piece boxes

Recommended cutting conditions

H chipbreaker (EZB-HP-H type / EZB-ST-H type)

Workpiece material	Insert grades Vc: m/min			EZB020/025		EZB030/035		EZB040/045		EZB050/055/ 060/065/070/075/080		Remarks
	MEGACOAT NANO PLUS	MEGACOAT	Carbide	ap (mm), f (mm/rev)								
	PR1725	PR1225	GW05	ap	f	ap	f	ap	f	ap	f	
Carbon steel / Alloy steel	30~120	30~100	-	~0.3	~0.03	~0.4	~0.04	~0.45	~0.07	~0.5	~0.1	Coolant
Stainless steel	30~100	30~80	-	~0.2	~0.02	~0.3	~0.03	~0.35	~0.05	~0.4	~0.07	
Non-ferrous metals	-	-	~100	~0.3	~0.05	~0.4	~0.06	~0.45	~0.1	~0.5	~0.15	

H chipbreaker (EZB-HP-H-LT type (Long type))

Workpiece material	Insert grades Vc: m/min		EZB020/025/030/035				EZB040/050/060				Remarks
	MEGACOAT		ap (mm), f (mm/rev)								
	PR1225		ap		f		ap		f		
Carbon steel / Alloy steel	30~60		~0.3		~0.05		~0.4		~0.1		Coolant
Stainless steel	20~40		~0.25		~0.05		~0.3		~0.07		

G chipbreaker

Workpiece material	Insert grades Vc: m/min		EZB020/025		EZB030/035		EZB040/045/050/060/070/080				Remarks
	MEGACOAT NANO PLUS		ap (mm), f (mm/rev)								
	PR1725		ap	f	ap	f	ap		f		
Carbon steel / Alloy steel	30~120		~0.25	~0.03	~0.3	~0.05	~0.35		~0.07		Coolant
Stainless steel	30~100		~0.2	~0.02	~0.25	~0.03	~0.3		~0.05		

F chipbreaker (EZB-HP-F type / EZB-ST-F type)

Workpiece material	Insert grades Vc: m/min		EZB020/025		EZB030/035		EZB040/045		EZB050/055/060/ 065/070/075/080		Remarks
	MEGACOAT NANO PLUS	MEGACOAT	ap (mm), f (mm/rev)								
	PR1725	PR1225	ap	f	ap	f	ap	f	ap	f	
Carbon steel / Alloy steel	30~120	30~100	~0.2	~0.03	~0.2	~0.05	~0.3	~0.07	~0.3	~0.07	Coolant
Stainless steel	30~100	30~80	~0.2	~0.02	~0.2	~0.03	~0.25	~0.05	~0.25	~0.05	

NB (Without chipbreaker)

Workpiece material	Insert grades Vc: m/min		EZB020/025		EZB030/035		EZB040/045		EZB055/ 065/075		Remarks
	MEGACOAT	Carbide	ap (mm), f (mm/rev)								
	PR1225	GW05	ap	f	ap	f	ap	f	ap	f	
Carbon steel / Alloy steel	30~100	-	~0.3	~0.03	~0.4	~0.04	~0.45	~0.07	~0.5	~0.1	Coolant
Stainless steel	30~80	-	~0.2	~0.02	~0.3	~0.03	~0.35	~0.05	~0.4	~0.07	
Non-ferrous metals	-	~100	~0.3	~0.05	~0.4	~0.06	~0.45	~0.07	~0.5	~0.1	

Workpiece material	Insert grades Vc: m/min		EZB030		EZB040/045		EZB050/060/070		Remarks		
	MEGACOAT CBN	PCD	ap (mm), f (mm/rev)								
	KBN05M	KPD001	ap	f	ap	f	ap	f			
Non-ferrous metals	-	~300	-	-	~0.45	~0.1	~0.5	~0.15	Coolant		
Hard materials	~100	-	~0.07	~0.03	~0.10	~0.05	~0.15	~0.07			



Boring

EZBF (Boring, 90° Lead angle)

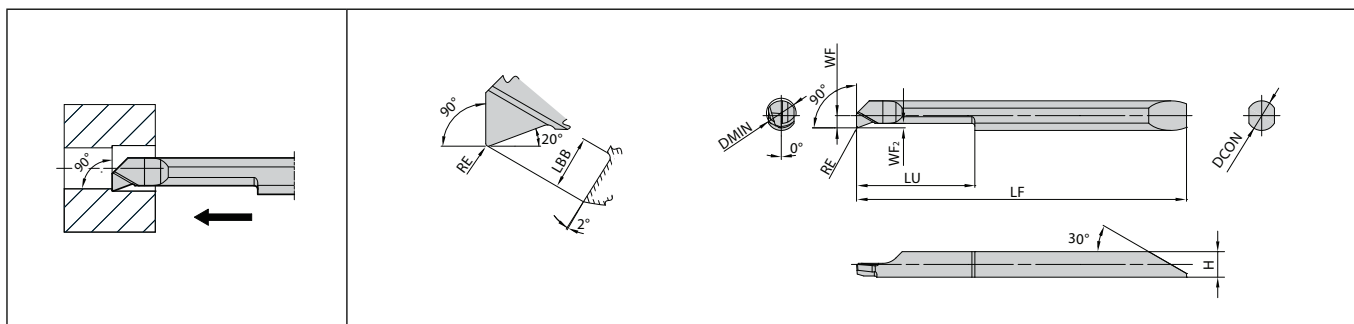

Right-hand shown

Dimensions

Description	No. of edges	Dimension (mm)										Tolerance (mm)		Carbide	Applicable sleeve ● F38~F43
		DMIN	DCON	H	LBB	LF	LU	WF	WF ₂	RE	RE min.	RE max.	PVD		
													PR1225		
													R		
EZBFR 030030-008	1	3	3	2.5	1.5	37.7	12	1.2	0.45	0.08	-0.015	+0.015	●	EZH030...	
EZBFR 040040-008	1	4	4	3.45	2	44.6	16	1.65	0.55	0.08	-0.015	+0.015	●	EZH040...	
EZBFR 050050-015	1	5	5	4.3	2.4	52.7	20	2.15	0.7	0.15	-0.02	+0.02	●	EZH050...	
EZBFR 060060-015	1	6	6	5.15	2.8	59.6	24	2.55	0.85	0.15	-0.02	+0.02	●	EZH060...	

Recommended cutting conditions

Workpiece Material	Insert Grades (Cutting Speed Vc : m/min)	EZBFR030030-008		EZBFR040040-008		EZBFR050050/ 060060-015		Remarks
	MEGACOAT	ap (mm), f (mm/rev)						
	PR1225	ap	f	ap	f	ap	f	
Carbon Steel / Alloy Steel	30~100	~0.2	~0.05	~0.3	~0.05	~0.5	~0.05	Coolant
Stainless Steel	30~80	~0.2	~0.05	~0.3	~0.05	~0.5	~0.05	

● : Standard item R : Right-hand only L : Left-hand only □ : Check availability

EZ bars are sold in 1 piece boxes

Precautions

✓ Recommended ✗ Not Recommended

1. Machining in blind hole is not recommended



2. If front cutting edge exceeds beyond workpiece center line, fracturing may occur



Min boring diameter of $\phi 4$: 1.9 mm front cutting edge length

Off-center Boring

3. Up facing is not recommended



EZBP (Internal copying)

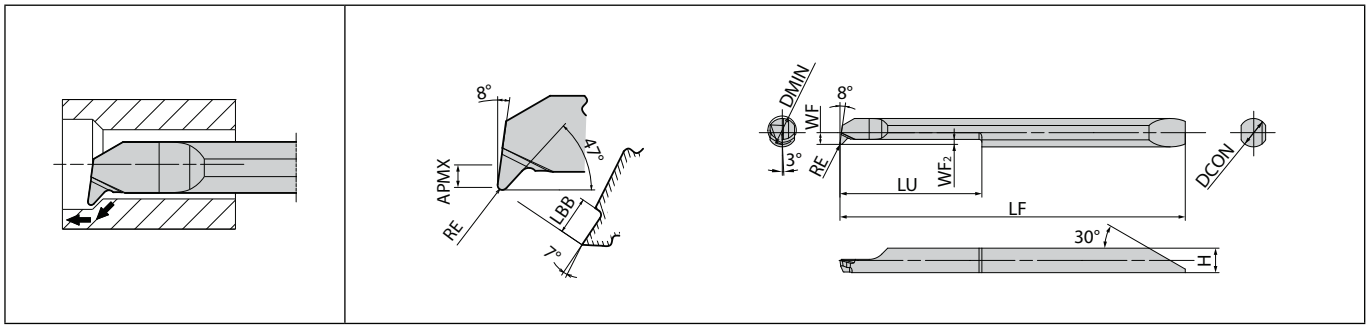

Right-hand shown

Dimensions

Description	No. of edges	Dimension (mm)										Tolerance (mm)		Carbide	Applicable sleeve ● F38~F43
		DMIN	DCON	H	LBB	LF	LU	WF	WF ₂	APMX	RE	RE min.	RE max.	PVD	
														PR1225	
EZBPR 020020-005-08 020020-005-10 020020-005-12	1	2	2	1.65	1	31.8	8	0.55	0.35	0.3	0.05	-0.01	+0.01	●	EZH020...
						33.8	10							●	
						35.8	12							●	
EZBPR 030030-005-12 030030-005-15	1	3	3	2.5	1.2	37.7	12	1.05	0.45	0.4	0.05	-0.01	+0.01	●	EZH030...
						40.7	15							●	
EZBPR 040040-015	1	4	4	3.45	1.5	48.7	20	1.65	0.65	0.6	0.15	-0.02	+0.02	●	EZH040...
EZBPR 050050-015	1	5	5	4.3	2.2	57.8	25	2	1.1	0.8	0.15	-0.02	+0.02	●	EZH050...
EZBPR 060060-015	1	6	6	5.15	2.5	65.7	30	2.45	1.35	1	0.15	-0.02	+0.02	●	EZH060...

Recommended cutting conditions

Workpiece Material	Insert Grades (Cutting Speed V _c : m/min)	EZBPR020		EZBPR030		EZBPR040		EZBPR050		EZBPR060		Remarks
	MEGACOAT	ap (mm), f (mm/rev)										
	PR1225	ap	f	ap	f	ap	f	ap	f	ap	f	
Carbon Steel / Alloy Steel	30~100	~0.3	~0.05	~0.4	~0.05	~0.6	~0.05	~0.8	~0.05	~1.0	~0.05	Coolant
Stainless Steel	30~80	~0.3	~0.05	~0.4	~0.05	~0.6	~0.05	~0.8	~0.05	~1.0	~0.05	

●: Standard item R: Right-hand only L: Left-hand only □: Check availability

EZ bars are sold in 1 piece boxes

F

Boring

Solid

Positive

AD bars

Negative

EZBC (Internal chamfering)

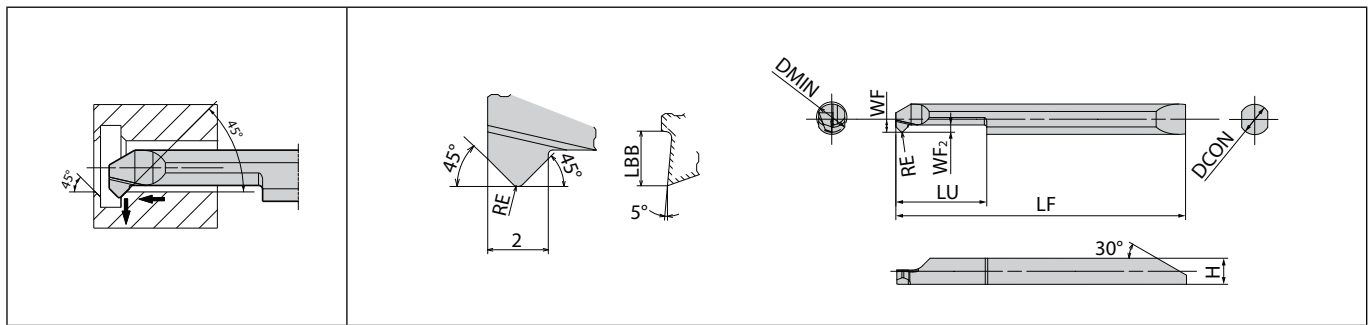

Right-hand shown

Dimensions

Description	No. of edges	Dimension (mm)										Tolerance (mm)		Carbide	Applicable sleeve F39 F41 F43
		DMIN	DCON	H	LBB	LF	LU	WF	WF ₂	RE	RE min.	RE max.	PVD		
													PR1225		
													R		
EZBCR 050050-020-15 050050-020-20	1	5	5	4.3	1.8	47.8 52.8	15 20	2.15	1.2	0.2	-0.02	+0.02	●	EZH050...	
EZBCR 060060-020-18 060060-020-24	1	6	6	5.15	2.5	53.7 59.7	18 24	2.65	1.9	0.2	-0.02	+0.02	●	EZH060...	
EZBCR 070070-020-21 070070-020-42	1	7	7	6.2	3.1	59.7 80.7	21 42	3	2.5	0.2	-0.02	+0.02	●	EZH070...	



Recommended cutting conditions

Workpiece Material	Insert Grades (Cutting Speed Vc : m/min)	EZBC050		EZBC060		EZBC070		Remarks
	MEGACOAT	ap (mm), f (mm/rev)						
	PR1225	ap	f	ap	f	ap	f	
Carbon Steel / Alloy Steel	30~100	~0.7	~0.06	~0.7	~0.06	~0.7	~0.06	Coolant
Stainless Steel	30~80	~0.7	~0.06	~0.7	~0.06	~0.7	~0.06	

● : Standard item R : Right-hand only L : Left-hand only □ : Check availability

EZ bars are sold in 1 piece boxes

EZVB (Boring / Internal facing / Internal copying)

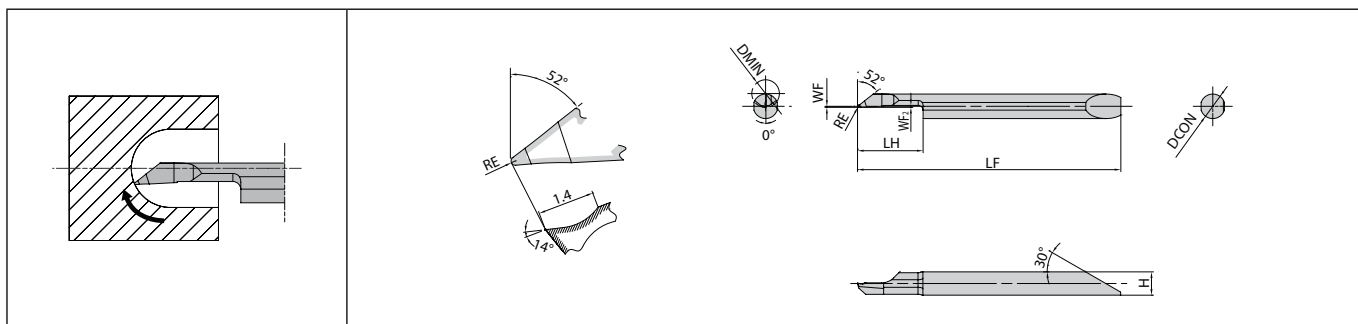

Right-hand shown

F

Dimensions

Description	No. of edges	Dimension (mm)										Tolerance (mm)		Carbide	Applicable sleeve ● F38~F43
		DMIN	DCON	H	LH	H	LF	WF	WF ₂	RE	RE min.	RE max.	PVD		
													PR1225		
													R		
EZVBR 035030-010	1	3.5	3	2.8	8	2.8	38	0.17	0.22	0.1	-0.015	+0.015	●	EZH030...	
EZVBR 045040-010	1	4.5	4	3.8	10	3.8	43						0.26	●	EZH040...
EZVBR 055050-010	1	5.5	5	4.8	12	4.8	50.2						0.29	●	EZH050...
EZVBR 065060-010	1	6.5	6	5.8	14	5.8	55.2						0.32	●	EZH060...

Boring

Solid

Positive

AD bars

Negative

Recommended cutting conditions

Workpiece material	Insert grades	EZVB035		EZVB045		EZVB055/065		Remarks
	Vc: m/min	ap (mm), f (mm/rev)						
	MEGACOAT							
	PR1225	ap	f	ap	f	ap	f	
Carbon steel / Alloy steel	30~100	~0.05	~0.04	~0.07	~0.07	~0.1	~0.07	Coolant
Stainless steel	30~80	~0.03	~0.03	~0.05	~0.05	~0.07	~0.05	

● : Standard item R : Right-hand only L : Left-hand only □ : Check availability

EZ bars are sold in 1 piece boxes

Application of EZVB

1. Application range

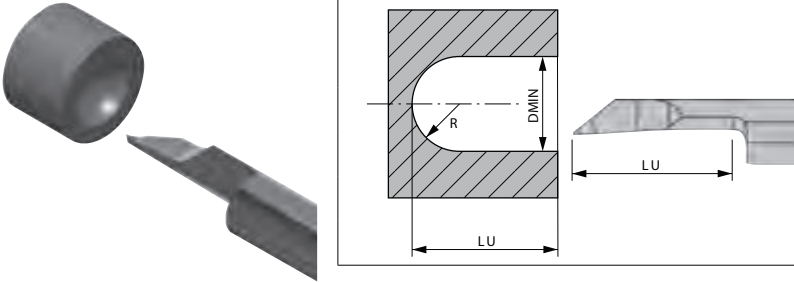

		mm		
Description		DMIN	R	LU
EZVBR	035030-010	3.5	1.75	8
EZVBR	045040-010	4.5	2.25	10
EZVBR	055050-010	5.5	2.75	12
EZVBR	065060-010	6.5	3.25	14

2. Application

Case with no existing hole

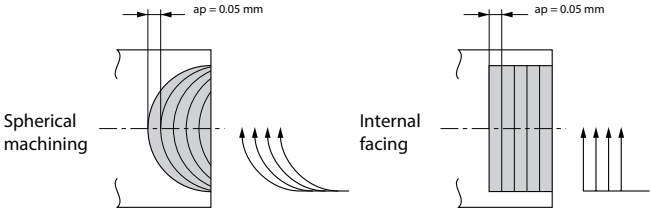

Note: f shall be under 0.03 mm/rev at internal facing.

Finishing

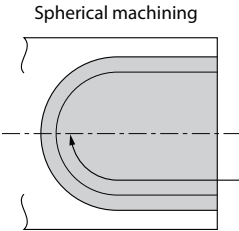

Case with drilled hole

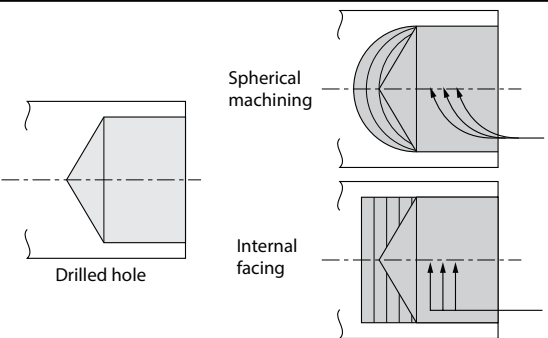

Note: f shall be under 0.03 mm/rev at internal facing.

Finishing

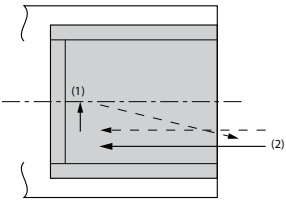

Machining process
 1. Finish the internal face first.
 2. Next, finish the internal diameter.

3. Caution

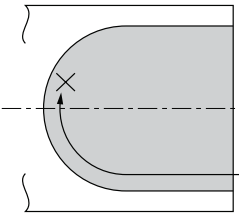

When machining past the center of the workpiece, insert may break.

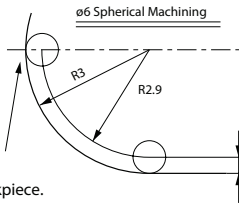

Fix the insert edge at the center of the workpiece.

Adjust the machining program to radius minus the value of RE.

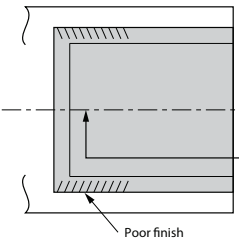

This type of machining is possible, but the chips might scratch the surface.

Poor finish

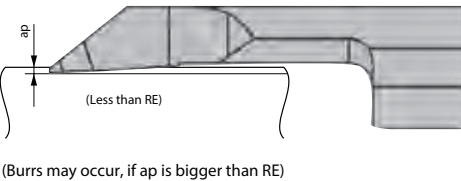

For internal profiling, ap should be less than the value of RE.

(Less than RE)

(Burrs may occur, if ap is bigger than RE)

EZBT (Back boring)

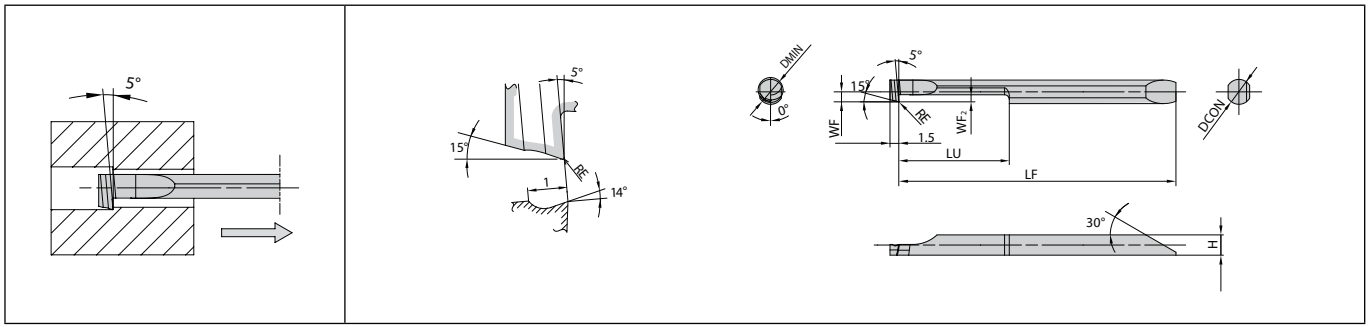

Right-hand shown

F

Dimensions

Description	No. of edges	Dimension (mm)								Tolerance (mm)			Carbide		Applicable sleeve ● F39 ● F41 ● F43
		DMIN	DCON	H	LF	LU	WF	WF ₂	RE	RE min.	RE max.	PVD	-		
												PR1225	GW05		
												R	R		
EZBTR 040040-005	1	4	4	3.45	47.2	18.5	1.7	1.2	0.05	-0.02	0	●	●	EZH040...	
EZBTR 050050-005	1	5	5	4.3	57.2	23.5	2.15	1.5	0.05	-0.02	0	●	●	EZH050...	

Boring

Solid

Positive

AD bars

Negative

Recommended Cutting Conditions

Workpiece Material	Insert Grades (Cutting Speed Vc: m/min)		EZBTR040040-005		EZBTR050050-005		Remarks
	MEGACOAT	Carbide	ap (mm), f (mm/rev)				
	PR1225	GW05	ap	f	ap	f	
Carbon Steel / Alloy Steel	★ 30-100	-	~0.45	~0.07	~0.5	~0.1	Coolant
Stainless Steel	★ 30-80	-	~0.45	~0.05	~0.5	~0.07	
Non-ferrous Metals	-	★ 30-100	~0.45	~0.1	~0.5	~0.15	

★ : 1st Recommendation

● : Standard item R : Right-hand only L : Left-hand only □ : Check availability

EZ bars are sold in 1 piece boxes

F30

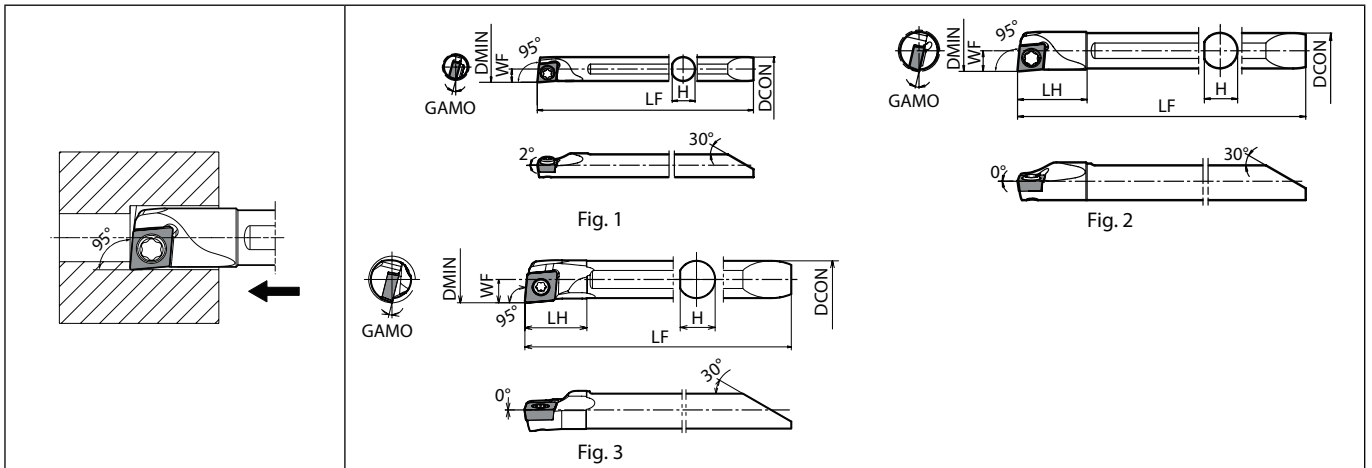

S-SCLC-EZP Steel shank bar (Boring)



Right-hand shown | Left-hand Insert for Right-hand Toolholder. | Max. Overhang Length L/D≈~3



Toolholder dimensions

Description	Availability	Dimension (mm)							GAMO (°)	Standard corner-R(RE)	Coolant hole	Fig.	Spare parts		Applicable inserts	Applicable sleeves ● F39 F41 F43
		R	DMIN	DCON	H	LH	LF	WF					Screw	Wrench		
																
S045X- SCLCR03-050EZP	●	5	4.5	4.3	-	42.4	2.5	15	0.2	No	1			CC□T0301... CC□W0301...	EZH045... EZH050...	
S050X- SCLCR03-060EZP	●	6	5	4.7	9	48.4	3	13	0.2	No	2	SB-1635TR	FT-6	CC□T0401... CC□W0401...	EZH060... EZH070...	
S060X- SCLCR04-070EZP	●	7	6	5.7	10	54.4	3.5	13	0.2	No	2	SB-2035TR	FT-6	CC□T0602... CC□W0602...	EZH080...	
S070X- SCLCR04-080EZP	●	8	7	6.7	10.3	60.4	4	11	0.4	No	3	SB-2545TR	FT-8			
S080X- SCLCR06-100EZP	●	10	8	7.5	13.3	69.5	5	14								

● : Standard item R : Right-hand only L : Left-hand only □ : Check availability

C-SCLC-EZP Carbide shank bar (Boring)

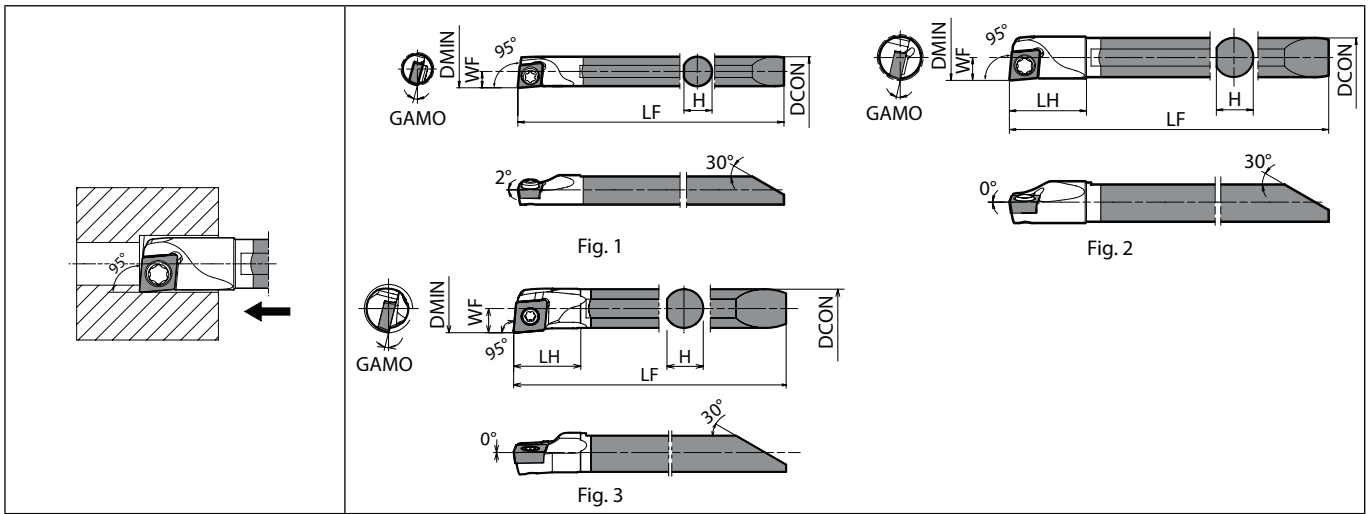

Right-hand shown | Left-hand Insert for Right-hand Toolholder. | Max. Overhang Length L/D≈~5

F

Boring

Toolholder dimensions

Description	Availability	Dimension (mm)							GAMO (°)	Standard corner-R(RE)	Coolant hole	Fig.	Spare parts		Applicable inserts	Applicable sleeves F39 F41 F43
		R	DMIN	DCON	H	LH	LF	WF					Screw	Wrench		
		Icon		Icon												
C045X- SCLCR03-050EZP	●	5	4.5	4.3	-	51.4	2.5	15	0.2	No	1	SB-1635TR	FT-6	CC□T0301... CC□W0301...	EZH045... EZH050...	
C050X SCLCR03-060EZP	●	6	5	4.7	9	58.4	3	13	0.2	No	2	SB-1635TR	FT-6	CC□T0401... CC□W0401...	EZH060... EZH070...	
C060X- SCLCR04-070EZP	●	7	6	5.7	10	66.4	3.5	13	0.2	No	2	SB-2035TR	FT-6	CC□T0602... CC□W0602...	EZH080...	
C070X SCLCR04-080EZP	●	8	7	6.7	10.3	74.4	4	11	0.4	No	3	SB-2545TR	FT-8			
C080X- SCLCR06-100EZP	●	10	8	7.5	13.3	85.5	5	14	0.4	No	3	SB-2545TR	FT-8			

Applicable inserts (S-SCLC-EZP / C- SCLC-EZP)

Applications	Minute ap	Finishing	Finishing	Finishing	Finishing	Finishing	Finishing - Medium	Finishing
Insert								
Chip Breaker Type	CF	PF	GF	SKS	SK	CK	GQ	WP
Page	B58	B58	B58	B59	B59	B59	B59	B60
Applications	Finishing	Finishing - Medium	Finishing - Medium	Medium	Medium	Finishing	Finishing	Low feed
Insert								
Chip Breaker Type	PP	GK	HQ	STD	MF	L-F	L-FSF	L-U
Page	B60	B60	B60	B60	B61	B62	B61	B63~B65
Applications	Low feed	Low feed	Cast iron	Non-Ferrous Metals	Non-Ferrous Metals	Hard materials		
Insert								
Chip Breaker Type	L-USF	L-J	No CB	AP	PCD	CBN		
Page	B63	B65	B66	B66	C39	C20		

Recommended cutting conditions F152, F153

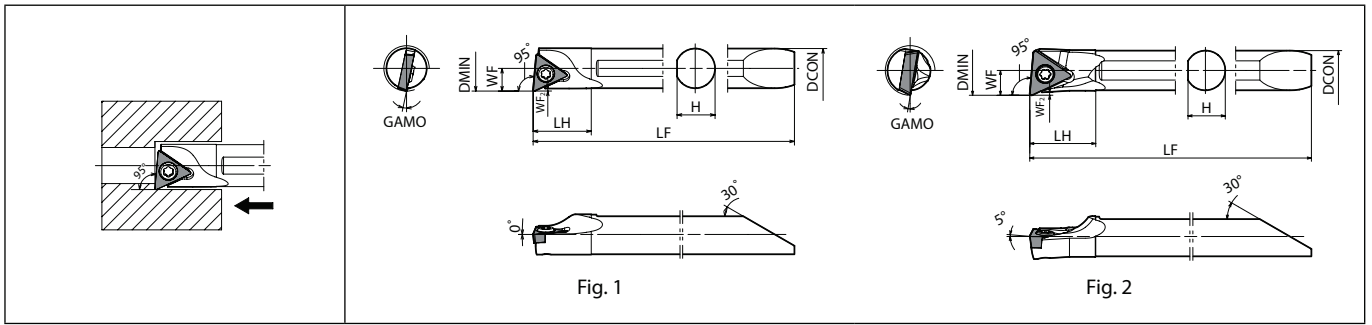

● : Standard item R : Right-hand only L : Left-hand only □ : Check availability

S-STLB(P)-EZP Steel shank bar (Boring)



Right-hand shown | Left-hand Insert for Right-hand Toolholder. | Max. Overhang Length L/D≈~3

Toolholder dimensions

Description	Availability	Dimension (mm)								GAMO (°)	Standard corner-R(RE)	Coolant hole	Fig.	Spare parts		Applicable inserts	Applicable sleeves ● F39 F41 F43
		R	DMIN	DCON	H	LH	LF	WF	WF ₂					Screw	Wrench		
																	
S070X- STLBR06-080EZP	●	8	7	6.7	10.3	60.4	4	0.4	12	0.2	No	1	SB-2035TR	FT-6	TB□T0601... TB□W0601...	EZH070...	
S080X- STLPR09-100EZP	●	10	8	7.5	13.3	69.5	5	0.5	10	0.4	No	2	SB-2545TR	FT-8	TP□B0902..., TP□H0902... TP□T0902..., TP□X0902...	EZH080...	

TB□□060108.. type inserts can not be used.

Use Right-handed P Chipbreaker

For WP chipbreaker, cutting edge offsets or program corrections are required on **R36** and **R37**.



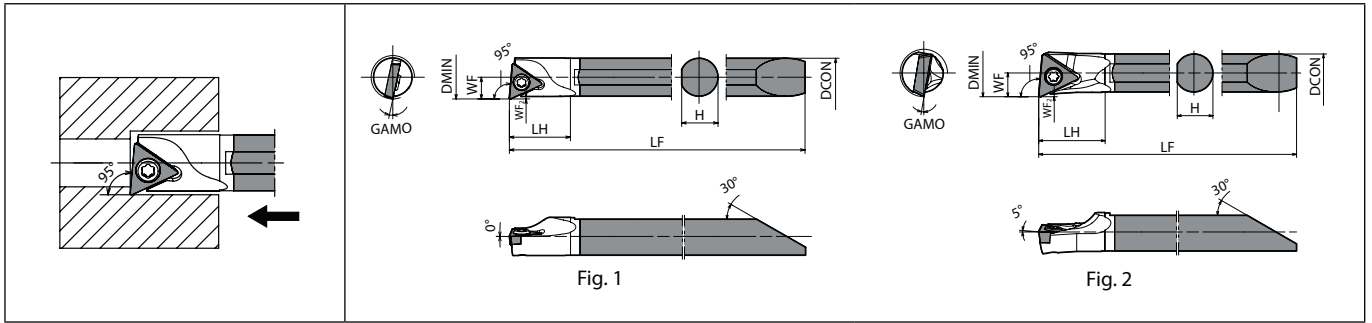

C-STLB(P)-EZP Carbide shank bar (Boring)



Right-hand shown | Left-hand Insert for Right-hand Toolholder. | Max. Overhang Length L/D≈5

F

Toolholder dimensions

Description	Availability	Dimension (mm)								GAMO (°)	Standard corner-R(RE)	Coolant hole	Fig.	Spare parts		Applicable inserts	Applicable sleeves ● F39 F41 F43
		R	DMIN	DCON	H	LH	LF	WF	WF ₂					Screw	Wrench		
																	
C070X- STLBR06-080EZP	●	8	7	6.7	11	74.4	4	0.4	12	0.2	No	1	SB-2035TR	FT-6	TB□T0601... TB□W0601...	EZH070...	
C080X- STLPR09-100EZP	●	10	8	7.5	14	85.5	5	0.5	10	0.4	No	2	SB-2545TR	FT-8	TP□B0902..., TP□H0902... TP□T0902..., TP□X0902...	EZH080...	













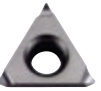

TB□□060108.. type inserts can not be used.

Use Right-handed P Chipbreaker

For WP chipbreaker, cutting edge offsets or program corrections are required on R36 and R37.

● : Standard item R : Right-hand only L : Left-hand only □ : Check availability

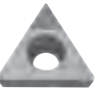
Applicable inserts (S-STLB(P)-EZP / C-STLB(P)-EZP)

Applications	Minute ap	Finishing	Finishing	Finishing	Finishing	Finishing	Finishing	Finishing - Medium
Insert								
Chip Breaker Type	CF	PF	WP	PP	R-P	GP	DP	HQ
Page	B84, B88	B84, B88	B88	B88	B92	B89	B84	B89
Applications	Finishing	Medium	Low carbon steel	Cast iron	Non-Ferrous Metals	Non-Ferrous Metals	Hard materials	
Insert								
Chip Breaker Type	L	L-H	XP	No CB	AP	PCD	CBN	
Page	B84, B90, B91	B93	B89	B84, B94	B94	C44, C46, C47	C23	

Recommended cutting conditions  F152, F153



Boring

S-SWUB-EZP Steel shank bar (Boring)

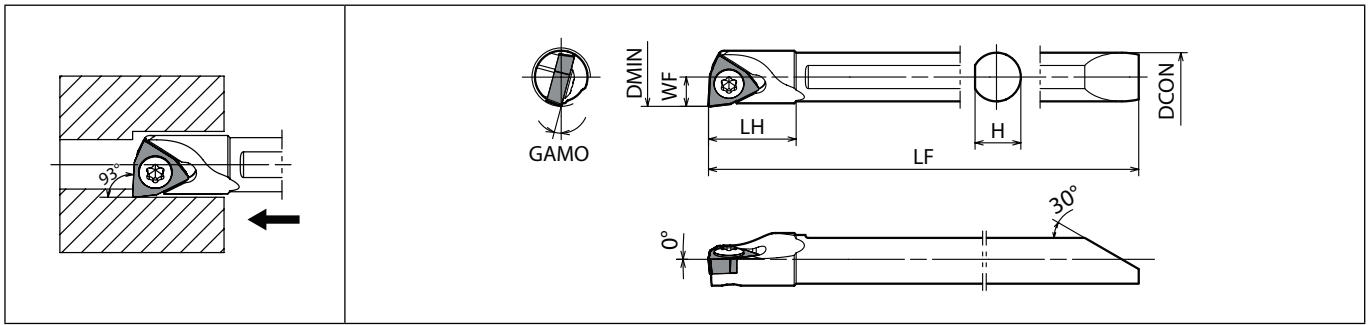

Right-hand shown | Left-hand Insert for Right-hand Toolholder. | Max. Overhang Length L/D≈3

F

Toolholder dimensions

Description	Availability		Dimension (mm)							GAMO (°)	Standard corner-R(RE)	Coolant hole	Spare parts		Applicable inserts	Applicable sleeves F39 F41 F43
	R	DMIN	DCON	H	LH	LF	WF	Screw	Wrench							
S050X- SWUBR06-060EZP	●	6	5	4.7	9	48.4	3	15	0.2	No	SB-2035TR	FT-6	WB-T0601... WB-W0601...	EZH050...		
S060X- SWUBR06-070EZP	●	7	6	5.7	10	54.4	3.5	13					WB-T0802..., WB-W0802...	EZH060...		
S070X- SWUBR08-080EZP	●	8	7	6.7	10.3	60.4	4	15	0.2	No	SB-2035TR	FT-6	WB-T0802..., WB-W0802...	EZH070...		

C-SWUB-EZP Carbide shank bar (Boring)

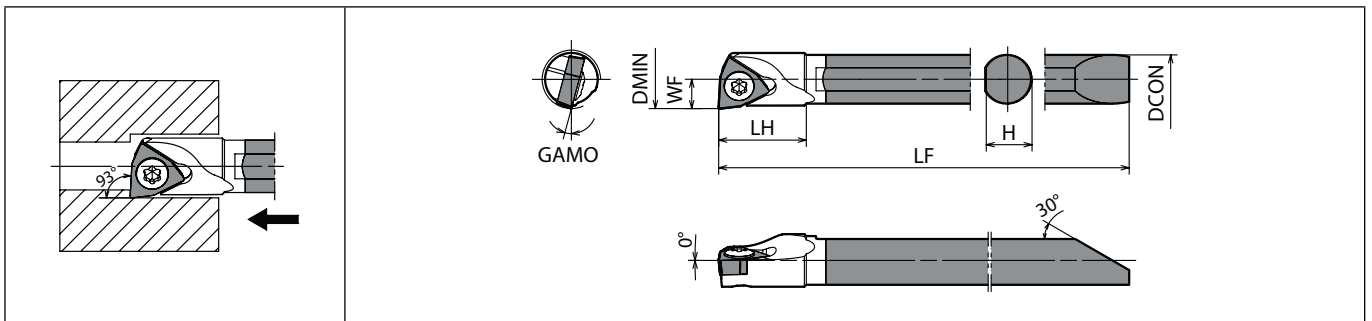

Right-hand shown | Left-hand Insert for Right-hand Toolholder. | Max. Overhang Length L/D≈5

Toolholder dimensions

Description	Availability		Dimension (mm)							GAMO (°)	Standard corner-R(RE)	Coolant hole	Spare parts		Applicable inserts	Applicable sleeves F39 F41 F43
	R	DMIN	DCON	H	LH	LF	WF	Screw	Wrench							
C050X- SWUBR06-060EZP	●	6	5	4.7	9	58.4	3	15	0.2	No	SB-2035TR	FT-6	WB-T0601... WB-W0601...	EZH050...		
C060X- SWUBR06-070EZP	●	7	6	5.7	10	66.4	3.5	13					WB-T0802..., WB-W0802...	EZH060...		
C070X- SWUBR08-080EZP	●	8	7	6.7	11	74.4	4	15	0.2	No	SB-2035TR	FT-6	WB-T0802..., WB-W0802...	EZH070...		

● : Standard item R : Right-hand only L : Left-hand only □ : Check availability

Applicable inserts (S-SWUB-EZP / C-SWUB-EZP)

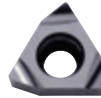
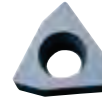
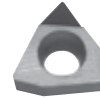
Applications	Minute ap	Finishing	Finishing	Finishing	Finishing	Cast iron	Non-Ferrous Metals	Hard materials
Insert								
Chip Breaker Type	L-CF	L-PF	L-DP	L-P	L-F	No CB	PCD	CBN
Page	B105	B105	B105	B106	B106	B106	C51	C28

Recommended cutting conditions  F152, F153

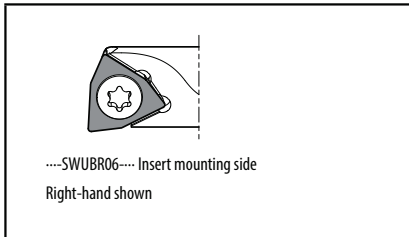

How to mount EZ Bars

How to use adjustment pin (Fig. 1)

1. Put the adjustment pin into the hole.
2. Push it into the sleeve, using the wrench (LW-1.5).
3. Tightening the clamp screw (HS3X4P) with wrench (LW-1.5) to fix the adjustment pin.

How to fix bar (Fig. 2)

1. With the chip pocket upward, set the bar into the sleeve. Press the slant of the end of the bar with the adjustment pin. Make sure that the bar does not move (Fig. 3)
2. Tighten the clamp screw with wrench (LW-2) and fix the bar. Use LW-1.5 if shank dia. is 3 mm or less.



Fig. 1
How to use adjustment pin

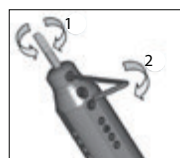

Fig. 2
How to fix bar

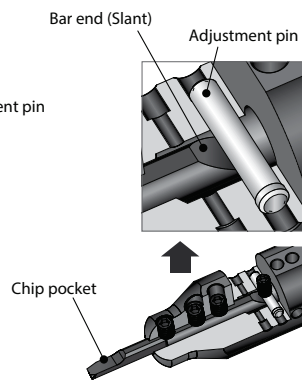
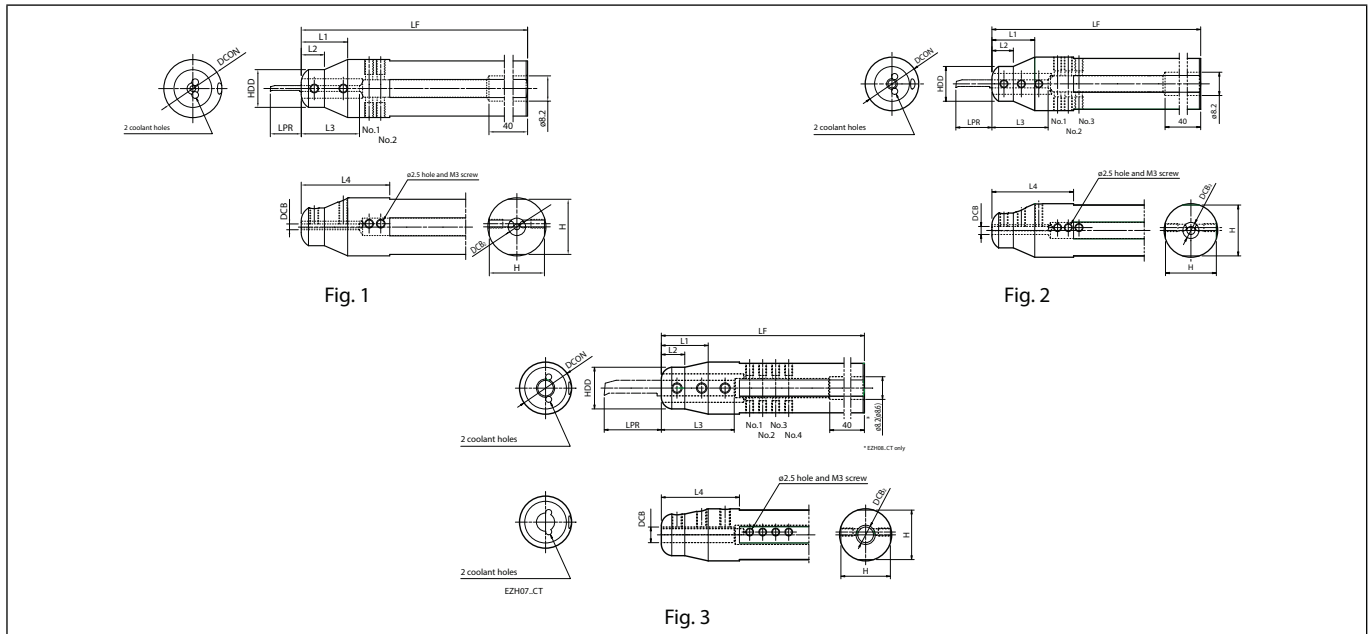

Fig. 3: Fixed bar

EZH-CT (Adjustable with coolant hole)



Sleeve dimensions

Description	Availability	Dimension (mm)											Fig.	Applicable EZ bars ● F16~F26, F28 ● G71 ● J40		
		DCB	DCB2	DCON	H	HDD	LF	L1	L2	L3	L4	LPR				
												No.1			No.2	No.3
EZH 01719CT-120	●	1.7	6	19.05	18	13	120	16	8	16	30.5	7.5	3.5	-	1	EZBR...017...
EZH 01720CT-120	●			20	19		135				30.5					
EZH 01722CT-135	●			22	21		120				30.5					
EZH 01725.0CT-135	●			25	24		135				30.5					
EZH 01725.4CT-120	●			25.4	24.4		120				30.5					
EZH 02019CT-120	●	2	6	19.05	18	13	120	16	8	20	30.5	8.5	4.5	-	1	EZB [®] /L...020... EZBPR...020...
EZH 02020CT-120	●			20	19		135				30.5					
EZH 02022CT-135	●			22	21		120				30.5					
EZH 02025.0CT-135	●			25	24		135				30.5					
EZH 02025.4CT-120	●			25.4	24.4		120				30.5					
EZH 02519CT-120	●	2.5	6	19.05	18	13	120	16	8	20	30.5	11	7	-	1	EZB [®] /L...025... EZTR...025...
EZH 02520CT-120	●			20	19		135				30.5					
EZH 02522CT-135	●			22	21		120				30.5					
EZH 02525.0CT-135	●			25	24		135				30.5					
EZH 02525.4CT-120	●			25.4	24.4		120				30.5					
EZH 03019CT-120	●	3	6	19.05	18	13	120	16	8	21	30.5	13.5	9.5	5.5	2	EZB [®] /L...030... EZBFR...030... EZBPR...030... EZVBR...030... EZGR...030... EZTR...030...
EZH 03020CT-120	●			20	19		135				30.5					
EZH 03022CT-135	●			22	21		120				30.5					
EZH 03025.0CT-135	●			25	24		135				30.5					
EZH 03025.4CT-120	●			25.4	24.4		120				30.5					
EZH 03519CT-120	●	3.5	6	19.05	18	13	120	16	8	21	31.1	15.5	11.5	7.5	2	EZB [®] /L...035... EZTR...035...
EZH 03520CT-120	●			20	19		135				31.1					
EZH 03522CT-135	●			22	21		120				31.1					
EZH 03525.0CT-135	●			25	24		135				31.1					
EZH 03525.4CT-120	●			25.4	24.4		120				31.1					

L3 shows DCB length.

LPR shows overhang length of the EZB Bar when attached to sleeve.

Choose sleeves (DCB) to meet with DCON dimension of bar.

A hole on the rear end of sleeve is prepared hole for Rc1/8 threading. Please modify by additional processing if necessary. The body hardness is 42HRC.

For how to fix EZ Bars (EZH-CT sleeve), please refer to F8.

● : Standard item R : Right-hand only L : Left-hand only □ : Check availability

Sleeve dimensions

Description	Availability	Dimension (mm)													Fig.	Applicable EZ bars ● F16~F36 ● G71, G103 ● J40	
		DCB	DCB2	DCON	H	HDD	LF	L1	L2	L3	L4	LPR					
												No.1	No.2	No.3			No.4
EZH 04019CT-120 04020CT-120 04022CT-135 04025.0CT-135 04025.4CT-120	● ● ● ● ●	4	6	19.05 20 22 25 25.4	18 19 21 24 24.4	13	120 135 120	16	8	22	32.7 41.5 32.7	20.5	16.5	12.5	8.5	3	EZB%L...040..., EZBFR...040... EZBPR...040..., EZVBR...040... EZBTR...040..., EZG%L...040... EZFG%L...040..., EZTR...040...
EZH 04519CT-120 04520CT-120 04522CT-135 04525.0CT-135 04525.4CT-120	● ● ● ● ●	4.5	6	19.05 20 22 25 25.4	18 19 21 24 24.4	16	120 135 120	18	9	23	30 44 30	23 (14)	18.5 (9.5)	14 (-)	9.5 (-)	3	EZB%L...045... _045X...-050EZP
EZH 05019CT-120 05020CT-120 05022CT-135 05025.0CT-135 05025.4CT-120	● ● ● ● ●	5	6	19.05 20 22 25 25.4	18 19 21 24 24.4	16	120 135 120	18	9	26	30 44 30	25.5 (15.5)	20.5 (10.5)	15.5 (-)	10.5 (-)	3	EZB%L...050..., EZBFR...050... EZBPR...050..., EZBCR...050... EZVBR...050..., EZBTR...050... _050X...-060EZP, EZG%L...050... EZFG%L...050..., EZTR...050...
EZH 06019CT-120 06020CT-120 06022CT-135 06025.0CT-135 06025.4CT-120	● ● ● ● ●	6	7.4	19.05 20 22 25 25.4	18 19 21 24 24.4	16	120 135 120	18	9	28	30 41.5 30	30.5 (18.5)	25.5 (13.5)	20.5 (-)	15.5 (-)	3	EZB%L...060..., EZBFR...060... EZBPR...060..., EZBCR...060... EZVBR...060..., _060X...-070EZP EZG%L...060..., EZTR...060...
EZH 07019CT-120 07020CT-120 07022CT-135 07025.0CT-135 07025.4CT-120	● ● ● ● ●	7	7.4	19.05 20 22 25 25.4	18 19 21 24 24.4	16	120 135 120	18	9	29	30 44 30	35.5 (21.5)	30.5 (16.5)	25.5 (11.5)	20.5 (-)	3	EZB%L...070..., EZBCR...070... _070X...-080EZP, EZG%L...070... EZFG%L...070..., EZTR...070...
EZH 08019CT-120 08020CT-120 08022CT-135 08025.0CT-135 08025.4CT-120	● ● ● ● ●	8	8.6	19.05 20 22 25 25.4	18 19 21 24 24.4	16	120 135 120	18	9	33	34 44 34	40.5 (24.5)	35.5 (19.5)	30.5 (14.5)	25.5 (-)	3	EZB%L...080... _080X...-100EZP

L3 shows DCB length.

LPR shows overhang length of the EZ Bar when attached to sleeve. () value indicates the overhang length when installed the steel boring bar (EZ Bar PLUS).

Choose sleeves (DCB) to meet with DCON dimension of bar.

A hole on the rear end of sleeve is prepared hole for Rc1/8 threading. Please modify by additional processing if necessary. The body hardness is 42HRC.

For how to fix EZ Bars (EZH-CT sleeve), please refer to **F8**.

Spare Parts Description (for EZH-CT Sleeves)

Description	Spare Parts				
	Adjustment Pin	Clamp Screw (for adjustment pin)	Wrench	Clamp Screw (for bar)	Wrench
EZH 017...CT-... 020...CT-... 025...CT-... 030...CT-...	LCP025097	HS3X4P (for adjustment pin and liquid leak prevention)	LW-1.5 Tightening Torque 1N·m	HS3X4P	LW-1.5 Tightening Torque 1N·m
EZH 035...CT-... 040...CT-... 045...CT-... 050...CT-... 060...CT-... 070...CT-...	LCP025097	HS3X4P (for adjustment pin and liquid leak prevention)	LW-1.5 Tightening Torque 1N·m	HS4X4P (for bar)	LW-2 Tightening Torque 2N·m
EZH 080...CT-...	LCP025110	HS3X3P (for adjustment pin and liquid leak prevention)			

1) If shank dia. is ø2.5mm or less, use clamp screw (HS3X4P)

2) If shank dia. is ø3mm, use clamp screw (HS3X4P)

- For adjustment pin 2 pcs
- For liquid leak prevention 2 pcs
- For EZ Bar 2 pcs

- For adjustment pin 2 pcs
- For liquid leak prevention 4 pcs
- For EZ Bar 3 pcs

● : Standard item R : Right-hand only L : Left-hand only □ : Check availability

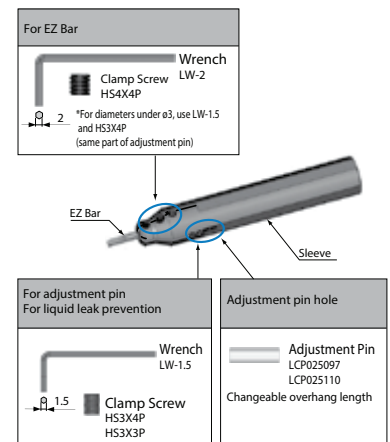

EZH-HP (Adjustable)

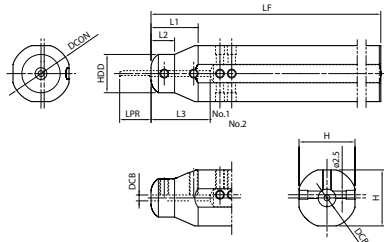

Fig. 1

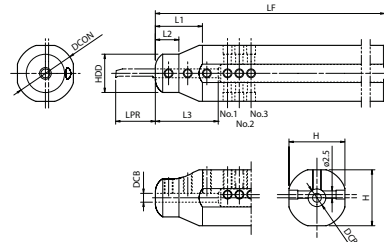

Fig. 2

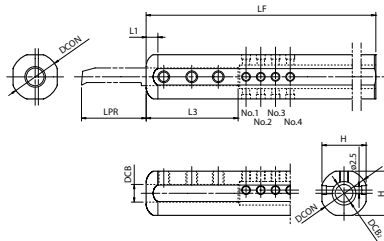

Fig. 3

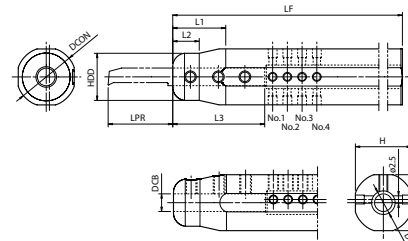

Fig. 4

F

Boring

Sleeve dimensions

Description	Availability	Dimension (mm)											Fig.	Applicable EZ bars ● F16~F26, F28 ● G71 ● J40			
		DCB	DCB2	DCON	H	HDD	LF	L1	L2	L3	LPR						
											No.1	No.2			No.3	No.4	
EZH 01716HP-100	●	1.7	6	16	15	13	100	16	8	16	7.5	3.5	-	-	1	EZBR...017...	
EZH 01719HP-120	●			19.05	18												120
EZH 01720HP-120	●			20	19												135
EZH 01722HP-135	●			22	21												120
EZH 01725.0HP-135	●			25	24												135
EZH 01725.4HP-120	●			25.4	24.4												120
EZH 02016HP-100	●	2	6	16	15	13	100	16	8	20	8.5	4.5	-	-	1	EZB [®] /L...020... EZBPR...020...	
EZH 02019HP-120	●			19.05	18												120
EZH 02020HP-120	●			20	19												135
EZH 02022HP-135	●			22	21												120
EZH 02025.0HP-135	●			25	24												135
EZH 02025.4HP-120	●			25.4	24.4												120
EZH 02516HP-100	●	2.5	6	16	15	13	100	16	8	20	11	7	-	-	1	EZB [®] /L...025... EZTR...025...	
EZH 02519HP-120	●			19.05	18												120
EZH 02520HP-120	●			20	19												135
EZH 02522HP-135	●			22	21												120
EZH 02525.0HP-135	●			25	24												135
EZH 02525.4HP-120	●			25.4	24.4												120
EZH 03016HP-100	●	3	6	16	15	13	100	16	8	21	13.5	9.5	5.5	-	2	EZB [®] /L...030... EZBFR...030... EZBPR...030... EZVBR...030... EZGR...030... EZTR...030...	
EZH 03019HP-120	●			19.05	18												120
EZH 03020HP-120	●			20	19												135
EZH 03022HP-135	●			22	21												120
EZH 03025.0HP-135	●			25	24												135
EZH 03025.4HP-120	●			25.4	24.4												120
EZH 03516HP-100	●	3.5	6	16	15	13	100	16	8	22	15.5	11.5	7.5	-	2	EZB [®] /L...035... EZTR...035...	
EZH 03519HP-120	●			19.05	18												120
EZH 03520HP-120	●			20	19												135
EZH 03522HP-135	●			22	21												120
EZH 03525.0HP-135	●			25	24												135
EZH 03525.4HP-120	●			25.4	24.4												120

L3 shows DCB length.

LPR shows overhang length of the EZB Bar when attached to sleeve.

Choose sleeves (DCB) to meet with DCON dimension of bar.

For how to fix EZ Bars (EZH-HP sleeve), please refer to F37.

● : Standard item R : Right-hand only L : Left-hand only □ : Check availability

Sleeve dimensions

Description	Availability	Dimension (mm)											Fig.	Applicable EZ bars ● F16~F36 ● G71, G103 ● J40		
		DCB	DCB2	DCON	H	HDD	LF	L1	L2	L3	LPR					
											No.1	No.2			No.3	No.4
EZH 04016HP-100 04019HP-120 04020HP-120 04022HP-135 04025.0HP-135 04025.4HP-120	● ● ● ● ● ●	4	6	16 19.05 20 22 25 25.4	15 18 19 21 24 24.4	100 120 135 120	16	8	24	20.5	16.5	12.5	8.5	4	EZB%L...040..., EZBFR...040... EZBPR...040..., EZVBR...040... EZBTR...040..., EZG%L...040... EZFG%L...040..., EZTR...040...	
EZH 04516HP-100 04519HP-120 04520HP-120 04522HP-135 04525.0HP-135 04525.4HP-120	● ● ● ● ● ●	4.5	6	16 19.05 20 22 25 25.4	15 18 19 21 24 24.4	100 120 135 120	18	9	25.3	23 (14)	18.5 (9.5)	14 (-)	9.5 (-)	3 4	EZB%L...045... _045X...-050EZP	
EZH 05016HP-100 05019HP-120 05020HP-120 05022HP-135 05025.0HP-135 05025.4HP-120	● ● ● ● ● ●	5	6	16 19.05 20 22 25 25.4	15 18 19 21 24 24.4	100 120 135 120	18	9	29	25.5 (15.5)	20.5 (10.5)	15.5 (-)	10.5 (-)	3 4	EZB%L...050..., EZBFR...050... EZBPR...050..., EZBCR...050... EZVBR...050..., EZBTR...050... _050X...-060EZP, EZG%L...050... EZFG%L...050..., EZTR...050...	
EZH 06016HP-100 06019HP-120 06020HP-120 06022HP-135 06025.0HP-135 06025.4HP-120	● ● ● ● ● ●	6	8	16 19.05 20 22 25 25.4	15 18 19 21 24 24.4	100 120 135 120	18	9	31	30.5 (18.5)	25.5 (13.5)	20.5 (-)	15.5 (-)	3 4	EZB%L...060..., EZBFR...060... EZBPR...060..., EZBCR...060... EZVBR...060..., _060X...-070EZP EZG%L...060..., EZTR...060...	
EZH 07016HP-100 07019HP-120 07020HP-120 07022HP-135 07025.0HP-135 07025.4HP-120	● ● ● ● ● ●	7	8	16 19.05 20 22 25 25.4	15 18 19 21 24 24.4	100 120 135 120	18	9	33	35.5 (21.5)	30.5 (16.5)	25.5 (11.5)	20.5 (-)	3 4	EZB%L...070..., EZBCR...070... _070X...-080EZP, EZG%L...070... EZFG%L...070..., EZTR...070...	
EZH 08019HP-120 08020HP-120 08022HP-135 08025.0HP-135 08025.4HP-120	● ● ● ● ●	8	8.4	19.05 20 22 25 25.4	18 19 21 24 24.4	120 135 120	18	9	37	40.5 (24.5)	35.5 (19.5)	30.5 (14.5)	25.5 (-)	4	EZB%L...080... _080X...-100EZP	

L3 shows DCB length.

LPR shows overhang length of the EZB Bar when attached to sleeve. () value indicates the overhang length when installed the steel boring bar (EZ Bar PLUS).

Choose sleeves (DCB) to meet with DCON dimension of bar.

For how to fix EZ Bars (EZH-HP sleeve), please refer to F37.

Spare Parts Description (for EZH-HP Sleeves)

Description	Spare Parts					Applicable EZ Bars EZ Bar PLUS
	Adjustment Pin	Clamp Screw (for Adjustment Pin)	Wrench	Clamp Screw (for Bar)	Wrench	
EZH 017...HP-... 020...HP-... 025...HP-... 030...HP-...	LCP025140	HS3X4P (for both Adjustment Pin and Bar)	LW-1.5 Tightening Torque 1N-m	HS3X4P	LW-1.5 Tightening Torque 1N-m	EZBR...017...
EZB%L...020...						EZ_R...020-...
EZB%L...025...						EZ_R...025-...
EZB%L...030...						EZ_R...030-...
EZH 035...HP-... 040...HP-... 045...HP-... 050...HP-... 060...HP-... 070...HP-... 080...HP-...	LCP025140	HS3X4P	LW-1.5 Tightening Torque 1N-m	HS4X4P	LW-2 Tightening Torque 2N-m	EZB%L...035...
EZB%L...040...						EZ_R...040-...
EZB%L...045...						_045X...-050EZP
EZB%L...050...						EZ_R...050-...
EZB%L...060...						EZ_R...060-...
EZB%L...070...						EZ_R...070-...
EZB%L...080...						_080X...-100EZP

● : Standard item R : Right-hand only L : Left-hand only □ : Check availability



EZH-ST (Not-adjustable)

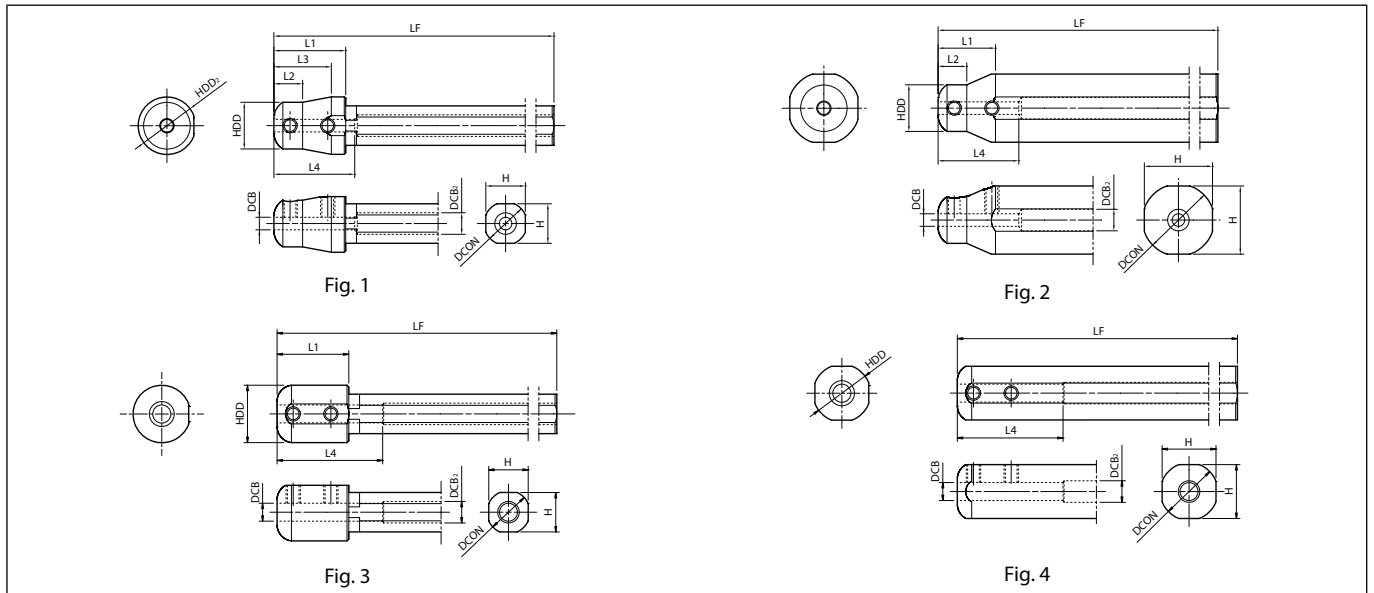

Sleeve dimensions

Description	Availability	Dimension (mm)											Fig.	Applicable EZ bars ● F16~F26, F28 ● G71 ● J40
		DCB	DCB2	DCON	H	HDD	HDD2	LF	L1	L2	L3	L4		
EZH 01712ST-80 01716ST-100 01719ST-120 01720ST-120 01722ST-135 01725.0ST-135 01725.4ST-120	●	1.7	6	12	11	13	16	80	20	8	16	16	1	EZBR...017...
	●			16	15			100						
	●			19.05	18			120						
	●			20	19			135						
	●			22	21			120						
	●			25	24			120						
EZH 02012ST-80 02016ST-100 02019ST-120 02020ST-120 02022ST-135 02025.0ST-135 02025.4ST-120	●	2	6	12	11	13	16	80	20	8	16	20	2	EZB [®] ...020... EZBPR...020...
	●			16	15			100						
	●			19.05	18			120						
	●			20	19			135						
	●			22	21			120						
	●			25	24			120						
EZH 02512ST-80 02516ST-100 02519ST-120 02520ST-120 02522ST-135 02525.0ST-135 02525.4ST-120	●	2.5	6	12	11	13	16	80	20	8	16	20	2	EZB [®] ...025... EZTR...025...
	●			16	15			100						
	●			19.05	18			120						
	●			20	19			135						
	●			22	21			120						
	●			25	24			120						
EZH 03012ST-80 03016ST-100 03019ST-120 03020ST-120 03022ST-135 03025.0ST-135 03025.4ST-120	●	3	6	12	11	13	16	80	20	8	16	21	2	EZB [®] ...030... EZBFR...030... EZBPR...030... EZVBR...030... EZGR...030... EZTR...030...
	●			16	15			100						
	●			19.05	18			120						
	●			20	19			135						
	●			22	21			120						
	●			25	24			120						

L4 shows DCB length.
 Choose sleeves (DCB) to meet with DCON dimension of bar.
 Adjustment pin cannot be installed to EZH-ST sleeves. To adjust overhang of the bar, please use EZH-CT / HP sleeves.

● : Standard item R : Right-hand only L : Left-hand only □ : Check availability

Sleeve dimensions

Description	Availability	Dimension (mm)											Fig.	Applicable EZ bars ● F16~F36 ● G71, G103 ● J40	
		DCB	DCB2	D/CON	H	HDD	HDD2	LF	L1	L2	L3	L4			
EZH 03512ST-80 03516ST-100 03519ST-120 03520ST-120 03522ST-135 03525.0ST-135 03525.4ST-120	●	3.5	6	12	11	13	-	16	80	20	16	-	22	1	EZB [®] /L...035... EZTR...035...
	●			16	15			100							
	●			19.05	18			120							
	●			20	19			16	8						
	●			22	21			135							
	●			25	24			120							
EZH 04012ST-80 04016ST-100 04019ST-120 04020ST-120 04022ST-135 04025.0ST-135 04025.4ST-120	●	4	6	12	11	13	-	16	80	20	16	-	24	2	EZB [®] /L...040..., EZBFR...040... EZBPR...040..., EZVBR...040... EZBTR...040..., EZG [®] /L...040... EZFG [®] /L...040..., EZTR...040...
	●			16	15			100							
	●			19.05	18			120							
	●			20	19			16	8						
	●			22	21			135							
	●			25	24			120							
EZH 05012ST-80 05016ST-100 05019ST-120 05020ST-120 05022ST-135 05025.0ST-135 05025.4ST-120	●	5	6	12	11	16	-	80	20	-	-	-	29	3	EZB [®] /L...050..., EZBFR...050... EZBPR...050..., EZBCR...050... EZVBR...050..., EZBTR...050... _050X...-060EZP, EZG [®] /L...050... EZFG [®] /L...050..., EZTR...050...
	●			16	15			100	-	4					
	●			19.05	18			120							
	●			20	19			18	9	2					
	●			22	21			135							
	●			25	24			120							
EZH 06012ST-80 06016ST-100 06019ST-120 06020ST-120 06022ST-135 06025.0ST-135 06025.4ST-120	●	6	8	12	11	16	-	80	20	-	-	-	31	3	EZB [®] /L...060..., EZBFR...060... EZBPR...060..., EZBCR...060... EZVBR...060..., _060X...-070EZP EZG [®] /L...060..., EZTR...060...
	●			16	15			100	-	4					
	●			19.05	18			120							
	●			20	19			18	9	2					
	●			22	21			135							
	●			25	24			120							
EZH 07012ST-80 07016ST-100 07019ST-120 07020ST-120 07022ST-135 07025.0ST-135 07025.4ST-120	●	7	8	12	11	16	-	80	20	-	-	-	33	3	EZB [®] /L...070..., EZBCR...070... _070X...-080EZP, EZG [®] /L...070... EZFG [®] /L...070..., EZTR...070...
	●			16	15			100	-	4					
	●			19.05	18			120							
	●			20	19			18	9	2					
	●			22	21			135							
	●			25	24			120							
EZH 08016ST-100 08019ST-120 08020ST-120 08022ST-135 08025.0ST-135 08025.4ST-120	●	8	8.4	16	15	16	-	100	-	-	-	-	37	4	EZB [®] /L...080... _080X...-100EZP
	●			19.05	18			120							
	●			20	19			18	9	2					
	●			22	21			135							
	●			25	24			120							

L4 shows DCB length.

Choose sleeves (DCB) to meet with DCON dimension of bar.

Adjustment pin cannot be installed to EZH-ST sleeves. To adjust overhang of the bar, please use EZH-CT / HP sleeves.

Spare Parts Description (for EZH-ST Sleeves)

Description	Spare Parts		Applicable EZ Bars		EZ Bar PLUS S/C-SCLC S/C-STLB(P) S/C-SWUB
	Clamp Screw	Wrench	EZB-HP EZB-HP-LT EZB-ST EZB-NB	EZBT / EZBF EZBP / EZBC EZVB / EZG EZFG / EZT	
EZH 017...ST-... 020...ST-... 025...ST-... 030...ST-...	HS3X4P	LW-1.5 Tightening Torque 1N·m	EZBR...017...	-	-
			EZB [®] /L...020...	EZ_R...020...	-
			EZB [®] /L...025...	EZTR...025...	-
			EZB [®] /L...030...	EZ_R...030...	-
EZH 035...ST-... 040...ST-... 050...ST-... 060...ST-... 070...ST-... 080...ST-...	HS4X4P	LW-2 Tightening Torque 2N·m	EZB [®] /L...035...	EZTR...035...	-
			EZB [®] /L...040...	EZ [®] /L...040...	-
			EZB [®] /L...050...	EZ [®] /L...050...	_050X...-060EZP
			EZB [®] /L...060...	EZ [®] /L...060...	_060X...-070EZP
			EZB [®] /L...070...	EZ [®] /L...070...	_070X...-080EZP
			EZB [®] /L...080...	-	_080X...-100EZP

● : Standard item R : Right-hand only L : Left-hand only □ : Check availability



Boring

VNB-S

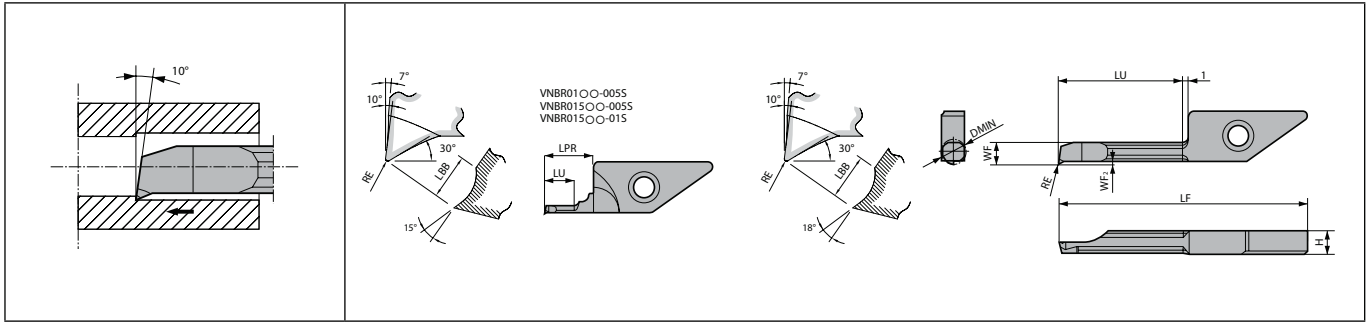

Right-hand shown

F

Dimensions

Description	No. of edges	Dimension (mm)										Tolerance (mm)			Carbide		Applicable toolholder F48~F51
		DMIN	H	LPR	LBB	LF	LU	WF	WF ₂	RE	RE min.	RE max.	PVD				
													PR1225	PR930			
VNBR 0103-005S	1	1	3.9	7	0.7	26.5	3	0.85	0.2	0.05	-0.02	0	●	●	SVNR...-12N S...-SVNR12N S...-SVNR12SN		
VNBR 0105-005S	1	1	3.9	7	0.7	26.5	5	0.85	0.2	0.05	-0.02	0	●	●			
VNBR 01503-005S 01503-01S 01505-005S 01505-01S	1	1.5	3.9	7	0.7	26.5	3 3 5 5	1.3	0.2	0.05 0.1 0.05 0.1	-0.02 -0.03 -0.02 -0.03	0	● ● ● ●	● ● ● ●			
VNBR 0206-005S 0206-01S	1	2	3.9	-	0.8	26.5	6	1.8	0.25	0.05 0.1	-0.02 -0.03	0	● ●	● ●	SVNR...-12N, SVNSR-12-06N S...-SVNR12N, S...-SVNR12SN		
VNBR 025075-005S 025075-01S	1	2.5	3.9	-	0.8	28.1	7.5	2.1	0.4	0.05 0.1	-0.02 -0.03	0	● ●	● ●	SVNR...-12NS..., -SVNR12N S...-SVNR12SN		
VNBR 0311-005S 0311-01S	1	3	3.9	-	0.8	30.8	11	2.6	0.4	0.05 0.1	-0.02 -0.03	0	● ●	● ●	SVNR...-12N, SVNSR-12-11N S...-SVNR12N, S...-SVNR12SN		
VNBR 03515-005S 03515-01S	1	3.5	3.9	-	0.8	34.8	15	3	0.5	0.05 0.1	-0.02 -0.03	0	● ●	● ●	SVNR...-12NS..., -SVNR12N S...-SVNR12SN		
VNBR 0411-005S 0411-01S 0411-02S	1	4	3.66	-	0.8	30.8	11	3.5	0.5	0.05 0.1 0.2	-0.02 -0.03 -0.04	0	● ● ●	● ● ●	SVNR...-12N, SVNSR-12-11N S...-SVNR12N, S...-SVNR12SN		
VNBR 0420-005S 0420-01S 0420-02S	1	4	3.66	-	0.8	39.8	20	3.5	0.5	0.05 0.1 0.2	-0.02 -0.03 -0.04	0	● ● ●	● ● ●	SVNR...-12N, SVNSR-12-20N S...-SVNR12N, S...-SVNR12SN		

Recommended Cutting Conditions (VNB-S)

Workpiece material	Insert grades (Vc: m/min)		VNB01-S VNB015-S	VNB02-S VNB04-S		Remarks	
	MEGACOAT	PVD coated carbide					
	PR1225	PR930		ap (mm), f (mm/rev)			
	ap	f		ap	f		
Carbon steel / Alloy steel	★ 30~120	☆ 30~100	~0.1	~0.01	~0.2	~0.03	Coolant
Stainless steel	★ 30~100	☆ 30~80	~0.1	~0.01	~0.2	~0.02	

★1st recommendation ☆2nd recommendation

● : Standard item R : Right-hand only L : Left-hand only □ : Check availability

System tip-bars are 5 piece boxes

VNB

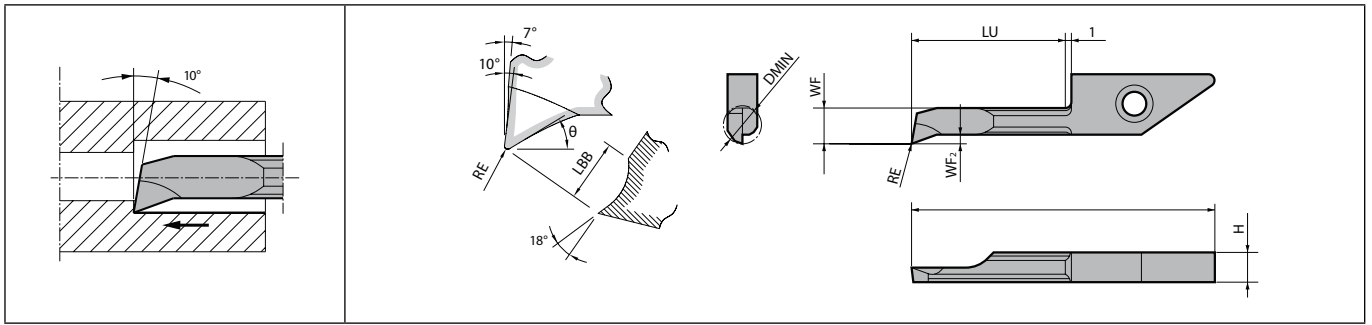

Right-hand shown

Dimensions

Description	No. of edges	Dimension (mm)								Angle θ (°)	Carbide			Applicable toolholder F48~F51
		DMIN	H	LBB	LF	LU	WF	WF ₂	RE		PVD		-	
											PR125	PR930		
VNBR 0206-003 0206-01 0206-02	1	2	3.9	1.2	26.5	6	1.8	0.25	0.03 0.1 0.2	24	●	●	●	SVNR...-12N, SVNSR-12-06N S...-SVNR12N, S...-SVNR12SN
VNBR 0311-003 0311-01 0311-02	1	3	3.9	1.8	30.8	11	2.6	0.4	0.03 0.1 0.2	24	●	●	●	SVNR...-12N, SVNSR-12-11N S...-SVNR12N, S...-SVNR12SN
VNBR 0411-003 0411-01 0411-02	1	4	3.66	2.7	30.8	11	3.5	0.5	0.03 0.1 0.2	23	●	●	●	SVNR...-12N, SVNSR-12-11N S...-SVNR12N, S...-SVNR12SN
VNBR 0420-003 0420-01 0420-02	1	4	3.66	2.7	39.8	20	3.5	0.5	0.03 0.1 0.2	23	●	●	●	SVNR...-12N, SVNSR-12-20N S...-SVNR12N, S...-SVNR12SN
VNBR 0511-003 0511-01 0511-02	1	5	3.9	3	30.8	11	4.5	0.7	0.03 0.1 0.2	23	●	●	●	SVNR...-12N, SVNSR-12-11N S...-SVNR12N, S...-SVNR12SN
VNBR 0520-003 0520-01 0520-02	1	5	3.9	3	39.8	20	4.5	0.7	0.03 0.1 0.2	23	●	●	●	SVNR...-12N, SVNSR-12-20N S...-SVNR12N, S...-SVNR12SN
VNBR 0620-003 0620-01 0620-02	1	6	3.9	3	39.8	20	5.3	1	0.03 0.1 0.2	24	●	●	●	SVNR...-12N, SVNSR-12-20N S...-SVNR12N, S...-SVNR12SN
VNBR 0630-003 0630-01 0630-02	1	6	3.9	3	49.8	30	5.3	1	0.03 0.1 0.2	24	●	●	●	SVNR...-12N S...-SVNR12N S...-SVNR12SN
VNBR 0720-003 0720-01 0720-02	1	7	3.9	3	39.8	20	6.2	1	0.03 0.1 0.2	24	●	●	●	SVNR...-12N, SVNSR-12-20N S...-SVNR12N, S...-SVNR12SN
VNBR 0730-003 0730-01 0730-02	1	7	3.9	3	49.8	30	6.2	1	0.03 0.1 0.2	24	●	●	●	SVNR...-12N S...-SVNR12N S...-SVNR12SN

Recommended cutting conditions F47

● : Standard item R : Right-hand only L : Left-hand only □ : Check availability

System tip-bars are sold in 5 piece boxes



VNB-NB

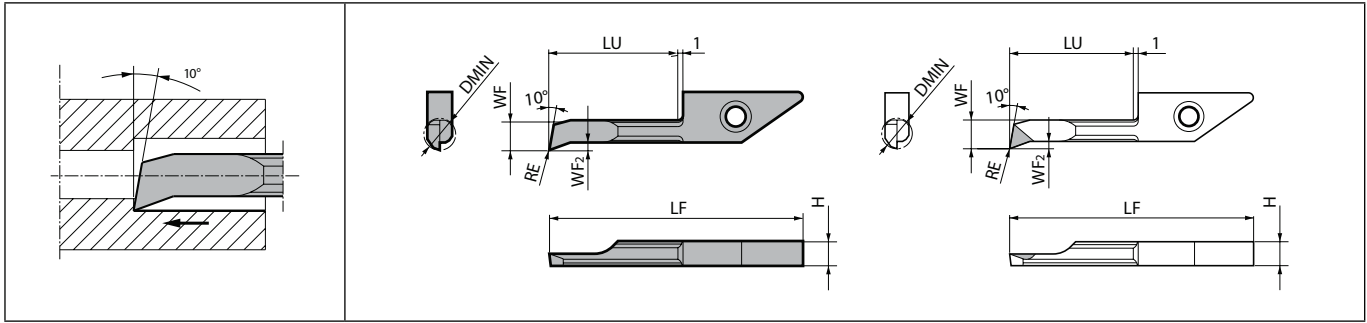

Right-hand shown

F

Dimensions

Description	No. of edges	Dimension (mm)								Angle θ (°)	Carbide			PCD	Applicable toolholder F48~F51
		DMIN	H	LF	LU	WF	WF ₂	RE	PVD		-	-			
									PR930		KW10	KPD001			
VNBR 0206-003NB 0206-02NB	1	2	3.9	26.5	6	1.8	0.25	0.03 0.2	15	●	●		SVNR...-12N, SVNSR-12-06N S...-SVNR12N, S...-SVNR12SN		
VNBR 0311-003NB 0311-02NB	1	3	3.9	30.8	11	2.6	0.4	0.03 0.2	15	●	●		SVNR...-12N, SVNSR-12-11N S...-SVNR12N, S...-SVNR12SN		
VNBR 0411-003NB 0411-02NB	1	4	3.66	30.8	11	3.5	0.5	0.03 0.2	15	●	●	●	SVNR...-12N, SVNSR-12-11N S...-SVNR12N, S...-SVNR12SN		
VNBR 0420-003NB 0420-02NB	1	4	3.66	39.8	20	3.5	0.5	0.03 0.2	15	●	●	●	SVNR...-12N, SVNSR-12-20N S...-SVNR12N, S...-SVNR12SN		
VNBR 0511-003NB 0511-02NB	1	5	3.9	30.8	11	4.5	0.7	0.03 0.2	15	●	●	●	SVNR...-12N, SVNSR-12-11N S...-SVNR12N, S...-SVNR12SN		
VNBR 0520-003NB 0520-02NB	1	5	3.9	39.8	20	4.5	0.7	0.03 0.2	15	●	●	●	SVNR...-12N, SVNSR-12-20N S...-SVNR12N, S...-SVNR12SN		
VNBR 0620-003NB 0620-02NB	1	6	3.9	39.8	20	5.3	1	0.03 0.2	15	●	●	●	SVNR...-12N, SVNSR-12-20N S...-SVNR12N, S...-SVNR12SN		
VNBR 0630-003NB 0630-02NB	1	6	3.9	49.8	30	5.3	1	0.03 0.2	15	●	●	●	SVNR...-12N, S...-SVNR12N S...-SVNR12SN		
VNBR 0720-003NB 0720-02NB	1	7	3.9	39.8	20	6.2	1	0.03 0.2	15	●	●	●	SVNR...-12N, SVNSR-12-20N S...-SVNR12N, S...-SVNR12SN		
VNBR 0730-003NB 0730-02NB	1	7	3.9	49.8	30	6.2	1	0.03 0.2	15	●	●	●	SVNR...-12N, S...-SVNR12N S...-SVNR12SN		

Recommended cutting conditions F47

● : Standard item R : Right-hand only L : Left-hand only □ : Check availability

System tip-bars are sold in 5 piece boxes

CBN & PCD Inserts are sold in 1 piece boxes

VNBT

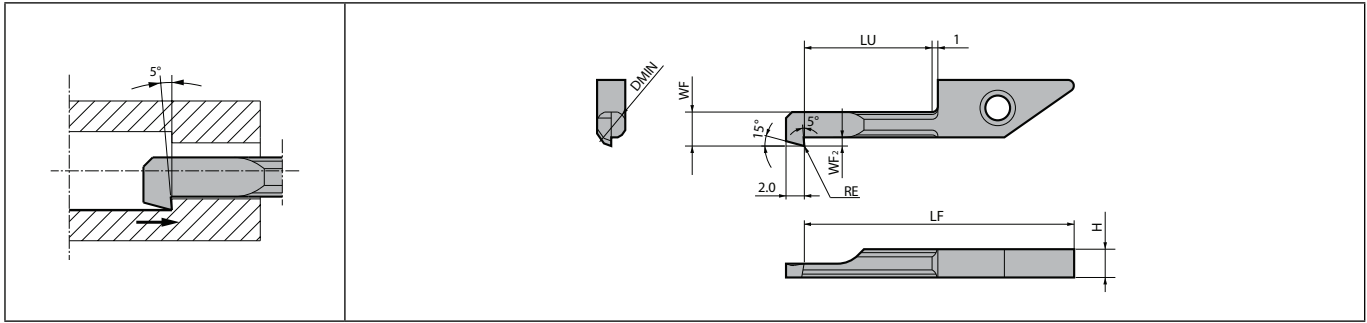

Right-hand shown

Dimensions

Description	No. of edges	Dimension (mm)								Carbide			Applicable toolholder F48~F51
		DMIN	H	LF	LU	WF	WF ₂	RE	PVD				
									PR1225	PR930	KW10		
VNBTR 0411-003 0411-01	1	4	3.66	28.8	9	3.6	1	0.03 0.1	●	●	●	SVNR...-12N, SVNSR-12-11N S...-SVNR12N, S...-SVNR12SN	
VNBTR 0420-003 0420-01	1	4	3.66	37.8	18	3.6	1	0.03 0.1	●	●		SVNR...-12N, SVNSR-12-20N S...-SVNR12N, S...-SVNR12SN	
VNBTR 0511-003 0511-01	1	5	3.9	28.8	9	4.6	1.3	0.03 0.1	●	●	●	SVNR...-12N, SVNSR-12-11N S...-SVNR12N, S...-SVNR12SN	
VNBTR 0520-003 0520-01	1	5	3.9	37.8	18	4.6	1.3	0.03 0.1	●	●		SVNR...-12N, SVNSR-12-20N S...-SVNR12N, S...-SVNR12SN	

Recommended cutting conditions F47

Recommended Cutting Conditions (VNB / VNB-NB / VNBT)

Workpiece material	Insert grades (Vc: m/min)					VNB02	VNB03	VNB04 VNB04	VNB05 VNB06 VNB07 VNB05	Remarks				
	MEGACOAT	PVD coated carbide	Carbide	PCD										
	PR1225	PR930	KW10	KPD001	KPD010									
	ap (mm), f (mm/rev)													
ap		f		ap		f		ap		f				
Carbon steel / Alloy steel	★ 30~120	☆ 30~100				~0.3	~0.03	~0.4	~0.04	~0.45	~0.07	~0.5	~0.1	Coolant
Stainless steel	★ 30~100	☆ 30~80				~0.3	~0.02	~0.4	~0.03	~0.45	~0.05	~0.5	~0.07	
Non-ferrous metals			☆ ~100	★ ~300	☆ ~300	~0.3	~0.05	~0.4	~0.06	~0.45	~0.1	~0.5	~0.15	

★ 1st recommendation ☆ 2nd recommendation



SVN-N (without side stopper)

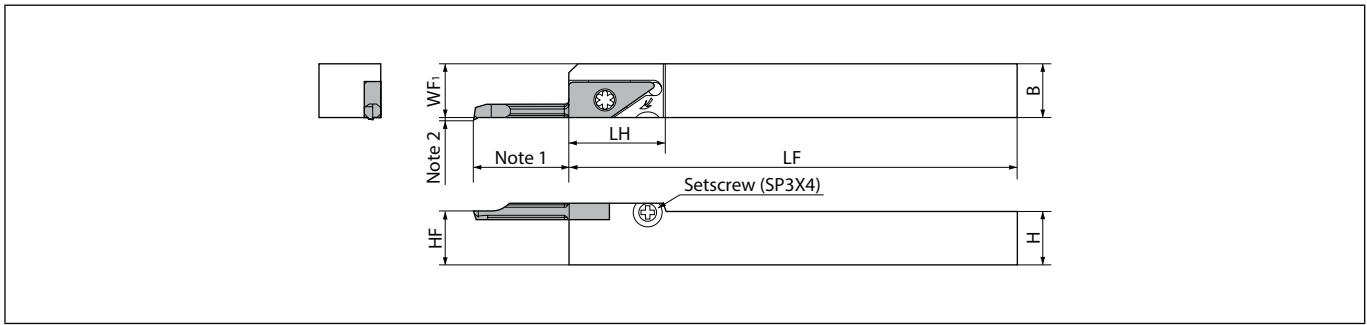

Right-hand shown | Right-hand Insert for Right-hand Toolholder.
Note 1 & Note 2 (WF2) : For insert dimensions, see page (F44~F47)

F

Toolholder dimensions

Description	Availability	Dimension (mm)						Spare parts			Applicable inserts ➔ F44~F47	
		R	H	B	LH	HF	LF	WF ₁	Screw	Set screw		Wrench
SVNR 1010H-12N	●	10	10			10	100	10	SB-3080TR	SP3X4	FT-10	VNBR...-... VNBTR...-... VNGR...-... VNFR...-... VNTR...-...
1212K-12N	●	12	12			12		12				
1616K-12N	●	16	16	22		16	125	16				
2020K-12N	●	20	20			20		20				
2525M-12N	●	25	25			25	150	25				

SVN-N (without side stopper) retains high index accuracy by easy restraint.

SVN-N (without side stopper) has a setscrew SP3X4. Changing the setscrew SP3X4 to a screw HS3X4 (sold separately) enables the toolholder to be used as a binding effect toolholder similar to the side stopper toolholder.

Spare Parts (Optional)

Screw (Side Stopper)	Wrench
HS3X4	LW-1.5

● : Standard item R : Right-hand only L : Left-hand only □ : Check availability



Boring

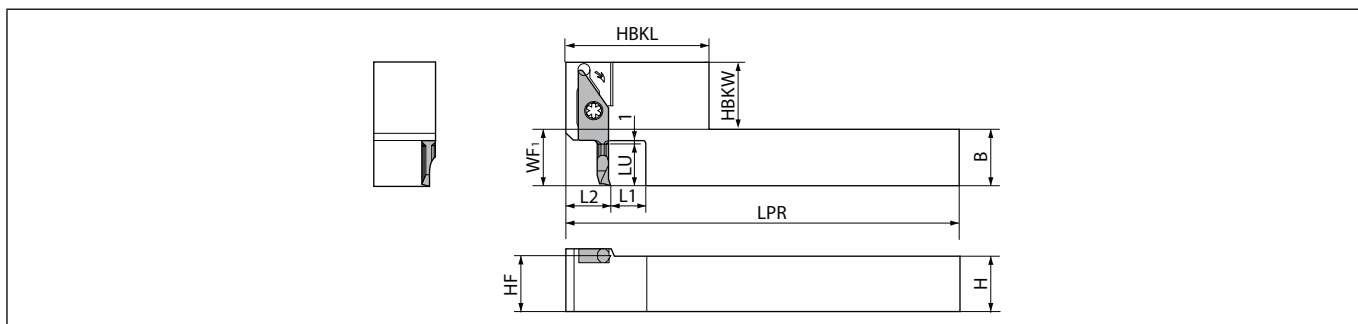

- Solid
- Positive
- AD bars
- Negative

SVNS-N (without side stopper / without setscrew)



Right-hand shown | Right-hand Insert for Right-hand Toolholder.

Toolholder dimensions

Description	Availability	Dimension (mm)											Spare parts		Applicable inserts F44~F47
		R	H	B	LPR	HF	HBKW	HBKCL	LU	WF1	L1	L2	Screw	Wrench	
															
SVNSR 1212M-12-11N 1616M-12-11N	● ●	12 16	12 16	150	12 16	21 17	45	11	12 16	10 16	12	SB-3080TR	LTW-10S	VNBR..11-..., VNBTR..11-... VNGR...-11, VNTR...-11	
SVNSR 1212M-12-20N 1616M-12-20N	● ●	12 16	12 16	150	12 16	30 26	45	20	12 16	10 16	13	SB-3080TR	LTW-10S	VNBR..20-..., VNBTR20-... VNGR...-20	

All system Tip-Bars Inserts are used with a SVNSR-N Toolholders. However, when setting the cutting edge at the face level of the toolholder as shown in the figure, use the applicable inserts described above.

In these cases, the LU dimension of the toolholders corresponds to the LU dimension of the insert.



S-SVN-N (Round shank / Standard / without side stopper)

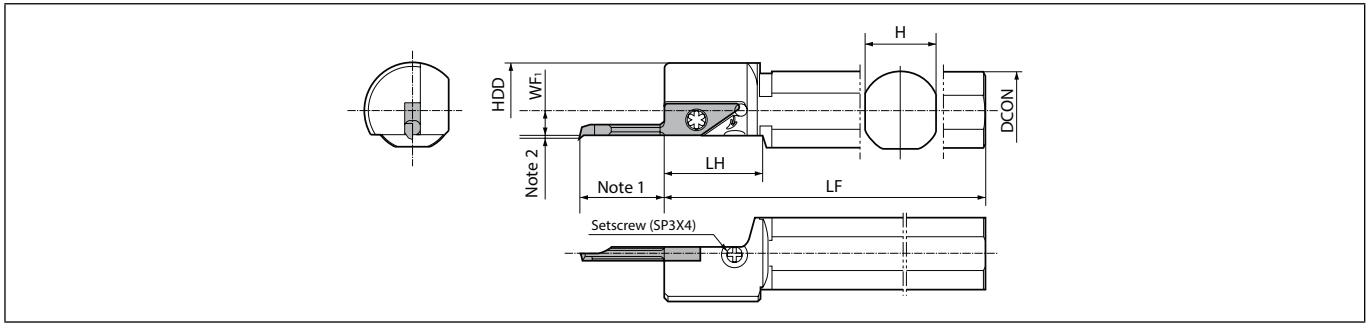

Right-hand shown | Right-hand Insert for Right-hand Toolholder.
Note 1 & Note 2 (WF₂) : For insert dimensions, see page (F44~F47)

F

Toolholder dimensions

Description	Availability	Dimension (mm)						Spare parts			Applicable inserts F44~F47	
		R	DCON	H	LH	HDD	LF	WF ₁	Screw	Set screw		Wrench
S12F- SVNR12N	●	12	11	23	20	80	4	SB-3080TR	SP3X4	FT-10	VNBR...-... VNBTR...-... VNGR...-... VNFR...-... VNTR...-...	
S14G- SVNR12N	●	14	13			90						
S16H- SVNR12N	●	16	15	24	100							
S19H- SVNR12N	●	19.05	17		160							
S19N- SVNR12N	●		20	18	24	100						
S20H- SVNR12N	●	25.4				23	30					180
S25H- SVNR12N	●		25.4	23	30							180
S25Q- SVNR12N	●											

S-SVN-N (without side stopper) retains high index accuracy by easy restraint.

S-SVN-N (without side stopper) has a setscrew SP3X4. Changing the setscrew SP3X4 to a screw HS3X4 (sold separately) enables the toolholder to be used as a binding effect toolholder similar to the side stopper toolholder.

Spare Parts (Optional)

Screw (Side Stopper)	Wrench
HS3X4	LW-1.5

● : Standard item R : Right-hand only L : Left-hand only □ : Check availability

Boring

Solid

Positive

AD bars

Negative

S-SVN-SN (Round shank / Straight / without side stopper)

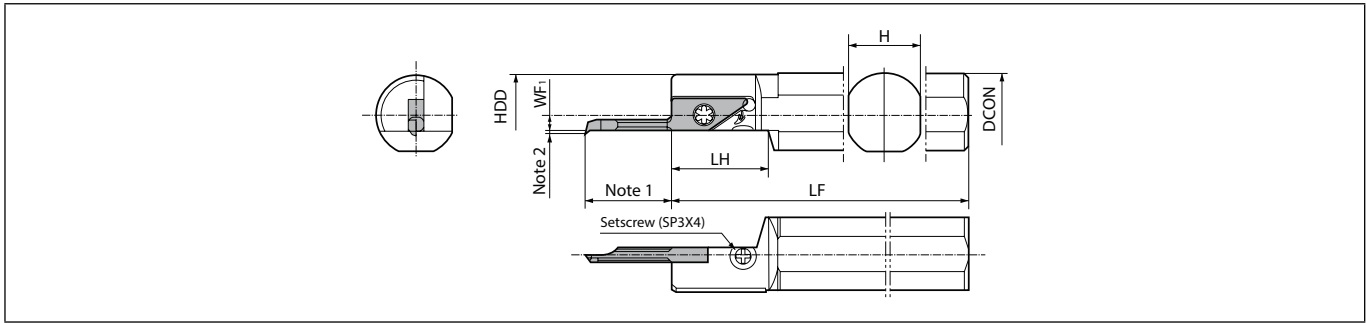

Right-hand shown | Right-hand Insert for Right-hand Toolholder.
Note 1 & Note 2 (WF₂) : For insert dimensions, see page (F44~F47)

Toolholder dimensions

Description	Availability	Dimension (mm)						Spare parts			Applicable inserts F44~F47	
		R	DCON	H	LH	HDD	LF	WF ₁	Screw	Set screw		Wrench
S19H- SVN12SN	●	19.05	17	23	18.5	100	4	SB-3080TR	SP3X4	FT-10	VNBR......, VNBTR... VNGR......, VNFG... VNTR......	
S20H- SVN12SN	●	20	18		19.5							
S22K- SVN12SN	●	22	20		21.5	125						
S25.0G- SVN12SN	●	25	23		24.5	90						

Spare Parts (Optional)

Screw (Side Stopper)	Wrench
HS3X4	LW-1.5

S-SVN-SN (without side stopper) retains high index accuracy by easy restraint.

S-SVN-SN (without side stopper) has a setscrew SP3X4. Changing the setscrew SP3X4 to a screw HS3X4 (sold separately) enables the toolholder to be used as a binding effect toolholder similar to the side stopper toolholder.

Selection of system tip-bars

Gang-Type (Horizontal)	Gang-Type	Gang-Type Front loading sleeve type	Gang-Type Back loading sleeve type
Square shank (Straight)	Square shank (L-shape)	Square shank	Square shank
Round shank (Standard)		Round shank (Standard)	Round shank (Standard)
Round shank (Straight)		Round shank (Straight)	Round shank (Straight)

Q: There are standard types (head dia. is larger than shank) and straight types for round shanks. What is each one used for?

A: The straight type is used when it cannot be inserted from the face side of the sleeve holder and can be inserted only from the back side due to space limitation (Refer to fig. on the right). On the other hand, the standard type should be installed when it can be inserted from the face side, and the head end is used for positioning as stopper.

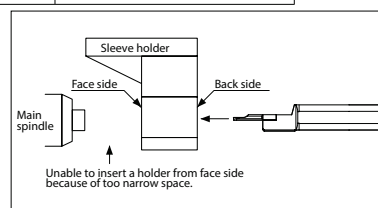

● : Standard item R : Right-hand only L : Left-hand only □ : Check availability



VNBX-S

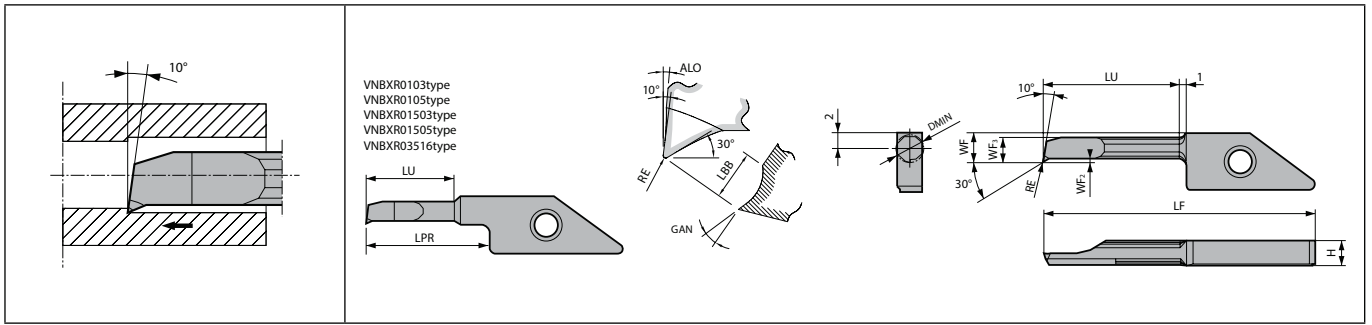

Right-hand shown

F

Dimensions

Description	No. of fedges	Dimension (mm)											Angle (°)		Tolerance (mm)		Carbide PVD PR930	Applicable toolholder F53~F55
		DMIN	H	LPR	LBB	LF	LU	WF	WF ₂	WF ₃	RE	ALO	GAN	RE min.	RE max.			
VNBXR 0103-005S	1	1	3.9	7	0.7	26.5	3	2.95	0.2	0.85	0.05	7	15	-0.02	0	●	S...-SVNR12XN S...-SVNR12SXN	
VNBXR 0105-005S	1	1	3.9	7	0.7	26.5	5	2.95	0.2	0.85	0.05	7	15	-0.02	0	●	S...-SVNR12XN S...-SVNR12SXN	
VNBXR 01503-005S 01503-01S 01505-005S 01505-01S	1	1.5	3.9	7	0.7	26.5	3 3 5 5	2.95	0.2	1.3	0.05 0.1 0.05 0.1	7	15	-0.02 -0.03 -0.02 -0.03	0	● ● ● ●	S...-SVNR12XN S...-SVNR12SXN	
VNBXR 0206-005S 0206-01S	1	2	3.9	-	0.8	26.5	6	3	0.25	1.8	0.05 0.1	8	18	-0.02 -0.03	0	● ●	SVNSR...-12-06XN S...-SVNR12XN S...-SVNR12SXN	
VNBXR 0311-005S 0311-01S	1	3	3.9	-	0.8	30.8	11	3.5	0.4	2.6	0.05 0.1	8	18	-0.02 -0.03	0	● ●	SVNSR...-12-11XN S...-SVNR12XN S...-SVNR12SXN	
VNBXR 03511-005S 03511-01S 03516-005S 03516-01S	1	3.5	3.9	- - 21 21	0.8	30.8 30.8 39.8 39.8	11 11 16 16	3.75	0.45	3.1	0.05 0.1 0.05 0.1	8	18	-0.02 -0.03 -0.02 -0.03	0	● ● ● ●	SVNSR...-12-11XN, S...-SVNR12XN S...-SVNR12SXN S...-SVNR12XN S...-SVNR12SXN	
VNBXR 0411-005S 0411-01S 0411-02S	1	4	3.66	-	0.8	30.8	11	4	0.5	3.5	0.05 0.1 0.2	8	18	-0.02 -0.03 -0.04	0	● ● ●	SVNSR...-12-11XN S...-SVNR12XN S...-SVNR12SXN	
VNBXR 0420-005S 0420-01S 0420-02S	1	4	3.66	-	0.8	39.8	20	4	0.5	3.5	0.05 0.1 0.2	8	18	-0.02 -0.03 -0.04	0	● ● ●	SVNSR...-12-20XN S...-SVNR12XN S...-SVNR12SXN	

Recommended cutting conditions F55

●: Standard item R: Right-hand only L: Left-hand only □: Check availability

System tip-bars are sold in 5 piece boxes

SVNS-XN (without side stopper)

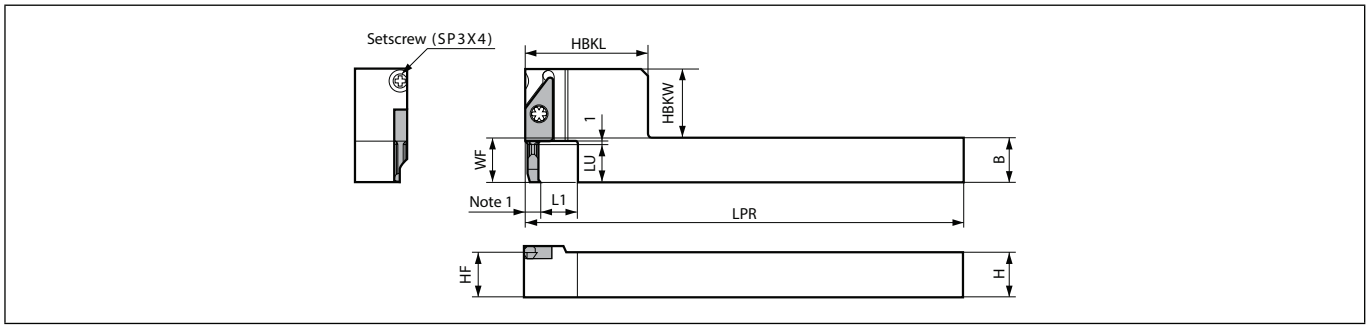

Right-hand shown | Right-hand Insert for Right-hand Toolholder.
 Note 1 : The dimension of Note 1 is same size as the applicable insert (VNBX) WF dimension.

Toolholder dimensions

Description	Availability	Dimension (mm)										Spare parts			Applicable inserts F52
		R	H	B	LPR	L1	HF	HBKWW	HBKWL	LU	WF	Screw	Set screw	Wrench	
SVNSR 1010K-12-06XN 1212M-12-06XN 1616M-12-06XN	●	10	10	125	10	10	19	45	6	10	SB-3080TR	SP3X4	LTW-10S	VNBXR0206-...	
●	12	12	150	12		17	12								
●	16	16	150	16		13	16								
SVNSR 1010K-12-11XN 1212M-12-11XN 1616M-12-11XN	●	10	10	125	10	10	23	45	11	10	SB-3080TR	SP3X4	LTW-10S	VNBXR...11-...	
●	12	12	150	12		21	12								
●	16	16	150	16		17	16								
SVNSR 1212M-12-20XN 1616M-12-20XN	●	12	12	150	10	12	30	45	20	12	SB-3080TR	SP3X4	LTW-10S	VNBXR0420-...	
●	16	16	150	16		26	16								

All VNBXR system Tip-Bars Inserts are used with a SVNS-XN Toolholder. However, when setting the cutting edge at the face level of the toolholder as shown in figure, use the applicable inserts described above.

SVNS-XN (without side stopper) retains high index accuracy by easy restraint.

SVNS-XN (without side stopper) has a setscrew SP3X4. Changing the setscrew SP3X4 to a screw HS3X4 (sold separately) enables the toolholder to be used as a binding effect toolholder similar to the side stopper toolholder.

Spare Parts (Optional)

Screw (Side Stopper)	Wrench
HS3X4	LW-1.5

● : Standard item R : Right-hand only L : Left-hand only □ : Check availability



S-SVN-XN (Round shank / Standard / without side stopper)

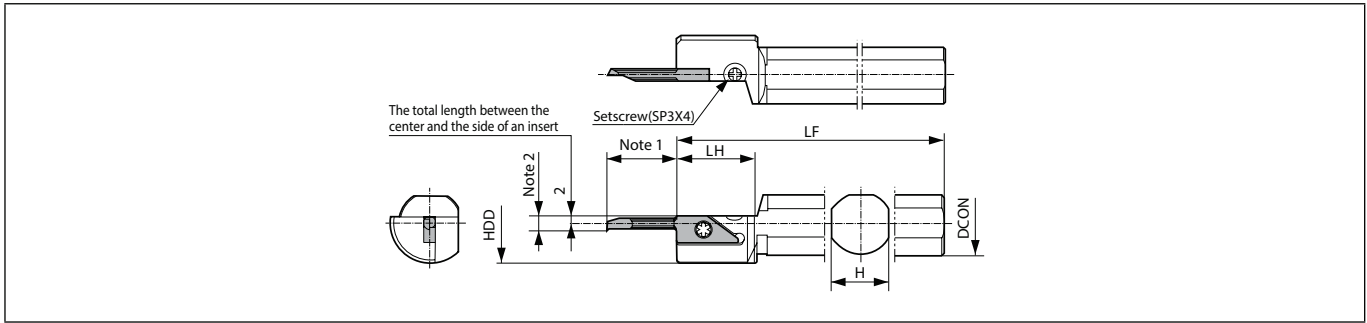

Right-hand shown | Right-hand Insert for Right-hand Toolholder.

Note 1 : The dimension of Note 1 shows the applicable insert (VNBX) LU +1 mm.

Note 2 : The dimension of Note 2 is same size as the applicable insert (VNBX) WF dimension.

F

Toolholder dimensions

Description	Availability	Dimension (mm)						Spare parts			Applicable inserts ➔ F52
		R	DCON	H	LH	HDD	LF	Screw	Set screw	Wrench	
S12F- SVNR12XN	●	12	11	23	20	80	SB-3080TR	SP3X4	FT-10	VNBXR...	
S14G- SVNR12XN	●	14	13			90					
S16H- SVNR12XN	●	16	15			100					
S19H- SVNR12XN	●	19.05	17	24	160						
S19N- SVNR12XN	●				100						
S20H- SVNR12XN	●	20	18	24	30	100					
S25H- SVNR12XN	●	25.4	23			180					
S25Q- SVNR12XN	●			180							

S-SVN-XN (without side stopper) retains high index accuracy by easy restraint.

S-SVN-XN (without side stopper) has a setscrew SP3X4. Changing the setscrew SP3X4 to a screw HS3X4 (sold separately) enables the toolholder to be used as a binding effect toolholder similar to the side stopper toolholder.

Spare Parts (Optional)

Screw (Side Stopper)	Wrench
HS3X4	LW-1.5

● : Standard item R : Right-hand only L : Left-hand only □ : Check availability

Boring

Solid

Positive

AD bars

Negative

S-SVN-SXN (Round shank / Straight / without side stopper)

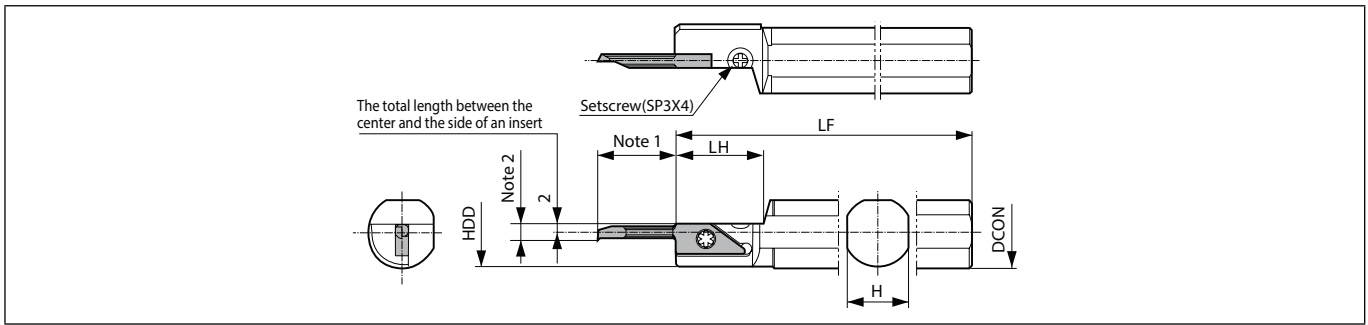

Right-hand shown | Right-hand Insert for Right-hand Toolholder.

Note 1 : The dimension of Note 1 shows the applicable insert (VNBX) LU +1 mm.

Note 2 : The dimension of Note 2 is same size as the applicable insert (VNBX) WF dimension.

Toolholder dimensions

Description	Availability	Dimension (mm)					Spare parts			Applicable inserts ➔ F52	
		R	DCON	H	LH	HDD	LF	Screw	Set screw		Wrench
S19H- SVNR12SXN	●	19.05	17	23	18.5	100	SB-3080TR	SP3X4	FT-10	VNBXR...	
S20H- SVNR12SXN	●	20	18		19.5						
S22K- SVNR12SXN	●	22	20		21.5						125
S25.0G- SVNR12SXN	●	25	23		24.5						90

S-SVN-SXN (without side stopper) retains high index accuracy by easy restraint.

S-SVN-SXN (without side stopper) has a setscrew SP3X4. Changing the setscrew SP3X4 to a screw HS3X4 (sold separately) enables the toolholder to be used as a binding effect toolholder similar to the side stopper toolholder.

Spare Parts (Optional)

Screw (Side Stopper)	Wrench
HS3X4	LW-1.5

Recommended Cutting Conditions (VNBX-S)

Workpiece material	Insert grades (Vc: m/min) PVD coated carbide PR930	VNBX01-S type VNBX015-S type		VNBX02-S type VNBX04-S type		Remarks
		ap (mm), f (mm/rev)				
		ap	f	ap	f	
		Carbon steel / Alloy steel	★ 30~100	~0.1	~0.01	
Stainless steel	★ 30~80	~0.1	~0.01	~0.2	~0.02	

★ 1st recommendation



TWB (Micro boring, Horizontal type)

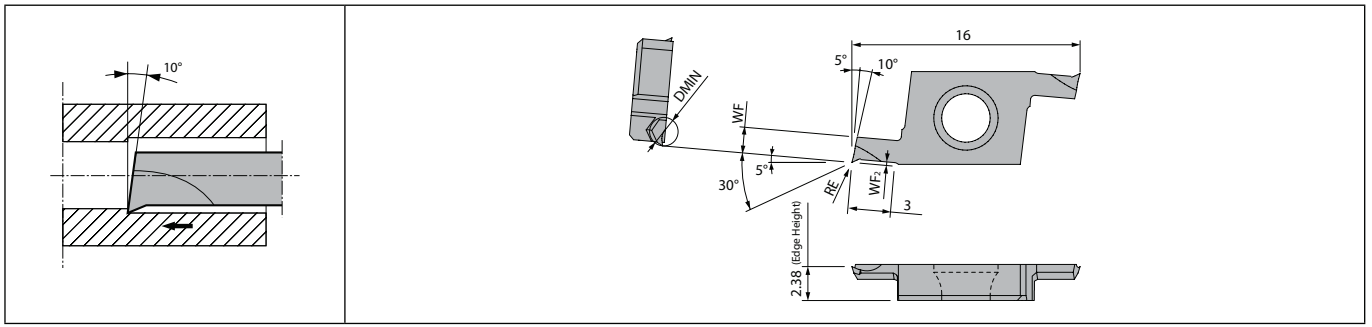

Right-hand shown

F

Dimensions

Description	No. of edges	Dimension (mm)				Tolerance (mm)		Carbide		Applicable toolholder ➔ F56, F57
		DMIN	WF	WF ₂	RE	RE min.	RE max.	PVD		
								PR1025	PR1535	
TWBR 01003-005	1	1	0.85	0.2	0.05	-0.02	0	●	●	STWR...-15 S.-STWR15
TWBR 01503-005 01503-010	1	1.5	1.3	0.2	0.05	-0.02 -0.03	0	●	●	
TWBR 02003-005 02003-010	1	2	1.75	0.25	0.05	-0.02 -0.03	0	●	●	
TWBR 02503-005 02503-010	1	2.5	2.1	0.3	0.05	-0.02 -0.03	0	●	●	
TWBR 03003-005 03003-010	1	3	2.4	0.4	0.05	-0.02 -0.03	0	●	●	

Recommended cutting conditions ➔ F59

STW (Micro boring, Square shank for horizontal type insert)

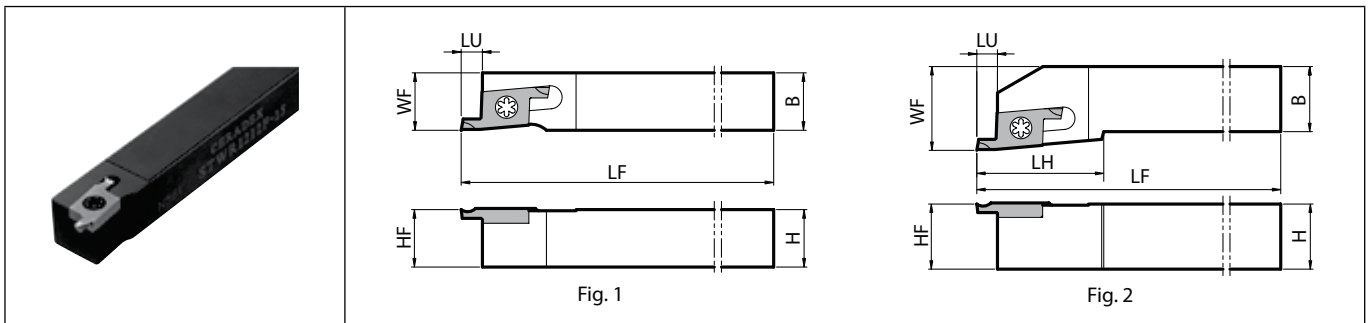

Right-hand shown | Right-hand Insert for Right-hand Toolholder.
(For Left-hand toolholders for grooving, please see page G106.)

Toolholder dimensions

Description	Availability	Dimension (mm)								Coolant hole Fig.	Spare parts		Applicable inserts ➔ F56	
		R	CDX	H	B	LH	HF	LF	LU		WF	Screw		Wrench
STWR 1212F-15	●						85			1			TWBR...	
1212K-15	●									1				
1616K-15	●	3	16	16		16	125	3	16	1	SB-3080TR	LTW-10S		
2020K-15	●		20	20		20			25	2				
2525M-15	●		25	25	25	150			32	2				

● : Standard item R : Right-hand only L : Left-hand only □ : Check availability

Twin-bars are sold in 5 piece boxes

S-STW (Micro boring, Round shank for horizontal type insert)

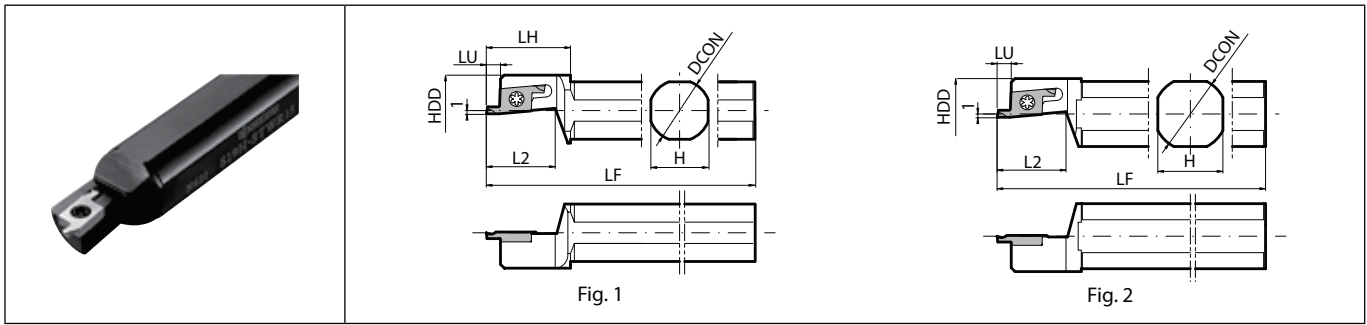

Right-hand shown | Right-hand Insert for Right-hand Toolholder.
(For Left-hand toolholders for grooving, please see page G107.)

Toolholder dimensions

Description	Availability	Dimension (mm)								Coolant hole	Fig.	Spare parts		Applicable inserts ➔ F56
		R	DCON	H	LH	HDD	L2	LF	LU			Screw	Wrench	
S12F- STWR15	●	12	11	22	20	18	80	3	No	1	SB-3080TR	LTW-10S	TWBR...	
S14H- STWR15	●	14	13											100
S15F- STWR15	●	15.875	15	85										
S16F- STWR15	●	16	18	90										
S19G- STWR15	●	19.05	17	18.5	90									
S19K- STWR15	●				120									
S20G- STWR15	●	20	18	19.5	90									
S20K- STWR15	●				120									
S22K- STWR15	●	22	20	21.5	125									
S25.0J- STWR15	●	25	23	24.5	110									
S25K- STWR15	●	25.4		25	120									



● : Standard item R : Right-hand only L : Left-hand only □ : Check availability

TWBT (Micro boring, Vertical type)

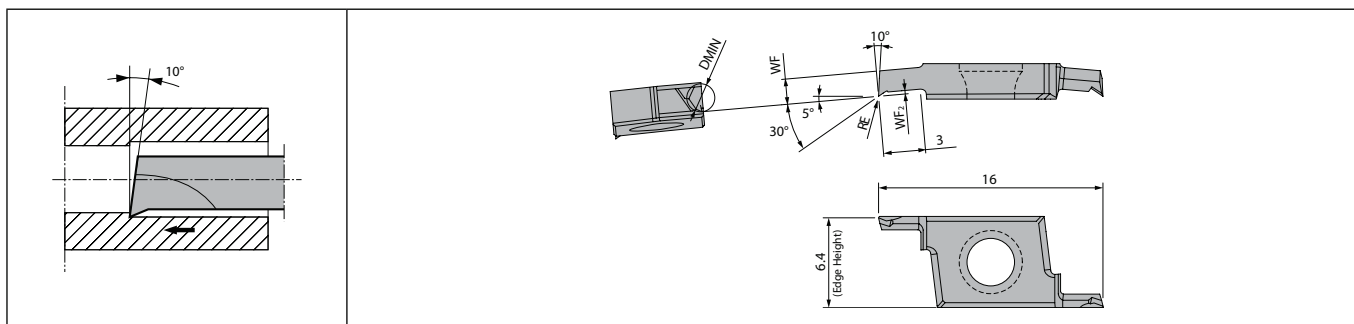

Right-hand shown

F

Dimensions

Description	No. of edges	Dimension (mm)				Tolerance (mm)		Carbide		Applicable toolholder F59
		DMIN	WF	WF ₂	RE	RE min.	RE max.	PVD		
								PR1025	PR1535	
TWBTR 01003-005	1	1	0.85	0.2	0.05	-0.02	0	●	●	STWSR...-15T
TWBTR 01503-005 01503-010	1	1.5	1.3	0.2	0.05	-0.02 -0.03	0	●	●	
TWBTR 02003-005 02003-010	1	2	1.75	0.25	0.05	-0.02 -0.03	0	●	●	
TWBTR 02503-005 02503-010	1	2.5	2.1	0.3	0.05	-0.02 -0.03	0	●	●	
TWBTR 03003-005 03003-010	1	3	2.3	0.4	0.05	-0.02 -0.03	0	●	●	

Recommended cutting conditions F59

● : Standard item R : Right-hand only L : Left-hand only □ : Check availability

Twin-bars are sold in 5 piece boxes

STWS (Micro boring, Square shank for vertical type insert)

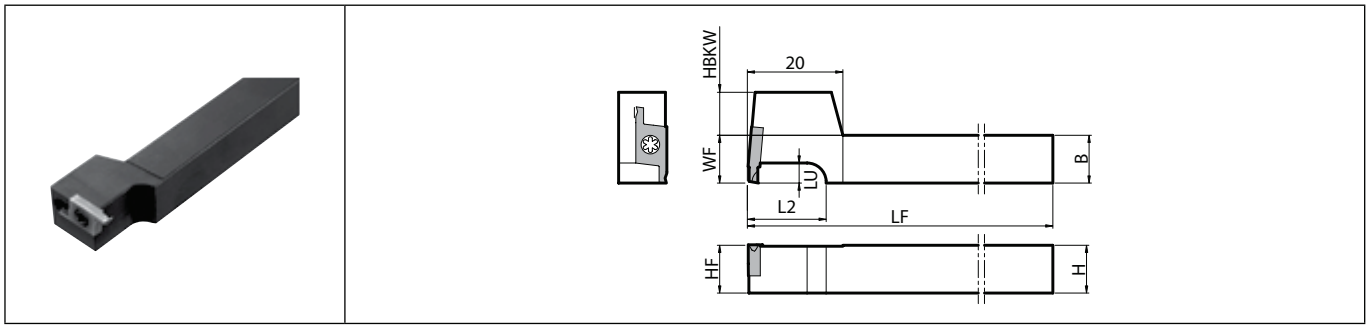

Right-hand shown

Toolholder dimensions

Description	Availability	Dimension (mm)									Spare parts		Applicable inserts ➔ F58
		R	H	B	L2	HF	HBKW	LF	LU	WF	Screw	Wrench	
STWSR	1010F-15T	●	10	10	16	10	9	85	3	10	SB-3080TR	LTW-10S	TWBTR...
	1010JX-15T	●						120					
	1212F-15T	●	12	12	12	7	85	12					
	1212JX-15T	●					120						
	1616JX-15T	●	16	16	20	16	3	120	16				



Recommended Cutting Conditions (TWB / TWBT)

Workpiece material	Insert grades Vc: m/min		TWBR01003 TWBR01503 TWBTR01003 TWBTR01503		TWBR02003 TWBR02503 TWBR03003 TWBTR02003 TWBTR02503 TWBTR03003		Remarks
	MEGACOAT NANO	PVD coated carbide	ap (mm), f (mm/rev)				
	PR1535	PR1025	ap	f	ap	f	
Carbon steel / Alloy steel	★ 30~100	☆ 30~100	~0.1	~0.01	~0.2	~0.03	Coolant
Stainless steel	★ 30~80	☆ 30~80	~0.1	~0.01	~0.2	~0.02	

★ 1st recommendation ☆ 2nd recommendation

● : Standard item R : Right-hand only L : Left-hand only □ : Check availability

A/S-SCLC-AE Excellent bar (Boring / Internal facing)

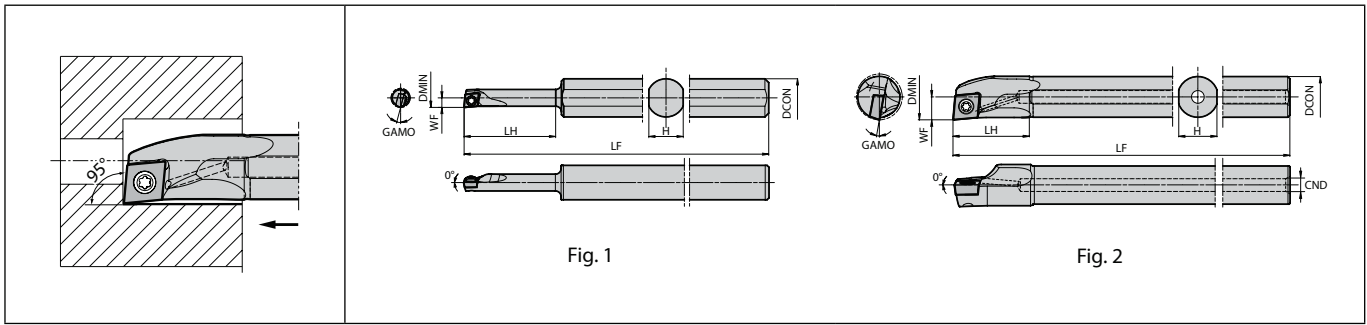

Fig. 1

Fig. 2

Max. Overhang Length L/D≈5.5 | Right-hand shown
Left-hand Insert for Right-hand Toolholder, Right-hand Insert for Left-hand Toolholder.

F

Toolholder dimensions

Description	Availability		Dimension (mm)								GAMO (°)	Standard corner-R(RE)	Coolant hole	Fig.	Spare parts			Applicable inserts
			R	L	DMIN	DCON	CND	H	LH	LF					WF	Screw	Wrench	
S10H- SCLC%03-05AE SCLC%03-06AE	●	●	5					24	2.5	15	0.2	No	1	SB-1635TR	-	FT-6	CC□T0301... CC□W0301...	
	●	●	6	10	-	9	28	100	3	13								
S10H- SCLC%04-07AE SCLC%04-08AE	●	●	7					32	3.5	13	0.2	No	1	SB-2035TR	-	FT-6	CC□T0401... CC□W0401...	
	●	●	8	10	-	9	37	100	4	11								
A08X- SCLC%06-10AE	●	●	10	8	2.5	7	16	120	5	14	0.4	Yes	2	SB-2545TR	-	FT-8	CC□T0602... CC□W0602...	
A10L- SCLC%06-12AE	●	●	12	10	3	9	20	140	6	12								
A12M- SCLC%06-14AE	●	●	14	12	4	11	24	150	7	10								
A16Q- SCLC%09-18AE	●	●	18	16			15	30	180	9								10
A20R- SCLC%09-22AE	●	●	22	20	5		19	36	200	11	8	0.4	Yes	2	SB-4065TR	FT-15	-	CC□T09T3... CC□W09T3...
A25S- SCLC%09-27AE	●	●	27	25			24	46	250	13.5	6							

When using P chipbreaker : Right-hand Insert for Right-hand Toolholder, Left-hand Insert for Left-hand Toolholder.

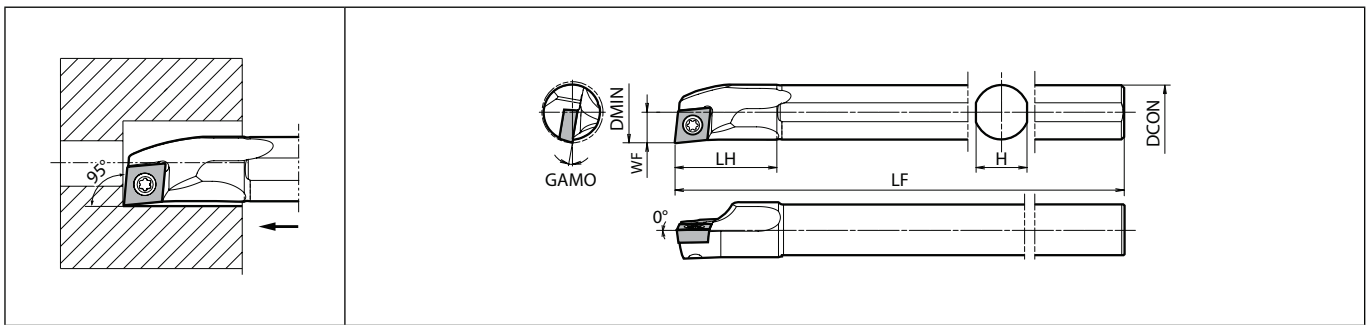

● : Standard item R : Right-hand only L : Left-hand only □ : Check availability

S-SCLC-A Steel shank bar (Boring / Internal facing)



Max. Overhang Length L/D≈4 | Right-hand shown
Left-hand Insert for Right-hand Toolholder, Right-hand Insert for Left-hand Toolholder.

Toolholder dimensions

Description	Availability		Dimension (mm)							GAMMO (°)	Standard corner-R(RE)	Coolant hole	Spare parts			Applicable inserts
													Screw	Wrench	Wrench	
	R	L	DMIN	DCON	H	LH	LF	WF								
S08X- SCLC [®] /L06-10A	●	●	10	8	7	16	120	5	14	0.4	No	SB-2545TR	-	FT-8	CC [®] T0602... CC [®] W0602...	
S10L- SCLC [®] /L06-12A	●	●	12	10	9	20	140	6	12							
S12M- SCLC [®] /L06-14A	●	●	14	12	11	24	150	7	10							
S16Q- SCLC [®] /L09-18A	●	●	18	16	15	30	180	9	10	0.4	No	SB-4065TR	FT-15	-	CC [®] T09T3... CC [®] W09T3...	
S20R- SCLC [®] /L09-22A	●	●	22	20	19	36	200	11	8							
S25S- SCLC [®] /L09-27A	●	●	27	25	24	46	250	13.5	6							

When using P chipbreaker : Right-hand Insert for Right-hand Toolholder, Left-hand Insert for Left-hand Toolholder.



● : Standard item R : Right-hand only L : Left-hand only □ : Check availability

C/E-SCLC-A(N) Carbide shank bar (Boring / Internal facing)

F
Boring

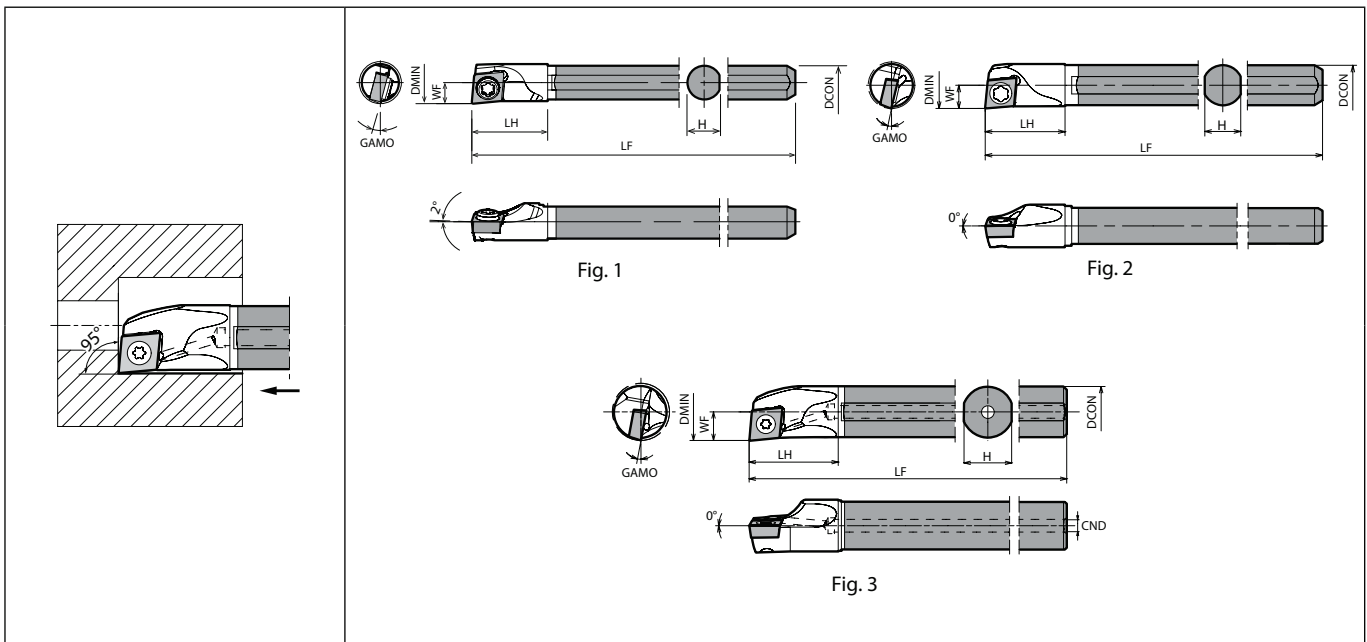

Max. Overhang Length L/D≈~7 | Right-hand shown
Left-hand Insert for Right-hand Toolholder, Right-hand Insert for Left-hand Toolholder.

Toolholder dimensions

Description	Availability		Dimension (mm)							GAMO (°)	Standard corner-R (RE)	Coolant hole	Fig.	Spare parts			Applicable inserts
	R	L	DMIN	DCON	CND	H	LH	LF	WF					Screw	Wrench	Wrench	
C04G- SCLC%03-05AN	●	●	5	4	-	3.8	7	90	2.5	15	0.2	No	1	SB-1635TR	-	FT-6	CC□T0301..., CC□W0301...
C05H- SCLC%03-06AN	●	●	6	5	-	4.4	9	100	3	13	0.2	No	2	SB-1635TR	-	FT-6	CC□T0301..., CC□W0301...
C06J- SCLC%04-07AN	●	●	7	6	-	5.4	10	110	3.5	13	0.2	No	2	SB-2035TR	-	FT-6	CC□T0401... CC□W0401...
C07K- SCLC%04-08AN	●	●	8	7	-	6.4	11	125	4	11							
E08L- SCLC%06-10AN	●	●	10	8	3	7	14	140	5	14	0.4	Yes	3	SB-2545TR	-	FT-8	CC□T0602... CC□W0602...
SCLCR06-10AN2/3	●	●				9	18	160	6	12							
E10N- SCLC%06-12AN	●	●	12	10		9	18	160	6	12							
SCLCR06-12AN2/3	●	●				9	18	105									
E12Q- SCLC%06-14A	●	●	14	12	4	11	23	180	7	10							
SCLCR06-14A-2/3	●	●				11	23	120									
E16X- SCLC%09-18A	●	●	18	16	4	15	28	220	9	10							
SCLCR09-18A-2/3	●	●				15	28	145									
E20S- SCLC%09-22A	●	●	22	20	6	19	32	250	11	8	0.4	Yes	3	SB-4065TR	FT-15	-	CC□T09T3... CC□W09T3...
SCLCR09-22A-2/3	●	●					19	32	165								
E25T- SCLC%09-27A	●	●	27	25		24	38	300	13.5	6							
SCLCR09-27A-2/3	●	●				24	38	200									



When using P chipbreaker : Right-hand Insert for Right-hand Toolholder, Left-hand Insert for Left-hand Toolholder.

● : Standard item R : Right-hand only L : Left-hand only □ : Check availability

Applicable inserts (A/S-SCLC-AE / S-SCLC-A / C/E-SCLC-A(N))

Applications	Minute ap	Finishing	Finishing	Finishing	Finishing	Finishing	Finishing - Medium	Finishing
Insert								
Chip Breaker Type	CF	PF	GF	SKS	SK	CK	GQ	WP
Page	B58	B58	B58	B59	B59	B59	B59	B60
Applications	Finishing	Finishing - Medium	Finishing - Medium	Medium	Medium	Finishing	Finishing	Finishing
Insert								
Chip Breaker Type	PP	GK	HQ	STD	MF	P/L-F	P/L-FSF	P/L-P
Page	B60	B60	B60	B60	B61	B62	B61	B63
Applications	Low feed	Low feed	Low feed	Stainless steel / Heat-resistant alloys	Cast iron	Non-Ferrous Metals	Non-Ferrous Metals	Non-Ferrous Metals
Insert								
Chip Breaker Type	P/L-U	P/L-USF	P/L-J	MQ	No CB	AP	P/L-A3	AH
Page	B63~B65	B63	B65	B61	B66	B66	B66	B66
Applications	Non-Ferrous Metals	Non-Ferrous Metals	Hard materials					
Insert								
Chip Breaker Type	PCD	APD	CBN					
Page	C39	C40	C20					



Recommended cutting conditions  F152, F153
 Applicable sleeves  F148~F151

A-SCLP-AE Excellent bar (Boring / Internal facing)

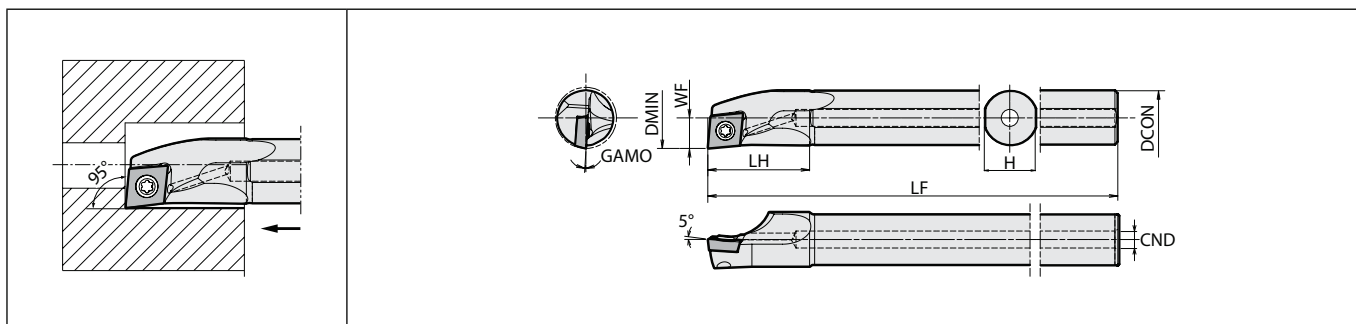

Max. Overhang Length L/D≈5.5 | Right-hand shown
Left-hand Insert for Right-hand Toolholder, Right-hand Insert for Left-hand Toolholder.

F

Toolholder dimensions

Description	Availability		Dimension (mm)								GAMO (°)	Standard corner-R(RE)	Coolant hole	Spare parts			Applicable inserts
														Screw	Wrench	Wrench	
	R	L	DMIN	DCON	CND	H	LH	LF	WF								
A10L- SCLP%08-12AE	●	●	12	10	3	9	20	140	6	5	0.4	Yes	SB-3060TR	-	FT-10	CP□B0802..., CP□H0802... CP□T0802...	
A12M- SCLP%08-14AE	●	●	14	12	4	11	24	150	7	4	0.4	Yes	SB-3060TR	-	FT-10	CP□B0802..., CP□H0802... CP□T0802...	
A12M- SCLP%09-16AE	●	●	16	12	4	11	24	150	8	4	0.4	Yes	SB-4065TR	FT-15	-	CP□B0903... CP□H0903... CP□T0903...	
A16Q- SCLP%09-18AE	●	●	18	16		15	30	180	9	3.5	0.4	Yes	SB-4065TR	FT-15	-	CP□B0903... CP□H0903... CP□T0903...	
A20R- SCLP%09-22AE	●	●	22	20	5	19	36	200	11	2	0.4	Yes	SB-4065TR	FT-15	-	CP□B0903... CP□H0903... CP□T0903...	
A25S- SCLP%09-27AE	●	●	27	25		24	46	250	13.5	0	0.4	Yes	SB-4065TR	FT-15	-	CP□B0903... CP□H0903... CP□T0903...	

S-SCLP-A Steel shank bar (Boring / Internal facing)

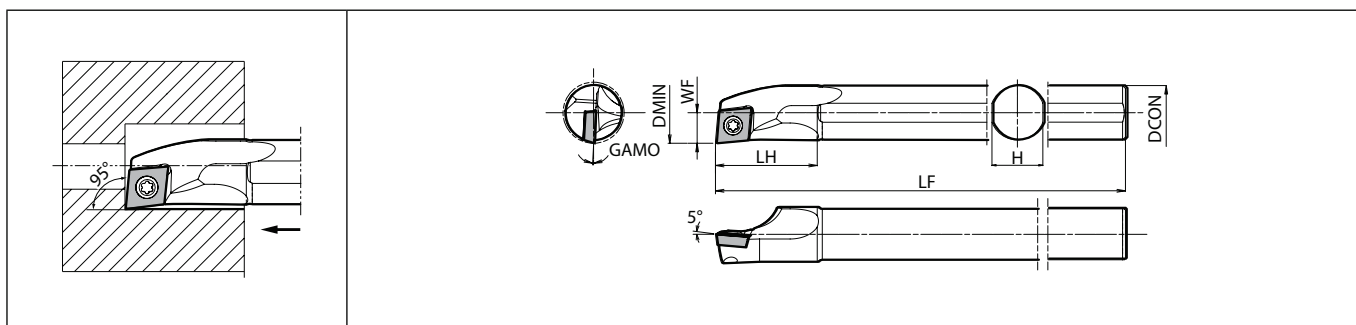

Max. Overhang Length L/D≈4 | Right-hand shown
Left-hand Insert for Right-hand Toolholder, Right-hand Insert for Left-hand Toolholder.

Toolholder dimensions

Description	Availability		Dimension (mm)								GAMO (°)	Standard corner-R(RE)	Coolant hole	Spare parts			Applicable inserts
														Screw	Wrench	Wrench	
	R	L	DMIN	DCON	H	LH	LF	WF									
S10L- SCLP%08-12A	●	●	12	10	9	20	140	6	5	0.4	No	SB-3060TR	-	FT-10	CP□B0802..., CP□H0802... CP□T0802...		
S12M- SCLP%08-14A	●	●	14	12	11	24	150	7	4	0.4	No	SB-3060TR	-	FT-10	CP□B0802..., CP□H0802... CP□T0802...		
S12M- SCLP%09-16A	●	●	16	12	11	24	150	8	4	0.4	No	SB-4065TR	FT-15	-	CP□B0903... CP□H0903... CP□T0903...		
S16Q- SCLP%09-18A	●	●	18	16	15	30	180	9	3.5	0.4	No	SB-4065TR	FT-15	-	CP□B0903... CP□H0903... CP□T0903...		
S20R- SCLP%09-22A	●	●	22	20	19	36	200	11	2	0.4	No	SB-4065TR	FT-15	-	CP□B0903... CP□H0903... CP□T0903...		
S25S- SCLP%09-27A	●	●	27	25	24	46	250	13.5	0	0.4	No	SB-4065TR	FT-15	-	CP□B0903... CP□H0903... CP□T0903...		

● : Standard item R : Right-hand only L : Left-hand only □ : Check availability

E-SCLP-A(N) Carbide shank bar (Boring / Internal facing)

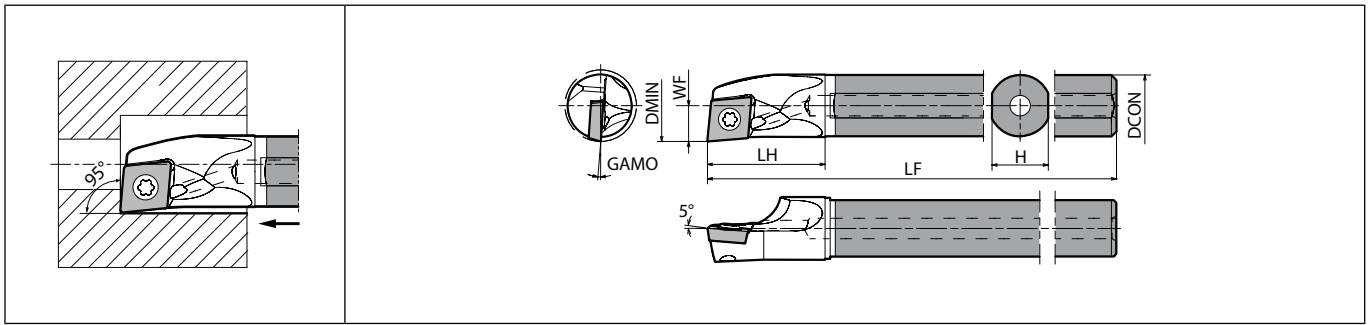

Max. Overhang Length L/D≈7 | Right-hand shown
Left-hand Insert for Right-hand Toolholder, Right-hand Insert for Left-hand Toolholder.

Toolholder dimensions

Description	Availability		Dimension (mm)							GAMO (°)	Standard corner-R(RE)	Coolant hole	Spare parts			Applicable inserts
	R	L	DMIN	DCON	CND	H	LH	LF	WF				Screw	Wrench	Wrench	
E10N- SCLP%08-12AN SCLPR08-12AN2/3 SCLPR08-12AN1/2	●	●	12	10	3	9	18	160	6	5	0.4	Yes	SB-3060TR	-	FT-10	CP□B0802... CP□H0802... CP□T0802...
	●							105								
	●							80								
E12Q- SCLP%08-14A SCLPR08-14A-2/3 SCLPR08-14A-1/2	●	●	14	12	4	11	23	180	7	4	0.4	Yes	SB-3060TR	-	FT-10	CP□B0802... CP□H0802... CP□T0802...
	●							120								
	●							90								
E12Q- SCLP%09-16A SCLPR09-16A-2/3 SCLPR09-16A-1/2	●	●	16	12	4	11	23	180	8	5	0.4	Yes	SB-3060TR	-	FT-10	CP□B0903... CP□H0903... CP□T0903...
	●							120								
	●							90								
E16X- SCLP%09-18A SCLPR09-18A-2/3 SCLPR09-18A-1/2	●	●	18	16	6	15	28	220	9	3.5	0.4	Yes	SB-4065TR	FT-15	-	CP□B0903... CP□H0903... CP□T0903...
	●							145								
	●							110								
E20S- SCLP%09-22A SCLPR09-22A-2/3 SCLPR09-22A-1/2	●	●	22	20	6	19	32	250	11	2	0.4	Yes	SB-4065TR	FT-15	-	CP□B0903... CP□H0903... CP□T0903...
	●							165								
	●							125								
E25T- SCLP%09-27A SCLPR09-27A-2/3	●	●	27	25	6	24	38	300	13.5	0	0.4	Yes	SB-4065TR	FT-15	-	CP□B0903... CP□H0903... CP□T0903...
	●							200								
	●															

Applicable inserts (A-SCLP-AE / S-SCLP-A / E-SCLP-A(N))

Applications	Finishing	Finishing	Finishing - Medium	Medium	Low carbon steel	Low carbon steel	Finishing - Medium	Cast iron
Insert								
Chip Breaker Type	PP	GP	HQ	STD	XP	XQ	Y-Y	No CB
Page	B67	B67	B67	B67	B67	B67	B67	B67
Applications	Non-Ferrous Metals		Hard materials					
Insert								
Chip Breaker Type	PCD		CBN					
Page	C41		C21					

Recommended cutting conditions F152, F153
Applicable sleeves F149~F151

● : Standard item R : Right-hand only L : Left-hand only □ : Check availability



A-SDUC-AE Excellent bar (Internal copying)

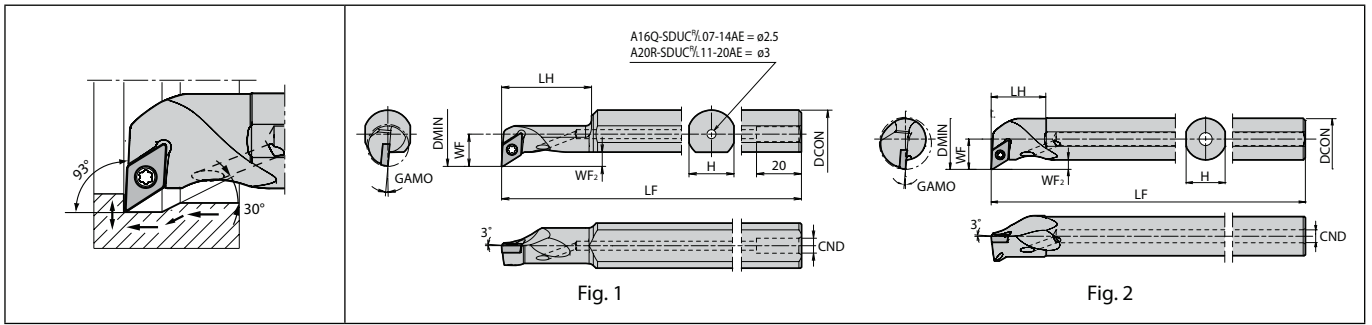

Max. Overhang Length L/D≈5.5 | Right-hand shown
Left-hand Insert for Right-hand Toolholder, Right-hand Insert for Left-hand Toolholder.

F

Toolholder dimensions

Description	Availability		Dimension (mm)									GAMO (°)	Standard corner-R(RE)	Coolant hole	Fig.	Spare parts			Applicable inserts
			R	L	DMIN	DCON	CND	H	LH	LF	WF					WF2	Screw	Wrench	
A10L- SDUC%.07-14AE	●	●	14	10	3	9	19	140	8.7	3.3	5	0.4	Yes	2	SB-2560TR	-	FT-8	DC□T0702... DC□W0702... DC□X0702...	
A12M- SDUC%.07-16AE	●	●	16	12	4	11	21	150	9.7	2									
A16Q- SDUC%.07-14AE	●	●	14	16	5	15	28	180	10.8	4.4									1
A16Q- SDUC%.07-20AE	●	●	20			21	180	11.7	3.3	2									
A16Q- SDUC%.11-23AE	●	●	23	16	5	15	21	180	14.5	6.1	5	0.4	Yes	2	SB-4065TR	FT-15	-	DC□T11T3... DC□W11T3... DC□X11T3...	
A20R- SDUC%.11-20AE	●	●	20	20		19	48	200	15.6										1
A20R- SDUC%.11-27AE	●	●	27			23	200	16.5	2										
A25S- SDUC%.11-32AE	●	●	32	25		24	24	250	19					2					

For WP chipbreaker, cutting edge offsets or program corrections are required on R36 and R37.

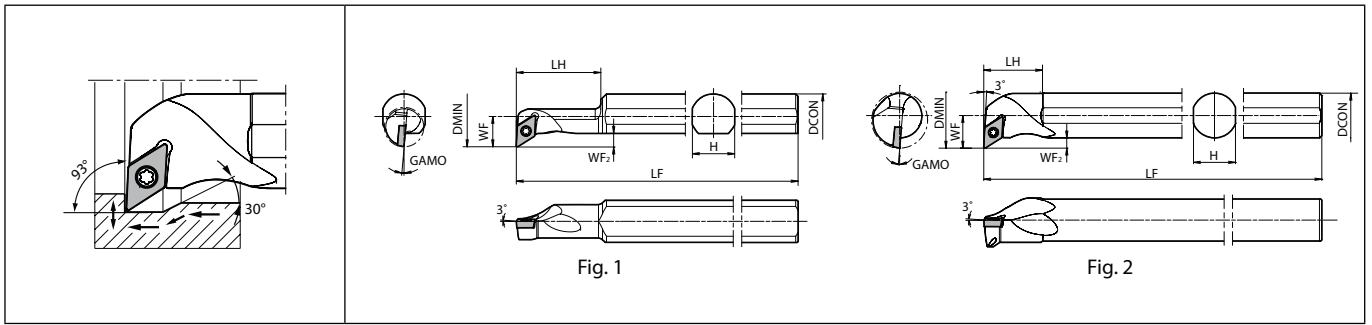

● : Standard item R : Right-hand only L : Left-hand only □ : Check availability

S-SDUC-A Steel shank bar (Internal copying)



Max. Overhang Length $L/D \approx 4$ | Right-hand shown
Left-hand Insert for Right-hand Toolholder, Right-hand Insert for Left-hand Toolholder.

Toolholder dimensions

Description	Availability		Dimension (mm)							GAMO (°)	Standard corner-R(RE)	Coolant hole	Fig.	Spare parts			Applicable inserts
														Screw	Wrench	Wrench	
	R	L	DMIN	DCON	H	LH	LF	WF	WF ₂								
S10L- SDUC ^{CP} %.07-14A	●	●	14	10	9	19	140	8.7	3.3	5	0.4	No	2	SB-2560TR	-	FT-8	DC□T0702... DC□W0702... DC□X0702...
S12M- SDUC ^{CP} %.07-16A	●	●	16	12	11	21	150	9.7									
S16Q- SDUC ^{CP} %.07-14A	●	●	14	16	15	28	180	10.8									
SDUC ^{CP} %.07-20A	●	●	20		21	11.7	3.3										
S16Q- SDUC ^{CP} %.11-23A	●	●	23	16	15	21	180	14.5	6.1	5	0.4	No	2	SB-4065TR	FT-15	-	DC□T11T3... DC□W11T3... DC□X11T3...
S20R- SDUC ^{CP} %.11-20A	●	●	20	20	19	48	200	15.6									
SDUC ^{CP} %.11-27A	●	●	27		23	16.5											
S25S- SDUC ^{CP} %.11-32A	●	●	32	25	24	24	250	19					2				

For WP chipbreaker, cutting edge offsets or program corrections are required on R36 and R37.



E-SDUC-A Carbide shank bar (Internal copying)

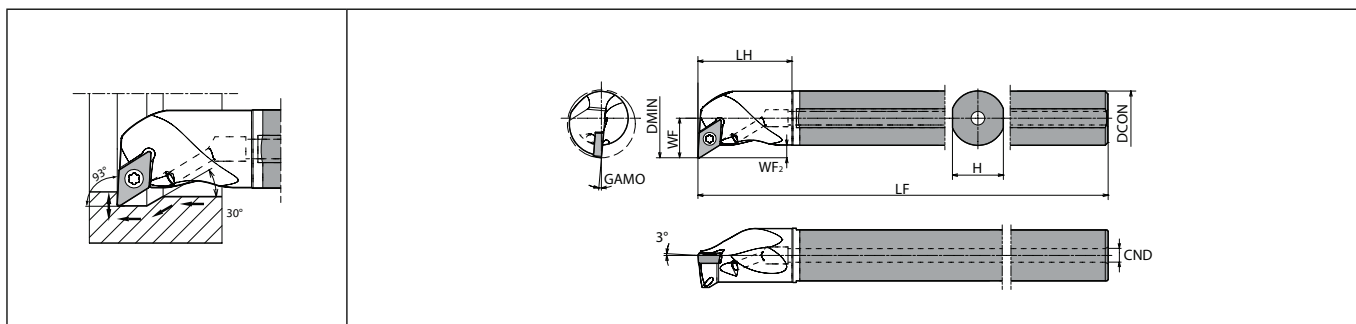

Max. Overhang Length $L/D \sim 7$ | Right-hand shown
 Left-hand Insert for Right-hand Toolholder, Right-hand Insert for Left-hand Toolholder.

F

Toolholder dimensions



Boring

Description	Availability		Dimension (mm)								GAMO (°)	Standard corner-R(RE)	Coolant hole	Spare parts			Applicable inserts
														Screw	Wrench	Wrench	
E10N- SDUC ^{CP} 07-14A SDUCR07-14A-2/3	●	●	14	10	3	9	20	$\frac{160}{105}$	8.7	3.3	5	0.4	Yes	SB-2560TR	-	FT-8	DC□T0702... DC□W0702... DC□X0702...
E12Q- SDUC ^{CP} 07-16A SDUCR07-16A-2/3	●	●	16	12	4	11	23	$\frac{180}{120}$	9.7								
E16X- SDUC ^{CP} 07-20A SDUCR07-20A-2/3	●	●	20	16		15	28	$\frac{220}{145}$	11.7								
E16X- SDUC ^{CP} 11-23A SDUCR11-23A-2/3	●	●	23	16	4	15	28	$\frac{220}{145}$	14.5	6.1	5	0.4	Yes	SB-4065TR	FT-15	-	DC□T11T3... DC□W11T3... DC□X11T3...
E20S- SDUC ^{CP} 11-27A SDUCR11-27A-2/3	●	●	27	20	6	19	32	$\frac{250}{165}$	16.5								
E25T- SDUC ^{CP} 11-32A SDUCR11-32A-2/3	●	●	32	25		24	38	$\frac{300}{200}$	19								

For WP chipbreaker, cutting edge offsets or program corrections are required on **R36** and **R37**.

● : Standard item R : Right-hand only L : Left-hand only □ : Check availability

Applicable inserts (A-SDUC-AE / S-SDUC-A / E-SDUC-A)

Applications	Minute ap	Finishing	Finishing	Finishing	Finishing	Finishing - Medium	Finishing	Finishing
Insert								
Chip Breaker Type	CF	GF	SKS	SK	CK	GQ	WP	1/2-WP
Page	B68	B68	B68	B68	B68	B69	B69	B69
Applications	Finishing	Finishing	Finishing - Medium	Finishing - Medium	Medium	Medium	Finishing	Finishing
Insert								
Chip Breaker Type	PP	GP	GK	HQ	STD	MF	1/2-F	1/2-FSF
Page	B69	B69	B70	B70	B70	B70	B72, B73	B72
Applications	Low feed	Low feed	Low feed	Low feed	Low carbon steel	Low carbon steel	Stainless steel / Heat-resistant alloys	Cast iron
Insert								
Chip Breaker Type	1/2-U	1/2-USF	1/2-J	1/2-JSF	XP	XQ	MQ	No CB
Page	B74~B76	B74	B77	B76	B71	B71	B71	B78
Applications	Non-Ferrous Metals	Non-Ferrous Metals	Non-Ferrous Metals	Non-Ferrous Metals	Non-Ferrous Metals	Hard materials		
Insert								
Chip Breaker Type	AP	1/2-A3	AH	PCD	APD	CBN		
Page	B78	B78	B78	C42	C42	C22		

Recommended cutting conditions  F152, F153

Applicable sleeves  F149~F151



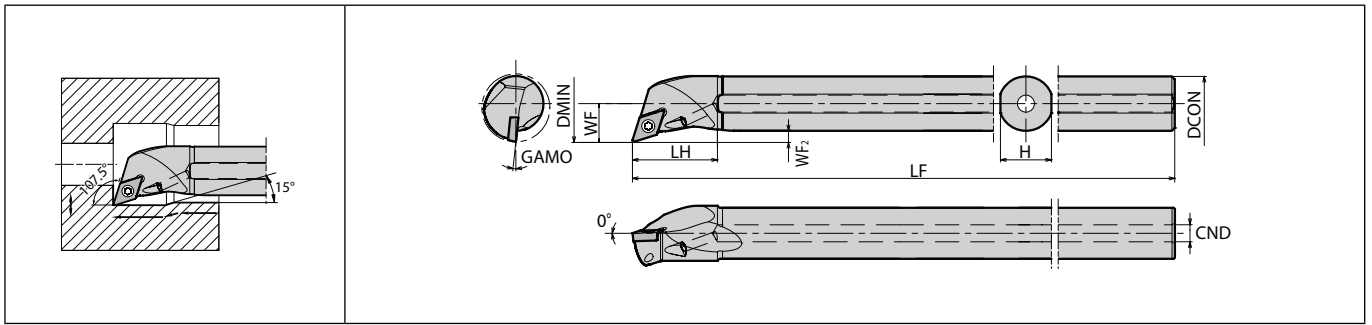

A-SDQC-AE Excellent bar (Internal copying)



Max. Overhang Length L/D≈5.5 | Right-hand shown
Left-hand Insert for Right-hand Toolholder, Right-hand Insert for Left-hand Toolholder.

F

Toolholder dimensions

Description	Availability		Dimension (mm)									GAMO (°)	Standard corner-R(RE)	Coolant hole	Spare parts			Applicable inserts
	R	L	DMIN	DCON	CND	H	LH	LF	WF	WF2	Screw				Wrench	Wrench		
																		
A10L- SDQC%07-13AE	●	●	13	10	3	9	19	140	7.5	2.1	10	0.4	Yes	SB-2560TR	-	FT-8	DC□T0702... DC□W0702...	
A12M- SDQC%07-16AE	●	●	16	12	4	11	22	150	9.25	8								
A16Q- SDQC%07-20AE	●	●	20	16	5	15	25	180	11.3	6								
A20R- SDQC%11-25AE	●	●	25	20	5	19	31	200	14.4	3.7	5	0.4	Yes	SB-4065TR	FT-15	-	DC□T11T3... DC□W11T3...	
A25S- SDQC%11-30AE	●	●	30	25		24	38	250	16.9									4

WP chipbreaker (DCMX-WP : Wiper insert) is not applicable to A-SDQC-AE Toolholders.

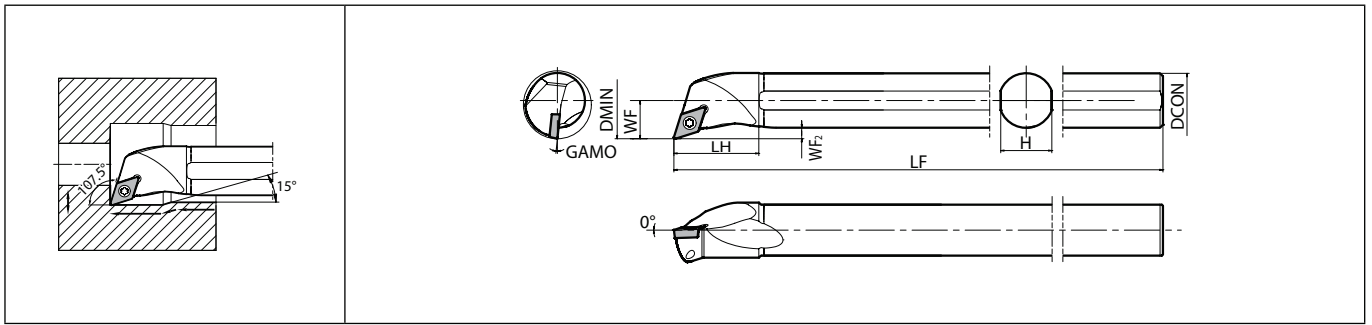

● : Standard item R : Right-hand only L : Left-hand only □ : Check availability

S-SDQC-A Steel shank bar (Internal copying)



Max. Overhang Length $L/D \approx 4$ | Right-hand shown
 Left-hand Insert for Right-hand Toolholder, Right-hand Insert for Left-hand Toolholder.

Toolholder dimensions

Description	Availability		Dimension (mm)								GAMO (°)	Standard corner-R(RE)	Coolant hole	Spare parts			Applicable inserts
														Screw	Wrench	Wrench	
	R	L	DMIN	DCON	H	LH	LF	WF	WF ₂								
S10L- SDQC%07-13A	●	●	13	10	9	19	140	7.5	2.1	10	0.4	No	SB-2560TR	-	FT-8	DC□T0702... DC□W0702...	
S12M- SDQC%07-16A	●	●	16	12	11	22	150	9.25	2.6								
S16Q- SDQC%07-20A	●	●	20	16	15	25	180	11.3	3.7	5	0.4	No	SB-4065TR	FT-15	-	DC□T11T3... DC□W11T3...	
S20R- SDQC%11-25A	●	●	25	20	19	31	200	14.4	4								
S25S- SDQC%11-30A	●	●	30	25	24	38	250	16.9									

WP chipbreaker (DCMX-WP : Wiper insert) is not applicable to S-SDQC-A Toolholders.



E-SDQC-A Carbide shank bar (Internal copying)

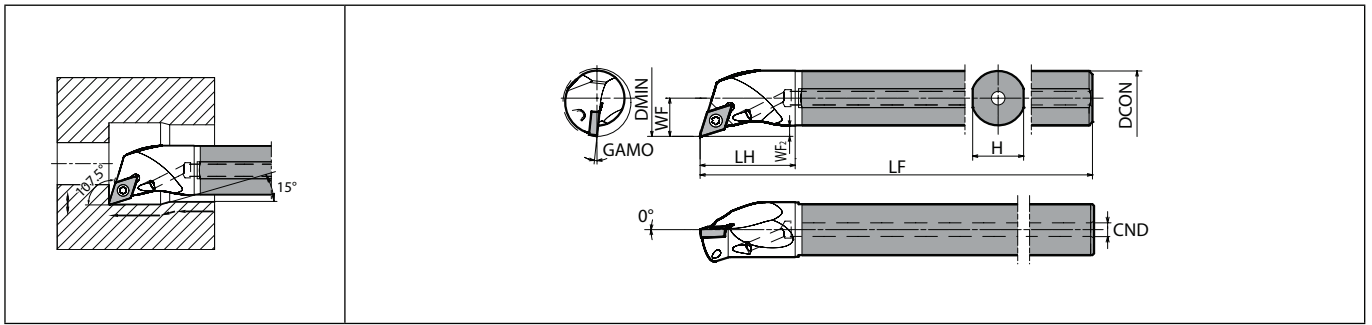

Max. Overhang Length $L/D \approx 7$ | Right-hand shown
 Left-hand Insert for Right-hand Toolholder, Right-hand Insert for Left-hand Toolholder.

F

Toolholder dimensions



- Solid
- Positive
- AD bars
- Negative

Description	Availability		Dimension (mm)									GAMO (°)	Standard corner-R(RE)	Coolant hole	Spare parts			Applicable inserts
			R	L	DMIN	DCON	CND	H	LH	LF	WF				WF2	Screw	Wrench	
E10N- SDQC [®] /07-13A SDQCR07-13A-2/3	●	●	13	10	3	9	20	160 105	7.5	2.1	10							
E12Q- SDQC [®] /07-16A SDQCR07-16A-2/3	●	●	16	12	4	11	23	180 120	9.25	2.6	8	0.4	Yes	SB-2560TR	-	FT-8	DC□T0702... DC□W0702...	
E16X- SDQC [®] /07-20A SDQCR07-20A-2/3	●	●	20	16		15	28	220 145	11.3	6								
E20S- SDQC [®] /11-25A SDQCR11-25A-2/3	●	●	25	20	6	19	32	250 165	14.4	3.7	5	0.4	Yes	SB-4065TR	FT-15	-	DC□T11T3... DC□W11T3...	
E25T- SDQC [®] /11-30A SDQCR11-30A-2/3	●	●	30	25		24	38	300 200	16.9	4								

WP chipbreaker (DCMX-WP : Wiper insert) is not applicable to E-SDQC-A Toolholders.

● : Standard item R : Right-hand only L : Left-hand only □ : Check availability

Applicable inserts (A-SDQC-AE / S-SDQC-A / E-SDQC-A)

Applications	Minute ap	Finishing	Finishing	Finishing	Finishing	Finishing - Medium	Finishing	Finishing
Insert								
Chip Breaker Type	CF	GF	SKS	SK	CK	GQ	PP	GP
Page	B68	B68	B68	B68	B68	B69	B69	B69
Applications	Finishing - Medium	Finishing - Medium	Medium	Medium	Finishing	Finishing	Low feed	Low feed
Insert								
Chip Breaker Type	GK	HQ	STD	MF	%L-F	%L-FSF	%L-U	%L-USF
Page	B70	B70	B70	B70	B72, B73	B72	B74~B76	B74
Applications	Low feed	Low feed	Low carbon steel	Low carbon steel	Stainless steel / Heat-resistant alloys	Cast iron	Non-Ferrous Metals	Non-Ferrous Metals
Insert								
Chip Breaker Type	%L-J	%L-JSF	XP	XQ	MQ	No CB	AP	%L-A3
Page	B77	B76	B71	B71	B71	B78	B78	B78
Applications	Non-Ferrous Metals	Non-Ferrous Metals	Non-Ferrous Metals	Hard materials				
Insert								
Chip Breaker Type	AH	PCD	APD	CBN				
Page	B78	C42	C42	C22				



Recommended cutting conditions [F152, F153](#)
 Applicable sleeves [F149~F151](#)

A-SDZC-AE Excellent bar (Back boring)

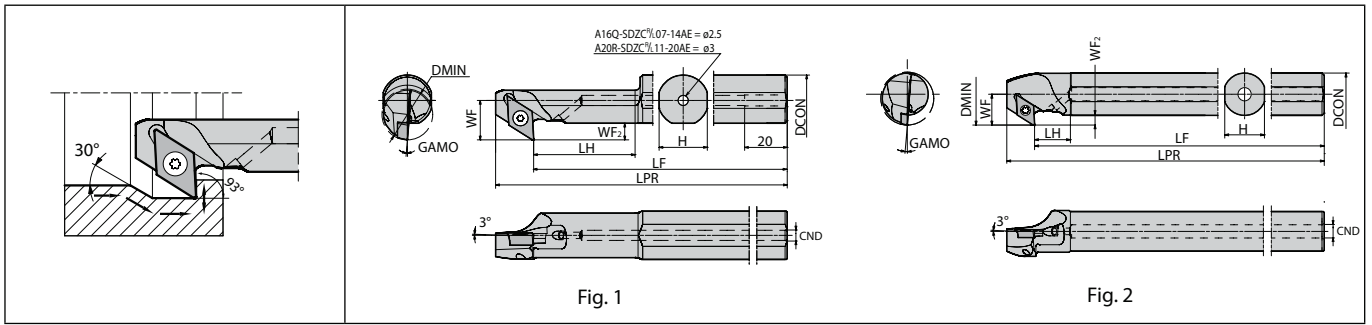

Max. Overhang Length L/D≈5.5 | Right-hand shown
Right-hand Insert for Right-hand Toolholder, Left-hand Insert for Left-hand Toolholder.

F

Toolholder dimensions

Description	Availability		Dimension (mm)										GAMO (°)	Standard corner-R(RE)	Coolant hole	Fig.	Spare parts			Applicable inserts	
	R	L	DMIN	DCON	CND	H	LH	LPR	LF	WF	WF2	Screw					Wrench	Wrench			
A10L- SDZC%07-14AE	●	●	14	10	3	9	14	140	130.5	8.7	3.3	5	0.4	Yes	2	SB-2545TR	-	FT-8	DC□T0702... DC□W0702... DC□X0702...		
A12M- SDZC%07-16AE	●	●	16	12	4	11	14	150	139.5	9.7	3.3					2				SB-2560TR	
A16Q- SDZC%07-14AE	●	●	14	16	5	15	30	180	170	10.8	4.4	5	0.4	Yes	1	SB-2545TR	-	FT-8			
A16Q- SDZC%07-20AE	●	●	20				14									169.5				11.7	3.3
A16Q- SDZC%11-23AE	●	●	23	16	5	15	15	180	165	14.5	6.1	5	0.4	Yes	2	SB-4065TR	FT-15	-		DC□T11T3... DC□W11T3... DC□X11T3...	
A20R- SDZC%11-20AE	●	●	20	20		19	40	200	185	15.6											1
A20R- SDZC%11-27AE	●	●	27	20		19	200	185	16.5	2											
A25S- SDZC%11-32AE	●	●	32	25	24	15	250	235	19	2											

For WP chipbreaker, cutting edge offsets or program corrections are required on R36 and R37.

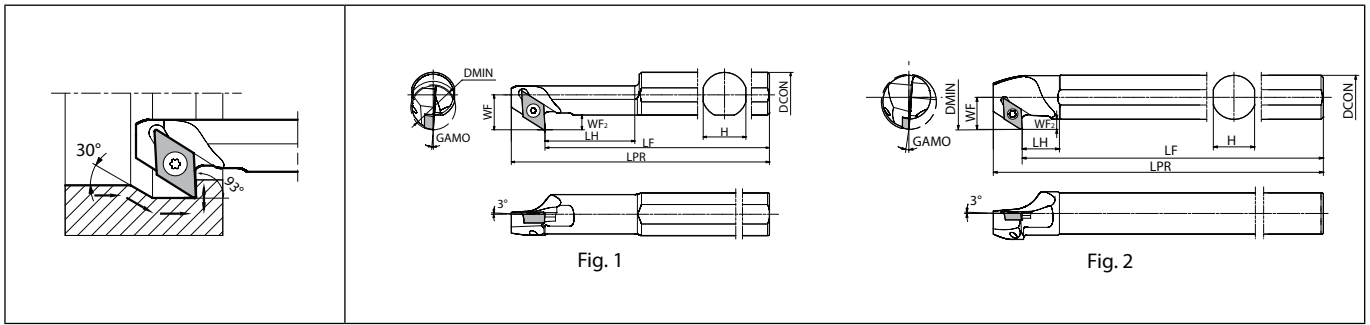

● : Standard item R : Right-hand only L : Left-hand only □ : Check availability

S-SDZC-A Steel shank bar (Back boring)

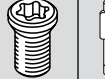

Max. Overhang Length $L/D \approx 4$ | Right-hand shown
Right-hand Insert for Right-hand Toolholder, Left-hand Insert for Left-hand Toolholder.

Toolholder dimensions

Description	Availability		Dimension (mm)									GAMO (°)	Standard corner-R(RE)	Coolant hole	Fig.	Spare parts			Applicable inserts
																Screw	Wrench	Wrench	
	R	L	DMIN	DCON	H	LH	LPR	LF	WF	WF2									
S10L- SDZC%07-14A	●	●	14	10	9	14	140	130.5	8.7	3.3	5	0.4	No	2	SB-2545TR	-	FT-8	DC□T0702... DC□W0702... DC□X0702...	
S12M- SDZC%07-16A	●	●	16	12	11	14	150	139.5	9.7	2				SB-2560TR					
S16Q- SDZC%07-14A	●	●	14	16	15	30	180	170	10.8	4.4	5	0.4	No	1	SB-2545TR	-	FT-8		
SDZC%07-20A	●	●	20			14	180	169.5	11.7	3.3				2	SB-2560TR				
S16Q- SDZC%11-23A	●	●	23	16	15	15	180	165	14.5	6.1	5	0.4	No	2	SB-4065TR	FT-15	-	DC□T11T3... DC□W11T3... DC□X11T3...	
S20R- SDZC%11-20A	●	●	20	20	19	40	200	185	15.6					1					
SDZC%11-27A	●	●	27			15	200	185	16.5	2									
S25S- SDZC%11-32A	●	●	32	25	24	15	250	235	19	2	2								

For WP chipbreaker, cutting edge offsets or program corrections are required on R36 and R37.

● : Standard item R : Right-hand only L : Left-hand only □ : Check availability



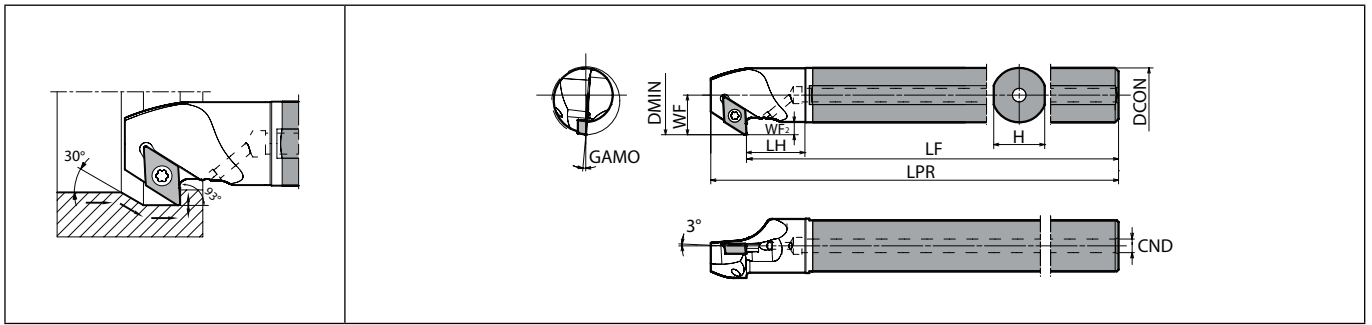

E-SDZC-A Carbide shank bar (Back boring)



Max. Overhang Length L/D≈7 | Right-hand shown
Right-hand Insert for Right-hand Toolholder.

F

Toolholder dimensions

Description	Availability	Dimension (mm)										GAMO (°)	Standard corner-R(RE)	Coolant hole	Spare parts			Applicable inserts
		R	DMIN	DCON	CND	H	LH	LPR	LF	WF	WF2				Screw	Wrench	Wrench	
																		
E10N- SDZCR07-14A	●	14	10	3	9	10.5	160	150.5	8.7						SB-2545TR			DC□T0702...
E12Q- SDZCR07-16A	●	16	12	4	11	12.5	180	169.5	9.7	3.3	5	0.4	Yes	SB-2560TR	-	FT-8	DC□W0702... DC□X0702...	
E16X- SDZCR07-20A	●	20	16		15	17.5	220	209.5	11.7									
E16X- SDZCR11-23A	●	23	16	4	15	13	220	205	14.5	6.1	5	0.4	Yes	SB-4065TR	FT-15	-	DC□T11T3..., DC□W11T3... DC□X11T3...	
E20S- SDZCR11-27A	●	27	20	6	19	17	250	235	16.5									

For WP chipbreaker, cutting edge offsets or program corrections are required on **R36** and **R37**.

● : Standard item R : Right-hand only L : Left-hand only □ : Check availability

Applicable inserts (A-SDZC-AE / S-SDZC-A / E-SDZC-A)

Applications	Minute ap	Finishing	Finishing	Finishing	Finishing	Finishing - Medium	Finishing	Finishing
Insert								
Chip Breaker Type	CF	GF	SKS	SK	CK	GQ	WP	F/L-WP
Page	B68	B68	B68	B68	B68	B69	B69	B69
Applications	Finishing	Finishing	Finishing - Medium	Finishing - Medium	Medium	Medium	Finishing	Finishing
Insert								
Chip Breaker Type	PP	GP	GK	HQ	STD	MF	F/L-F	F/L-FSF
Page	B69	B69	B70	B70	B70	B70	B72, B73	B72
Applications	Low feed	Low feed	Low feed	Low feed	Low carbon steel	Low carbon steel	Stainless steel / Heat-resistant alloys	Cast iron
Insert								
Chip Breaker Type	F/L-U	F/L-USF	F/L-J	F/L-JSF	XP	XQ	MQ	No CB
Page	B74~B76	B74	B77	B76	B71	B71	B71	B78
Applications	Non-Ferrous Metals	Non-Ferrous Metals	Non-Ferrous Metals	Non-Ferrous Metals	Non-Ferrous Metals	Hard materials		
Insert								
Chip Breaker Type	AP	F/L-A3	AH	PCD	APD	CBN		
Page	B78	B78	B78	C42	C42	C22		

Recommended cutting conditions  F152, F153

Applicable sleeves  F149~F151

F



Boring

C-SJLC Carbide shank bar (Boring / Internal facing)

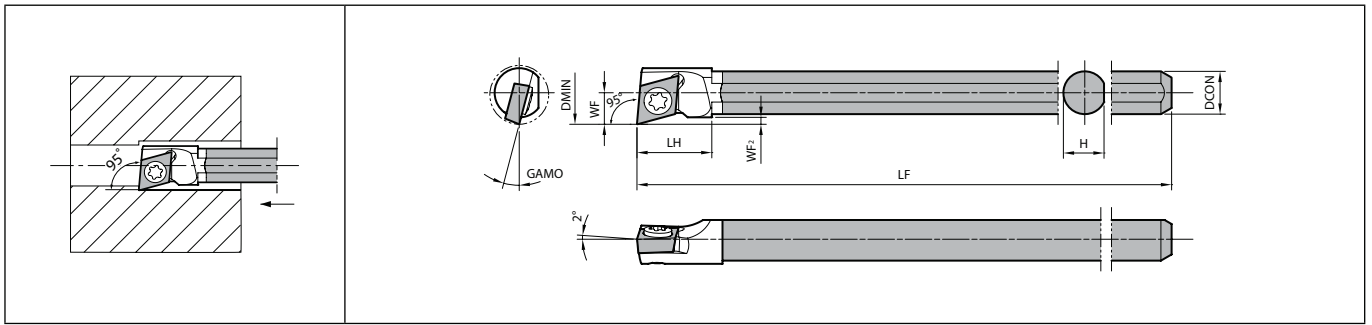

Max. Overhang Length L/D≈7 | Right-hand shown
Left-hand Insert for Right-hand Toolholder, Right-hand Insert for Left-hand Toolholder.

F

Toolholder dimensions

Description	Availability		Dimension (mm)							GAMO (°)	Standard corner-R(RE)	Coolant hole	Spare parts		Applicable inserts
			Screw	Wrench											
	R	L	DMIN	DCON	H	LH	LF	WF	WF ₂	SB-1635TR	FT-6				
C04X- SJLC [®] /03-055	●	●	5.5	4	3.8	7	91	2.95	0.65	15	0.03	No			JC□T0301...

Applicable inserts

Applications	Finishing	Finishing
Insert		
Chip Breaker Type	[®] /L-F	[®] /L-FSF
Page	B80	B80

Recommended cutting conditions ➡ F152, F153

Applicable sleeves ➡ F148, F150, F151

• Features of C-SJLC

1. Specially designed for minimized bore dia.
2. A relief angle of 15° ensures high flexibility of the tool pass during necking.
3. Retaining front relief angle 5° and good surface roughness during internal facing.

● : Standard item R : Right-hand only L : Left-hand only □ : Check availability



Boring

Solid

Positive

AD bars

Negative

C-SJZC Carbide shank bar (Back boring)

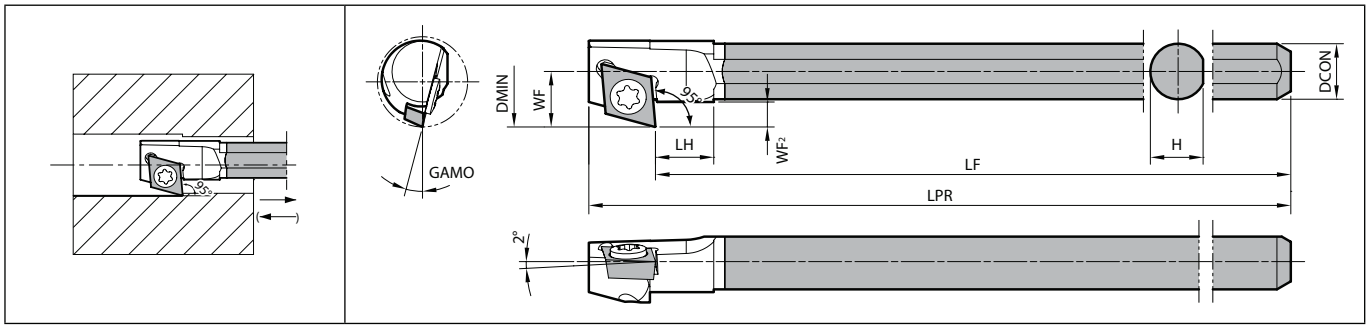

Max. Overhang Length $L/D \approx 7$ | Right-hand shown
 Right-hand Insert for Right-hand Toolholder, Left-hand Insert for Left-hand Toolholder.
 When using Right-hand Toolholder, use Right-hand insert if machining from back to front in this direction (→).
 Use Left-hand insert if machining from front to back in this direction (←).

Toolholder dimensions

Description	Availabi- lity		Dimension (mm)									GAMO (°)	Standard corner-R/(RE)	Coolant hole	Spare parts		Applicable inserts
			Screw	Wrench													
	R	L	DMIN	DCON	H	LH	LPR	LF	WF	WF ₂	SB-1635TR				FT-6		
C04X- SJZC [®] /03-065	●	●	6.5	4	3.8	4	93	88.1	4	1.8	15	0.03	No	SB-1635TR	FT-6	JC□T0301...	



Applicable inserts

Applications	Finishing	Finishing
Insert		
Chip Breaker Type	^F / _L -F	^F / _L -FSF
Page	B80	B80

Recommended cutting conditions ➡ F152, F153

Applicable sleeves ➡ F148, F150, F151

• Features of C-SJZC

1. Back boring bars for workpiece that require high concentric circle accuracy and when a change of chuck is not possible.
2. Available for back boring and necking.
3. Despite the small size of minimum boring dia. as $\phi 6.5$, the edge gap is retained as large as 1.8 mm.

● : Standard item R : Right-hand only L : Left-hand only □ : Check availability

A/S-STLB(P)-AE Excellent bar (Boring / Internal facing)

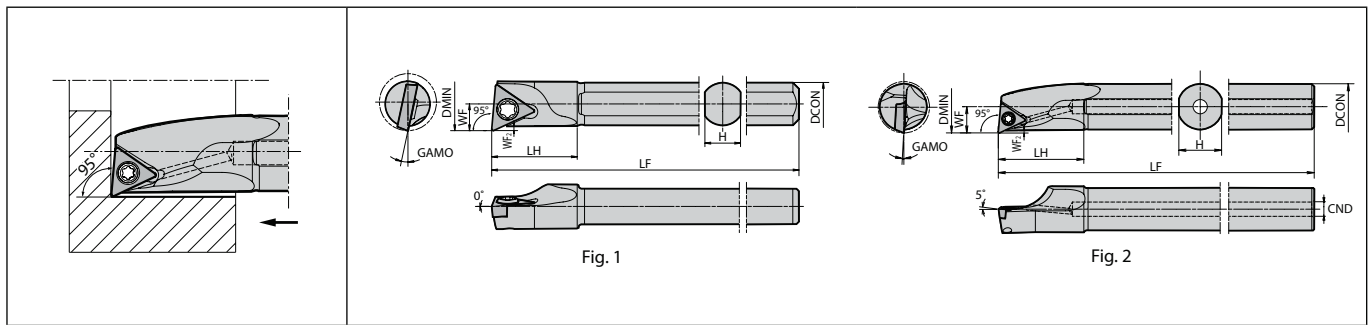

Max. Overhang Length L/D≈5.5 | Right-hand shown
Left-hand Insert for Right-hand Toolholder, Right-hand Insert for Left-hand Toolholder.

F

Toolholder dimensions

Description	Availability		Dimension (mm)									GAMO (°)	Standard corner-R(RE)	Coolant hole	Fig.	Spare parts			Applicable inserts
	R	L	DMIN	DCON	CND	H	LH	LF	WF	WF2	Screw					Wrench	Wrench		
S06H- STLB%L06-08AE	●	●	8	6	-	5	12	100	3.8	0.5	12	0.2	No	1	SB-2035TR		FT-6	TB□T0601..., TB□W0601...	
A08X- STLP%L08-10AE	●	●	10	8	2.5	7	16	120	5	0.5	10	0.4	Yes	2	SB-1TR	-	FT-6	TP□B0802..., TP□H0802... TP□T0802...	
A08X- STLP%L09-10AE	●	●	10	8	2.5	7	16	120	5	0.5	10	0.4	Yes	2	SB-2545TR	-	FT-8	TP□B0902... TP□H0902... TP□T0902... TP□X0902...	
A10L- STLP%L09-12AE	●	●	12	10	3	9	20	140	6.2	0.9	8								
A12M- STLP%L09-16AE	●	●	16	12	4	11	24	150	8	0.6	5								
A10L- STLP%L11-12AE	●	●	12	10	3	9	20	140	6	0.7	10	0.4	Yes	2	SB-3060TR	-	FT-10	TP□B1103... TP□H1103... TP□T1103... TP□X1103...	
A12M- STLP%L11-14AE	●	●	14	12	4	11	24	150	7.2	0.8	7								
A16Q- STLP%L11-18AE	●	●	18	16	5	15	30	180	9.2	0.7	3.5								
A20R- STLP%L11-22AE	●	●	22	20		19	36	200	11.2		2								
A20R- STLP%L16-25AE	●	●	25	20	5	19	36	200	13	0.7	0	0.4	Yes	2	SB-4065TR	FT-15	-	TP□B1603... TP□H1603... TP□T1603...	
A25S- STLP%L16-27AE	●	●	27	25		24	46	250	13.7										

For WP chipbreaker, cutting edge offsets or program corrections are required on **R36** and **R37**.
When using P chipbreaker : Right-hand Insert for Right-hand Toolholder, Left-hand Insert for Left-hand Toolholder.

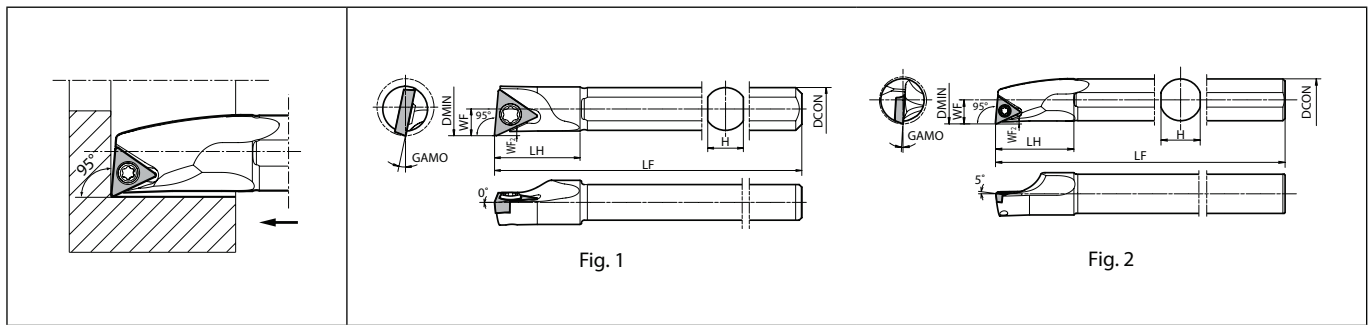

● : Standard item R : Right-hand only L : Left-hand only □ : Check availability

S-STLB(P)-A Steel shank bar (Boring / Internal facing)



Max. Overhang Length $L/D \approx 4$ | Right-hand shown
Left-hand Insert for Right-hand Toolholder, Right-hand Insert for Left-hand Toolholder.

Toolholder dimensions

Description	Availability		Dimension (mm)							GAMO (°)	Standard corner-R(RE)	Coolant hole	Fig.	Spare parts			Applicable inserts
														Screw	Wrench	Wrench	
	R	L	DMIN	DCON	H	LH	LF	WF	WF ₂								
S06H- STLB%L06-08A	●	●	8	6	5	12	100	3.8	0.5	12	0.2	No	1	SB-2035TR		FT-6	TB□T0601..., TB□W0601...
S08X- STLP%L08-10A	●	●	10	8	7	16	120	5	0.5	10	0.4	No	2	SB-1TR	-	FT-6	TP□B0802..., TP□H0802... TP□T0802...
S08X- STLP%L09-10A	●	●	10	8	7	16	120	5	0.5	10	0.4	No	2	SB-2545TR	-	FT-8	TP□B0902... TP□H0902... TP□T0902... TP□X0902...
S10L- STLP%L09-12A	●	●	12	10	9	20	140	6.2	0.9	8							
S12M- STLP%L09-16A	●	●	16	12	11	24	150	8	0.6	5							
S10L- STLP%L11-12A	●	●	12	10	9	20	140	6	0.7	10	0.4	No	2	SB-3060TR	-	FT-10	TP□B1103... TP□H1103... TP□T1103... TP□X1103...
S12M- STLP%L11-14A	●	●	14	12	11	24	150	7.2	0.8	7							
S16Q- STLP%L11-18A	●	●	18	16	15	30	180	9.2	0.7	3.5							
S20R- STLP%L11-22A	●	●	22	20	19	36	200	11.2	0.7	2	0.4	No	2	SB-4065TR	FT-15	-	TP□B1603..., TP□H1603... TP□T1603...
S25S- STLP%L16-27A	●	●	27	25	24	46	250	13.7	0.7	0							

For WP chipbreaker, cutting edge offsets or program corrections are required on **R36** and **R37**.
When using P chipbreaker : Right-hand Insert for Right-hand Toolholder, Left-hand Insert for Left-hand Toolholder.

● : Standard item R : Right-hand only L : Left-hand only □ : Check availability



C/E-STLB(P)-A(N) Carbide shank bar (Boring / Internal facing)

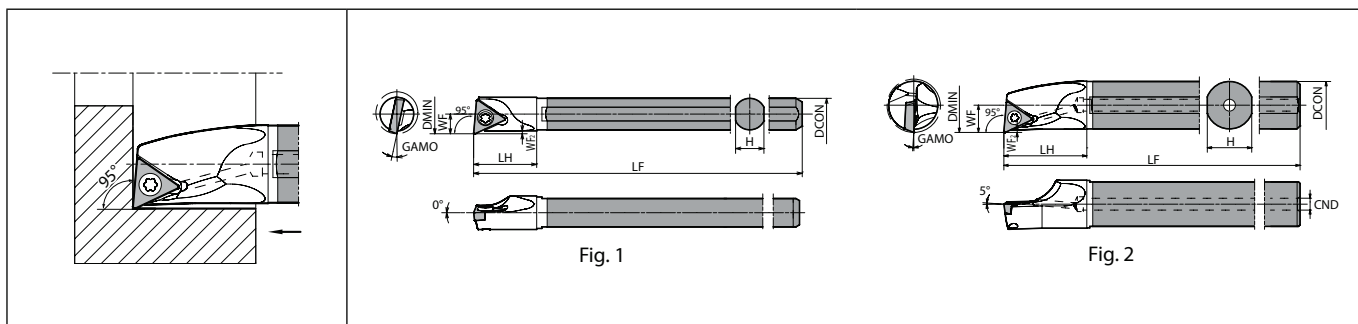

Max. Overhang Length L/D≈~7 | Right-hand shown
Left-hand Insert for Right-hand Toolholder, Right-hand Insert for Left-hand Toolholder.

F

Toolholder dimensions



Boring

Solid

Positive

AD bars

Negative



Description	Availability		Dimension (mm)									GAMO (°)	Standard corner-R(RE)	Coolant hole	Fig.	Spare parts			Applicable inserts
	R	L	DMIN	DCON	CND	H	LH	LF	WF	WF2	Screw					Wrench	Wrench		
C06J- STLB%06-08AN	●	●	8	6	-	5.4	10	110	3.8	0.5	12	0.2	No	1	SB-2035TR	-	FT-6	TB□T0601..., TB□W0601...	
E08L- STLP%08-10AN	●	●	10	8	3	7	14	140	5	0.5	10	0.4	Yes	2	SB-1TR	-	FT-6	TP□B0802..., TP□H0802... TP□T0802...	
E08L- STLP%09-10AN	●	●	10	8		7	14	140	5	0.5	10							TP□B0902... TP□H0902... TP□T0902... TP□X0902...	
E10N- STLP%09-12AN	●	●			3	9	18	105	6.2	0.9	8	0.4	Yes	2	SB-2545TR	-	FT-8		
STLPR09-12AN2/3	●		12	10				80											
E12Q- STLPR09-12AN1/2	●							180											
E12Q- STLP%09-16A	●	●						180											
STLPR09-16A-2/3	●		16	12	4	11	23	120	8	0.6	5								
STLPR09-16A-1/2	●							90											
E10N- STLP%11-12AN	●	●						160											
STLPR11-12AN2/3	●		12	10	3	9	18	105	6	0.7	10								
STLPR11-12AN1/2	●							80											
E12Q- STLP%11-14A	●	●						180											
STLPR11-14A-2/3	●		14	12		11	23	120	7.2	0.8	7								
STLPR11-14A-1/2	●							90											
E16X- STLP%11-18A	●	●			4			220				0.4	Yes	2	SB-3060TR	-	FT-10	TP□B1103... TP□H1103... TP□T1103... TP□X1103...	
STLPR11-18A-2/3	●		18	16		15	28	145	9.2	3.5									
STLPR11-18A-1/2	●							110											
E20S- STLP%11-22A	●	●						250											
STLPR11-22A-2/3	●		22	20	6	19	32	165	11.2	2									
STLPR11-22A-1/2	●							125											
E20S- STLP%16-25A	●	●						250											
STLPR16-25A-2/3	●		25	20		19	32	165	13			0.4	Yes	2	SB-4065TR	FT-15	-	TP□B1603... TP□H1603... TP□T1603...	
STLPR16-25A-1/2	●				6			125		0.7	0								
E25T- STLP%16-27A	●	●						300											
STLPR16-27A-2/3	●		27	25		24	38	200	13.7										

For WP chipbreaker, cutting edge offsets or program corrections are required on R36 and R37.
When using P chipbreaker : Right-hand Insert for Right-hand Toolholder, Left-hand Insert for Left-hand Toolholder.

● : Standard item R : Right-hand only L : Left-hand only □ : Check availability

Applicable inserts (A/S-STLB(P)-AE / S-STLB(P)-A / C/E-STLB(P)-A(N))

Applications	Minute ap	Finishing	Finishing	Finishing	Finishing	Finishing	Finishing	Finishing - Medium
Insert								
Chip Breaker Type	CF	PF	WP	1/2-WP	PP	GP	DP	HQ
Page	B84, B88	B84, B88	B88	B88	B88	B89	B84	B89
Applications	Finishing	Finishing	Finishing	Medium	Low feed	Low carbon steel	Low carbon steel	Cast iron
Insert								
Chip Breaker Type	R/L	1/2-FSF	1/2-P	1/2-H	1/2-USF	XP	XQ	No CB
Page	B84, B90, B91	B92	B92	B93	B94	B89	B89	B84, B94
Applications	Non-Ferrous Metals	Non-Ferrous Metals	Non-Ferrous Metals	Hard materials				
Insert								
Chip Breaker Type	AP	PCD	APD	CBN				
Page	B94	C44, C46, C47	C47	C23				

Recommended cutting conditions  F152, F153
 Applicable sleeves  F148~F151



S-STWP-E Excellent bar (Internal copying)

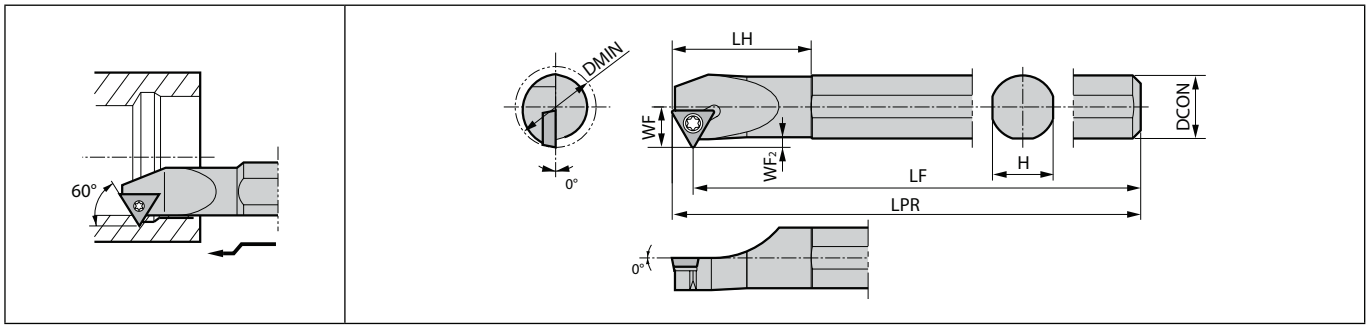

Max. Overhang Length L/D~5 | This toolholder is also available for threading. | Right-hand shown
Left-hand Insert for Right-hand Toolholder, Right-hand Insert for Left-hand Toolholder.

F

Toolholder dimensions

Description	Availability		Dimension (mm)									GAM0 (°)	Standard corner-R(RE)	Coolant hole	Spare parts			Applicable inserts
	R	L	DMIN	DCON	H	LH	LPR	LF	WF	WF2	Screw				Wrench	Wrench		
S10M- STWP ^{PL} 11-12E	●	●	12	10	9.2	23	150	144.5	6	1	0	0.1	No	SB-3STR	-	FT-10	TP□B1102..., TP□H1102...	
S12M- STWP ^{PL} 11-16E	●	●	16	12	11	30		8	1.5	TP□B1103... TP□H1103... TP□T1103...								
S16R- STWP ^{PL} 11-20E	●	●	20	16	15	35	200	194.5	10	2	0	0.8	No	SB-3TR	FT-15	-	TP□B1603..., TP□H1603... TP□T1603...	
S20X- STWP ^{PL} 11-25E	●	●	25	20	19	40	220	214.5	12.5	2.5							TP□B1603..., TP□H1603... TP□T1603...	
S20X- STWP ^{PL} 16-25E	●	●	25	20	19	40	220	212.3	14	4	0	0.8	No	SB-4TR	FT-15	-	TP□B1603..., TP□H1603... TP□T1603...	
S25X- STWP ^{PL} 16-32E	●	●	32	25	24	42	270	262.3	16.5								TP□B1603..., TP□H1603... TP□T1603...	

WP chipbreaker (TPMX-WP : Wiper insert) is not applicable to S-STWP-E Toolholders.

● : Standard item R : Right-hand only L : Left-hand only □ : Check availability

S-STWP Steel shank bar (Internal copying)

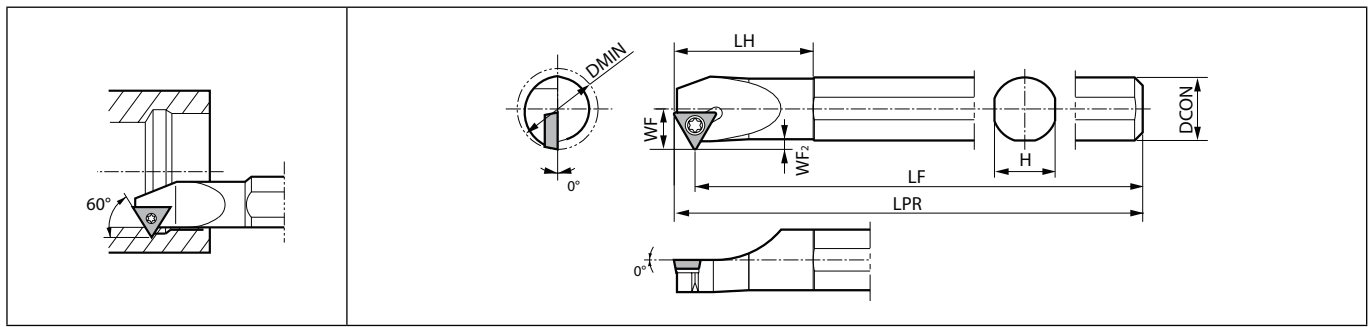

Max. Overhang Length L/D≈3 | This toolholder is also available for threading. | Right-hand shown
Left-hand Insert for Right-hand Toolholder.

Toolholder dimensions

Description	Availability		Dimension (mm)								GAMO (°)	Standard corner-R(RE)	Coolant hole	Spare parts		Applicable inserts
	R	DMIN	DCON	H	LH	LPR	LF	WF	WF2	Screw				Wrench		
	S10M- STWPR11-12	●	12	10	9.2	23	150	144.5	6	1				0	0.1	
S12M- STWPR11-16	●	16	12	11	30	8			1.5							
S16Q- STWPR11-20	●	20	16	15	35	180	174.5	10	2							
S20R- STWPR11-25	●	25	20	19	40	200	194.5	12.5	2.5							

WP chipbreaker (TPMX-WP : Wiper insert) is not applicable to S-STWP Toolholders.

Applicable inserts (S-STWP-E / S-STWP)

Applications	Finishing	Finishing	Finishing - Medium	Finishing	Finishing	Medium	Low feed	Low carbon steel
Insert								
Chip Breaker Type	PP	GP	HQ	R/L	F/L-FSF	F/L-H	F/L-USF	XP
Page	B88	B89	B89	B90, B91	B92	B93	B94	B89
Applications	Low carbon steel	Cast iron	Non-Ferrous Metals	Non-Ferrous Metals	Non-Ferrous Metals	Hard materials		
Insert								
Chip Breaker Type	XQ	No CB	AP	PCD	APD	CBN		
Page	B89	B94	B94	C46, C47	C47	C23		

Recommended cutting conditions → F152, F153
Applicable sleeves → F149~F151

● : Standard item R : Right-hand only L : Left-hand only □ : Check availability



C-STXB(P) Carbide shank bar (Boring / Internal facing)

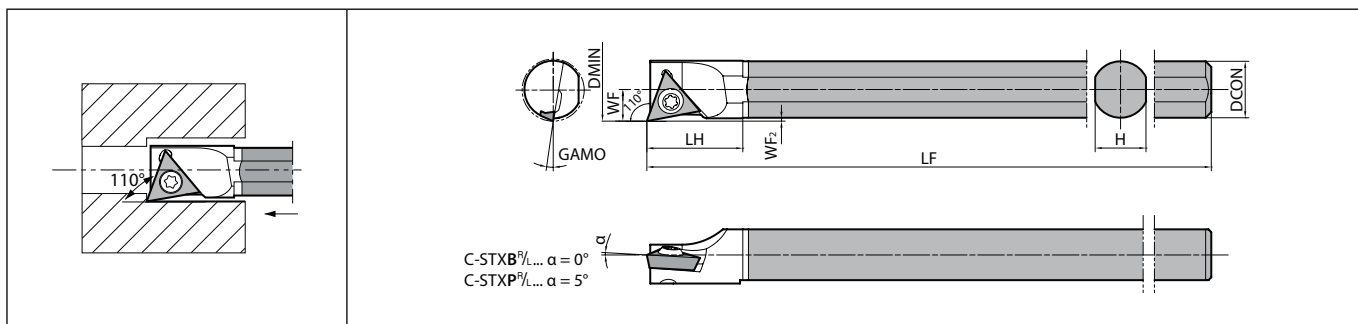

Max. Overhang Length $L/D \sim 7$ | Right-hand shown
Left-hand Insert for Right-hand Toolholder, Right-hand Insert for Left-hand Toolholder.

F

Toolholder dimensions

Description	Availability		Dimension (mm)							GAMO (°)	Standard corner-R(RE)	Coolant hole	Spare parts		Applicable inserts
	R	L	DMIN	DCON	H	LH	LF	WF	WF2				Screw	Wrench	
	C06J- STXB [°] /L06-075	●	●	7.5	6	5.4	11	110	3.75				0.5	10	
C08X- STXP [°] /L08-09	●	●	9	8	7	14	143	4.6	0.5	10	0.03	No	SB-1TR	FT-6	TP□B0802..., TP□H0802..., TP□T0802...
C10X- STXP [°] /L09-11	●	□	11	10	9	17	164	5.6	0.5	10	0.03	No	SB-2TR	FT-8	TP□B0902..., TP□H0902..., TP□T0902...

WP chipbreaker (TPMX-WP : Wiper insert) is not applicable to C-STXP Toolholders.

Applicable inserts

Applications	Minute ap	Finishing	Finishing	Finishing	Finishing	Finishing - Medium	Finishing	Finishing
Insert								
Chip Breaker Type	CF	PF	PP	GP	DP	HQ	R/L	°/L-FSF
Page	B84, B88	B84, B88	B88	B89	B84	B89	B84, B90, B91	B92
Applications	Medium	Low feed	Low carbon steel	Cast iron	Non-Ferrous Metals	Non-Ferrous Metals	Hard materials	
Insert								
Chip Breaker Type	°/L-H	°/L-USF	XP	No CB	AP	PCD	CBN	
Page	B93	B94	B89	B84, B94	B94	C44, C46, C47	C23	

Recommended cutting conditions [F152, F153](#)

Applicable sleeves [F148, F149, F151](#)

C-STXP(B) Boring Bar Cutting Conditions (Workpiece Material : 34CrMo4)

Toolholder Description	Insert Description (Grades)	Vc (m/min)	ap (mm)	f (mm/rev)	Coolant
C06J-STXB [°] /L06-075	TBGT0601003 1/8 (PR930)	30~100	0.02~0.1	0.02~0.04	Yes
C08X-STXP [°] /L08-09	TPGH080201 1/8 (PR930)	30~100	0.05~0.15	0.03~0.08	Yes
C10X-STXP [°] /L09-11	TPGH090201 1/8 (PR930)	30~100	0.05~0.15	0.03~0.08	Yes

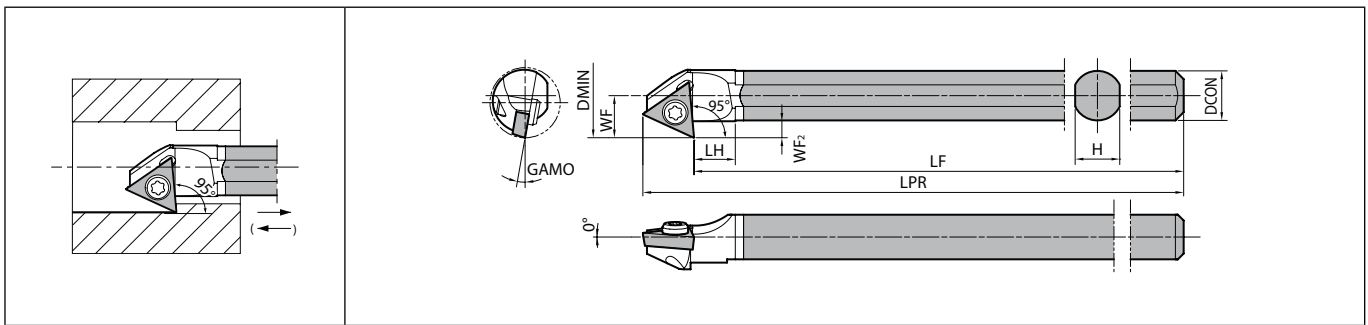

● : Standard item R : Right-hand only L : Left-hand only □ : Check availability

C-STZB Carbide shank bar (Back boring)





Max. Overhang Length $L/D \approx 7$ | Right-hand shown
 Right-hand Insert for Right-hand Toolholder, Left-hand Insert for Left-hand Toolholder.
 When using Right-hand Toolholder, use Right-hand insert if machining from back to front in this direction (→).
 Use Left-hand insert if machining from front to back in this direction (←).

Toolholder dimensions

Description	Availability		Dimension (mm)									GAMMO (°)	Standard corner-R(RE)	Coolant hole	Spare parts		Applicable inserts
															Screw	Wrench	
	R	L	DMIN	DCON	H	LH	LPR	LF	WF	WF ₂							
C06J- STZB%\.06-085	●	●	8.5	6	5.4	5	110	104.3	5.1	1.8	10	0.03	No	SB-1STR	FT-6	TB□T0601..., TB□W0601...	

Applicable inserts

Applications	Minute ap	Finishing	Finishing	Finishing	Cast iron	Non-Ferrous Metals
Insert						
Chip Breaker Type	CF	PF	DP	R/L	No CB	PCD
Page	B84	B84	B84	B84	B84	C44

Recommended cutting conditions  F152, F153
 Applicable sleeves  F148, F151

● : Standard item R : Right-hand only L : Left-hand only □ : Check availability



A-STLC-AE Excellent bar (Boring / Internal facing)

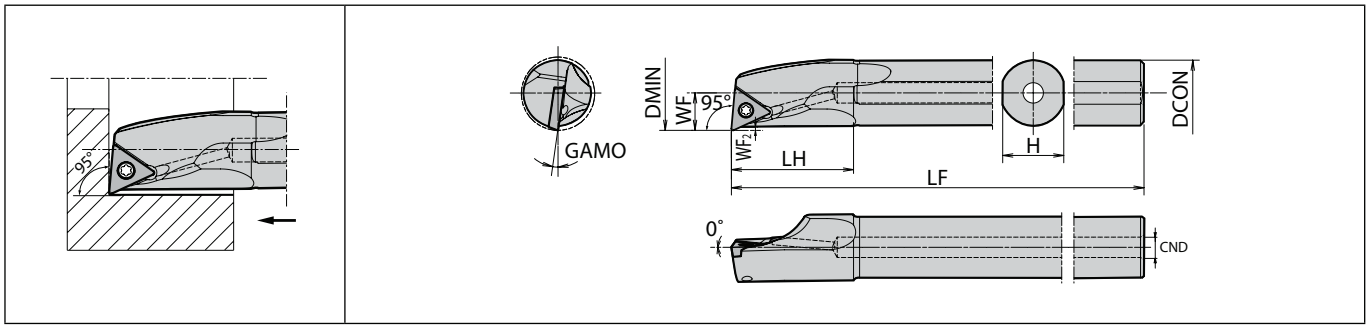

Max. Overhang Length L/D≈~5.5 | Right-hand shown
Left-hand Insert for Right-hand Toolholder, Right-hand Insert for Left-hand Toolholder.

F

Toolholder dimensions

Description	Availability		Dimension (mm)									GAMO (°)	Standard corner-R(RE)	Coolant hole	Spare parts		Applicable inserts
	R	L	DMIN	DCON	CND	H	LH	LF	WF	WF ₂	Screw				Wrench		
	A08X- STLC%L09-10AE	●	●	10	8	2.5	7	16	120	5	0.5				14	0.4	
A10L- STLC%L09-12AE	●	●	12	10	3	9	20	140	6.2	0.9	12	0.4	Yes	SB-2560TR	FT-8	TCMT1102... TCMX1102...	
A10L- STLC%L11-12AE	●	●	12	10	3	9	20	140	6.2	0.9	12	0.4	Yes	SB-2560TR	FT-8	TCMT1102... TCMX1102...	
A12M- STLC%L11-14AE	●	●	14	12	4	11	24	150	7.2		10	0.4	Yes	SB-2560TR	FT-8	TCMT1102... TCMX1102...	
A16Q- STLC%L11-18AE	●	●	18	16	5	15	30	180	9.2	0.7	8	0.4	Yes	SB-2560TR	FT-8	TCMT1102... TCMX1102...	
A20R- STLC%L11-22AE	●	●	22	20		19	36	200	11.2		6	0.4	Yes	SB-2560TR	FT-8	TCMT1102... TCMX1102...	

For WP chipbreaker, cutting edge offsets or program corrections are required on R36 and R37.

Applicable inserts

Applications	Finishing	Finishing - Medium
Insert		
Chip Breaker Type	WP	HQ
Page	B85	B85

Recommended cutting conditions [F152](#), [F153](#)

Applicable sleeves [F148~F151](#)

● : Standard item R : Right-hand only L : Left-hand only □ : Check availability

S-STLC-A Steel shank bar (Boring / Internal facing)

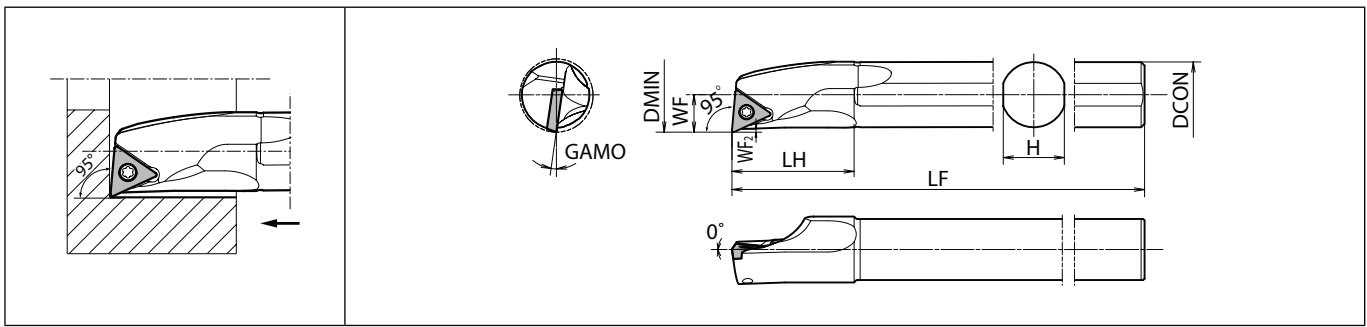

Max. Overhang Length $L/D \approx 4$ | Right-hand shown
 Left-hand Insert for Right-hand Toolholder, Right-hand Insert for Left-hand Toolholder.

Toolholder dimensions

Description	Availability		Dimension (mm)							GAMO (°)	Standard corner-R(RE)	Coolant hole	Spare parts		Applicable inserts
			R	L	DMIN	DCON	H	LH	LF				WF	WF ₂	
	S08X- STLC [®] L09-10A	●	●	10	8	7	16	120	5	0.5	14	0.4	No	SB-2250TR	
S10L- STLC [®] L09-12A	●	●	12	10	9	20	140	6.2	0.9	12	0.4	No	SB-2560TR	FT-8	TCMT1102... TCMX1102...
S10L- STLC [®] L11-12A	●	●	12	10	9	20	140	6.2	0.9	12					
S12M- STLC [®] L11-14A	●	●	14	12	11	24	150	7.2		10					
S16Q- STLC [®] L11-18A	●	●	18	16	15	30	180	9.2	0.7	8					
S20R- STLC [®] L11-22A	●	●	22	20	19	36	200	11.2	8	6					
									6						

For WP chipbreaker, cutting edge offsets or program corrections are required on R36 and R37.

Applicable inserts

Applications	Finishing	Finishing - Medium
Insert		
Chip Breaker Type	WP	HQ
Page	B85	B85

Recommended cutting conditions ➔ F152, F153

Applicable sleeves ➔ F148~F151

● : Standard item R : Right-hand only L : Left-hand only □ : Check availability



A-SVJP(C)(B)-AE Excellent bar (Spherical machining / Internal facing / Internal copying)

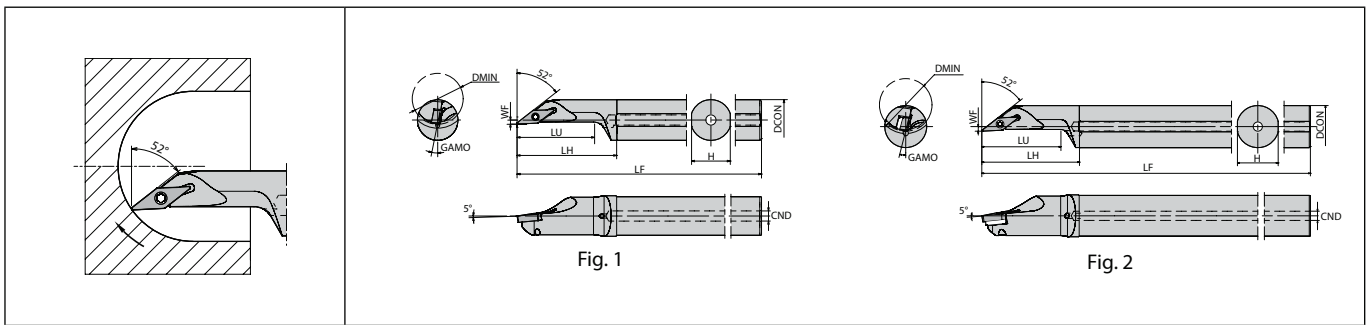

Max. Overhang Length L/D≈5.5 | Right-hand shown
Left-hand Insert for Right-hand Toolholder, Right-hand Insert for Left-hand Toolholder.

F

Toolholder dimensions

Description	Availability		Dimension (mm)										GAMO (°)	Standard corner-R(RE)	Coolant hole	Fig.	Spare parts						Applicable inserts
	R	L	DMIN	DCON	CND	H	LH	LF	LU	WF	Screw	Wrench					Wrench	Shim	Shim screw	Wrench			
A12M- SVJP%L08-16AE	●	●	16	12	4	11	33	150	26	2	5	0.2	Yes	1	SB-2050TR	-	FT-6	-	-	-	VP□T0802...		
A12M- SVJC%L08-16AE	●	●	16	12	4	11	33	150	26	2	5	0.4	Yes	1	SB-2050TR	-	FT-6	-	-	-	VC□T0802... VC□W0802...		
A16Q- SVJC%L08-20AE	●	●	20	16		15	43	180	36														
A20R- SVJB%L11-25AE	●	●	25	20	5	19	48	200	37.5	2	5	0.4	Yes	1	SB-2570TR	-	FT-8	-	-	-	VB□T1103... VB□W1103...		
A25S- SVJB%L11-30AE	●	●	30	25	7	24	58	250	45	3.5	8	0.4	Yes	2	SB-40125TRN	FT-15	-	SVN-32N (SVN-32S*)	SS-4N	LW-4	VB□T1604... VB□W1604... VC□T1604...		
A32S- SVJB%L16-40AE	●	●	40	32	7	31	74	250	60	3.5	8	0.4	Yes	2	SB-40125TRN	FT-15	-	SVN-32N (SVN-32S*)	SS-4N	LW-4	VB□T1604... VB□W1604... VC□T1604...		
A40T- SVJB%L16-50AE	●	●	50	40	9	39	91	300	75	4.5	7	0.4	Yes	2	SB-40125TRN	FT-15	-	SVN-32N (SVN-32S*)	SS-4N	LW-4	VB□T1604... VB□W1604... VC□T1604...		

Use of VB□T1103...-Y / VB□T1604...-Y with A-SVJB-AE is not recommended.
When using inserts whose corner-R(RE) is 0.2 or 0.4mm, shim (SVN-32S) is recommended (sold separately).

● : Standard item R : Right-hand only L : Left-hand only □ : Check availability

S-SVJP(C)(B)-A Steel shank bar (Spherical machining / Internal facing / Internal copying)

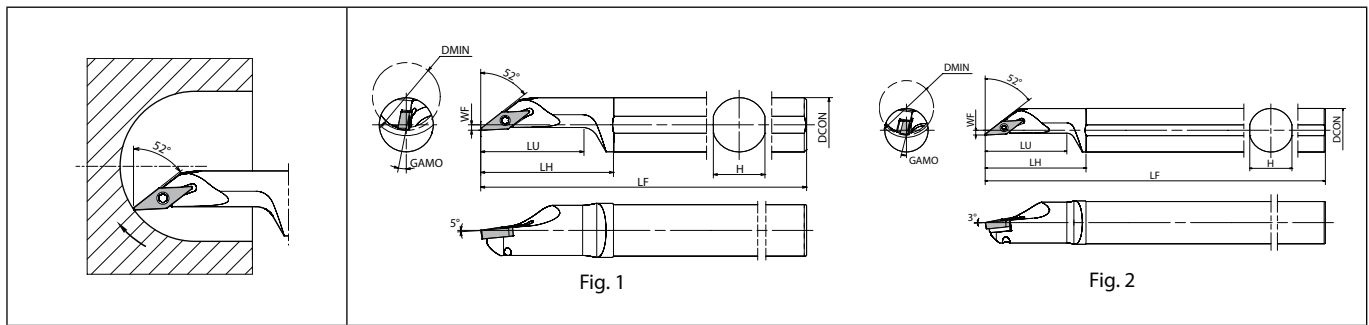

Max. Overhang Length L/D≈4 | Right-hand shown
Left-hand Insert for Right-hand Toolholder, Right-hand Insert for Left-hand Toolholder.

Toolholder dimensions













Description	Availability		Dimension (mm)										Standard corner-R(RE)	Coolant hole	Fig.	Spare parts						Applicable inserts
			R	L	DMIN	DCON	H	LH	LF	LU	WF	Screw				Wrench	Wrench	Shim	Shim screw	Wrench		
	GAMO (°)																					
S12M- SVJP%L.08-16A	●	●	16	12	11	33	150	26	2	5	0.2	No	1	SB-2050TR	-	FT-6	-	-	-	VP□T0802...		
S12M- SVJC%L.08-16A	●	●	16	12	11	33	150	26	2	5	0.4	No	1	SB-2050TR	-	FT-6	-	-	-	VC□T0802...		
S16Q- SVJC%L.08-20A	●	●	20	16	15	43	180	36	2	5	0.4	No	1	SB-2050TR	-	FT-6	-	-	-	VC□W0802...		
S20R- SVJB%L.11-25A	●	●	25	20	19	48	200	37.5	2	5	0.4	No	1	SB-2570TR	-	FT-8	-	-	-	VB□T1103...		
S25S- SVJB%L.11-30A	●	●	30	25	24	58	250	45	3.5	5	0.4	No	1	SB-2570TR	-	FT-8	-	-	-	VB□W1103...		
S32S- SVJB%L.16-40A	●	●	40	32	31	74	250	60	3.5	8	0.4	No	2	SB-40125TRN	FT-15	-	SVN-32N (SVN-32S*)	SS-4N	LW-4	VB□T1604...		
S40T- SVJB%L.16-50A	●	●	50	40	39	91	300	75	4.5	7	0.4	No	2	SB-40125TRN	FT-15	-	SVN-32N (SVN-32S*)	SS-4N	LW-4	VB□W1604...		
																					VC□T1604...	

Use of VB□T1103...Y / VB□T1604...Y with S-SVJB-A is not recommended.
When using inserts whose corner-R(RE) is 0.2 or 0.4mm, shim (SVN-32S) is recommended (sold separately).



● : Standard item R : Right-hand only L : Left-hand only □ : Check availability

Applicable inserts (A-SVJP(C)(B)-AE / S-SVJP(C)(B)-A)

Applications	Finishing	Finishing	Finishing	Finishing	Finishing - Medium	Finishing	Finishing	Low feed
Insert								
Chip Breaker Type	CK	VF	PP	GP	HQ	^{P/L} -F	^{P/L} -FSF	^{P/L} -U
Page	B102	B97, B100	B97, B100	B97	B97, B100	B98, B103	B98, B103	B104
Applications	Low feed	Finishing - Medium	Non-Ferrous Metals	Hard materials				
Insert								
Chip Breaker Type	^{P/L} -USF	^{P/L} -Y	PCD	CBN				
Page	B104	B99	C49, C50	C26, C27				

Recommended cutting conditions [F152, F153](#)

Applicable sleeves [F149~F151](#)

F



Boring

Solid

Positive

AD bars

Negative

Application of □-SVJP(C)(B)-□ / A-SZJB-AE

1. Application Range

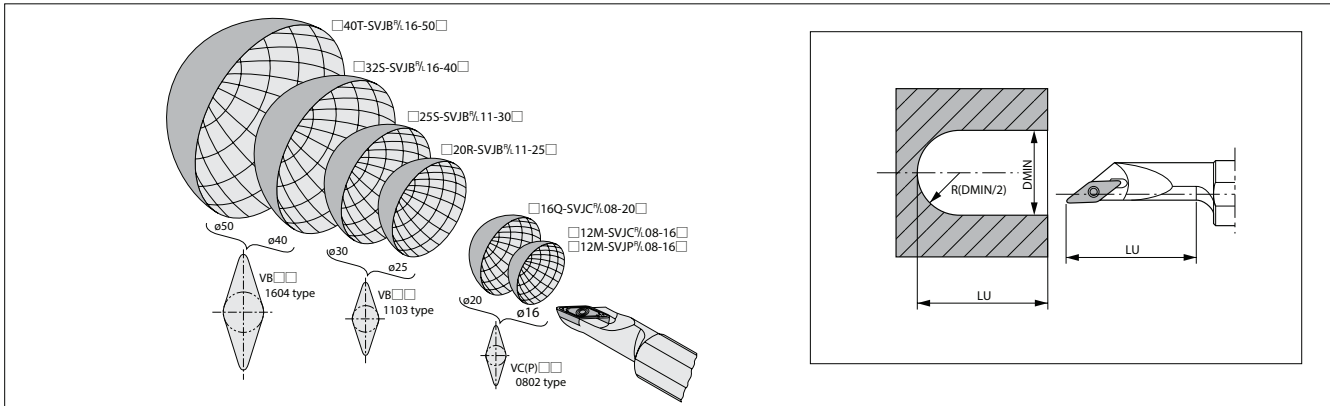

2. Application

Case with no existing hole	Finishing
<p>(Note) f shall be 0.05 mm/rev or less at internal facing.</p>	
<p>Case with drilled hole</p> <p>(Note) f shall be 0.05mm/rev or less at internal facing.</p>	<p>Machining process (1) Finish the internal face first. (2) Next, finish the internal diameter.</p>

3. Caution

When machining past the center of the workpiece, insert may break.

Fix the insert edge at the center of the workpiece.

Adjust the machining program to radius minus the value of corner-R (RE).

For internal profiling, a_p should be the value of Corner-R(RE) and less.

This type of machining is possible, but the chips might scratch the surface.

Poor finish

[Burrs may occur, if a_p is Corner-R (RE) and more]



Boring

A-SVPC(B)-AE Excellent bar (Internal copying / Undercutting)

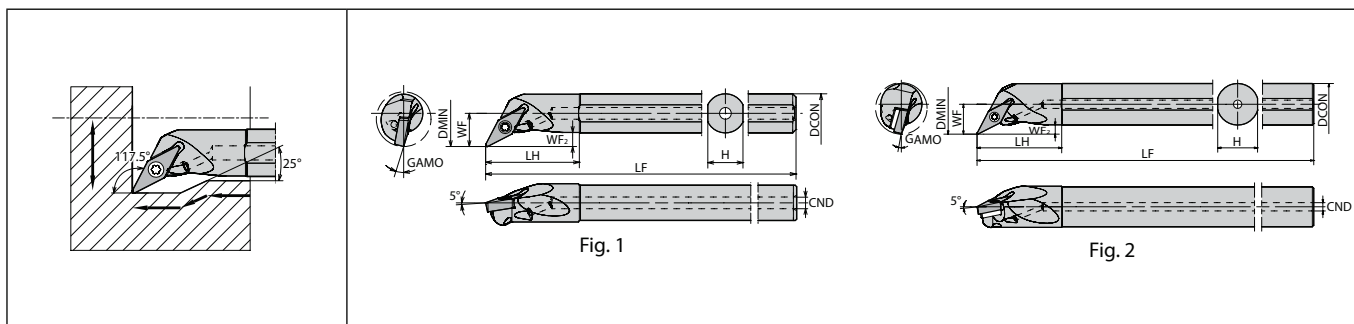

Max. Overhang Length L/D≈5.5 | Right-hand shown
Left-hand Insert for Right-hand Toolholder, Right-hand Insert for Left-hand Toolholder.

F

Toolholder dimensions

Description	Availability		Dimension (mm)										GAMO (°)	Standard corner-R(RE)	Coolant hole	Fig.	Spare parts						Applicable inserts
																	Screw	Wrench	Wrench	Shim	Shim screw	Wrench	
A10L- SVPC%08-14AE	●	●	14	10	3	9	24	140	8.5	3	8	0.4	Yes	1	SB-2050TR	-	FT-6	-	-	-	VC□T0802... VC□W0802...		
A12M- SVPB%11-18AE	●	●	18	12	4	11	29	150	11	4.5	8	0.4	Yes	1	SB-2570TR	-	FT-8	-	-	-	VB□T1103... VB□W1103...		
A16Q- SVPB%11-22AE	●	●	22	16	5	15	35	180	13.5	5	5												
A20R- SVPB%11-26AE	●	●	26	20		19	41	200	15.5														
A25S- SVPB%16-31AE	●	●	31	25	5	24	51	250	18	5	13	0.4	Yes	2	SB-40125TRN	FT-15	-	SVN-32N (SVN-32S*)	SS-4N	LW-4	VB□T1604... VB□W1604... VC□T1604...		
A32S- SVPB%16-40AE	●	●	40	32		31	54		23	6.5	9												

When using inserts whose corner-R(RE) is 0.2 or 0.4mm, shim (SVN-32S) is recommended (sold separately).

S-SVPC(B)-A Steel shank bar (Internal copying / Undercutting)

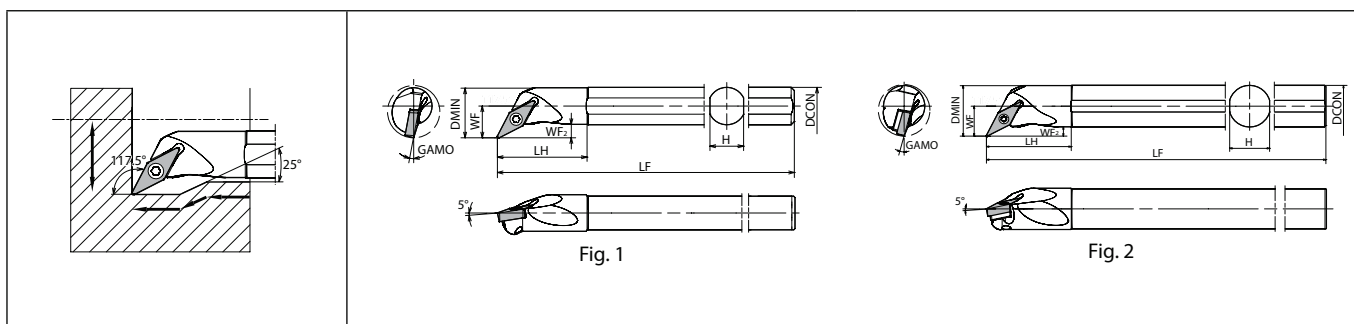

Max. Overhang Length L/D≈4 | Right-hand shown
Left-hand Insert for Right-hand Toolholder, Right-hand Insert for Left-hand Toolholder.

Toolholder dimensions

Description	Availability		Dimension (mm)										GAMO (°)	Standard corner-R(RE)	Coolant hole	Fig.	Spare parts						Applicable inserts
																	Screw	Wrench	Wrench	Shim	Shim screw	Wrench	
S10L- SVPC%08-14A	●	●	14	10	9	24	140	8.5	3	8	0.4	No	1	SB-2050TR	-	FT-6	-	-	-	VC□T0802..., VC□W0802...			
S12M- SVPB%11-18A	●	●	18	12	11	29	150	11	4.5	8	0.4	No	1	SB-2570TR	-	FT-8	-	-	-	VB□T1103... VB□W1103...			
S16Q- SVPB%11-22A	●	●	22	16	15	35	180	13.5	5	5													
S20R- SVPB%11-26A	●	●	26	20	19	41	200	15.5															
S25S- SVPB%16-31A	●	●	31	25	24	51	250	18	5	13	0.4	No	2	SB-40125TRN	FT-15	-	SVN-32N (SVN-32S*)	SS-4N	LW-4	VB□T1604..., VB□W1604... VC□T1604...			
S32S- SVPB%16-40A	●	●	40	32	31	54		23	6.5	9													

When using inserts whose corner-R(RE) is 0.2 or 0.4mm, shim (SVN-32S) is recommended (sold separately).

● : Standard item R : Right-hand only L : Left-hand only □ : Check availability



Boring

Solid

Positive

AD bars

Negative

E-SVPC(B)-A Carbide shank bar (Internal copying / Undercutting)

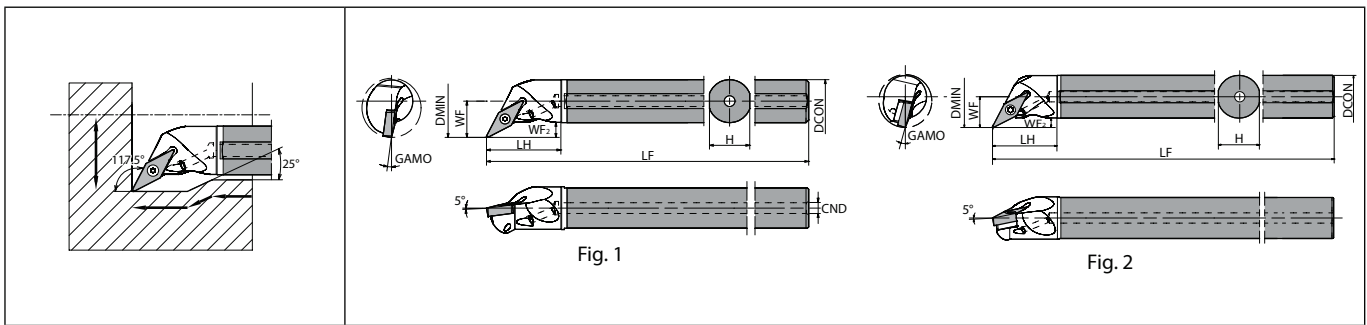

Max. Overhang Length L/D≈~7 | Right-hand shown | Left-hand Insert for Right-hand Toolholder.

Toolholder dimensions

Description	Availability	Dimension (mm)											GAMO (°)	Standard corner-R(RE)	Coolant hole	Fig.	Spare parts						Applicable inserts
		R	DMIN	DCON	CND	H	LH	LF	WF	WF ₂	Screw	Wrench					Wrench	Shim	Shim screw	Wrench			
E10N- SVPCR08-14A	●	14	10	3	9	20	160	8.5	3	8	0.4	Yes	1	SB-2050TR	-	FT-6	-	-	-	VC□T0802... VC□W0802...			
E12Q- SVPBR11-18A	●	18	12	4	11	23	180	11	4.5	8	0.4	Yes	1	SB-2570TR	-	FT-8	-	-	-	VB□T1103... VB□W1103...			
E16X- SVPBR11-22A	●	22	16		15	28	220	13.5	5	5													
E20S- SVPBR11-26A	●	26	20	6	19	32	250	15.5	5	5													
E25T- SVPBR16-31A	●	31	25	6	24	38	300	18	5	13	0.4	Yes	2	SB-40125TRN	FT-15	-	SVN-32N (SVN-32S*)	SS-4N	LW-4	VB□T1604... VB□W1604... VC□T1604...			

When using inserts whose corner-R(RE) is 0.2 or 0.4mm, shim (SVN-32S) is recommended (sold separately).

Applicable inserts (A-SVPC(B)-AE / S-SVPC(B)-A / E-SVPC(B)-A)

Applications	Finishing	Finishing	Finishing	Finishing - Medium	Finishing	Finishing	Finishing - Medium	Non-Ferrous Metals
Insert								
Chip Breaker Type	VF	PP	GP	HQ	Y/L-F	Y/L-FSF	Y/L-Y	PCD
Page	B97, B100	B97, B100	B97	B97, B100	B98	B98	B99	C49, C50
Applications	Hard materials							
Insert								
Chip Breaker Type	CBN							
Page	C26, C27							

Recommended cutting conditions ● F152, F153

Applicable sleeves ● F149~F151

● : Standard item R : Right-hand only L : Left-hand only □ : Check availability



A-SVUC(B)-AE Excellent bar (Internal copying)

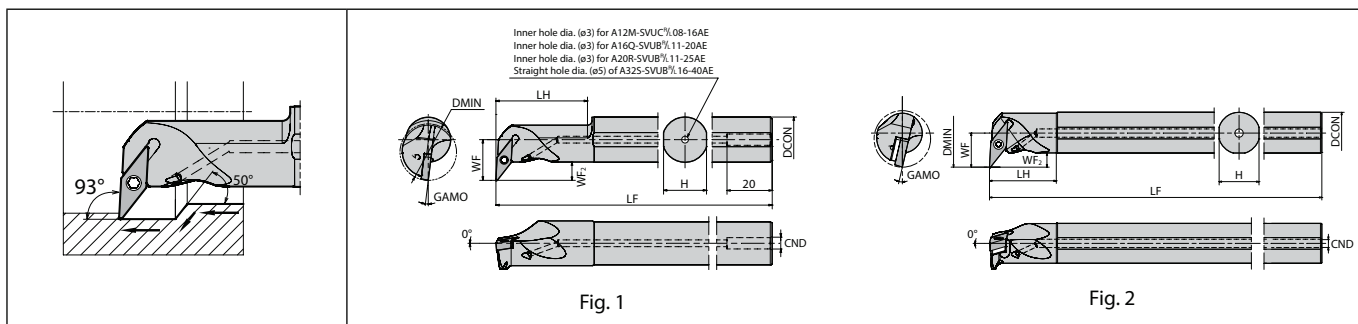

Fig. 1

Fig. 2

Max. Overhang Length L/D≈5.5 | Right-hand shown
Left-hand Insert for Right-hand Toolholder, Right-hand Insert for Left-hand Toolholder.

F

Toolholder dimensions

Description	Availability		Dimension (mm)										Standard corner-R(RE)	Coolant hole	Fig.	Spare parts						Applicable inserts
	R	L	DMIN	DCON	CND	H	LH	LF	WF	WF2	GAMO (°)	Screw				Wrench	Wrench	Shim	Shim screw	Wrench		
A12M- SVUC%0.08-16AE	●	●	16	12	4	11	25.5	150	11.5	5.5	8	0.4	Yes	1	SB-2050TR	-	FT-6	-	-	-	VC□T0802... VC□W0802...	
A16Q- SVUB%1.11-20AE	●	●	20	16	5	15	32.5	180	16	8	8	0.4	Yes	1	SB-2570TR	-	FT-8	-	-	-	VB□T1103... VB□W1103...	
A20R- SVUB%1.11-25AE	●	●	25	20		19	40.5	200	18	7	7	0.4	Yes	1	SB-2570TR	-	FT-8	-	-	-	VB□T1103... VB□W1103...	
A25S- SVUB%1.16-34AE	●	●	34	25	5	24	40	250	20.5	8.5	13	0.4	Yes	2	SB-40125TRN	FT-15	-	SVN-32N (SVN-32S*)	SS-4N	LW-4	VB□T1604... VB□W1604... VC□T1604...	
A32S- SVUB%1.16-40AE	●	●	40	32	5	31	84	250	28	12	9	0.4	Yes	1	SB-40125TRN	FT-15	-	SVN-32N (SVN-32S*)	SS-4N	LW-4	VB□T1604... VB□W1604... VC□T1604...	

When using inserts whose corner-R(RE) is 0.2 or 0.4mm, shim (SVN-32S) is recommended (sold separately).

S-SVUC(B)-A Steel shank bar (Internal copying)

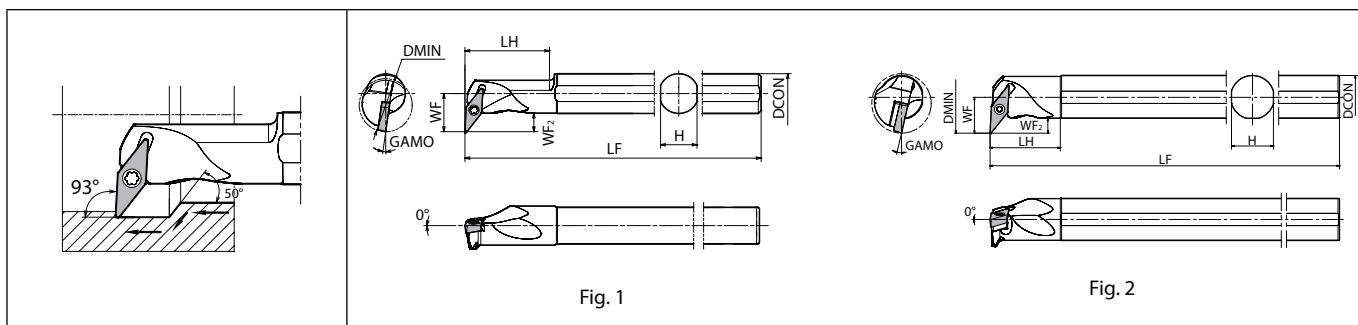

Fig. 1

Fig. 2

Max. Overhang Length L/D≈4 | Right-hand shown
Left-hand Insert for Right-hand Toolholder, Right-hand Insert for Left-hand Toolholder.

Toolholder dimensions

Description	Availability		Dimension (mm)										Standard corner-R(RE)	Coolant hole	Fig.	Spare parts						Applicable inserts
	R	L	DMIN	DCON	H	LH	LF	WF	WF2	GAMO (°)	Screw	Wrench				Wrench	Shim	Shim screw	Wrench			
S12M- SVUC%0.08-16A	●	●	16	12	11	25.5	150	11.5	5.5	8	0.4	No	1	SB-2050TR	-	FT-6	-	-	-	VC□T0802... VC□W0802...		
S16Q- SVUB%1.11-20A	●	●	20	16	15	32.5	180	16	8	8	0.4	No	1	SB-2570TR	-	FT-8	-	-	-	VB□T1103... VB□W1103...		
S20R- SVUB%1.11-25A	●	●	25	20	19	40.5	200	18	7	7	0.4	No	1	SB-2570TR	-	FT-8	-	-	-	VB□T1103... VB□W1103...		
S25S- SVUB%1.16-34A	●	●	34	25	24	40	250	20.5	8.5	13	0.4	No	2	SB-40125TRN	FT-15	-	SVN-32N (SVN-32S*)	SS-4N	LW-4	VB□T1604... VB□W1604... VC□T1604...		
S32S- SVUB%1.16-40A	●	●	40	32	31	84	250	28	12	9	0.4	No	1	SB-40125TRN	FT-15	-	SVN-32N (SVN-32S*)	SS-4N	LW-4	VB□T1604... VB□W1604... VC□T1604...		

When using inserts whose corner-R(RE) is 0.2 or 0.4mm, shim (SVN-32S) is recommended (sold separately).

● : Standard item R : Right-hand only L : Left-hand only □ : Check availability

Boring

Solid
Positive
AD bars
Negative

E-SVUC(B)-A Carbide shank bar (Internal copying)

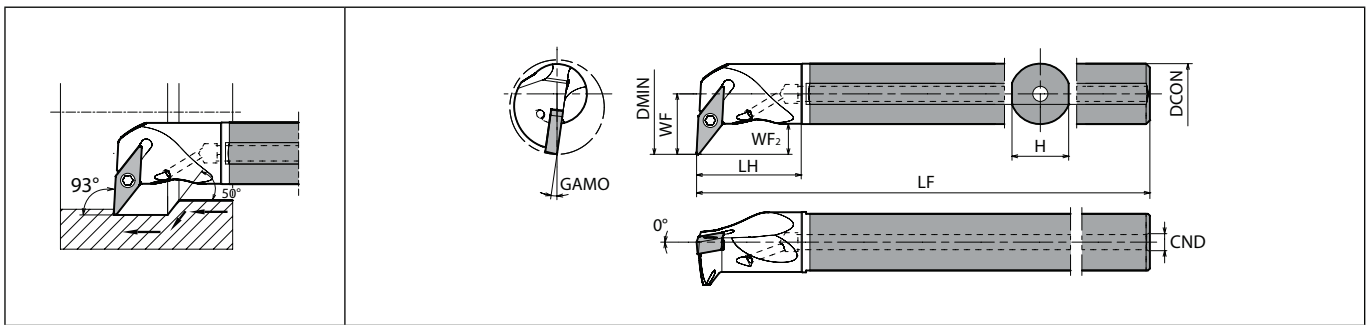

Max. Overhang Length L/D≈7 | Right-hand shown
Left-hand Insert for Right-hand Toolholder.

Toolholder dimensions

Description	Availability	Dimension (mm)										GAMO (°)	Standard corner-R(RE)	Coolant hole	Spare parts						Applicable inserts
		R	DMIN	DCON	CND	H	LH	LF	WF	WF2	Screw				Wrench	Wrench	Shim	Shim screw	Wrench		
E12Q- SVUCR08-18A	●	18	12	4	11	23	180	11.5	5.5	8	0.4	Yes	SB-2050TR	-	FT-6	-	-	-	VC...T0802... VC...W0802...		
E16X- SVUBR11-25A	●	25	16	4	15	28	220	16	8	8	0.4	Yes	SB-2570TR	-	FT-8	-	-	-	VB...T1103... VB...W1103...		
E20S- SVUBR11-29A	●	29	20	6	19	32	250	18	7	8	0.4	Yes	SB-2570TR	-	FT-8	-	-	-	VB...T1103... VB...W1103...		
E25T- SVUBR16-34A	●	34	25	6	24	38	300	21	8.5	13	0.4	Yes	SB-4012STRN	FT-15	-	SVN-32N (SVN-32S*)	SS-4N	LW-4	VB...T1604... VB...W1604... VB...T1604...		

When using inserts whose corner-R(RE) is 0.2 or 0.4mm, shim (SVN-32S) is recommended (sold separately).

Applicable inserts (A-SVUC(B)-AE / S-SVUC(B)-A / E-SVUC(B)-A)

Applications	Finishing	Finishing	Finishing	Finishing - Medium	Finishing	Finishing	Finishing - Medium	Non-Ferrous Metals
Insert								
Chip Breaker Type	VF	PP	GP	HQ	%/-F	%/-FSF	%/-Y	PCD
Page	B97, B100	B97, B100	B97	B97, B100	B98	B98	B99	C49, C50
Applications	Hard materials							
Insert								
Chip Breaker Type	CBN							
Page	C26, C27							

Recommended cutting conditions F152, F153

Applicable sleeves F149~F151

● : Standard item R : Right-hand only L : Left-hand only □ : Check availability



A-SVZC(B)-AE Excellent bar (Back boring)

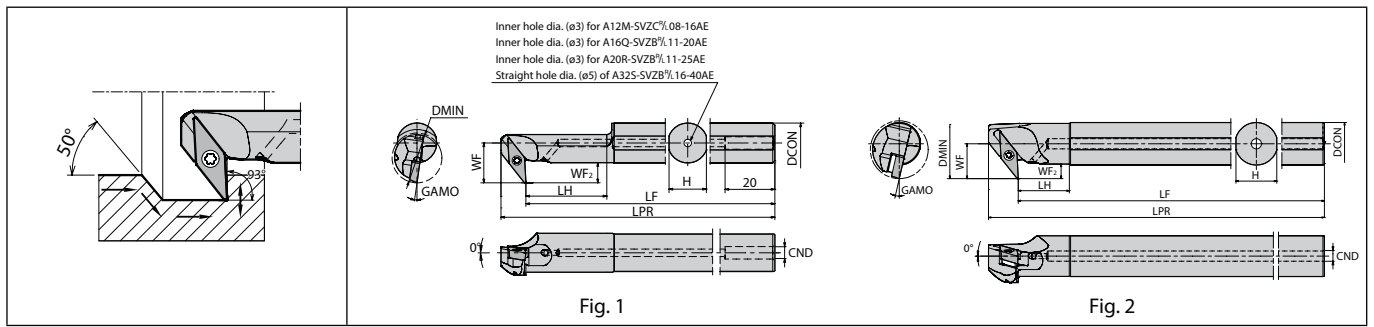

Fig. 1

Fig. 2

Max. Overhang Length L/D≈5.5 | Right-hand shown
Right-hand Insert for Right-hand Toolholder, Left-hand Insert for Left-hand Toolholder.

F

Toolholder dimensions

Description	Availability		Dimension (mm)											GAMO (°)	Standard corner-R(RE)	Coolant hole	Fig.	Spare parts						Applicable inserts
			R	L	DMIN	DCON	CND	H	LH	LPR	LF	WF	WF ₂					Screw	Wrench	Wrench	Shim	Shim screw	Wrench	
A12M- SVZC% 08-16AE	●	●	16	12	4	11	25.5	150	142.5	11.5	5.5	8	0.4	Yes	1	SB-2050TR	-	FT-6	-	-	-	VC□T0802... VC□W0802...		
A16Q- SVZB% 11-20AE	●	●	20	16	5	15	32.5	180	170	16	8	7	0.4	Yes	1	SB-2570TR	-	FT-8	-	-	-	VB□T1103... VB□W1103...		
A20R- SVZB% 11-25AE	●	●	25	20		19	40.5	200	190	18														
A25S- SVZB% 16-34AE	●	●	34	25	5	24	30	250	232.5	20.5	8.5	13	0.4	Yes	2	SB-40125TRN	FT-15	-	SVN-32N (SVN-32S*)	SS-4N	LW-4	VB□T1604... VB□W1604... VC□T1604...		
A32S- SVZB% 16-40AE	●	●	40	32	5	31	72.5	250	232.5	28	12	9	0.4	Yes	1									

When using inserts whose corner-R(RE) is 0.2 or 0.4mm, shim (SVN-32S) is recommended (sold separately).

● : Standard item R : Right-hand only L : Left-hand only □ : Check availability

S-SVZC(B)-A Steel shank bar (Back boring)

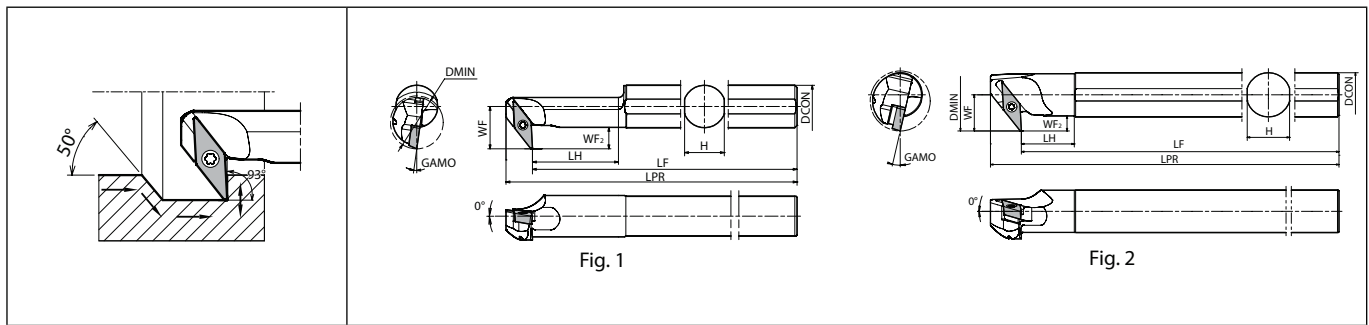

Max. Overhang Length L/D≈~4 | Right-hand shown
Right-hand Insert for Right-hand Toolholder, Left-hand Insert for Left-hand Toolholder.

Toolholder dimensions

Description	Availability		Dimension (mm)										GAMO (°)	Standard corner-R(RE)	Coolant hole	Fig.	Spare parts						Applicable inserts
																	Screw	Wrench	Wrench	Shim	Shim screw	Wrench	
S12M- SVZC%0.08-16A	●	●	16	12	11	25.5	150	142.5	11.5	5.5	8	0.4	No	1	SB-2050TR	-	FT-6	-	-	-	VC...T0802... VC...W0802...		
S16Q- SVZB%1.11-20A	●	●	20	16	15	32.5	180	170	16	8	8	0.4	No	1	SB-2570TR	-	FT-8	-	-	-	VB...T1103... VB...W1103...		
S20R- SVZB%1.11-25A	●	●	25	20	19	40.5	200	190	18	8	7	0.4	No	1	SB-2570TR	-	FT-8	-	-	-	VB...T1103... VB...W1103...		
S25S- SVZB%1.16-34A	●	●	34	25	24	30	250	232.5	20.5	8.5	13	0.4	No	2	SB-40125TRN	FT-15	-	SVN-32N (SVN-32S*)	SS-4N	LW-4	VB...T1604... VB...W1604... VC...T1604...		
S32S- SVZB%1.16-40A	●	●	40	32	31	72.5	250	232.5	28	12	9	0.4	No	1	SB-40125TRN	FT-15	-	SVN-32N (SVN-32S*)	SS-4N	LW-4	VB...T1604... VB...W1604... VC...T1604...		

When using inserts whose corner-R(RE) is 0.2 or 0.4mm, shim (SVN-32S) is recommended (sold separately).

Applicable inserts (A-SVZC(B)-AE / S-SVZC(B)-A)

Applications	Finishing	Finishing	Finishing	Finishing - Medium	Finishing	Finishing	Finishing - Medium	Non-Ferrous Metals
Insert								
Chip Breaker Type	VF	PP	GP	HQ	%L-F	%L-FSF	%L-Y	PCD
Page	B97, B100	B97, B100	B97	B97, B100	B98	B98	B99	C49, C50
Applications	Hard materials							
Insert								
Chip Breaker Type	CBN							
Page	C26, C27							

Recommended cutting conditions F152, F153
Applicable sleeves F149~F151

● : Standard item R : Right-hand only L : Left-hand only □ : Check availability



A/S-SWUB(P)-AE Excellent bar (Boring)

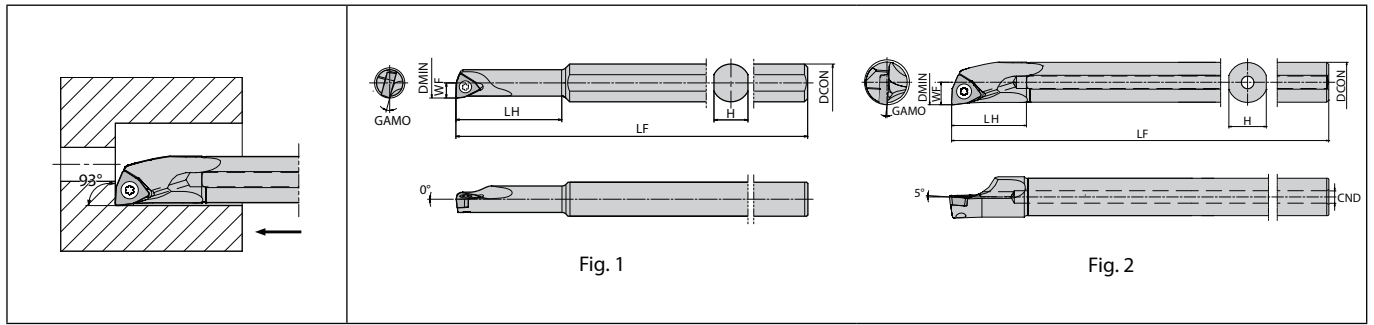





Fig. 1

Fig. 2

Max. Overhang Length L/D≈~5.5 | Right-hand shown
Left-hand Insert for Right-hand Toolholder, Right-hand Insert for Left-hand Toolholder.

F

Toolholder dimensions

Description	Availability		Dimension (mm)								GAMO (°)	Standard corner-R(RE)	Coolant hole	Fig.	Spare parts			Applicable inserts
	R	L	DMIN	DCON	CND	H	LH	LF	WF	Screw					Wrench	Wrench		
																		
S10H- SWUB%L.06-06AE	●	●	6	10	-	9	21	3	15	0.2	No	1	SB-2035TR	-	FT-6	WB□T0601... WB□W0601...		
S10H- SWUB%L.06-07AE	●	●	7	10	-	9	25	3.5	13									
S10H- SWUB%L.08-08AE	●	●	8	10	-	9	28	4	15	0.2	No	1	SB-2035TR	-	FT-6	WB□T0802... WB□W0802...		
A08X- SWUB%L.08-10AE	●	●	10	8	2.5	7	16	5	13									
A10L- SWUB%L.08-12AE	●	●	12	10	3	9	20	6	10	0.2	Yes	2	SB-2050TR	-	FT-6	WP□T1102... WP□W1102...		
A12M- SWUP%L.11-14AE	●	●	14	12	4	11	24	7	4	0.4	Yes	2	SB-2545TR	-	FT-8			
A16Q- SWUP%L.11-18AE	●	●	18	16	5	15	30	180	9	0.8	Yes	2	SB-4065TR	FT-15	-	WP□T1603... WP□W1603...		
A16Q- SWUP%L.16-18AE	●	●	18	16	5	15	30	180	9									
A20R- SWUP%L.16-22AE	●	●	22	20		19	36	200	11	2								

● : Standard item R : Right-hand only L : Left-hand only □ : Check availability



Boring

Solid

Positive

AD bars

Negative

S-SWUB(P)-A Steel shank bar (Boring)

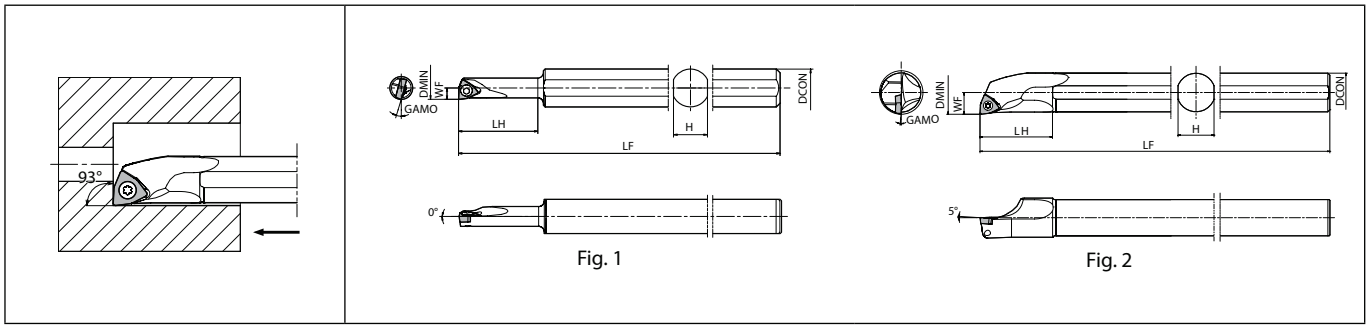

Max. Overhang Length L/D≈4 | Right-hand shown
Left-hand Insert for Right-hand Toolholder, Right-hand Insert for Left-hand Toolholder.

Toolholder dimensions

Description	Availability		Dimension (mm)								GAMO (°)	Standard corner-R(RE)	Coolant hole Fig.	Spare parts			Applicable inserts
			R	L	DMIN	DCON	H	LH	LF	WF				Screw	Wrench	Wrench	
S10H- SWUB%L.06-06A	●	●	6							15			1	SB-2035TR	-	FT-6	WB□T0601... WB□W0601...
S10H- SWUB%L.06-07A	●	●	7	10	9	21	100	3	13	0.2	No	1	SB-2035TR	-	FT-6		
S10H- SWUB%L.08-08A	●	●	8	10	9	28	100	4	15	0.2	No	1	SB-2035TR	-	FT-6	WB□T0802... WB□W0802...	
S08X- SWUB%L.08-10A	●	●	10	8	7	16	120	5	13	0.2	No	2	SB-2050TR	-	FT-6		
S10L- SWUB%L.08-12A	●	●	12	10	9	20	140	6	10								
S12M- SWUP%L.11-14A	●	●	14	12	11	24	150	7	4	0.4	No	2	SB-2545TR	-	FT-8	WP□T1102... WP□W1102...	
S16Q- SWUP%L.11-18A	●	●	18	16	15	30	180	9	1								
S16Q- SWUP%L.16-18A	●	●	18	16	15	30	180	9	3.5	0.8	No	2	SB-4065TR	FT-15	-	WP□T1603... WP□W1603...	
S20R- SWUP%L.16-22A	●	●	22	20	19	36	200	11	2								

● : Standard item R : Right-hand only L : Left-hand only □ : Check availability



C/E-SWUB(P)-A(N) Carbide shank bar (Boring)

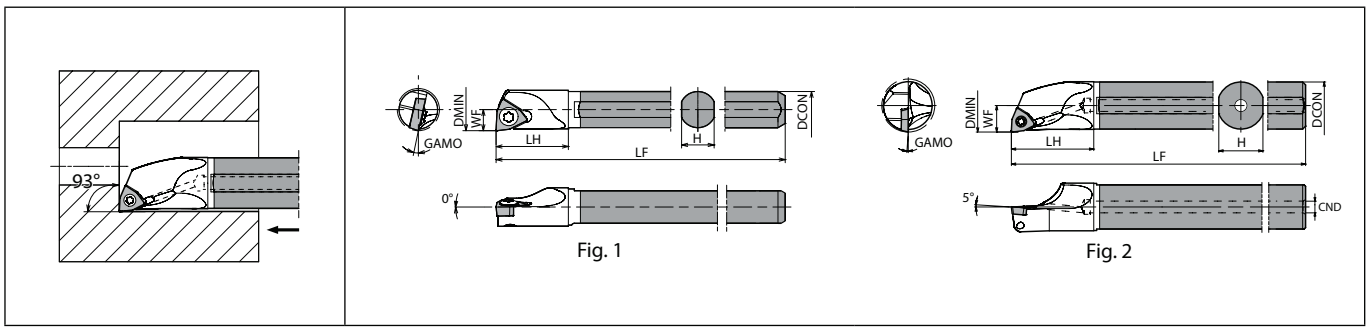

Max. Overhang Length L/D≈~7 | Right-hand shown
Left-hand Insert for Right-hand Toolholder, Right-hand Insert for Left-hand Toolholder.











F

Toolholder dimensions

Description	Availability		Dimension (mm)								GAMO (°)	Standard corner-R(RE)	Coolant hole	Fig.	Spare parts			Applicable inserts
	R	L	DMIN	DCON	CND	H	LH	LF	WF	Screw					Wrench	Wrench		
C05H- SWUB%L06-06AN	●	●	6	5	-	4.4	9	100	3	15	0.2	No	1	SB-2035TR	-	FT-6	WB□T0601... WB□W0601...	
C06J- SWUB%L06-07AN	●	●	7	6	-	5.4	10	110	3.5	13								
C07K- SWUB%L08-08AN	●	●	8	7	-	6.4	11	125	4	15	0.2	No	1	SB-2035TR				
E08L- SWUB%L08-10AN	●	●	10	8		7	14	140	5	13								
E10N- SWUB%L08-12AN SWUBR08-12AN2/3 SWUBR08-12AN1/2	●	●	12	10	3	9	18	160	6	10	0.2	Yes	2	SB-2050TR	-	FT-6	WB□T0802... WB□W0802...	
	●	105																
	●	80																
E12Q- SWUP%L11-14A SWUPR11-14A-2/3 SWUPR11-14A-1/2	●	●	14	12	4	11	23	180	7	4	0.4	Yes	2	SB-2545TR	-	FT-8	WP□T1102... WP□W1102...	
	●	120																
	●	90																
E16X- SWUP%L11-18A SWUPR11-18A-2/3 SWUPR11-18A-1/2	●	●	18	16	4	15	28	220	9	1	0.8	Yes	2	SB-4065TR	FT-15	-	WP□T1603... WP□W1603...	
	●	145																
	●	110																
E16X- SWUP%L16-18A SWUPR16-18A-2/3 SWUPR16-18A-1/2	●	●	18	16	4	15	28	220	9	3.5	0.8	Yes	2	SB-4065TR	FT-15	-	WP□T1603... WP□W1603...	
	●	145																
	●	110																
E20S- SWUP%L16-22A SWUPR16-22A-2/3 SWUPR16-22A-1/2	●	●	22	20	6	19	32	250	11	2	0.8	Yes	2	SB-4065TR	FT-15	-	WP□T1603... WP□W1603...	
	●	165																
	●	125																

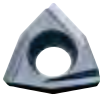
● : Standard item R : Right-hand only L : Left-hand only □ : Check availability

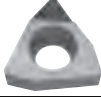
Applicable inserts

Applications	Minute ap	Finishing	Finishing	Finishing	Finishing - Medium	Finishing	Finishing	Finishing - Medium
Insert								
Chip Breaker Type	$\frac{R}{L}$ -CF	$\frac{R}{L}$ -PF	GP	$\frac{R}{L}$ -DP	HQ	$\frac{R}{L}$ -F	$\frac{R}{L}$ -P	$\frac{R}{L}$ -Y
Page	B105	B105	B107	B105	B107	B105, B106	B106	B107
Applications	Cast iron	Non-Ferrous Metals	Hard materials					
Insert								
Chip Breaker Type	No CB	PCD	CBN					
Page	B107	C51	C28					

Recommended cutting conditions  F152, F153



Boring

25° Insert Profiling Tools

ZBMT Series

Unique clamping structure and a wide lineup of external toolholders and boring bars. High precision and stable machining in a wide range of applications including copying, undercutting, tapering, V-slotting, spherical machining, and more.

1 Newly Developed Unique-Clamping Mechanism Achieves a Higher Rigidity

Side Lock Mechanism

Unique design holds insert at 2 points
Safe even for insert with small tip angle that is difficult to mount

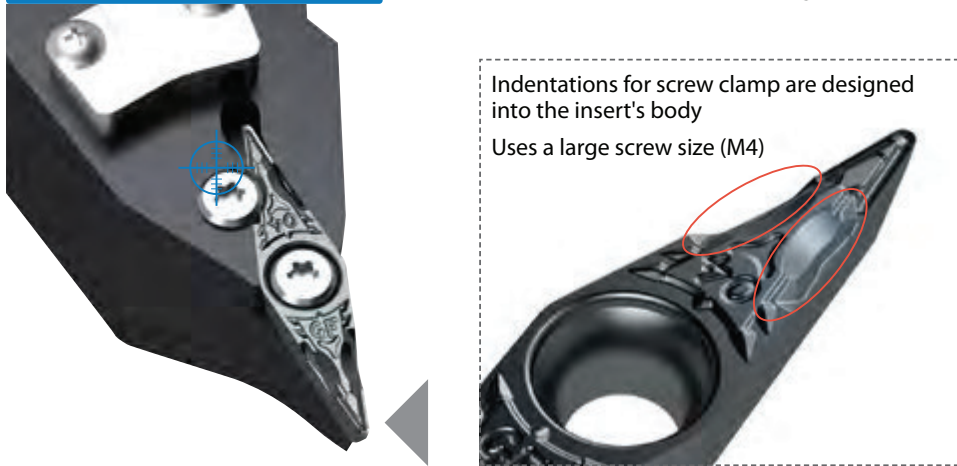

Indentations for screw clamp are designed into the insert's body
Uses a large screw size (M4)

Insert Displacement During Facing Comparison (Internal evaluation)

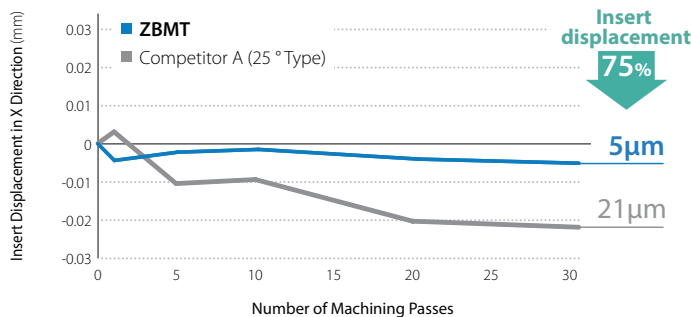

Cutting Conditions : Vc = 230 m/min, ap = 0.3 mm, f = 0.15 mm/rev, Wet Workpiece SCM435

*The above figures are not guaranteed. It depends on cutting conditions.

Check

- By controlling insert displacement,
- Machining precision is stabilized and long tool life is enable
 - Reduces defect rate due to sudden dimensional deviation

Provides High Quality and Stable Machining in Various Machining Applications

Excellent Performance in Various Machining Applications including Copying, Undercutting, Tapering, V-Slotting, Spherical Machining, etc.



CG images

2 Unique Holder Design to Meet Customers' Needs

Both boring bars and external toolholders are compatible with internal coolant.

Uses a clamp with a small thickness that does not prevent chip flow

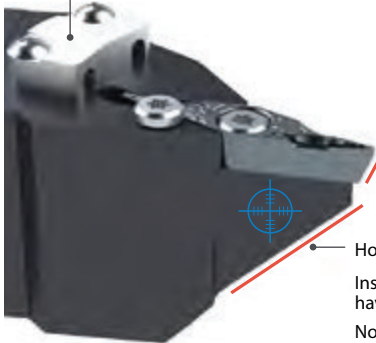

Unique Double Coolant Hole Design

Supplies coolant directly to the cutting edge and provides improved chip evacuation and long tool life (Coolant discharge direction: Fine adjustment possible)

*Though coolant stream hits side clamp screw, machining performance is not affected

*Pressure resistance: ~ 3 MPa

Fine Tuned and Adjustable
± 4° Adjustable Oscillation

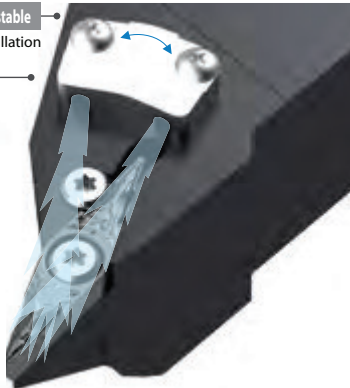

Easy to use for Facing

Insert corner : 2-Step Positive Type (20°)

Holder: Tapered shape

Inserts and toolholders have a unique end shape

No additional machining is required when trying to avoid interference with workpiece.



Effective for facing applications

3 New GF Chipbreaker for ZBMT Reduces Chip Control Issues at minute D.O.C.

GF Chipbreaker

Solving chip control issues leads to high-quality surface finishes

The thin molded chipbreaker extends near the corner and reliably controls chips even in narrow spaces

Two-step dot

Responds to chip fluctuation

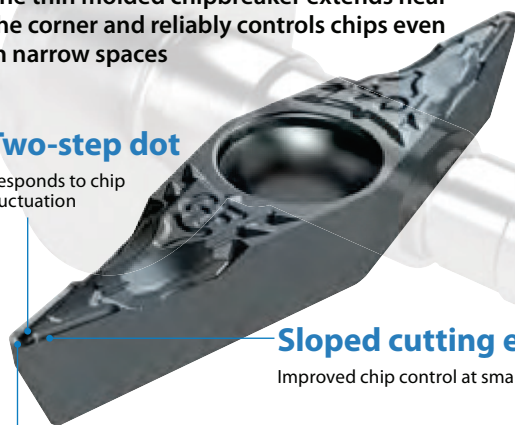

Sloped cutting edge

Improved chip control at small D.O.C.

Mortar-shaped chipbreaker

Low resistance and excellent chip control even in ductile workpieces

Chip control comparison
(Internal evaluation)



GF Chipbreaker



Competitor A (25° Type)

Cutting Conditions : Vc = 230 m/min, f = 0.15 mm/rev, ap = 0.2 - 0.5 mm, Wet Workpiece 34CrMo4 Facing

15° Inserts are also available upon customer requests

To avoid holder interference, additional modifications is required as shown in the figure on the right (Details: P8). Also, as shown in the figure below, special order for holders may be required depending on machining application.

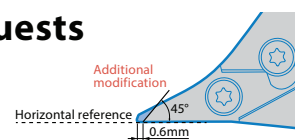

Examples

When using the toolholder in reverse mounting position



When using the toolholder in normal mounting position

* Holder: Special order specification

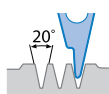
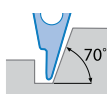

15° inserts are developed relative to 25° inserts
Helps avoid interference and supports a wider range of machining application

Corner-R 0.4

Double-blade design for turning and back turning

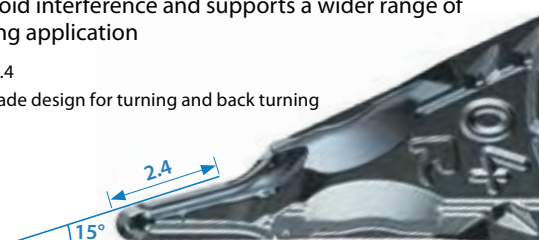

A-SZJB-AE Excellent bar (Spherical machining / Internal facing / Internal copying)

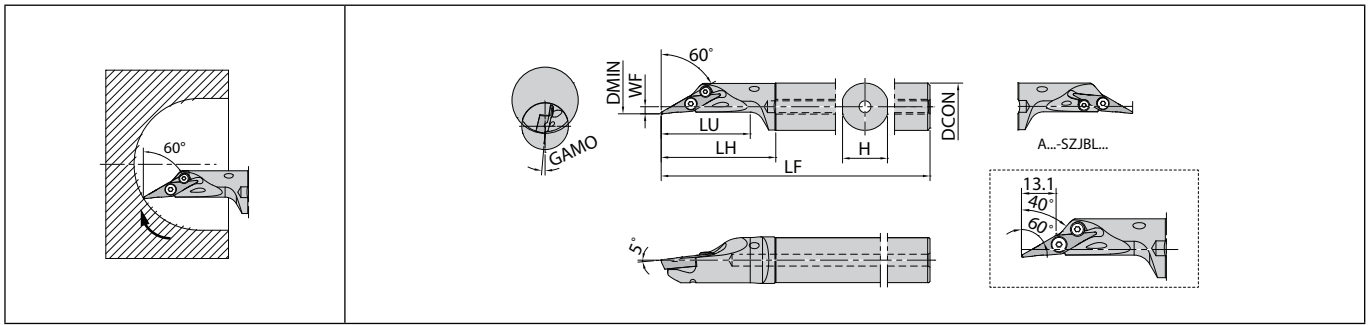

Max. Overhang Length L/D≈~5.5 | Right-hand shown | ZBMT13T304R-GF-15D is applicable to Right-hand Toolholder.

F

Toolholder dimensions

Description	Availability		Dimension (mm)										GAMO (°)	Standard corner-R(RE)	Coolant hole	Spare parts		Applicable inserts
			R	L	DMIN	DCON	CND	H	LH	LF	LU	WF				Screw	Wrench	
	Icon																	
A20R- SZJB%13-28AE	●	●	28	20		19	48	200	37.5	3	5	0.4	Yes	SB-3079TR	FT-8	ZBMT13T3...		
A25S- SZJB%13-30AE	●	●	30	25	5	24	58	250	47	3.5								
A32S- SZJB%13-40AE	●	●	40	32		31	72		61.5									

For application of A-SZJB-AE, please refer to **F93**.

Applicable inserts

Applications	Finishing	Finishing
Insert		
Chip Breaker Type	GF	R-GF-15D
Page	B108	B108

R-GF-15D inserts are only for the right-hand toolholders of A-SZJB-AE.

Recommended cutting conditions **F152, F153**

Applicable sleeves **F150**

● : Standard item R : Right-hand only L : Left-hand only □ : Check availability



Boring

Solid

Positive

AD bars

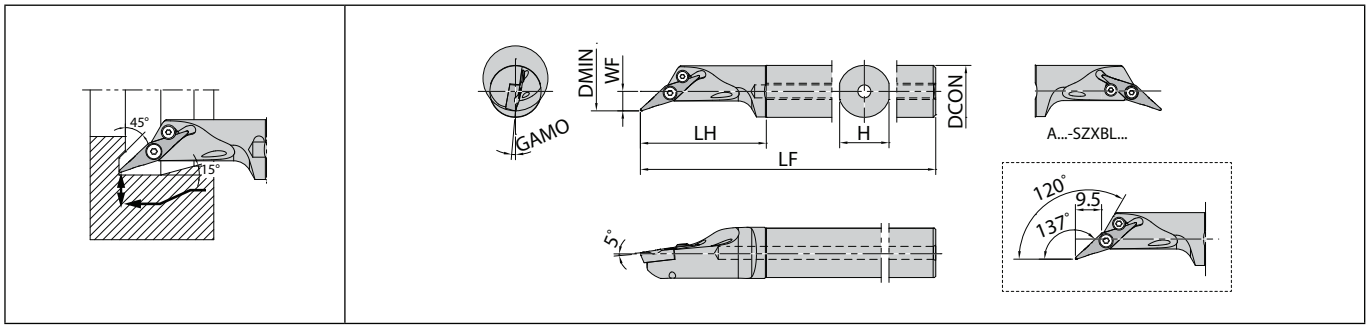

Negative

A-SZXB-AE Excellent bar (Internal facing / Internal copying / Undercutting)



Max. Overhang Length L/D≈5.5 | Right-hand shown

Toolholder dimensions

Description	Availability		Dimension (mm)								GAMO (°)	Standard corner-R(RE)	Coolant hole	Spare parts		Applicable inserts
	R	L	DMIN	DCON	CND	H	LH	LF	LU	WF				Screw	Wrench	
																
A20R- SZXB%13-25AE	●	●	25	20		19	48	200	37.5	7.5	5	0.4	Yes	SB-3079TR	FT-8	ZBMT13T3...
A25S- SZXB%13-30AE	●	●	30	25	5	24	58	250	45.2	7						
A32S- SZXB%13-40AE	●	●	40	32		31	74		60.2							



Applicable inserts

Applications	Finishing
Insert	
Chip Breaker Type	GF
Page	B108

Recommended cutting conditions ➔ **F152, F153**
 Applicable sleeves ➔ **F150**

● : Standard item R : Right-hand only L : Left-hand only □ : Check availability

A-SZQB-AE Excellent bar (Internal copying / Undercutting)

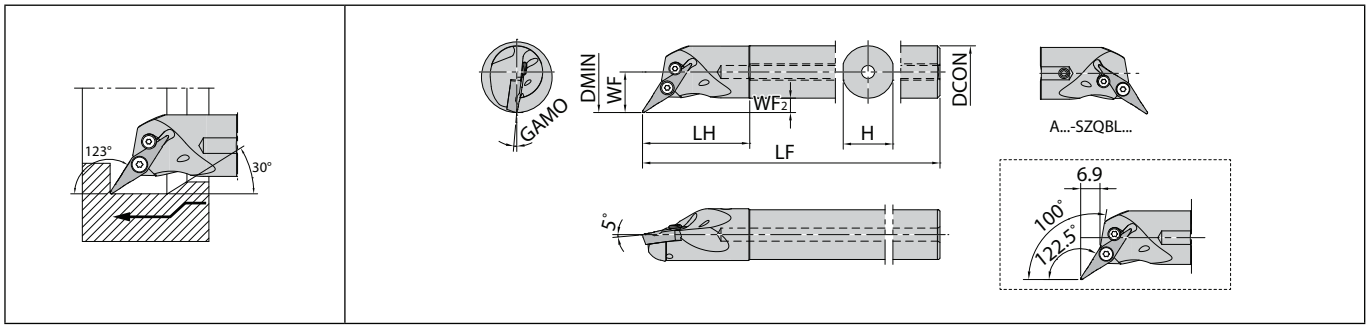

Max. Overhang Length L/D≈~5.5 | Right-hand shown

F

Toolholder dimensions

Description	Availability		Dimension (mm)								GAMO (°)	Standard corner-R(RE)	Coolant hole	Spare parts		Applicable inserts
	R	L	DMIN	DCON	CND	H	LH	LF	WF	WF ₂				Screw	Wrench	
A20R- SZQB% 13-27AE	●	●	27	20		19	41	200	15.5	5.5	5	0.4	Yes	SB-3079TR	FT-8	ZBMT13T3...
A25S- SZQB% 13-32AE	●	●	32	25	5	24	51	250	18							
A32S- SZQB% 13-40AE	●	●	40	32		31	54		22.5	6.5						

Applicable inserts

Applications	Finishing
Insert	
Chip Breaker Type	GF
Page	B108

Recommended cutting conditions F152, F153

Applicable sleeves F150

● : Standard item R : Right-hand only L : Left-hand only □ : Check availability

Boring

Solid

Positive

AD bars

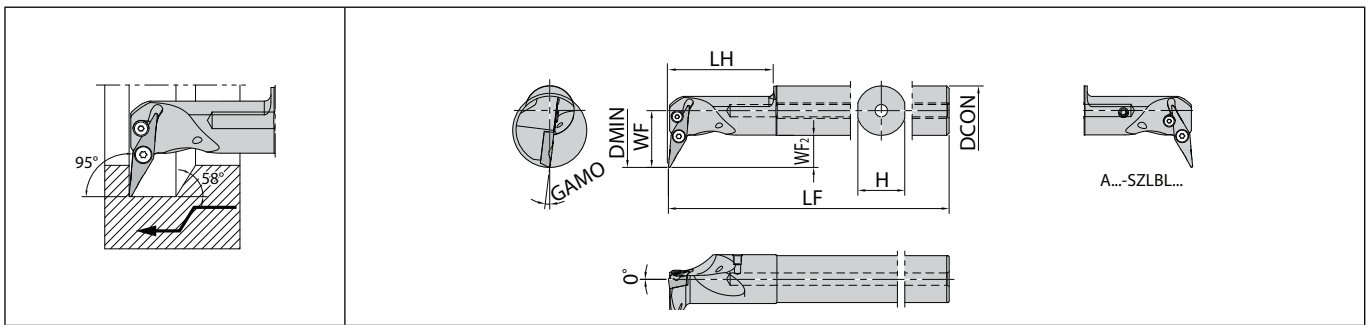

Negative

A-SZLB-AE Excellent bar (Internal copying)





Max. Overhang Length L/D≈5.5 | Right-hand shown | ZBMT13T304R-GF-15D is applicable to Left-hand Toolholder.

Toolholder dimensions

Description	Availability		Dimension (mm)										GAMO (°)	Standard corner-R(RE)	Coolant hole	Spare parts		Applicable inserts
																Screw	Wrench	
	R	L	DMIN	DCON	CND	H	LH	LF	WF	WF ₂								
A20R- SZLB%:13-30AE	●	●	30	20		19	42	200	23									ZBMT13T3...
A25S- SZLB%:13-34AE	●	●	34	25	5	24	64	250	25.5	13	7	0.4	Yes	SB-3079TR	FT-8			
A32S- SZLB%:13-40AE	●	●	40	32		31	86		29									

Applicable inserts

Applications	Finishing	Finishing
Insert		
Chip Breaker Type	GF	R-GF-15D
Page	B108	B108

R-GF-15D inserts are only for the left-hand toolholders of A-SZLB-AE.

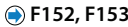
Recommended cutting conditions 

Applicable sleeves 



A-SZB-AE Excellent bar (Back boring)

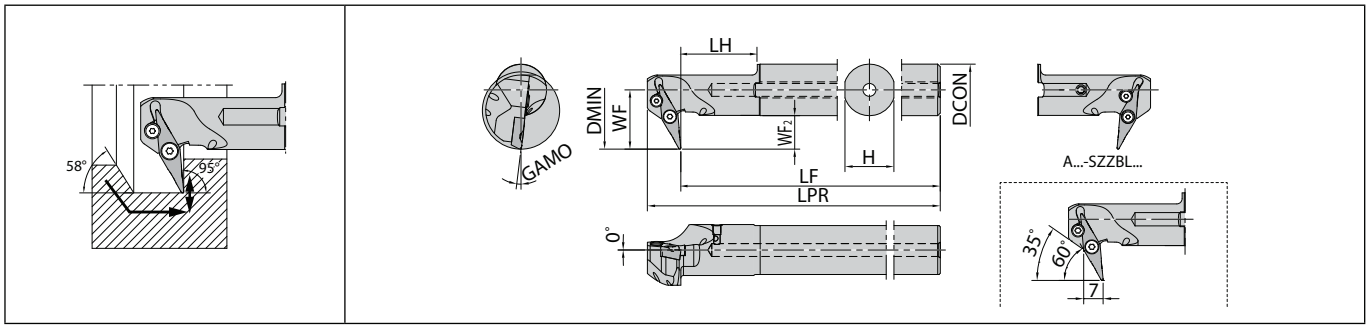

Max. Overhang Length L/D≈5.5 | Right-hand shown | ZBMT13T304R-GF-15D is applicable to Right-hand Toolholder.

F

Toolholder dimensions

Description	Availability		Dimension (mm)										GAMO (°)	Standard corner-R(RE)	Coolant hole	Spare parts		Applicable inserts		
	R	L	D_{MIN}	D_{CON}	CND	H	LH	LPR	LF	WF	WF₂	Screw				Wrench				
A20R- SZZB%:13-30AE	●	●	30	20		19	42	200	187	23										
A25S- SZZB%:13-34AE	●	●	34	25	5	24	58				25.5	13	7	0.4	Yes	SB-3079TR	FT-8		ZBMT13T3...	
A32S- SZZB%:13-40AE	●	●	40	32		31	74				29									

Applicable inserts

Applications	Finishing	Finishing
Insert		
Chip Breaker Type	GF	R-GF-15D
Page	B108	B108

R-GF-15D inserts are only for the right-hand toolholders of A-SZB-AE.

Recommended cutting conditions F152, F153

Applicable sleeves F150

Instructions

When mounting the insert (Tightening torque: 1.2 N·m)



1. Tighten the main screw with the insert pressed against the contact surface with fingertips.

2. Tighten the side screw to complete the installation.

When removing the insert

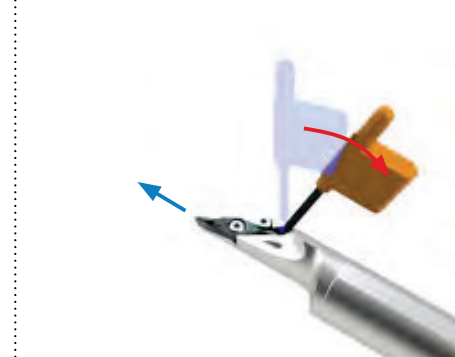

Remove the two screws and put the wrench into the gap at the back end of the insert. It can be easily removed by pushing out the insert as shown above.

● : Standard item R : Right-hand only L : Left-hand only □ : Check availability



Boring

Solid

Positive

AD bars

Negative

S-SSKP Steel shank bar (Boring)

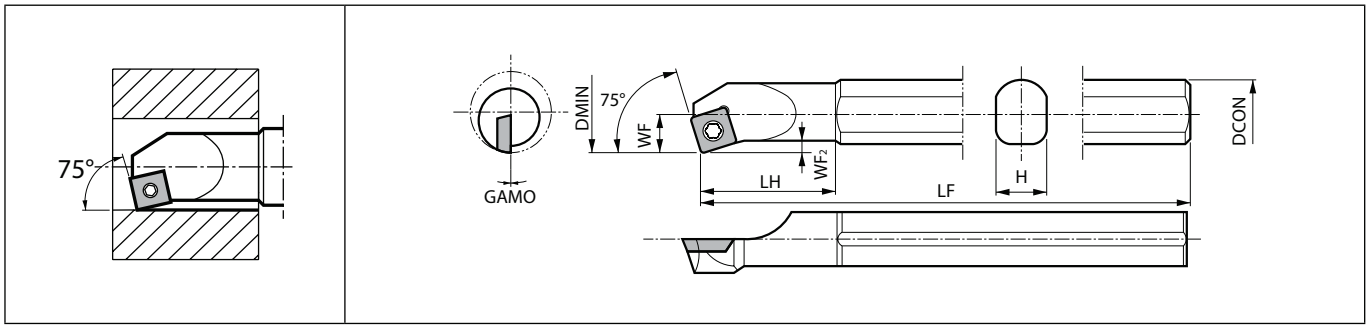

Max. Overhang Length $L/D \approx 3$ | Right-hand shown | Left-hand Insert for Right-hand Toolholder.

Toolholder dimensions

Description	Availability		Dimension (mm)							GAMO (°)	Standard corner-R(RE)	Coolant hole	Spare parts		Applicable inserts
	R	DMIN	DCON	H	LH	LF	WF	WF ₂	Screw				Wrench		
	S16Q-	SSKPR09-20	●	20	16	14	30	180	10				2	-3	



Applicable inserts

Applications	Finishing
Insert	
Chip Breaker Type	L
Page	B82

Recommended cutting conditions [F152](#), [F153](#)

Applicable sleeves [F150](#), [F151](#)

● : Standard item R : Right-hand only L : Left-hand only □ : Check availability

S-CSKP Steel shank bar (Boring)

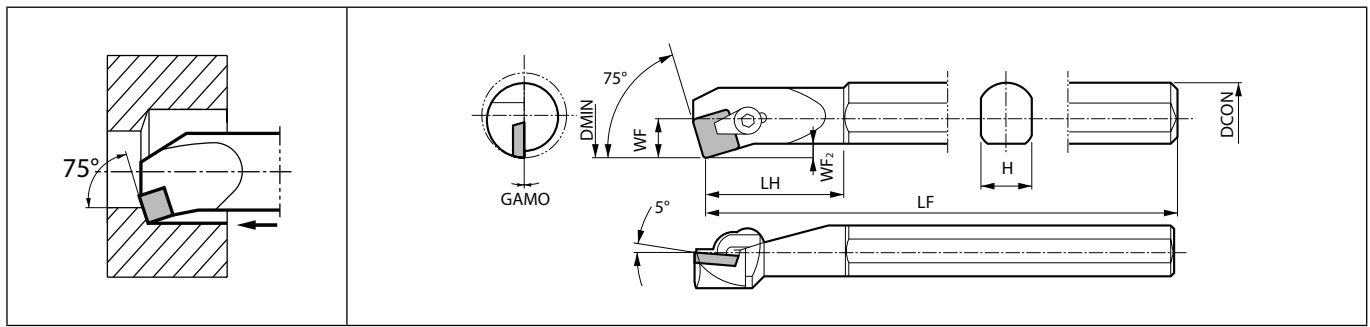

Max. Overhang Length L/D≈~3 | Right-hand shown | Left-hand Insert for Right-hand Toolholder.

F

Toolholder dimensions

Description	Availability	Dimension (mm)								GAMO (°)	Standard corner-R(RE)	Coolant hole	Spare parts			Applicable inserts
		R	DMIN	DCON	H	LH	LF	WF	WF2				Clamp set	Wrench	Wrench	
S16N- CSKPR09-20	●	20	16	14	40	160	10	2	0	0.8	No	CPS-2	-	FH-2.5	SP□N0903... SP□R0903...	
S20Q- CSKPR09-27	●	27	20	18	45	180	13.5	3.5	0	0.8	No	CPS-2	-	FH-2.5	SP□N0903... SP□R0903...	
S25X- CSKPR12-34	●	34	25	23	60	220	17	4.5	0	0.8	No	CPS-3	LW-3	-	SP□N1203..., SP□R1203...	

Applicable inserts

Applications	Medium	Medium	Finishing - Medium	Cast iron	Cast iron	Non-Ferrous Metals
Insert						
Chip Breaker Type	G	STD	L	No CB	Ceramic	PCD
Page	B83	B83	B83	B83	B121	C43

Recommended cutting conditions F152, F153

Applicable sleeves F150, F151

● : Standard item R : Right-hand only L : Left-hand only □ : Check availability

S-CTUP Steel shank bar (Boring)

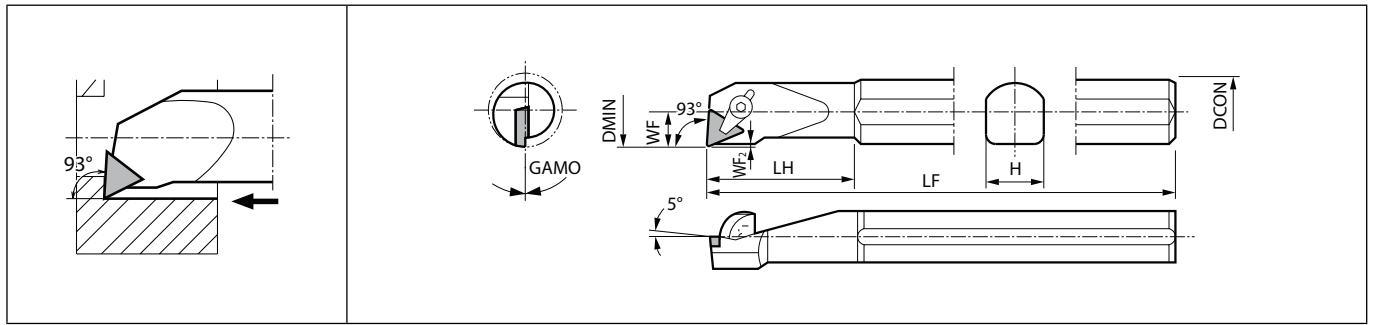

Max. Overhang Length L/D≈3 | Right-hand shown
Left-hand Insert for Right-hand Toolholder, Right-hand Insert for Left-hand Toolholder.

Toolholder dimensions

Description	Availability		Dimension (mm)								GAMO (°)	Standard corner-R(RE)	Coolant hole	Spare parts						Applicable inserts
														Clamp set	Clamp set	Shim screw	Shim	Wrench	Wrench	
	R	L	DMIN	DCON	H	LH	LF	WF	WF ₂	Clamp set				Clamp set	Shim screw	Shim	Wrench	Wrench		
S12L- CTUPR09-16	●		16	12	11	32	140	8	0.5	0	0.4	No	CPS-1	-	-	-	-	FH-2	TP□N0902... TP□R0902...	
S16N- CTUP ^{9/11} -20	●	●	20	16	15	30	160	10	0.5	0	0.4	No	-	CPS-2	-	-	-	FH-2.5	TP□N1103... TP□R1103...	
S20Q- CTUP ^{9/11} -27	●	●	27	20	18	40	180	13.5	1.3	0	0.4	No	-	CPS-2	-	-	-	FH-2.5	TP□N1103... TP□R1103...	
S25X- CTUP ^{9/16} -34	●	●	34	25	23	60	220	17		0	0.8	No	-	CPS-3	-	-	-	-	TP□N1603... TP□R1603...	
S32S- CTUP ^{9/16} -43	●	●	43	32	30	70	250	21.5		0	0.8	No	-	CPS-3	SP3X10	KPT-32	LW-3	-	TP□N1603... TP□R1603...	
S40X- CTUP ^{9/16} -50	●	●	50	40	37	80	315	25		0	0.8	No	-	CPS-3	SP3X10	KPT-32	LW-3	-	TP□N1603... TP□R1603...	

Applicable inserts

Applications	Finishing	Finishing	Finishing - Medium	Medium	Medium	Finishing	Finishing	Finishing - Medium
Insert								
Chip Breaker Type	DP	GP	HQ	G	STD	9/16-F	9/16-A	9/16-B
Page	B95	B95	B95	B95	B95	B96	B96	B96
Applications	Medium	Cast iron	Cast iron	Non-Ferrous Metals	Hard materials			
Insert								
Chip Breaker Type	9/16-C	No CB	Ceramic	PCD	CBN			
Page	B96	B96	B122	C48	C25			

Recommended cutting conditions ➔ F152, F153

Applicable sleeves ➔ F149~F151

● : Standard item R : Right-hand only L : Left-hand only □ : Check availability



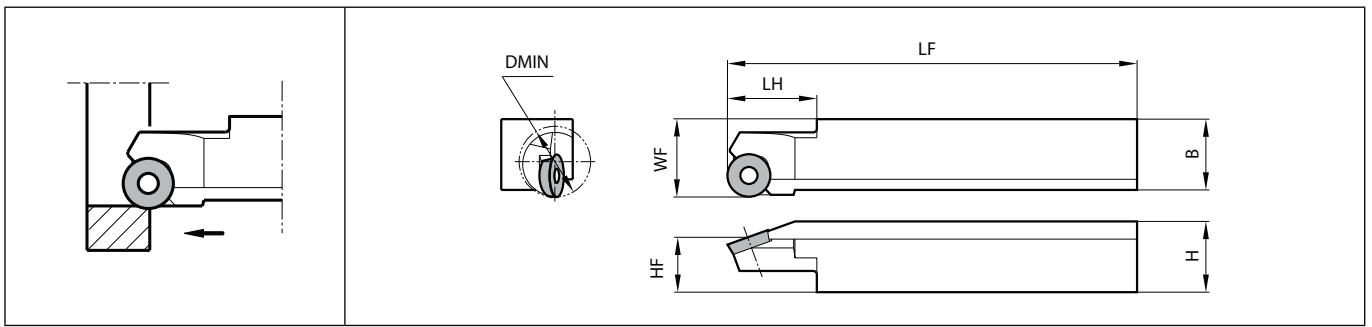

SRCP-B (Boring)



Right-hand shown

F

Toolholder dimensions

Description	Availability		Dimension (mm)									Spare parts			Applicable inserts
												Screw	Wrench	Wrench	
	R	L	D _{MIN}	H	B	LH	HF	LF	WF						
SRCP ^{PL} 2020B-12-A20	●	●	20	20	20	25	15.5	125	22	SB-4TR	FT-15	-	RPMT1203M0-BB		
SR CPR 2525B-16-A32	●		32	25	25	31	20	150	27	SB-5090TR	-	LTW-20	RPMT1604M0-BB		

Applicable inserts

Applications	Bearing machining
Insert	
Chip Breaker Type	BB
Page	B109

● : Standard item R : Right-hand only L : Left-hand only □ : Check availability

Boring

Solid

Positive

AD bars

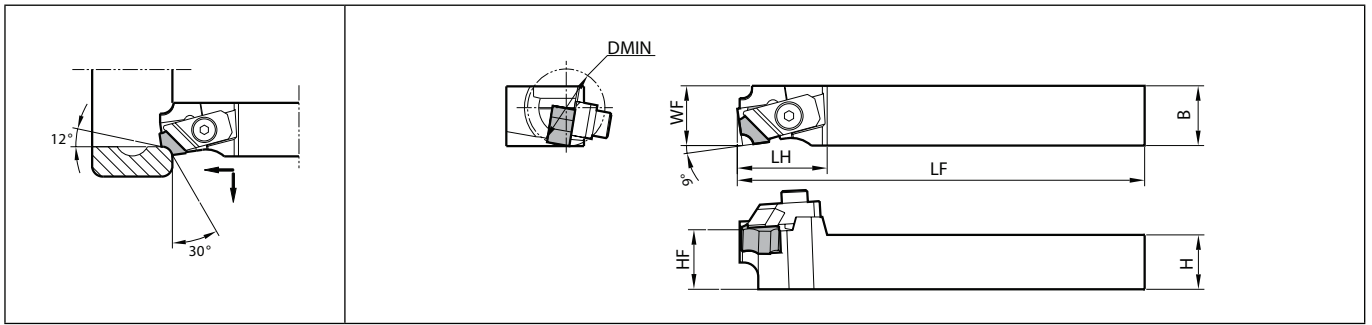

Negative

CBSN-B (Internal round chamfering)



Right-hand shown

Toolholder dimensions

Description	Availability	Dimension (mm)								Spare parts		Applicable inserts
		R	DMIN	H	B	LH	HF	LF	WF	Clamp set (R)	Wrench	
												
CBSNR 2020B-12-A20	●	20	20	20	32	21	125	20	CP-RCR	LW-5	SNMF1204..-21	
2525B-12-A20	●	25	25	32	26	150	25					

Applicable inserts

Applications	Bearing machining
Insert	
Chip Breaker Type	21
Page	B109



● : Standard item R : Right-hand only L : Left-hand only □ : Check availability

HA-PCLN (Boring / Internal facing)

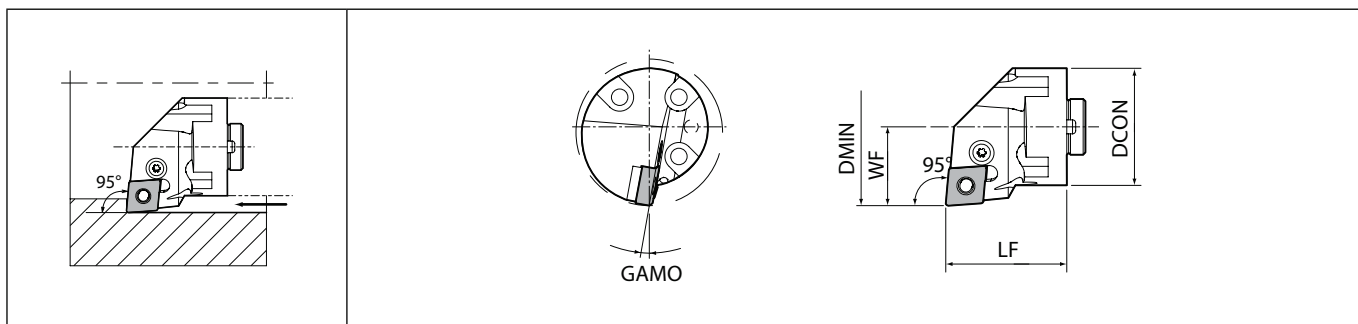

Right-hand shown | Left-hand Insert for Right-hand Toolholder, Right-hand Insert for Left-hand Toolholder.

F

Toolholder dimensions

Description	Availability		Dimension (mm)				GAMO (°)	Standard corner-R(RE)	Coolant hole	Spare parts						Applicable boring adapter	Applicable inserts	
	R	L	DMIN	DCON	LF	WF				Lever	Lock screw	Punch*	Shim pin	Shim	Wrench*			
HA32 PCLN%L12-40	●	●	40	32		22											AD32U	CN□A1204...
HA40 PCLN%L12-50	●	●	50	40	41	27	10	0.8	Yes	LL-2K	LS-2P	PC-2K	LSP-3K	LC-4K	DTPM-15		AD40V	CN□G1204...
HA50 PCLN%L12-63	●	●	63	50		35											AD50W	CN□M1204...





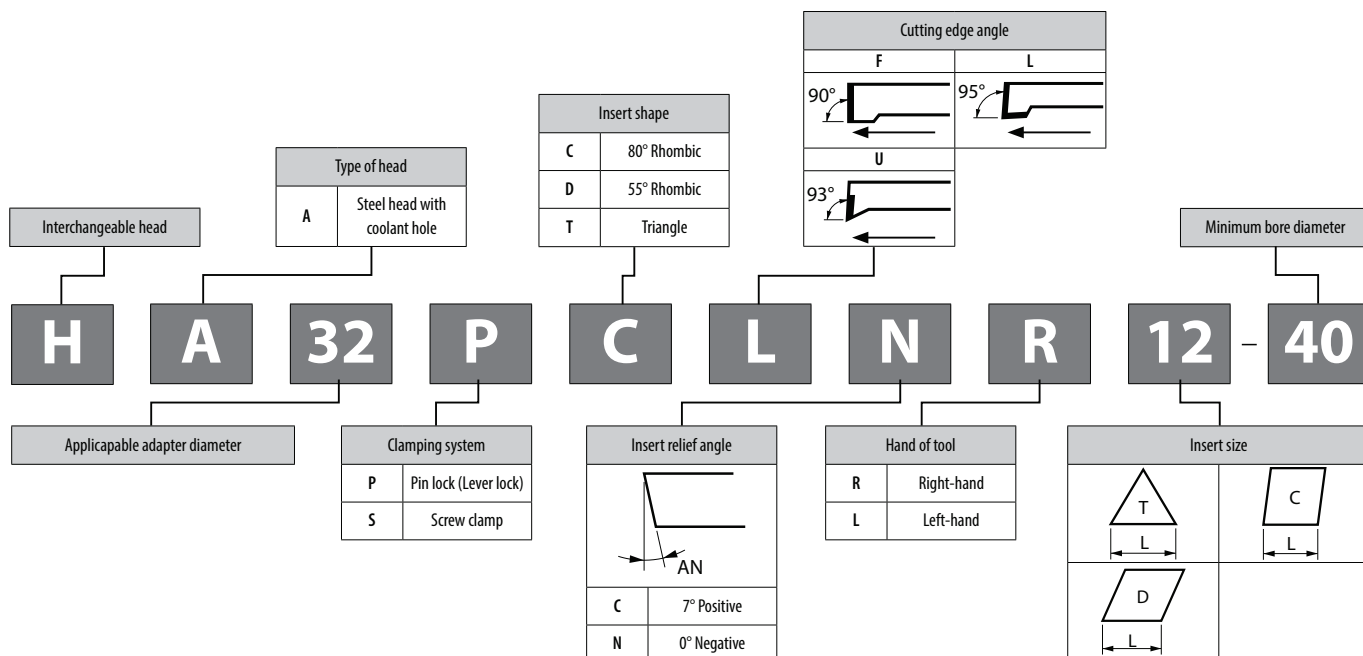









Punch (PC-2K) : Not included. Purchase separately.
Included wrench is L type.

AD bars - Identification system for interchangeable heads

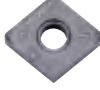

● : Standard item R : Right-hand only L : Left-hand only □ : Check availability

Applicable inserts

Applications	Finishing	Finishing	Finishing - Medium	Finishing - Medium	Finishing	Finishing	Finishing - Medium	Finishing - Medium
Insert								
Chip Breaker Type	WF	WP	WE	WQ	PP	GP	PQ	HQ
Page	B16	B16	B16	B16	B16	B16	B16	B17
Applications	Finishing - Medium	Finishing - Medium	Medium	Medium - Roughing	Medium - Roughing	Medium - Roughing	Medium - Roughing	Medium - Roughing
Insert								
Chip Breaker Type	CQ	CJ	TN-V	GS	PG	PS	PT	GT
Page	B17	B17	B17	B17	B17	B18	B18	B18
Applications	Roughing	Roughing	Roughing	Medium	Medium - Roughing	Medium - Roughing	Low carbon steel	Low carbon steel
Insert								
Chip Breaker Type	STD	PH	PX	R/L	P/L-25R	Z	XF	XP
Page	B18	B18	B19	B23	B23	B23	B19	B19
Applications	Low carbon steel	Low carbon steel	Finishing - Medium	Medium - Roughing	Stainless steel / Heat-resistant alloys	Stainless steel / Heat-resistant alloys	Stainless steel / Heat-resistant alloys	Stainless steel / Heat-resistant alloys
Insert								
Chip Breaker Type	XQ	XS	SK	FP-TK	TK	MQ	MS	MU
Page	B19	B19	B19	B19	B20	B20	B20	B20
Applications	Cast iron	Cast iron	Cast iron	Cast iron	Cast iron	Cast iron	Cast iron	Cast iron / Hard materials
Insert								
Chip Breaker Type	KQ	KG	KH	C	ZS	GC	No CB	Ceramic
Page	B21	B21	B21	B22	B22	B22	B22	B113
Applications	Non-Ferrous Metals	Non-Ferrous Metals	Non-Ferrous Metals	Heat-resistant alloys	Heat-resistant alloys	Hard materials	Hard materials	Hard materials
Insert								
Chip Breaker Type	P/L-A3	AH	PCD	SQ	SG	HH	HL	HD
Page	B23	B23	C34	B20	B21	C9	C9	C9
Applications	Hard materials / Cast iron							
Insert								
Chip Breaker Type	CBN							
Page	C8							



Recommended cutting conditions  F152, F153

HA-PDUN (Internal copying)

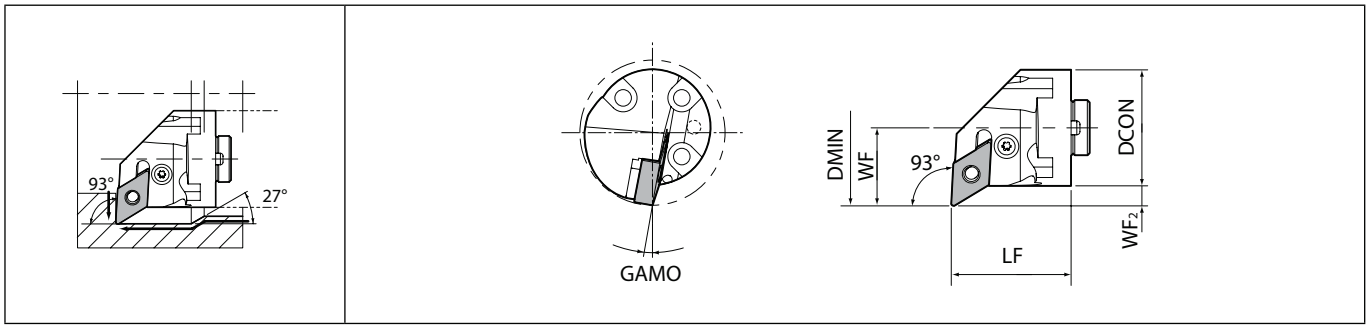

Right-hand shown | Left-hand Insert for Right-hand Toolholder, Right-hand Insert for Left-hand Toolholder.

F

Toolholder dimensions

Description	Availability		Dimension (mm)					GAMO (°)	Standard corner-R(RE)	Coolant hole	Spare parts						Applicable boring adapter	Applicable inserts
			R	L	DMIN	DCON	LF				WF	WF ₂	Lever	Lock screw	Punch*	Shim pin		
	HA32 PDUN%15-43	●	●	43	32		25	9	12	0.8	Yes							AD32U
HA40 PDUN%15-50	●	●	50	40	41	27	7	10	LL-3K			LS-3P	PC-2K	LSP-3K	LD-4K43 (LD-4K*)	DTPM-15	AD40V	DN□G1504...
HA50 PDUN%15-63	●	●	63	50		35	10										AD50W	DN□M1504...

Punch (PC-2K) : Not included. Purchase separately.

Included wrench is L type.

Shim : LD-4K43 is attached to Toolholder. When using DN□1506 Insert, purchase LD-4K separately.

For WF chipbreaker, cutting edge offsets or program corrections are required on R34 and R35.

● : Standard item R : Right-hand only L : Left-hand only □ : Check availability



Boring

Solid

Positive

AD bars

Negative

Applicable inserts

Applications	Finishing	Finishing	Finishing	Finishing - Medium	Finishing - Medium	Finishing - Medium	Finishing - Medium	Medium
Insert								
Chip Breaker Type	WF	PP	GP	PQ	HQ	CQ	CJ	TN-V
Page	B24	B24	B24	B24	B25	B25	B25	B25
Applications	Medium - Roughing	Medium - Roughing	Medium - Roughing	Medium - Roughing	Medium - Roughing	Roughing	Roughing	Roughing
Insert								
Chip Breaker Type	GS	PG	PS	PT	GT	STD	PH	PX
Page	B25	B26	B26	B26	B26	B27	B27	B27
Applications	Medium	Low carbon steel	Low carbon steel	Low carbon steel	Low carbon steel	Finishing - Medium	Large ap	Medium - Roughing
Insert								
Chip Breaker Type	R/L	XF	XP	XQ	XS	SK	R-LD	FP-TK
Page	B31	B27	B27	B27	B27	B28	B28	B28
Applications	Stainless steel / Heat-resistant alloys	Stainless steel / Heat-resistant alloys	Stainless steel / Heat-resistant alloys	Stainless steel / Heat-resistant alloys	Cast iron	Cast iron	Cast iron	Cast iron
Insert								
Chip Breaker Type	TK	MQ	MS	MU	KQ	KG	KH	C
Page	B28	B28	B29	B29	B30	B30	B30	B30
Applications	Cast iron	Cast iron	Cast iron	Cast iron / Hard materials	Non-Ferrous Metals	Non-Ferrous Metals	Non-Ferrous Metals	Heat-resistant alloys
Insert								
Chip Breaker Type	ZS	GC	No CB	Ceramic	A3	AH	PCD	SQ
Page	B30	B30	B31	B114	B31	B31	C35	B29
Applications	Heat-resistant alloys	Hard materials	Hard materials	Hard materials	Hard materials / Cast iron			
Insert								
Chip Breaker Type	SG	HH	HL	HD	CBN			
Page	B29	C11	C11	C11	C10			

Recommended cutting conditions  F152, F153



HA-PTFN (Internal copying)

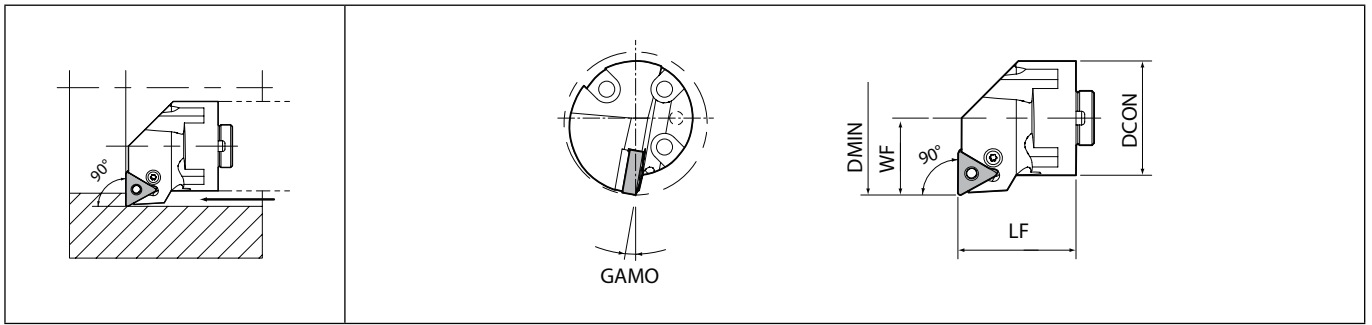

Right-hand shown | Left-hand Insert for Right-hand Toolholder, Right-hand Insert for Left-hand Toolholder.

F

Toolholder dimensions

Description	Availability		Dimension (mm)				GAMO (°)	Standard corner-R(RE)	Coolant hole	Spare parts						Applicable boring adapter	Applicable inserts
										Lever	Lock screw	Punch*	Shim pin	Shim	Wrench*		
	R	L	DMIN	DCON	LF	WF	LL-1K	LS-1P	PC-2K	LSP-2K	LT-3K	DTPM-10					
HA32 PTFN%L16-40	●	●	40	32		22	10	0.8	Yes							AD32U	TN□A1604...
HA40 PTFN%L16-50	●	●	50	40	41	27										AD40V	TN□G1604...
HA50 PTFN%L16-63	●	●	63	50		35	8									AD50W	TN□M1604... TN□X1604...

Punch (PC-2K) : Not included. Purchase separately.

Included wrench is L type.

For WF chipbreaker, cutting edge offsets or program corrections are required on **R34** and **R35**.

● : Standard item R : Right-hand only L : Left-hand only □ : Check availability



Boring











































Solid

Positive

AD bars

Negative

Applicable inserts

Applications	Finishing	Finishing	Finishing	Finishing - Medium	Finishing - Medium	Finishing - Medium	Medium - Roughing	Medium - Roughing
Insert								
Chip Breaker Type	WF	PP	GP	PQ	HQ	CQ	GS	PG
Page	B39	B39	B39	B39	B39	B39	B40	B40
Applications	Medium - Roughing	Medium - Roughing	Medium - Roughing	Roughing	Roughing	Roughing	Finishing	Finishing - Medium
Insert								
Chip Breaker Type	PS	PT	GT	STD	PH	PX	1/2-SSF	1/2-B
Page	B40	B40	B40	B40	B41	B41	B45	B45
Applications	Medium - Roughing	Medium - Roughing	Low carbon steel	Low carbon steel	Low carbon steel	Low carbon steel	Finishing - Medium	Large ap
Insert								
Chip Breaker Type	1/2-C	1/2-25R	XF	XP	XQ	XS	SK	R-LD
Page	B46	B46	B41	B41	B41	B41	B42	B42
Applications	Medium - Roughing	Stainless steel / Heat-resistant alloys	Stainless steel / Heat-resistant alloys	Stainless steel / Heat-resistant alloys	Stainless steel / Heat-resistant alloys	Stainless steel	Cast iron	Cast iron
Insert								
Chip Breaker Type	FP-TK	TK	MQ	MS	MU	1/2-ST	KQ	KG
Page	B42	B42	B42	B42	B42	B43	B43	B43
Applications	Cast iron	Cast iron	Cast iron	Cast iron	Cast iron	Cast iron / Hard materials	Non-Ferrous Metals	Non-Ferrous Metals
Insert								
Chip Breaker Type	KH	C	ZS	GC	No CB	Ceramic	1/2-A3	AH
Page	B43	B43	B43	B43	B44	B118	B44	B44
Applications	Non-Ferrous Metals	Heat-resistant alloys	Hard materials / Cast iron					
Insert								
Chip Breaker Type	PCD	SG	CBN					
Page	C36	B43	C13					



Recommended cutting conditions  F152, F153

HA-SCLC (Boring / Internal facing)

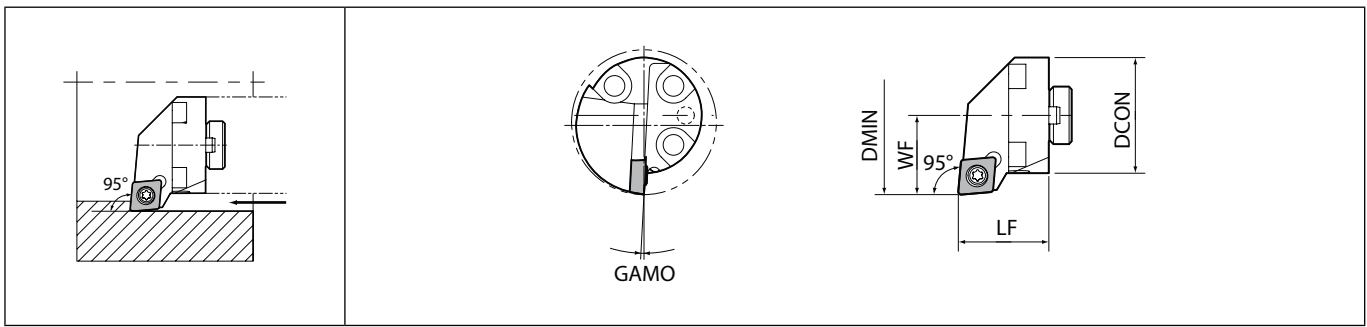

Right-hand shown | Left-hand Insert for Right-hand Toolholder, Right-hand Insert for Left-hand Toolholder.

F

Toolholder dimensions

Description	Availability		Dimension (mm)				GAMO (°)	Standard corner-R(RE)	Coolant hole	Spare parts		Applicable boring adapter	Applicable inserts
	R	L	DMIN	DCON	LF	WF				Screw	Wrench		
HA32 SCLC%L09-40	●	●	40	32	25	22	3	0.8	Yes	SB-3580TR	FT-15	AD32U	CC-T09T3... CC-W09T3...

Applicable inserts

Applications	Finishing	Finishing	Finishing	Finishing	Finishing - Medium	Finishing	Finishing	Finishing - Medium
Insert								
Chip Breaker Type	GF	SKS	SK	CK	GQ	WP	PP	GK
Page	B58	B59	B59	B59	B59	B60	B60	B60
Applications	Finishing - Medium	Medium	Medium	Finishing	Low feed	Low feed	Low feed	Stainless steel / Heat-resistant alloys
Insert				%L-P insert"/>	%L-U insert"/>	%L-USF insert"/>	%L-J insert"/>	
Chip Breaker Type	HQ	STD	MF	%L-P	%L-U	%L-USF	%L-J	MQ
Page	B60	B60	B61	B63	B63~B65	B63	B65	B61
Applications	Cast iron	Non-Ferrous Metals	Non-Ferrous Metals	Non-Ferrous Metals	Non-Ferrous Metals	Non-Ferrous Metals	Hard materials	
Insert			%L-A3 insert"/>					
Chip Breaker Type	No CB	AP	%L-A3	AH	PCD	APD	CBN	
Page	B66	B66	B66	B66	C39	C40	C20	

Recommended cutting conditions F152, F153

● : Standard item R : Right-hand only L : Left-hand only □ : Check availability



Boring

Solid

Positive

AD bars

Negative

HA-SDUC (Internal copying)

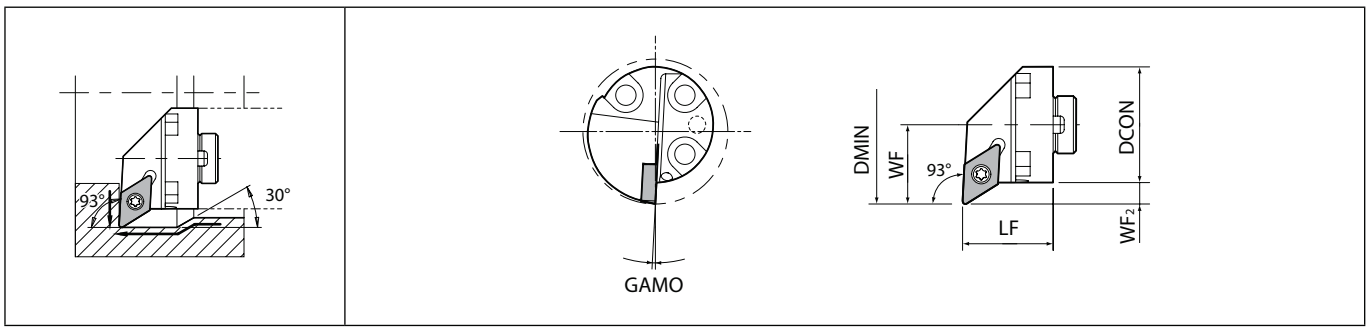

Right-hand shown | Left-hand Insert for Right-hand Toolholder, Right-hand Insert for Left-hand Toolholder.

Toolholder dimensions

Description	Availability		Dimension (mm)						GAMO (°)	Standard corner-R(RE)	Coolant hole	Spare parts		Applicable boring adapter	Applicable inserts
	R	L	DMIN	DCON	LH	LF	WF	WF ₂				Screw	Wrench		
HA32 SDUC ^{CF} 11-40	●	●	40	32	25	25	22	6	3	0.8	Yes	SB-3580TR	FT-15	AD32U	DC□T11T3..., DC□W11T3..., DC□X11T3...

For WP chipbreaker, cutting edge offsets or program corrections are required on R36 and R37.

Applicable inserts

Applications	Minute ap	Finishing	Finishing	Finishing	Finishing	Finishing - Medium	Finishing	Finishing
Insert								
Chip Breaker Type	CF	GF	SKS	SK	CK	GQ	WP	1/2-WP
Page	B68	B68	B68	B68	B68	B69	B69	B69
Applications	Finishing	Finishing	Finishing - Medium	Finishing - Medium	Medium	Medium	Finishing	Finishing
Insert								
Chip Breaker Type	PP	GP	GK	HQ	STD	MF	1/2-F	1/2-FSF
Page	B69	B69	B70	B70	B70	B70	B72, B73	B72
Applications	Low feed	Low feed	Low feed	Low feed	Low carbon steel	Low carbon steel	Stainless steel / Heat-resistant alloys	Cast iron
Insert								
Chip Breaker Type	1/2-U	1/2-USF	1/2-J	1/2-JSF	XP	XQ	MQ	No CB
Page	B74~B76	B74	B77	B76	B71	B71	B71	B78
Applications	Non-Ferrous Metals	Non-Ferrous Metals	Non-Ferrous Metals	Non-Ferrous Metals	Non-Ferrous Metals	Hard materials		
Insert								
Chip Breaker Type	AP	1/2-A3	AH	PCD	APD	CBN		
Page	B78	B78	B78	C42	C42	C22		

Recommended cutting conditions F152, F153

● : Standard item R : Right-hand only L : Left-hand only □ : Check availability



Boring adapter

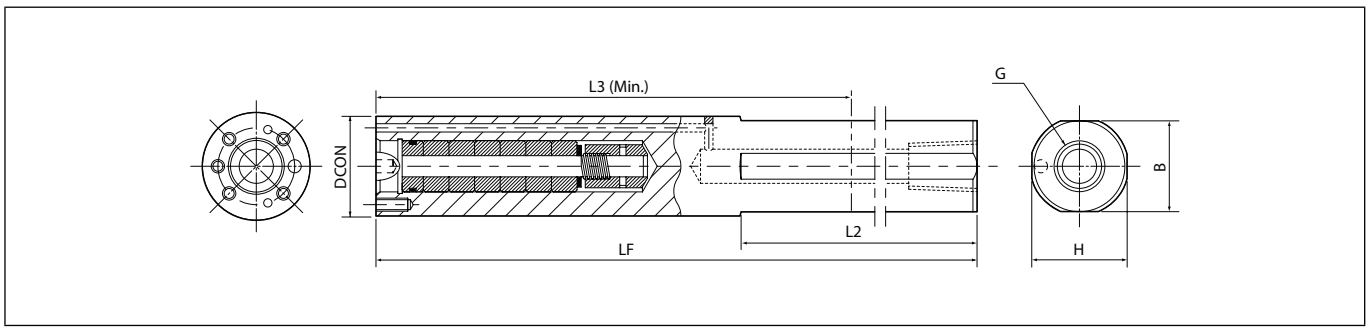

Toolholder dimensions

Description	Availability	Dimension (mm)						Spare parts			
		DCON	H	B	LF	L2	L3 (Min.)	G	Clamp bolt	Wrench	
AD 32U	●	32	31	29	310	200	200	Rp3/8	HH5X20 (3 pcs)	HH5X30 (1 pcs)	LW-4
AD 40V	●	40	39	37	360	248	228	Rp3/8	HH5X20 (3 pcs)	HH5X30 (1 pcs)	LW-4
AD 50W	●	50	47	47	410	280	276	Rp3/8	HH6X20 (3 pcs)	HH6X30 (1 pcs)	LW-5

Combination of boring adapter and interchangeable head

Interchangeable Head Description	Boring Adapter			
	Base Description	Clamp Bolt		Wrench
HA32 PCLN [®] /L 12-40	AD32U	HH5X20	HH5X30	LW-4
PDUN [®] /L 15-43				
PTFN [®] /L 16-40		HH5X20		
SCLC [®] /L 09-40		HH5X20		
SDUC [®] /L 11-40		HH5X20		
HA40 PCLN [®] /L 12-50	AD40V	HH5X20	HH5X30	LW-4
PDUN [®] /L 15-50				
PTFN [®] /L 16-50				
HA50 PCLN [®] /L 12-63	AD50W	HH6X20	HH6X30	LW-5
PDUN [®] /L 15-63				
PTFN [®] /L 16-63				

How to change heads



1. No head attached



2. Align hole positions



3. Tighten 3 bolts to attach the head

For lever lock type Interchangeable head, use 2 short bolts for upper side and 1 long bolt for lower side.
 HA32 SCLC[®]/L 09-40 and
 HA32 SDUC[®]/L 11-40 use HH5X20
 for all 3 bolts.

● : Standard item R : Right-hand only L : Left-hand only □ : Check availability

A-DCLN (Boring / Internal facing)

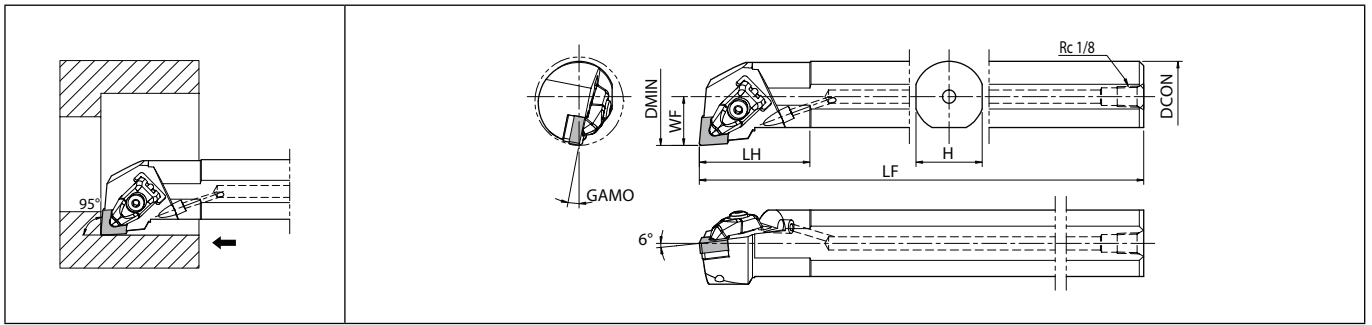

Max. Overhang Length L/D≈3 | Right-hand shown
Left-hand Insert for Right-hand Toolholder, Right-hand Insert for Left-hand Toolholder.

Toolholder dimensions

Description	Availability		Dimension (mm)							GAMO (°)	Standard corner-R(RE)	Coolant hole	Spare parts							Applicable inserts
			R	L	DMIN	DCON	H	LH	LF				WF	Clamp	Screw (for clamp)	Spring	Wrench (for clamp)	Shim	Screw (for shim)	
	A25R- DCLN [®] 12-32	●	●	32	25	23	42	200	17				11	0.8	Yes					
A32S- DCLN [®] 12-40	●	●	40	32	30	50	250	22												CN□M1204...
A40T- DCLN [®] 12-50	●	●	50	40	37	60	300	27	14											

Not applicable to high-pressure coolant
Wrench (FT-15) is sold separately.



● : Standard item R : Right-hand only L : Left-hand only □ : Check availability

S-PCLN (Boring / Internal facing)

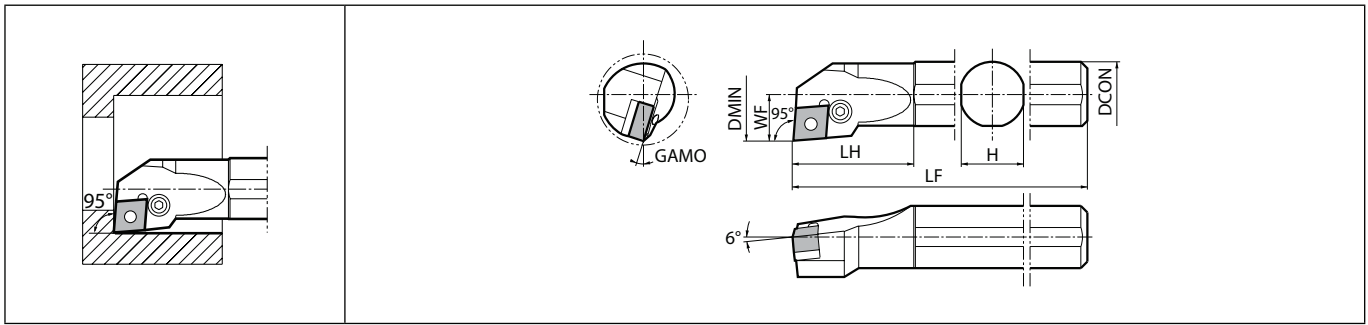

Max. Overhang Length L/D≈3 | Right-hand shown
Left-hand Insert for Right-hand Toolholder, Right-hand Insert for Left-hand Toolholder.

F

Toolholder dimensions

Description	Availability		Dimension (mm)							GAMO (°)	Standard corner-R(RE)	Coolant hole	Spare parts							Applicable inserts					
	R	L	DMIN	DCON	H	LH	LF	WF	Lever				Lock screw	Punch	Shim pin	Shim pin	Shim	Wrench	Wrench						
S16M- PCLN%09-20	●	●	20	16	15	34	150	11	16	0.8	No	LL-03SN	LS-03SN	-	-	P-03S	-	-	-	-	-	-	-	-	
S20Q- PCLN%09-27	●	●	27	20	19	37	180	14.2	17			LL-1N	LS-1SN	PC-1	LSP-1	-	LC-32N	-	-	-	-	-	-	-	CN□G0904...
S25R- PCLN%09-32	●	●	32	25	24	42	200	15.7	15			LL-2N	LS-2N	PC-2	LSP-2	-	LC-42N%L	LW-3	-	-	-	-	-	-	CN□A1204... CN□G1204... CN□M1204...
S25R- PCLN%12-32	●	●	32	25	24	42	200	16.3	16	10	No	LL-2N	LS-2N	PC-2	LSP-2	-	LC-42N%L	LW-3	-	-	-	-	-	-	-
S32S- PCLN%12-40	●	●	40	32	30	50	250	21	10			LL-2N	LS-2N	PC-2	LSP-2	-	LC-42N%L	LW-3	-	-	-	-	-	-	-
S40T- PCLN%12-50	●	●	50	40	37	60	300	25	10			LL-2N	LS-2N	PC-2	LSP-2	-	LC-42N%L	LW-3	-	-	-	-	-	-	-

LC-42NR for Right-hand Toolholder, LC-42NL for Left-hand Toolholder.

A-PCLN (Boring / Internal facing)

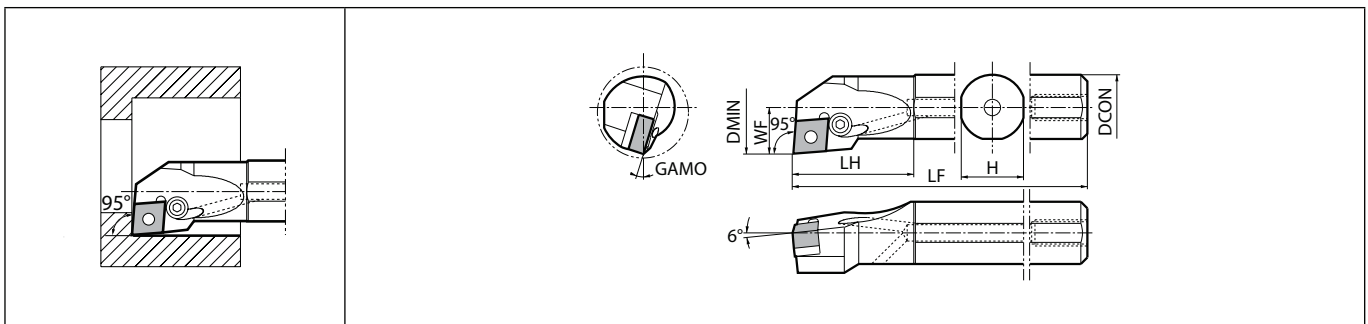















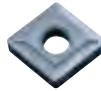



Max. Overhang Length L/D≈3 | Right-hand shown | Left-hand Insert for Right-hand Toolholder.

Toolholder dimensions

Description	Availability		Dimension (mm)							GAMO (°)	Standard corner-R(RE)	Coolant hole	Spare parts							Applicable inserts					
	R	L	DMIN	DCON	H	LH	LF	WF	Lever				Lock screw	Punch	Shim pin	Shim pin	Shim	Wrench							
A16M- PCLNR09-20	●		20	16	15	34	150	11	16	0.8	Yes	LL-03SN	LS-03SN	-	-	P-03S	-	-	-	-	-	-	-	-	
A20Q- PCLNR09-27	●		27	20	19	37	180	14.2	17			LL-1N	LS-1SN	PC-1	LSP-1	-	LC-32N	-	-	-	-	-	-	-	CN□G0904...
A25R- PCLNR09-32	●		32	25	24	42	200	15.7	15			LL-2N	LS-2N	PC-2	LSP-2	-	LC-42N%L	LW-3	-	-	-	-	-	-	-

● : Standard item R : Right-hand only L : Left-hand only □ : Check availability

Applicable inserts (A-DCLN / S-PCLN / A-PCLN)

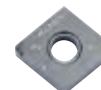
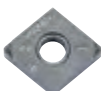
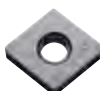
Applications	Finishing	Finishing	Finishing - Medium	Finishing - Medium	Finishing	Finishing	Finishing - Medium	Finishing - Medium
Insert								
Chip Breaker Type	WF	WP	WE	WQ	PP	GP	PQ	HQ
Page	B16	B16	B16	B16	B16	B16	B16	B17
Applications	Finishing - Medium	Finishing - Medium	Medium	Medium - Roughing	Medium - Roughing	Medium - Roughing	Medium - Roughing	Medium - Roughing
Insert								
Chip Breaker Type	CQ	CJ	TN-V	GS	PG	PS	PT	GT
Page	B17	B17	B17	B17	B17	B18	B18	B18
Applications	Roughing	Roughing	Roughing	Finishing	Medium	Medium - Roughing	Medium - Roughing	Low carbon steel
Insert								
Chip Breaker Type	STD	PH	PX	P/L-S	R/L	P/L-25R	Z	XF
Page	B18	B18	B19	B23	B23	B23	B23	B19
Applications	Low carbon steel	Low carbon steel	Low carbon steel	Finishing - Medium	Medium - Roughing	Stainless steel / Heat-resistant alloys	Stainless steel / Heat-resistant alloys	Stainless steel / Heat-resistant alloys
Insert								
Chip Breaker Type	XP	XQ	XS	SK	FP-TK	TK	MQ	MS
Page	B19	B19	B19	B19	B19	B20	B20	B20
Applications	Stainless steel / Heat-resistant alloys	Cast iron	Cast iron	Cast iron	Cast iron	Cast iron	Cast iron	Cast iron
Insert								
Chip Breaker Type	MU	KQ	KG	KH	C	ZS	GC	No CB
Page	B20	B21	B21	B21	B22	B22	B22	B22
Applications	Cast iron / Hard materials	Non-Ferrous Metals	Non-Ferrous Metals	Non-Ferrous Metals	Heat-resistant alloys	Heat-resistant alloys	Hard materials	Hard materials
Insert								
Chip Breaker Type	Ceramic	P/L-A3	AH	PCD	SQ	SG	HH	HL
Page	B113	B23	B23	C34	B20	B21	C9	C9
Applications	Hard materials	Hard materials / Cast iron						
Insert								
Chip Breaker Type	HD	CBN						
Page	C9	C8						



Recommended cutting conditions  F152, F153

Applicable Coolant Sleeve / Joint

Toolholder Description	Applicable Coolant Sleeve	Applicable Coolant Joint
A16M -PCLN ^{P/L} 09-20	SHC1640-70, SHC1650-95	SJS-8
A20Q -PCLN ^{P/L} 09-27	SHC2040-70, SHC2050-95	
A25R -PCLN ^{P/L} 09-32	SHC2540-70, SHC2550-95	

For Coolant Sleeve, Coolant Joint See Page  F150, F151

S-PDUN11 (Boring / Internal facing)

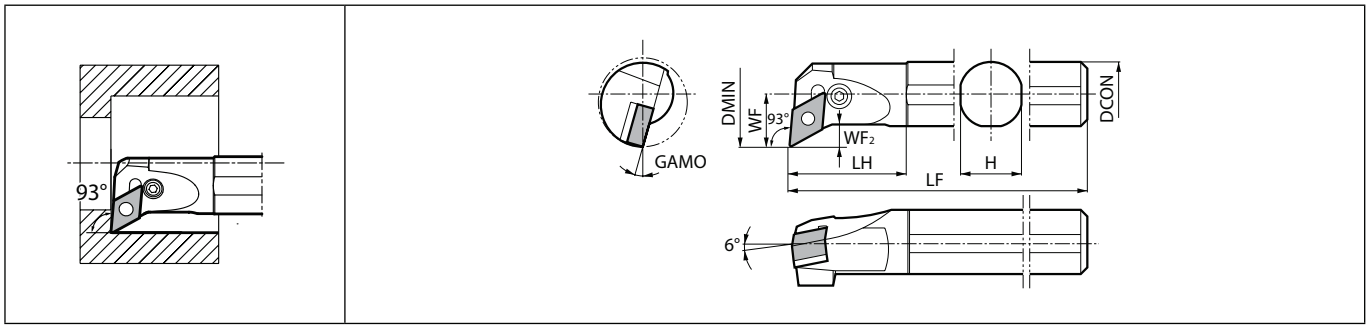

Max. Overhang Length $L/D \approx 3$ | Right-hand shown
Left-hand Insert for Right-hand Toolholder, Right-hand Insert for Left-hand Toolholder.

F

Toolholder dimensions

Description	Availability		Dimension (mm)							GAMO (°)	Standard corner-R(RE)	Coolant hole	Spare parts						Applicable inserts
	R	L	DMIN	DCON	H	LH	LF	WF	WF ₂				Lever	Lock screw	Punch	Shim pin	Shim	Wrench	
	S20Q- PDUN%11-27	●	●	27	20	19	35	180	16				7.6	17	0.4	No	LL-1DN	LS-1SN	
S25R- PDUN%11-32	●	●	32	25	24	40	200	17	7.6	15	0.4	No	LL-1DN	LS-1SN	PC-1	LSP-1	LD-32N	FH-2.5	DN□G1104...
S32S- PDUN%11-40	●	●	40	32	31	45	250	22	8.5	12	0.4	No	LL-1DN	LS-1SN	PC-1	LSP-1	LD-32N	FH-2.5	DN□G1104...

A-PDUN11 (Boring / Internal facing)

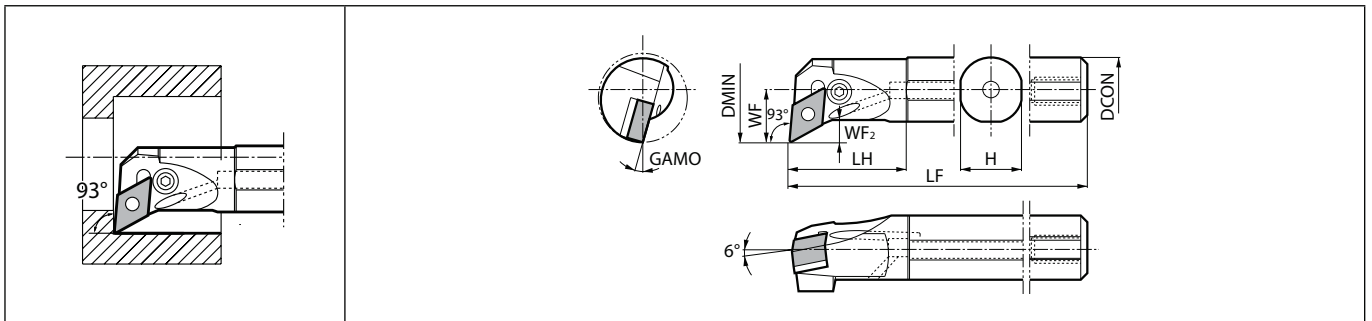





Max. Overhang Length $L/D \approx 3$ | Right-hand shown | Left-hand Insert for Right-hand Toolholder.

Toolholder dimensions

Description	Availability		Dimension (mm)							GAMO (°)	Standard corner-R(RE)	Coolant hole	Spare parts						Applicable inserts
	R	L	DMIN	DCON	H	LH	LF	WF	WF ₂				Lever	Lock screw	Punch	Shim pin	Shim	Wrench	
	A20Q- PDUNR11-27	●		27	20	19	35	180	16				7.6	17	0.4	Yes	LL-1DN	LS-1SN	
A25R- PDUNR11-32	●		32	25	24	40	200	17	7.6	15	0.4	Yes	LL-1DN	LS-1SN	PC-1	LSP-1	LD-32N	FH-2.5	DN□G1104...
A32S- PDUNR11-40	●		40	32	31	45	250	22	8.5	12	0.4	Yes	LL-1DN	LS-1SN	PC-1	LSP-1	LD-32N	FH-2.5	DN□G1104...

● : Standard item R : Right-hand only L : Left-hand only □ : Check availability

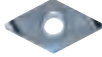
Applicable inserts (S-PDUN / A-PDUN)

Applications	Finishing	Finishing - Medium	Medium - Roughing	Finishing	Medium
Insert					
Chip Breaker Type	GP	HQ	GS	R/L-S	R/L
Page	B24	B25	B25	B31	B31

Recommended cutting conditions [F152](#), [F153](#)

Applicable Coolant Sleeve / Joint

Toolholder Description	Applicable Coolant Sleeve	Applicable Coolant Joint
A20Q-PDUNR11-27	SHC2040-70, SHC2050-95	SJS-8
A25R-PDUNR11-32	SHC2540-70, SHC2550-95	
A32S-PDUNR11-40	-	

For Coolant Sleeve, Coolant Joint See Page [F150](#), [F151](#)



A-DDUN (Boring / Internal copying)

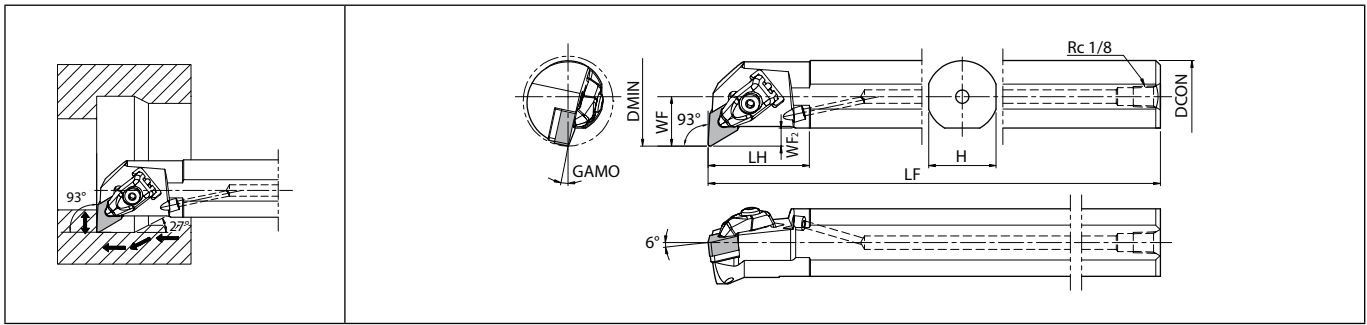

Max. Overhang Length L/D≈3 | Right-hand shown
Left-hand Insert for Right-hand Toolholder, Right-hand Insert for Left-hand Toolholder.

F

Toolholder dimensions

Description	Availability		Dimension (mm)								GAMO (°)	Standard corner-R(RE)	Coolant hole	Spare parts							Applicable inserts
	R	L	DMIN	DCON	H	LH	LF	WF	WF2	Clamp				Screw (for clamp)	Spring	Wrench (for clamp)	Shim	Screw (for shim)	Wrench* (for shim)	Nozzle	
A32S- DDUN%L15-40	●	●	40	32	30	45	250	22	8	12	0.8	Yes	CP-3D	CS-3D	SP-3D	LW-3	DD-42 (DD-42-16*)	SB-4085TR	FT-15	DN10	DN□A1504... DN□G1504... DN□M1504... DN□X1504...
A40T- DDUN%L15-50	●	●	50	40	37	55	300	27	8.5											DN20	
A50U- DDUN%L15-63	●	●	63	50	47	65	350	35	10.5											DN20	

When using inserts whose corner-R(RE) is greater than 1.6 mm, please purchase a shim* and use it in order to prevent workpiece and shim from interfering each other.

Not applicable to high-pressure coolant

When using the insert with WF chipbreaker, tool edge offset or program corrections are required on R34 and R35.

Wrench (FT-15) is sold separately.

● : Standard item R : Right-hand only L : Left-hand only □ : Check availability

Applicable inserts

Applications	Finishing	Finishing	Finishing	Finishing - Medium	Finishing - Medium	Finishing - Medium	Finishing - Medium	Medium
Insert								
Chip Breaker Type	WF	PP	GP	PQ	HQ	CQ	CJ	TN-V
Page	B24	B24	B24	B24	B25	B25	B25	B25
Applications	Medium - Roughing	Medium - Roughing	Medium - Roughing	Medium - Roughing	Medium - Roughing	Roughing	Roughing	Roughing
Insert								
Chip Breaker Type	GS	PG	PS	PT	GT	STD	PH	PX
Page	B25	B26	B26	B26	B26	B27	B27	B27
Applications	Medium	Low carbon steel	Low carbon steel	Low carbon steel	Low carbon steel	Finishing - Medium	Large ap	Medium - Roughing
Insert								
Chip Breaker Type	R/L	XF	XP	XQ	XS	SK	R-LD	FP-TK
Page	B31	B27	B27	B27	B27	B28	B28	B28
Applications	Stainless steel / Heat-resistant alloys	Stainless steel / Heat-resistant alloys	Stainless steel / Heat-resistant alloys	Stainless steel / Heat-resistant alloys	Cast iron	Cast iron	Cast iron	Cast iron
Insert								
Chip Breaker Type	TK	MQ	MS	MU	KQ	KG	KH	C
Page	B28	B28	B29	B29	B30	B30	B30	B30
Applications	Cast iron	Cast iron	Cast iron	Cast iron / Hard materials	Non-Ferrous Metals	Non-Ferrous Metals	Non-Ferrous Metals	Heat-resistant alloys
Insert								
Chip Breaker Type	ZS	GC	No CB	Ceramic	A3	AH	PCD	SQ
Page	B30	B30	B31	B114	B31	B31	C35	B29
Applications	Heat-resistant alloys	Hard materials	Hard materials	Hard materials	Hard materials / Cast iron			
Insert								
Chip Breaker Type	SG	HH	HL	HD	CBN			
Page	B29	C11	C11	C11	C10			

Recommended cutting conditions  F152, F153



S-PDUN15 (Internal copying)

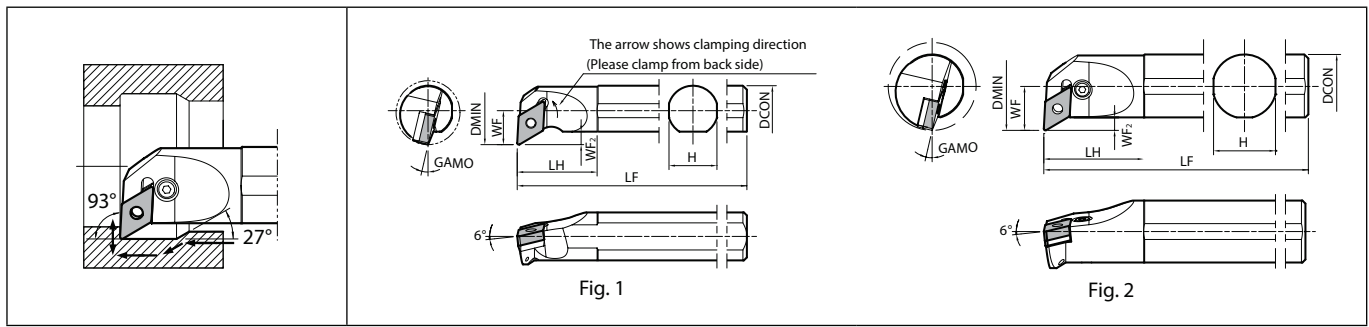

Max. Overhang Length L/D≈3 | Right-hand shown
Left-hand Insert for Right-hand Toolholder, Right-hand Insert for Left-hand Toolholder.

F

Toolholder dimensions

Description	Availability		Dimension (mm)							GAMO (°)	Standard corner-R(RE)	Coolant hole	Fig.	Applicable inserts
	R	L	DMIN	DCON	H	LH	LF	WF	WF ₂					
S25R- PDUN% 15-32	●	●	32	25	24	40	200	17	6.5	13	0.8	No	1	DN□A1504..., DN□G1504... DN□M1504..., DN□X1504...
S32S- PDUN% 15-44	●	●	44	32	31	50	250	22					2	
S40T- PDUN% 15-54	●	●	54	40	39	65	300	27	7.5	12				

Description	Spare parts									
	Lever	Lock pin	Lock screw	Wrench	Shim	Shim	Screw	Wrench	Shim pin	Punch
	S25R- PDUN% 15-32	-	PP-4	-	LW-3	-	PD-42	SB-2050TR	FT-6	-
S32S- PDUN% 15-44	-	-	-	LD-42 (LD-42-20*)		-	-	-	LSP-2	PC-2
S40T- PDUN% 15-54	LL-3N	-	LS-2N	-		-	-	-	-	-

When using the insert with WF chipbreaker, tool edge offset or program corrections are required on R34 and R35.
 When using inserts whose corner-R(RE) is greater than 1.6 mm for S25R-PDUN% 15-32, use shim modified by additional processing in order to prevent workpiece and shim from interfering each other.
 When using inserts whose corner-R(RE) is greater than 1.6 mm for S32S-PDUN% 15-44 and S40T-PDUN% 15-54, please purchase a shim with* mark and use it in order to prevent workpiece and shim from interfering each other.

● : Standard item R : Right-hand only L : Left-hand only □ : Check availability

S-PDQN15 (Internal copying)

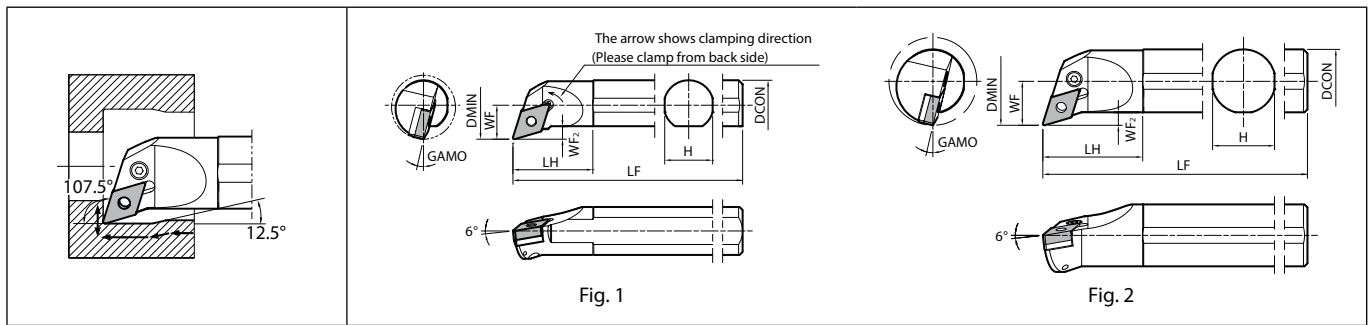

Max. Overhang Length L/D≈3 | Right-hand shown
Left-hand Insert for Right-hand Toolholder, Right-hand Insert for Left-hand Toolholder.

Toolholder dimensions

Description	Availability		Dimension (mm)							GAMO (°)	Standard corner-R(RE)	Coolant hole	Fig.	Applicable inserts
	R	L	DMIN	DCON	H	LH	LF	WF	WF ₂					
S25R- PDQN [®] /15-32	●	●	32	25	24	40	200	17	6.5	13	0.8	No	1	DN□A1504... DN□G1504... DN□M1504...
S32S- PDQN [®] /15-44	●	●	44	32	31	50	250	22					2	
S40T- PDQN [®] /15-54	●	●	54	40	39	65	300	27	7.5	12				

Description	Spare parts									
	Lever	Lock pin	Lock screw	Wrench	Shim	Shim	Screw	Wrench	Shim pin	Punch
	S25R- PDQN [®] /15-32	-	PP-4	-	LW-3	-	PD-42	SB-2050TR	FT-6	-
S32S- PDQN [®] /15-44	LL-3N	-	LS-2N	LD-42 (LD-42-20*)		-	-	-	LSP-2	PC-2
S40T- PDQN [®] /15-54										

When using inserts whose corner-R(RE) is greater than 1.6 mm for S25R-PDQN[®]/15-32, use shim modified by additional processing in order to prevent workpiece and shim from interfering each other.
When using inserts whose corner-R(RE) is greater than 1.6 mm for S32S-PDQN[®]/15-44 and S40T-PDQN[®]/15-54, please purchase a shim with* mark and use it in order to prevent workpiece and shim from interfering each other.
WF chipbreaker can not be used for S-PDQN15 toolholder.

● : Standard item R : Right-hand only L : Left-hand only □ : Check availability



S-PDZN15 (Back boring)

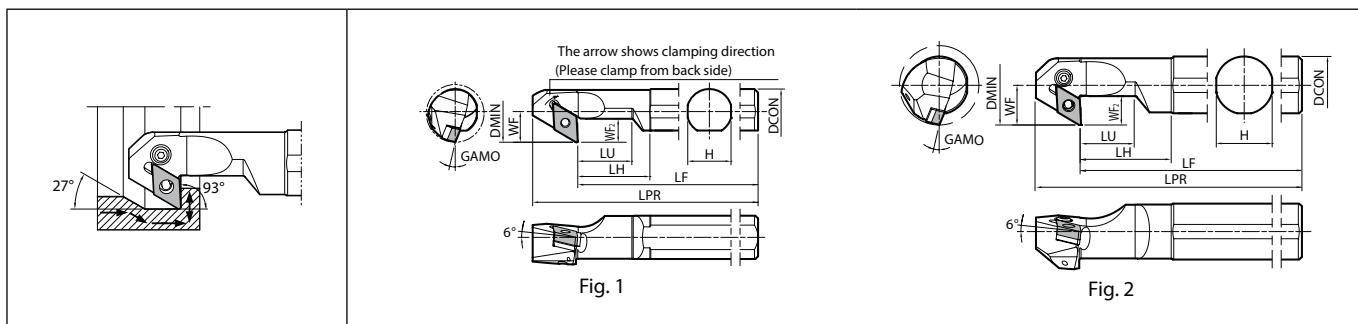

Max. Overhang Length L/D≈3 | Right-hand shown
Right-hand Insert for Right-hand Toolholder, Left-hand Insert for Left-hand Toolholder.

F

Toolholder dimensions

Description	Availability		Dimension (mm)								GAMO (°)	Standard corner-R(RE)	Coolant hole	Fig.	Applicable inserts
	R	L	DMIN	DCON	H	LH	LPR	LU	WF	WF ₂					
S25R- PDZN% 15-32	●	●	32	25	24	40	225	17	13	13	0.8	No	1	DN□A1504..., DN□G1504...	
S32S- PDZN% 15-44	●	●	44	32	31	50	275	30	22	16	0.8	No	2	DN□M1504..., DN□X1504...	
S40T- PDZN% 15-54	●	●	54	40	39	65	325	50	27	12	0.8	No	2	DN□M1504..., DN□X1504...	

Description	Spare parts									
	Lever	Lock pin	Lock screw	Wrench	Shim	Shim	Screw	Wrench	Shim pin	Punch
S25R- PDZN% 15-32	-	PP-4	-	-	-	PD-42	SB-2050TR	FT-6	-	-
S32S- PDZN% 15-44	-	-	-	LW-3	LD-42	-	-	-	LSP-2	PC-2
S40T- PDZN% 15-54	LL-3N	-	LS-2N	LW-3	LD-42 (LD-42-20*)	-	-	-	LSP-2	PC-2

When using the insert with WF chipbreaker, tool edge offset or program corrections are required on **R34** and **R35**.

When using inserts whose corner-R(RE) is greater than 1.6 mm for S25R-PDZN% 15-32, use shim modified by additional processing in order to prevent workpiece and shim from interfering each other.

When using inserts whose corner-R(RE) is greater than 1.6 mm for S32S-PDZN% 15-44 and S40T-PDZN% 15-54, please purchase a shim with* mark and use it in order to prevent workpiece and shim from interfering each other.

How to change S25R-PD□N% 15-32 inserts

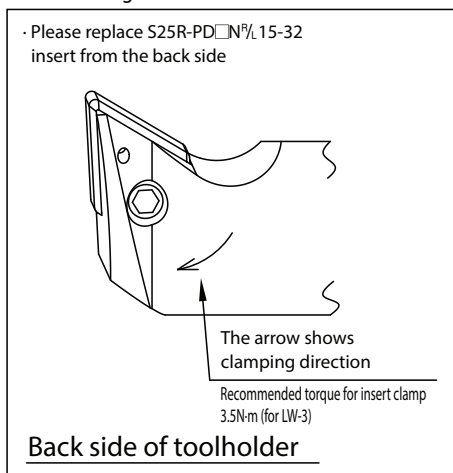

How to assemble spare parts

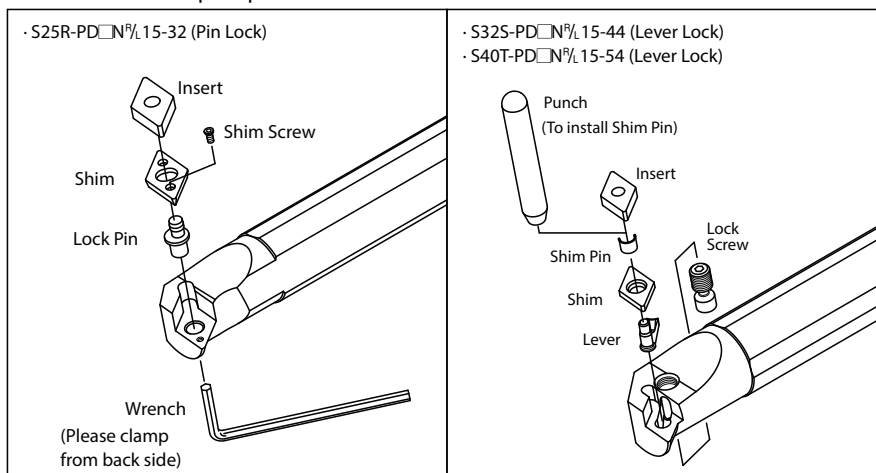

● : Standard item R : Right-hand only L : Left-hand only □ : Check availability

Applicable inserts (S-PDUN15 / S-PDQN15 / S-PDZN15)

Applications	Finishing	Finishing	Finishing	Finishing - Medium	Finishing - Medium	Finishing - Medium	Finishing - Medium	Medium
Insert								
Chip Breaker Type	WF*	PP	GP	PQ	HQ	CQ	CJ	TN-V
Page	B24	B24	B24	B24	B25	B25	B25	B25
Applications	Medium - Roughing	Medium - Roughing	Medium - Roughing	Medium - Roughing	Medium - Roughing	Roughing	Roughing	Roughing
Insert								
Chip Breaker Type	GS	PG	PS	PT	GT	STD	PH	PX
Page	B25	B26	B26	B26	B26	B27	B27	B27
Applications	Medium	Low carbon steel	Low carbon steel	Low carbon steel	Low carbon steel	Finishing - Medium	Large ap	Medium - Roughing
Insert								
Chip Breaker Type	R/L	XF	XP	XQ	XS	SK	R-LD	FP-TK
Page	B31	B27	B27	B27	B27	B28	B28	B28
Applications	Stainless steel / Heat-resistant alloys	Stainless steel / Heat-resistant alloys	Stainless steel / Heat-resistant alloys	Stainless steel / Heat-resistant alloys	Cast iron	Cast iron	Cast iron	Cast iron
Insert								
Chip Breaker Type	TK	MQ	MS	MU	KQ	KG	KH	C
Page	B28	B28	B29	B29	B30	B30	B30	B30
Applications	Cast iron	Cast iron	Cast iron	Cast iron / Hard materials	Non-Ferrous Metals	Non-Ferrous Metals	Non-Ferrous Metals	Heat-resistant alloys
Insert								
Chip Breaker Type	ZS	GC	No CB	Ceramic	¾-A3	AH	PCD	SQ
Page	B30	B30	B31	B114	B31	B31	C35	B29
Applications	Heat-resistant alloys	Hard materials	Hard materials	Hard materials	Hard materials / Cast iron			
Insert								
Chip Breaker Type	SG	HH	HL	HD	CBN			
Page	B29	C11	C11	C11	C10			

Recommended cutting conditions  F152, F153

When using the insert with WF chipbreaker, tool edge offset or program corrections are required on R34 and R35.
The insert with WF chipbreaker is not applicable for S-PDQN15 type toolholder.



A-DSKN (Boring)

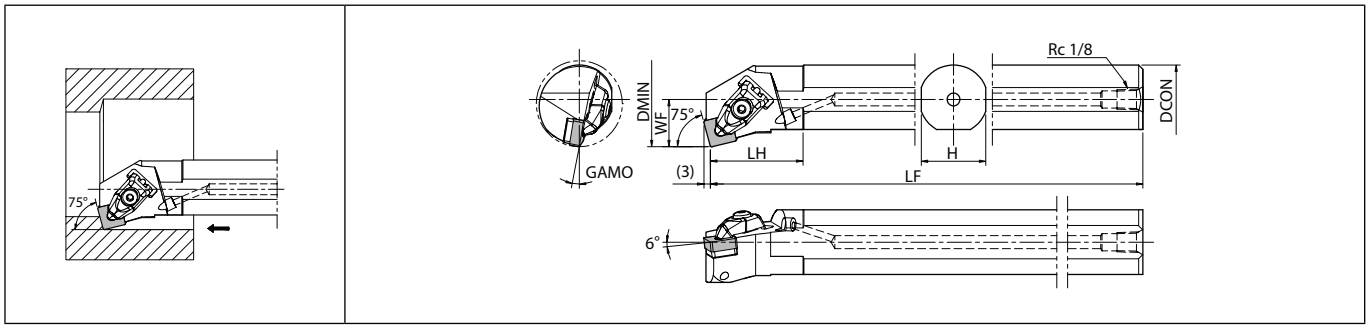

Max. Overhang Length L/D≈3 | Right-hand shown
Left-hand Insert for Right-hand Toolholder, Right-hand Insert for Left-hand Toolholder.

F

Toolholder dimensions

Description	Availability		Dimension (mm)							GAMO (°)	Standard corner-R(RE)	Coolant hole	Spare parts							Applicable inserts
			R	L	DMIN	DCON	H	LH	LF				WF	Clamp	Screw (for clamp)	Spring	Wrench (for clamp)	Shim	Screw (for shim)	
	A25R- DSKN [®] L 12-32	●	●	32	25	23	43	200	17				11	0.8	Yes	CP-3D	CS-3D	SP-3D	LW-3	
A32S- DSKN [®] L 12-40	●	●	40	32	30		250	22												
A40T- DSKN [®] L 12-50	●	●	50	40	37	53	300	27												

Not applicable to high-pressure coolant
Wrench (FT-15) is sold separately.

Applicable inserts

Applications	Finishing - Medium	Finishing - Medium	Medium - Roughing	Medium - Roughing	Medium - Roughing	Roughing	Roughing	Roughing
Insert								
Chip Breaker Type	PQ	HQ	PG	PS	PT	STD	PH	PX
Page	B34	B34	B34	B34	B34	B34	B35	B35
Applications	Medium - Roughing	Medium - Roughing	Low carbon steel	Low carbon steel	Low carbon steel	Stainless steel / Heat-resistant alloys	Stainless steel / Heat-resistant alloys	Cast iron
Insert								
Chip Breaker Type	P/L-C	P/L-25R	XP	XQ	XS	MQ	MS	KG
Page	B37	B37	B35	B35	B35	B36	B36	B36
Applications	Cast iron	Cast iron	Cast iron	Cast iron	Cast iron	Cast iron / Hard materials	Heat-resistant alloys	Hard materials / Cast iron
Insert								
Chip Breaker Type	KH	C	ZS	GC	No CB	Ceramic	SG	CBN
Page	B36	B36	B37	B37	B37	B117	B36	C12

Recommended cutting conditions → F152, F153

● : Standard item R : Right-hand only L : Left-hand only □ : Check availability

A-DTFN (Boring)

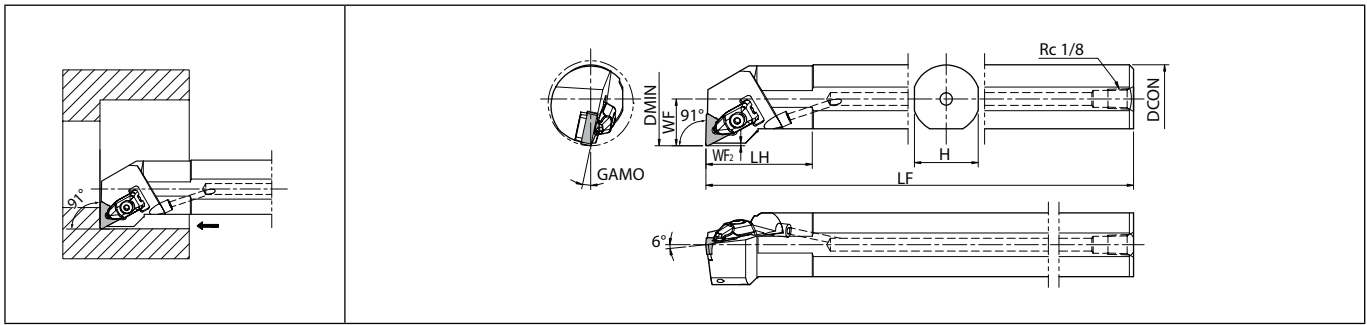

Max. Overhang Length L/D≈3 | Right-hand shown
Left-hand Insert for Right-hand Toolholder, Right-hand Insert for Left-hand Toolholder.

Toolholder dimensions

Description	Availability		Dimension (mm)							GAMO (°)	Standard corner-R(RE)	Coolant hole	Applicable inserts
	R	L	DMIN	DCON	H	LH	LF	WF	WF ₂				
A25R- DTFN%L16-32	●	●	32	25	23	42	200	17	0.8	12	0.8	Yes	TN□A1604..., TN□G1604...
A32S- DTFN%L16-40	●	●	40	32	30	50	250	22	1.2				TN□M1604..., TN□X1604...
A40T- DTFN%L22-50	●	●	50	40	37	60	300	27	1.5	12	0.8	Yes	TN□G2204..., TN□M2204...

Description	Spare parts								
	Clamp	Screw (for clamp)	Spring	Wrench (for clamp)	Shim	Screw (for shim)	Wrench* (for shim)	Wrench* (for shim)	Nozzle
A25R- DTFN%L16-32									
A32S- DTFN%L16-40	CP-2D	CS-2D	SP-2D	LW-2.5	DT-32	SB-3080TR	FT-10	-	DN10
A40T- DTFN%L22-50	CP-3D	CS-3D	SP-3D	LW-3	DT-42	SB-4085TR	-	FT-15	DN20

Not applicable to high-pressure coolant

When using the insert with WF chipbreaker, tool edge offset or program corrections are required on R34 and R35.

Wrench (FT-10 or FT-15) is sold separately

● : Standard item R : Right-hand only L : Left-hand only □ : Check availability



S-PTUN (Boring)

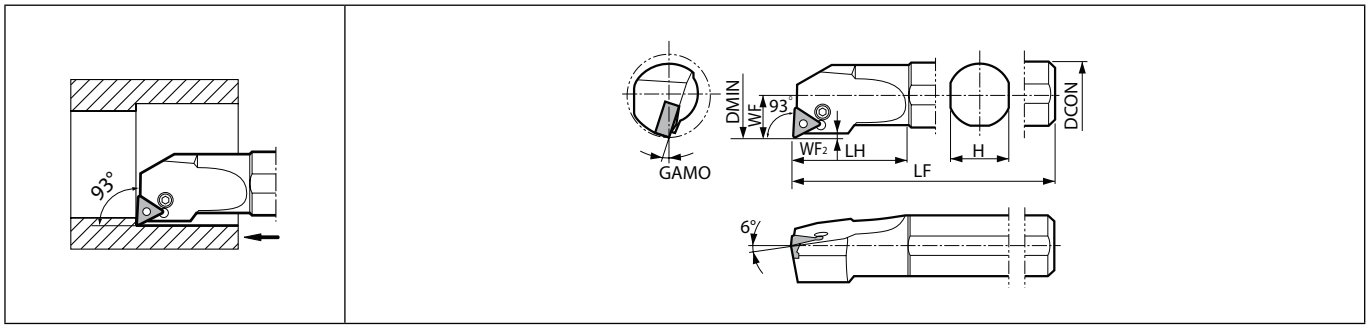

Max. Overhang Length L/D≈3 | Right-hand shown
Left-hand Insert for Right-hand Toolholder, Right-hand Insert for Left-hand Toolholder.

F

Toolholder dimensions

Description	Availability		Dimension (mm)								GAMO (°)	Standard corner-R(RE)	Coolant hole	Spare parts						Applicable inserts
	R	L	DMIN	DCON	H	LH	LF	WF	WF2	Lever				Lock screw	Punch	Shim	Shim pin	Shim pin	Wrench	
	S16M- PTUN%11-20	●	●	20	16	15	34	150	11	0.3				18	0.8	No	LL-03TN	LS-03SN	-	
S20Q- PTUN%11-25	●	●	25	20	19	37	180	13.2	0.2	17										
S25R- PTUN%11-32	●	●	32	25	24	42	200	15.7	0.3	16	0.8	No	LL-03SN	LS-03SN	-	-	-	P-03S	FH-2.5	TN□A1604... TN□G1604... TN□M1604...
S16M- PTUN%16-20	●	●	20	16	15	34	150	11	18											
S20Q- PTUN%16-25	●	●	25	20	19	37	180	13.2	1.3	17										
S25R- PTUN%16-30	●	●	30	25	24	42	200	15.5	13											
S32S- PTUN%16-40	●	●	40	32	30	50	250	22	0.7											
S40T- PTUN%16-50	●	●	50	40	37	60	300	27	0.6	11	LL-1N	LS-1N	PC-1	LT-32N (LT-32N-20*)	LSP-1	-	FH-2.5	TN□A1604... TN□G1604... TN□M1604...		

When using inserts whose corner-R(RE) is greater than 1.6 mm, please purchase a shim* and use it in order to prevent workpiece and shim from interfering each other.

A-PTUN (Boring)

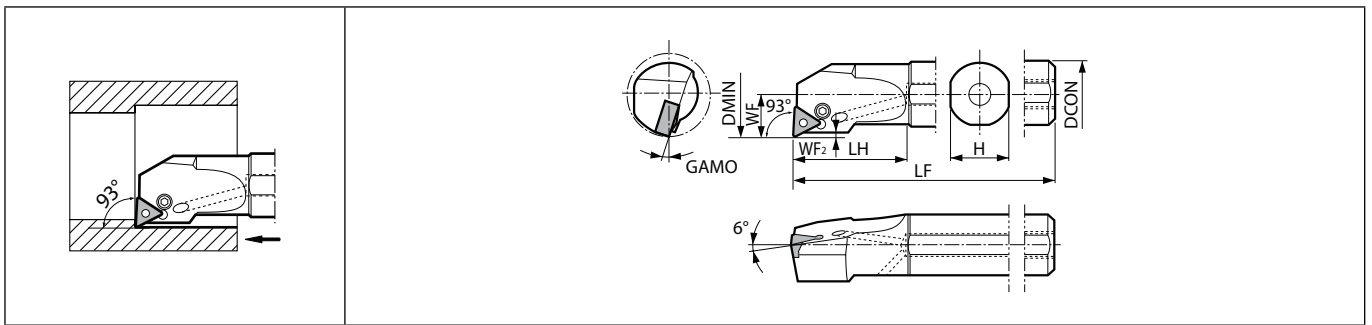

Max. Overhang Length L/D≈3 | Right-hand shown
Left-hand Insert for Right-hand Toolholder.

Toolholder dimensions

Description	Availability		Dimension (mm)								GAMO (°)	Standard corner-R(RE)	Coolant hole	Spare parts				Applicable inserts
	R	L	DMIN	DCON	H	LH	LF	WF	WF2	Lever				Lock screw	Shim pin	Wrench		
	A16M- PTUNR11-20	●		20	16	15	34	150	11	0.3				18	0.8	Yes	LL-03TN	
A20Q- PTUNR11-25	●		25	20	19	37	180	13.2	0.2	17								
A25R- PTUNR11-32	●		32	25	24	42	200	15.7	0.3	16								

● : Standard item R : Right-hand only L : Left-hand only □ : Check availability

Applicable inserts (A-DTFN / S-PTUN / A-PTUN)

Applications	Finishing	Finishing	Finishing	Finishing - Medium	Finishing - Medium	Finishing - Medium	Medium - Roughing	Medium - Roughing
Insert								
Chipbreaker type	WF*	PP	GP	PQ	HQ	CQ	GS	PG
Page	B39	B39	B39	B39	B39	B39	B40	B40
Applications	Medium - Roughing	Medium - Roughing	Medium - Roughing	Roughing	Roughing	Roughing	Finishing	Finishing
Insert								
Chipbreaker type	PS	PT	GT	STD	PH	PX	1/2-SSF	1/2-S
Page	B40	B40	B40	B40	B41	B41	B45	B45
Applications	Finishing - Medium	Medium - Roughing	Medium - Roughing	Medium - Roughing	Low carbon steel	Low carbon steel	Low carbon steel	Low carbon steel
Insert								
Chipbreaker type	1/2-B	1/2-C	R/L	1/2-25R	XF	XP	XQ	XS
Page	B45	B46	B46	B46	B41	B41	B41	B41
Applications	Finishing - Medium	Large ap	Medium - Roughing	Stainless steel / Heat-resistant alloys	Stainless steel / Heat-resistant alloys	Stainless steel / Heat-resistant alloys	Stainless steel / Heat-resistant alloys	Stainless steel
Insert								
Chipbreaker type	SK	R-LD	FP-TK	TK	MQ	MS	MU	1/2-ST
Page	B42	B42	B42	B42	B42	B42	B42	B43
Applications	Cast iron	Cast iron	Cast iron	Cast iron	Cast iron	Cast iron	Cast iron	Cast iron / Hard materials
Insert								
Chipbreaker type	KQ	KG	KH	C	ZS	GC	No CB	Ceramic
Page	B43	B43	B43	B43	B43	B43	B44	B118
Applications	Non-Ferrous Metals	Non-Ferrous Metals	Non-Ferrous Metals	Heat-resistant alloys	Hard materials / Cast iron			
Insert								
Chipbreaker type	1/2-A3	AH	PCD	SG	CBN			
Page	B44	B44	C36	B43	C13			

When using the insert with WF chipbreaker, tool edge offset or program corrections are required on R34 and R35. The insert with WF chipbreaker is not applicable for S-PTUN type and A-PTUN type toolholder.

Recommended cutting conditions [F152](#), [F153](#)

Applicable Coolant Sleeve / Joint

Toolholder Description	Applicable Coolant Sleeve	Applicable Coolant Joint
A16M-PTUN ^{1/2} 11-20	SHC1640-70, SHC1650-95	SJS-8
A20Q-PTUN ^{1/2} 11-25	SHC2040-70, SHC2050-95	
A25R-PTUN ^{1/2} 11-32	SHC2540-70, SHC2550-95	

For Coolant Sleeve, Coolant Joint See Page [F150](#), [F151](#)



S-PWLN (Boring / Internal facing)

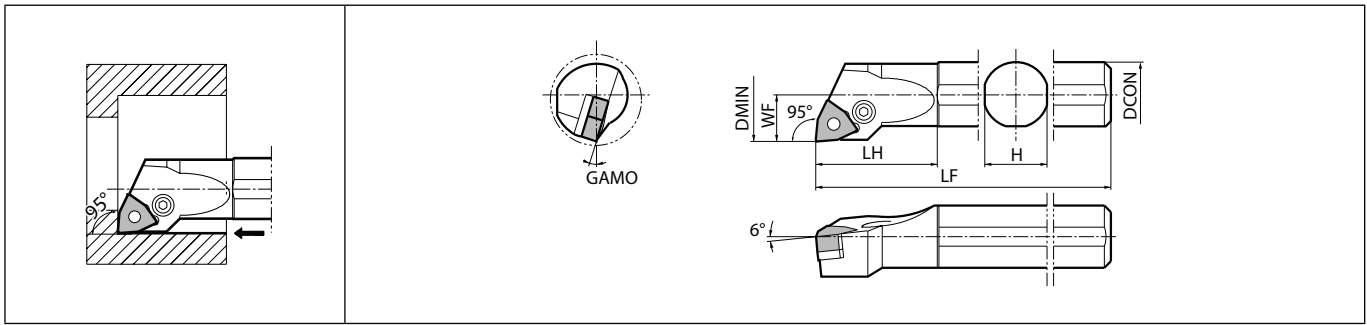

Max. Overhang Length $L/D \approx 3$ | Right-hand shown
Left-hand Insert for Right-hand Toolholder, Right-hand Insert for Left-hand Toolholder.

F

Toolholder dimensions

Description	Availability		Dimension (mm)							GAMO (°)	Standard corner-R(RE)	Coolant hole	Spare parts							Applicable inserts	
	R	L	DMIN	DCON	H	LH	LF	WF	Lever				Lock screw	Punch	Shim	Shim pin	Shim pin	Wrench	Wrench		
S16M- PWLN%06-20	●	●	20	16	15	34	150	11	16	0.8	No	LL-03SN	LS-03SN	-	-	-	P-03S	-	FH-2.5	WN□G0604...	
S20Q- PWLN%06-27	●	●	27	20	19	37	180	14.2	17			LL-1N	LS-1SN	PC-1	LW-32N	LSP-1	-				-
S25R- PWLN%06-32	●	●	32	25	24	42	200	15.7	15	10	0.8	No	LL-2N	LS-2N	PC-2	LW-42N%	LSP-2	-	LW-3	-	WN□A0804... WN□G0804... WN□M0804...
S32S- PWLN%08-40	●	●	40	32	30	50	250	22													
S40T- PWLN%08-50	●	●	50	40	37	60	300	27													

Shim : LW-42NR for Right-hand Toolholder, LW-42NL for Left-hand Toolholder.

A-PWLN (Boring / Internal facing)

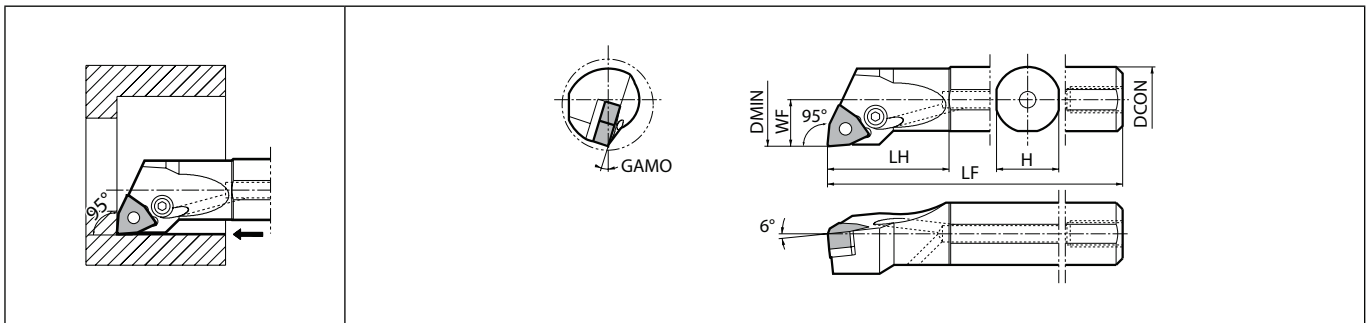





































Max. Overhang Length $L/D \approx 3$ | Right-hand shown
Left-hand Insert for Right-hand Toolholder.

Toolholder dimensions

Description	Availability		Dimension (mm)							GAMO (°)	Standard corner-R(RE)	Coolant hole	Spare parts							Applicable inserts	
	R	L	DMIN	DCON	H	LH	LF	WF	Lever				Lock screw	Punch	Shim	Shim pin	Shim pin	Wrench	Wrench		
A16M- PWLNRO6-20	●		20	16	15	34	150	11	16	0.8	Yes	LL-03SN	LS-03SN	-	-	-	P-03S	FH-2.5	WN□G0604...		
A20Q- PWLNRO6-27	●		27	20	19	37	180	14.2	17			LL-1N	LS-1SN	PC-1	LW-32N	LSP-1	-			-	-
A25R- PWLNRO6-32	●		32	25	24	42	200	15.7	15												

● : Standard item R : Right-hand only L : Left-hand only □ : Check availability

Applicable inserts (S-PWLN / A-PWLN)

Applications	Finishing	Finishing	Finishing - Medium	Finishing - Medium	Finishing	Finishing	Finishing - Medium	Finishing - Medium
Insert								
Chip Breaker Type	WF	WP	WE	WQ	PP	GP	PQ	HQ
Page	B50	B50	B50	B50	B50	B50	B50	B51
Applications	Finishing - Medium	Finishing - Medium	Medium - Roughing	Medium - Roughing	Medium - Roughing	Medium - Roughing	Medium - Roughing	Roughing
Insert								
Chip Breaker Type	CQ	CJ	GS	PG	PS	PT	GT	STD
Page	B51	B51	B51	B51	B51	B51	B52	B52
Applications	Roughing	Finishing	Medium	Low carbon steel	Low carbon steel	Low carbon steel	Stainless steel / Heat-resistant alloys	Stainless steel / Heat-resistant alloys
Insert								
Chip Breaker Type	PH	PH-S	R/L	XP	XQ	XS	TK	MQ
Page	B52	B54	B54	B52	B52	B52	B52	B53
Applications	Stainless steel / Heat-resistant alloys	Stainless steel / Heat-resistant alloys	Cast iron	Cast iron	Cast iron	Cast iron	Cast iron	Cast iron
Insert								
Chip Breaker Type	MS	MU	KQ	KG	KH	C	ZS	GC
Page	B53	B53	B53	B53	B53	B54	B54	B54
Applications	Cast iron	Non-Ferrous Metals	Non-Ferrous Metals	Heat-resistant alloys	Hard materials / Cast iron			
Insert								
Chip Breaker Type	No CB	AH	PCD	SG	CBN			
Page	B54	B54	C38	B53	C15			

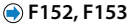
Recommended cutting conditions 

Applicable Coolant Sleeve / Joint

Toolholder Description	Applicable Coolant Sleeve	Applicable Coolant Joint
A16M-PWLNRO6-20	SHC1640-70, SHC1650-95	SJS-8
A20M-PWLNRO6-27	SHC2040-70, SHC2050-95	
A25R-PWLNRO6-32	SHC2540-70, SHC2550-95	

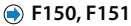
For Coolant Sleeve, Coolant Joint See Page 



A-DWLN (Boring / Internal facing)

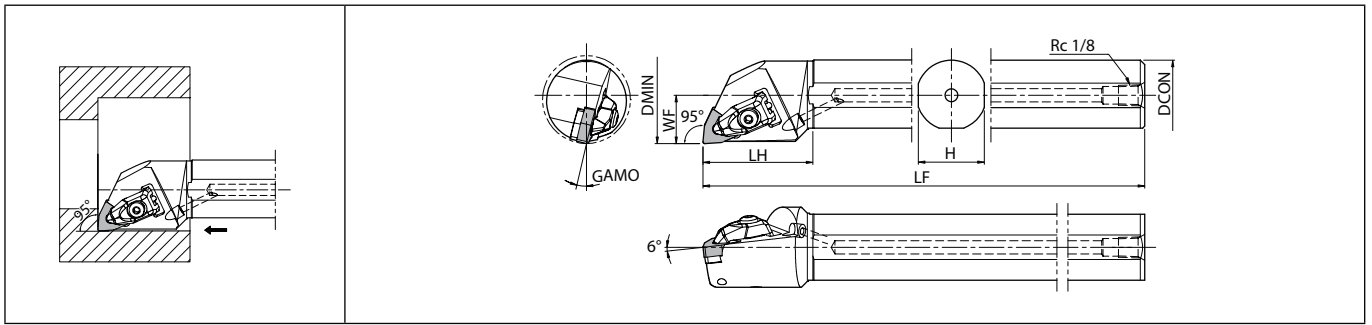

Max. Overhang Length L/D=~3 | Right-hand shown
Left-hand Insert for Right-hand Toolholder, Right-hand Insert for Left-hand Toolholder.

F

Toolholder dimensions

Description	Availability		Dimension (mm)							GAMO (°)	Standard corner-R(RE)	Coolant hole	Applicable inserts
	R	L	DMIN	DCON	H	LH	LF	WF					
A25R- DWLN [®] /L.08-32	●	●	32	25	23	50	200	17	13	0.8	Yes	WN□A0804... WN□G0804... WN□M0804...	
A32S- DWLN [®] /L.08-40	●	●	40	32	30	50	250	22					
A40T- DWLN [®] /L.08-50	●	●	50	40	37	60	300	27					

Description	Spare parts							
	Clamp	Screw (for clamp)	Spring	Wrench (for clamp)	Shim	Screw (for shim)	Wrench* (for shim)	Nozzle
A25R- DWLN [®] /L.08-32	CP-3D	CS-3D	SP-3D	LW-3	DW-42	SB-4085TR	FT-15	DN10
A32S- DWLN [®] /L.08-40								DN20
A40T- DWLN [®] /L.08-50								DN20

Not applicable to high-pressure coolant
Wrench (FT-15) is sold separately.

● : Standard item R : Right-hand only L : Left-hand only □ : Check availability

Boring

Solid

Positive

AD bars

Negative

S-WWLN-E Excellent bar (Boring / Internal facing)

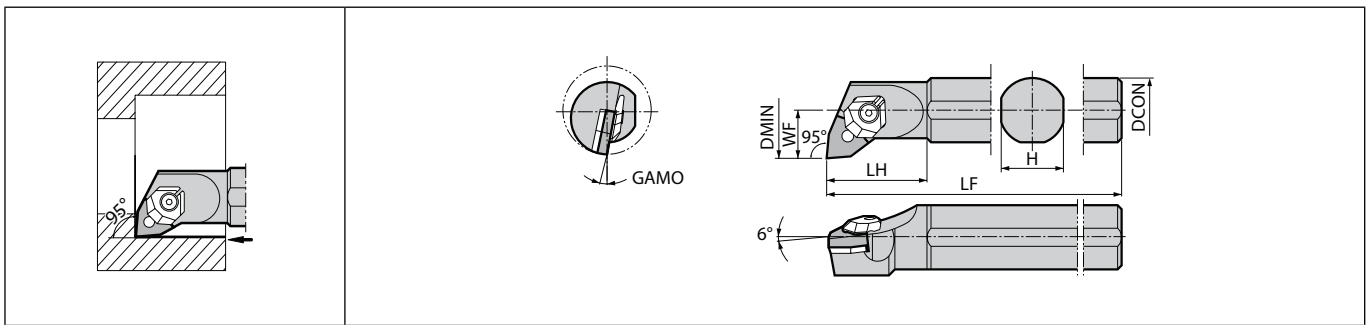

Max. Overhang Length L/D≈5 | Right-hand shown
Left-hand Insert for Right-hand Toolholder, Right-hand Insert for Left-hand Toolholder.

Toolholder dimensions



































Description	Availability		Dimension (mm)								GAMO (°)	Standard corner-R(RE)	Coolant hole	Spare parts					Applicable inserts
			R	L	DMIN	DCON	H	LH	LF	WF				Clamp set	Wrench	Shim	Shim pin	Wrench	
	S25S- WWLN%08-28E	●	●	28	25	24	36		14	13				1.2	No	WCS-8	LW-3	WWP-42 (WWP-42-16*)	
S25S- WWLN%08-34E	●	●	34		40	250	17	11											
S32S- WWLN%08-40E	●	●	40	32	30	50	20	10											

When using inserts whose corner-R(RE) is greater than 1.6 mm, please purchase a shim* and use it in order to prevent workpiece and shim from interfering each other.
In wedge lock, use of ceramic insert other than silicon nitride insert is not recommended due to strong restrain force.

● : Standard item R : Right-hand only L : Left-hand only □ : Check availability



Applicable inserts (A-DWLN / S-WWLN-E)

Applications	Finishing	Finishing	Finishing - Medium	Finishing - Medium	Finishing	Finishing	Finishing - Medium	Finishing - Medium
Insert								
Chip Breaker Type	WF	WP	WE	WQ	PP	GP	PQ	HQ
Page	B50	B50	B50	B50	B50	B50	B50	B51
Applications	Finishing - Medium	Finishing - Medium	Medium - Roughing	Medium - Roughing	Medium - Roughing	Medium - Roughing	Medium - Roughing	Roughing
Insert								
Chip Breaker Type	CQ	CJ	GS	PG	PS	PT	GT	STD
Page	B51	B51	B51	B51	B51	B51	B52	B52
Applications	Roughing	Low carbon steel	Low carbon steel	Low carbon steel	Stainless steel / Heat-resistant alloys	Stainless steel / Heat-resistant alloys	Stainless steel / Heat-resistant alloys	Stainless steel / Heat-resistant alloys
Insert								
Chip Breaker Type	PH	XP	XQ	XS	TK	MQ	MS	MU
Page	B52	B52	B52	B52	B52	B52	B53	B53
Applications	Cast iron	Cast iron	Cast iron	Cast iron	Cast iron	Cast iron	Cast iron	Non-Ferrous Metals
Insert								
Chip Breaker Type	KQ	KG	KH	C	ZS	GC	No CB	AH
Page	B53	B53	B53	B54	B54	B54	B54	B54
Applications	Non-Ferrous Metals	Heat-resistant alloys	Hard materials / Cast iron					
Insert								
Chip Breaker Type	PCD	SG	CBN					
Page	C38	B53	C15					

Recommended cutting conditions  F152, F153

F

Boring

Solid

Positive

AD bars

Negative

S-CELN (Boring / Internal facing)

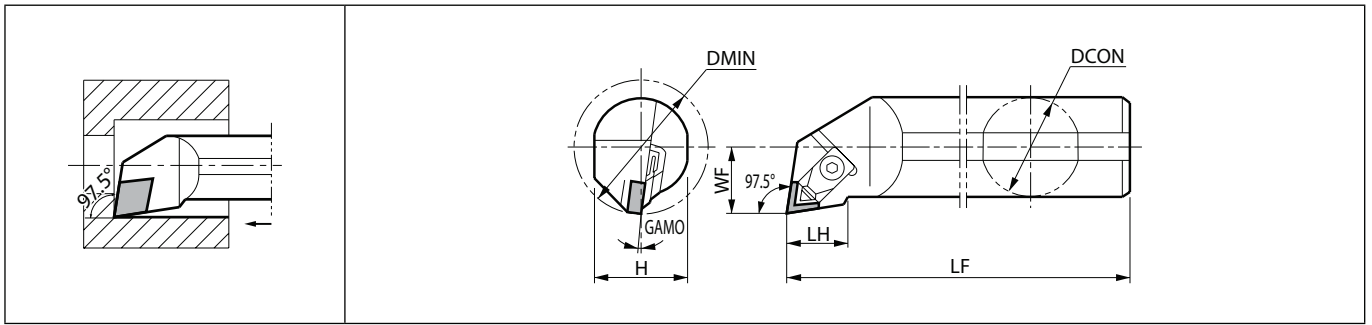

Max. Overhang Length L/D≈3 | Right-hand shown

Toolholder dimensions

Description	Availability		Dimension (mm)							GAMO (°)	Standard corner-R(RE)	Coolant hole	Spare parts					Applicable inserts
	R	DMIN	DCON	H	LH	LF	WF	Chipbreaker	Clamp set				Wrench	Shim	Shim screw			
	S40T- CELNR13-50	●	50	40	37	32	300	27	12				0.8	No				

Applicable inserts

Applications	Cast iron / Hard materials
Insert	
Type	Ceramic
Page	B115

Recommended cutting conditions F152, F153

● : Standard item R : Right-hand only L : Left-hand only □ : Check availability



S-CTUN-A (Boring)

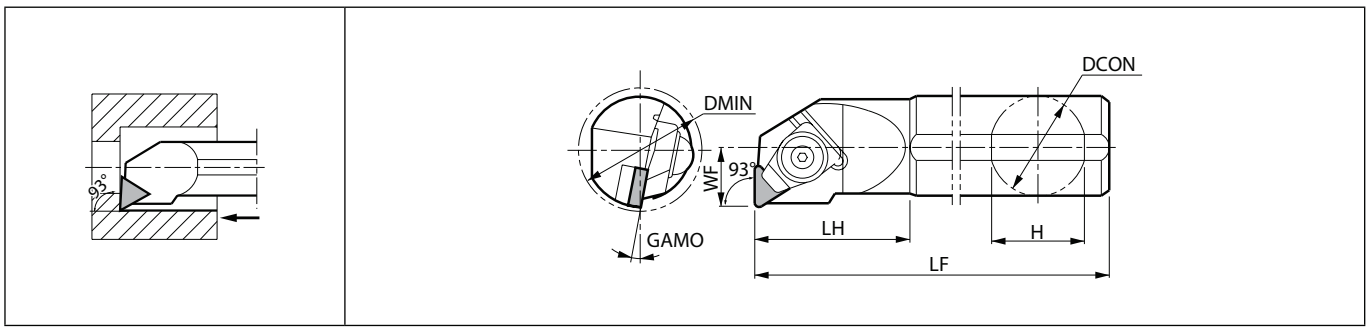

Right-hand shown

F

Toolholder dimensions

Description	Availability		Dimension (mm)							GAMO (°)	Standard corner-R(RE)	Spare parts				Applicable inserts
	R	DMIN	DCON	H	LH	LF	WF	Clamp set	Shim screw			Shim	Wrench			
	S25X- CTUNR11-30A	●	30	25	24	40	220	15	10			0.8				

Applicable inserts

Applications	Hard materials / Cast iron	Cast iron / Hard materials
Insert		
Type	CBN	Ceramic
Page	C19	B118

Recommended cutting conditions F152, F153

● : Standard item R : Right-hand only L : Left-hand only □ : Check availability

Boring

Solid

Positive

AD bars

Negative

EZH Sleeves

Sleeve Description			Applicable Inserts				Applicable Machine Manufacturer	
EZH-CT (Adjustable overhang length with coolant hole)	EZH-HP (Adjustable overhang length)	EZH-ST	Sleeve Shank Dia. DCON (mm)	EZB	EZBT/EZBF EZBP/EZBC EZVB/EZG EZFG/EZT	EZ Bar PLUS		Shank Dia. DCON (mm)
-	-	EZH 01712ST-80 02012ST-80 02512ST-80 03012ST-80 03512ST-80 04012ST-80 05012ST-80 06012ST-80 07012ST-80	12	EZB ...017... EZB ...020... EZB ...025... EZB ...030... EZB ...035... EZB ...040... EZB ...050... EZB ...060... EZB ...070...	- EZ ...020... EZ ...025... EZ ...030... EZ ...035... EZ ...040... EZ ...050... EZ ...060... EZ ...070...	-	1.7 2 2.5 3 3.5 4 5 6 7	(General purpose)
-	EZH 01716HP-100 02016HP-100 02516HP-100 03016HP-100 03516HP-100 04016HP-100 04516HP-100 05016HP-100 06016HP-100 07016HP-100	EZH 01716ST-100 02016ST-100 02516ST-100 03016ST-100 03516ST-100 04016ST-100	16	EZB ...017... EZB ...020... EZB ...025... EZB ...030... EZB ...035... EZB ...040... EZB ...045... EZB ...050... EZB ...060... EZB ...070... EZB ...080...	- EZ ...020... EZ ...025... EZ ...030... EZ ...035... EZ ...040... - EZ ...050... EZ ...060... EZ ...070... -	- - - - - - _045X- ...-050EZP _050X- ...-060EZP _060X- ...-070EZP _070X- ...-080EZP _080X- ...-100EZP	1.7 2 2.5 3 3.5 4 4.5 5 6 7 8	(General purpose)
EZH 01719CT-120 02019CT-120 02519CT-120 03019CT-120 03519CT-120 04019CT-120 04519CT-120 05019CT-120 06019CT-120 07019CT-120 08019CT-120	EZH 01719HP-120 02019HP-120 02519HP-120 03019HP-120 03519HP-120 04019HP-120 04519HP-120 05019HP-120 06019HP-120 07019HP-120 08019HP-120	EZH 01719ST-120 02019ST-120 02519ST-120 03019ST-120 03519ST-120 04019ST-120	19.05	EZB ...017... EZB ...020... EZB ...025... EZB ...030... EZB ...035... EZB ...040... EZB ...045... EZB ...050... EZB ...060... EZB ...070... EZB ...080...	- EZ ...020... EZ ...025... EZ ...030... EZ ...035... EZ ...040... - EZ ...050... EZ ...060... EZ ...070... -	- - - - - - _045X- ...-050EZP _050X- ...-060EZP _060X- ...-070EZP _070X- ...-080EZP _080X- ...-100EZP	1.7 2 2.5 3 3.5 4 4.5 5 6 7 8	Citizen Machinery
EZH 01720CT-120 02020CT-120 02520CT-120 03020CT-120 03520CT-120 04020CT-120 04520CT-120 05020CT-120 06020CT-120 07020CT-120 08020CT-120	EZH 01720HP-120 02020HP-120 02520HP-120 03020HP-120 03520HP-120 04020HP-120 04520HP-120 05020HP-120 06020HP-120 07020HP-120 08020HP-120	EZH 01720ST-120 02020ST-120 02520ST-120 03020ST-120 03520ST-120 04020ST-120	20	EZB ...017... EZB ...020... EZB ...025... EZB ...030... EZB ...035... EZB ...040... EZB ...045... EZB ...050... EZB ...060... EZB ...070... EZB ...080...	- EZ ...020... EZ ...025... EZ ...030... EZ ...035... EZ ...040... - EZ ...050... EZ ...060... EZ ...070... -	- - - - - - _045X- ...-050EZP _050X- ...-060EZP _060X- ...-070EZP _070X- ...-080EZP _080X- ...-100EZP	1.7 2 2.5 3 3.5 4 4.5 5 6 7 8	Eguro Tsugami Citizen Machinery (General purpose)
EZH 01722CT-135 02022CT-135 02522CT-135 03022CT-135 03522CT-135 04022CT-135 04522CT-135 05022CT-135 06022CT-135 07022CT-135 08022CT-135	EZH 01722HP-135 02022HP-135 02522HP-135 03022HP-135 03522HP-135 04022HP-135 04522HP-135 05022HP-135 06022HP-135 07022HP-135 08022HP-135	EZH 01722ST-135 02022ST-135 02522ST-135 03022ST-135 03522ST-135 04022ST-135	22	EZB ...017... EZB ...020... EZB ...025... EZB ...030... EZB ...035... EZB ...040... EZB ...045... EZB ...050... EZB ...060... EZB ...070... EZB ...080...	- EZ ...020... EZ ...025... EZ ...030... EZ ...035... EZ ...040... - EZ ...050... EZ ...060... EZ ...070... -	- - - - - - _045X- ...-050EZP _050X- ...-060EZP _060X- ...-070EZP _070X- ...-080EZP _080X- ...-100EZP	1.7 2 2.5 3 3.5 4 4.5 5 6 7 8	Star Micronics Nomura DS Tsugami
EZH 01725.0CT-135 02025.0CT-135 02525.0CT-135 03025.0CT-135 03525.0CT-135 04025.0CT-135 04525.0CT-135 05025.0CT-135 06025.0CT-135 07025.0CT-135 08025.0CT-135	EZH 01725.0HP-135 02025.0HP-135 02525.0HP-135 03025.0HP-135 03525.0HP-135 04025.0HP-135 04525.0HP-135 05025.0HP-135 06025.0HP-135 07025.0HP-135 08025.0HP-135	EZH 01725.0ST-135 02025.0ST-135 02525.0ST-135 03025.0ST-135 03525.0ST-135 04025.0ST-135	25	EZB ...017... EZB ...020... EZB ...025... EZB ...030... EZB ...035... EZB ...040... EZB ...045... EZB ...050... EZB ...060... EZB ...070... EZB ...080...	- EZ ...020... EZ ...025... EZ ...030... EZ ...035... EZ ...040... - EZ ...050... EZ ...060... EZ ...070... -	- - - - - - _045X- ...-050EZP _050X- ...-060EZP _060X- ...-070EZP _070X- ...-080EZP _080X- ...-100EZP	1.7 2 2.5 3 3.5 4 4.5 5 6 7 8	Eguro Tsugami Citizen Machinery (General purpose)
EZH 01725.4CT-120 02025.4CT-120 02525.4CT-120 03025.4CT-120 03525.4CT-120 04025.4CT-120 04525.4CT-120 05025.4CT-120 06025.4CT-120 07025.4CT-120 08025.4CT-120	EZH 01725.4HP-120 02025.4HP-120 02525.4HP-120 03025.4HP-120 03525.4HP-120 04025.4HP-120 04525.4HP-120 05025.4HP-120 06025.4HP-120 07025.4HP-120 08025.4HP-120	EZH 01725.4ST-120 02025.4ST-120 02525.4ST-120 03025.4ST-120 03525.4ST-120 04025.4ST-120	25.4	EZB ...017... EZB ...020... EZB ...025... EZB ...030... EZB ...035... EZB ...040... EZB ...045... EZB ...050... EZB ...060... EZB ...070... EZB ...080...	- EZ ...020... EZ ...025... EZ ...030... EZ ...035... EZ ...040... - EZ ...050... EZ ...060... EZ ...070... -	- - - - - - _045X- ...-050EZP _050X- ...-060EZP _060X- ...-070EZP _070X- ...-080EZP _080X- ...-100EZP	1.7 2 2.5 3 3.5 4 4.5 5 6 7 8	Citizen Machinery

* Choose sleeves (DCB) to meet with DCON dimension of bar.

* Adjustment Pin cannot be installed to EZH-ST sleeves. To adjust overhanda of the bar, please use EZH-CT / HP sleeves.



EZH Sleeves and Applicable Inserts / Toolholders

Shank Size (Hole Dia.: mm)		017 (1.7mm)	020 (2mm)	025 (2.5mm)	03 (3mm)	035 (3.5mm)
EZH-CT sleeve (Internal coolant)	EZH-HP sleeve description (Adjustable overhang length)	EZH 01716HP-100	EZH 02016HP-100	EZH 02516HP-100	EZH 03016HP-100	EZH 03516HP-100
		01719CT/HP-120	02019CT/HP-120	02519CT/HP-120	03019CT/HP-120	03519CT/HP-120
		01720CT/HP-120	02020CT/HP-120	02520CT/HP-120	03020CT/HP-120	03520CT/HP-120
		01722CT/HP-135	02022CT/HP-135	02522CT/HP-135	03022CT/HP-135	03522CT/HP-135
		01725.0CT/HP-135	02025.0CT/HP-135	02525.0CT/HP-135	03025.0CT/HP-135	03525.0CT/HP-135
		01725.4CT/HP-120	02025.4CT/HP-120	02525.4CT/HP-120	03025.4CT/HP-120	03525.4CT/HP-120
EZH-ST sleeve description	EZH 01712ST-80	EZH 02012ST-80	EZH 02512ST-80	EZH 03012ST-80	EZH 03512ST-80	
	01716ST-100	02016ST-100	02516ST-100	03016ST-100	03516ST-100	
	01719ST-120	02019ST-120	02519ST-120	03019ST-120	03519ST-120	
	01720ST-120	02020ST-120	02520ST-120	03020ST-120	03520ST-120	
	01722ST-135	02022ST-135	02522ST-135	03022ST-135	03522ST-135	
	01725.0ST-135	02025.0ST-135	02525.0ST-135	03025.0ST-135	03525.0ST-135	
	01725.4ST-120	02025.4ST-120	02525.4ST-120	03025.4ST-120	03525.4ST-120	
		EZB [®] /L 020020HP-	EZB [®] /L 025025HP-	EZB [®] /L 030030HP-	EZB [®] /L 035035HP-	
		EZBR 020017ST-	EZBR 025020ST-	EZBR 030025ST-	EZBR 035030ST-	
	EZBR 020017-...NB	EZBR 025020-...NB	EZBR 030025-...NB	EZBR 035030-...NB		
EZ Bars	Boring		EZBPR 020020-		EZBFR 030030-008	
					EZBPR 030030-	
					EZVBR 035030-	
					EZGR 030030-	
	Internal Grooving					
	Face Grooving					
	Internal Threading		EZTR 030025-	EZTR 035030-	EZTR 040035-	
EZ Bar PLUS						

F





Boring

Shank Size (Hole Dia.: mm)		04 (4mm)	045 (4.5mm)	05 (5mm)	06 (6mm)	07 (7mm)	08 (8mm)	
EZH-CT sleeve (Internal coolant)	EZH-HP sleeve description (Adjustable overhang length)	EZH 04016HP-100	EZH 04516HP-100	EZH 05016HP-100	EZH 06016HP-100	EZH 07016HP-100	EZH 08016HP-100	
		04019CT/HP-120	04519CT/HP-120	05019CT/HP-120	06019CT/HP-120	07019CT/HP-120	08019CT/HP-120	
		04020CT/HP-120	04520CT/HP-120	05020CT/HP-120	06020CT/HP-120	07020CT/HP-120	08020CT/HP-120	
		04022CT/HP-135	04522CT/HP-135	05022CT/HP-135	06022CT/HP-135	07022CT/HP-135	08022CT/HP-135	
		04025.0CT/HP-135	04525.0CT/HP-135	05025.0CT/HP-135	06025.0CT/HP-135	07025.0CT/HP-135	08025.0CT/HP-135	
		04025.4CT/HP-120	04525.4CT/HP-120	05025.4CT/HP-120	06025.4CT/HP-120	07025.4CT/HP-120	08025.4CT/HP-120	
EZH-ST sleeve description	EZH 04012ST-80		EZH 05012ST-80	EZH 06012ST-80	EZH 07012ST-80	EZH 08012ST-80		
	04016ST-100		05016ST-100	06016ST-100	07016ST-100	08016ST-100		
	04019ST-120		05019ST-120	06019ST-120	07019ST-120	08019ST-120		
	04020ST-120		05020ST-120	06020ST-120	07020ST-120	08020ST-120		
	04022ST-135		05022ST-135	06022ST-135	07022ST-135	08022ST-135		
	04025.0ST-135		05025.0ST-135	06025.0ST-135	07025.0ST-135	08025.0ST-135		
	04025.4ST-120		05025.4ST-120	06025.4ST-120	07025.4ST-120	08025.4ST-120		
		EZB [®] /L 040040HP-	EZB [®] /L 045045HP-	EZB [®] /L 050050HP-	EZB [®] /L 060060HP-	EZB [®] /L 070070HP-	EZB [®] /L 080080HP-	
		EZBR 045040ST-		EZBR 055050ST-	EZBR 065060ST-	EZBR 075070ST-		
	EZBR ...040-...NB		EZBR ...050-...NB	EZBR ...060-...NB	EZBR ...070-...NB			
EZ Bars	Boring	EZBFR 040040-008		EZBFR 050050-015	EZBFR 060060-015			
		EZBPR 040040-015		EZBPR 050050-015	EZBPR 060060-015			
				EZBCR 050050-	EZBCR 060060-	EZBCR 070070-		
		EZVBR 045040-		EZVBR 055050-	EZVBR 065060-			
		EZBTR 040040-		EZBTR 050050-				
		Internal Grooving	EZG [®] /L 040040-		EZG [®] /L 050050-	EZG [®] /L 060060-	EZG [®] /L ...070-...	
		Face Grooving	EZFG [®] /L 050040-		EZFG [®] /L 060050-		EZFG [®] /L 080070-	
Internal Threading	EZTR 050040-		EZTR 060050-	EZTR 070060-	EZTR 080070-			
EZ Bar PLUS			S/C045X-SCLCR03-050EZP	S/C050X-SCLCR03-060EZP	S/C060X-SCLCR04-070EZP	S/C070X-SCLCR04-080EZP	S/C080X-SCLCR06-100EZP	
				S/C050X-SWUBR06-060EZP	S/C060X-SWUBR06-070EZP	S/C070X-STLBR06-080EZP	S/C080X-STLPR09-100EZP	
Boring Bars		C04-....		C05-....	C06-....	C07-....	C/E08-....	
					S06-....		A/S08-....	

Note 1) When attaching 2-Edge Tip-Bars to EZH-CT/HP Sleeve (Adjustable overhang length), detach Adjustable Pin.
Overhang length of bar is not adjustable.

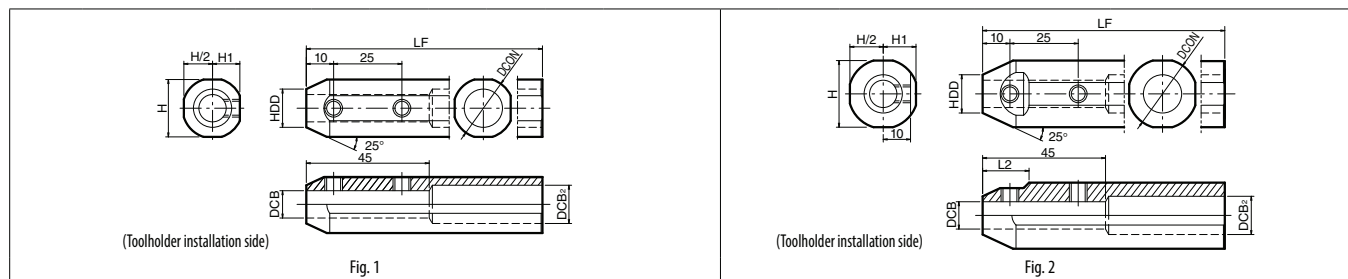
SHA sleeves (Applicable Toolholders )



Description	Availability	Dimension (mm)									Drawing	Spare Parts		Applicable Machine Manufacturer
		DCB	DCON	HDD	DCB ₂	H	H1	LF	L2	Screw		Wrench		
														
SHA 0820-120	●	8	20	14	12	19	9.25	120	-	Fig. 1	HS6X4P	LW-3	Eguro Tsumami Citizen Machinery	
SHA 1020-120	●	10		14										
SHA 0825.0-135	●	8	25	14	14	24	11.5	135	17	Fig. 2	HS6X4P	LW-3		
SHA 1025.0-135	●	10		16										
SHA 1225.0-135	●	12		16										
SHA 0819-120	●	8	19.05	14	12	18	8.75	120	-	Fig. 1	HS6X4P	LW-3		Citizen Machinery
SHA 1019-120	●	10		14										
SHA 0820-120	●	8	20	14	12	19	9.25	120	-	Fig. 1	HS6X4P	LW-3		
SHA 1020-120	●	10		14										
SHA 0825.4-120	●	8	25.4	14	14	24.4	12	120	17	Fig. 2	HS6X4P	LW-3		
SHA 1025.4-120	●	10		16										
SHA 1225.4-120	●	12		16										
SHA 0822-125	●	8	22	14	14	21	10	125	-	Fig. 1	HS6X4P	LW-3	Star Micronics Nomura DS	
SHA 1022-125	●	10		16										
SHA 1222-125	●	12		16										
SHA 0823-120	●	8	23	14	14	22	10.5	120	16	Fig. 2	HS6X4P	LW-3	Nomura DS	
SHA 1023-120	●	10		16										
SHA 1223-120	●	12		16										

* Length of DCB=45mm (All of SHA sleeves)
 Choose sleeves (DCB) to meet with DCON dimension of toolholder.
 Machine manufacturers in random order.



Boring

Sleeves for Boring Bars

Shape	Description	Availability	Dimension (mm)					Spare Parts	
			DCON	DCB	DCB ₂	H	LF	Screw	Wrench
 (Toolholder installation side)	SH 0416-100	●	16	4	5	14	100	HS4X4	LW-2
	0516-100	●		5	6				
	0616-100	●		6	7				
	0716-100	●		7	8				
	SH 0820-120	●	20	8	9	18	120	HS4X4	LW-2
	1020-120	●	25	10	11	23	150	HS5X5	LW-2.5
	1225-150	●		12	13				
	1632-180	●		16	18				
2032-180	●	32	20	22	30	180			

Coolant Sleeve Dimensions

Accessories
 Back Cover / SHL-4...SHC○○○40-70
 SHL-5...SHC○○○50-95

Back Cover Screw
 Shank Clamp Screw

(Note) To stabilize the toolholder and to prevent coolant leaks, tighten all 4 screws of coolant sleeve securely.

Description	Availability	Dimension (mm)							Drawing	Spare Parts						
		DCON	HDD	DCB	LS	LH	H	A		Front Screw	Wrench	Back Screw	Wrench	Back Cover	Back Cover Screw	Wrench
SHC 0840-70	●	40	56	8	70	16	38	27	Fig. 1	HS6X22	LW-3	HS6X14	LW-3	SHL-4	HH3X6	LW-2.5
1040-70	●			10												
1240-70	●			12												
1640-70	●			16												
2040-70	●			20												
2540-70	●			25												
SHC 0850-95	●	50	65	8	95	16	47	30.5	Fig. 1	HS6X22	LW-3	HS6X14	LW-3	SHL-5	HH3X12	LW-2.5
1050-95	●			10												
1250-95	●			12												
1650-95	●			16												
2050-95	●			20												
2550-95	●			25												

How to Install

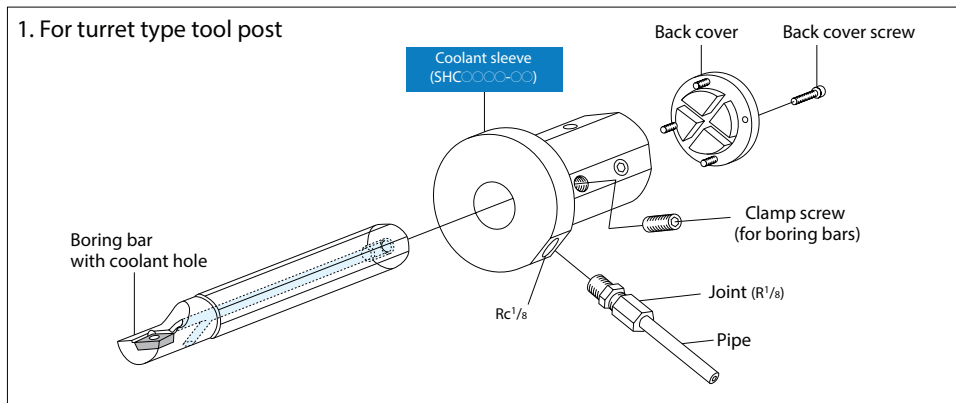

Coolant Joint Dimensions *This Coolant Joint is not applicable for Dynamic Bar

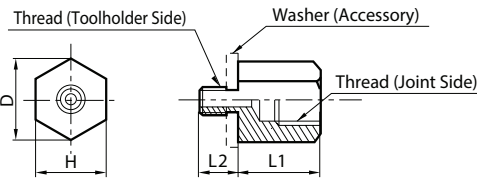

Description	Availability	Dimension (mm)				Thread (Toolholder Side)	Thread (Joint Side)	Spare Parts	
		D	L1	L2	H			Washer	Image
SJS-5	●	15	15	7	13	M5XP0.8	Rc1/8 (PT1/8)	WB-5	
SJS-6	●			9		WB-6			
SJS-8	●			13		WB-8			

2. For gang type toolpost

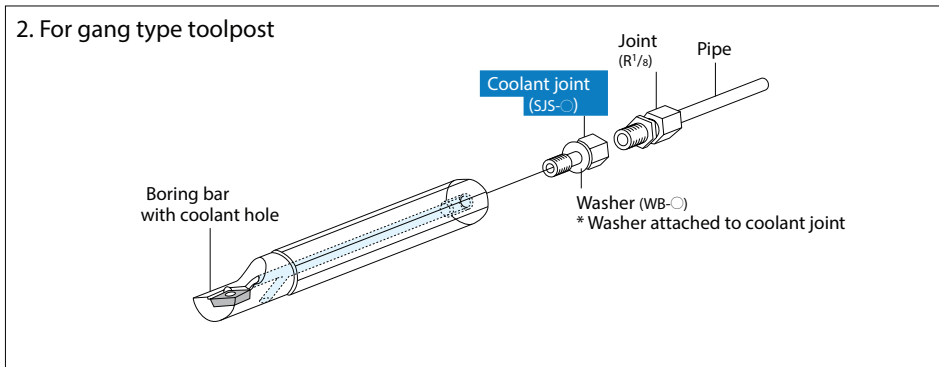

List of toolholders and applicable joints

Toolholder Description	Applicable Coolant Joint
A08-...-○○E	SJS-5
A10-...-○○E	
A12-...-○○E	
A16-...-○○E	SJS-8
A20-...-○○E	
A25-...-○○E	
E08-...-○○	SJS-5
E10-...-○○	
E12-...-○○	SJS-6
E16-...-○○	
E20-...-○○	SJS-8

*This Coolant Joint is not applicable for Dynamic Bar

SHA / SH / SHC Sleeves and Applicable Toolholders

Shank Size (Hole Dia.: mm)	04 (4mm)	05 (5mm)	06 (6mm)	07 (7mm)	08 (8mm)	10 (10mm)	12 (12mm)	16 (16mm)	20 (20mm)	25 (25mm)
Sleeve Description	SH0416-100	SH0516-100	SH0616-100	SH0716-100	SH0820-120	SH1020-120	SH1225-150	SH1632-180	SH2032-180	
					SHA0819-120	SHA1019-120				
					SHA0820-120	SHA1020-120				
					SHA0822-125	SHA1022-125	SHA1222-125			
					SHA0823-120	SHA1023-120	SHA1223-120			
					SHA0825.0-135	SHA1025.0-135	SHA1225.0-135			
					SHA0825.4-120	SHA1025.4-120	SHA1225.4-120			
					SHC0840-70	SHC1040-70	SHC1240-70	SHC1640-70	SHC2040-70	SHC2540-70
Boring Bar Description	C04-...	C05-...	C06-...	C07-...	A08-...	A10-...	A12-...	A16-...	A20-...	A25-...
					E08-...	E10-...	E12-...	E16-...	E20-...	E25-...
			S06-...		S08-...	S10-...	S12-...	S16-...	S20-...	S25-...
Internal Grooving Toolholder Description			SIGC%/0806-WH		SIGC%/1008-WH-L85	SIGCR1210-WH-L95	SIGC%/0812-EH	SIGC%/1016-EH		
					SIGCR1008-WH-L100	SIGC%/1210-WH-L110		SIGC%/1216-EH		
					SIGE%/0808A-EH	SIGE%/1010B-EH	SIGE%/1412C-EH	SIGE%/1616C-EH	SIGE%/2020D-EH	SIGE%/2525E-EH
						SIGE%/1210B-EH	SIGE%/1612C-EH			KIGBA%/3525-16
					SIGE%/0808A-WH	SIGE%/1010B-WH	SIGE%/1412C-WH	KGDI%/...16B-	KGDI%/2520B-	KGDI%/3225B-
						SIGE%/1210B-WH	SIGE%/1612C-WH			
					SIGER1008B-WH-90	SIGER1210B-WH-90	SIGER1412C-WH-90			
							GIV%/1412-1SE	GIV%/1216-1SS	GIV%/1420-1S	GIV%/2025-1B
							GIV%/1612-1AE	GIV%/2016-1BE	GIV%/1620-1A	GIV%/2025-2B
								GIV%/2016-2BE	GIV%/2520-1CE	GIV%/3225-1CE
Internal Threading Toolholder Description							SINR0612S-06E	SINR0816S-08E	SIN%/2420S-16	CIN%/3025S-16
								SIN%/1216S-11E	SINR2420S-22	CINR3025S-22
								SIN%/1516S-11		
								SIN%/1616S-16		

* For SHA sleeves, please see page F149. For SH / SHC sleeves, please see page F150.



Boring: Positive insert (Cutting diameter under 10 mm)

ISO classification	Workpiece material	Hardness	Cutting range	Applications	Chipbreaker	Insert grades	Corner-R (RE)	Lower limit - Recommendation - Upper limit		
								Vc (m/min)	ap (mm)	f (mm/rev)
P*	Low-carbon steel Low-carbon alloy	HB ≤ 300	Finishing Solid type	Continuous Interruption	EZB-F EZB-H	PR1225	0.05 0.15	30 - 70 - 110 30 - 60 - 90	0.05 - 0.1 - 0.2 0.05 - 0.1 - 0.2	0.01 - 0.04 - 0.07 0.03 - 0.07 - 0.1
			Finishing	Continuous Interruption	F	PR1725	0.1 0.2	40 - 80 - 120 40 - 70 - 100	0.05 - 0.08 - 0.1 0.05 - 0.1 - 0.15	0.03 - 0.05 - 0.07 0.03 - 0.07 - 0.1
			Finishing-Medium	Continuous Interruption	CF	PR1725	0.1 0.2	40 - 80 - 120 40 - 70 - 100	0.05 - 0.15 - 0.25 0.05 - 0.15 - 0.25	0.03 - 0.05 - 0.07 0.03 - 0.07 - 0.1
	Medium-carbon steel Medium-carbon alloy	HB ≤ 300	Finishing Solid type	Continuous Interruption	EZB-F EZB-H	PR1225	0.05 0.15	30 - 70 - 110 30 - 60 - 90	0.05 - 0.1 - 0.2 0.05 - 0.1 - 0.2	0.01 - 0.04 - 0.07 0.03 - 0.07 - 0.1
			Finishing	Continuous Interruption	F	PR1725	0.1 0.2	40 - 80 - 120 40 - 70 - 120	0.05 - 0.08 - 0.1 0.05 - 0.1 - 0.15	0.03 - 0.05 - 0.07 0.03 - 0.07 - 0.1
			Finishing-Medium	Continuous Interruption	CF	PR1725	0.1 0.2	40 - 80 - 120 40 - 70 - 100	0.05 - 0.15 - 0.25 0.05 - 0.15 - 0.25	0.03 - 0.05 - 0.07 0.03 - 0.07 - 0.1
	High-carbon alloy	HB ≤ 280	Finishing Solid type	Continuous Interruption	EZB-F EZB-H	PR1225	0.05 0.15	30 - 70 - 110 30 - 60 - 90	0.05 - 0.1 - 0.2 0.05 - 0.1 - 0.2	0.01 - 0.04 - 0.07 0.03 - 0.07 - 0.1
			Finishing	Continuous Interruption	F	PR1725	0.1 0.2	40 - 80 - 120 40 - 70 - 100	0.05 - 0.08 - 0.1 0.05 - 0.1 - 0.15	0.03 - 0.05 - 0.07 0.03 - 0.07 - 0.1
			Finishing-Medium	Continuous Interruption	CF	PR1725	0.1 0.2	40 - 80 - 120 40 - 70 - 100	0.05 - 0.15 - 0.25 0.05 - 0.15 - 0.25	0.03 - 0.05 - 0.07 0.03 - 0.07 - 0.1
M	Stainless steel	HB ≤ 220	Finishing Solid type	Continuous Interruption	EZB-F EZB-H	PR1225	0.05 0.15	30 - 60 - 80 30 - 60 - 80	0.05 - 0.1 - 0.2 0.05 - 0.1 - 0.2	0.01 - 0.03 - 0.05 0.02 - 0.05 - 0.07
			Finishing	Continuous Interruption	F	PR1225 PR1535	0.1 0.2	30 - 60 - 80 30 - 60 - 80	0.05 - 0.08 - 0.1 0.05 - 0.1 - 0.15	0.03 - 0.05 - 0.07 0.03 - 0.07 - 0.1
			Finishing-Medium	Continuous Interruption	CF	PR1225 PR1535	0.1 0.2	30 - 60 - 80 30 - 60 - 80	0.05 - 0.15 - 0.25 0.05 - 0.15 - 0.25	0.03 - 0.05 - 0.07 0.03 - 0.07 - 0.1
	Stainless steel	HB ≤ 300	Finishing Solid type	Continuous Interruption	EZB-F EZB-H	PR1225	0.05 0.15	30 - 60 - 80 30 - 60 - 80	0.05 - 0.1 - 0.2 0.05 - 0.1 - 0.2	0.01 - 0.03 - 0.05 0.02 - 0.05 - 0.07
			Finishing	Continuous Interruption	F	PR1225 PR1535	0.1 0.2	30 - 60 - 80 30 - 60 - 80	0.05 - 0.08 - 0.1 0.05 - 0.1 - 0.15	0.03 - 0.05 - 0.07 0.03 - 0.07 - 0.1
			Finishing-Medium	Continuous Interruption	CF	PR1225 PR1535	0.1 0.2	30 - 60 - 80 30 - 60 - 80	0.05 - 0.15 - 0.25 0.05 - 0.15 - 0.25	0.03 - 0.05 - 0.07 0.03 - 0.07 - 0.1
K	Gray cast iron	HB ≤ 250	Finishing Solid type	Continuous Interruption	(VNB) (VNB-NB)	KW10	0.03 0.2	30 - 60 - 100 30 - 60 - 100	0.05 - 0.08 - 0.1 0.05 - 0.1 - 0.15	0.03 - 0.05 - 0.07 0.03 - 0.07 - 0.1
			Finishing	Continuous Interruption	F	KW10	0.1 0.2	30 - 60 - 100 30 - 60 - 80	0.05 - 0.08 - 0.1 0.05 - 0.1 - 0.15	0.03 - 0.05 - 0.07 0.03 - 0.07 - 0.1
			Finishing-Medium	Continuous Interruption	Without chipbreaker	KW10	0.2 0.4	30 - 60 - 100 30 - 60 - 80	0.1 - 0.2 - 0.3 0.1 - 0.2 - 0.3	0.03 - 0.05 - 0.07 0.03 - 0.07 - 0.1
	Nodular cast iron	HB ≤ 270	Finishing Solid type	Continuous Interruption	(VNB) (VNB-NB)	KW10	0.03 0.2	30 - 60 - 80 30 - 60 - 80	0.05 - 0.08 - 0.1 0.05 - 0.1 - 0.15	0.03 - 0.05 - 0.07 0.03 - 0.07 - 0.1
			Finishing	Continuous Interruption	F,U	KW10	0.1 0.2	30 - 60 - 80 30 - 60 - 80	0.05 - 0.08 - 0.1 0.05 - 0.1 - 0.15	0.03 - 0.05 - 0.07 0.03 - 0.07 - 0.1
			Finishing-Medium	Continuous Interruption	Without chipbreaker	KW10	0.2 0.4	30 - 60 - 100 30 - 60 - 80	0.1 - 0.2 - 0.3 0.1 - 0.2 - 0.3	0.03 - 0.05 - 0.07 0.03 - 0.07 - 0.1
N	Non-ferrous metals Copper alloy Aluminum Aluminum alloys	HB ≤ 100	High Speed Finishing Rainbow surface gloss	Continuous	Without chipbreaker	KPD001	0.05	150 - 200 - 300	0.05 - 0.1 - 0.3	0.05 - 0.1 - 0.15
			Finishing Long tool life	Continuous Interruption	F, U	PDL025	0.1 0.2	100 - 150 - 200 100 - 150 - 200	0.05 - 0.3 - 0.5 0.05 - 0.3 - 0.5	0.03 - 0.1 - 0.2 0.03 - 0.1 - 0.2
			Finishing	Continuous Interruption	F, U	KW10	0.1 0.2	100 - 150 - 200 100 - 150 - 200	0.05 - 0.3 - 0.5 0.05 - 0.3 - 0.5	0.03 - 0.1 - 0.2 0.03 - 0.1 - 0.2
S	Titanium alloys	HB ≤ 400	Precision Finishing Rainbow surface gloss	Continuous Interruption	Without chipbreaker	KPD001	0.1 0.2	100 - 120 - 150 70 - 100 - 120	0.05 - 0.1 - 0.3 0.05 - 0.1 - 0.3	0.03 - 0.07 - 0.1 0.03 - 0.07 - 0.1
			Finishing	Continuous Interruption	F, U	KW10	0.1 0.2	20 - 40 - 60 20 - 40 - 60	0.05 - 0.2 - 0.5 0.05 - 0.2 - 0.5	0.03 - 0.1 - 0.2 0.03 - 0.1 - 0.2
	Heat-resistant alloys	HB ≤ 350	Finishing Solid type	Continuous Interruption	(VNB)	KW10	0.2 0.2	10 - 30 - 50 10 - 30 - 50	0.05 - 0.1 - 0.3 0.05 - 0.1 - 0.3	0.03 - 0.05 - 0.1 0.03 - 0.05 - 0.08
			Finishing	Continuous Interruption	F,U	KW10	0.2 0.2	10 - 30 - 50 10 - 30 - 50	0.05 - 0.2 - 0.4 0.05 - 0.2 - 0.4	0.03 - 0.05 - 0.1 0.03 - 0.05 - 0.1
H	Hardened steel Hard materials	40~50 HRC	Finishing	Continuous Interruption	(VNB)	PR930	0.2 0.2	30 - 50 - 70 30 - 50 - 70	0.05 - 0.1 - 0.4 0.05 - 0.1 - 0.2	0.01 - 0.02 - 0.05 0.01 - 0.02 - 0.03
		45~68 HRC	Finishing	Continuous Interruption	ME MES	KBN05M	0.2 0.4	60 - 100 - 140 60 - 80 - 120	0.05 - 0.1 - 0.2 0.05 - 0.1 - 0.2	0.02 - 0.05 - 0.1 0.02 - 0.05 - 0.1

* Please use it with PR1725 set to Vc = 150 m/min or below, for machining of free-cutting steel such as small size SUM. For ap and f, refer to specs for low carbon steels.

• ap indicates radius

Boring: Positive insert (Cutting diameter over 10 mm)

ISO classification	Workpiece material	Hardness	Cutting range	Applications	Chipbreaker	Insert grades	Corner-R (RE)	Lower limit - Recommendation - Upper limit		
								Vc (m/min)	ap (mm)	f (mm/rev)
P*	Low-carbon steel Low-carbon alloy	HB ≤ 300	Precision finishing	Continuous Interruption	F, U	TN620 PR1725	0.1 0.2	250 - 300 - 350 120 - 170 - 220	0.05 - 0.3 - 0.5 0.05 - 0.3 - 0.5	0.03 - 0.1 - 0.15 0.03 - 0.1 - 0.15
			Finishing	Continuous Interruption	XP	PV710 CA025P	0.4 0.4	200 - 250 - 300 150 - 200 - 250	0.2 - 0.5 - 1.0 0.2 - 0.5 - 1.0	0.05 - 0.1 - 0.2 0.05 - 0.1 - 0.2
			Finishing-Medium	Continuous Interruption	XQ	PV710 CA025P	0.4 0.4	150 - 200 - 250 100 - 150 - 200	0.5 - 1.0 - 2.0 0.5 - 1.0 - 1.5	0.1 - 0.15 - 0.25 0.1 - 0.15 - 0.2
			Medium	Continuous Interruption	Standard	PV720 CA025P	0.8 0.8	100 - 150 - 200 80 - 120 - 150	1.0 - 1.5 - 2.5 1.0 - 1.5 - 2.0	0.1 - 0.15 - 0.3 0.1 - 0.15 - 0.2
	Medium-carbon steel Medium-carbon alloy	HB ≤ 300	Precision finishing	Continuous Interruption	F, U	TN620 PR1725	0.2 0.4	150 - 200 - 250 120 - 140 - 170	0.05 - 0.3 - 0.5 0.05 - 0.3 - 0.5	0.03 - 0.1 - 0.15 0.03 - 0.1 - 0.15
			Finishing	Continuous Interruption	PP	PV710 CA025P	0.4 0.4	150 - 200 - 250 120 - 180 - 200	0.2 - 0.5 - 1.0 0.2 - 0.5 - 1.0	0.05 - 0.1 - 0.2 0.05 - 0.1 - 0.2
			Finishing-Medium	Continuous Interruption	HQ	PV710 CA025P	0.4 0.4	120 - 180 - 220 100 - 150 - 200	0.5 - 1.0 - 2.0 0.5 - 1.0 - 1.5	0.1 - 0.15 - 0.25 0.1 - 0.15 - 0.2
			Medium	Continuous Interruption	Standard	PV720 CA025P	0.8 0.8	100 - 150 - 200 80 - 120 - 150	1.0 - 1.5 - 2.5 1.0 - 1.5 - 2.0	0.1 - 0.15 - 0.3 0.1 - 0.15 - 0.2
	High-carbon alloy	HB ≤ 280	Precision finishing	Continuous Interruption	F, U	TN620 PR1725	0.2 0.4	120 - 150 - 180 110 - 130 - 160	0.05 - 0.3 - 0.5 0.05 - 0.3 - 0.5	0.03 - 0.1 - 0.15 0.03 - 0.1 - 0.15
			Finishing	Continuous Interruption	PP	PV710 CA025P	0.4 0.4	120 - 150 - 180 100 - 120 - 150	0.2 - 0.5 - 1.0 0.2 - 0.5 - 1.0	0.05 - 0.1 - 0.2 0.05 - 0.1 - 0.2
			Finishing-Medium	Continuous Interruption	HQ	PV710 CA025P	0.4 0.4	120 - 150 - 180 100 - 120 - 150	0.5 - 1.0 - 2.0 0.5 - 1.0 - 1.5	0.1 - 0.15 - 0.25 0.1 - 0.15 - 0.2
			Medium	Continuous Interruption	Standard	CA515 CA025P	0.8 0.8	100 - 120 - 150 80 - 100 - 120	1.0 - 1.5 - 2.5 1.0 - 1.5 - 2.0	0.1 - 0.15 - 0.3 0.1 - 0.15 - 0.2
M	Stainless steel	HB ≤ 220	Finishing	Continuous Interruption	MQ	CA6525 PR1535	0.4 0.8	120 - 150 - 180 100 - 120 - 150	0.2 - 0.5 - 0.8 0.2 - 0.5 - 0.8	0.05 - 0.08 - 0.1 0.05 - 0.08 - 0.1
			Medium	Continuous Interruption	Standard	CA6525 PR1535	0.4 0.8	120 - 150 - 180 100 - 120 - 150	0.5 - 1.0 - 1.5 0.5 - 1.0 - 1.5	0.05 - 0.1 - 0.2 0.05 - 0.1 - 0.2
	Stainless steel	HB ≤ 300	Finishing	Continuous Interruption	MQ	CA6525 PR1535	0.4 0.8	80 - 100 - 120 60 - 80 - 100	0.2 - 0.7 - 1.0 0.2 - 0.7 - 1.0	0.05 - 0.1 - 0.15 0.05 - 0.1 - 0.15
			Medium	Continuous Interruption	Standard	CA6525 PR1535	0.4 0.8	80 - 100 - 120 60 - 80 - 100	0.5 - 1.0 - 1.5 0.5 - 1.0 - 1.5	0.05 - 0.1 - 0.2 0.05 - 0.1 - 0.2
K	Gray cast iron	HB ≤ 250	High speed finishing	Continuous Interruption	Without chipbreaker	KBN475 PT600M	0.4 0.8	400 - 500 - 600 200 - 250 - 350	0.05 - 0.2 - 0.5 0.2 - 0.5 - 1.0	0.05 - 0.1 - 0.15 0.05 - 0.1 - 0.15
			Finishing Gloss oriented	Continuous Interruption	Standard	PV7005 TN620	0.8 0.8	200 - 250 - 300 120 - 180 - 230	0.2 - 0.5 - 1.0 0.2 - 0.5 - 1.0	0.05 - 0.1 - 0.2 0.05 - 0.1 - 0.2
			Finishing	Continuous Interruption	Standard	CA310 CA315	0.4 0.8	150 - 180 - 200 100 - 150 - 180	0.2 - 0.5 - 1.0 0.2 - 0.5 - 1.0	0.05 - 0.1 - 0.2 0.05 - 0.1 - 0.2
			Medium	Continuous Interruption	Standard Without chipbreaker	CA310 CA315	0.8 0.8	100 - 150 - 200 80 - 120 - 150	0.5 - 1.0 - 2.0 0.5 - 1.0 - 2.0	0.1 - 0.15 - 0.2 0.05 - 0.1 - 0.15
	Nodular cast iron	HB ≤ 270	High speed finishing	Continuous Interruption	Without chipbreaker	KBN60M PT600M	0.4 0.8	200 - 300 - 400 150 - 200 - 250	0.05 - 0.2 - 0.5 0.2 - 0.5 - 1.0	0.03 - 0.05 - 0.1 0.05 - 0.1 - 0.15
			Finishing Gloss oriented	Continuous Interruption	Standard	PV7005 TN620	0.8 0.8	150 - 200 - 250 120 - 150 - 200	0.2 - 0.5 - 1.0 0.2 - 0.5 - 1.0	0.05 - 0.1 - 0.2 0.05 - 0.1 - 0.2
			Finishing	Continuous Interruption	Standard	CA310 CA315	0.4 0.8	120 - 150 - 180 100 - 120 - 150	0.2 - 0.5 - 1.0 0.2 - 0.5 - 1.0	0.05 - 0.1 - 0.2 0.05 - 0.1 - 0.2
			Medium	Continuous Interruption	Standard	CA315 CA320	0.8 0.8	100 - 120 - 150 80 - 100 - 120	0.5 - 1.0 - 2.0 0.5 - 1.0 - 2.0	0.05 - 0.1 - 0.2 0.05 - 0.1 - 0.15
N	Non-ferrous metals Copper alloy Aluminum Aluminum alloys	HB ≤ 100	High speed finishing Rainbow surface gloss	Continuous	Without chipbreaker	KPD001	0.2	200 - 400 - 1,000	0.05 - 0.1 - 0.3	0.05 - 0.1 - 0.15
			Finishing Long tool life	Continuous Interruption	F, U	PDLO25	0.4 0.4	100 - 200 - 400 100 - 200 - 400	0.05 - 0.5 - 1.0 0.05 - 0.5 - 1.0	0.03 - 0.1 - 0.2 0.03 - 0.1 - 0.2
			Finishing	Continuous Interruption	F, U	KW10	0.4 0.4	100 - 200 - 400 100 - 200 - 400	0.05 - 0.5 - 1.0 0.05 - 0.5 - 1.0	0.03 - 0.1 - 0.2 0.03 - 0.1 - 0.2
S	Titanium alloys	HB ≤ 400	Precision finishing Rainbow surface gloss	Continuous Interruption	Without chipbreaker	KPD001	0.2 0.4	100 - 120 - 150 70 - 100 - 120	0.05 - 0.1 - 0.3 0.05 - 0.1 - 0.3	0.03 - 0.07 - 0.1 0.03 - 0.07 - 0.1
			Finishing	Continuous Interruption	F, U	KW10	0.2 0.4	30 - 50 - 70 30 - 50 - 70	0.05 - 0.5 - 1.0 0.05 - 0.5 - 1.0	0.03 - 0.1 - 0.2 0.03 - 0.1 - 0.2
	Heat-resistant alloys	HB ≤ 350	Finishing	Continuous Interruption	F, U	KW10	0.4 0.4	10 - 30 - 50 10 - 30 - 50	0.05 - 0.5 - 1.0 0.05 - 0.5 - 1.0	0.03 - 0.1 - 0.2 0.03 - 0.1 - 0.2
			Finishing	Continuous Interruption	MQ	PR1310	0.4 0.8	40 - 60 - 80 40 - 60 - 80	0.1 - 0.3 - 0.5 0.1 - 0.3 - 0.5	0.03 - 0.05 - 0.1 0.03 - 0.05 - 0.1
H	Hardened steel Hard materials	40~50 HRC	Finishing	Continuous Interruption	HQ Standard	CA515	0.8 0.8	60 - 80 - 100 30 - 50 - 70	0.05 - 0.3 - 0.5 0.05 - 0.3 - 0.5	0.05 - 0.08 - 0.1 0.05 - 0.08 - 0.1
			Finishing	Continuous Interruption	ME MET	KBN05M	0.4 0.8	100 - 140 - 180 90 - 120 - 160	0.1 - 0.2 - 0.3 0.1 - 0.2 - 0.3	0.02 - 0.07 - 0.1 0.02 - 0.07 - 0.1
		Medium	Continuous	Without chipbreaker Negative	KBN900	0.8	60 - 80 - 100	0.3 - 0.7 - 1.0	0.03 - 0.1 - 0.15	

* When machining free-cutting steel such as SUM, please use PR1725 for Vc = 200 m/min or under or use PV720 / CA515, etc.
 • ap indicates radius



Boring

G

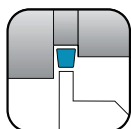

External grooving		G2
GBA type	KGBA/KGBAS/KGBA-JCT	G13
	KGB/KGBS	G16
GBF type	KGBF-F/KGBF-JCTM/KGBFS	G23
	S-KGBF	G26
GDM/GDMS/GDGS type	KGD (Integral type)	G34
	KGD (Integral type for automatic lathe)	G35
	KGD-JCT (Integral type)	G36
	KGD-JCTM (Integral type for automatic lathe)	G38
	KGD (Polygon taper shank)	G40
	KGD-S (0° separate type)	G41
GM/GMN/GMM/GMG/GMGA/FGG type	KGM/KGM-T/KGMM/KGMS	G55
	KGMU	G60
GH/GHU/GA type	KGH/KGHS/KGA	G62
GMGW type	KGMW	G67
TGF type	TGF	G68
Internal grooving		G69
EZG type	EZG	G71
VNG type	VNG	G73
GC type	SIGC	G76
GE/GER type	SIGE-EH / WH / WH-90	G81
GV type	GIV/GIV-E/GIV-W	G86
GBA type	KIGBA	G89
GDM/GDG type	KGDI	G91
GH/GHU type	KIGH	G93
GMM/GMG/GMGA type	KIGM-8/KIGMU-8	G95
GIA type	KGIA	G97
GMM-V type	GMM	G98
Face grooving		G99
EZFG type	EZFG	G103
VNFG type	VNFG	G105
TWFG/TWFGT small diameter face grooving (Twin-Bars)	TWFG	G106
	TWFGT	G108
GDFM/GDFMS type	KGDF 0°	G114
	KGDF-Z (Integral type)	G118
	KGDF 90°	G121
GVF type	GFV (A/B/C)	G127
	GIFV (A/B/C)	G133
FMM/FMN type	KFMS	G135
GMM/GMG/GMGA type	KFMS	G138
FTK type	KFTB-S	G140
Recommended cutting conditions		G141

KGD Grooving (External grooving & turning)

· Integral type

Type	KGD
Edge width (mm)	2.0 ~ 8.0
Max. grooving depth (mm)	6 ~ 30
See Page	G34

· Integral type (Coolant-through holders)

Type	KGD-JCTM
Edge width (mm)	3.0 ~ 5.0
Max. grooving depth (mm)	6 ~ 25
See Page	G39

· Integral type for automatic lathe

Type	KGD
Edge width (mm)	2.0 ~ 4.0
Max. grooving depth (mm)	10 ~ 25.5
See Page	G35

· Integral type for automatic lathe (Coolant-through holders)

Type	KGD-JCTM
Edge width (mm)	2.0 ~ 4.0
Max. grooving depth (mm)	12 ~ 16
See Page	G38

· Separate type

Type	*KGD-S
Edge width (mm)	3.0
Max. grooving depth (mm)	10
See Page	G42

* The separate type toolholders can accept all the blades if their hand is matching.

· Separate type

Type	*KGD-S
Edge width (mm)	2.0 ~ 5.0
Max. grooving depth (mm)	10 ~ 25
See Page	G41

* The separate type toolholders can accept all the blades if their hand is matching.

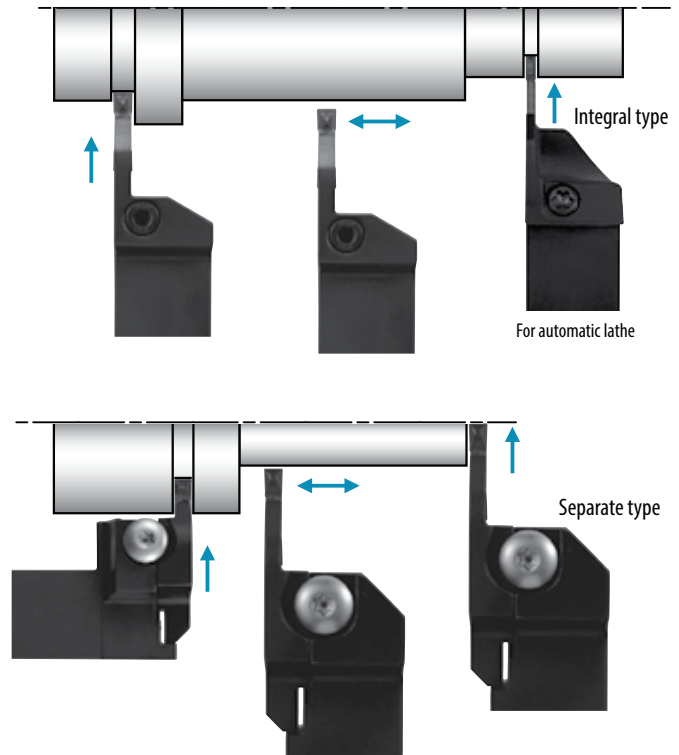

Low cutting force
GS

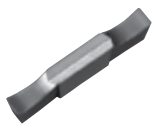

Low feed
GL



General purpose
GM



High feed
PH



Copying
CM



Shallow grooving (Grooving depth: ~5 mm)

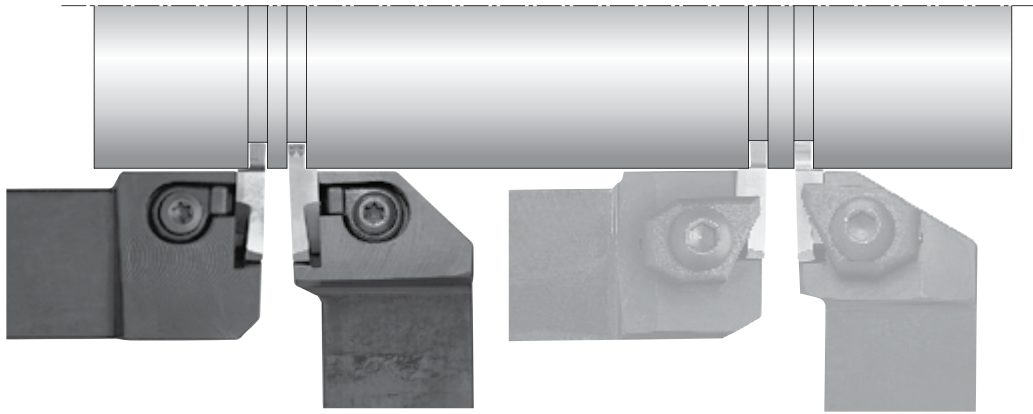

Type	KGBAS	KGBA (-JCT)	KGBS	KGB
Edge width (mm)	0.33~4.8	0.33~4.8	0.33~4.8	0.33~4.8
Max. grooving depth (mm)	0.8~5.0	0.8~5.0	0.8~5.0	0.8~5.0
See Page	G14	G13,G15	G17	G16

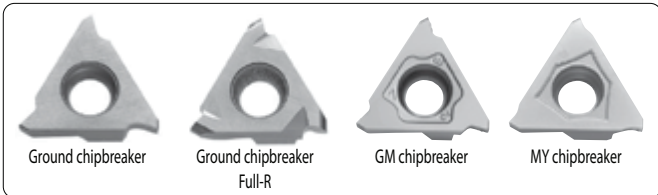

* These shallow groove types of the previous system will be switched to the system on the left.

KGBS → **KGBAS**
KGB → **KGBA**

	General (Square)	Full-R (Round)	GM chipbreaker	MY chipbreaker
Edge shape				

Deep grooving (Grooving depth : ~25 mm)

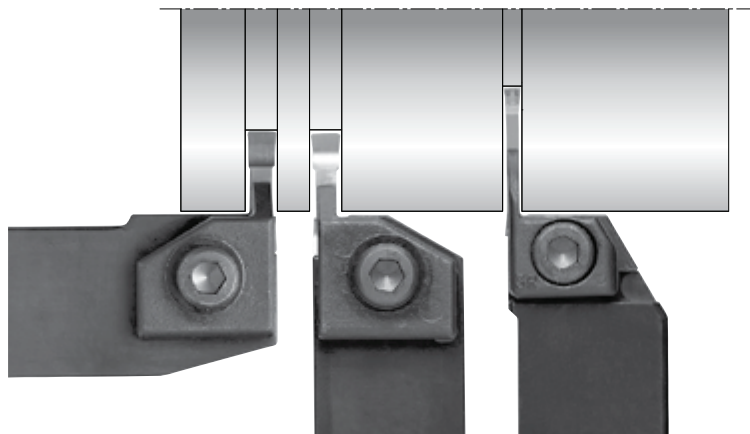

Type	KGHS	KGH	KGA
Edge Width (mm)	4.0~8.0	4.0~12.0	3.0~5.0
Max. grooving depth (mm)	13	13~17	20~25
See Page	G63	G62	G64

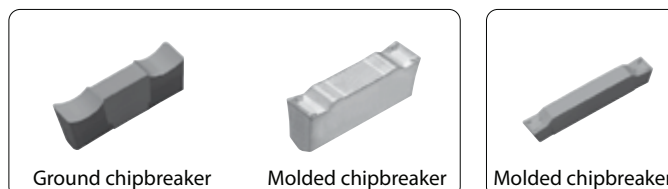

KGM Grooving (External grooving & turning)

Type	KGMM
Edge width (mm)	3.0~5.0
Max. grooving depth (mm)	4.8
See Page	G58

Type	KGMS
Edge width (mm)	3.0~5.0
Max. grooving depth (mm)	4.8
See Page	G58

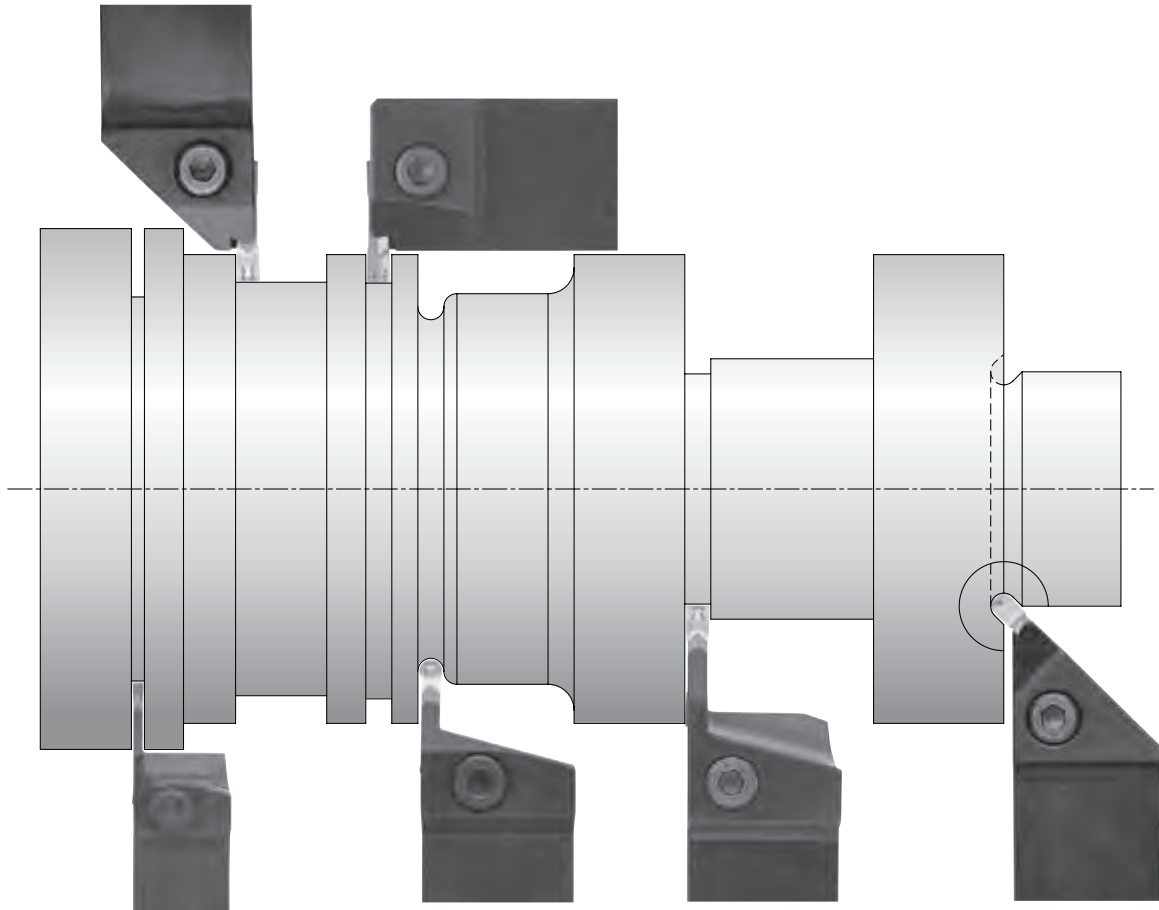

Type	KGM
Edge width (mm)	1.5~4.0
Max. grooving depth (mm)	10~16
See Page	G55

Type	KGM
Edge width (mm)	3.0~8.0
Max. grooving depth (mm)	9~25
See Page	G56

Type	KGM-T
Edge width (mm)	2.0~6.0
Max. grooving depth (mm)	17~30
See Page	G57

Type	KG MU
Edge width (mm)	3.0~5.0
Max. grooving depth (mm)	3.5~4.5
See Page	G60

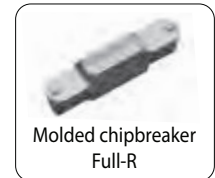
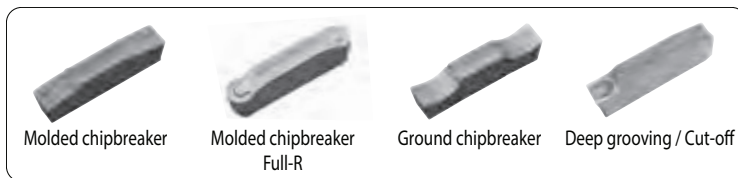

G

Grooving

External

Internal

Face

External grooving of precision parts for automatic lathe

· Coolant-through holders

Type	KGD
Edge width (mm)	2.0 ~ 4.0
Max. grooving depth (mm)	10 ~ 25.5
See Page	G35

Type	KGD-JCTM
Edge width (mm)	2.0 ~ 4.0
Max. grooving depth (mm)	12 ~ 16
See Page	G38

Type	KGM
Edge width (mm)	1.5 ~ 4.0
Max. grooving depth (mm)	10 ~ 16
See Page	G55

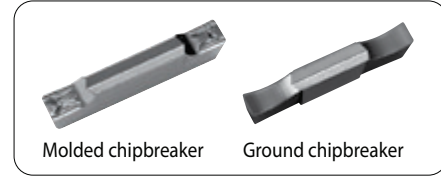
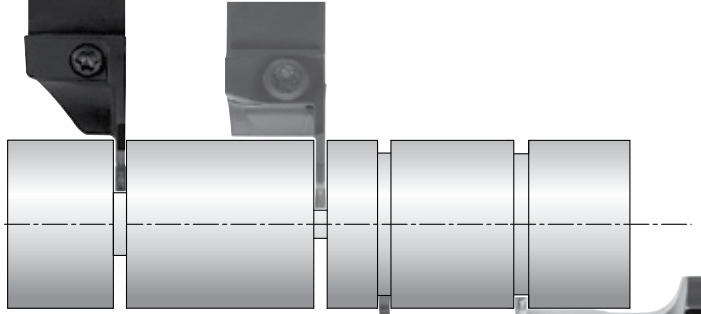

Type	KGBF-F
Edge width (mm)	0.25 ~ 3.0
Max. grooving depth (mm)	0.6 ~ 3.0
See Page	G23

· Coolant-through holders

Type	KGBFS	KGBF-JCTM	S-KGBF
Edge width (mm)	0.25 ~ 3.0	0.25 ~ 3.0	0.25 ~ 3.0
Max. grooving depth (mm)	0.6 ~ 3.0	0.6 ~ 3.0	0.6 ~ 3.0
See Page	G25	G24	G26

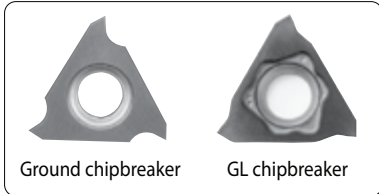

For aluminum wheel external grooving

(External / Facing / Copying)

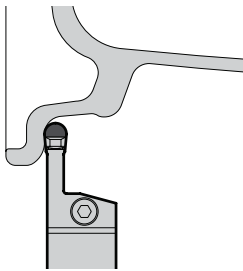

Type	KGMW
Edge width (mm)	6.0 ~ 8.0
Max. grooving depth (mm)	25
See Page	G67

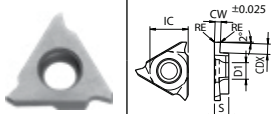

GBA32

Insert	Description	No. of edges	Dimension (mm)					Tolerance (mm)		Carbide					Applicable toolholder G13~G17 G89				
			CW	CDX	IC	S	D1	RE	CW min.	CW max.	PVD		Cermet						
											PR1215	PR1625	PR905	PR930		KW10	PVD		
																	-	PVD	-
	GBA32R 033-005	3	0.33	0.8				0.05	-0.03	+0.02	●	●	●	●	●	●	●	KGBAR...16 KGBAR...16JCT KGBASL...16 KIGBAL...16	
	050-005		0.5	1.2				0.05	0	+0.05	●	●	●	●	●	●	●		
	075-005		0.75	2				0.05	-0.025	+0.025	●	●	●	●	●	●	●		
	095-005		0.95	2				0.05	-0.025	+0.025	●	●	●	●	●	●	●		●
	100-005		1	2				0.05	-0.025	+0.025	●	●	●	●	●	●	●		●
	110-005		1.1	2				0.05	-0.025	+0.025	●	●	●	●	●	●	●		●
	120-005		1.2	2				0.05	-0.025	+0.025	●	●	●	●	●	●	●		●
	125-020		1.25	2				0.2	-0.025	+0.025	●	●	●	●	●	●	●		●
	130-020		1.3	2				0.2	-0.025	+0.025	●	●	●	●	●	●	●		●
	140-020		1.4	2.5				0.2	-0.025	+0.025	●	●	●	●	●	●	●		●
	145-020		1.45	2				0.2	-0.025	+0.025	●	●	●	●	●	●	●		●
												●	●	●	●	●	●		●
	150-020		1.5	2				0.2	-0.025	+0.025	●	●	●	●	●	●	●		●
												●	●	●	●	●	●		●
	160-020		1.6	2.5				0.2	-0.025	+0.025	●	●	●	●	●	●	●		●
	170-020		1.7	2.5				0.2	-0.025	+0.025	●	●	●	●	●	●	●		●
	175-020		1.75	2				0.2	-0.025	+0.025	●	●	●	●	●	●	●		●
												●	●	●	●	●	●		●
	200-020		2	2.5				0.2	-0.025	+0.025	●	●	●	●	●	●	●		●
	225-020		2.25	2.5				0.2	-0.025	+0.025	●	●	●	●	●	●	●		●
	250-020		2.5	2.5				0.2	-0.025	+0.025	●	●	●	●	●	●	●		●
	300-020		3	2.5	9.525	3.18	4.4	0.2	-0.025	+0.025	●	●	●	●	●	●	●		●
	GBA32L 033-005		3	0.33	0.8				0.05	-0.03	+0.02	●	●	●	●	●	●		●
	050-005			0.5	1.2				0.05	0	+0.05	●	●	●	●	●	●		●
	075-005			0.75	2				0.05	-0.025	+0.025	●	●	●	●	●	●		●
	095-005			0.95	2				0.05	-0.025	+0.025	●	●	●	●	●	●		●
	100-005			1	2				0.05	-0.025	+0.025	●	●	●	●	●	●		●
	110-005			1.1	2				0.05	-0.025	+0.025	●	●	●	●	●	●		●
	120-005			1.2	2				0.05	-0.025	+0.025	●	●	●	●	●	●		●
	125-020			1.25	2				0.2	-0.025	+0.025	●	●	●	●	●	●		●
	130-020			1.3	2				0.2	-0.025	+0.025	●	●	●	●	●	●		●
	140-020			1.4	2.5				0.2	-0.025	+0.025	●	●	●	●	●	●		●
	145-020			1.45	2				0.2	-0.025	+0.025	●	●	●	●	●	●		●
											●	●	●	●	●	●	●		
150-020			1.5	2				0.2	-0.025	+0.025	●	●	●	●	●	●	●		
											●	●	●	●	●	●	●		
160-020			1.6	2.5				0.2	-0.025	+0.025	●	●	●	●	●	●	●		
170-020			1.7	2.5				0.2	-0.025	+0.025	●	●	●	●	●	●	●		
175-020			1.75	2				0.2	-0.025	+0.025	●	●	●	●	●	●	●		
											●	●	●	●	●	●	●		
200-020			2	2.5				0.2	-0.025	+0.025	●	●	●	●	●	●	●		
225-020			2.25	2.5				0.2	-0.025	+0.025	●	●	●	●	●	●	●		
250-020			2.5	2.5				0.2	-0.025	+0.025	●	●	●	●	●	●	●		
300-020			3	2.5				0.2	-0.025	+0.025	●	●	●	●	●	●	●		

Right-hand shown
 CDX shows available grooving depth.

Recommended cutting conditions G141

● : Standard item R : Right-hand only L : Left-hand only □ : Check availability

GBA32

		Material										Toolholder			
		Carbon steel / Alloy steel										●	●	●	P
		Stainless steel										●	●	●	M
		Cast iron										●	●	●	K
		Non-ferrous metals										●	●	●	N
		Titanium alloy										●	●	●	S
		Hard materials (~ 40HRC)										●	●	●	H
		Hard materials (40HRC ~)										●	●	●	
Insert	Description	No. of edges	Dimension (mm)						Tolerance (mm)		Carbide / Cermets / PCD			Applicable toolholder G13~G17 G89	
			CW	CDX	IC	S	D1	RE	LE	CW min.	CW max.	PVD	-		-
												PR1715	PR1625		TiN620
	GBA32R 050-005F	3	0.5	1	9.525	3.18	4.4	0.05	-	0	+0.05	●	●	●	KGBAR...16 KGBAR...16JCT KGBASL...16 KIGBAL...16
	075-005F		0.75	2				0.05		-0.025	+0.025	●	●	●	
	095-005F		0.95	2				0.05		-0.025	+0.025	●	●	●	
	100-005F		1	2				0.05		-0.025	+0.025	●	●	●	
	125-020F		1.25	2				0.2		-0.025	+0.025	●	●	●	
	145-020F		1.45	2				0.2		-0.025	+0.025	●	●	●	
	150-020F		1.5	2				0.2		-0.025	+0.025	●	●	●	
	175-020F		1.75	2				0.2		-0.025	+0.025	●	●	●	
	200-020F		2	2.5				0.2		-0.025	+0.025	●	●	●	
	250-020F		2.5	2.5				0.2		-0.025	+0.025	●	●	●	
	GBA32L 050-005F		0.5	1				0.05		0	+0.05	●	●	●	
	075-005F		0.75	2				0.05		-0.025	+0.025	●	●	●	
	095-005F		0.95	2				0.05		-0.025	+0.025	●	●	●	
	100-005F		1	2				0.05		-0.025	+0.025	●	●	●	
125-020F	1.25	2	0.2	-0.025	+0.025	●	●	●							
145-020F	1.45	2	0.2	-0.025	+0.025	●	●	●							
150-020F	1.5	2	0.2	-0.025	+0.025	●	●	●							
175-020F	1.75	2	0.2	-0.025	+0.025	●	●	●							
200-020F	2	2.5	0.2	-0.025	+0.025	●	●	●							
250-020F	2.5	2.5	0.2	-0.025	+0.025	●	●	●							
	GBA32R 200-100R	3	2	2.5	9.525	3.18	4.4	1	-	-0.025	+0.025	●	●	KGBAR...16 KGBAR...16JCT KGBASL...16 KIGBAL...16	
	300-150R		3					1.5				●	●		
	GBA32R 125-010	1	1.25	2	9.525	3.18	4.4	0.1	1.7	-0.03	+0.03	●	●	KGBAR...16 KGBAR...16JCT KGBASL...16 KIGBAL...16	
	150-010		1.5	2				●				●			
	200-010		2	2.5				●				●			

Right-hand shown
CDX shows available grooving depth.

Recommended cutting conditions G141



Grooving

● : Standard item R : Right-hand only L : Left-hand only □ : Check availability

CBN & PCD Inserts are sold in 1 piece boxes

GBA43

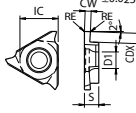
Insert		Description		Dimension (mm)							Tolerance (mm)		Carbide					Cermet	Applicable toolholder G13~G17 G89			
				No. of edges	CW	CDX	IC	S	D1	RE	CW min.	CW max.	PVD			-		PVD		-		
													PR1215	PR1625	PR905	PR930	KW10				PV7040	TN90
		Carbon steel / Alloy steel							●	●	●	●	●	●	●	●	●	P				
		Stainless steel							●	●	●	●	●	●	●	●	●	M				
		Cast iron							●	●	●	●	●	●	●	●	●	K				
		Non-ferrous metals							●	●	●	●	●	●	●	●	●	N				
		Titanium alloy							●	●	●	●	●	●	●	●	●	S				
		Hard materials (~ 40HRC)							●	●	●	●	●	●	●	●	●	H				
		Hard materials (40HRC ~)							●	●	●	●	●	●	●	●	●	H				
 	GBA43R	125-010	1.25	2		4.76		0.1			●	●										
		125-020	1.25	2		4.76		0.2			●	●	●	●	●	●	●	●				
		140-020	1.4	3.5		4.76		0.2			●	●	●	●	●	●	●	●				
		145-020	1.45	2		4.76		0.2			●	●	●	●	●	●	●	●				
		150-010	1.5	3.5		4.76		0.1			●	●	●	●	●	●	●	●				
		150-020	1.5	3.5		4.76		0.2			●	●	●	●	●	●	●	●				
		170-020	1.7	3.5		4.76		0.2			●	●	●	●	●	●	●	●				
		175-020	1.75	3.5		4.76		0.2			●	●	●	●	●	●	●	●				
		185-020	1.85	3.5		4.76		0.2			●	●	●	●	●	●	●	●				
		195-020	1.95	3.5		4.76		0.2			●	●	●	●	●	●	●	●				
		200-010	2	3.5		4.76		0.1			●	●	●	●	●	●	●	●				
		200-020	2	3.5		4.76		0.2			●	●	●	●	●	●	●	●				
		225-020	2.25	3.5		4.76		0.2			●	●	●	●	●	●	●	●				
		230-020	2.3	3.5		4.76		0.2			●	●	●	●	●	●	●	●				
		250-010	2.5	5		4.76		0.1			●	●	●	●	●	●	●	●		*1		
		250-030	3	2.5	4	12.7	4.76	5.5	0.3	-0.025	+0.025	●	●	●	●	●	●	●		*2		
		265-030	2.65	4	5		4.76		0.3			●	●	●	●	●	●	●		*1		
		280-030	2.8	4	5		4.76		0.3			●	●	●	●	●	●	●		*2		
		300-010	3	5		4.76		0.1				●	●	●	●	●	●	●		*1		
		300-030	3	4	5		4.76		0.3			●	●	●	●	●	●	●		*2		
		325-030	3.25	5		4.76		0.3				●	●	●	●	●	●	●		*1		
		330-030	3.3	4	5		4.76		0.3			●	●	●	●	●	●	●		*2		
		350-010	3.5	5		4.76		0.1				●	●	●	●	●	●	●		*1		
		350-030	3.5	5		4.76		0.3				●	●	●	●	●	●	●		*2		
		400-010	4	5		4.76		0.1				●	●	●	●	●	●	●		*1		
		400-040	4	5		4.76		0.4				●	●	●	●	●	●	●		*2		
		430-040	4.3	5		4.76		0.4				●	●	●	●	●	●	●		*1		
		450-040	4.5	5		4.76		0.4				●	●	●	●	●	●	●		*2		
480-040	4.8	5		5		0.4				●	●	●	●	●	●	●		*1				

Right-hand shown

CDX shows available grooving depth.

*1 : KGBAR...22-25T5, KGBAR...22-25JCT, KGBASL...22-25T5, KIGBAL...22

*2 : KGBAR...22-25, KGBAR...22-25T5, KGBAR...22-25JCT, KGBASL...22-25, KGBASL...22-25T5, KIGBAL...22

Recommended cutting conditions G141

● : Standard item R : Right-hand only L : Left-hand only □ : Check availability

GBA43

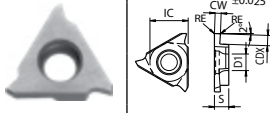
		Material compatibility											P			
		Carbon steel / Alloy steel											●	●		
		Stainless steel											●	●		
		Cast iron											●	●		
		Non-ferrous metals											●	●		
		Titanium alloy											●	●		
		Hard materials (~ 40HRC)											●	○		
		Hard materials (40HRC ~)											●	○		
Insert	Description	No. of edges	Dimension (mm)					Tolerance (mm)		Carbide			Cermet		Applicable toolholder G13~G17 G89	
			CW	CDX	IC	S	D1	RE	CW min.	CW max.	PVD			-		
											PR1215	PR1625	PR905	PR930		KW10
	GBA43L 125-010		1.25	2		4.76	0.1			●	●	●	●	●		
	125-020		1.25	2		4.76	0.2			●	●	●	●	●		
	140-020		1.4	3.5		4.76	0.2			●	●	●	●	●		
	145-020		1.45	2		4.76	0.2			●	●	●	●	●		
	150-010		1.5	3.5		4.76	0.1			●	●	●	●	●		
	150-020		1.5	3.5		4.76	0.2			●	●	●	●	●		
	170-020		1.7	3.5		4.76	0.2			●	●	●	●	●		
	175-020		1.75	3.5		4.76	0.2			●	●	●	●	●		
	185-020		1.85	3.5		4.76	0.2			●	●	●	●	●		
	195-020		1.95	3.5		4.76	0.2			●	●	●	●	●		
	200-010		2	3.5		4.76	0.1			●	●	●	●	●		
	200-020		2	3.5		4.76	0.2			●	●	●	●	●		
	225-020		2.25	3.5		4.76	0.2			●	●	●	●	●		
	230-020		2.3	3.5		4.76	0.2			●	●	●	●	●		
	250-010		2.5	5		4.76	0.1			●	●	●	●	●		
	250-030	3	2.5	4	12.7	4.76	5.5	0.3	-0.025	+0.025	●	●	●	●	●	*3
	265-030		2.65	4		4.76	0.3				●	●	●	●	●	*4
	280-030		2.8	5		4.76	0.3				●	●	●	●	●	*3
	300-010		3	5		4.76	0.1				●	●	●	●	●	*4
	300-030		3	4		4.76	0.3				●	●	●	●	●	*3
	330-030		3.3	4		4.76	0.3				●	●	●	●	●	*4
	350-010		3.5	5		4.76	0.1				●	●	●	●	●	*3
	350-030		3.5	5		4.76	0.3				●	●	●	●	●	*4
	400-010		4	5		4.76	0.1				●	●	●	●	●	*3
400-040		4	5		4.76	0.4				●	●	●	●	●	*4	
430-040		4.3	5		4.76	0.4				●	●	●	●	●	*3	
450-040		4.5	5		4.76	0.4				●	●	●	●	●	*4	
480-040		4.8	5		5	0.4				●	●	●	●	●	*3	

Right-hand shown

CDX shows available grooving depth.

*3 : KGBAL...22-25T5, KGBAL...22-25JCT, KGBASR...22-25T5, KIGBAR...22

*4 : KGBAL...22-25, KGBAL...22-25T5, KGBAL...22-25JCT, KGBASR...22-25, KGBASR...22-25T5, KIGBAR...22

Recommended cutting conditions G141

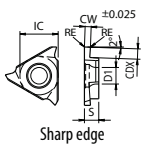

GBA43

		Carbon steel / Alloy steel										●	P			
		Stainless steel											M			
		Cast iron											K			
		Non-ferrous metals											N			
		Titanium alloy											S			
		Hard materials (~ 40HRC)											H			
		Hard materials (40HRC ~)														
Insert	Description	No. of edges	Dimension (mm)							Tolerance (mm)		Cermetal	Applicable toolholder ➔ G13~G17 G89			
			CW	CDX	IC	S	D1	RE	LE	CW min.	CW max.			Ti620		
	GBA43R	125-020F	1.25	2		4.76			0.2						●	KGBAR...22-15 KGBAR...22-15JCT KGBASL...22-15 KIGBAL...22
	145-020F	1.45	2		4.76			0.2					●			
	150-020F	1.5	3.5		4.76			0.2					●			
	175-020F	1.75	3.5		4.76			0.2					●			
	185-020F	1.85	3.5		4.76			0.2					●			
	200-020F	2	3.5		4.76			0.2					●			
	230-020F	2.3	3.5		4.76			0.2					●			
	250-030F	2.5	4		4.76			0.3					●			
	265-030F	2.65	4		4.76			0.3					●			
	280-030F	2.8	4		4.76			0.3					●	*2		
	300-030F	3	4		4.76			0.3					●			
	330-030F	3.3	4		4.76			0.3					●			
	350-030F	3.5	5		4.76			0.3					●			
	400-040F	4	5		4.76			0.4					●			
	430-040F	4.3	5		4.76			0.4					●			
	450-040F	4.5	5	12.7	4.76	5.5		0.4	-	-0.025	+0.025		●	KGBAR...22-35 KGBAR...22-35JCT KGBASL...22-35 KIGBAL...22		
	480-040F	4.8	5		5			0.4					●			
	GBA43L	125-020F	1.25	2				0.2					●			
	145-020F	1.45	2					0.2					●			
	150-020F	1.5	3.5					0.2					●	KGBAL...22-15 KGBAL...22-15JCT		
	175-020F	1.75	3.5					0.2					●			
	185-020F	1.85	3.5					0.2					●	KGBASR...22-15 KIGBAR...22		
	200-020F	2	3.5					0.2					●			
	230-020F	2.3	3.5		4.76			0.2					●			
	250-030F	2.5	4					0.3					●			
	265-030F	2.65	4					0.3					●			
	280-030F	2.8	4					0.3					●	*4		
	300-030F	3	4					0.3					●			
330-030F	3.3	4					0.3					●				
350-030F	3.5	5					0.3					●				
400-040F	4	5					0.4					●	*6			

Right-hand shown

Recommended cutting conditions ➔ G141

CDX shows available grooving depth.



*2 : KGBAR...22-25, KGBAR...22-25T5, KGBAR...22-25JCT, KGBASL...22-25, KGBASL...22-25T5, KIGBAL...22

*4 : KGBAL...22-25, KGBAL...22-25T5, KGBAL...22-25JCT, KGBASR...22-25, KGBASR...22-25T5, KIGBAR...22

*6 : KGBAL...22-35, KGBAL...22-35JCT, KGBASR...22-35, KIGBAR...22

● : Standard item R : Right-hand only L : Left-hand only □ : Check availability

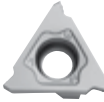
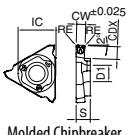
GBA43

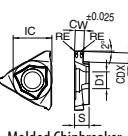
				Carbon steel / Alloy steel											P
				Stainless steel											M
				Cast iron											K
				Non-ferrous metals											N
				Titanium alloy											S
				Hard materials (~ 40HRC)							●				H
				Hard materials (40HRC ~)											
Insert	Description	No. of edges	Dimension (mm)						Tolerance (mm)		Carbi-	Cer-	Applicable toolholder ➔ G13~G17 G89		
			CW	CDX	IC	S	D1	RE	CW min.	CW max.	PVD	-			
											PR1215	PR1625		TN620	TN6020
  <p>Molded Chipbreaker</p>	GBA43R	3	140-010GM	1.4	3.5				0.1			●	●	KGBAR...22-15 KGBAR...22-15JCT KGBASL...22-15 KIGBAL...22	
			150-020GM	1.5	3.5				0.2			●	●		
			175-020GM	1.75	3.5				0.2			●	●		
			185-020GM	1.85	3.5				0.2			●	●		
			200-020GM	2	3.5				0.2			●	●		
			230-020GM	2.3	3.5				0.2			●	●		
			250-030GM	2.5	5				0.3			●	●		
			265-030GM	2.65	5				0.3			●	●		
			300-030GM	3	5				0.3			●	●		
			330-030GM	3.3	5				0.3			●	●		
	350-030GM	3.5	5				0.3			●	●				
	400-040GM	4	5				0.4			●	●				
	GBA43L	140-010GM	3	1.4	3.5	12.7	4.76	5.5	0.1	-0.025	+0.025	●	●	KGBAL...22-15 KGBAL...22-15JCT KGBASR...22-15 KIGBAR...22	
	150-020GM	1.5	3.5				0.2			●	●				
	175-020GM	1.75	3.5				0.2			●	●				
	185-020GM	1.85	3.5				0.2			●	●				
	200-020GM	2	3.5				0.2			●	●				
	230-020GM	2.3	3.5				0.2			●	●				
	250-030GM	2.5	5				0.3			●	●				
	265-030GM	2.65	5				0.3			●	●				
300-030GM	3	5				0.3			●	●					
330-030GM	3.3	5				0.3			●	●					
350-030GM	3.5	5				0.3			●	●					
400-040GM	4	5				0.4			●	●					
  <p>Molded Chipbreaker</p>	GBA43R	3	175-020MY	1.75	3.5				0.2			●	●	KGBAR...22-15 KGBAR...22-15JCT KGBASL...22-15 KIGBAL...22	
			185-020MY	1.85	3.5				0.2			●	●		
			200-020MY	2	3.5				0.2			●	●		
			230-020MY	2.3	3.5				0.2			●	●		
			250-030MY	2.5	5				0.3			●	●		
			265-030MY	2.65	5				0.3			●	●		
			300-030MY	3	5				0.3			●	●		
			330-030MY	3.3	5				0.3			●	●		
			350-030MY	3.5	5				0.3			●	●		
			400-040MY	4	5				0.4			●	●		
	GBA43L	175-020MY	3	1.75	3.5	12.7	4.76	5.5	0.2	-0.025	+0.025	●	●	KGBAL...22-15 KGBAL...22-15JCT KGBASR...22-15 KIGBAR...22	
	185-020MY	1.85	3.5				0.2			●	●				
	200-020MY	2	3.5				0.2			●	●				
	230-020MY	2.3	3.5				0.2			●	●				
	250-030MY	2.5	5				0.3			●	●				
	265-030MY	2.65	5				0.3			●	●				
	300-030MY	3	5				0.3			●	●				
	350-030MY	3.5	5				0.3			●	●				
	400-040MY	4	5				0.4			●	●				

Right-hand shown

CDX shows available grooving depth.

*2 : KGBAR...22-25, KGBAR...22-25T5, KGBAR...22-25JCT, KGBASL...22-25, KGBASL...22-25T5, KIGBAL...22

*4 : KGBAL...22-25, KGBAL...22-25T5, KGBAL...22-25JCT, KGBASR...22-25, KGBASR...22-25T5, KIGBAR...22

*5 : KGBAR...22-35, KGBAR...22-35JCT, KGBASL...22-35, KIGBAL...22

*6 : KGBAL...22-35, KGBAL...22-35JCT, KGBASR...22-35, KIGBAR...22





Recommended cutting conditions ➔ G141

● : Standard item R : Right-hand only L : Left-hand only □ : Check availability



Grooving

GBA43

Insert		Description		Edge preparation type		Dimension (mm)						Tolerance (mm)		Carbide		Cermet		CBN	PCD	Applicable toolholder G13~G17 G89	
				No. of edges	CW	CDX	IC	S	D1	RE	LE	CW min.	CW max.	PVD		- PVD	- Cermet	- CBN	- PCD		
														PR1215	PR1625						PR905
						Carbon steel / Alloy steel						● ●		● ●						P	
						Stainless steel						● ●		● ●						M	
						Cast iron						● ●		● ●						K	
						Non-ferrous metals						● ●		● ●						N	
						Titanium alloy						● ●		● ●						S	
						Hard materials (~ 40HRC)						● ●		● ●						H	
						Hard materials (40HRC ~)						● ●		● ●						H	
 <p>Full R / Copying</p>	GBA43R	100-050R	1	2				0.5						●	●	●	●			KGBAR...22-15 KGBAR...22-15JCT KGBASL...22-15 KIGBAL...22	
		150-075R	1.5	3.5				0.75							●	●	●	●			
		200-100R	2	3.5				1							●	●	●	●			
		250-125R	2.5	4				1.25							●	●	●	●			
		300-150R	3	4				1.5							●	●	●	●			
		400-200R	4	5				2							●	●	●	●			
	GBA43L	100-050R	-	3	1	2	12.7	4.76	5.5	0.5	-	-0.025	+0.025		●	●	●	●			KGBAL...22-15 KGBAL...22-15JCT KGBASR...22-15 KIGBAR...22
		150-075R			1.5	3.5				0.75					●	●	●	●			
		200-100R			2	3.5				1					●	●	●	●			
		250-125R			2.5	4				1.25					●	●	●	●			
		300-150R			3	4				1.5					●	●	●	●			
		400-200R			4	5				2					●	●	●	●			
 <p>Full R / Copying / Sharp edge</p>	GBA43R	100-050RF	1	2				0.5								●	●			KGBAR...22-15 KGBAR...22-15JCT KGBASL...22-15 KIGBAL...22	
		150-075RF	1.5	3.5				0.75									●	●			
		200-100RF	2	3.5				1									●	●			
		250-125RF	2.5	4				1.25									●	●			
		300-150RF	3	4				1.5									●	●			
		400-200RF	F	3	4	5	12.7	4.76	5.5	2	-	-0.025	+0.025				●	●			
	GBA43L	100-050RF			1	2				0.5								●	●		KGBAL...22-15 KGBAL...22-15JCT KGBASR...22-15 KIGBAR...22
		150-075RF			1.5	3.5				0.75								●	●		
		200-100RF			2	3.5				1								●	●		
		250-125RF			2.5	4				1.25								●	●		
		300-150RF			3	4				1.5								●	●		
 <p>1-edge</p>	GBA43R	125-020	1.25	2												●	●			KGBAR...22-15 KGBAR...22-15JCT KGBASL...22-15 KIGBAL...22	
		150-020	1.5	3.5													●	●			
		200-020	2	3.5													●	●			
		250-020	2.5	4													●	●			
		300-020	3	4													●	●			
			E008	1	1.25	2	12.7	4.76	5.5	0.2	1.9	-0.03	+0.03					●	●		
	GBA43L	125-020			1.25	2												●	●		KGBAL...22-15 KGBAL...22-15JCT KGBASR...22-15 KIGBAR...22
		150-020			1.5	3.5												●	●		
		200-020			2	3.5												●	●		
		250-020			2.5	4												●	●		
		300-020			3	4												●	●		
 <p>1-edge</p>	GBA43R	125-010	1.25	2													●	●		KGBAR...22-15 KGBAR...22-15JCT KGBASL...22-15 KIGBAL...22	
		150-010	1.5	3.5														●	●		
		200-010	2	3.5														●	●		
		250-010	2.5	4														●	●		
		300-010	3	4														●	●		
			F	1	1.25	2	12.7	4.76	5.5	0.1	1.9	-0.03	+0.03					●	●		
	GBA43L	125-010			1.25	2													●	●	KGBAL...22-15 KGBAL...22-15JCT KGBASR...22-15 KIGBAR...22
		150-010			1.5	3.5													●	●	
		200-010			2	3.5													●	●	
		250-010			2.5	4													●	●	
		300-010			3	4													●	●	

Right-hand shown

CDX shows available grooving depth.

*2 : KGBAR...22-25, KGBAR...22-25T5, KGBAR...22-25JCT, KGBASL...22-25, KGBASL...22-25T5, KIGBAL...22

*4 : KGBAL...22-25, KGBAL...22-25T5, KGBAL...22-25JCT, KGBASR...22-25, KGBASR...22-25T5, KIGBAR...22

*5 : KGBAR...22-35, KGBAR...22-35JCT, KGBASL...22-35, KIGBAL...22

*6 : KGBAL...22-35, KGBAL...22-35JCT, KGBASR...22-35, KIGBAR...22

Recommended cutting conditions G141

● : Standard item R : Right-hand only L : Left-hand only □ : Check availability

CBN & PCD Inserts are sold in 1 piece boxes

KGBA (External grooving / Shallow grooving)

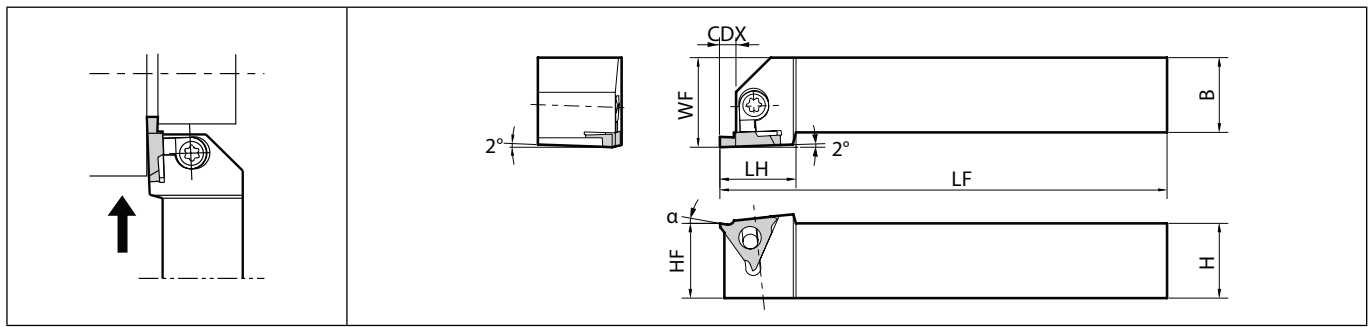

Right-hand shown | Right-hand Insert for Right-hand Toolholder, Left-hand Insert for Left-hand Toolholder.

Toolholder dimensions

Description	Availability		Dimension (mm)								Spare parts		Applicable inserts G6~G12			
											Clamp set	Wrench				
	R	L	CDX	H	B	LH	HF	LF	WF							
KGBA ^{R/L} 2020K-16 2525M-16	●	●	2.5	20	20	24	20	125	25	25	25	150	30	LGBA-16 ^{R/L} S	FT-15	GBA32 ^{R/L} type
KGBA ^{R/L} 2020H22-15 2020H22-25 2020H22-35 2020K22-15 2020K22-25 2020K22-25T5 2020K22-35 2525M22-15 2525M22-25 2525M22-25T5 2525M22-35	●	●	4	20	20	25.5	20	125	25	25	150	30	100	LGBA-22RS	FT-15	GBA43 ^{R/L} type
	●	●	4.5													
	●	●	5.5													
	●	●	4													
	●	●	4.5													
	●	●	5.5													
	●	●	4													
	●	●	4.5													
	●	●	5.5													
	●	●	5.5													

CDX shows the distance from the toolholder to the cutting edge. Available Groove Depth : „CDX“ of Insert.
Clamp Set : LGBA-○○RS for Right-hand Toolholder and LGBA-○○LS for Left-hand Toolholder.

Rake Angle (α) after Installment of GBA insert

GBA32 ^{R/L} ○○○-○○○		GBA43 ^{R/L} ○○○-○○○		GBA43 ^{R/L} ○○○-○○○R (Full-R)		
α	Insert Grades	α	Insert Grades	α	Insert Grades	Full-R Description
10°	TN620, TN90, PV7040 PR930, PR1215, PR1625, PR905 KPD001, KPD010	0°	KBN510, KBN525	10°	TN620, TN90, PV7040, PR930 PR1215, PR1625, PR905	050R~150R
		10°	TN620, TC40, TN90, PV7040 PR930, PR1215, PR1625, PR905 KPD001, KPD010		TN620, TN90, PV7040, PR930 PR1215, PR1625, PR905	200R
20°	KW10	20°	KW10	14°	KW10	050R~200R

Rake Angle (α) after Installment of GBA-GM insert

α	Insert Description
10°	GBA43 ^{R/L} 150-020GM
15°	GBA43 ^{R/L} 175-020GM
	GBA43 ^{R/L} 265-030GM
12°	GBA43 ^{R/L} 300-030GM
	GBA43 ^{R/L} 400-040GM

α indicates the rake angle at the center of the edge width, after installing insert.

Rake Angle (α) after Installment of GBA-MY insert

α	Insert Description
15°	GBA43 ^{R/L} 175-020MY
	GBA43 ^{R/L} 350-030MY
14°	GBA43 ^{R/L} 400-040MY

α indicates the rake angle at the center of the edge width, after installing insert.

● : Standard item R : Right-hand only L : Left-hand only □ : Check availability



KGBAS (External grooving / Shallow grooving)

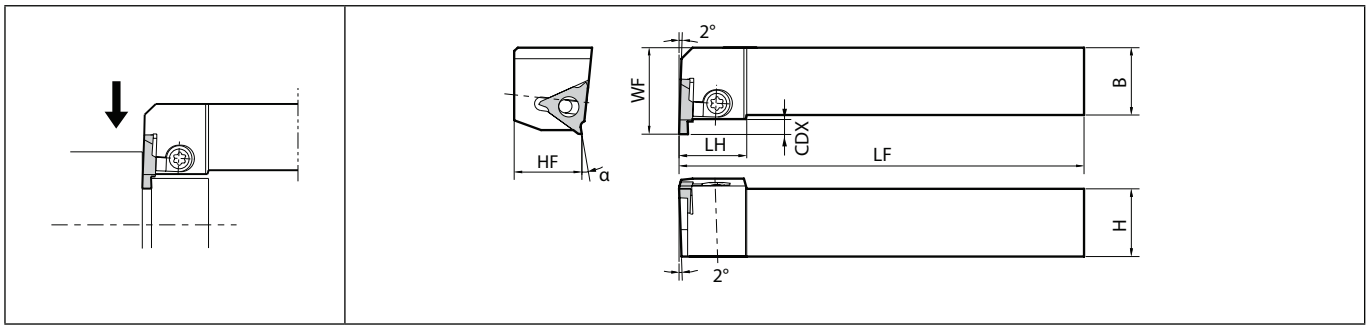

Right-hand shown | Left-hand Insert for Right-hand Toolholder, Right-hand Insert for Left-hand Toolholder.

Toolholder dimensions

Description	Availability		Dimension (mm)								Spare parts		Applicable inserts G6~G12
											Clamp set	Wrench	
	R	L	CDX	H	B	LH	HF	LF	WF				
KGBAS [®] /L 2020K-16 2525M-16	●	●	2.5	20	20	25	20	125	25	LGBA-16 ¹ / _r S	FT-15	GBA32 ¹ / _r type	
	●	●		25	25		25	150	30				
KGBAS [®] /L 2020K22-15 2020K22-25 2020K22-25T5 2020K22-35 2525M22-15 2525M22-25 2525M22-25T5 2525M22-35	●	●	4	20	20	25	20	125	27	LGBA-22 ¹ / _r S	FT-15	GBA43 ¹ / _r type	
	●	●											4.5
	●	●	5.5	25	25	25	150	32					
	●	●							4				
	●	●	4.5										
	●	●	5.5	25	25	25	150	32					
	●	●							4				
	●	●	4.5										
●	●	5.5											

CDX shows the distance from the toolholder to the cutting edge. Available Groove Depth : „CDX“ of Insert.

See Page G13 for Rake Angle (α) after Installment of Insert.

Clamp Set : LGBA-○○LS for Right-hand Toolholder and LGBA-○○RS for Left-hand Toolholder.

G

Grooving

External

Internal

Face

● : Standard item R : Right-hand only L : Left-hand only □ : Check availability

KGBA-JCT (External grooving / Shallow grooving, Coolant-through holder)

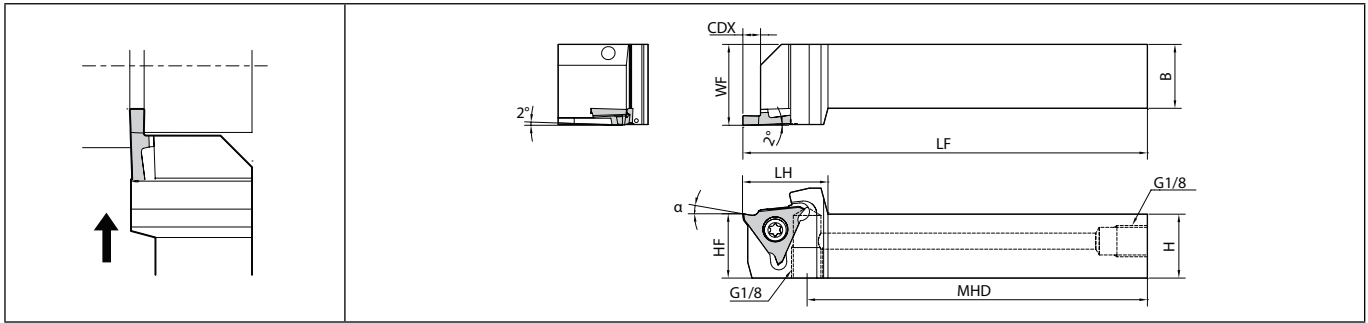

Right-hand shown | Right-hand Insert for Right-hand Toolholder, Left-hand Insert for Left-hand Toolholder.

Toolholder dimensions

Description	Availability		Dimension (mm)									Coolant hole	Spare parts				Applicable inserts ➔ G6~G12		
													Plug	Screw	Wrench	Wrench			
	R	L	CDX	H	B	LH	MHD	HF	LF	WF									
KGBA%L 2020K-16JCT 2525K-16JCT	●	●	2.5	20	20	24	107.5	20	125	25	Yes				-	GBA32%L type			
	●	●		25	25			25	30										
KGBA%L 2020K22-15JCT 2020K22-25JCT 2020K22-35JCT 2525K22-15JCT 2525K22-25JCT 2525K22-35JCT	●	●	4	20	20	26.5	105	20	125	25	Yes				LTW-20	GBA43%L type			
	●	●															5.5	25	25
	●	●	4	25	25			30											
	●	●							5.5	25									
	●	●	4	25	25			30											
	●	●							5.5	25							25	30	

CDX shows the distance from the toolholder to the cutting edge. Available Groove Depth : „CDX“ of Insert.

See Page G13 for Rake Angle (α) after Installment of Insert.

KGBA-JCT toolholder is screw clamp type.

Please see page H16 and H17 for piping parts of coolant-through holders.



KGB (External grooving / Shallow grooving)

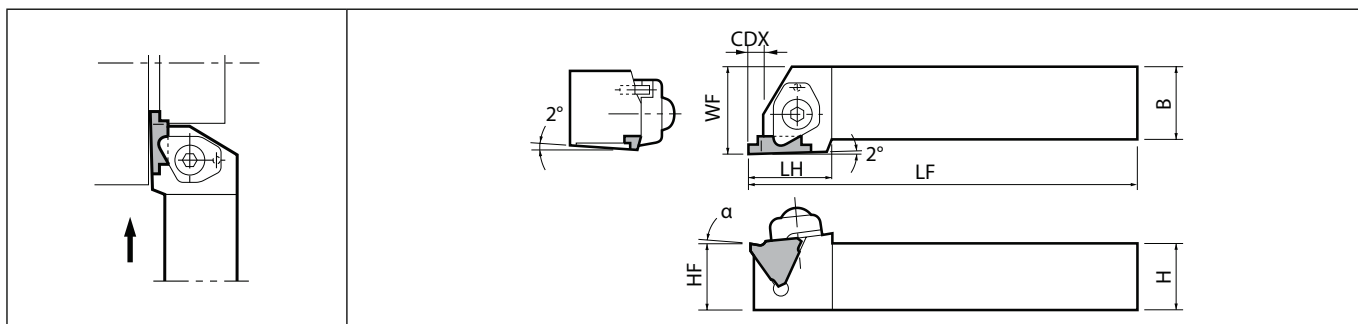

Right-hand shown | Right-hand Insert for Right-hand Toolholder, Left-hand Insert for Left-hand Toolholder.

Toolholder dimensions

Description	Availability		Dimension (mm)								Spare parts				Applicable inserts G6~G12			
											Clamp	Clamp bolt	Spring	Wrench				
	R	L	CDX	H	B	LH	HF	LF	WF									
KGB ^{R/L} 2020K-16 2525M-16	●	●	2.5	20	20	24	20	125	25	25	25	150	30	CGB ^{R/L}	BH6X25	SP-6	LW-4	GBA32 ^{R/L} type
KGB ^{R/L} 2020K22-15 2020K22-25 2020K22-35	●	●	4	20	20	25.5	20	125	25	CGB ^{R/L}	BH6X25	SP-6	LW-4	GBA43 ^{R/L} type				
2525M22-15 2525M22-25 2525M22-35	●	●	4.5												5.5	4	4.5	5.5

KGB will be switched to KGBA=> **G13**

CDX shows the distance from the toolholder to the cutting edge. Available Groove Depth : „CDX“ of Insert.

KGB Clamp : CGBR for Right-hand Toolholder and CGBL for Left-hand Toolholder.

Alternative Toolholder Reference Table

KGBA	←	(KGB)
KGBA ^{R/L} ...22-15		KGB ^{R/L} ...22-15
KGBA ^{R/L} ...22-25		KGB ^{R/L} ...22-25
KGBA ^{R/L} ...22-35		KGB ^{R/L} ...22-35
KGBA ^{R/L} ...22-25T5		KGB ^{R/L} ...22-25 (Available grooving depth has a limit)

· Short shank type is not available for KGB / KGBS.

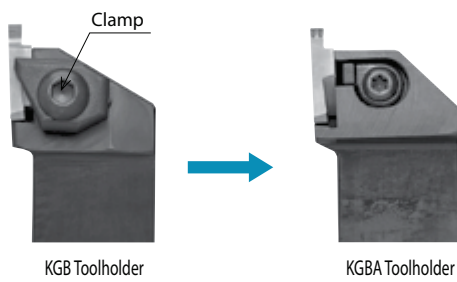

* KGB / KGBS toolholder will be switched to KGBA / KGBAS.
Better Chip flow.

● : Standard item R : Right-hand only L : Left-hand only □ : Check availability

KGBS (External grooving / Shallow grooving)

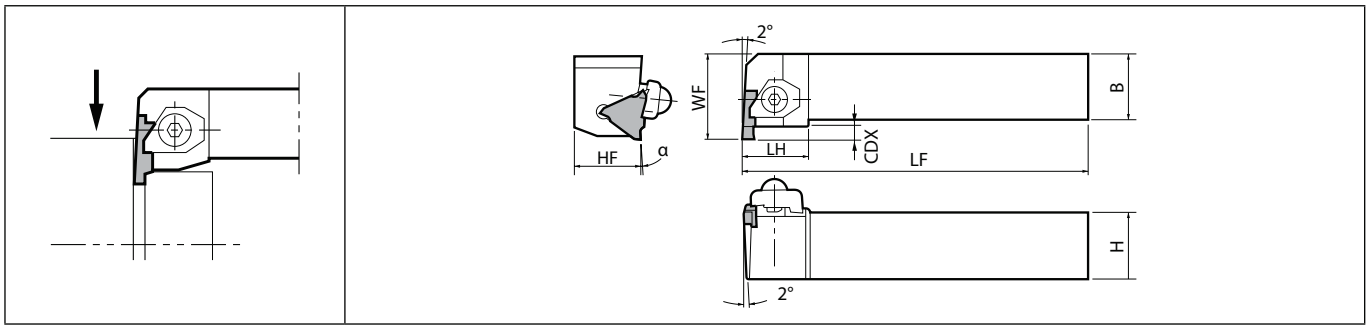

Right-hand shown | Left-hand Insert for Right-hand Toolholder, Right-hand Insert for Left-hand Toolholder.

Toolholder dimensions

Description	Availability		Dimension (mm)								Spare parts				Applicable inserts ➔ G6~G12
											Clamp	Clamp bolt	Spring	Wrench	
	R	L	CDX	H	B	LH	HF	LF	WF						
KGBS ^{R/L} 2020K-16 2525M-16	●	●	2.5	20	20	25	20	125	25	CGB ^R	BH6X25	SP-6	LW-4	GBA32 ^R type	
	●	●		25	25		25	150	30						
KGBS ^{R/L} 2020K22-15 2020K22-25 2020K22-35 2525M22-15 2525M22-25 2525M22-35	●	●	4	20	20	25	20	125	27	CGB ^R	BH6X25	SP-6	LW-4	GBA43 ^R type	
	●	●													4.5
	●	●	5.5												
	●	●	4												
	●	●	4.5												
	●	●	5.5												

KGBS will be switched to KGBAS=> G14

KGBS Clamp : CGBL for Right-hand Toolholder and CGBR for Left-hand Toolholder.

Alternative Toolholder Reference Table

KGBAS	←	(KGBS)
KGBAS ^{R/L} ...22-15		KGBS ^{R/L} ...22-15
KGBAS ^{R/L} ...22-25		KGBS ^{R/L} ...22-25
KGBAS ^{R/L} ...22-35		KGBS ^{R/L} ...22-35
KGBAS ^{R/L} ...22-25T5		KGBS ^{R/L} ...22-25 (Available grooving depth has a limit)

● : Standard item R : Right-hand only L : Left-hand only □ : Check availability



GBF (for automatic lathe)

High precision with edge width tolerance of ± 0.02 mm
 High efficiency MEGACOAT coating technology for long tool life

1 Stable chip control with GL chipbreaker

GL Chipbreaker controls chips stable at both grooving and turning.
 (Turning is not recommended for GBF32R075-005GL)

G

Grooving

External

Internal

Face

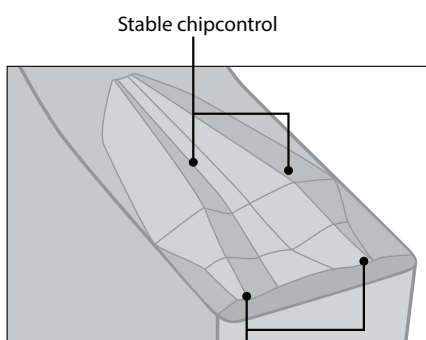

Chips are short, curled and break evenly in low feed machining.
 Prevents chip clogging.

Chip control comparison (internal evaluation)

	GL chipbreaker	Competitor A
Grooving f = 0.05 mm/rev d = 1.5 mm		
Turning f = 0.04 mm/rev ap = 0.2 mm		

Cutting conditions: $V_c = 80$ m/min, edge width 1 mm
 Workpiece material : X5CrNi18 10

2 Good surface finish

GL chipbreaker controls chips stable at high feed machining,
 Good surface finish of side wall

Surface roughness comparison (internal evaluation)

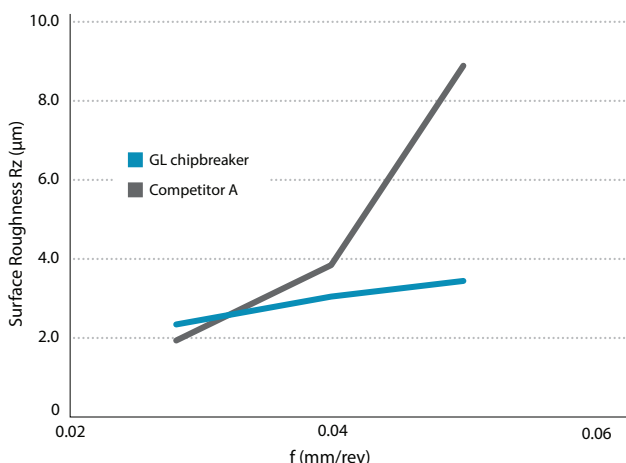

Cutting conditions: $V_c = 80$ m/min, d = 1.5 mm, f = 0.03~0.05 mm/rev, edge width 1 mm
 Workpiece material : 15CrMo4

Chip control comparison (internal evaluation)

	f = 0.03	f = 0.04	f = 0.05
GL chipbreaker			
Competitor A (Molded chipbreaker)			

KGBF-JCTM (for automatic lathe)

Discharges coolant from the top of the insert

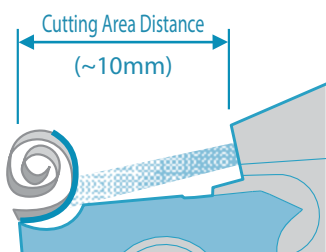

Coolant hole

Ample supply of coolant to the cutting edge.
Prevents coolant stream spreading which slows the coolant flow.

Direction of supply

Sufficient coolant between the chipbreaker and the chips
Stable chip curls and sufficient cooling of the insert

- 1 Excellent chip control provide long tool life
- 2 Superior cooling action improves tool life

External Grooving KGBF-JCTM

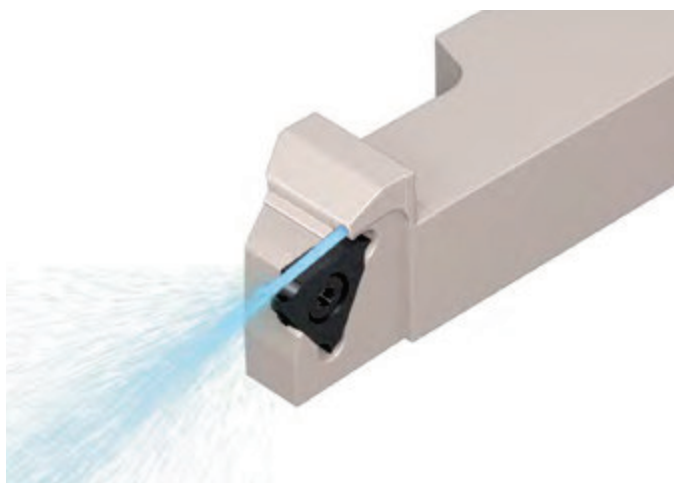

- Provides Coolant toward the Rake Surface of Insert
- Specification

Edge Width : 0.25 -3 mm
Ground Chipbreaker/Molded GL Chipbreaker
Maximum groove depth : 3 mm



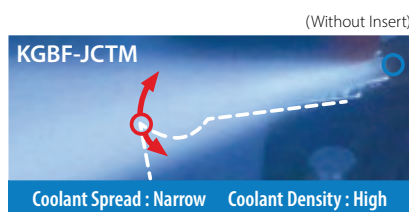
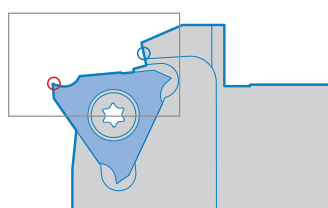

Coolant Discharging Comparison (Internal evaluation)

Small chips and better cooling of the insert leads to longer tool life

- Cutting Edge
- Coolant Hole

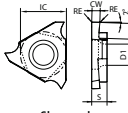

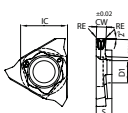
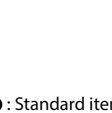
GBF

		Carbon steel / Alloy steel						P					
		Stainless steel						M					
		Cast iron						K					
		Non-ferrous metals						N					
		Titanium alloy						S					
		Hard materials (~ 40HRC)						H					
		Hard materials (40HRC ~)											
Insert	Description	No. of edges	Dimension (mm)					Tolerance (mm)		Carbide		Applicable toolholder G23~G26	
			CW	CDX	IC	S	D1	RE	CW min.	CW max.	PVD		
											PR1215		PR1535
	 <p>Sharp edge</p>	3	0.25	0.6	9.525	3.18	4.4	0	-0.02	+0.02	●	●	KGBFR...-16F KGBFR...-16FJCTM KGBFSL...-16 S...KGBFL16
			0.30	0.8					-0.02	+0.02	●	●	
			0.33	0.8					-0.025	+0.015	●	●	
			0.43	1					-0.025	+0.015	●	●	
			0.50	1.2					-0.02	+0.02	●	●	
			0.53	1.2					-0.025	+0.015	●	●	
			0.65	1.2					-0.02	+0.02	●	●	
			0.75	2					-0.02	+0.02	●	●	
			0.80	2					-0.02	+0.02	●	●	
			0.95	2					-0.02	+0.02	●	●	
			1	2					-0.02	+0.02	●	●	
			1.1	2					-0.02	+0.02	●	●	
			1.2	2					-0.02	+0.02	●	●	
			1.25	2					-0.02	+0.02	●	●	
			1.3	2					-0.02	+0.02	●	●	
			1.4	2.7					-0.02	+0.02	●	●	
			1.45	2.7					-0.02	+0.02	●	●	
			1.5	2.7					-0.02	+0.02	●	●	
			1.65	2.7					-0.02	+0.02	●	●	
			1.7	3					-0.02	+0.02	●	●	
1.75	3	-0.02	+0.02	●	●								
2	3	-0.02	+0.02	●	●								
	 <p>Sharp edge</p>	3	0.25	0.6	9.525	3.18	4.4	0	-0.02	+0.02	●	●	KGBFL...-16F KGBFSR...-16
			0.30	0.8					-0.02	+0.02	●	●	
			0.33	0.8					-0.025	+0.015	●	●	
			0.43	1					-0.025	+0.015	●	●	
			0.50	1.2					-0.02	+0.02	●	●	
			0.53	1.2					-0.025	+0.015	●	●	
			0.65	1.2					-0.02	+0.02	●	●	
			0.75	2					-0.02	+0.02	●	●	
			0.80	2					-0.02	+0.02	●	●	
			0.95	2					-0.02	+0.02	●	●	
			1	2					-0.02	+0.02	●	●	
			1.1	2					-0.02	+0.02	●	●	
			1.2	2					-0.02	+0.02	●	●	
1.25	2	-0.02	+0.02	●	●								
1.3	2	-0.02	+0.02	●	●								
1.4	2.7	-0.02	+0.02	●	●								
1.45	2.7	-0.02	+0.02	●	●								
1.5	2.7	-0.02	+0.02	●	●								
1.65	2.7	-0.02	+0.02	●	●								
1.7	3	-0.02	+0.02	●	●								
1.75	3	-0.02	+0.02	●	●								
2	3	-0.02	+0.02	●	●								
	 <p>Molded Chipbreaker</p>	3	0.75	2	9.525	3.18	4.4	0.05	-0.02	+0.02	●	●	KGBFR...-16F KGBFR...-16FJCTM KGBFSL...-16 S...KGBFL16
			0.95	2				0.05			●	●	
			1	2				0.05			●	●	
			1.5	2.7				0.1			●	●	
			2	3				0.1			●	●	
			3	3				0.1			●	●	

Right-hand shown
Max. Cutting Dia. : See Page G27

Recommended cutting conditions G142

● : Standard item R : Right-hand only L : Left-hand only □ : Check availability

G20

GBF

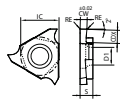
		Carbon steel / Alloy steel		Stainless steel		Cast iron		Non-ferrous metals		Titanium alloy		Hard materials (~ 40HRC)		Hard materials (40HRC ~)	
Insert	Description	No. of edges	Dimension (mm)					Tolerance (mm)		Carbide		Applicable toolholder G23~G26			
			CW	CDX	IC	S	D1	RE	CW min.	CW max.	PVD		-		
											PRI215		PRI535	GWT5	
 	GBF32R 025-005	3	0.25	0.6				0.05	-0.02	+0.02	●	●	●	KGBFR...-16F KGBFR...-16FJCTM KGBFSL...-16 S...KGBFL16	
	030-005		0.3	0.8				0.05	-0.02	+0.02	●	●	●		
	033-005		0.33	0.8				0.05	-0.025	+0.015	●	●	●		
	043-005		0.43	1				0.05	-0.025	+0.015	●	●	●		
	050-005		0.5	1.2				0.05	-0.02	+0.02	●	●	●		
	053-005		0.53	1.2				0.05	-0.025	+0.015	●	●	●		
	065-005		0.65	1.2				0.05	-0.02	+0.02	●	●	●		
	075-005		0.75	2				0.05	-0.02	+0.02	●	●	●		
	075-010		0.75	2				0.1	-0.02	+0.02	●	●	●		
	080-005		0.8	2				0.05	-0.02	+0.02	●	●	●		
	080-010		0.8	2				0.1	-0.02	+0.02	●	●	●		
	095-005		0.95	2				0.05	-0.02	+0.02	●	●	●		
	095-010		0.95	2				0.1	-0.02	+0.02	●	●	●		
	100-005		1	2				0.05	-0.02	+0.02	●	●	●		
	100-010		1	2				0.1	-0.02	+0.02	●	●	●		
	110-005		1.1	2				0.05	-0.02	+0.02	●	●	●		
	110-010		1.1	2				0.1	-0.02	+0.02	●	●	●		
	120-005		1.2	2				0.05	-0.02	+0.02	●	●	●		
	120-010		1.2	2				0.1	-0.02	+0.02	●	●	●		
	125-005		1.25	2				0.05	-0.02	+0.02	●	●	●		
	125-010		1.25	2				0.1	-0.02	+0.02	●	●	●		
	130-005		1.3	2	9.525	3.18	4.4	0.05	-0.02	+0.02	●	●	●		
	130-010		1.3	2				0.1	-0.02	+0.02	●	●	●		
	140-005		1.4	2.7				0.05	-0.02	+0.02	●	●	●		
	140-010		1.4	2.7				0.1	-0.02	+0.02	●	●	●		
	145-005		1.45	2.7				0.05	-0.02	+0.02	●	●	●		
	145-010		1.45	2.7				0.1	-0.02	+0.02	●	●	●		
	150-005		1.5	2.7				0.05	-0.02	+0.02	●	●	●		
	150-010		1.5	2.7				0.1	-0.02	+0.02	●	●	●		
	165-005		1.65	2.7				0.05	-0.02	+0.02	●	●	●		
	165-010		1.65	2.7				0.1	-0.02	+0.02	●	●	●		
	170-005		1.7	3				0.05	-0.02	+0.02	●	●	●		
	170-010		1.7	3				0.1	-0.02	+0.02	●	●	●		
	175-005		1.75	3				0.05	-0.02	+0.02	●	●	●		
	175-010		1.75	3				0.1	-0.02	+0.02	●	●	●		
	200-005		2	3				0.05	-0.02	+0.02	●	●	●		
200-010		2	3				0.1	-0.02	+0.02	●	●	●			
225-005		2.25	3				0.05	-0.02	+0.02	●	●	●			
225-010		2.25	3				0.1	-0.02	+0.02	●	●	●			
250-005		2.5	3				0.05	-0.02	+0.02	●	●	●			
250-010		2.5	3				0.1	-0.02	+0.02	●	●	●			
300-005		3	3				0.05	-0.02	+0.02	●	●	●			
300-010		3	3				0.1	-0.02	+0.02	●	●	●			

Right-hand shown
Max. Cutting Dia. : See Page G27

Recommended cutting conditions G142



● : Standard item R : Right-hand only L : Left-hand only □ : Check availability

GBF

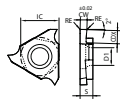
		Carbon steel / Alloy steel		Stainless steel		Cast iron		Non-ferrous metals		Titanium alloy		Hard materials (~ 40HRC)		Hard materials (40HRC ~)		
		P		M		K		N		S		H				
Insert	Description	No. of edges	Dimension (mm)						Tolerance (mm)		Carbide			Applicable toolholder G23,G25		
			CW	CDX	IC	S	D1	RE	CW min.	CW max.	PVD	-				
												PR1215	PR1535		GW15	
 	GBF32L 025-005	3	0.25	0.6				0.05	-0.02	+0.02	●	●	●			
	030-005		0.3	0.8				0.05	-0.02	+0.02	●	●	●			
	033-005		0.33	0.8				0.05	-0.025	+0.015	●	●	●			
	043-005		0.43	1				0.05	-0.025	+0.015	●	●	●			
	050-005		0.5	1.2				0.05	-0.02	+0.02	●	●	●			
	053-005		0.53	1.2				0.05	-0.025	+0.015	●	●	●			
	065-005		0.65	1.2				0.05	-0.02	+0.02	●	●	●			
	075-005		0.75	2				0.05	-0.02	+0.02	●	●	●			
	075-010		0.75	2				0.1	-0.02	+0.02	●	●	●			
	080-005		0.8	2				0.05	-0.02	+0.02	●	●	●			
	080-010		0.8	2				0.1	-0.02	+0.02	●	●	●			
	095-005		0.95	2				0.05	-0.02	+0.02	●	●	●			
	095-010		0.95	2				0.1	-0.02	+0.02	●	●	●			
	100-005		1	2				0.05	-0.02	+0.02	●	●	●			
	100-010		1	2				0.1	-0.02	+0.02	●	●	●			
	110-005		1.1	2				0.05	-0.02	+0.02	●	●	●			
	110-010		1.1	2				0.1	-0.02	+0.02	●	●	●			
	120-005		1.2	2				0.05	-0.02	+0.02	●	●	●			
	120-010		1.2	2				0.1	-0.02	+0.02	●	●	●			
	125-005		1.25	2				0.05	-0.02	+0.02	●	●	●			
	125-010		1.25	2				0.1	-0.02	+0.02	●	●	●			
	130-005		3	1.3	2	9.525	3.18	4.4	0.05	-0.02	+0.02	●	●	●	●	KBFL...-16F KGBFSR...-16
	130-010			1.3	2				0.1	-0.02	+0.02	●	●	●		
	140-005			1.4	2.7				0.05	-0.02	+0.02	●	●	●		
	140-010			1.4	2.7				0.1	-0.02	+0.02	●	●	●		
	145-005			1.45	2.7				0.05	-0.02	+0.02	●	●	●		
	145-010			1.45	2.7				0.1	-0.02	+0.02	●	●	●		
	150-005			1.5	2.7				0.05	-0.02	+0.02	●	●	●		
	150-010			1.5	2.7				0.1	-0.02	+0.02	●	●	●		
	165-005			1.65	2.7				0.05	-0.02	+0.02	●	●	●		
	165-010			1.65	2.7				0.1	-0.02	+0.02	●	●	●		
	170-005			1.7	3				0.05	-0.02	+0.02	●	●	●		
	170-010			1.7	3				0.1	-0.02	+0.02	●	●	●		
	175-005			1.75	3				0.05	-0.02	+0.02	●	●	●		
	175-010			1.75	3				0.1	-0.02	+0.02	●	●	●		
	200-005			2	3				0.05	-0.02	+0.02	●	●	●		
200-010			2	3				0.1	-0.02	+0.02	●	●	●			
225-005			2.25	3				0.05	-0.02	+0.02	●	●	●			
225-010			2.25	3				0.1	-0.02	+0.02	●	●	●			
250-005			2.5	3				0.05	-0.02	+0.02	●	●	●			
250-010			2.5	3				0.1	-0.02	+0.02	●	●	●			
300-005			3	3				0.05	-0.02	+0.02	●	●	●			
300-010			3	3				0.1	-0.02	+0.02	●	●	●			

Right-hand shown
Max. Cutting Dia. : See Page G27

Recommended cutting conditions G142

● : Standard item R : Right-hand only L : Left-hand only □ : Check availability

KGBF-F (External grooving / Shallow grooving)

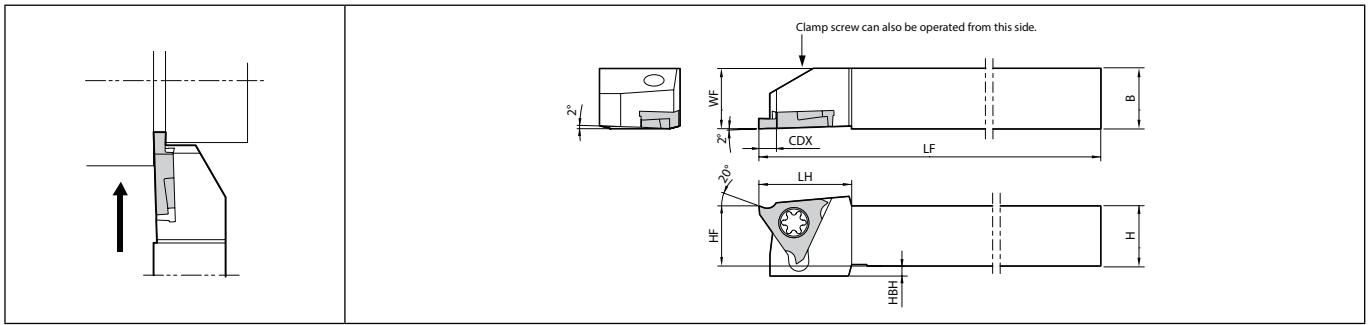

Right-hand shown | Right-hand Insert for Right-hand Toolholder, Left-hand Insert for Left-hand Toolholder.

Toolholder dimensions

Description	Availability		Dimension (mm)									Spare parts		Applicable inserts ➔ G20~G22
												Screw	Wrench	
	R	L	CDX	H	B	LH	HF	HBH	LF	WF				
KGBF [®] /L 1010JX-16F	●	●	3	10	10	18.5	10	4	120	10	SB-4070TRW	FT-8	GBF32 [®] /L type	
1212JX-16F	●	●		12	12		12	2		12				
1616JX-16F	●	●		16	16		16	-		16				
2020JX-16F	●	●		20	20		20	-		20				

CDX shows the distance from the toolholder to the cutting edge. Available Groove Depth : „CDX“ of Insert.



KGBF-JCTM (External grooving / Shallow grooving, Coolant-through holder)

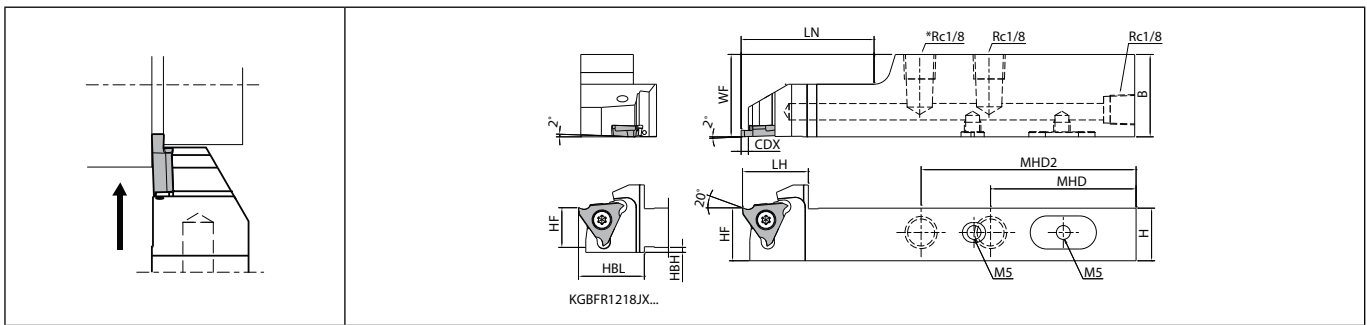

Right-hand shown | Right-hand Insert for Right-hand Toolholder. | KGBFR1218JX-16FJCTM : 2-Rc1/8

Toolholder dimensions

Description	Availability		Dimension (mm)											Coolant hole	Spare parts				Applicable inserts G20,G21
	R	CDX	H	B	LH	MHD	MHD2	HF	HBH	HBL	LF	LN	WF		Plug	Plug	Screw	Wrench	
KGBFR 1218JX-16FJCTM	●		12	18		54	-	12	1.5	20		28	12	Yes	GP-1	HSSX4LP	SB-4070TRW	FT-8	GBF32R type
1625JX-16FJCTM	●	3	16	25	20	44	65	16	-	-	120	40	16						
2025JX-16FJCTM	●		20					20					20						

CDX shows the distance from the toolholder to the cutting edge. Available Groove Depth : „CDX“ of Insert.
Please see page H16 and H17 for piping parts of coolant-through holders.

G

Grooving

External

Internal

Face

● : Standard item R : Right-hand only L : Left-hand only □ : Check availability

KGBFS (External grooving / Shallow grooving)

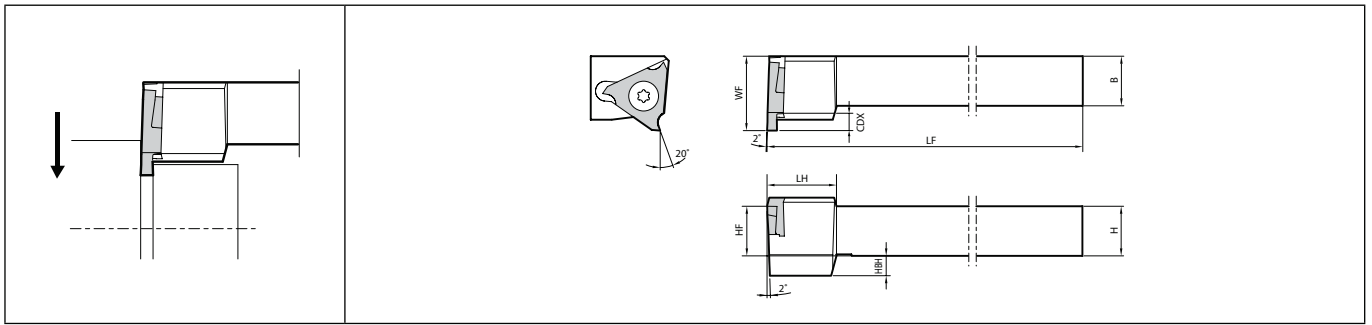

Right-hand shown | Left-hand Insert for Right-hand Toolholder, Right-hand Insert for Left-hand Toolholder.

Toolholder dimensions

Description	Availability		Dimension (mm)									Spare parts		Applicable inserts G20~G22
												Screw	Wrench	
	R	L	CDX	H	B	LH	HF	HBH	LF	WF				
KGBFS% 1010JX-16	●	●		10	10		10	4		15	SB-4070TRW	FT-8	GBF32 ^{1/8} type	
1212JX-16	●	●	3	12	12	14	12	2	120	16				
1616JX-16	●	●		16	16		16	-		20				

CDX shows the distance from the toolholder to the cutting edge. Available Groove Depth : „CDX“ of Insert.



S-KGBF (External grooving / Shallow grooving)

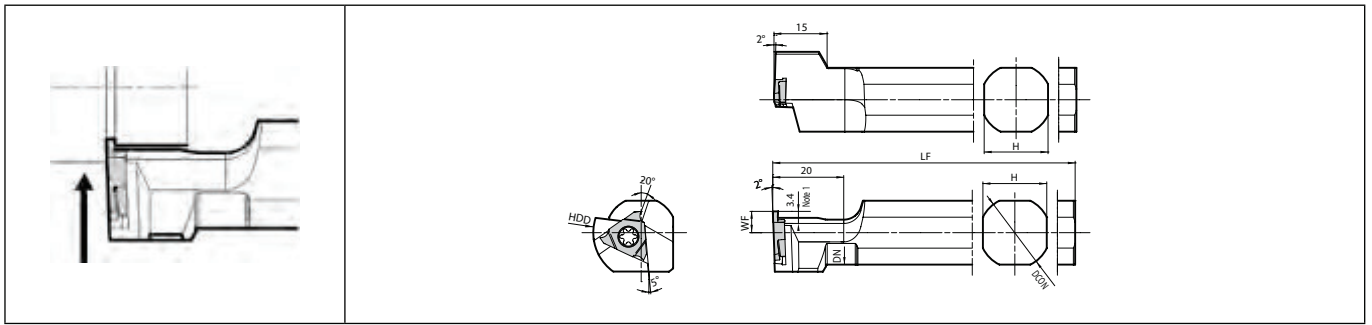

Left-hand shown | Right-hand Insert for Left-hand Toolholder. | Note 1) CDX shows available grooving depth.

Toolholder dimensions

Description	Availability	Dimension (mm)							Spare parts		Applicable inserts G20,G21
		L	DCON	H	DN	HDD	LF	WF	Screw	Wrench	
S12F- KGBFL16	●	12	11	11		80		SB-4070TRW	FT-8	GBF32R type	
S14H- KGBFL16	●	14	13	13		100					
S15F- KGBFL16	●	15.875	15	15	27	85	6				
S16F- KGBFL16	●	16				90					
S19G- KGBFL16	●	19.05	17	18		120					
S19K- KGBFL16	●					90					
S20G- KGBFL16	●					20					18
S20K- KGBFL16	●	22	20	21							
S22K- KGBFL16	●	25	23	24	32	100	10				
S25.0H- KGBFL16	●	25.4									
S25K- KGBFL16	●										

G

Grooving

External

Internal

Face

● : Standard item R : Right-hand only L : Left-hand only □ : Check availability

Compatibility with GBF and GBA

1. GBF will fit KGBA / KGBAS toolholders.
 - Caution: The maximum groove depth for KGBA / KGBAS toolholders is 2.5 mm
2. GBA inserts will also fit KGBF-F toolholders
 - Caution: The rake angle after installation in the toolholder is 11°

KGBF-F toolholder with GBF insert maximum machining diameter

- 3 mm groove depth is available on workpiece diameters up to $\varnothing 51$ mm.
- 2.7 mm groove depth is available on workpiece diameters up to $\varnothing 100$ mm.
- 2.5 mm or less groove depth is available on workpiece diameters up to $\varnothing 200$ mm

The workpiece will interfere with the holder at maximum diameter or larger

Max. cutting diameter

Max. cutting diameter at 3 mm grooving depth

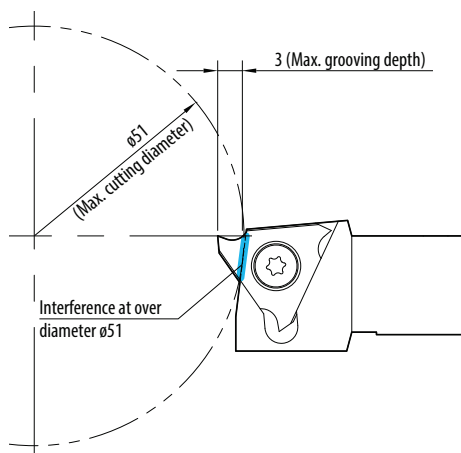

Various insert lineup for KGD toolholder

Smooth chip control

» Newly-introduced chipbreakers designed to cover a variety of workpiece materials.

High precision edge preparation

» High precision molding technology with tolerance ± 0.03 mm (Edge width 2, 3, 4 mm types)

Highly-reputed MEGACOAT technology

» Long tool life and high efficiency machining achieved by superior oxidation resistance and wear resistance.

Application map

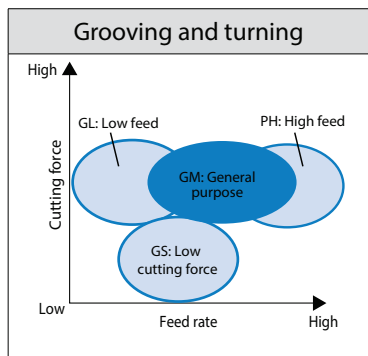

Chipbreaker selection

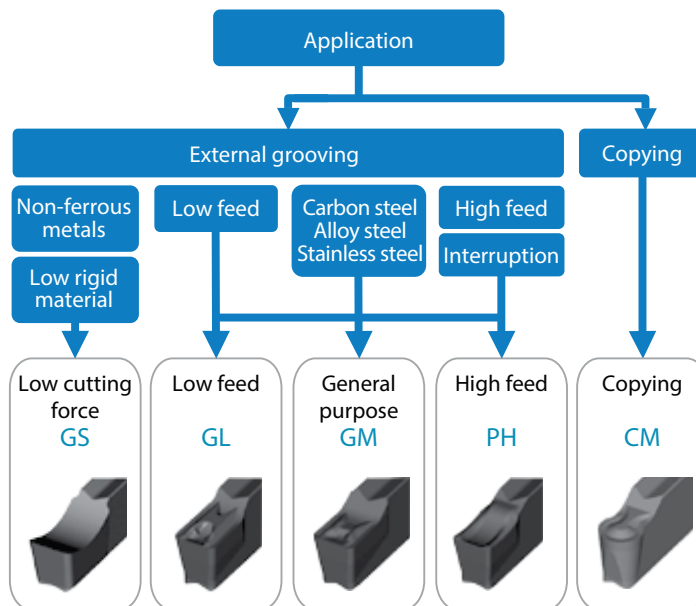

- G
- Grooving
- External
- Internal
- Face

Comparison of chip control (15CrMo4, $V_c = 150$ m/min, $f = 0.15$ mm/rev)

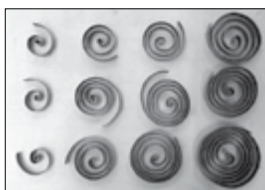

GM chipbreaker



Competitor A



Competitor B

Smooth chip control
» Less chip biting troubles

Toolholder and insert combination of KGD type (new) and KGM type (conventional)

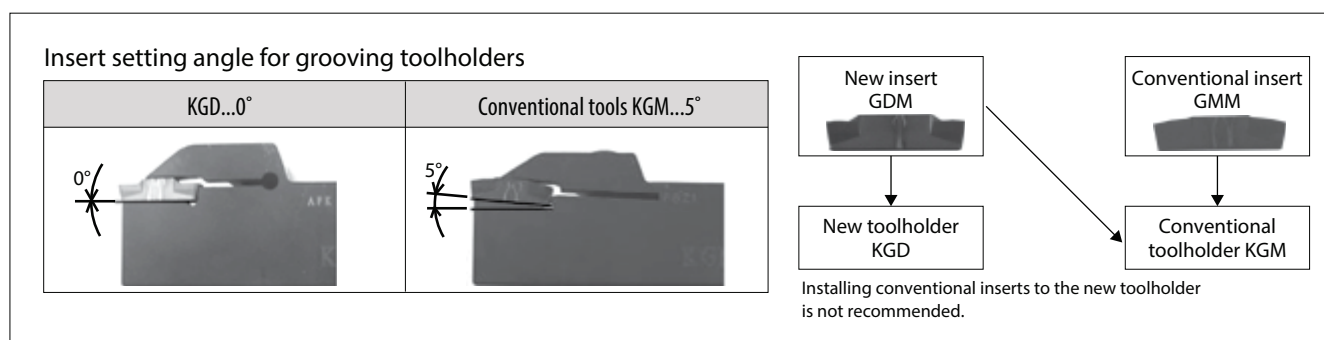

KGD grooving toolholder

Integral type and separate type (toolholder + blade) are available

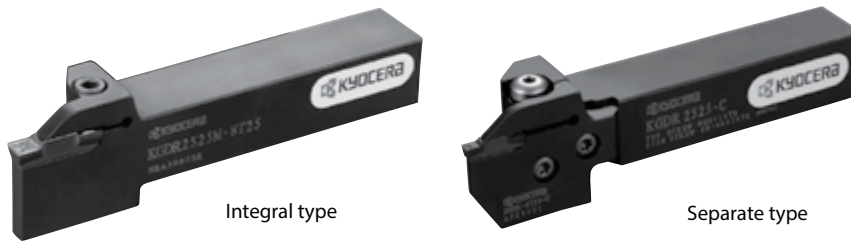

High rigidity separate type toolholder

- Adaptable to wide applications by changing blades.
- Deals with various edge widths and cutting depths by changing the blade and toolholder combination.
- Even if the blade is broken, you only need to replace the broken part.

Toolholders for High Pressure Coolant

- Added coolant-through holder KGD-JCTM with superior chip control and long tool life

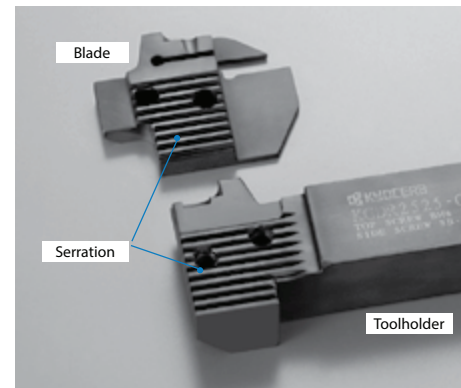

Structure of toolholder unit (toolholder + blade)

KGD-S (0° separate type)

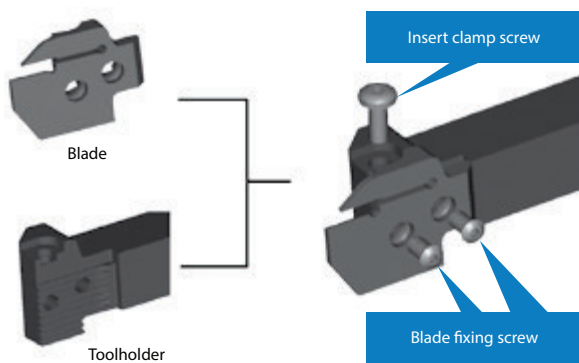

Note for the toolholder and blade combination of 0° separate type
 Toolholder (KGD[®]/L○○○○-C)
 +
 Blade (KGD[®]/L-○T○○-C)

Right-hand blade for right-hand toolholder,
 Left-hand blade for left-hand toolholder.

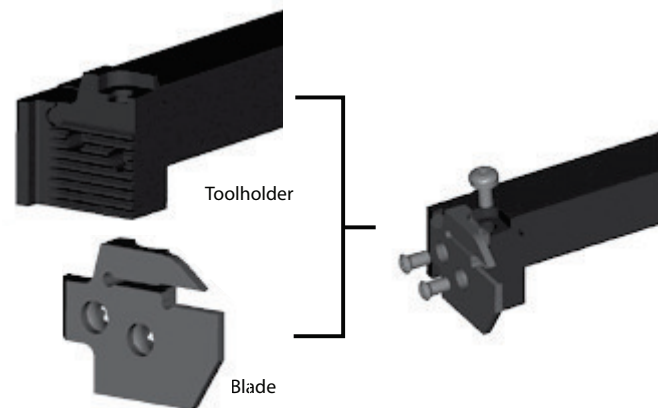

KGDS-S (90° separate type)



Note for the toolholder and blade combination of 90° separate type
 Toolholder (KGDS[®]/L○○○○-C)
 +
 Blade (KGD[®]/r-○T○○-C)

Left-hand blade for right-hand toolholder,
 Right-hand blade for left-hand toolholder.

GDM/GDMS/GDG

Insert		Description	No. of edges	Dimension (mm)				Tolerance (mm)		Carbide		Cermet	Applicable toolholder G34~G42		
				CW	S	RE	INSL	CW min.	CW max.	PVD	-				
										PR1715	PR1725	PR1535	TiN620	TiN90	
 General purpose	GDM 2420N-020GM	2	2.4	4.3	0.2	20	-0.03	+0.03	●	●	●	●	●	●	KGD [°] /L...2.4... KGD [°] /L...2...
	GDM 3020N-020GM 3020N-040GM	2	3	4.3	0.2 0.4	20	-0.03	+0.03	●	●	●	●	●	●	KGD [°] /L...3... KGD [°] /L...2.4...
	GDM 4020N-020GM 4020N-040GM 4020N-080GM	2	4	4.3	0.2 0.4 0.8	20	-0.03	+0.03	●	●	●	●	●	●	KGD [°] /L...4... KGD [°] /L...3...
	GDM 5020N-040GM 5020N-080GM	2	5	4.3	0.4 0.8	20	-0.04	+0.04	●	●	●	●	●	●	KGD [°] /L...5... KGD [°] /L...4...
	GDM 6020N-040GM 6020N-080GM	2	6	4.3	0.4 0.8	20	-0.04	+0.04	●	●	●	●	●	●	KGD [°] /L...6... KGD [°] /L...5...
	GDM 8030N-080GM	2	8	5.5	0.8	30	-0.05	+0.05	●	●	●	●	●	●	KGD [°] /L...-8T25
 1-edge / General purpose	GDMS 2220N-020GM	1	2.2	4.3	0.2	20	-0.03	+0.03	●	●	●	●	●	●	KGD [°] /L...2...
	GDMS 3020N-040GM	1	3	4.3	0.4	20	-0.03	+0.03	●	●	●	●	●	●	KGD [°] /L...3... KGD [°] /L...2.4...
	GDMS 4020N-040GM	1	4	4.3	0.4	20	-0.03	+0.03	●	●	●	●	●	●	KGD [°] /L...4... KGD [°] /L...3...
	GDMS 5020N-080GM	1	5	4.3	0.8	20	-0.04	+0.04	●	●	●	●	●	●	KGD [°] /L...5... KGD [°] /L...4...
	GDMS 6020N-080GM	1	6	4.3	0.8	20	-0.04	+0.04	●	●	●	●	●	●	KGD [°] /L...6... KGD [°] /L...5...

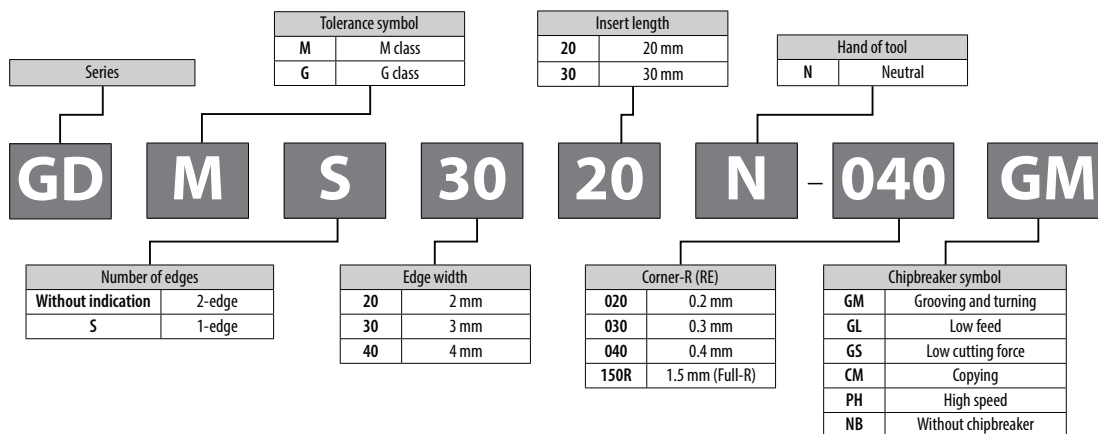

Recommended cutting conditions G45

Inserts identification system

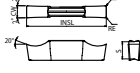

● : Standard item R : Right-hand only L : Left-hand only □ : Check availability

GDM/GDMS/GDG

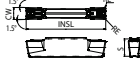
		Carbon steel / Alloy steel								☺ ☹		● ○		● ○		P	
		Stainless steel								☺ ☹		● ○		● ○		M	
		Cast iron								● ○		● ○		● ○		K	
		Non-ferrous metals								● ○		● ○		● ○		N	
		Titanium alloy								● ○		● ○		● ○		S	
		Hard materials (~ 40HRC)								● ○		● ○		● ○		H	
		Hard materials (40HRC ~)								● ○		● ○		● ○		H	
Insert	Description	No. of edges	Dimension (mm)				Tolerance (mm)		Carbide			Cermet		Applicable toolholder G34~G42			
			CW	S	RE	INSL	CW min.	CW max.	PVD		-	-					
									PR1Z15	PR1Z25			PR1S35		GW15	TN620	TN90
  Low cutting force	GDG 2520N-020GS	2	2.5	4.3	0.2	20	-0.02	+0.02	●	●	●	●	●	●	●	●	KGD [®] /L...2.4... KGD [®] /L...2...
	GDG 3020N-020GS	2	3	4.3	0.2	20	-0.02	+0.02	●	●	●	●	●	●	●	●	KGD [®] /L...3... KGD [®] /L...2.4...
	GDG 3520N-020GS	2	3.5	4.3	0.2	20	-0.02	+0.02	●	●	●	●	●	●	●	●	KGD [®] /L...3...
	GDG 4020N-040GS	2	4	4.3	0.4	20	-0.02	+0.02	●	●	●	●	●	●	●	●	KGD [®] /L...4... KGD [®] /L...3...
	GDG 5020N-040GS	2	5	4.3	0.4	20	-0.02	+0.02	●	●	●	●	●	●	●	●	KGD [®] /L...5... KGD [®] /L...4...
	GDG 6020N-040GS	2	6	4.3	0.4	20	-0.02	+0.02	●	●	●	●	●	●	●	●	KGD [®] /L...6... KGD [®] /L...5...
	GDG 8030N-040GS	2	8	5.5	0.4	30	-0.02	+0.02	●	●	●	●	●	●	●	●	KGD [®] /L...8T25
  Low feed	GDM 2420N-020GL	2	2.4	4.3	0.2	20	-0.03	+0.03	●	●	●	●	●	●	●	KGD [®] /L...2.4... KGD [®] /L...2...	
	GDM 3020N-020GL 3020N-040GL	2	3	4.3	0.2 0.4	20	-0.03	+0.03	●	●	●	●	●	●	●	●	KGD [®] /L...3... KGD [®] /L...2.4...
	GDM 4020N-020GL 4020N-040GL	2	4	4.3	0.2 0.4	20	-0.03	+0.03	●	●	●	●	●	●	●	●	KGD [®] /L...4... KGD [®] /L...3...
	GDM 5020N-040GL	2	5	4.3	0.4	20	-0.04	+0.04	●	●	●	●	●	●	●	●	KGD [®] /L...5... KGD [®] /L...4...
	GDM 6020N-040GL	2	6	4.3	0.4	20	-0.04	+0.04	●	●	●	●	●	●	●	●	KGD [®] /L...6... KGD [®] /L...5...

Recommended cutting conditions G45

● : Standard item R : Right-hand only L : Left-hand only □ : Check availability

GDM/GDMS/GDG



Insert		Description	No. of edges	Dimension (mm)				Tolerance (mm)		Carbide		Cer- met	Applicable toolholder G34~G42
				CW	S	RE	INSL	CW min.	CW max.	PVD		-	
										PR1715	PR1725		
		GDM 2020-020PH	2	2	4.3	0.2	20	-0.03	+0.03	●	●	●	KGD [°] L...2...
		GDM 3020N-030PH	2	3	4.3	0.3	20	-0.03	+0.03	●	●	●	KGD [°] L...3... KGD [°] L...2.4...
		GDM 4020N-030PH	2	4	4.3	0.3	20	-0.03	+0.03	●	●	●	KGD [°] L...4... KGD [°] L...3...
		GDMS 2020-020PH	1	2	4.3	0.2	20	-0.03	+0.03	●	●	●	KGD [°] L...2...
		GDMS 3020N-030PH	1	3	4.3	0.3	20	-0.03	+0.03	●	●	●	KGD [°] L...3... KGD [°] L...2.4...
		GDMS 4020N-030PH	1	4	4.3	0.3	20	-0.03	+0.03	●	●	●	KGD [°] L...4... KGD [°] L...3...
		GDM 3020N-150R-CM	2	3	4.3	1.5	20	-0.03	+0.03	●	●	●	KGD [°] L...3... KGD [°] L...2.4...
		GDM 4020N-200R-CM	2	4	4.3	2	20	-0.03	+0.03	●	●	●	KGD [°] L...4... KGD [°] L...3...
		GDM 5020N-250R-CM	2	5	4.3	2.5	21	-0.04	+0.04	●	●	●	KGD [°] L...5... KGD [°] L...4...
		GDM 6020N-300R-CM	2	6	4.3	3	21	-0.04	+0.04	●	●	●	KGD [°] L...6... KGD [°] L...5...

GDM50/60-CM differs from other descriptions in length (INSL) to avoid interference of a toolholder with workpiece.

Recommended cutting conditions G45

● : Standard item R : Right-hand only L : Left-hand only □ : Check availability

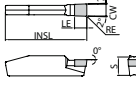
GDGS

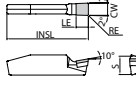
Insert		Description	Edge preparation type	No. of edges	Dimension (mm)					Tolerance (mm)		CBN			PCD	Applicable toolholder G34~G42
					CW	S	RE	INSL	LE	CW min.	CW max.	PVD	-	-		
												KBN05M	KBN570	KPD001		
						Carbon steel / Alloy steel									P	
						Stainless steel									M	
						Cast iron									K	
						Non-ferrous metals						●			N	
						Titanium alloy						●			S	
						Hard materials (~ 40HRC)									H	
						Hard materials (40HRC ~)						●				
						Sintered steel						●				
 1-edge	 1-edge	GDGS 2020N-020NB	E008	1	2	4.3	0.2	20	2.9	-0.03	+0.03	●	●			KGD [®] /L...2...
		GDGS 3020N-040NB	E008	1	3	4.3	0.4	20	2.9	-0.03	+0.03	●	●			KGD [®] /L...3... KGD [®] /L...2.4...
		GDGS 4020N-040NB	E008	1	4	4.3	0.4	20	2.9	-0.03	+0.03	●	●			KGD [®] /L...4... KGD [®] /L...3...
		GDGS 5020N-040NB	E008	1	5	4.3	0.4	20	2.9	-0.03	+0.03	●	●			KGD [®] /L...5... KGD [®] /L...4...
		GDGS 6020N-040NB	E008	1	6	4.3	0.4	20	2.9	-0.03	+0.03	●	●			KGD [®] /L...6... KGD [®] /L...5...
 1-edge	 1-edge	GDGS 2020N-020NB	F	1	2	4.3	0.2	20	2.9	-0.03	+0.03			●		KGD [®] /L...2...
		GDGS 3020N-020NB	F	1	3	4.3	0.2	20	2.9	-0.03	+0.03			●		KGD [®] /L...3... KGD [®] /L...2.4...
		GDGS 4020N-020NB	F	1	4	4.3	0.2	20	2.9	-0.03	+0.03			●		KGD [®] /L...4... KGD [®] /L...3...
		GDGS 5020N-020NB	F	1	5	4.3	0.2	20	2.9	-0.03	+0.03			●		KGD [®] /L...5... KGD [®] /L...4...
		GDGS 6020N-020NB	F	1	6	4.3	0.2	20	2.9	-0.03	+0.03			●		KGD [®] /L...6... KGD [®] /L...5...

Recommended cutting conditions G45



● : Standard item R : Right-hand only L : Left-hand only □ : Check availability

CBN & PCD Inserts are sold in 1 piece boxes

KGD (External grooving)

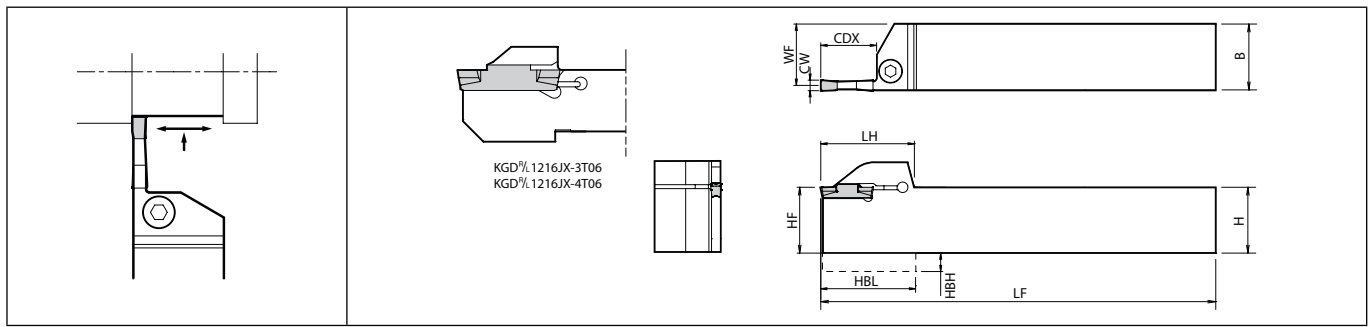

Right-hand shown

Toolholder dimensions

Description	Availability		Dimension (mm)											Spare parts				Applicable inserts G30~G33
	R	L	CDX	H	B	LH	HF	HBH	HBL	LF	WF	CW min.	CW max.	Clamp bolt	Screw	Wrench	Wrench	
KGD% 1616H-2T06 1616H-2T10 1616H-2T17 2012K-2T17 2020K-2T06 2020K-2T10 2020K-2T17 2525M-2T06 2525M-2T10 2525M-2T17	●	●	6			27.7			28					HH5X16	-	LW-4	-	GD..2020... GD..2220... GD..2420... GD..2520... GD..3020...
	●	●	10	16	16	30.2	16	4	30.5	100	15.2							
	●	●	17			31.2			31.5									
	●	●	17		12	32.5					11.2							
	●	●	6		20	28	20			125	19.2	2	3					
	●	●	10		20	30.5												
	●	●	17		20	32.5												
	●	●	6			28												
	●	●	10	25	25	30.5	25			150	24.2							
●	●	17			32.5													
KGD% 2012K-2.4T17 2020K-2.4T17	●	●	17	20	12	32.5	20	-	-	125	11	2.4	3	HH5X16	-	LW-4	-	GD..2420... , GD..2520... GD..3020...
	●	●	17	20	20	32.5	20	-	-	125	19							
KGD% 1216JX-3T06 1616H-3T06 1616H-3T10 1616H-3T20 2012K-3T20 2020K-3T06 2020K-3T10 2020K-3T20 2525M-3T06 2525M-3T10 2525M-3T20	●	●	6	12		19.5	12	2	19	120				-	SE-50125TR	-	LW-20	GD..3020... GD..3520... GD..4020...
	●	●	10		16	27.7	16	4	28	100	14.8			HH5X16	-	LW-4	-	
	●	●	10		16	30.2	16	4	30.5	100								
	●	●	20			34.2			34.5									
	●	●	20		12	34.5					10.8							
	●	●	6		20	28	20			125	18.8	3	4					
	●	●	10		20	30.5												
	●	●	20		20	34.5												
	●	●	6			28												
	●	●	10	25	25	30.5	25			150	23.8							
	●	●	20			35.5												
	●	●	20			35.5												
KGD% 1216JX-4T06 2020K-4T10 2020K-4T20 2525M-4T10 2525M-4T20 2525M-4T25	●	●	6	12	16	19.5	12	2	19	120	14.3							-
	●	●	10		20	30.5	20			125	18.3			HH5X16	-	LW-4	-	
	●	●	20		20	34.5												
	●	●	10			30.5												
	●	●	20	25	25	35.5	25			150	23.3							
	●	●	25			40.5												
KGD% 2020K-5T10 2020K-5T17 2525M-5T10 2525M-5T17 2525M-5T25	●	●	10	20	20	30.5	20			125	17.8							HH5X16
	●	●	17			37.5												
	●	●	10			30.5												
	●	●	17	25	25	37.5	25			150	22.8							
	●	●	25			40.5												
KGD% 2525M-6T15 2525M-6T30	●	●	15	25	25	32.5	25	-	-	150	22.4	6	6	HH5X25	-	LW-4	-	GD..6020...
	●	●	30			45.5												
KGD% 2525M-8T25 3232P-8T25	●	●	25	25	25	43.3	25	7	44.2	150	22			HH6X25	-	LW-5	-	GD..8030...
	●	●	25	32	32	32	-	-	170	29								

CDX : Maximum depth to which processing can be made. (If the CDX is 20 mm or more, the maximum groove-depth of groove made by the 2-edge insert will be 18 mm.)

Recommended tightening torque of clamp bolt : 6.5N·m (HH5X16), 8.0N·m (HH6X25), 2.5N·m (SE-50125TR)

Above toolholders are applicable to Cut-off, too.

KGD (External grooving)

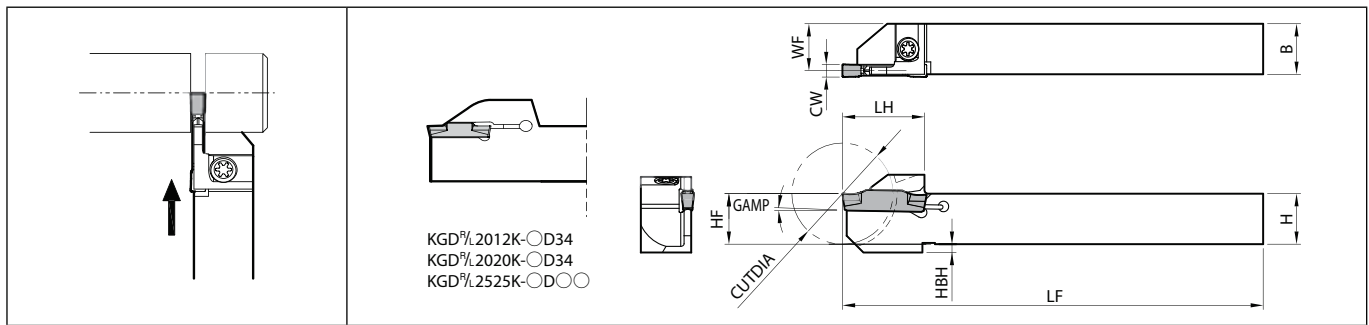

Right-hand shown

Toolholder dimensions

Description	Availability		Dimension (mm)										Angle (°)	Spare parts					Applicable inserts ➔ G30~G33		
														Clamp bolt	Screw	Screw	Wrench	Wrench			
	R	L	CUTDIA	H	B	LH	HF	HBH	LF	WF	CW min.	CW max.		GAMP							
KGD [®] /L 1010JX-2 1212F-2 1212JX-2 1616JX-2 2012K-2D34 2020K-2D34 2525K-2D34	●	●	20	10	10	18	10		120	9.2				1	-	SB-40120TR	-	-	LTW-15S	GD..2020... GD..2220... GD..2420... GD..2520... GD..3020...	
	●	●	24	12	12	19.5	12	2	85	11.2											
	●	●	32	16	16	24.5	16		120	15.2	2	3									
	●	●	34	20	12	20	-		11.2	125	19.2			0	HH5X16	-		LW-4	-		
	●	●			20				32.5												
	●	●	25	25		25															
KGD [®] /L 1010JX-2.4 1212F-2.4 1212JX-2.4 1616JX-2.4 2012K-2.4D34 2020K-2.4D34 2525K-2.4D34	●	●	20	10	10	18	10		120	9				1	-	SB-40120TR	-	-	LTW-15S	GD..2420... GD..2520... GD..3020...	
	●	●	24	12	12	19.5	12	2	85	11											
	●	●	32	16	16	24.5	16		120	15	2.4	3									
	●	●	34	20	12	20	-		11	125	19			0	HH5X16	-		LW-4	-		
	●	●			20				32.5												
	●	●	25	25		25															
KGD [®] /L 1212JX-3	●	●	24	12	12	19.5	12	2	120	10.8	3	3	1	-	SB-40120TR	-	-	LTW-15S	GD..3020...		
KGD [®] /L 1616JX-3 1616JX-3D38 1913K-3D38 2012JX-3D42 2012JX-3D51 2020JX-3D42 2020JX-3D51 2525K-3D51	●	●	32	16	16	24.5	16		120	14.8						SB-40120TR	-	-	LTW-15S	GD..3020... GD..3520... GD..4020...	
	●	●	38	19	13	29	19		125	11.8											
	●	●							12												31
	●	●	42	20	12	31	20		120	18.8				1	-	SE-50125TR	-	LW-4	-		
	●	●							36												120
	●	●	42	20	12	31	20		120	18.8											
	●	●							36												120
	●	●	51	25	25	41.5	25		125	23.8				0	HH5X16	-		LW-4	-		
●	●	120																			

4mm width Insert cannot be installed in KGD[®]/L 1212JX-3

Recommended tightening torque of clamp screw : 2.0N·m (SB-40120TR), 2.5N·m (SE-50125TR), 6.5N·m (HH5X16)

When machining the material greater than ø36 mm with KGD[®]/L...-3D38, KGD[®]/L...-3D42 and KGD[®]/L...-3D51 toolholders, please use 1-edge inserts.

Maximum cutting diameter for 2-edge inserts is ø36 mm.

KGD-JCT (External grooving, Coolant-through holder)

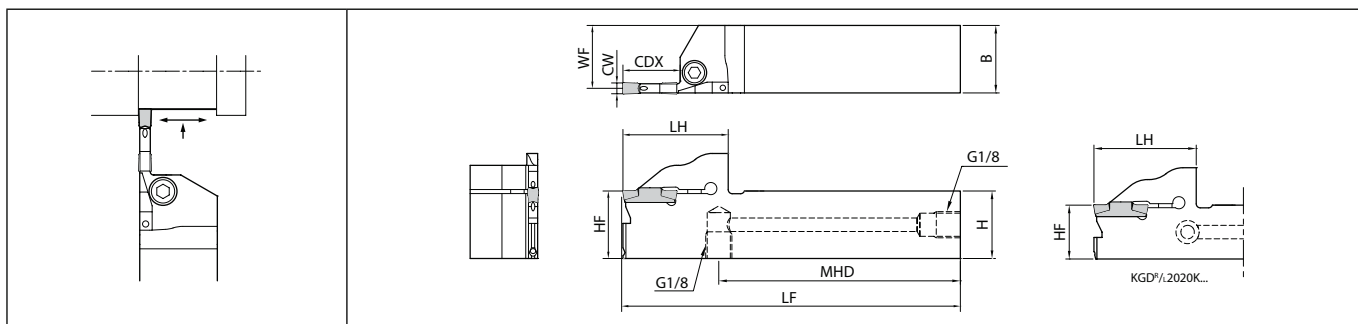

Right-hand shown | Pressure Resistance : ~15MPa

Toolholder dimensions

Description	Availability		Dimension (mm)											Coolant hole	Spare parts			Applicable inserts G30~G33
	R	L	CDX	H	B	LH	MHD	HF	LF	WF	CW min.	CW max.	Clamp bolt		Plug	Wrench		
KGD%L 2020K-3T06JCT 2525K-3T06JCT	●	●	6	20	20	31.5	96.2	20	125	18.8	3	4	Yes	HH5X16	HSG1/8X8.0	LW-4	GD..3020... GD..3520... GD..4020...	
	●	●		25	25		96.5	25		23.8				HH5X25				
KGD%L 2020K-3T10JCT 2525K-3T10JCT	●	●	10	20	20	34	94.2	20	125	18.8	3	4	Yes	HH5X16	HSG1/8X8.0	LW-4		
	●	●		25	25		94.5	25		23.8				HH5X25				
KGD%L 2020K-3T20JCT 2525K-3T20JCT	●	●	20	20	20	38	90.2	20	125	18.8	3	4	Yes	HH5X16	HSG1/8X8.0	LW-4		
	●	●		25	25	39	89.5	25		23.8				HH5X25				
KGD%L 2020K-4T10JCT 2525K-4T10JCT	●	●	10	20	20	34	94.2	20	125	18.3	4	5	Yes	HH5X16	HSG1/8X8.0	LW-4	GD..4020... GD..5020...	
	●	●		25	25		94.5	25		23.3				HH5X25				
KGD%L 2020K-4T20JCT 2525K-4T20JCT	●	●	20	20	20	38	90.2	20	125	18.3	4	5	Yes	HH5X16	HSG1/8X8.0	LW-4		
	●	●		25	25	39	89.5	25		23.3				HH5X25				
KGD%L 2525K-4T25JCT	●	●	25	25	25	44	84.5	25	125	23.3	4	5	Yes	HH5X25	HSG1/8X8.0	LW-4		

Toolholder identification system

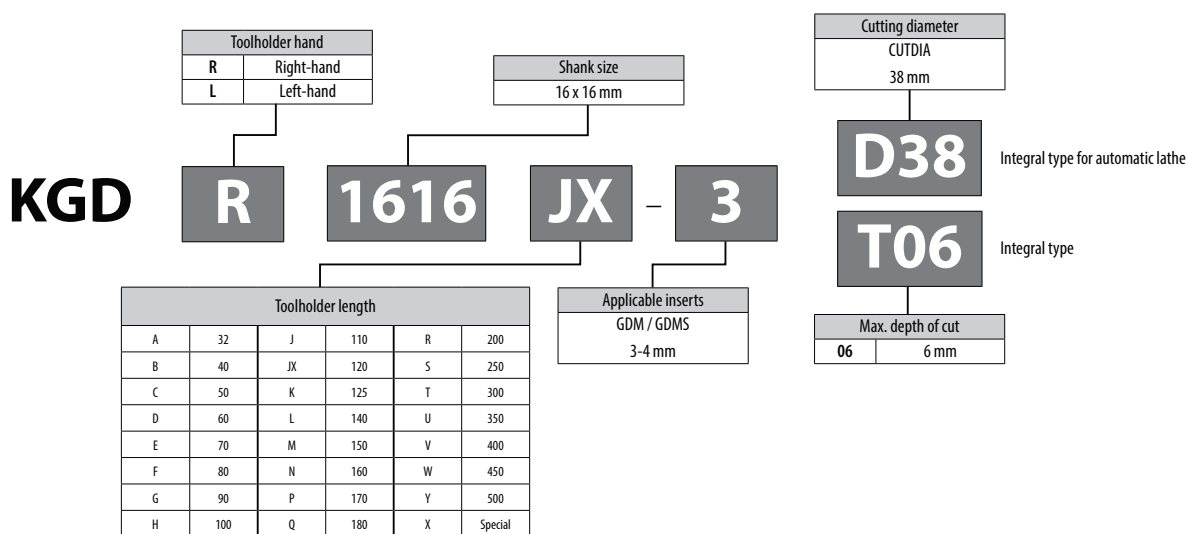

● : Standard item R : Right-hand only L : Left-hand only □ : Check availability

Easy connection with high pressure hose and joint

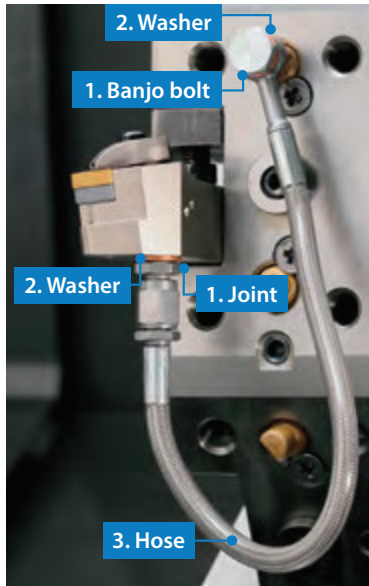

- Even without a high pressure pump, internal coolant can be used at a normal pressure
- Banjo bolt available for angled hose connection. Can be used in a variety of machines

Piping installation guide

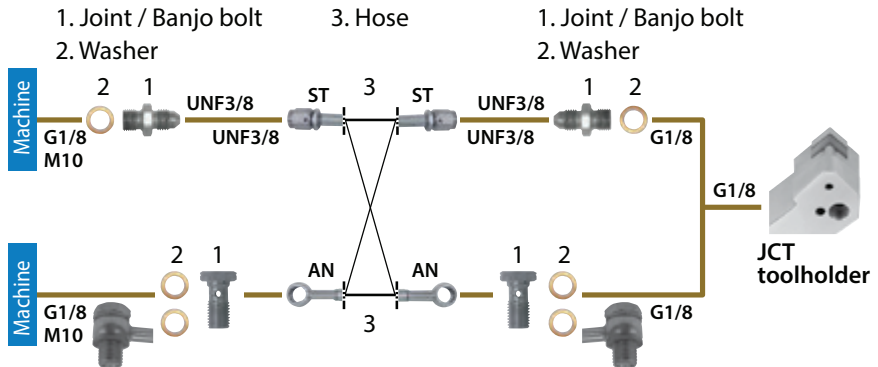

Piping parts

Optional piping parts available

Choose from parts below to match your machine specifications

1. Joint / Banjo bolt × 2 2. Washer × 2-4 3. Hose × 1

1. Joint / Banjo bolt

Applicable pressure: ~ 30 MPa

Shape	Description	Availability	Thread standard
			Thread connection to the machine
	J-G1/8-UNF3/8	●	G1/8
	J-M10X1.5-UNF3/8	●	M10X1.5
Banjo bolt (For the angle hose)	BB-G1/8	●	G1/8
	BB-M10X1.5	●	M10X1.5

2. Washer

Applicable pressure: ~ 30 MPa

Shape	Description	Availability
	WS-10	●

* Use 2 washers for a banjo bolt

3. Hose

Applicable pressure: ~ 30 MPa

Shape	Description	Availability	Thread standard		Dimensions (mm)
					L
	HS-ST-ST-200	●	UNF3/8	UNF3/8	200
	HS-ST-ST-250	●			250
	HS-ST-AN-200	●	UNF3/8	Banjo bolt	200
	HS-ST-AN-250	●			250
	HS-AN-AN-200	●	Banjo bolt	Banjo bolt	200
	HS-AN-AN-250	●			250

Precautions

● : Std. Item

1. Make sure machine door is completely closed before use of these parts.
2. Use appropriate seal for the male thread of the piping parts and make sure the connection is secure. Use plugs to seal off unused coolant holes.
3. Connect and fasten the coolant hose firmly.
4. The use of copper washers may cause leakage but will have no effect on the performance.
5. Commercial piping parts can be used if the thread standards are same. Check the applicable pressure before use.
6. Regularly changing the coolant filter is recommended.

KGD-JCTM (for automatic lathe)

Cut-off holders for high pressure coolant with long tool life
The optimized coolant hole position effectively cools the cutting edge

- 1 Optimized coolant hole position
- 2 Discharge coolant towards the flank face of the insert

G



Grooving

External

Internal

Face

Coolant discharging

KGD-JCTM

Sufficient cooling towards the cutting edge

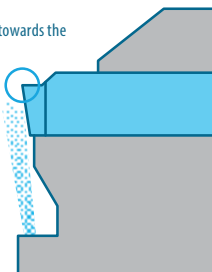

Competitor A

Coolant does not flow directly towards the cutting edge

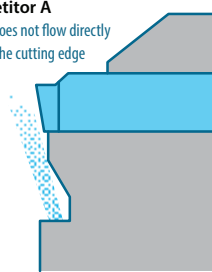

Effective cooling of the cutting edge

Applicable to Different Supply Styles. 2 Supports Internal Coolant with/without Piping System

Internal Coolant without Piping *When the tool turret supports direct coolant

Coolant is supplied directly from tool turret into the holder. No need for piping just by installing tools

Applicable to Wide Range of Machines

The tool turret is optional. Please contact our company sales representative for details.

CITIZEN MACHINERY CO., LTD. (L20, D25, M32)
STAR MICRONICS CO., LTD. (SB-R series, SR series, SV series)
TSUGAMI CORPORATION (S205/206-II □ 16 type, S205A/206A-II □ 16 type)

Compatible with various machine including the above. Toolholders can be customized as well.

(Random order)
Based on Kyocera Survey in January 2021



Point

Appropriate hole design to reduce energy loss based on deep analysis

Analysis Image (Internal evaluation)

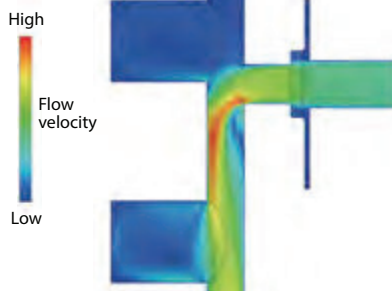

KGD-JCTM (External grooving, Coolant-through holder)

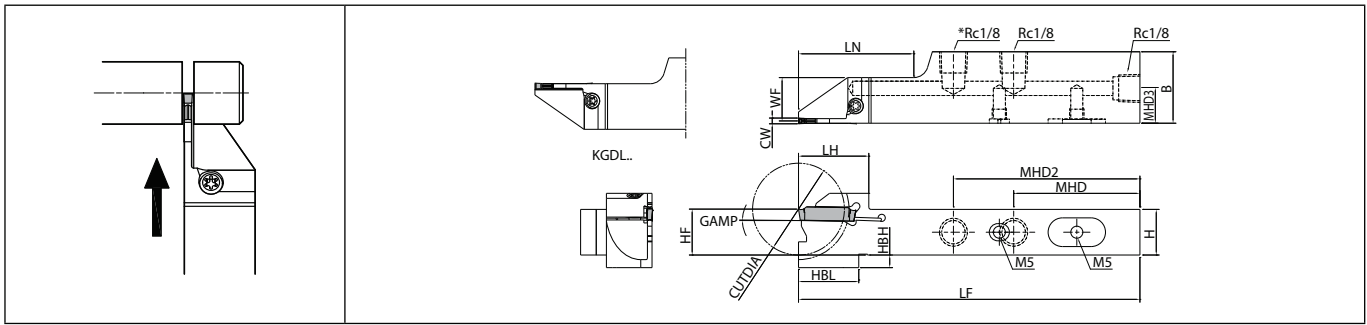

Right-hand shown | KGD[®] 12-JCTM : 2-Rc1/8

Toolholder dimensions

Description	Availability		Dimension (mm)														Coolant hole	Applicable inserts G30~G33	
	R	L	CUTDIA	H	B	LH	MHD	MHD2	MHD3	HF	HBH	HBL	LF	LN	WF	CW min.			CW max.
KGDR 1218JX-2JCTM	●		24	12	18	19.5	54	-	8.4	12	21	120	44	11.2	2	3	1	Yes	GD..2020... GD..2220... GD..2420... GD..2520... GD..3020...
KGDL 1218JX-2JCTM		●							7.7	8.5	21.5		40	15.2					
KGDR 1625JX-2JCTM	●		32	16	25	24.5	44	65	12.2	16	4.5	21	40	15	2.4	3	1	Yes	
KGDL 1625JX-2JCTM		●							7.7										
KGDR 1218JX-2.4JCTM	●		24	12	18	19.5	54	-	8.4	12	8.5	21	44	11	2.4	3	1	Yes	GD..2420... GD..2520... GD..3020...
KGDL 1218JX-2.4JCTM		●							7.7			21.5							
KGDR 1625JX-2.4JCTM	●		32	16	25	24.5	44	65	12.2	16	4.5	21	40	15	2.4	3	1	Yes	
KGDL 1625JX-2.4JCTM		●							7.7										
KGDR 1218JX-3JCTM	●		24	12	18	19.5	54	-	8.6	12	21	120	44	10.8	3	3	1	Yes	GD..3020... GD..3520... GD..4020...
KGDL 1218JX-3JCTM		●							7.7	8.5	21.5		40	14.8					
KGDR 1625JX-3JCTM	●		32	16	25	24.5	44	65	12.2	16	4.5	21	40	14.8	3	4	1	Yes	
KGDL 1625JX-3JCTM		●							7.7										

Description	Spare parts			
	Plug	Plug	Screw	Wrench
KGDR 1218JX-2JCTM	GP-1	HSSX4LP	SB-40120TR	LTW-15S
KGDL 1218JX-2JCTM				
KGDR 1625JX-2JCTM	GP-1	HSSX4LP	SB-40120TR	LTW-15S
KGDL 1625JX-2JCTM				
KGDR 1218JX-2.4JCTM	GP-1	HSSX4LP	SB-40120TR	LTW-15S
KGDL 1218JX-2.4JCTM				
KGDR 1625JX-2.4JCTM	GP-1	HSSX4LP	SB-40120TR	LTW-15S
KGDL 1625JX-2.4JCTM				
KGDR 1218JX-3JCTM	GP-1	HSSX4LP	SB-40120TR	LTW-15S
KGDL 1218JX-3JCTM				
KGDR 1625JX-3JCTM	GP-1	HSSX4LP	SB-40120TR	LTW-15S
KGDL 1625JX-3JCTM				

● : Standard item R : Right-hand only L : Left-hand only □ : Check availability



KGD polygon taper shank (External grooving)

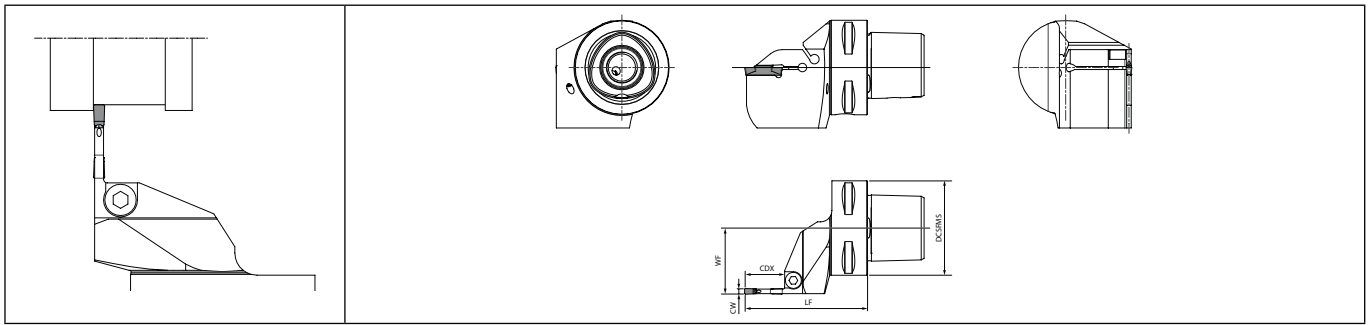

Right-hand shown

Toolholder dimensions

Description	Availability		Polygon size	Dimension (mm)						Coolant hole	Spare parts	
	R	L		DCS/FMS	LF	WF	CDX	CW min.	CW max.		Clamp bolt	Applicable inserts G30~G33
KUA-KPC4-KGD [®] /L 2T17	●	●	C4	40	60	27	17	2.0	3.0	Yes	HH5X16	GDG2020N-... - GDMS3020R-...
KUA-KPC5-KGD [®] /L 2T17	●	●	C5	50	60	35	17					GDG2020N-... - GDMS3020R-...
KUA-KPC4-KGD [®] /L 3T20	●	●	C4	40	65	27	20	3.0	4.0			GDG3020N-... - GDMS4020R-...
KUA-KPC5-KGD [®] /L 3T20	●	●	C5	50	65	35	20					GDG3020N-... - GDMS4020R-...
KUA-KPC6-KGD [®] /L 3T20	●	●	C6	60	65	45	20	4.0	5.0			GDG3020N-... - GDMS4020R-...
KUA-KPC4-KGDR 4T25	●		C4	40	70	27	25					GDG4020N-... - GDMS5020N-...
KUA-KPC5-KGDR 4T25	●		C5	50	70	35	25	4.0	5.0			GDG4020N-... - GDMS5020N-...
KUA-KPC6-KGD 4T25	●		C6	60	70	45	25					GDG4020N-... - GDMS5020N-...
KUA-KPC4-KGD 5T25	●		C4	40	70	27	25	5.0	6.0			GDG5020N-... - GDMS6020N-...
KUA-KPC5-KGD 5T25	●		C5	50	70	35	25					GDG5020N-... - GDMS6020N-...
KUA-KPC6-KGD 5T25	●		C6	60	70	45	25					GDG5020N-... - GDMS6020N-...

Applicable Pressure : ~7MPa

Recommended tightening torque : 6.5 N·m

CDX : Maximum depth to which processing can be made. (If the CDX is 20 mm or more, the maximum groove-depth of groove made by the 2-edge insert will be 18 mm.)

G

Grooving

External

Internal

Face

● : Standard item R : Right-hand only L : Left-hand only □ : Check availability

KGD-S (External grooving / 0° separate type)

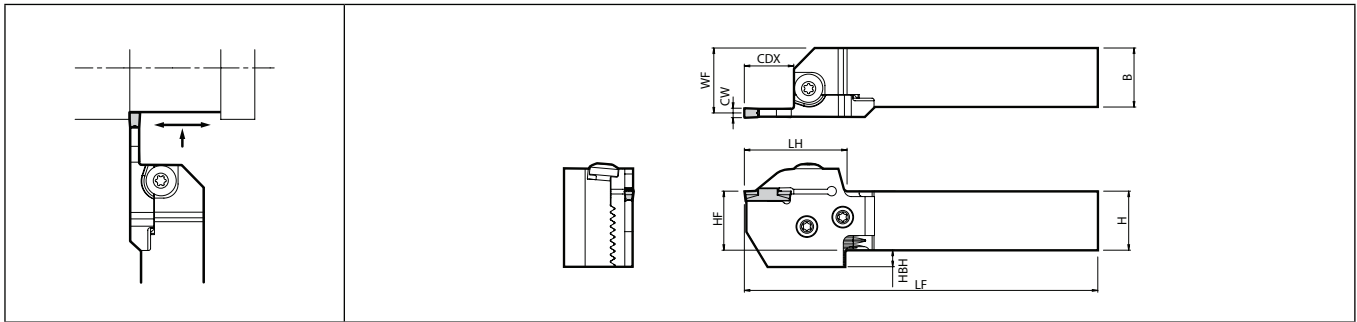

Right-hand shown (Right-hand blade and right-hand toolholder)

Toolholder dimensions (Blade and toolholder)

Shank angle	Width (mm)	Max. depth of cut (mm)	Shank size (mm)	Unit description	Availability		Blade description G43	Toolholder description G43	Dimension (mm)										Spare parts					
					R	L			CDX	H	B	LH	HF	HBH	LF	WF	CW min.	CW max.	Clamp bolt (for insert clamp)	Screw (for blade)	Wrench			
0°	2	17	□20	KGD%L 2020X-2T17S	●		KGD%L-2T17-C	KGD%L 2020-C	17	20	20	20	12	122	23.4	2	3	BH6X10TR	SB-60120TR	LTW-25				
			□25	2525X-2T17S	●	●				KGD%L 2525-C	25	25	40	25	7						147	28.4		
			□32	No unit description ⇔						KGD%L 3232-C	32	32		32	-						167	35.4		
	3	10	10	□20	KGD%L 2020X-3T10S	●		KGD%L-3T10-C	KGD%L 2020-C	10	20	20	20	12	115	23	3				4			
				□25	2525X-3T10S	●	●				KGD%L 2525-C	25	25	33	25	7						140	28	
				□32	No unit description ⇔						KGD%L 3232-C	32	32		32	-						160	35	
	3	20	20	□20	KGD%L 2020X-3T20S	●	●	KGD%L-3T20-C	KGD%L 2020-C	20	20	20	20	12	125	23	3				4			
				□25	2525X-3T20S	●	●				KGD%L 2525-C	25	25	43	25	7						150	28	
				□32	3232X-3T20S	●					KGD%L 3232-C	32	32		32	-						170	35	
	4	10	10	□20	KGD%L 2020X-4T10S	●		KGD%L-4T10-C	KGD%L 2020-C	10	20	20	33	20	12	115	22.5				4	5		
				□25	2525X-4T10S	●	●				KGD%L 2525-C	25	25	33	25	7	140						27.5	
				□32	No unit description ⇔						KGD%L 3232-C	32	32		32	-	160						34.5	
		4	20	20	□20	KGD%L 2020X-4T20S	●		KGD%L-4T20-C	KGD%L 2020-C	20	20	20	20	12	125	22.5				4	5		
					□25	2525X-4T20S	●	●				KGD%L 2525-C	25	25	43	25	7						150	27.5
					□32	3232X-4T20S	●					KGD%L 3232-C	32	32		32	-						170	34.5
	4	25	25	□20	KGD%L 2020X-4T25S	●	●	KGD%L-4T25-C	KGD%L 2020-C	25	20	20	20	12	130	22.5	4				5			
				□25	2525X-4T25S	●	●				KGD%L 2525-C	25	25	48	25	7						155	27.5	
				□32	3232X-4T25S	●					KGD%L 3232-C	32	32		32	-						175	34.5	
	5	10	10	□20	KGD%L 2020X-5T10S	●	●	KGD%L-5T10-C	KGD%L 2020-C	10	20	20	33	20	12	115	22				5	6		
				□25	2525X-5T10S	●	●				KGD%L 2525-C	25	25	33	25	7	140						27	
				□32	No unit description ⇔						KGD%L 3232-C	32	32		32	-	160						34	
		5	25	25	□20	No unit description ⇔			KGD%L 2020-C	KGD%L 2020-C	25	20	20	20	12	130	22				5	6		
	5	25	25	□25	KGD%L 2525X-5T25S	●	●	KGD%L-5T25-C	KGD%L 2525-C	25	25	25	48	25	7	155	27				5	6		
	5	25	25	□32	3232X-5T25S	●		KGD%L 3232-C	KGD%L 3232-C	25	32	32		32	-	175	34				5	6		

- When using the toolholder in normal mounting position, the lower jaw of toolholder may interfere with the tool presetter. Applicable inserts G30~G33
- The toolholder and blade descriptions are printed on the toolholder body. (Unit description is not printed.)
KGD-S: Right-hand blade for right-hand toolholder, left-hand blade for left-hand toolholder.
The toolholder is applicable for all blade with suitable hand.
- When the unit description is not available (No unit description) and/or stock status is "-", please purchase toolholder and blade separately.
- CDX: Maximum depth to which processing can be made. (If the CDX is 20 mm or more, the maximum groove-depth of groove made by the 2-edge insert will be 18 mm.)
Above toolholders are applicable to Cut-off, too.

● : Standard item R : Right-hand only L : Left-hand only □ : Check availability



KGDS-S (External grooving / 90° separate type)

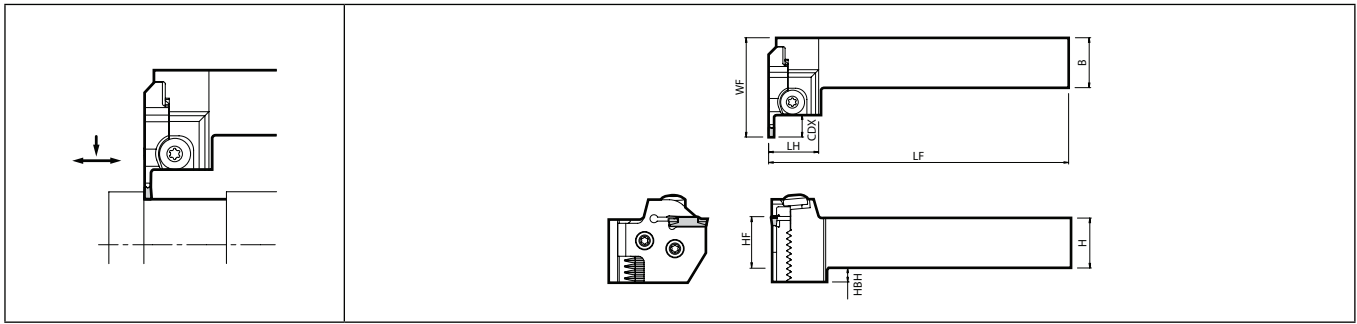

Right-hand shown (Left-hand blade and right-hand toolholder)

Toolholder dimensions (Blade and toolholder)

Shank angle	Width (mm)	Max. depth of cut (mm)	Shank size (mm)	Blade description G43	Toolholder description G43	Unit description	Availability		Dimension (mm)										Spare parts		
							R	L	CDX	H	B	LH	HF	HBH	LF	WF	CW min.	CW max.	Clamp bolt (for insert clamp)	Screw (for blade)	Wrench
90°	2	17	<input type="checkbox"/> 20	KGDR-2T17-C	KGDS%L.2020-C	-			17	20	20		20	12	125	56.7	2	3	BH6X10TR	SB-60120TR	LTW-25
			<input type="checkbox"/> 25	KGDS%L.2525-C	-						25	25		25	7	150					
	3	10	<input type="checkbox"/> 20	KGDR-3T10-C	KGDS%L.2020-C	KGDS%L 2020X-3T10S	● ●	● ●	10	20	20		20	12	125	49.7	3	4			
			<input type="checkbox"/> 25	KGDS%L.2525-C	-	● ●	● ●				25	25		25	7	150					
	20	20	<input type="checkbox"/> 20	KGDR-3T20-C	KGDS%L.2020-C	-			20	20	20		20	12	125	59.7	4	5			
			<input type="checkbox"/> 25	KGDS%L.2525-C	-						25	25		25	7	150					
	10	20	<input type="checkbox"/> 20	KGDR-4T10-C	KGDS%L.2020-C	-			10	20	20	27.7	20	12	125	49.7	5	6			
			<input type="checkbox"/> 25	KGDS%L.2525-C	-						25	25		25	7	150					
	20	25	<input type="checkbox"/> 20	KGDR-4T20-C	KGDS%L.2020-C	-			20	20	20		20	12	125	59.7	6	7			
			<input type="checkbox"/> 25	KGDS%L.2525-C	-						25	25		25	7	150					
	25	25	<input type="checkbox"/> 20	KGDR-4T25-C	KGDS%L.2020-C	-			25	20	20		20	12	125	64.7	7	8			
			<input type="checkbox"/> 25	KGDS%L.2525-C	-						25	25		25	7	150					
10	25	<input type="checkbox"/> 20	KGDR-5T10-C	KGDS%L.2020-C	-			10	20	20		20	12	125	49.7	8	9				
		<input type="checkbox"/> 25	KGDS%L.2525-C	-						25	25		25	7	150						
25	25	<input type="checkbox"/> 20	KGDR-5T25-C	KGDS%L.2020-C	-			25	20	20		20	12	125	64.7	9	10				
		<input type="checkbox"/> 25	KGDS%L.2525-C	-						25	25		25	7	150						

- When using the toolholder in normal mounting position, the lower jaw of toolholder may interfere with the tool presetter.
- The toolholder and blade descriptions are printed on the toolholder body. (Unit description is not printed.)
 KGDS-S : Left-hand Blade for Right-hand Toolholder, Right-hand Blade for Left-hand Toolholder.
 The toolholder is applicable for all blade with suitable hand.
- CDX : Maximum depth to which processing can be made. (If the CDX is 20 mm or more, the maximum groove-depth of groove made by the 2-edge insert will be 18 mm.)

Applicable inserts **G30~G33**

Toolholder identification system

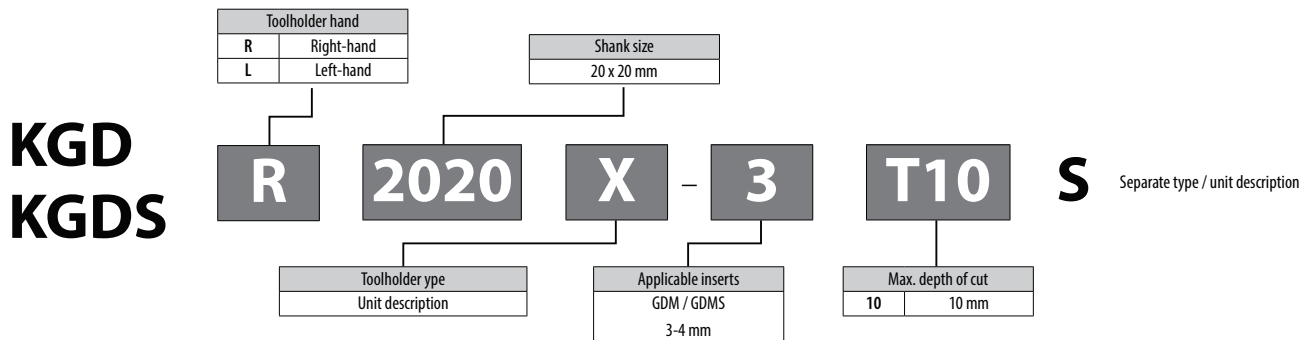

● : Standard item R : Right-hand only L : Left-hand only □ : Check availability

Toolholder dimensions (Blade and toolholder)

KGD-C (0° Separate Type)

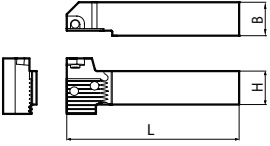
Drawing of 0° type Right-hand shown	Toolholder description	Availability		Dimension (mm)		
		R	L	L	B	H
	KGD%L 2020-C	●	●	104	20	20
	2525-C	●	●	129	25	25
	3232-C	●	●	149	32	32

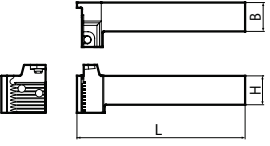

KGDS-C (90° Separate Type)

Drawing of 90° type Right-hand shown	Toolholder description	Availability		Dimension (mm)		
		R	L	L	B	H
	KGDS%L 2020-C	●	●	122	20	20
	2525-C	●	●	147	25	25

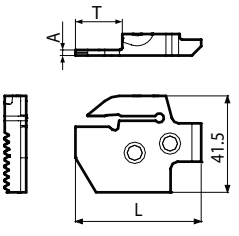
Blade

Drawing of blade Right-hand shown	Blade description	Availability		Dimension (mm)		
		R	L	L	T	A
	KGD%L -2T17-C	●	●	51.2	17.2	1.7
	-3T10-C	●	●	44.2	10.2	2.4
	-3T20-C	●	●	53.2	20.2	
	-4T10-C	●	●	44.2	10.2	3.4
	-4T20-C	●	●	54.2	20.2	
	-4T25-C	●	●	59.2	25.2	4.4
	-5T10-C	●	●	44.2	10.2	
	-5T25-C	●	●	59.2	25.2	

Spare parts

Unit description	Spare parts		
	Clamp bolt (for insert clamp)	Screw (for blade)	Wrench
KGD%L ...S KGDS%L ...S	 BH6X10TR	 SB-60120TR	 LTW-25

● : Standard item R : Right-hand only L : Left-hand only □ : Check availability

Setting the inserts

1. Use compressed air or other measures to remove chips from the insert mounting part (Ref. to Fig. 1).
2. Put the insert into the toolholder and push it makes contact with the back end of toolholder's surface (Ref. to Fig. 1 and 2).
3. Keeping the insert fit to the surface, tighten the insert clamp screw at an appropriate torque.
4. Make sure that there is no gap between the insert and the back end of the toolholder's surface and that the insert is set straight (Ref. to Fig. 2 and 3).

Clamp screw for automatic lathe	Recommended tightening torque: 2.0N-m (SB-40120TR) 2.5N-m (SE-50125TR)
Clamp bolt	Recommended tightening torque: 6.5N-m (Width 2~6 mm) 8.0N-m (Width 8 mm)

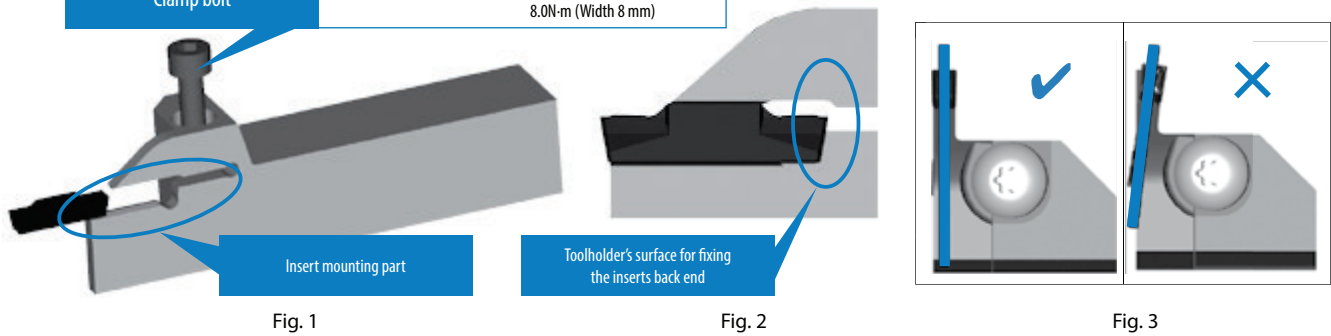

Fig. 1

Fig. 2

Fig. 3

Setting the blade (Separate type toolholder)

1. Use compressed air or other measures to remove chips and dust from the serration part (Ref. to Fig. 1).
 2. Mate and fit the serrations of the blade and toolholder, and also fit the blade end to the toolholder. (Ref. to Fig. 2)
 3. Tighten the blade fixing screws at an appropriate torque. You can tighten them in any order. (Ref. to Fig. 2)
- Recommended tightening torque : 8N-m
4. Set the insert after setting the blade.

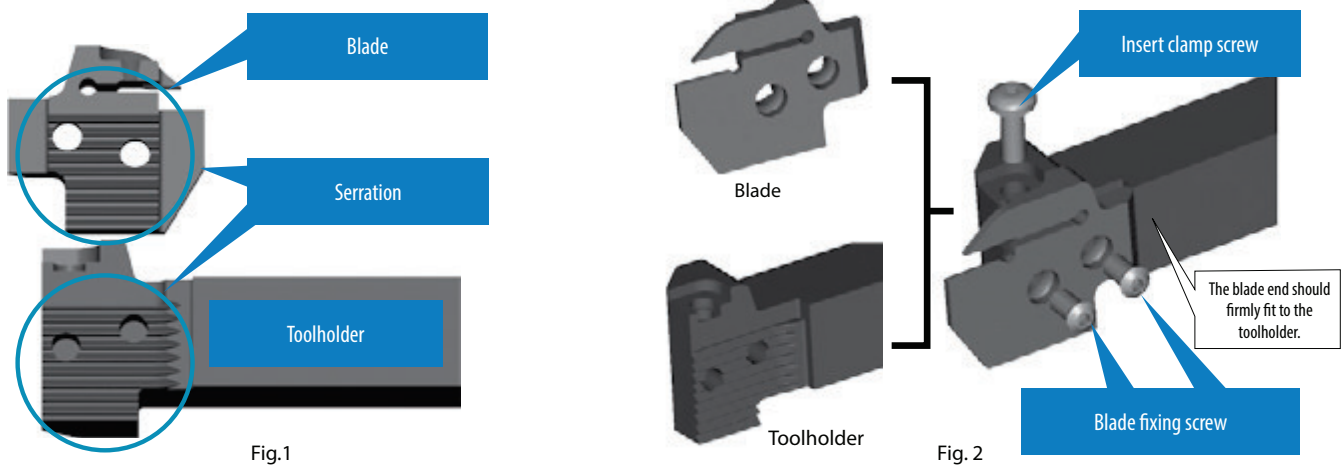
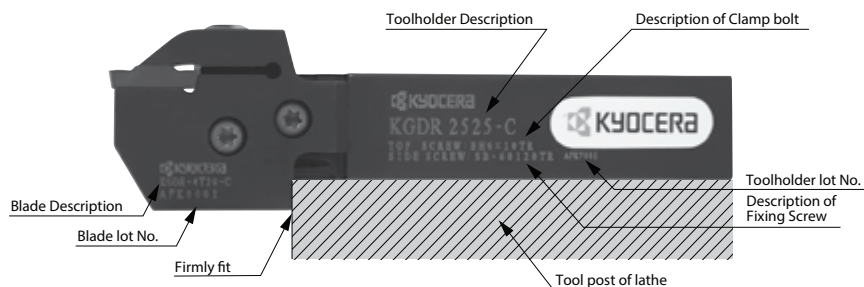

Fig.1

Fig. 2

Separate type toolholder identification system and their setting to lathe

Firmly fit the lower jaw to the tool post of the lathe.



Recommended cutting conditions (cutting speed Vc)

Workpiece material	Chipbreaker	Recommended insert grades (Vc: m/min)								Remarks	
		Cermet		MEGACOAT NANO	MEGACOAT		Carbide	MEGACOAT CBN	CBN		PCD
		TN620	TN90	PR1535	PR1225	PR1215	GW15	KBN05M	KBN570		KPD001
Carbon steel	GM	☆ 80~220	☆ 100~220	☆ 80~200	★ 80~200	☆ 100~200	-	-	-	-	
Alloy steel	GL	☆ 70~200	☆ 80~200	☆ 70~180	★ 70~180	☆ 80~180	-	-	-	-	
Stainless steel	CM	-	-	★ 60~150	☆ 60~150	☆ 60~150	-	-	-	-	
Cast iron	PH	-	-	-	-	★ 100~200	-	-	-	-	
Aluminum	GS	-	-	-	-	-	☆ 200~500	-	-	★ 150~2,000	
Brass	NB	-	-	-	-	-	☆ 100~200	-	-	★ 200~800	
Hard materials	NB	-	-	-	-	-	-	★ 80~150	-	-	
Sintered steel		-	-	-	-	-	-	-	★ 100~250	-	

★:1st recommendation ☆:2nd recommendation

Recommended cutting conditions (feed rate / ap)

Workpiece material: C50

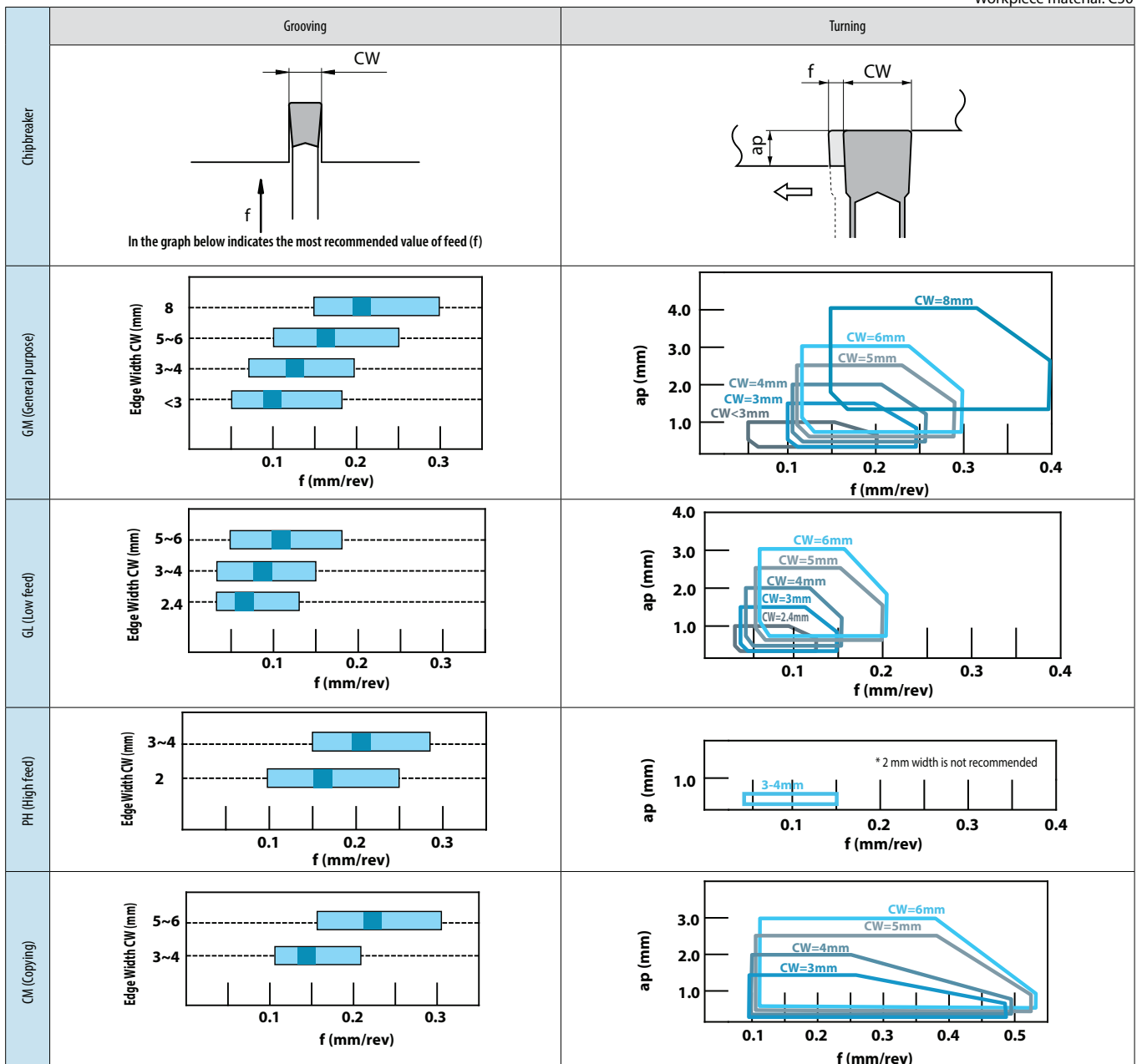

Grooving

Recommended cutting conditions (feed rate / ap)

Workpiece material: C50

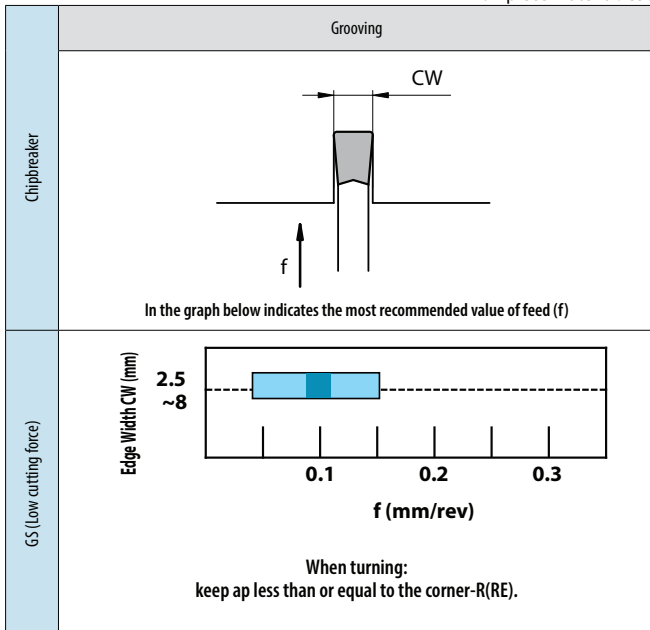

Note 1. The above values are based on the condition that CDX of toolholder is 17 mm or less.

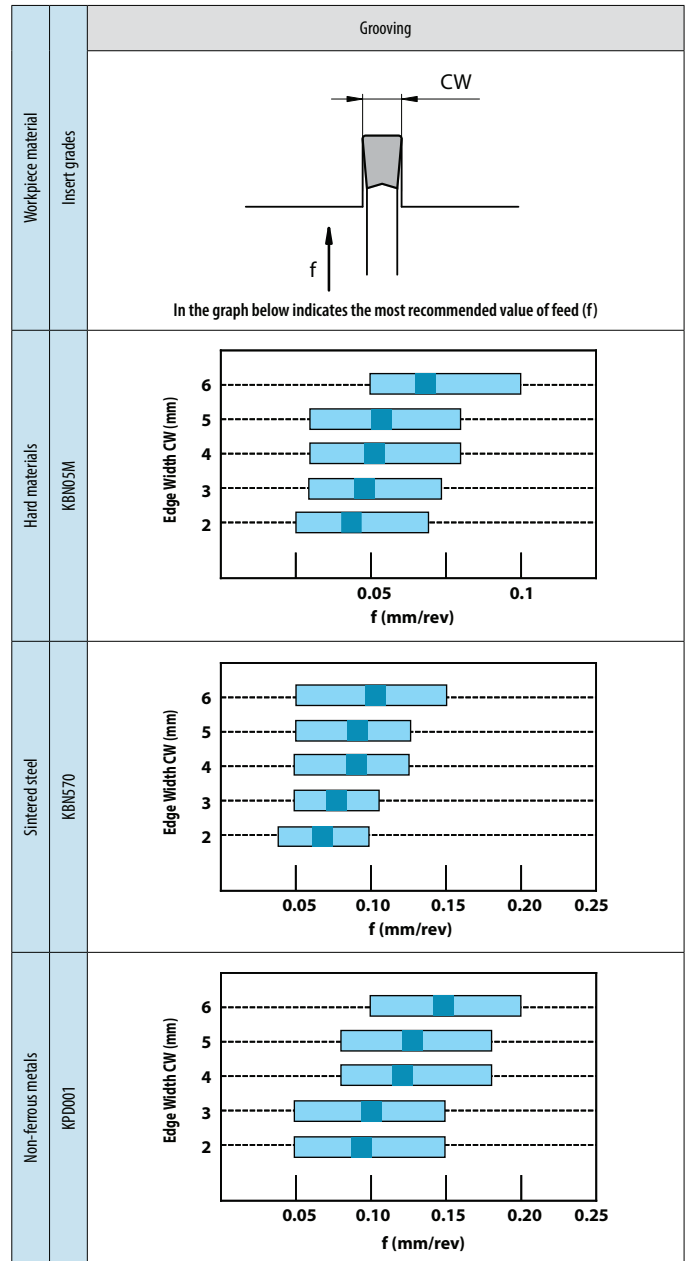

CM chipbreaker [Cutting amount (ap) in back copying]

Maximum ap in back copying

Description	Maximum ap (mm)				
	Toolholder description				
	KGD...-2T...	KGD...-3T...	KGD...-4T...	KGD...-5T...	KGD...-6T...
GDM 3020N-150R-CM	0.24	0.20	-	-	-
4020N-200R-CM	-	0.24	0.20	-	-
5020N-250R-CM	-	-	0.30	0.20	-
6020N-300R-CM	-	-	-	0.30	0.25

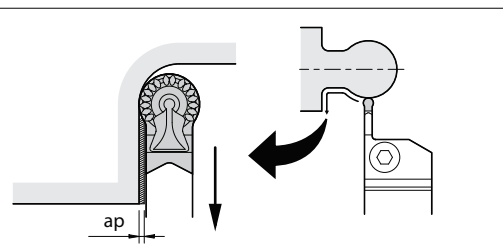

Guide for external grooving

Point 1 - Turning after grooving

1. Grooving depth over 0.5 mm: For roughing - refer to fig. 1

Before turning, pull the tool back about 0.1mm after grooving, instead of turning subsequent to grooving.

Failure to pull the tool back before traverse machining will result in an unbalanced load applied on only one side of the cutting edge.

2. Grooving depth under 0.5 mm: For finishing - refer to fig. 2

Turning subsequent to grooving is possible because shallow groove depths relate a small load on the cutting edge.

Retention time is not necessary.

Point 2

1. When widening the groove width (Refer to Fig.3), apply the "Step Turning."

2. The widened groove and side walls should be finished last. For better chip control, ap over 0.5 mm is recommended. Note: If the workpiece is not supported at the center, reduce the feed rate when grooving towards center.

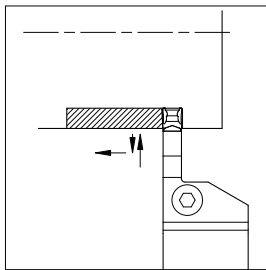

Fig.1

Before turning, pull the tool back about 0.1 mm after grooving.
Grooving depth over 0.5 mm: At roughing

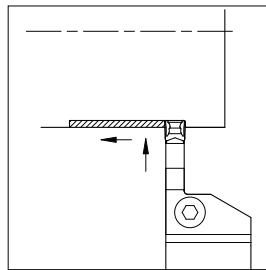

Fig. 2

Turning subsequent to grooving.
Grooving depth under 0.5 mm: At finishing

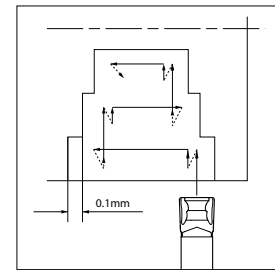

Fig. 3



Case Studies

17Cr3 (Grooving)		20CrMo5 (Grooving / Turning)	
Gear $V_c = 113 \sim 164$ m/min $f = 0.06$ mm/rev Wet GDM4020N-040GM (PR1225) KGDL2525X-3T10S		Gear $V_c = 170$ m/min $f = 0.15$ mm/rev (Roughing) 0.10 mm/rev (Finishing) $a_p = 0.2$ mm (Finishing) Wet GDM4020N-040GM (PR1215) KGDR2525X-4T20S	
GM chipbreaker (PR1225)	1,500 pcs/c	GM chipbreaker (PR1215)	250 pcs/c
Competitor K (PVD coated carbide)	250 pcs/c	Competitor L (Roughing: PVD coated carbide; Finishing: cermet)	200 pcs/c
<ul style="list-style-type: none"> GM chipbreaker (PR1225) showed 6 times longer tool life than that of Competitor K. Good chip control without burned chips. 		<ul style="list-style-type: none"> GM chipbreaker reduced occurrence rate of tangle of chips (occurrence rate 80% to 10%). The problem was persistent with Competitor L. Machining productivity is improved. 	

Evaluation by the user

Evaluation by the user



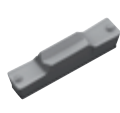
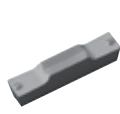

GM/GMN/GMM/GMG/GMGA/FGG

Insert		Description		Dimension (mm)				Tolerance (mm)		Carbide					Cermets	Applicable toolholder G55~G58 G95	
				No. of edges	CW	S	RE	INSL	CW min.	CW max.	CVD						
											CP9025	PR905	PR915	PR930			KW10
				Carbon steel / Alloy steel						●					P		
				Stainless steel						●					M		
				Cast iron						●					K		
				Non-ferrous metals						●					N		
				Titanium alloy						●					S		
				Hard materials (~ 40HRC)						○					H		
				Hard materials (40HRC ~)						●							
	 <p>Shows GMM2420-02</p> <p>Chip control oriented / M class</p>	GMM 2420-020MW	2	2.4	4.3	0.2	20	-0.05	+0.05	●	●	●	●	●	●	KGM...2.5(...) KGM...2(...)	
		GMM 3020-020MW 3020-040MW	2	3	4.3	0.2 0.4	20	-0.05	+0.05	●	●	●	●	●	●	●	KGM...3(...) KGM...2(...)
		GMM 4020-020MW 4020-040MW 4020-080MW	2	4	4.3	0.2 0.4 0.8	20	-0.05	+0.05	●	●	●	●	●	●	●	KGM...4(...) KGM...3(...)
		GMM 5020-040MW 5020-080MW	2	5	4.3	0.4 0.8	20	-0.05	+0.05	●	●	●	●	●	●	●	KGM...5(...) KGM...4(...)
		GMM 6020-040MW 6020-080MW	2	6	4.3	0.4 0.8	20	-0.05	+0.05	●	●	●	●	●	●	●	KGMR...6T30 KGM...5(...)
		GMM 8030-080MW	2	8	5.5	0.8	30	-0.05	+0.05	●	●	●	●	●	●	●	KGM%L 2525M-8 KIGM...6540B-8 KFMS...-8
 <p>Sharp cutting oriented / M class</p>	GMM 3020-020MS 3020-040MS	2	3	4.3	0.2 0.4	20	-0.05	+0.05	●	●	●	●	●	●	KGM...3(...) KGM...2(...)		
	GMM 4020-040MS	2	4	4.3	0.4	20	-0.05	+0.05	●	●	●	●	●	●	KGM...4(...) KGM...3(...)		
	GMM 5020-040MS	2	5	4.3	0.4	20	-0.05	+0.05	●	●	●	●	●	●	KGM...5(...) KGM...4(...)		
 <p>Sharp cutting oriented / Precision class</p>	GMG 3020-000MS 3020-020MS 3020-040MS	2	3	4.3	0 0.2 0.4	20	-0.02	+0.02	●	●	●	●	●	●	KGM...3(...) KGM...2(...)		
	GMG 4020-020MS 4020-040MS 4020-080MS	2	4	4.3	0.2 0.4 0.8	20	-0.02	+0.02	●	●	●	●	●	●	KGM...4(...) KGM...3(...)		
	GMG 5020-040MS 5020-080MS	2	5	4.3	0.4 0.8	20	-0.02	+0.02	●	●	●	●	●	●	KGM...5(...) KGM...4(...)		
	GMG 6020-080MS	2	6	4.3	0.8	20	-0.02	+0.02	●	●	●	●	●	●	KGMR...6T30 KGM...5(...)		

Recommended cutting conditions → G148

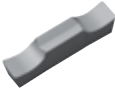
● : Standard item R : Right-hand only L : Left-hand only □ : Check availability







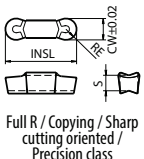

GM/GMN/GMM/GMG/GMGA/FGG

		Carbon steel / Alloy steel		Stainless steel		Cast iron		Non-ferrous metals		Titanium alloy		Hard materials (~ 40HRC)		Hard materials (40HRC ~)									
Insert	Description	No. of edges	Dimension (mm)				Tolerance (mm)		Carbide					Applicable toolholder G55~G60									
			CW	S	RE	INSL	CW min.	CW max.	Cermat														
									CVD	PVD	-	-	-										
								CB9025	PR905	PR915	PR930	KW10	TN90										
 <p>Sharp cutting oriented / Precision class (ground chipbreaker)</p>	GMG 2520-030MG	2	2.5	4.3	0.3	20	-0.03	+0.03														KGM...2.5(...) KGM...2(...)	
	GMG 3020-030MG	2	3	4.3	0.3	20	-0.03	+0.03														KGM...3(...) KGM...2(...)	
	GMG 3520-030MG	2	3.5	4.3	0.3	20	-0.03	+0.03														KGM...3(...)	
	GMG 4020-040MG	2	4	4.3	0.4	20	-0.03	+0.03														KGM...4(...) KGM...3(...)	
	GMG 5020-040MG	2	5	4.3	0.4	20	-0.03	+0.03														KGM...5(...) KGM...4(...)	
	GMG 6020-040MG	2	6	4.3	0.4	20	-0.03	+0.03															KGMR...6T30 KGM...5(...)
	GMG 8030-050MG	2	8	5.5	0.5	30	-0.03	+0.03															KGM%L 2525M-8 KIGM...6540B-8 KFMS...-8
 <p>Chip control oriented / M class / Full R / Copying</p>	GMM 3020-150R	2	3	4.3	1.5	20	-0.05	+0.05														KGM...3(...) KGM...2(...)	
	GMM 4020-200R	2	4	4.3	2	20	-0.05	+0.05															KGM...4(...) KGM...3(...)
	GMM 5020-250R	2	5	4.3	2.5	20	-0.05	+0.05															KGM...5(...) KGM...4(...)
	GMM 6020-300R	2	6	4.3	3	20	-0.05	+0.05															KGMR...6T30 KGM...5(...)
 <p>Full R / Copying / Sharp cutting oriented / Precision class</p>	GMG 3020-150R	2	3	4.3	1.5	20	-0.02	+0.02														KGM...3(...) KGM...2(...)	
	GMG 4020-200R	2	4	4.3	2	20	-0.02	+0.02															KGM...4(...) KGM...3(...)
	GMG 5020-250R	2	5	4.3	2.5	20	-0.02	+0.02															KGM...5(...) KGM...4(...)
 <p>Chip control oriented / Undercutting</p>	GMG 3020-150RU	2	3	4.3	1.5	20	-0.02	+0.02															KGM...3(...) KGM...2(...) KGMUR2525M
	GMG 4020-200RU	2	4	4.3	2	20	-0.02	+0.02															KGM...4(...) KGM...3(...) KGMUR2525M

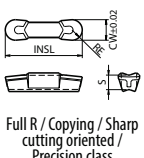
Recommended cutting conditions G143

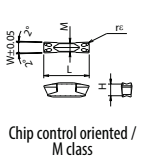
● : Standard item R : Right-hand only L : Left-hand only □ : Check availability

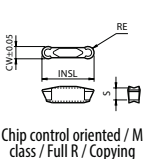
GM/GMN/GMM/GMG/GMGA/FGG

		Carbon steel / Alloy steel		Stainless steel		Cast iron		Non-ferrous metals		Titanium alloy		Hard materials (~ 40HRC)		Hard materials (40HRC ~)		
		●		☺		☺		●		●		●		●		
		P		M		K		N		S		H				
Insert	Description	No. of edges	Dimension (mm)				Tolerance (mm)		Carbide			Cement	Applicable toolholder ➔ G56~G58 G95			
			CW	S	RE	INSL	CW min.	CW max.	CVD	PVD	-					
									CB9025	PR930	KW10			TN90		
	 Full R / Copying / Sharp cutting oriented / Precision class	2	6	4.3	3	20	-0.02	+0.02	●							KGM%L...5 KGM%L...5T
	 Full R / Copying / Sharp cutting oriented / Precision class	2	8	5.5	4	30	-0.02	+0.02	●							KGM%L2525M-8 KIGM%L6540B-8 KIGMUR6540B-8 KFMS...-8
	 Chip control oriented / M class	2	3	4.3	0.4	14	-0.05	+0.05	●	●						-
	 Chip control oriented / M class / Full R / Copying	2	3	4.3	1.5	14	-0.05	+0.05			●					-
	FGGR 3020-02	2	3	4.3	0.2	20	-0.02	+0.02	●	●	●					KGMMR2525M-3 KGMRSR2525M-3
	FGGL 3020-02								●	●	●					
	FGGR 4020-04	2	4	4.3	0.4	20	-0.02	+0.02	●	●	●					
	FGGL 4020-04								●	●	●					
FGGR 5020-04	2	5	4.3	0.4	20	-0.02	+0.02	●	●	●						
FGGL 5020-04								●	●	●						

Handed insert shows Right-hand

Recommended cutting conditions ➔ G143

● : Standard item R : Right-hand only L : Left-hand only ☐ : Check availability

G







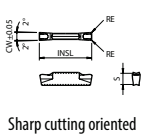

Grooving

External

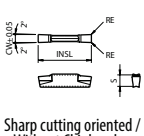
Internal

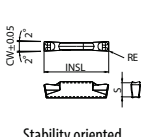
Face

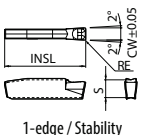
GM/GMN/GMM/GMG/GMGA/FGG

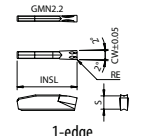
Insert		Description		Dimension (mm)				Tolerance (mm)		Carbide					Applicable toolholder G55~G58			
				No. of edges	CW	S	RE	INSL	CW min.	CW max.	Cermat							
											CVD	PVD	-	-		-		
												CB9025	PR905	PR915	PR930	KW10	TN90	
										<input checked="" type="checkbox"/> <input checked="" type="checkbox"/> <input checked="" type="checkbox"/> <input checked="" type="checkbox"/> <input checked="" type="checkbox"/> <input checked="" type="checkbox"/>					P			
										<input checked="" type="checkbox"/> <input checked="" type="checkbox"/> <input checked="" type="checkbox"/> <input checked="" type="checkbox"/> <input checked="" type="checkbox"/> <input checked="" type="checkbox"/>					M			
										<input checked="" type="checkbox"/> <input checked="" type="checkbox"/> <input checked="" type="checkbox"/> <input checked="" type="checkbox"/> <input checked="" type="checkbox"/> <input checked="" type="checkbox"/>					K			
										<input checked="" type="checkbox"/> <input checked="" type="checkbox"/> <input checked="" type="checkbox"/> <input checked="" type="checkbox"/> <input checked="" type="checkbox"/> <input checked="" type="checkbox"/>					N			
										<input checked="" type="checkbox"/> <input checked="" type="checkbox"/> <input checked="" type="checkbox"/> <input checked="" type="checkbox"/> <input checked="" type="checkbox"/> <input checked="" type="checkbox"/>					S			
										<input type="checkbox"/> <input checked="" type="checkbox"/> <input checked="" type="checkbox"/> <input checked="" type="checkbox"/> <input checked="" type="checkbox"/> <input checked="" type="checkbox"/>					H			
										<input type="checkbox"/> <input type="checkbox"/> <input type="checkbox"/> <input type="checkbox"/> <input type="checkbox"/> <input type="checkbox"/>					H			
 <p>Sharp cutting oriented</p>		GMM 1520-MT	2	1.5	4.3	0 0.05	20	-0.05	+0.05								KGM...1.5(...)	
		GMM 2020-MT	2	2	4.3	0 0.05	20	-0.05	+0.05									KGM...2(...) KGM...1.5(...)
		GMM 2520-MT	2	2.5	4.3	0 0.05	20	-0.05	+0.05									KGM...2.5(...) KGM...2(...)
		GMM 3020-MT	2	3	4.3	0 0.05	20	-0.05	+0.05									KGM...3(...) KGM...2(...)
 <p>Sharp cutting oriented / Without Chipbreaker</p>		GMM 1520-NB	2	1.5	4.3	0	20	-0.05	+0.05								KGM...1.5(...)	
		GMM 2020-NB	2	2	4.3	0	20	-0.05	+0.05									KGM...2(...) KGM...1.5(...)
		GMM 3020-NB	2	3	4.3	0	20	-0.05	+0.05									KGM...3(...) KGM...2(...)
 <p>Stability oriented</p>		GMM 2020-TK	2	2	4.3	0.2	20	-0.05	+0.05								KGM...2(...) KGM...1.5(...)	
		GMM 2520-TK	2	2.5	4.3	0.2	20	-0.05	+0.05									KGM...2.5(...) KGM...2(...)
		GMM 3020-TK	2	3	4.3	0.25	20	-0.05	+0.05									KGM...3(...) KGM...2(...)
 <p>1-edge / Stability oriented</p>		GMN 2-TK	1	2	4.3	0.2	20	-0.05	+0.05								KGM...2(...) KGM...1.5(...)	
		GMN 3-TK	1	3	4.3	0.25	20	-0.05	+0.05									KGM...3(...) KGM...2(...)
		GMN 4-TK	1	4	4.3	0.3	20	-0.05	+0.05									KGM...4(...) KGM...3(...)
 <p>1-edge</p>		GMN 2.2	1	2.2	4.3	0.17	20	-0.05	+0.05								KGM...2(...)	
		GMN 3	1	3	4.3	0.2	20	-0.05	+0.05									KGM...3(...) KGM...2(...)
		GMN 4	1	4	4.3	0.25	20	-0.05	+0.05									KGM...4(...) KGM...3(...)
		GMN 5	1	5	4.3	0.8	20	-0.05	+0.05									KGM...5(...) KGM...4(...)
		GMN 6	1	6	4.3	0.8	20	-0.05	+0.05									KGMR...6T30 KGM...5(...)





Handed insert shows Right-hand

Recommended cutting conditions  G143

● : Standard item R : Right-hand only L : Left-hand only □ : Check availability



GM/GMN/GMM/GMG/GMGA/FGG

Insert		Description		Dimension (mm)						Angle (°)	Tolerance (mm)		Carbide					Applicable toolholder G55~G58	
				No. of edges	CW	S	RE	INSL	PSIR°L	CW min.	CW max.	CVD		PVD		Cemet			
												CB9025	PR905	PR915	PR930	KW10	TN90		
				Carbon steel / Alloy steel														P	
				Stainless steel															M
				Cast iron															K
				Non-ferrous metals															N
				Titanium alloy															S
				Hard materials (~ 40HRC)															
				Hard materials (40HRC ~)															H
 <p>Sharp cutting oriented</p>	GMM	1520R-MT-15D	2	1.5	4.3	0 0.05	20	15	-0.05	+0.05								KGM...1.5(...)	
	GMM	2020R-MT-15D 2020R-MT-15D 2020L-MT-15D	2	2	4.3	0 0.05 0	20	15	-0.05	+0.05								KGM...2(...) KGM...1.5(...)	
	GMM	2520R-MT-15D	2	2.5	4.3	0 0.05	20	15	-0.05	+0.05								KGM...2.5(...) KGM...2(...)	
	GMM	3020R-MT-15D 3020R-MT-15D 3020L-MT-15D	2	3	4.3	0 0.05 0	20	15	-0.05	+0.05								KGM...3(...) KGM...2(...)	
 <p>Stability oriented</p>	GMM	2020R-TK-8D	2	2	4.3	0.2	20	8	-0.05	+0.05								KGM...2(...) KGM...1.5(...)	
	GMM	2520R-TK-8D	2	2.5	4.3	0.2	20	8	-0.05	+0.05								KGM...2.5(...) KGM...2(...)	
	GMM	3020R-TK-8D	2	3	4.3	0.25	20	8	-0.05	+0.05								KGM...3(...) KGM...2(...)	
 <p>1-edge / Stability oriented</p>	GMR	2-TK-8D	1	2	4.3	0.2	20	8	-0.05	+0.05								KGM...2(...) KGM...1.5(...)	
	GMR	3-TK-8D	1	3	4.3	0.25	20	8	-0.05	+0.05								KGM...3(...) KGM...2(...)	
	GMR	4-TK-8D	1	4	4.3	0.3	20	8	-0.05	+0.05								KGM...4(...) KGM...3(...)	
 <p>1-edge / Sharp cutting oriented</p>	GMR GML	2.2-8D 2.2-8D	1	2.2	4.3	0.17	20	8	-0.05	+0.05								KGM...2(...)	
	GMR	2.2-15D	1	2.2	4.3	0	20	15	-0.05	+0.05									
	GMR GML	3-4D 3-4D	1	3	4.3	0.2	20	4	-0.05	+0.05								KGM...3(...) KGM...2(...)	
	GMR GML	4-4D 4-4D	1	4	4.3	0.25	20	4	-0.05	+0.05								KGM...4(...) KGM...3(...)	

Handed insert shows Right-hand

Recommended cutting conditions G143

● : Standard item R : Right-hand only L : Left-hand only □ : Check availability

GM/GMN/GMM/GMG/GMGA/FGG

Cutting edge preparation				Material										Applicable toolholder	
Symbol	Specification	Example												G55~G58	
F	Sharp edge	F	Sharp edge												
E	R-honed	E008	R0.08mm honed												
				Carbon steel / Alloy steel										P	
				Stainless steel										M	
				Cast iron										K	
				Non-ferrous metals										N	
				Titanium alloy										S	
				Hard materials (~ 40HRC)										H	
				Hard materials (40HRC ~)											
Insert	Description	Edge preparation type	No. of edges	Dimension (mm)					Tolerance (mm)		CBN PCD				Applicable toolholder
				CW	S	RE	INSL	LE	CW min.	CW max.	KBN510	KBN525	KPD001	KPD010	
	GMN 2	E008	1	2	4.3	0.2	20	2.9	-0.05	+0.05	●	●			KGM...2(...) KGM...1.5(...)
	GMN 2	F	1	2	4.3	0.2	20	2.9	-0.05	+0.05			●	●	
	GMN 3	E008	1	3	4.3	0.4	20	2.9	-0.05	+0.05	●	●			KGM...3(...) KGM...2(...)
	GMN 3	F	1	3	4.3	0.2	20	2.9	-0.05	+0.05			●	●	
	GMN 4	E008	1	4	4.3	0.4	20	2.9	-0.05	+0.05	●	●			KGM...4(...) KGM...3(...)
	GMN 4	F	1	4	4.3	0.2	20	2.9	-0.05	+0.05			●	●	
	GMN 5	F	1	5	4.3	0.2	20	2.9	-0.05	+0.05			●	●	KGM...5(...) KGM...4(...)
	GMN 6	F	1	6	4.3	0.2	20	2.9	-0.05	+0.05			●		KGMR...GT30 KGM...5(...)

Recommended cutting conditions G146



Features of Chipbreaker

Series	Insert	Features
GMM MW		Excellent chip evacuation at Grooving, Turning, Cut-off
GMG MG		Low cutting force with ground chipbreaker
GMG MS GMM MS		Grooving / Turning / Cut-off operations are minimum cutting force at Positive Edge
GMM MT		Small corner-R(RE) and minimize the core which remains in the center of the face
GMM TK		Large corner-R(RE) and stable performance at cut-off
GMM NB		Flat rake face and non-chipbreak It works well for brass

Edge Preparation

Edge Prep.	Chamfered + R-honed	Chamfered + R-honed
	Corner-R(RE) = 0.05	Sharp Corner
MT Chipbreaker	CR9025 / PR915	PR930 / KW10
Edge Prep.	Chamfered + R-honed	Sharp Edge
	Corner-R(RE) = 0.2 ~ 0.3	Corner-R(RE) = 0.2 ~ 0.3
TK Chipbreaker	CR9025 / PR915	PR930 / KW10
Edge Prep.	R-honed	Sharp Edge
	Corner-R(RE) = 0.05	Sharp Corner
Without Chipbreaker (-NB)	CR9025	PR930 / KW10

· Sharp Edge Spec. can reduce cutting force by 40% less than that of chamfer edge.

● : Standard item R : Right-hand only L : Left-hand only □ : Check availability

CBN & PCD Inserts are sold in 1 piece boxes

Available Cutting Diameter of KGM (for automatic lathe) / KGM-T

· There is a limit to available grooving depth depending on the workpiece diameter.

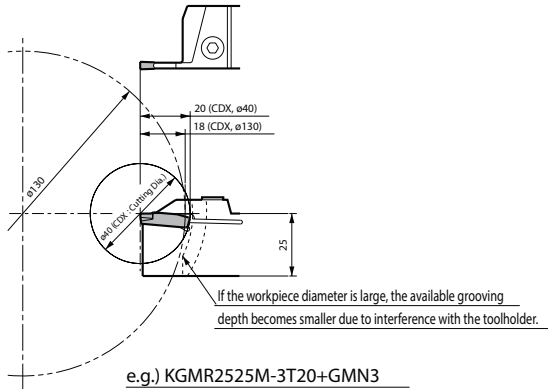

G

KGM (for automatic lathe) Possible Cutting Diameter and Available Grooving Depth Table

Toolholder Description		DCX (Cutting Dia.)															
KGM ⁹ /L	1010 □ -1.5...	-	-	-	-	-	-	-	18	21	26	38	76	∞			
	1212 □ -1.5...	-	-	-	-	23	27	37	71	∞	∞	∞	∞				
	1010 □ -2...	-	-	-	-	-	-	-	18	21	26	38	76				
	1212 □ -2...	-	-	-	-	23	27	37	71	∞							
	1616 □ -2...	30	37	47	68	89	131	∞	∞								
	1212 □ -2.5...	-	-	-	-	23	27	37	71								
	1616 □ -2.5...	30	37	47	68	89	131	∞	∞								
	1616 □ -3...	30	37	47	68	89	131	∞	∞								
Available Grooving Depth CDX (mm)		15	14	13	12	11.5	11	10	9	8	7	6	5	4	3	2	1

Grooving

External

Internal

Face

KGM-T Possible Cutting Diameter and Available Grooving Depth Table (GMN, GM⁹/L when using 1-edge insert)

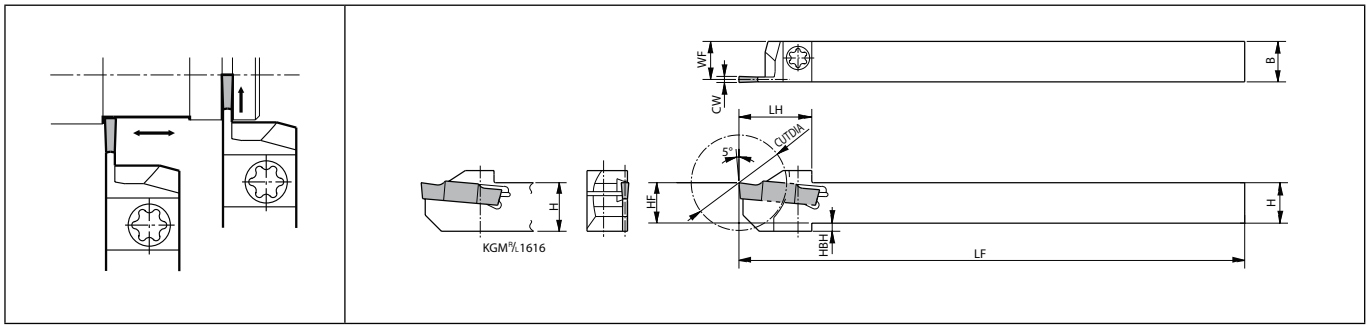

Toolholder Description		DCX (Cutting Dia.)														
KGM ⁹ /L	2012K-2T17	-	-	-	-	-	-	-	-	66	80	130	260	∞		
	2020K-2T17															
	2525M-2T17															
	1616H-3T20	-	-	-	-	-	40	54	70	100	180					
	2012K-3T20	-	-	-	-	-	40	90	130	240	∞	∞	∞			
	2020K-3T20															
	2525M-3T20															
	2020K-4T20															
	2525M-4T20	-	-	-	-	-	∞	∞	∞	∞						
	2525M-4T25	-	-	50	140	240	∞	∞	∞	∞						
	2525M-5T25															
	3232P-5T25															
	2525M-6T30	100	300	∞	∞	∞										
Available Grooving Depth CDX (mm)		30	27	25	23	22	20	19	18	17	16	15	14	13 or under		

KGM (External grooving)



Right-hand shown

Toolholder dimensions

Description	Availability		Dimension (mm)										Spare parts		Applicable inserts G48,G49 G51~G53	
													Screw	Wrench		
	R	L	CVDIA	H	B	LH	HF	HBH	LF	WF	CW min.	CW max.				
KGM%L 1010JX-1.5 1212F-1.5-85 1212JX-1.5	●	●	18	10	10	18	10		120	9.4	1.5	2	SE-40120TR	LTW-15S	GMM1520... GM.2(...)	
	●		23	12	12	19	12	2	85	11.4						
	●	●							120							
KGM%L 1010JX-2 1212F-2-85 1212JX-2 1616JX-2	●	●	18	10	10	18	10		120	9.15	2	3	SE-40120TR	LTW-15S	GM.2(...) GM.3(...)	
	●	●	23	12	12	19	12	2	85	11.15						
	●	●							120							
	●	●	30	16	16	24.5	16	-		15.15			SE-50125TR	LTW-20		
KGM%L 1212F-2.5-85 1212JX-2.5 1616JX-2.5	●		23	12	12	19	12	2	85	11	2.4	3	SE-40120TR	LTW-15S	GMM24... GM.25... GM.3(...)	
	●	●							120							15
	●	●							30				16	16		24.5
KGM%L 1616JX-3	●	●	30	16	16	24.5	16	-	120	14.8	3	4	SE-50125TR	LTW-20	GM.3(...), GM.4(...)	

If using a full-R insert, you need to modify the corner of insert adapter part of toolholder.
KGM will be switched to KGD=> G35



KGM (External grooving)

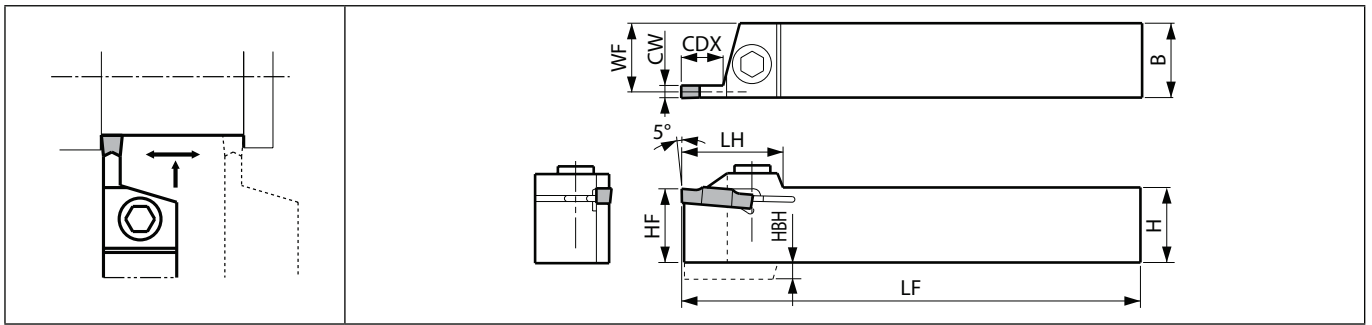

Right-hand shown

Toolholder dimensions

Description	Availability		Dimension (mm)										Spare parts				Applicable inserts G48~G53
													Clamp bolt	Clamp screw (Torx)	Wrench	Wrench	
	R	L	CDX	H	B	LH	HF	HBH	LF	WF	CW min.	CW max.					
KGM [®] /L 1212H-3 1616H-3 2020K-3 2525M-3	●		9	12	12	27	12	4	100	10.8	3	3	-	SB-5TR	-	LTW-20	GM.3(...) GM.4(...)
	●			16	16		16	14.8	4	HH5X16			-	LW-4	-		
	●	●		20	20		20	125		18.8			HH5X25	-	-	-	
	●	●		25	25		25	150	23.8	HH5X25			-	-	-		
KGM [®] /L 2020K-4 2525M-4	●		10	20	20	27	20	-	125	18.3	4	5	HH5X16	-	LW-4	-	GM.4(...) GM.5(...)
	●	●		25	25		25	150	23.3	HH5X25			-	-	-		
KGMR 2020K-5 2525M-5	●		10	20	20	27	20	-	125	17.8	5	6	HH5X16	-	LW-4	-	GM.5(...) GM.6(...)
	●			25	25		25	150	22.8	HH5X25			-	-	-		
KGM [®] /L 2525M-8	●	●	25	25	25	40	25	7.5	150	22	8	8	HH6X25	-	LW-5	-	GM..8030...

CDX shows available grooving depth.

4mm width Insert can be installed in KGM[®]/L 1212H-3, but is not recommended due to the toolholder's rigidity.

If using a full-R insert, you need to modify the corner of insert adapter part of toolholder.

KGM will be switched to KGD=> G34

● : Standard item R : Right-hand only L : Left-hand only □ : Check availability

KGM-T (External grooving / Deep grooving)

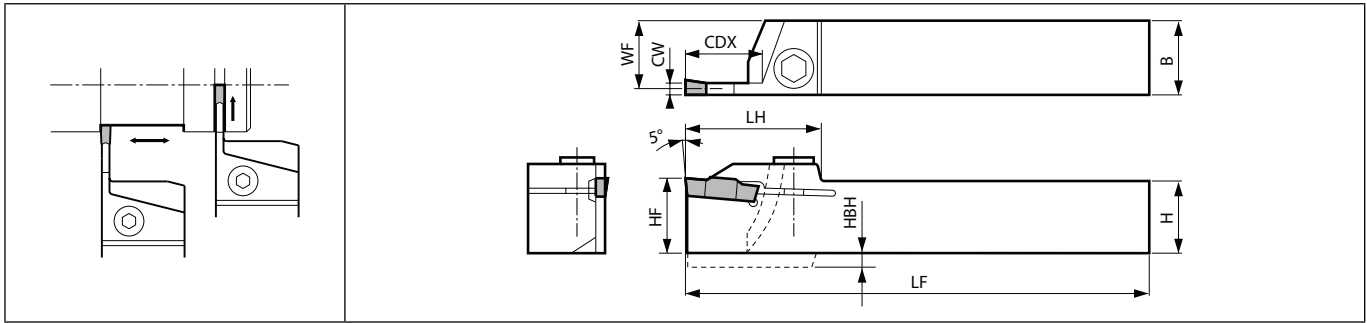

Right-hand shown

Toolholder dimensions

Description	Availability		Dimension (mm)										Spare parts				Applicable inserts G48~G53
													Clamp bolt	Clamp screw (Torx)	Wrench	Wrench	
	R	L	CDX	H	B	LH	HF	HBH	LF	WF	CW min.	CW max.					
KGM [®] L 2012K-2T17 2020K-2T17 2525M-2T17		●	17	20	12	33	20	-	125	11.15	2	3	-	SB-5TR	-	LTW-20	GM.2(...) GM.3(...)
	●	●		20	20				19.15	HH5X16			-	LW-4	-		
	●	●		25	25				24.15	HH5X25			-	LW-4	-		
KGM [®] L 1616H-3T20 2012K-3T20 2020K-3T20 2525M-3T20	●		20	16	16	36	20	4	100	14.8	3	4	HH5X16	-	LW-4	-	GM.3(...) GM.4(...)
		●		20	12				10.8	-			SB-5TR	-	LTW-20		
	●	●		20	20				18.8	HH5X16			-	LW-4	-		
	●	●		25	25				23.8	HH5X25			-	LW-4	-		
KGM [®] L 2020K-4T20 2525M-4T20 2525M-4T25	●		20	20	20	41	20	-	125	18.3	4	5	HH5X16	-	LW-4	-	GM.4(...) GM.5(...)
	●	●		25	25				23.3	HH5X25			-	LW-4	-		
	●	●		25	25				23.3	HH5X25			-	LW-4	-		
KGM [®] L 2525M-5T25 3232P-5T25	●		25	25	25	42	25	-	150	22.8	5	6	HH5X25	-	LW-4	-	GM.5(...) GM.6(...)
	●	●		32	32				29.8	HH5X25			-	LW-4	-		
KGMR 2525M-6T30	●		30	25	25	45	25	-	150	22.4	6	6	HH5X25	-	LW-4	-	GM6(...)

If using a full-R insert, you need to modify the corner of insert adapter part of toolholder.

CDX shows the distance from the toolholder to the cutting edge. Ref. to the Table (G54) for the relationship between the available grooving depth and the cutting dia.

When using GMG / GMM (2-edge) insert, set the groove depth under 15 mm.

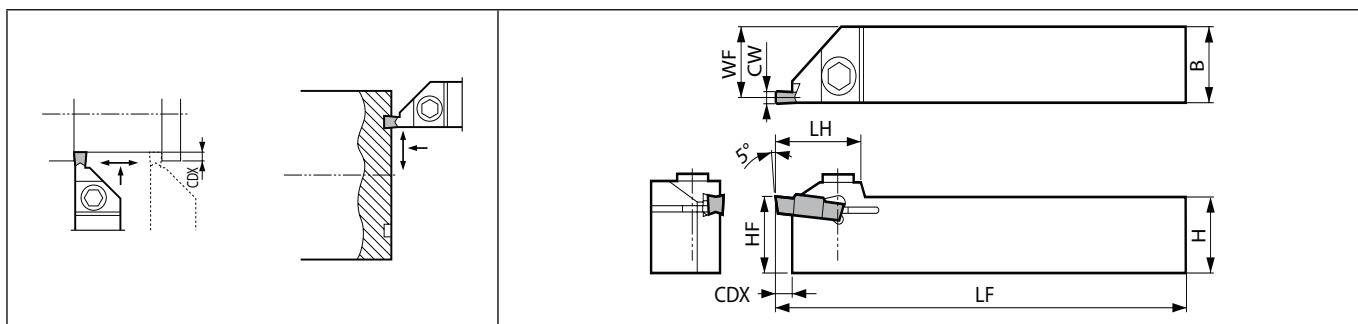

KGM will be switched to KGD=> G34

KGMM (External grooving / Face grooving)



Right-hand shown

Toolholder dimensions

Description	Availability		Dimension (mm)								Spare parts		Applicable inserts ● G48~G53
	R	CDX	H	B	LH	HF	LF	WF	CW min.	CW max.			
KGMMR 2525M-3	●	4.8	25	25	25	25	150	23.8	3	5	HH5X25	LW-4	FGG..., GM.3(...), GM.4(...), GM.5(...)

CDX shows available grooving depth. (Ref. to the table G59 for Face Grooving)

G

Grooving

External

Internal

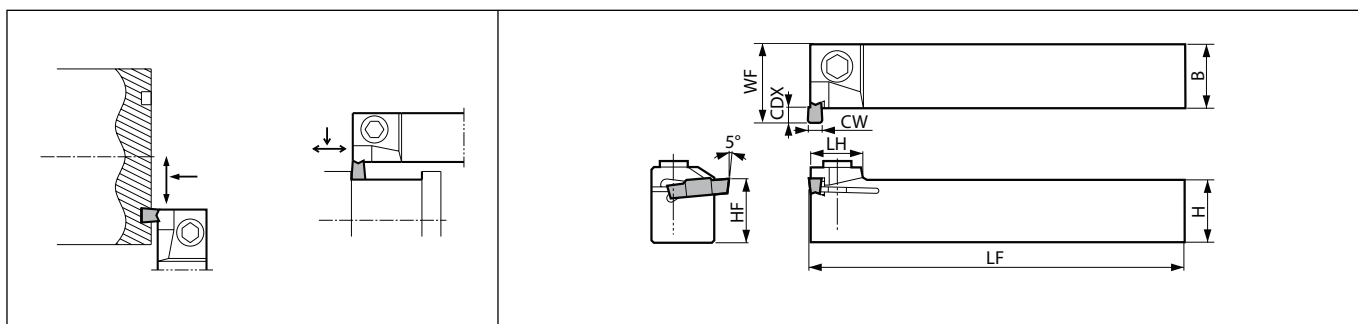

Face

KGMS (External grooving / Face grooving)



Right-hand shown

Toolholder dimensions

Description	Availability		Dimension (mm)								Spare parts		Applicable inserts ● G48~G53
	R	CDX	H	B	LH	HF	LF	WF	CW min.	CW max.			
KGMSR 2525M-3	●	4.8	25	25	17	25	150	30	3	5	HH5X25	LW-4	FGG..., GM.3(...), GM.4(...), GM.5(...)

CDX shows available grooving depth. (Ref. to the table G59 for Face Grooving)

● : Standard item R : Right-hand only L : Left-hand only □ : Check availability

Selection of Insert & Toolholder (Face Grooving)

Case of KGMM

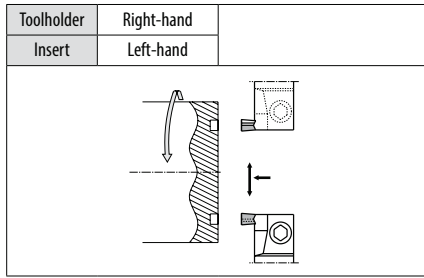
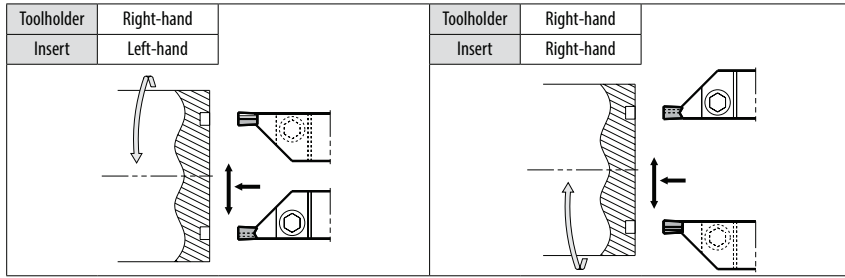

External dia. of the groove (min.) & Grooving Depth (Face Grooving)

KGMM / KGMS (Common) (mm)

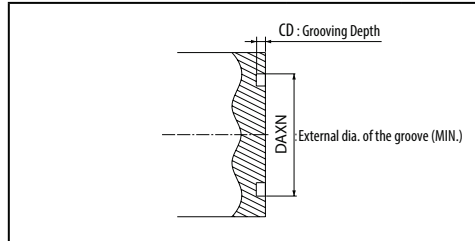

Description	DAXN	CD
GMG/GMM3020-○○○○□□	ø100	4.8
GMG/GMM4020-○○○○□□		
GMG/GMM5020-○○○○□□		
FGG [®] /L 3020-02	ø22	4.3
FGG [®] /L 4020-04	ø28	4.8
FGG [®] /L 5020-04	ø30	
GMG3020-150RU	ø22	4.3
GMG4020-200RU	ø28	4.8



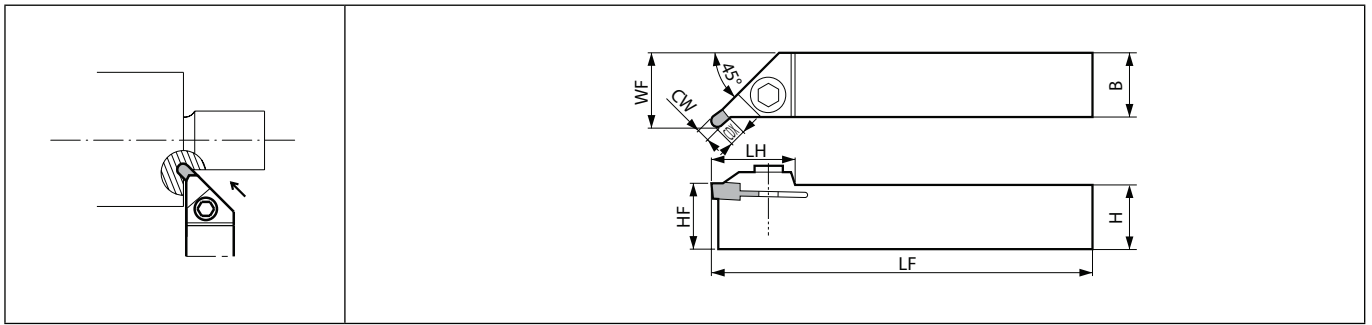

KGMU (External grooving / Undercut grooving)



Right-hand shown

Toolholder dimensions

Description	Availability		Dimension (mm)									Spare parts		Applicable inserts G49
	R	CDX	H	B	LH	HF	LF	WF	CW min.	CW max.				
KGMUR 2525M	●	4.8	25	25	28.5	25	150	28.6	3	5 (6)	HHSX25	LW-4	GMG3020..RU, GMG4020..RU	

CDX shows the distance from the toolholder to the cutting edge. Ref. to the table below for the available grooving depth.

WF shows at GMM5020-RU. () indicates external grooving inserts when installed.

External grooving inserts (grooving width 3 mm~6 mm) will be attached. (In case of using GMG○20-○○○□□, GMM○20-○○○□□, GMN○ insert)







Undercut Depth CD

Description	Undercut Depth	Distance from the face of the workpiece
	CD (mm)	ap (mm)
GMG3020-150RU	3.5	1.8
GMG4020-200RU	4.0	1.9

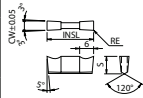
* In case of undercutting for the diameter 100mm or over, Inserts for External Grooving GMG○20-○○○□□, GMM○20-○○○□□, GMN○ are also available.

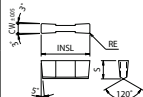
● : Standard item R : Right-hand only L : Left-hand only □ : Check availability

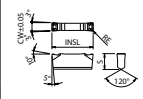
GH/GHU/GA

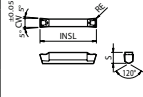
Cutting edge preparation				Material compatibility										Applicable toolholder					
				Carbon steel / Alloy steel										Stainless steel	Cast iron	Non-ferrous metals	Titanium alloy	Hard materials (~ 40HRC)	Hard materials (40HRC ~)
Symbol	Specification	Example		Edge preparation type	No. of edges	Dimension (mm)				Tolerance (mm)		Carbide		Ceramic		Cermet	G62~G64		
S	Chamfered and R-honed	S01020	0.10mm x 20° chamfered and R-honed			CW	S	RE	INSL	CW min.	CW max.	CVD	PVD	PVD	-			TC40	TN60
T	Chamfered	T01020	0.10mm x 20° chamfered																
 				-	2	4	7.5	0.2 0.5	20	-0.05	+0.05	●	●			●	●	KGH%L ...4 KGHS%L ...4	
				-	2	4.5	7.5	0.2 0.5	20	-0.05	+0.05						●		●
				-	2	5	7.5	0.2 0.5	20	-0.05	+0.05	●	●				●	●	KGH%L ...5 KGHS%L ...5
				-	2	5.5	7.5	0.2 0.5	20	-0.05	+0.05						●	●	
				-	2	6	7.5	0.2 0.5	20	-0.05	+0.05	●	●				●	●	KGH%L ...7 KGHS%L ...7
				-	2	6.5	7.5	0.2 0.5	20	-0.05	+0.05						●	●	
				-	2	7	7.5	0.2 0.5	20	-0.05	+0.05	●	●				●	●	KGH%L ...10
				-	2	7.5	7.5	0.2 0.5	20	-0.05	+0.05						●	●	
				-	2	8	7.5	0.2 0.5	20	-0.05	+0.05	●	●				●	●	
				-	2	10	7.5	0.5	25	-0.05	+0.05	●	●						
				-	2	12	7.5	0.5	25	-0.05	+0.05	●	●						
				 				S01020 T01020	2	4	7.5	0.5	20	-0.05	+0.05			●	●
S01020 T01020	2	5	7.5					0.5	20	-0.05	+0.05			●	●	●	●		
T01020	2	6	7.5					0.5	20	-0.05	+0.05					●	●	KGH%L ...7 KGHS%L ...7	
T01020	2	7	7.5					0.5	20	-0.05	+0.05					●	●		
 				-	2	4	7.5	0.25	20	-0.05	+0.05	●				●	●	KGH%L ...4 KGHS%L ...4	
				-	2	5	7.5	0.3	20	-0.05	+0.05	●					●		●
				-	2	6	7.5	0.3	20	-0.05	+0.05	●						●	●
 				-	2	3	5	0.2	25	-0.05	+0.05	●				●	●	KGAL ...3	
				-	2	4	5	0.25	25	-0.05	+0.05	●					●	●	KGAL ...4
				-	2	5	5	0.3	30	-0.05	+0.05	●					●	●	KGAL ...5

Recommended cutting conditions  G65

● : Standard item R : Right-hand only L : Left-hand only □ : Check availability



KGH (External grooving / Deep grooving)

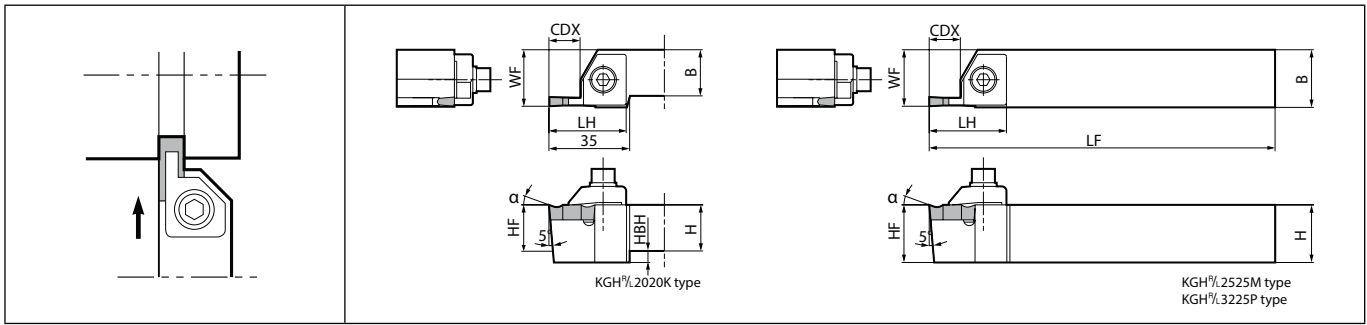

Right-hand shown

Toolholder dimensions

Description	Availability		Dimension (mm)										Clamp	Clamp bolt	Spring	Washer	Wrench	Applicable inserts G61
	R	L	CDX	H	B	LH	HF	HBH	LF	WF (min.)	WF (max.)							
KGH% 2020K-4 2525M-4	●	●	13	20	20	33.5	20	5	125	24.5	24.8	CGH-1%	HH6X25	SP-6	W-6	LW-5	GH4.20-.. GHU40-20	
KGH% 2020K-5 2525M-5 3225P-5	●	●	13	20	20	33.5	20	5	125	25	25.8	CGH-1%	HH6X25	SP-6	W-6	LW-5	GH5.20-.. GH6.20-.. GHU50-20 GHU60-20	
KGH% 2020K-7 2525M-7	●	●	13	20	20	33.5	20	7	125	24.5	25	CGH-2%	HH6X25	SP-6	W-6	LW-5	GH7.20-.. GH8020-..	
KGH% 2525M-10 3225P-10	●	●	17	25	25	41	25	-	150	25.5	26.5	CGH-3%	HH6X25	SP-6	W-6	LW-5	GH10025-05 GH12025-05	

CDX shows available grooving depth.

WF of KGH% Toolholder depends on the insert's edge width.

Clamp : CGH-○R for Right-hand Toolholder and CGH-○L for Left-hand Toolholder.

G

Grooving

External

Internal

Face

● : Standard item R : Right-hand only L : Left-hand only □ : Check availability

KGHS (External grooving / Deep grooving)

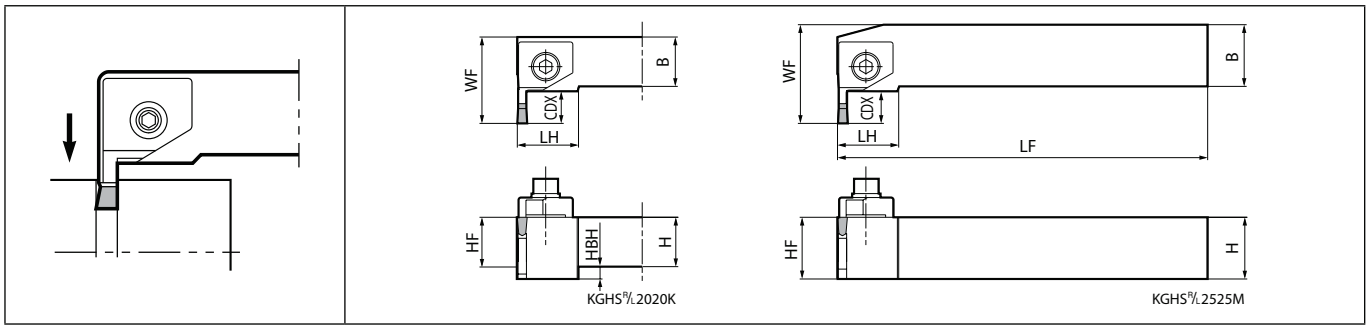

Right-hand shown

Toolholder dimensions

Description	Availability		Dimension (mm)								Spare parts					Applicable inserts ➔ G61
											Clamp	Clamp bolt	Spring	Washer	Wrench	
	R	L	CDX	H	B	LH	HF	HBH	LF	WF						
KGHS%L 2020K-4 2525M-4	●	●	13	20	20	25	20	5	125	35	CGH-1 $\frac{1}{2}$ /R	HH6X25	SP-6	W-6	LW-5	GH4.20-.. GHU40-20
KGHS%L 2020K-5 2525M-5	●	●	13	20	20	25	20	5	125	35	CGH-1 $\frac{1}{2}$ /R	HH6X25	SP-6	W-6	LW-5	GH5.20-.. GHU50-20 GH6.20-.. GHU60-20

CDX shows available grooving depth.

Clamp : CGH-○L for Right-hand Toolholder and CGH-○R for Left-hand Toolholder.

Rake Angle (α) after Installment of GH / GHU insert

When using GH○○-○○		When using GHU○○-○○	
α	Insert Grades	α	Insert Grades
0°	A65, A66N, PT600M	10°	TN60 CR9025
10°	TC40		
20°	TN90, TC60 PR930 KW10		

● : Standard item R : Right-hand only L : Left-hand only □ : Check availability



KGA (External grooving / Deep grooving)

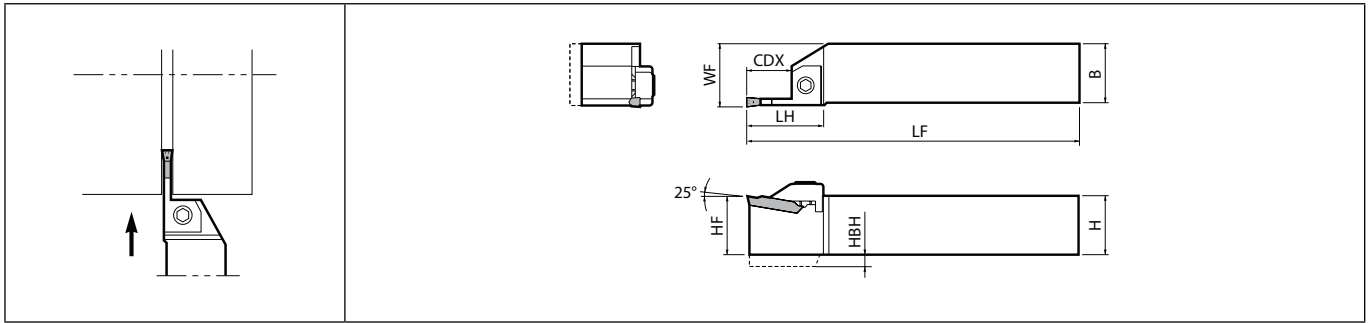

Right-hand shown

Toolholder dimensions

Description	Availability		Dimension (mm)									Spare parts				Applicable inserts G61
												Clamp bolt	Clamp	Spring	Wrench	
	R	L	CDX	H	B	LH	HF	HBH	LF	WF						
KGA [®] / _L 2020K-3 2525M-3	●	●	20	20	20	37	20	5	125	21.5	HH6X20	CGA-3 [®] / _L	SP-6	LW-5	GA30	
	●	●		25	25		25	-	150	26.5						
KGAR 2020K-4 2525M-4	●		20	20	20	37	20	5	125	21.5	HH6X20	CGA-4R	SP-6	LW-5	GA40	
	●			25	25		25	-	150	26.5						
KGAR 2020K-5 2525M-5	●		25	20	20	42	20	5	125	21.5	HH6X20	CGA-5R	SP-6	LW-5	GA50	
	●			25	25		25	-	150	26.5						

CDX shows available grooving depth.

Clamp : CGA-○R for Right-hand Toolholder and CGA-○L for Left-hand Toolholder.

G

Grooving

External

Internal

Face

● : Standard item R : Right-hand only L : Left-hand only □ : Check availability

Recommended cutting conditions

GH inserts - ground chipbreaker

Workpiece material	Recommended insert grades (Vc: m/min)							(1) f for grooving (mm/rev) (2) f for turning (mm/rev) (3) ap for turning (mm)				Remarks
	Cermet		PVD coated carbide	Carbide	Ceramic			GH 40~50...	GH 55~70...	GH 75~80...	GH 100~120...	
	TC40	TC60	PR930	KW10	A65	A66N	PT600M					
Carbon steel	☆ 150~220	☆ 100~150	★ 80~180	-	-	-	-	(1) 0.07~0.2 (2) 0.07~0.15 (3) Max. 1.0	(1) 0.07~0.2 (2) 0.07~0.15 (3) Max. 1.0	(1) 0.1~0.25 (2) 0.1~0.2 (3) Max. 1.5	(1) 0.15~0.3 (2) 0.15~0.25 (3) Max. 2.0	Coolant
Alloy steel	☆ 130~200	☆ 80~130	★ 80~160	-	-	-	-	(1) 0.07~0.18 (2) 0.07~0.13 (3) Max. 1.0	(1) 0.07~0.18 (2) 0.07~0.13 (3) Max. 1.0	(1) 0.1~0.23 (2) 0.1~0.18 (3) Max. 1.5	(1) 0.15~0.27 (2) 0.15~0.22 (3) Max. 2.0	
Stainless steel	-	☆ 60~100	★ 60~130	-	-	-	-	(1) 0.07~0.16 (2) 0.07~0.13 (3) Max. 1.0	(1) 0.07~0.16 (2) 0.07~0.13 (3) Max. 1.0	(1) 0.1~0.21 (2) 0.1~0.18 (3) Max. 1.5	(1) 0.15~0.25 (2) 0.15~0.22 (3) Max. 2.0	
Cast iron	-	-	-	★ 60~100	☆ 150~300	☆ 150~300	☆ 150~300	KW10 (1) 0.07~0.2 (2) 0.07~0.15 (3) Max. 1.0 A65/A66N (1) 0.03~0.07 (2) Not recom. (3) Not recom.	KW10 (1) 0.07~0.2 (2) 0.07~0.15 (3) Max. 1.0 A65/A66N (1) 0.03~0.07 (2) Not recom. (3) Not recom.	KW10 (1) 0.1~0.25 (2) 0.1~0.2 (3) Max. 1.5 A65/A66N (1) 0.05~0.09 (2) Not recom. (3) Not recom.	KW10 (1) 0.15~0.3 (2) 0.15~0.25 (3) Max. 2.0 A65/A66N (1) 0.05~0.09 (2) Not recom. (3) Not recom.	
Aluminum alloys	-	-	-	★ 150~400	-	-	-	(1) 0.07~0.2 (2) 0.07~0.15 (3) Max. 1.0	(1) 0.07~0.2 (2) 0.07~0.15 (3) Max. 1.0	(1) 0.1~0.25 (2) 0.1~0.2 (3) Max. 1.5	(1) 0.15~0.3 (2) 0.15~0.25 (3) Max. 2.0	
Brass	-	-	-	★ 150~300	-	-	-	(1) 0.07~0.2 (2) 0.07~0.15 (3) Max. 1.0	(1) 0.07~0.2 (2) 0.07~0.15 (3) Max. 1.0	(1) 0.1~0.25 (2) 0.1~0.2 (3) Max. 1.5	(1) 0.15~0.3 (2) 0.15~0.25 (3) Max. 2.0	
Hard materials	-	-	-	-	☆ 40~80	☆ 40~80	☆ 40~80	(1) 0.02~0.05 (2) 0.01~0.03 (3) Max. 0.1	(1) 0.02~0.05 (2) 0.01~0.03 (3) Max. 0.2	(1) 0.02~0.05 (2) 0.01~0.04 (3) Max. 0.2		

* Above cutting condition is for external grooving. Set both cutting speed and feed 10% lower for internal grooving.

★:1st recommendation ☆:2nd recommendation

GHU Inserts - molded chipbreaker

Workpiece material	Recommended insert grades (Vc: m/min)		(1) f for grooving (mm/rev) (2) f for turning (mm/rev) (3) ap for turning (mm)			Remarks
	Cermet	CVD coated carbide	GHU 40-20	GHU 50-20	GHU 60-20	
	TN60	CR9025				
Carbon steel	☆ 130~200	☆ 80~180	(1) 0.06~0.12 (2) 0.05~0.1 (3) Max. 1.0	(1) 0.06~0.12 (2) 0.05~0.1 (3) Max. 1.0	(1) 0.06~0.15 (2) 0.05~0.12 (3) Max. 1.5	Coolant
Alloy steel	☆ 100~180	☆ 80~160	(1) 0.06~0.12 (2) 0.05~0.1 (3) Max. 1.0	(1) 0.06~0.12 (2) 0.05~0.1 (3) Max. 1.0	(1) 0.06~0.15 (2) 0.05~0.12 (3) Max. 1.5	
Stainless steel	-	☆ 60~130	(1) 0.06~0.1 (2) 0.05~0.08 (3) Max. 0.8	(1) 0.06~0.1 (2) 0.05~0.08 (3) Max. 0.8	(1) 0.06~0.12 (2) 0.05~0.1 (3) Max. 1.2	

* Above cutting condition is for external grooving. Set both cutting speed and feed 10% lower for internal grooving.

★:1st recommendation ☆:2nd recommendation





GA inserts - molded chipbreaker

Workpiece material	Recommended insert grades (Vc: m/min)		(1) f for grooving (mm/rev) (2) f for turning (mm/rev) (3) ap for turning (mm)			Remarks
	Cermet	CVD coated carbide	GA 30	GA 40	GA 50	
	TN60	CR9025				
Carbon steel	☆ 130~200	★ 80~180	(1) 0.06~0.18 (2) 0.05~0.15 (3) Max. 0.8	(1) 0.06~0.21 (2) 0.05~0.17 (3) Max. 1.0	(1) 0.06~0.25 (2) 0.05~0.2 (3) Max. 1.3	Coolant
Alloy steel	☆ 100~180	★ 80~160	(1) 0.06~0.15 (2) 0.05~0.12 (3) Max. 0.3	(1) 0.06~0.18 (2) 0.05~0.15 (3) Max. 0.5	(1) 0.06~0.22 (2) 0.05~0.18 (3) Max. 0.8	
Stainless steel	-	★ 60~130	(1) 0.06~0.1 (2) 0.05~0.08 (3) Max. 0.8	(1) 0.06~0.1 (2) 0.05~0.08 (3) Max. 0.8	(1) 0.06~0.12 (2) 0.05~0.1 (3) Max. 1.2	

★:1st recommendation ☆:2nd recommendation

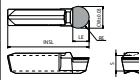

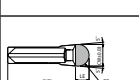
GMGW

Insert		Description	No. of edges	Dimension (mm)					Tolerance (mm)		PCD	Applicable toolholder ➔ G67
				CW	S	RE	INSL	LE	CW min.	CW max.		
				Carbon steel / Alloy steel							P	
				Stainless steel							M	
				Cast iron							K	
				Non-ferrous metals					●		N	
				Titanium alloy					●		S	
				Hard materials (~ 40HRC)							H	
				Hard materials (40HRC ~)								
		GMGW 6030-30R	1	6	5.5	3	30	4.5	-0.03	+0.03	●	KGMW [®] /L2525M-6
		GMGW 8030-40R	1	8	5.5	4	30	6	-0.03	+0.03	●	KGMW [®] /L2525M-8
		GMGW 8030-40R-HR	1	8	5.5	4	30	5	-0.03	+0.03	●	KGMW [®] /L2525M-8

GMGW inserts are exclusively used for KGMW toolholder. It cannot be used for other toolholder because of its different installation angle.
GMGW inserts Edge Preparation : R-honed Cutting Edge.

Recommended cutting conditions ➔ G67

Grooving

G

External

Internal

Face

● : Standard item R : Right-hand only L : Left-hand only □ : Check availability

CBN & PCD Inserts are sold in 1 piece boxes

KGMW (External grooving / Face grooving)

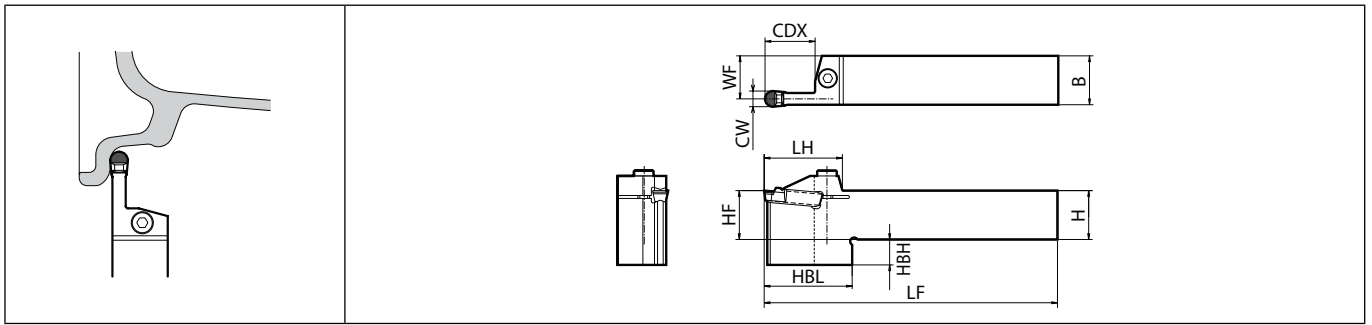

Right-hand shown

Toolholder dimensions

Description	Availability		Dimension (mm)										Spare parts		Applicable inserts G66
													Clamp bolt	Wrench	
	R	L	CDX	H	B	LH	HF	HBH	HBL	LF	WF				
KGMW ^{R/L} 2525M-6	●	●	25	25	25	40	25	13	55	150	22.8	HH6X25	LW-5	GMGW6030-30R	
KGMW ^{R/L} 2525M-8	●	●	25	25	25	40	25	13	55	150	22	HH6X25	LW-5	GMGW8030-40R (-HR)	



Recommended cutting conditions

Workpiece material	Recommended insert grades (Vc: m/min)		(1) f for grooving (mm/rev) (2) f for turning (mm/rev) (3) ap for turning (mm)
	PCD		
	KPD001		
Aluminum	★ 150~2,700		(1) 0.05 ~ 0.3 (2) 0.2 ~ 0.8 (3) Max. 3

★ :1st recommendation

● : Standard item R : Right-hand only L : Left-hand only □ : Check availability

TGF

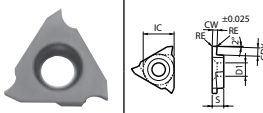
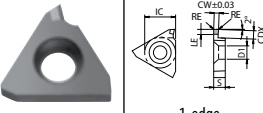
		Carbon steel / Alloy steel		Stainless steel		Cast iron		Non-ferrous metals		Titanium alloy		Hard materials (~ 40HRC)		Hard materials (40HRC ~)		P		M		K		N		S		H	
Insert	Description	No. of edges	Dimension (mm)							Tolerance (mm)		Carbide				Applicable toolholder											
			CW	CDX	IC	S	D1	RE	LE	CW min.	CW max.	PVD	Cermet	PCD													
			PR1215	PR930	KW10	TC40	KPD001																				
	TGF32R 033-005	3	0.33	0.8	9.525	3.18	4.6	0.05	-	-0.025	+0.025	<input type="checkbox"/>	<input type="checkbox"/>	<input type="checkbox"/>	<input type="checkbox"/>	<input type="checkbox"/>	KTGFR...-16 KTGFR...-16F S...-KTGFL16										
	TGF32R 050-005		0.5	1.2				0.05																			
	TGF32R 075-010		0.75	2				0.1																			
	TGF32R 095-010		0.95	2				0.1																			
	TGF32R 100-010		1	2				0.1																			
	TGF32R 120-010		1.2	2				0.1																			
	TGF32R 125-010		1.25	2				0.1																			
	TGF32R 140-010		1.4	2				0.1																			
	TGF32R 145-010		1.45	2				0.1																			
	TGF32R 150-010		1.5	2				0.1																			
	TGF32R 175-010		1.75	2				0.1																			
	TGF32R 200-010		2	2.5				0.1																			
	TGF32R 250-010		2.5	2.5				0.1																			
	TGF32L 050-005		0.5	1.2				0.05				KTGFR...-16 KTGFR...-16F															
	TGF32L 075-010		0.75	2				0.1																			
	TGF32L 095-010		0.95	2				0.1																			
	TGF32L 100-010		1	2				0.1																			
TGF32L 120-010	1.2	2	0.1																								
TGF32L 125-010	1.25	2	0.1																								
TGF32L 140-010	1.4	2	0.1																								
TGF32L 145-010	1.45	2	0.1																								
TGF32L 150-010	1.5	2	0.1																								
TGF32L 175-010	1.75	2	0.1																								
TGF32L 200-010	2	2.5	0.1																								
TGF32L 250-010	2.5	2.5	0.1																								
	TGF32R 125-010	1	1.25	2	9.525	3.18	4.6	0.1	1.7	-0.03	+0.03		<input type="checkbox"/>	<input type="checkbox"/>	<input type="checkbox"/>	<input type="checkbox"/>	KTGFR...-16 KTGFR...-16F S...-KTGFL16										
	TGF32R 150-010		1.5	2				0.1																			
	TGF32R 200-010		2	2.5				0.1																			

Right-hand shown
CDX shows available grooving depth.

Recommended cutting conditions

Workpiece material	Recommended insert grades (Vc: m/min)					(1) f for grooving (mm/rev) (2) f for turning (mm/rev) (3) ap for turning (mm)				Remarks	
	Cermet	MEGACAOT	PVD coated carbide	Carbide	PCD	TGF32 [®] L 033~050-005	TGF32 [®] L 075~095-010	TGF32 [®] L 100~145-010	TGF32 [®] L 150~250-010		
	TC40	PR1215	PR930	PR1115	KW10	KPD001 (KPD0010)					
Carbon steel	☆ 150~220	★ 80~180	☆ 80~180	☆ 80~180	-	-	(1) 0.01~0.05 (2) Not recom. (3) Not recom.	(1) 0.02~0.07 (2) Not recom. (3) Not recom.	(1) 0.03~0.08 (2) 0.03~0.06 (3) Max. 0.2	(1) 0.03~0.08 (2) 0.03~0.06 (3) Max. 0.2	Coolant
Alloy steel	☆ 130~200	★ 80~160	☆ 80~160	☆ 80~160	-	-	(1) 0.01~0.04 (2) Not recom. (3) Not recom.	(1) 0.02~0.06 (2) Not recom. (3) Not recom.	(1) 0.03~0.07 (2) 0.02~0.05 (3) Max. 0.2	(1) 0.03~0.07 (2) 0.02~0.05 (3) Max. 0.2	
Stainless steel	-	☆ 60~130	☆ 60~130	★ 60~130	-	-	(1) 0.01~0.04 (2) Not recom. (3) Not recom.	(1) 0.02~0.06 (2) Not recom. (3) Not recom.	(1) 0.03~0.07 (2) 0.02~0.05 (3) Max. 0.2	(1) 0.03~0.07 (2) 0.02~0.05 (3) Max. 0.2	
Cast iron	-	-	-	-	★ 60~100	-	(1) 0.01~0.05 (2) Not recom. (3) Not recom.	(1) 0.02~0.07 (2) Not recom. (3) Not recom.	(1) 0.03~0.08 (2) 0.03~0.06 (3) Max. 0.2	(1) 0.03~0.08 (2) 0.03~0.06 (3) Max. 0.2	
Aluminum alloys	-	-	-	-	★ 150~400	★ 150~2,000	(1) 0.01~0.05 (2) Not recom. (3) Not recom.	(1) 0.02~0.07 (2) Not recom. (3) Not recom.	(1) 0.03~0.08 (2) 0.03~0.06 (3) Max. 0.2	(1) 0.03~0.08 (2) 0.03~0.06 (3) Max. 0.2	
Brass	-	-	-	-	★ 150~300	★ 200~800	(1) 0.01~0.04 (2) Not recom. (3) Not recom.	(1) 0.02~0.06 (2) Not recom. (3) Not recom.	(1) 0.03~0.07 (2) 0.02~0.05 (3) Max. 0.2	(1) 0.03~0.07 (2) 0.02~0.05 (3) Max. 0.2	

★:1st recommendation ☆:2nd recommendation

● : Standard item R : Right-hand only L : Left-hand only □ : Check availability

CBN & PCD Inserts are sold in 1 piece boxes

Small diameter internal grooving

EZ bar and system tip-bars

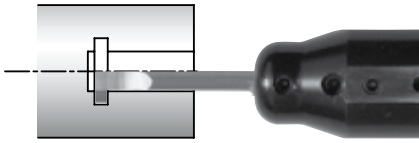

Type	EZG
Min. bore diameter	ø3~ø8
Edge width (mm)	0.5~2.0
Grooving depth (mm)	1.0~2.0
See Page	G71



EZ bars

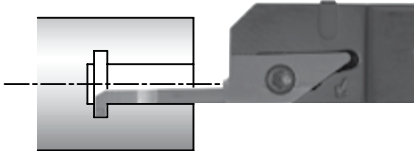

Type	VNG
Min. bore diameter	ø4~ø7
Edge width (mm)	1.0~2.0
Grooving depth (mm)	0.8~2.0
See Page	G73



System tip-bars

Internal Grooving ø8~ - shallow grooving

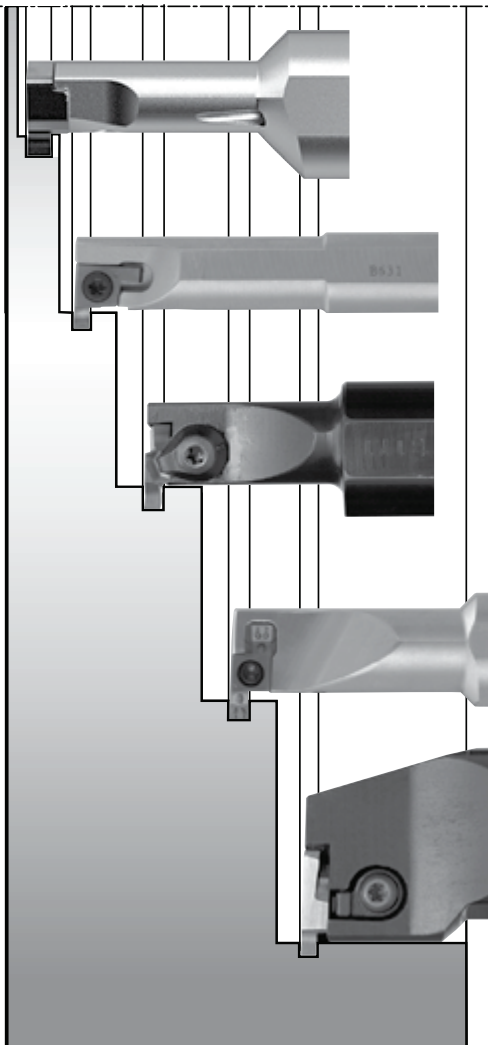

Type	SIGC
Min. bore diameter	ø8~ø12
Edge width (mm)	1.0~3.0
Grooving depth (mm)	1.5~2.2
See Page	G76,G77

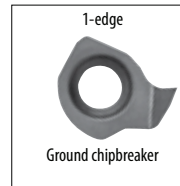

1-edge

Ground chipbreaker

Type	SIGE
Min. bore diameter	ø8~ø12
Edge width (mm)	1.0~3.0
Grooving depth (mm)	1.5~2.2
See Page	G81~G83

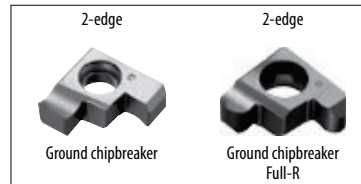

2-edge

2-edge

Ground chipbreaker

Ground chipbreaker Full-R

Type	GIV
Min. bore diameter	ø12~ø40
Edge width (mm)	1.0~5.0
Grooving depth (mm)	1.7~6.3
See Page	G86~G88

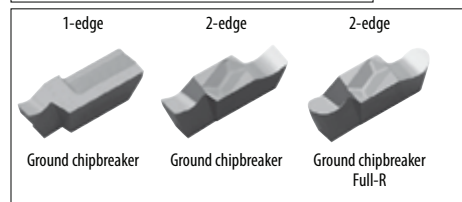

1-edge

2-edge

2-edge

Ground chipbreaker

Ground chipbreaker

Ground chipbreaker Full-R

Type	SIGE
Min. bore diameter	ø14~ø40
Edge width (mm)	1.0~5.0
Grooving depth (mm)	2.5~6.5
See Page	G81~G83

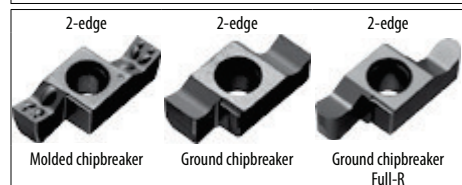

2-edge

2-edge

2-edge

Molded chipbreaker

Ground chipbreaker

Ground chipbreaker Full-R

Type	KIGBA
Min. bore diameter	ø35~ø40
Edge width (mm)	0.33~4.8
Grooving depth (mm)	0.8~2.8
See Page	G89

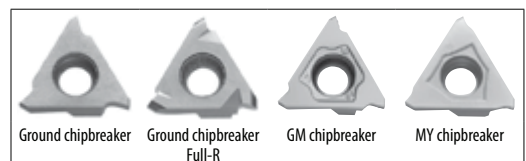

Ground chipbreaker

Ground chipbreaker Full-R

GM chipbreaker

MY chipbreaker



Summary deep grooving

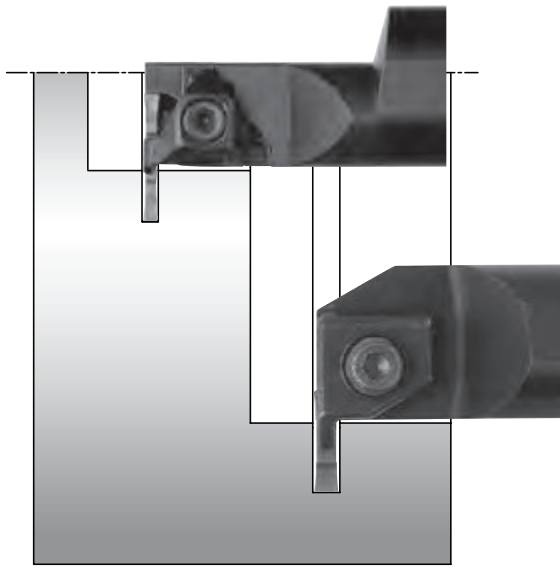

Type	KGIA
Min. bore diameter	ø32~ø66
Edge width (mm)	3.0~5.0
Grooving depth (mm)	10~15
See Page	G97

Type	KIGH
Min. bore diameter	ø45~ø65
Edge width (mm)	4.0~8.0
Grooving depth (mm)	12
See Page	G93

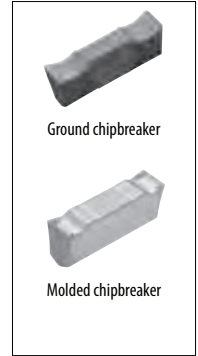
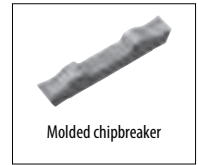

G

Grooving

Summary internal grooving & turning ø20~

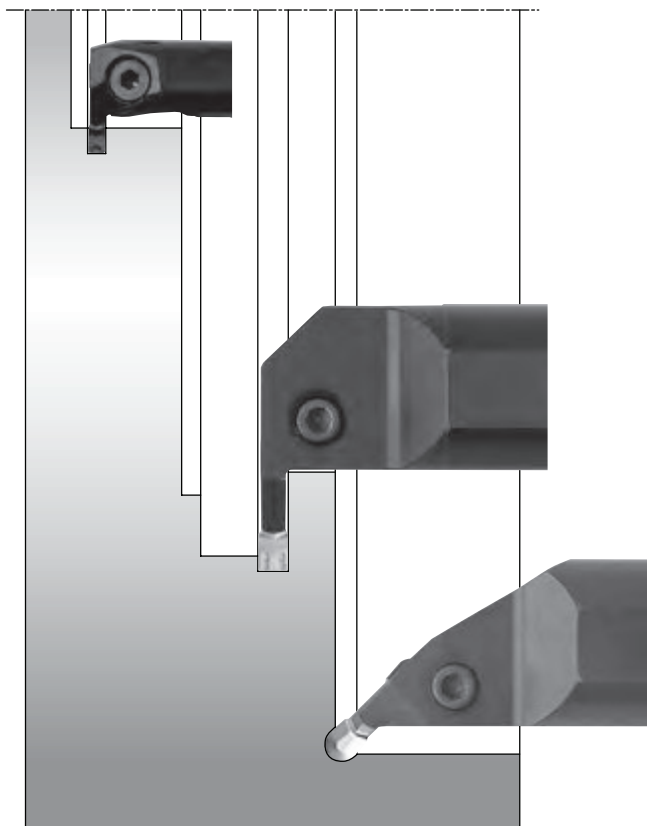

Type	KGDI
Min. bore diameter	ø18~ø40
Edge width (mm)	2.0~5.0
Grooving depth (mm)	4.5~11.0
See Page	G91

Type	KIGM-8
Min. bore diameter	ø65
Edge width (mm)	8.0
Grooving depth (mm)	20
See Page	G95

Type	KIGMU-8
Min. bore diameter	ø65
Edge width (mm)	8.0
Grooving depth (mm)	2.2
See Page	G95

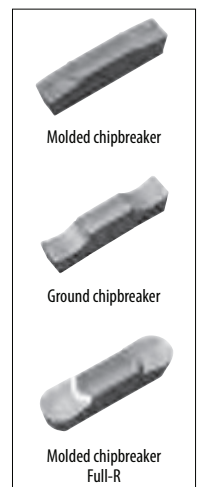
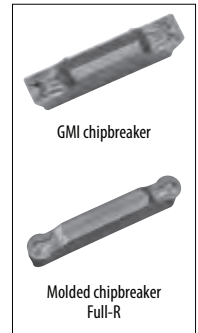

External
Internal
Face

EZG (Internal grooving)

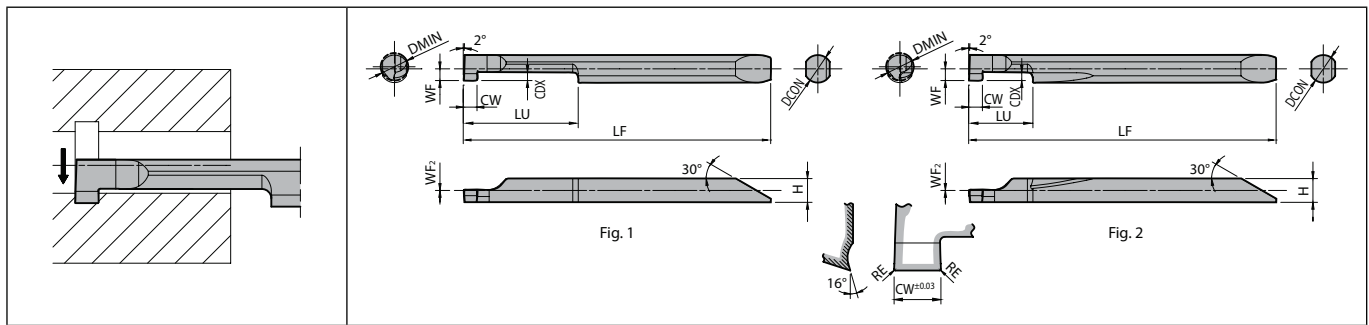

Right-hand shown

Dimensions

Description	No. of edges	Dimension (mm)										Fig.	Tolerance (mm)				Carbide			Applicable sleeve F38~F43			
		DMIN	CW	CDX	RE	DCON	H	LF	LU	WF	WF ₂		CW min.	CW max.	RE min.	RE max.	PVD		-				
																	PR1225	GW05			R	L	R
EZG ^{PL} 040040-050 040040-100 040040-150 040040-200	1	4	0.5 1 1.5 2	1	0.05	4	3.45	44.7	12	1.7	0	2	-0.03	+0.03	-0.013	+0.013	●	□	●	EZH040...			
EZG ^{PL} 050050-100 050050-150 050050-200	1	5	1 1.5 2	1.5	0.05	5	4.3	52.8	20	2.15	0	1	-0.03	+0.03	-0.013	+0.013	●	□	●	EZH050...			
EZG ^{PL} 060060-100 060060-150 060060-200	1	6	1 1.5 2	2	0.05	6	5.15	60.7	20	2.65	0	1	-0.03	+0.03	-0.013	+0.013	●	□	●	EZH060...			
EZG ^{PL} 070070-100 070070-150 070070-200	1	7	1 1.5 2	2	0.05	7	6.2	63.7	25	3.05	0	1	-0.03	+0.03	-0.013	+0.013	●	□	●	EZH070...			
EZG ^{PL} 080070-100 080070-150 080070-200	1	8	1 1.5 2	2	0.05	7	6.2	63.7	25	3.45	0	1	-0.03	+0.03	-0.013	+0.013	●	□	●	EZH070...			
EZGR 030030-050S 030030-100S	1	3	0.5 1	0.8	0.05	3	2.5	38.7	5	1.25	0	2	-0.03	+0.03	-0.013	+0.013	●			EZH030...			
EZGR 040040-050S 040040-100S 040040-150S 040040-200S	1	4	0.5 1 1.5 2	1	0.05	4	3.45	44.7	8	1.7	0	2	-0.03	+0.03	-0.013	+0.013	●			EZH040...			
EZGR 050050-100S 050050-150S 050050-200S	1	5	1 1.5 2	1.5	0.05	5	4.3	52.8	10	2.15	0	2	-0.03	+0.03	-0.013	+0.013	●			EZH050...			
EZGR 060060-100S 060060-150S 060060-200S	1	6	1 1.5 2	2	0.05	6	5.15	60.7	10	2.65	0	2	-0.03	+0.03	-0.013	+0.013	●			EZH060...			
EZGR 070070-100S 070070-150S 070070-200S	1	7	1 1.5 2	2	0.05	7	6.2	63.7	10	3.05	0	2	-0.03	+0.03	-0.013	+0.013	●			EZH070...			
EZGR 080070-100S 080070-150S 080070-200S	1	8	1 1.5 2	2	0.05	7	6.2	63.7	10	3.45	0	2	-0.03	+0.03	-0.013	+0.013	●			EZH070...			

CDX shows available grooving depth.

Recommended cutting conditions G144

● : Standard item R : Right-hand only L : Left-hand only □ : Check availability

EZ bars are sold in 1 piece boxes



EZ Bars Identification System

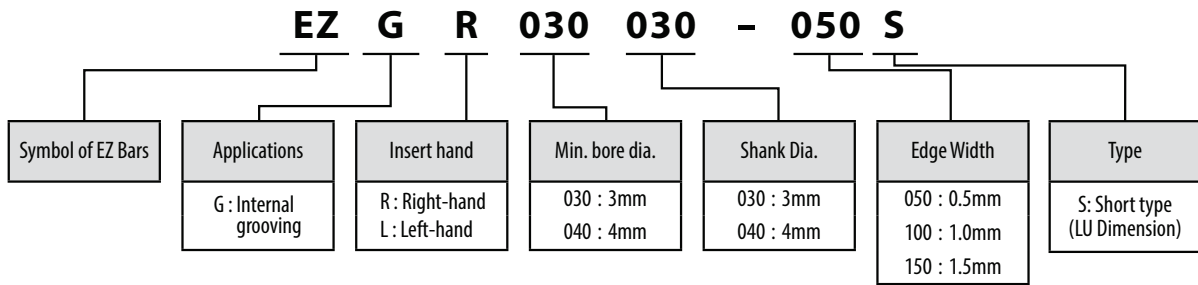

Applicable Sleeves

Sleeve				Applicable Insert for Small Dia. Internal Grooving			Applicable Machine Manufacturer
EZH-CT (Adjustable overhang length with coolant hole) F38, F39	EZH-HP (Adjustable overhang length) F40, F41	EZH-ST F42, F43	Sleeve Shank Dia. DCON(mm)	EZG	Shank Dia. DCON(mm)		
		EZH 03012ST-80 04012ST-80 05012ST-80 06012ST-80 07012ST-80	12	EZG_ 030030-... EZG_ 040040-... EZG_ 050050-... EZG_ 060060-... EZG_ 070070-... EZG_ 080070-...	3 4 5 6 7 8	(General purpose)	
	EZH 03016HP-100 04016HP-100 05016HP-100 06016HP-100 07016HP-100	EZH 03016ST-100 04016ST-100 05016ST-100 06016ST-100 07016ST-100	16	EZG_ 030030-... EZG_ 040040-... EZG_ 050050-... EZG_ 060060-... EZG_ 070070-... EZG_ 080070-...	3 4 5 6 7 8	(General purpose)	
EZH 03019CT-120 04019CT-120 05019CT-120 06019CT-120 07019CT-120	EZH 03019HP-120 04019HP-120 05019HP-120 06019HP-120 07019HP-120	EZH 03019ST-120 04019ST-120 05019ST-120 06019ST-120 07019ST-120	19.05	EZG_ 030030-... EZG_ 040040-... EZG_ 050050-... EZG_ 060060-... EZG_ 070070-... EZG_ 080070-...	3 4 5 6 7 8	Citizen Machinery	
EZH 03020CT-120 04020CT-120 05020CT-120 06020CT-120 07020CT-120	EZH 03020HP-120 04020HP-120 05020HP-120 06020HP-120 07020HP-120	EZH 03020ST-120 04020ST-120 05020ST-120 06020ST-120 07020ST-120	20	EZG_ 030030-... EZG_ 040040-... EZG_ 050050-... EZG_ 060060-... EZG_ 070070-... EZG_ 080070-...	3 4 5 6 7 8	Eguro Tsugami Citizen Machinery (General purpose)	
EZH 03022CT-135 04022CT-135 05022CT-135 06022CT-135 07022CT-135	EZH 03022HP-135 04022HP-135 05022HP-135 06022HP-135 07022HP-135	EZH 03022ST-135 04022ST-135 05022ST-135 06022ST-135 07022ST-135	22	EZG_ 030030-... EZG_ 040040-... EZG_ 050050-... EZG_ 060060-... EZG_ 070070-... EZG_ 080070-...	3 4 5 6 7 8	Star Micronics Nomura DS Tsugami	
EZH 03025.0CT-135 04025.0CT-135 05025.0CT-135 06025.0CT-135 07025.0CT-135	EZH 03025.0HP-135 04025.0HP-135 05025.0HP-135 06025.0HP-135 07025.0HP-135	EZH 03025.0ST-135 04025.0ST-135 05025.0ST-135 06025.0ST-135 07025.0ST-135	25	EZG_ 030030-... EZG_ 040040-... EZG_ 050050-... EZG_ 060060-... EZG_ 070070-... EZG_ 080070-...	3 4 5 6 7 8	Eguro Tsugami Citizen Machinery (General purpose)	
EZH 03025.4CT-120 04025.4CT-120 05025.4CT-120 06025.4CT-120 07025.4CT-120	EZH 03025.4HP-120 04025.4HP-120 05025.4HP-120 06025.4HP-120 07025.4HP-120	EZH 03025.4ST-120 04025.4ST-120 05025.4ST-120 06025.4ST-120 07025.4ST-120	25.4	EZG_ 030030-... EZG_ 040040-... EZG_ 050050-... EZG_ 060060-... EZG_ 070070-... EZG_ 080070-...	3 4 5 6 7 8	Citizen Machinery	

· Choose sleeves (DCB) to meet with DCON dimension of Internal Grooving Inserts.
 · Adjustment Pin cannot be installed to EZH-ST sleeves.
 · To adjust overhang of the bar, please use EZH-CT / HP Sleeves.
 · Machine manufacturers in random order.

VNG

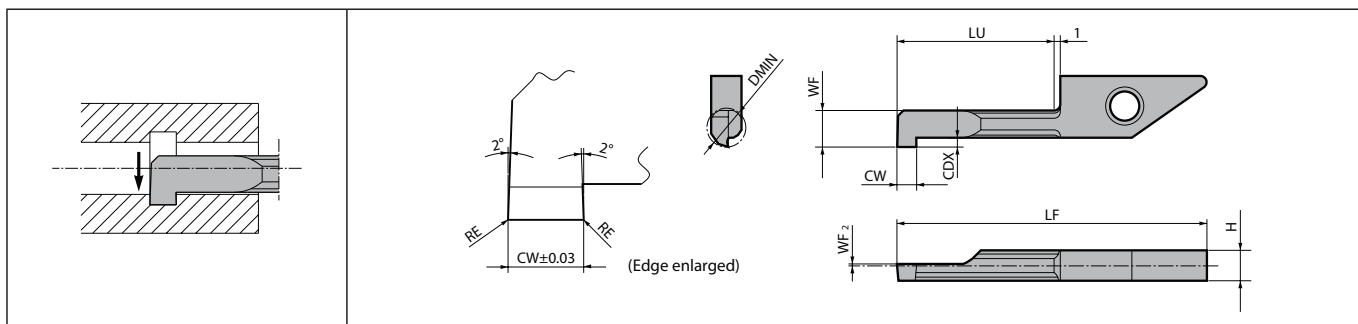

Right-hand shown

Dimensions

Description	No. of edges	Dimension (mm)										Tolerance (mm)		Carbide			Applicable toolholder F48~F51
		DMIN	CW	CDX	RE	H	LF	LU	WF	WF ₂	CW min.	CW max.	PVD	-			
													PR1225	PR930	KV10		
VNGR 0410-11 0420-11	1	4	1/2	0.8	0.05	3.9	30.8	11	3.5	0.1	-0.03	+0.03	●	●	●	SVNR...-12N SVNSR...-12-11N	
VNGR 0510-11 0520-11	1	5	1/2	1	0.05	3.9	30.8	11	4.4	0.1	-0.03	+0.03	●	●	●	S...-SVNR12N S...-SVNR12SN	
VNGR 0610-20 0620-20	1	6	1/2	1.8	0.05	3.9	39.8	20	5.2	0.3	-0.03	+0.03	●	●	●	SVNR...-12N SVNSR...-12-20N	
VNGR 0710-20 0720-20	1	7	1/2	2	0.05	3.9	39.8	20	6.2	0.3	-0.03	+0.03	●	●	●	S...-SVNR12N S...-SVNR12SN	

CDX shows available grooving depth.

Recommended cutting conditions G144

WF₂ indicates the cutting edge is above the Tool's Center Position.

VNG

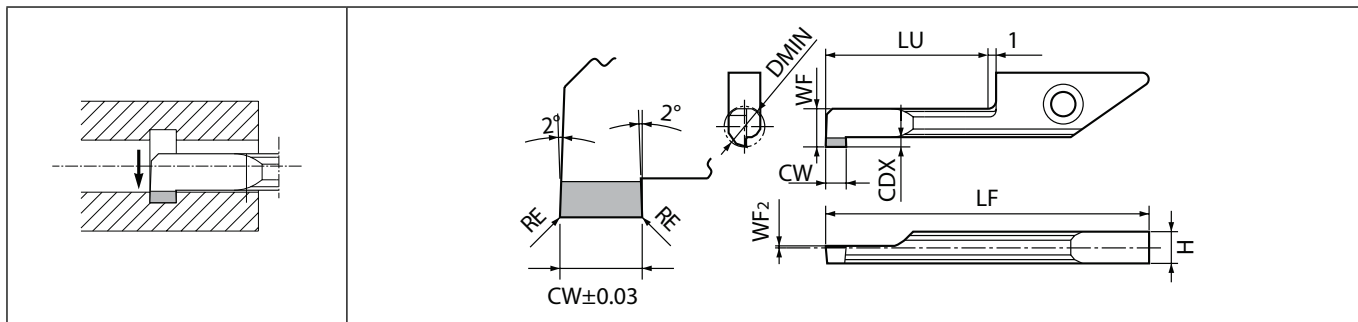

Right-hand shown

Dimensions

Description	No. of edges	Dimension (mm)										Tolerance (mm)		PCD	Applicable toolholder F48~F51
		DMIN	CW	CDX	RE	H	LF	LU	WF	WF ₂	CW min.	CW max.	RPD001		
													RPD001		
VNGR 0410-11NB 0420-11NB	1	4	1/2	0.8	0.05	3.9	30.8	11	3.5	0.1	-0.03	+0.03	MTO	SVNR...-12N SVNSR...-12-11N	
VNGR 0510-11NB 0520-11NB	1	5	1/2	1	0.05	3.9	30.8	11	4.4	0.1	-0.03	+0.03	MTO	S...-SVNR12N S...-SVNR12SN	
VNGR 0610-20NB 0620-20NB	1	6	1/2	1.8	0.05	3.9	39.8	20	5.2	0.3	-0.03	+0.03	MTO	SVNR...-12N SVNSR...-12-20N	
VNGR 0710-20NB 0720-20NB	1	7	1/2	2	0.05	3.9	39.8	20	6.2	0.3	-0.03	+0.03	MTO	S...-SVNR12N S...-SVNR12SN	

CDX shows available grooving depth.

WF₂ indicates the cutting edge is above the Tool's Center Position.

● : Standard item R : Right-hand only L : Left-hand only □ : Check availability MTO : Made to order

System tip-bars are sold in 5 piece boxes



SIGC

Newly developed clamping system ensures a firm insert hold to provide high-precision machining. Excellent chip evacuation with double coolant holes and optimized flute shape with a $\varnothing 8$ mm minimum cutting diameter.

1 Firm insert clamping system provides high-precision machining

Firm clamping action by pulling the bottom surface of the insert in axial direction
Precise machining is achieved by ensuring a firm clamp on the insert

G

Grooving

External

Internal

Face

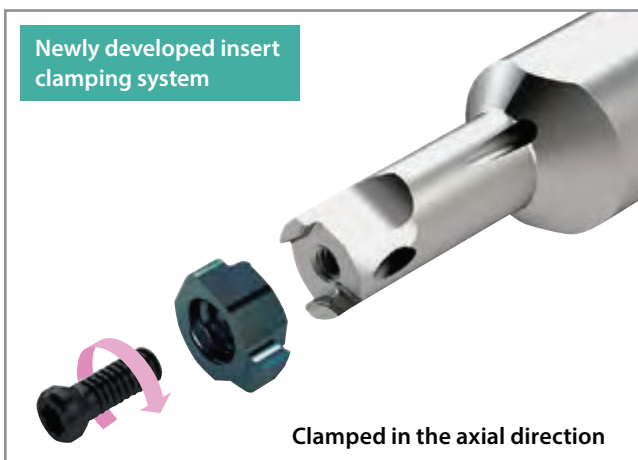

Clamping part (image)

Firm clamping is available due to large contact surface

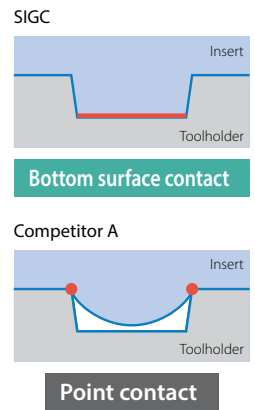
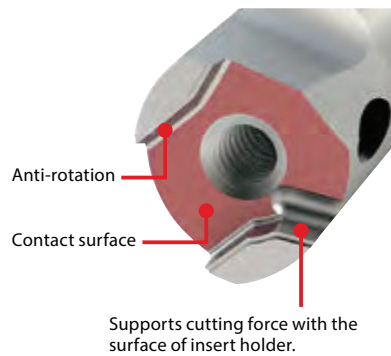



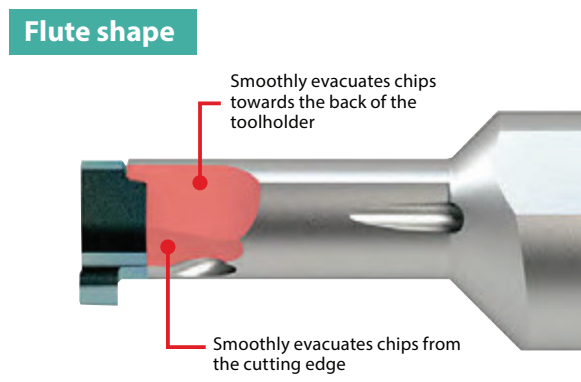
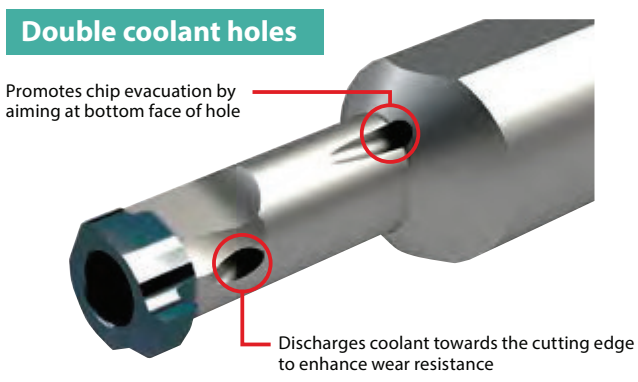

2 Excellent chip evacuation

Excellent chip evacuation with double coolant holes and optimized flute shape



Provides a better solution when facing chip evacuation difficulties in small internal grooving.
Prevents chip crunching.

GC

		Material										PVD		Applicable toolholder	
		Carbon steel / Alloy steel										P		G76, G77	
		Stainless steel										M			
		Cast iron										K			
		Non-ferrous metals										N			
		Titanium alloy										S			
		Hard materials (~ 40HRC)										H			
		Hard materials (40HRC ~)													
Insert	Description	No. of edges	Dimension (mm)							Tolerance (mm)		Carbide		Applicable toolholder G76, G77	
			CW	CDX	S	D1	RE	INSL	W1	CW min.	CW max.	P1535	P1725		
	GC08R 100-005 120-005 125-005 150-010 200-010	1	1	1.5	3.5	2.7	0.05	7.7	3.4	-0.025	+0.025	●	●	SIGCR08...	
			1.2				0.05					●	●		
			1.25				0.05					●	●		
			1.5				0.1					●	●		
			2				0.1					●	●		
			2				0.1					●	●		
	GC08L 100-005 120-005 125-005 150-010 200-010	1	1	1.5	3.5	2.7	0.05	7.7	3.4	-0.025	+0.025	●	●	SIGCL08...	
			1.2				0.05					●	●		
			1.25				0.05					●	●		
			1.5				0.1					●	●		
			2				0.1					●	●		
			2				0.1					●	●		
	GC10R 100-005 120-005 125-005 145-010 150-010 200-010 250-020 300-020	1	1	2.2	4.4	3.5	0.05	9.6	4.7	-0.025	+0.025	●	●	SIGCR10...	
			1.2				0.05					●	●		
			1.25				0.05					●	●		
			1.45				0.1					●	●		
			1.5				0.1					●	●		
			2				0.1					●	●		
	2.5	0.2	●	●											
	3	0.2	●	●											
	GC10L 100-005 120-005 125-005 145-010 150-010 200-010 250-020 300-020	1	1	2.2	4.4	3.5	0.05	9.6	4.7	-0.025	+0.025	●	●	SIGCL10...	
			1.2				0.05					●	●		
			1.25				0.05					●	●		
			1.45				0.1					●	●		
1.5			0.1				●					●			
2			0.1				●					●			
2.5	0.2	●	●												
3	0.2	●	●												
	GC12R 100-005 120-005 125-005 145-010 150-010 200-010 250-020 300-020	1	1	2.2	5.4	3.5	0.05	11.6	4.7	-0.025	+0.025	●	●	SIGCR12...	
			1.2				0.05					●	●		
			1.25				0.05					●	●		
			1.45				0.1					●	●		
			1.5				0.1					●	●		
			2				0.1					●	●		
	2.5	0.2	●	●											
	3	0.2	●	●											
	GC12L 100-005 120-005 125-005 145-010 150-010 200-010 250-020 300-020	1	1	2.2	5.4	3.5	0.05	11.6	4.7	-0.025	+0.025	●	●	SIGCL12...	
			1.2				0.05					●	●		
			1.25				0.05					●	●		
			1.45				0.1					●	●		
1.5			0.1				●					●			
2			0.1				●					●			
2.5	0.2	●	●												
3	0.2	●	●												
	GC08R 100-050R 200-100R	1	1	1.5	3.5	2.7	0.5	7.7	3.4	-0.025	+0.025	●	●	SIGCR08...	
			2				1					●	●		
	GC10R 100-050R 200-100R	1	1	2.2	4.4	3.5	0.5	9.6	4.7	-0.025	+0.025	●	●	SIGCR10...	
			2				1					●	●		
	GC12R 100-050R 200-100R	1	1	2.2	5.4	3.5	0.5	11.6	4.7	-0.025	+0.025	●	●	SIGCR12...	
			2				1					●	●		

Right-hand shown
CDX shows available grooving depth.

Recommended cutting conditions  G144

● : Standard item R : Right-hand only L : Left-hand only □ : Check availability

GC type inserts are sold in 5 piece boxes



SIGC Excellent bar (Internal grooving)

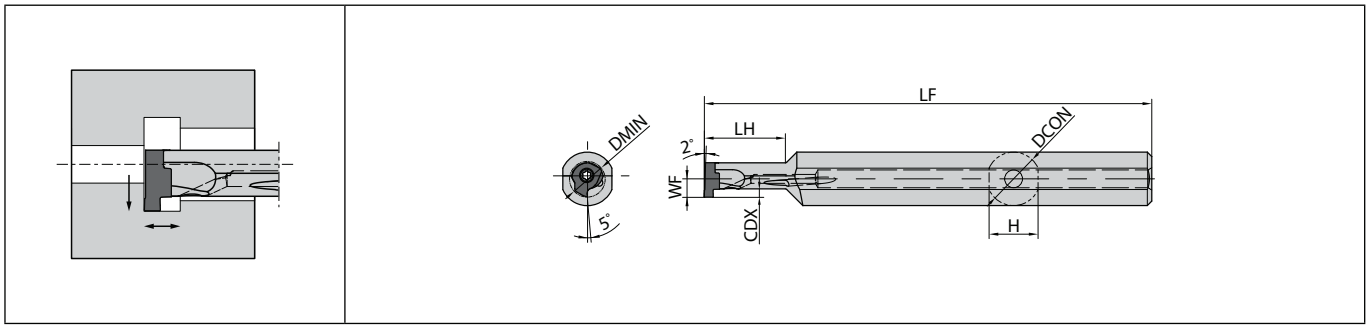

Right-hand shown | Right-hand Insert for Right-hand Toolholder, Left-hand Insert for Left-hand Toolholder.

Toolholder dimensions

Description	Availability		Dimension (mm)								Coolant hole	Spare parts		Applicable inserts G75
												Screw	Wrench	
	R	L	DMIN	DCON	CDX	H	LH	LF	WF					
SIGC [®] /L 0812-EH	●	●	8	12	1.5	11	18	100	4.1	Yes	SB-2270T [®] /L	FT-7	GC08 [®] /L...	
SIGC [®] /L 1016-EH	●	●	10	16	2.2	15	21	100	5	Yes	SB-3070T [®] /L	FT-8	GC10 [®] /L...	
SIGC [®] /L 1216-EH	●	●	12	16	2.2	15	25	110	6	Yes	SB-3070T [®] /L	FT-8	GC12 [®] /L...	

Setting the insert

Use compressed air or other measures to remove chips from the insert pocket.
 Mount the insert into the toolholder ensure the bottom makes contact with the end of the toolholder's surface.
 Keeping the insert seated, tighten the insert clamp screw at an appropriate torque.
 Recommended tightening torque : 0.8 N·m (SB-2270T[®]/L), 1.2 N·m (SB-3070T[®]/L)
 L-hand clamp screw for L-hand toolholder

GC**R-***	GC**L-***
Right-hand screw Toolholder : SIGCR..... Clamp Screw : SB-....TR	Left-hand screw Toolholder : SIGCL..... Clamp Screw : SB-....TL

G

Grooving

External

Internal

Face

● : Standard item R : Right-hand only L : Left-hand only □ : Check availability

SIGC Carbide shank bar (Internal grooving)

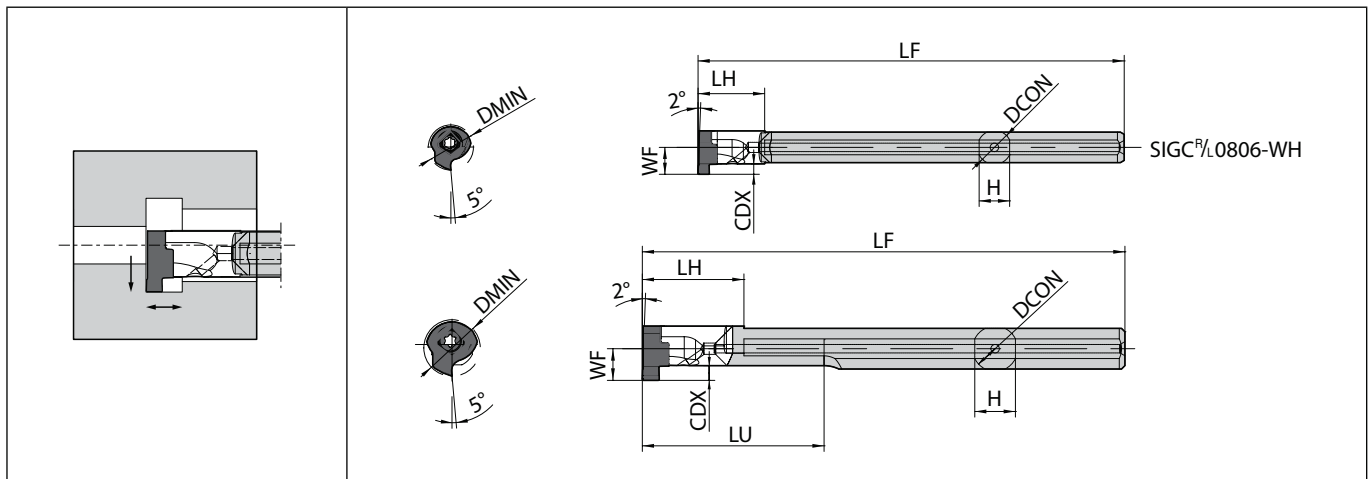

Right-hand shown | Right-hand Insert for Right-hand Toolholder, Left-hand Insert for Left-hand Toolholder.

Toolholder dimensions

Description	Availability		Dimension (mm)								Coolant hole	Spare parts		Applicable inserts ➔ G75
	R	L	DMIN	DCON	CDX	H	LH	LF	LU	WF		Screw	Wrench	
SIGC [®] /L 0806-WH	●	●	8	6	1.5	5.4	12	75	-	4.8	Yes	SB-2270T [®] /L	FT-7	GC08 [®] /L...
SIGC [®] /L 1008-WH-L85	●	●	10	8	2.2	7.2	18	85	32	5.6	Yes	SB-3070T [®] /L	FT-8	GC10 [®] /L...
SIGC [®] /L 1008-WH-L100	●							100	45			SB-3070TR		
SIGC [®] /L 1210-WH-L95	●		12	10	2.2	9.2	18	95	32	6.6	Yes	SB-3070T [®] /L	FT-8	GC12 [®] /L...
SIGC [®] /L 1210-WH-L110	●	●						110	45					

Setting the insert

Use compressed air or other measures to remove chips from the insert pocket.
 Mount the insert into the toolholder ensure the bottom makes contact with the end of the toolholder's surface.
 Keeping the insert seated, tighten the insert clamp screw at an appropriate torque.
 Recommended tightening torque : 0.8 N·m (SB-2270T[®]/L), 1.2 N·m (SB-3070T[®]/L)
 L-hand clamp screw for L-hand toolholder

GC**R***	GC**L***
 Right-hand screw Toolholder : SIGCR..... Clamp Screw : SB-....TR	 Left-hand screw Toolholder : SIGCL..... Clamp Screw : SB-....TL

Applicable Sleeves





Shank Size (Hole Dia.: mm)	06 (6 mm)	08 (8 mm)	10 (10 mm)	12 (12 mm)	16 (16 mm)
Toolholder Description	SIGC [®] /L 0806-WH	SIGC [®] /L 1008-WH-L85 SIGCR 1008-WH-L100	SIGCR 1210-WH-L95 SIGC [®] /L 1210-WH-L110	SIGC [®] /L 0812-EH	SIGC [®] /L 1016-EH SIGC [®] /L 1216-EH
SH Sleeves (For Boring Bars)	SH 06...	SH 08...	SH 10...	SH 12...	SH 16...
SHC Sleeves (Coolant Sleeve)	-	SHC 08...	SHC 10...	SHC 12...	SHC 16...
SHA Sleeves	-	SHA 08...	SHA 10...	SHA 12...	-
EZH Sleeves (For EZ Bars)	EZH 06...ST/CT/HP...	EZH 08...ST/CT/HP...	-	-	-

* Remove the positioning pin when mounting SIGC to the EZH-CT/HP Sleeve
 Positioning function is not available

● : Standard item R : Right-hand only L : Left-hand only □ : Check availability

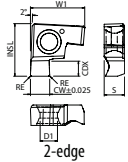

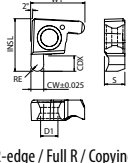
GE

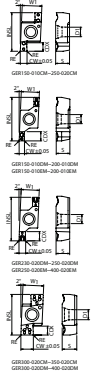
		Carbon steel / Alloy steel										☺	☹	☹	☹	P				
		Stainless steel										☺	☹	☹	☹	M				
		Cast iron										☺	☹	☹	☹	K				
		Non-ferrous metals										☺	☹	☹	☹	N				
		Titanium alloy										☺	☹	☹	☹	S				
		Hard materials (~ 40HRC)										☺	☹	☹	☹	H				
		Hard materials (40HRC ~)										☺	☹	☹	☹	H				
Insert	Description	No. of edges	Dimension (mm)							Tolerance (mm)		Carbide				Applicable toolholder ☺ G81~G83				
			CW	CDX	S	D1	RE	INSL	W1	CW min.	CW max.	PVD		Cermet						
												PRI025	PRI225	KW10	TN6020					
  2-edge	GER 100-005A 120-005A 125-005A 150-010A 200-010A	2	1 1.2 1.25 1.5 2					0.05 0.05 0.05 0.1 0.1			6.5	6.69	-0.025	+0.025	☐	●	●	●	SIGER0808A-EH SIGER0808A-WH	
	GEL 100-005A 120-005A 125-005A 150-010A 200-010A	2	1 1.2 1.25 1.5 2	1.5	2.58	2.5		0.05 0.05 0.05 0.1 0.1			6.5	6.69	-0.025	+0.025	●	●	●	●	SIGEL0808A-EH SIGEL0808A-WH	
	GER 100-005B 120-005B 125-005B 145-010B 150-010B 200-010B 250-020B 300-020B	2	1 1.2 1.25 1.45 1.5 2 2.5 3					0.05 0.05 0.05 0.1 0.1 0.1 0.2 0.2			8.2	8.46	-0.025	+0.025	☐	●	●	●	SIGER...B-EH SIGER...B-WH SIGER...B-WH-90	
	GEL 100-005B 120-005B 125-005B 145-010B 150-010B 200-010B 250-020B 300-020B	2	1 1.2 1.25 1.45 1.5 2 2.5 3	2.2	3.18	2.7		0.05 0.05 0.05 0.1 0.1 0.1 0.2 0.2			8.2	8.46	-0.025	+0.025	●	●	●	●	SIGEL...B-EH SIGEL...B-WH	
	  2-edge / Full R / Copying	GER 100-050AR 200-100AR	2	1 2	1.5	2.58	2.5	0.5 1			6.5	6.69	-0.025	+0.025	☐	●	●	●	SIGER0808A-EH SIGER0808A-WH	
		GER 100-050BR 200-100BR	2	1 2	2.2	3.18	2.7	0.5 1			8.2	8.46	-0.025	+0.025	☐	●	●	●	SIGER...B-EH SIGER...B-WH SIGER...B-WH-90	
	  2-edge / Molded Chipbreaker	GER 150-010CM 200-010CM 250-020CM 300-020CM 350-020CM	2	1.5 2 2.5 3 3.5	2.5	4.05	2.8	0.1 0.1 0.2 0.2 0.2			11.48	5.8	-0.05	+0.05	☐	●	●	●	SIGER...C-EH SIGER...C-WH SIGER...C-WH-90	
		GER 150-010DM 200-010DM 230-020DM 250-020DM 300-020DM 350-020DM 400-020DM	2	1.5 2 2.3 2.5 3 3.5 4	3 3.2 3.2 3.2 4.5 4.5 4.5		5.05	3.4	0.1 0.1 0.2 0.2 0.2 0.2 0.2			16.44	6.8	-0.05	+0.05	☐	●	●	●	SIGER2020D-EH

Right-hand shown
CDX shows available grooving depth.

Recommended cutting conditions ☺ G145

● : Standard item R : Right-hand only L : Left-hand only ☐ : Check availability

G

Grooving

External

Internal

Face

GE

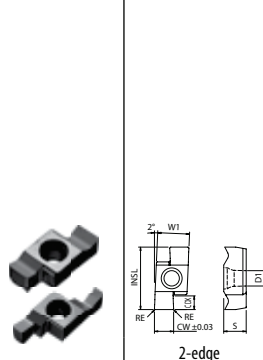
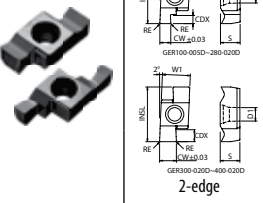
		Material										Tolerance (mm)		Carbide			Applicable toolholder G81~G83						
		Dimension (mm)										CW min.	CW max.	PVD	-	-							
Insert	Description	No. of edges	CW	CDX	S	D1	RE	INSL	W1					PRI025	PRI225	GW15		TN6020					
			Carbon steel / Alloy steel																				P
			Stainless steel																				M
			Cast iron																				K
			Non-ferrous metals																				N
			Titanium alloy																				S
			Hard materials (~ 40HRC)																				H
			Hard materials (40HRC ~)																				H
 <p>2-edge</p>	GER	100-005C	1				0.05														SIGER...C-EH SIGER...C-WH SIGER...C-WH-90		
		120-005C	1.2				0.05																
		125-005C	1.25				0.05																
		140-005C	1.4				0.05																
		145-010C	1.45				0.1																
		150-010C	1.5				0.1																
		170-010C	1.7				0.1																
		185-010C	1.85				0.1																
		195-010C	1.95				0.1																
		200-010C	2				0.1																
		250-020C	2.5	2.5	4.05	3.1	0.2	11.48	5.8	-0.03	+0.03												
		300-020C	3				0.2																
		350-020C	3.5				0.2																
		GEL	100-005C	1				0.05															SIGEL...C-EH SIGEL...C-WH
		120-005C	1.2				0.05																
	125-005C	1.25				0.05																	
	145-010C	1.45				0.1																	
	150-010C	1.5				0.1																	
	200-010C	2				0.1																	
	250-020C	2.5				0.2																	
	300-020C	3				0.2																	
	350-020C	3.5				0.2																	
	GER	100-005D	1	2.5			0.05														SIGER2020D-EH		
	140-005D	1.4	2.5			0.05																	
	145-010D	1.45	2.5			0.1																	
	150-010D	1.5	3			0.1																	
	170-010D	1.7	3			0.1																	
	185-010D	1.85	3			0.1																	
	195-010D	1.95	3			0.1																	
	200-010D	2	3.2			0.1																	
	225-010D	2.25	3.2			0.1																	
	230-020D	2.3	3.2			0.2																	
	250-020D	2.5	3.2			0.2																	
	280-020D	2.8	3.2			0.2																	
	300-020D	3	4.5			0.2																	
	330-020D	3.3	4.5	5.05	3.6	0.2	16.44	6.8	-0.03	+0.03													
	350-020D	3.5	4.5			0.2																	
	400-020D	4	4.5			0.2																	
	GEL	100-005D	1	2.5			0.05														SIGEL2020D-EH		
	140-005D	1.4	2.5			0.05																	
	145-010D	1.45	2.5			0.1																	
	150-010D	1.5	3			0.1																	
	170-010D	1.7	3			0.1																	
	200-010D	2	3.2			0.1																	
	225-010D	2.25	3.2			0.1																	
	230-020D	2.3	3.2			0.2																	
	250-020D	2.5	3.2			0.2																	
	300-020D	3	4.5			0.2																	
	400-020D	4	4.5			0.2																	
 <p>2-edge</p>	GER	200-100CR	2	2	2.5	4.05	3.1	1	11.48	5.8	-0.03	+0.03									SIGER...C-EH SIGER...C-WH(-)		
		250-125CR	2.5				1.25																
		300-150CR	3				1.5																
		GER	200-100DR	2	2	3.2	5.05	3.6	1	16.44	6.8	-0.03	+0.03									SIGER2020D-EH	
		300-150DR	3	3	4.5		1.5																



Right-hand shown
CDX shows available grooving depth.

Recommended cutting conditions G145

● : Standard item R : Right-hand only L : Left-hand only □ : Check availability

G
Grooving

GE/GER

		Carbon steel / Alloy steel		Stainless steel		Cast iron		Non-ferrous metals		Titanium alloy		Hard materials (~ 40HRC)		Hard materials (40HRC ~)								
Insert	Description	No. of edges	Dimension (mm)							Tolerance (mm)		Carbide			Applicable toolholder G81							
			CW	CDX	S	D1	RE	INSL	W1	CW min.	CW max.	PVD	-	-								
												PRI25	PRI25	GW15		TN6020						
 <p>GER 2-edge / Molded Chipbreaker</p>	GER 150-010EM	2	1.5	3			0.1							<input type="checkbox"/>	<input checked="" type="checkbox"/>	<input type="checkbox"/>					SIGER...E-EH	
	200-010EM		2	3.2			0.1								<input type="checkbox"/>	<input checked="" type="checkbox"/>	<input type="checkbox"/>					
	250-020EM		2.5	4.5			0.2								<input type="checkbox"/>	<input checked="" type="checkbox"/>	<input type="checkbox"/>					
	300-020EM		3	4.5	5.55	4.4	0.2	21.66	9.54	-0.05	+0.05	<input type="checkbox"/>	<input checked="" type="checkbox"/>	<input type="checkbox"/>	<input type="checkbox"/>	<input type="checkbox"/>	<input type="checkbox"/>					
	350-020EM		3.5	5.5			0.2								<input type="checkbox"/>	<input checked="" type="checkbox"/>	<input type="checkbox"/>					
	400-020EM		4	5.5			0.2								<input type="checkbox"/>	<input checked="" type="checkbox"/>	<input type="checkbox"/>					
	450-020EM		4.5	6.5			0.2								<input type="checkbox"/>	<input checked="" type="checkbox"/>	<input type="checkbox"/>					
	500-020EM	5	6.5			0.2								<input type="checkbox"/>	<input checked="" type="checkbox"/>	<input type="checkbox"/>						
 <p>GER 2-edge / Molded Chipbreaker</p> <p>GEL 2-edge</p>	GER 100-005E	2	1	2.5			0.05								<input type="checkbox"/>	<input checked="" type="checkbox"/>	<input type="checkbox"/>	<input type="checkbox"/>			SIGER...E-EH	
	150-010E		1.5	3			0.1									<input type="checkbox"/>	<input checked="" type="checkbox"/>	<input type="checkbox"/>	<input type="checkbox"/>			
	170-010E		1.7	3			0.1									<input type="checkbox"/>	<input checked="" type="checkbox"/>	<input type="checkbox"/>	<input type="checkbox"/>			
	185-010E		1.85	3			0.1									<input type="checkbox"/>	<input checked="" type="checkbox"/>	<input type="checkbox"/>	<input type="checkbox"/>			
	195-010E		1.95	3			0.1									<input type="checkbox"/>	<input checked="" type="checkbox"/>	<input type="checkbox"/>	<input type="checkbox"/>			
	200-010E		2	3.2			0.1									<input type="checkbox"/>	<input checked="" type="checkbox"/>	<input type="checkbox"/>	<input type="checkbox"/>			
	225-010E		2.25	3.2			0.1									<input type="checkbox"/>	<input checked="" type="checkbox"/>	<input type="checkbox"/>	<input type="checkbox"/>			
	230-020E		2.3	3.2			0.2									<input type="checkbox"/>	<input checked="" type="checkbox"/>	<input type="checkbox"/>	<input type="checkbox"/>			
	250-020E		2.5	4.5			0.2									<input type="checkbox"/>	<input checked="" type="checkbox"/>	<input type="checkbox"/>	<input type="checkbox"/>			
	275-020E		2.75	4.5			0.2									<input type="checkbox"/>	<input checked="" type="checkbox"/>	<input type="checkbox"/>	<input type="checkbox"/>			
	280-020E		2.8	4.5			0.2									<input type="checkbox"/>	<input checked="" type="checkbox"/>	<input type="checkbox"/>	<input type="checkbox"/>			
	300-020E		3	4.5			0.2									<input type="checkbox"/>	<input checked="" type="checkbox"/>	<input type="checkbox"/>	<input type="checkbox"/>			
	330-020E		3.3	4.5			0.2									<input type="checkbox"/>	<input checked="" type="checkbox"/>	<input type="checkbox"/>	<input type="checkbox"/>			
	350-020E		3.5	5.5			0.2									<input type="checkbox"/>	<input checked="" type="checkbox"/>	<input type="checkbox"/>	<input type="checkbox"/>			
	400-020E		4	5.5			0.2									<input type="checkbox"/>	<input checked="" type="checkbox"/>	<input type="checkbox"/>	<input type="checkbox"/>			
	430-020E	4.3	5.5			0.2									<input type="checkbox"/>	<input checked="" type="checkbox"/>	<input type="checkbox"/>	<input type="checkbox"/>				
	450-020E	4.5	6.5	5.55	4.6	0.2	21.66	9.54	-0.03	+0.03	<input type="checkbox"/>	<input checked="" type="checkbox"/>	<input type="checkbox"/>	<input type="checkbox"/>	<input type="checkbox"/>	<input type="checkbox"/>	<input type="checkbox"/>	<input type="checkbox"/>				
	460-020E	4.6	6.5			0.2									<input type="checkbox"/>	<input checked="" type="checkbox"/>	<input type="checkbox"/>	<input type="checkbox"/>				
	500-020E	5	6.5			0.2									<input type="checkbox"/>	<input checked="" type="checkbox"/>	<input type="checkbox"/>	<input type="checkbox"/>				
	GEL 100-005E	1	2.5			0.05									<input type="checkbox"/>	<input checked="" type="checkbox"/>	<input type="checkbox"/>	<input type="checkbox"/>				
	150-010E	1.5	3			0.1									<input type="checkbox"/>	<input checked="" type="checkbox"/>	<input type="checkbox"/>	<input type="checkbox"/>				
	170-010E	1.7	3			0.1									<input type="checkbox"/>	<input checked="" type="checkbox"/>	<input type="checkbox"/>	<input type="checkbox"/>				
	185-010E	1.85	3			0.1									<input type="checkbox"/>	<input checked="" type="checkbox"/>	<input type="checkbox"/>	<input type="checkbox"/>				
	195-010E	1.95	3			0.1									<input type="checkbox"/>	<input checked="" type="checkbox"/>	<input type="checkbox"/>	<input type="checkbox"/>				
	200-010E	2	3.2			0.1									<input type="checkbox"/>	<input checked="" type="checkbox"/>	<input type="checkbox"/>	<input type="checkbox"/>				
	230-020E	2.3	3.2			0.2									<input type="checkbox"/>	<input checked="" type="checkbox"/>	<input type="checkbox"/>	<input type="checkbox"/>				
	250-020E	2.5	4.5			0.2									<input type="checkbox"/>	<input checked="" type="checkbox"/>	<input type="checkbox"/>	<input type="checkbox"/>				
	280-020E	2.8	4.5			0.2									<input type="checkbox"/>	<input checked="" type="checkbox"/>	<input type="checkbox"/>	<input type="checkbox"/>				
	300-020E	3	4.5			0.2									<input type="checkbox"/>	<input checked="" type="checkbox"/>	<input type="checkbox"/>	<input type="checkbox"/>				
	330-020E	3.3	4.5			0.2									<input type="checkbox"/>	<input checked="" type="checkbox"/>	<input type="checkbox"/>	<input type="checkbox"/>				
	350-020E	3.5	5.5			0.2									<input type="checkbox"/>	<input checked="" type="checkbox"/>	<input type="checkbox"/>	<input type="checkbox"/>				
	400-020E	4	5.5			0.2									<input type="checkbox"/>	<input checked="" type="checkbox"/>	<input type="checkbox"/>	<input type="checkbox"/>				
	500-020E	5	6.5			0.2									<input type="checkbox"/>	<input checked="" type="checkbox"/>	<input type="checkbox"/>	<input type="checkbox"/>				

Right-hand shown
CDX shows available grooving depth.

Recommended cutting conditions G145

● : Standard item R : Right-hand only L : Left-hand only □ : Check availability

SIGE Excellent bar (Internal grooving)

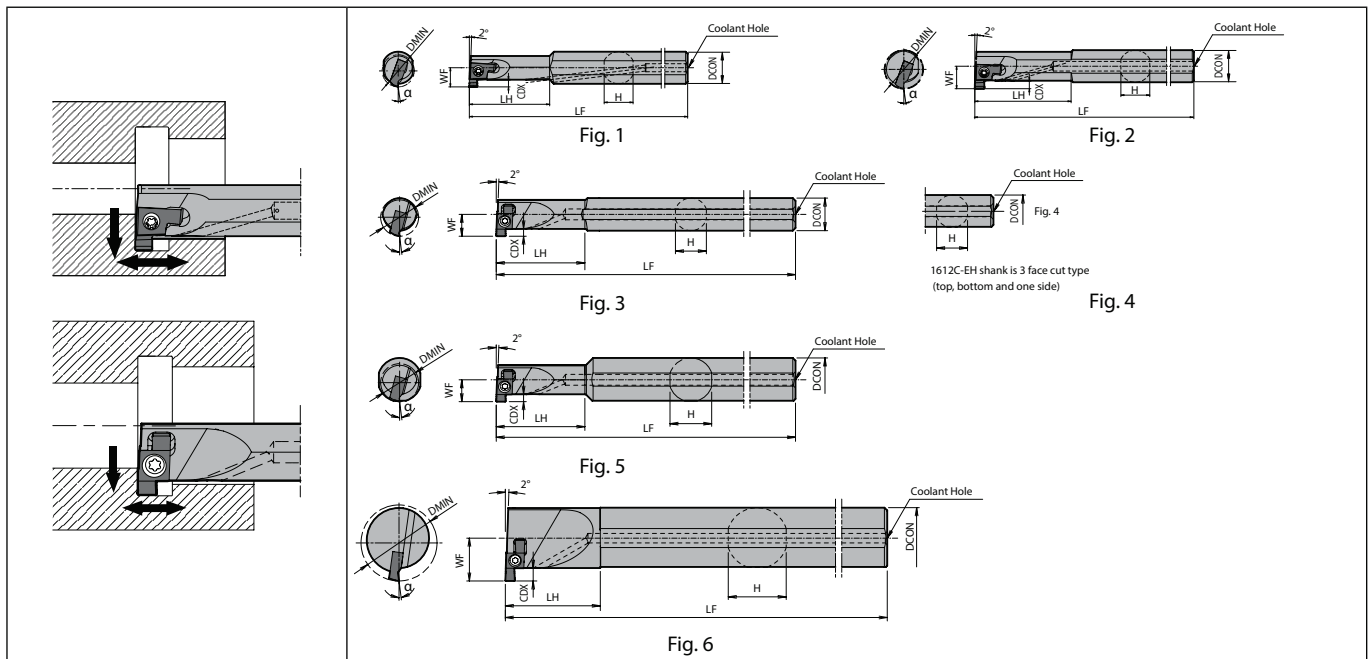

Right-hand shown | Right-hand Insert for Right-hand Toolholder, Left-hand Insert for Left-hand Toolholder.

Toolholder dimensions

Description	Availability		Dimension (mm)								Coolant hole	Fig.	Spare parts				Applicable inserts ➔ G78~G80
													Screw	Wrench	Wrench	Wrench	
	R	L	DMIN	DCON	CDX	H	LH	LF	WF								
SIGE [®] /L 0808A-EH	●	●	8	8	1.5	7.2	20	100	4.8	Yes	1	SB-2045TRN	-	-	FT-6	GE [®] /...A / AR	
SIGE [®] /L 1010B-EH	●	●	10	10	2.2	9	25	125	6.2	Yes	1	SB-2255TR	-	DT-7	-	GE [®] /...B GE [®] /...BR	
SIGE [®] /L 1210B-EH	●	●	12	12	2.5	11.4	30	150	8	Yes	2	SB-2570TR	-	-	FT-8	GE [®] /...C GE [®] /...CM GE [®] /...CR	
SIGE [®] /L 1412C-EH	●	●	14	14	2.5	11.4	33	150	8	Yes	4	SB-2570TR	-	-	FT-8	GE [®] /...C GE [®] /...CM GE [®] /...CR	
SIGE [®] /L 1612C-EH	●	●	16	16	2.5	11.4	33	150	8	Yes	4	SB-2570TR	-	-	FT-8	GE [®] /...C GE [®] /...CM GE [®] /...CR	
SIGE [®] /L 1616C-EH	●	●	16	16	2.5	11.4	33	150	8	Yes	5	SB-2570TR	-	-	FT-8	GE [®] /...C GE [®] /...CM GE [®] /...CR	
SIGE [®] /L 2020D-EH	●	●	20	20	4.5	19	40	180	12.1	Yes	5	SB-3080TR	-	-	FT-10	GE [®] /...D / DM / DR	
SIGE [®] /L 2525E-EH	●	●	25	25	6.5	24	45	200	15.6	Yes	5	SB-4085TR	FT-15	-	-	GE [®] /...E GE [®] /...EM	
SIGE [®] /L 3232E-EH	●	●	32	32	6.5	24	55	220	19	Yes	5	SB-4085TR	FT-15	-	-	GE [®] /...E GE [®] /...EM	
SIGE [®] /L 4032E-EH	●	●	40	40	6.5	30.4	45	250	23	Yes	6	SB-4085TR	FT-15	-	-	GE [®] /...E GE [®] /...EM	

CDX shows the distance from the toolholder to the cutting edge. Available Groove Depth : „CDX“ of Insert.

Applicable sleeve ➔ F149, F150

Features

Large chip pocket screw clamp toolholder design enables excellent chip evacuation

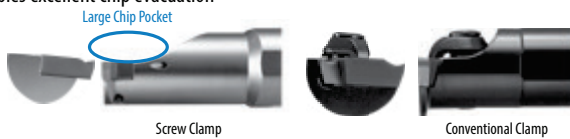

Cutting edge is free from contact face



An 8mm minimum bore diameter with a 2-edge design

Cost effective chip control from a molded chipbreaker



● : Standard item R : Right-hand only L : Left-hand only □ : Check availability

SIGE Carbide shank bar (Internal grooving)

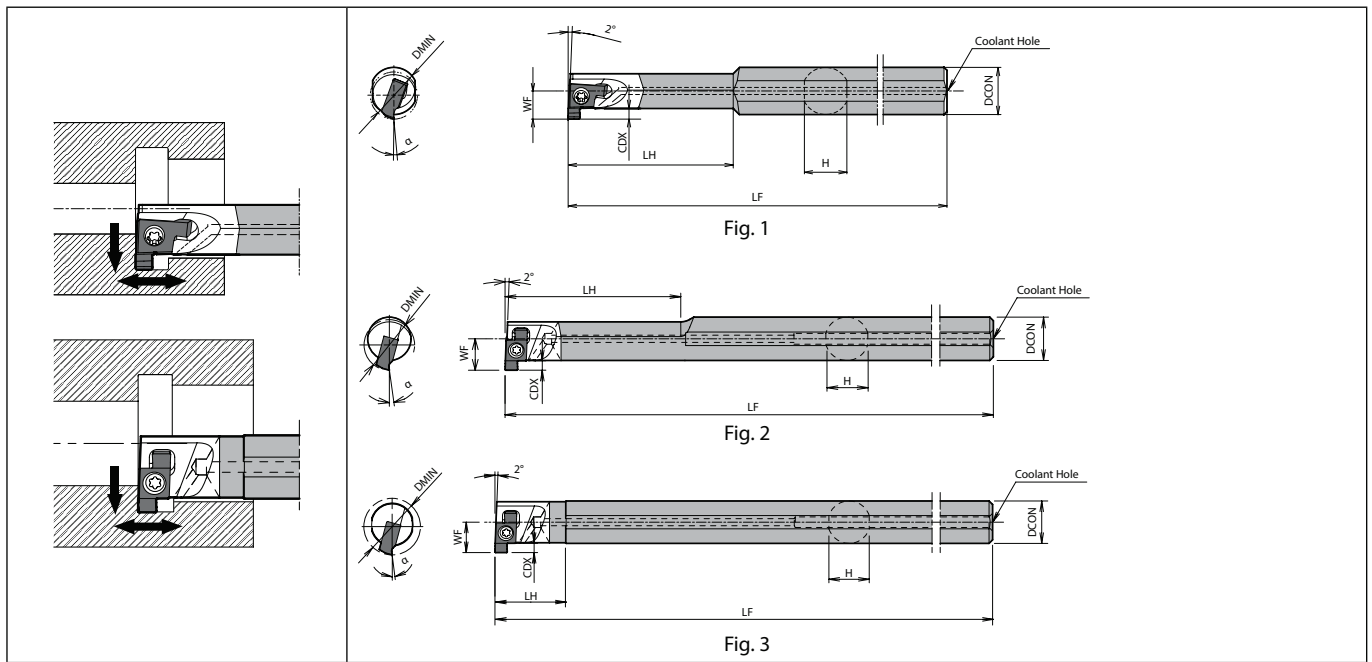

Right-hand shown | Right-hand Insert for Right-hand Toolholder, Left-hand Insert for Left-hand Toolholder.

Toolholder dimensions

Description	Availability		Dimension (mm)								Coolant hole	Fig.	Spare parts			Applicable inserts G78, G79
													Screw	Wrench	Wrench	
	R	L	DMIN	DCON	CDX	H	LH	LF	WF							
SIGE%L 0808A-WH	●	●	8	8	1.5	7.2	28	125	4.8	Yes	1	SB-2045TRN	-	FT-6	GE%L...A / AR	
SIGE%L 1010B-WH	●	●	10	10	2.2	9	35	125	6.2	Yes	1	SB-2255TR	DT-7	-	GE%L...B GE%L...BR	
SIGE%L 1210B-WH	●	●	12	12			45	140	7							
SIGE%L 1412C-WH	●	●	14	12	2.5	11.4	50	150	8.7	Yes	2 3	SB-2570TR	-	FT-8	GE%L...C GE%L...CM GE%L...CR	
SIGE%L 1612C-WH	●	●	16				20	180	8.5							

CDX shows the distance from the toolholder to the cutting edge. Available Groove Depth : „CDX“ of Insert.

Applicable sleeve F149, F150

● : Standard item R : Right-hand only L : Left-hand only □ : Check availability

SIGE Carbide shank bar (Internal grooving / for automatic lathe)

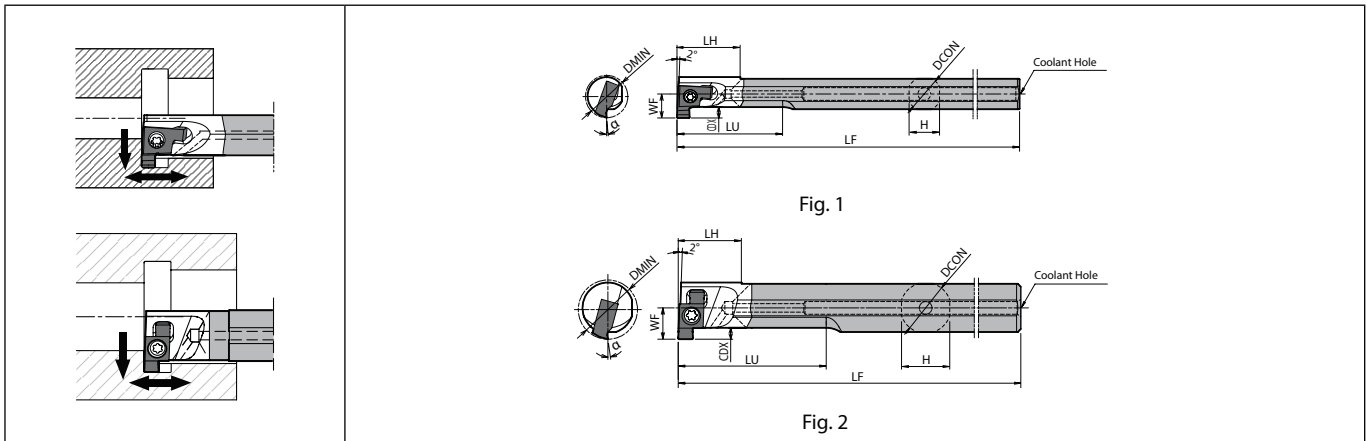

Right-hand shown | Right-hand Insert for Right-hand Toolholder.

Toolholder dimensions

Description	Availability	Dimension (mm)									Coolant hole	Fig.	Spare parts		Applicable inserts ● G78, G79
		R	DMIN	DCON	CDX	H	LH	LF	LU	WF			Screw	Wrench	
		●	10	8	2.2	7.2	15	90	25	5.6			Yes	1	
●	12	10	2.2	9.4	15	90	30	6.6	Yes	2	SB-257OTR	FT-8	GE [®] ...C / CM/ CR		

CDX shows the distance from the toolholder to the cutting edge.
LH shows minimum overhang length.

Applicable sleeve ● F149, F150

Applicable Insert & Rake Angle (α) after Installment of Insert



Toolholder Description	Applicable Insert & Rake Angle (α) after Installment of Insert				
	Ground Chipbreaker	α	Molded Chipbreaker	α	
SIGE [®] /L 0808A-EH 1010B-EH 1210B-EH 1412C-EH 1612C-EH 1616C-EH 2020D-EH 2525E-EH 3232E-EH 4032E-EH	GE [®] /L 100-005A~GE [®] /L 200-010A GER100-050AR~GER200-100AR	5°	-	-	
	GE [®] /L 100-005B~GE [®] /L 300-020B GER100-050BR~GER200-100BR	5°	-	-	
	GE [®] /L 100-005C~GE [®] /L 350-020C GER200-100CR~GER300-150CR	8°	GER150-010CM~GER350-020CM	10°	
	GE [®] /L 100-005D~GE [®] /L 400-020D GER200-100DR~GER300-150DR	9°	GER150-010DM~GER400-020DM	10°	
	GE [®] /L 100-005E~GE [®] /L 500-020E	10°	GER150-010EM~GER500-020EM	10°	
	SIGE [®] /L 0808A-WH 1010B-WH 1210B-WH 1008B-WH-90 1210B-WH-90 1412C-WH 1612C-WH 1412C-WH-90	GE [®] /L 100-005A~GE [®] /L 200-010A GER100-050AR~GER200-100AR	5°	-	-
		GE [®] /L 100-005B~GE [®] /L 300-020B GER100-050BR~GER200-100BR	5°	-	-
		GE [®] /L 100-005C~GE [®] /L 350-020C GER200-100CR~GER300-150CR	8°	GER150-010CM~GER350-020CM	10°

α indicates the rake angle at the center of the edge width after installing insert.

● : Standard item R : Right-hand only L : Left-hand only □ : Check availability

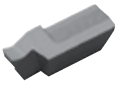
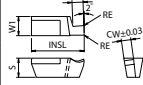
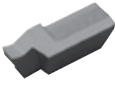
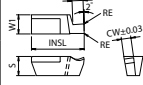

GV

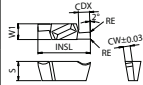
Insert		Description		Dimension (mm)							Tolerance (mm)		Carbide				Cemet	Applicable toolholder G86~G88																														
				No. of edges	CW	CDX	S	RE	INSL	W1	CW min.	CW max.	PVD	- PR125 PR930	- KW10	- TC60																																
																			Carbon steel / Alloy steel							Stainless steel							Cast iron							Non-ferrous metals							Titanium alloy	
  1-edge	GVR 100-020SS 125-020SS 145-020SS 200-020SS 250-020SS 300-020SS GVL 100-020SS 125-020SS 145-020SS 200-020SS 250-020SS 300-020SS	1	1	2.3	3	0.2	9	3.6	-0.03	+0.03	●	●	●	●	GIVR1216-1SS GIVL1216-1SS																																	
			1.25								●	●	●	●																																		
  1-edge	GVR 100-020S 125-020S 145-020S 185-020S 200-020S 250-020S 340-020S GVL 100-020S 125-020S 145-020S 185-020S 200-020S 250-020S 340-020S	1	1	2.3	4	0.2	11	4	-0.03	+0.03	●	●	●	●	GIVR1420-1S GIVR1412-1SE GIVL1420-1S GIVL1412-1SE																																	
			1.25								●	●	●	●																																		
  2-edge	GVR 100-020A 125-020A 145-020A 185-020A 200-020A 250-020A 300-020A 340-020A GVL 100-020A 125-020A 145-020A 185-020A 200-020A 250-020A 300-020A 340-020A	2	1	2.3	5	0.2	12	4	-0.03	+0.03	●	●	●	●	GIVR1620-1A GIVR1612-1AE GIVR1616-1AW GIVL1620-1A GIVL1612-1AE GIVL1616-1AW																																	
			1.25								●	●	●	●																																		

Right-hand shown
CDX shows available grooving depth.

Recommended cutting conditions  G146

● : Standard item R : Right-hand only L : Left-hand only □ : Check availability

GV

		Carbon steel / Alloy steel										P					
		Stainless steel										M					
		Cast iron										K					
		Non-ferrous metals										N					
		Titanium alloy										S					
		Hard materials (~ 40HRC)										H					
		Hard materials (40HRC ~)															
Insert	Description	No. of edges	Dimension (mm)						Tolerance (mm)		Carbide		Cemet	PCD	Applicable toolholder G86~G88		
			CW	CDX	S	RE	INSL	W1	CW min.	CW max.	PVD	-					
 2-edge	GVR	145-020B 185-020B 200-020B 230-020B 250-020B	1.45	2.8												GIVR2025-1B GIVR2016-1BE GIVR2020-1BW	
			1.85	2.8													
			2	3.2													
			2.3	3.2													
			2.5	3.2													
		GVL	145-020B 185-020B 200-020B 230-020B 250-020B 280-020B 300-020B 400-020B	1.45	2.8											GIVL2025-1B GIVL2016-1BE GIVL2020-1BW	
		1.85		2.8													
		2		3.2													
		2.3		3.2													
		2.5		3.2													
		2.8		3.2													
		3		4.2													
		3.4		4.2													
		4		4.2	5.5	0.2	15	4.5	-0.03	+0.03							
 2-edge	GVR	280-020C 300-020C 340-020C 400-020C 430-020C 460-020C 500-020C	2.8	4.5											GIVR...-1C GIVR...-1CE GIVR...-1CW		
			3	4.5													
			3.4	5.5													
			4	5.5													
			4.3	6.3													
		GVL	280-020C 300-020C 340-020C 400-020C 430-020C 460-020C 500-020C	2.8	4.5	6.5	0.2	21	5.8	-0.03	+0.03					GIVL...-1C GIVL...-1CE GIVL...-1CW	
		3		4.5													
		3.4		5.5													
		4		5.5													
		4.3		6.3													
		4.6		6.3													
		5		6.3													
		4		5.5													
		4.3		6.3													
 1-edge	GVR	145-020A 200-020A	1.45 2	2.3	5	0.2	12	4	-0.03	+0.03					GIVR1620-1A GIVR1612-1AE GIVR1616-1AW		
	GVR	200-020B 250-020B	2 2.5	3.2	5.5	0.2	15	4.5	-0.03	+0.03						GIVR2025-1B GIVR2016-1BE GIVR2020-1BW	
	GVL	200-100AR 250-125AR 300-150AR	2 2.5 3	2.3	5	1.25 1.5 1	12	4	-0.03	+0.03							GIVR2025-1B GIVR2016-1BE GIVR2020-1BW
	GVL	200-100AR	2			1											
 2-edge / Full R / Copying	GVR	200-100BR 300-150BR	2 3	3.2 4.2	5.5	1 1.5	15	4.5	-0.03	+0.03					GIVR2025-1B GIVR2016-1BE GIVR2020-1BW		

Right-hand shown
CDX shows available grooving depth.

Recommended cutting conditions G146

● : Standard item R : Right-hand only L : Left-hand only □ : Check availability

CBN & PCD Inserts are sold in 1 piece boxes

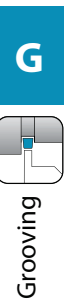

GIV Steel shank bar (Internal grooving)

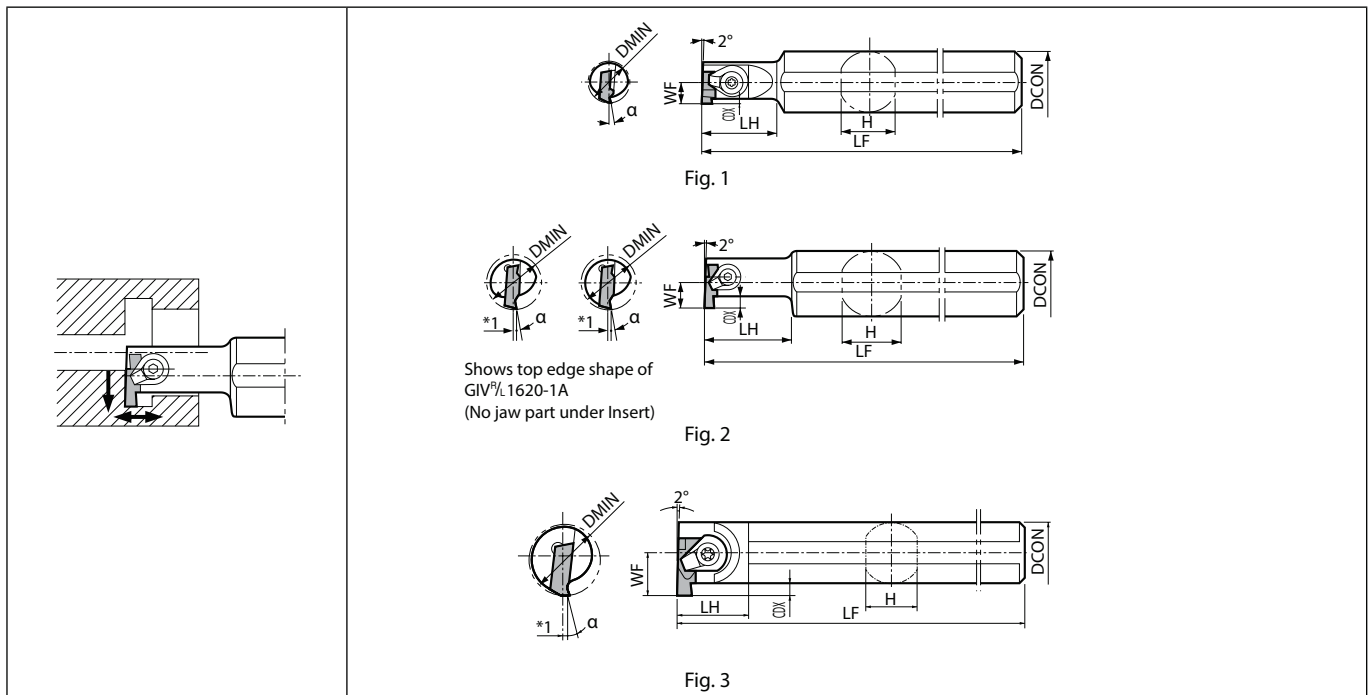

Right-hand shown | Right-hand Insert for Right-hand Toolholder, Left-hand Insert for Left-hand Toolholder.

Toolholder dimensions

Description	Availability		Dimension (mm)								Fig.	Spare parts					Applicable inserts ➔ G84,G85
												Clamp set	Clamp set	Wrench	Wrench	Wrench	
	R	L	DMIN	DCON	CDX	H	LH	LF	WF								
GIV%L 1216-1SS	●	●	12	16	2.2	15	20	150	6	1	CPS-4V	-	-	-	FT-10	GIV%L...-020SS	
GIV%L 1420-1S	●	●	14	20	2.2	19	24	150	7	1	CPS-5F	-	-	FT-15	-	GIV%L...-020S	
GIV%L 1620-1A	●	●	16	20	2.2	19	28	160	8	2	CPS-5V	-	-	FT-15	-	GIV%L...-...A(R)	
GIV%L 2025-1B	●	●	20	25	*1 2.8	23	35	180	10	2	CPS-5V	-	-	FT-15	-	GIV%L 145 ~ 250-...B(R)	
GIV%L 2025-2B	●	●			*2 3.2											GIV%L 280 ~ 400-...B(R)	
GIV%L 2532-1C	●	●	25	32	*3 4.5	30	43	200	12.5	2	-	CPS-6V	LW-3	-	-	GIV%L 280 ~ 340-020C	
GIV%L 2532-2C	●	●			*4 5.5											GIV%L 400 ~ 500-020C	
GIV%L 3232-1C	●	●	32	32	*3 4.5	52	220	16								GIV%L 280 ~ 340-020C	
GIV%L 3232-2C	●	●			*4 5.5											GIV%L 400 ~ 500-020C	
GIV%L 4032-1C	●	●	40	32	*3 4.5	30	43	250	21	3	-	CPS-6V	LW-3	-	-	GIV%L 280 ~ 340-020C	
GIV%L 4032-2C	●	●			*4 5.5											GIV%L 400 ~ 500-020C	

GIV are designed to set the cutting edge height 1mm above the center height.

CDX shows available grooving depth.

*1. GIV%L 200~250-020B Insert can be used up to a Groove Depth 3.2mm.

*2. GIV%L 300~400-020B Insert can be used up to a Groove Depth 4.2mm.

*3. GIV%L 340-020C Insert can be used up to a Groove Depth 5.5mm.

*4. GIV%L 430~500-020C Insert can be used up to a Groove Depth 6.3mm.

If you need any of insert groove depth specified in *1 to *4, modify the dimension CDX of toolholder.

● : Standard item R : Right-hand only L : Left-hand only □ : Check availability

GIV-E Excellent bar (Internal grooving)

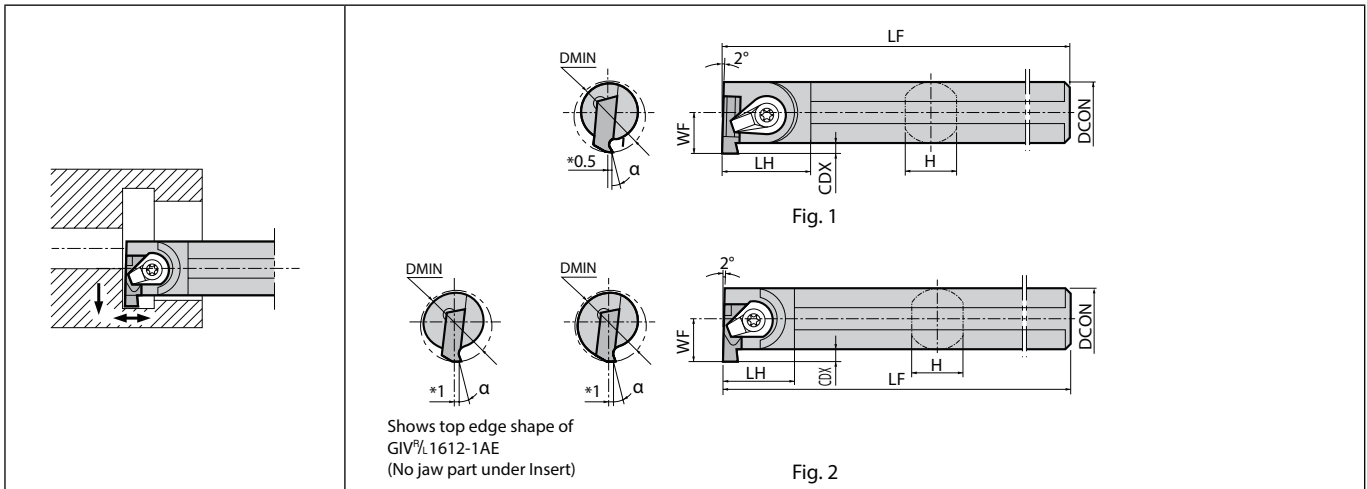

Right-hand shown | Right-hand Insert for Right-hand Toolholder, Left-hand Insert for Left-hand Toolholder.

Toolholder dimensions

Description	Availability		Dimension (mm)								Fig.	Spare parts				Applicable inserts G84, G85
												Clamp set	Clamp set	Wrench	Wrench	
	R	L	DMIN	DCON	CDX	H	LH	LF	WF							
GIV%L 1412-1SE	●	●	14	12	1.7	11.4	18	150	7.7	1	CPS-5F	-	-	FT-15	GV%L...-020S	
GIV%L 1612-1AE	●	●	16	12	2.2	11.4	19	150	8.2	2	CPS-5V	-	-	FT-15	GV%L...-A(R)	
GIV%L 2016-1BE	●	●	20	16	*1 2.8	15.2	20	180	11.2	2	CPS-5V	-	-	FT-15	GV%L 145 ~ 250-...B(R)	
GIV%L 2016-2BE	●	●			*5 3.2										19	11.7
GIV%L 2520-1CE	●	●	25	20	*6 4.5	19	25	200	14.5	2	-	CPS-6V	LW-3	-	GV%L 280 ~ 340-020C	
GIV%L 2720-2CE	●	●	27	*4 5.5	16.2										GV%L 400 ~ 500-020C	
GIV%L 3225-1CE	●	●	32	25	*7 4.5	24	24	220	17.5	2	-	CPS-6V	LW-3	-	GV%L 280 ~ 340-020C	
GIV%L 3225-2CE	●	●			*4 5.5										18.7	GV%L 400 ~ 500-020C
GIV%L 4032-1CE	●	●	40	32	*7 4.5	31	29	240	21	2	-	CPS-6V	LW-3	-	GV%L 280 ~ 340-020C	
GIV%L 4032-2CE	●	●			*4 5.5										22.2	GV%L 400 ~ 500-020C

GIV-E are designed to set the cutting edge height 1mm above the center height. (0.5mm for GIV%L 1612-1AE)
CDX shows available grooving depth.

- *1. GV%L 200~250-020B Insert can be used up to a Groove Depth 3.2mm.
 - *4. GV%L 430~500-020C Insert can be used up to a Groove Depth 6.3mm.
 - *5. GV%L 300~400-020B Insert can be used up to a Groove Depth 3.8mm. (When using GIV%L 2016-2BE)
 - *6. GV%L 340-020C Insert can be used up to a Groove Depth 4.7mm. (When using GIV%L 2520-1CE)
 - *7. GV%L 340-020C Insert can be used up to a Groove Depth 5.3mm. (When using GIV%L 3225-1CE, GIV%L 4032-1CE)
- If you need any of insert groove depth specified in *1 to *7, modify the dimension CDX of toolholder.



GIV-W Carbide shank bar (Internal grooving)

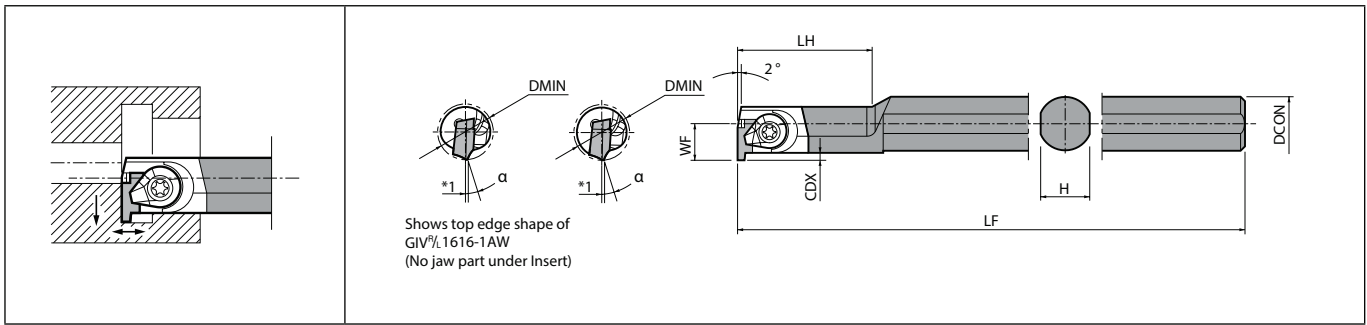

Right-hand shown | Right-hand Insert for Right-hand Toolholder, Left-hand Insert for Left-hand Toolholder.

Toolholder dimensions

Description	Availability		Dimension (mm)								Spare parts				Applicable inserts ➔ G84, G85
											Clamp set	Clamp set	Wrench	Wrench	
R	L	DMIN	DCON	CDX	H	LH	LF	WF							
GIV% 1616-1AW	●	●	16	16	2.2	15	48	175	10.6	CPS-5V	-	-	FT-15	GIV%...A(R)	
GIV% 2020-1BW	●	●	20	20	*1 2.8	19	60	220	14.6	CPS-5V	-	-	FT-15	GIV% 145 ~ 250...B(R)	
GIV% 2020-2BW	●	●			*2 3.2									GIV% 280 ~ 400...B(R)	
GIV% 2525-1CW	●	●	25	25	*3 4.5	24	70	260	19.1	-	CPS-6V	LW-3	-	GIV% 280 ~ 340-020C	
GIV% 2525-2CW	●	●			*4 5.5									GIV% 400 ~ 500-020C	

GIV-W are designed to set the cutting edge height 1mm above the center height.

CDX shows available grooving depth.

*1. GIV% 200~250-020B Insert can be used up to a Groove Depth 3.2mm.

*2. GIV% 300~400-020B Insert can be used up to a Groove Depth 4.2mm.

*3. GIV% 340-020C Insert can be used up to a Groove Depth 5.5mm.

*4. GIV% 430~500-020C Insert can be used up to a Groove Depth 6.3mm.

If you need any of insert groove depth specified in *1 to *4, modify the dimension CDX of toolholder.

Applicable Insert & Rake Angle (α) after Installment of Insert

Toolholder Description	Insert Description ➔ G84, G85		Rake Angle (α)	
	General Grooving (Square)	Full-R Grooving (Round)	TC40	TN90, TC60 PR930, PR1225 KW10
GIV%...1SS	GIV% 100~300-020SS	-	10°	15°
GIV%...1S	GIV% 100~340-020S	-	10°	15°
GIV%...1SE	GIV% 100~340-020S	-	3°	8°
GIV%...1A(□)	GIV% 100~340-020A	GIV% 200-100AR~300-150AR	3°	8°
GIV%...1B(□)	GIV% 145~250-020B	GIV% 200-100BR	4°	9°
GIV%...2B(□)	GIV% 280~400-020B	GIV% 300-150BR		
GIV%...1C(□)	GIV% 280~340-020C	-	5°	10°
GIV%...2C(□)	GIV% 400~500-020C	-		

● : Standard item R : Right-hand only L : Left-hand only □ : Check availability

KIGBA (Internal grooving / Shallow grooving)

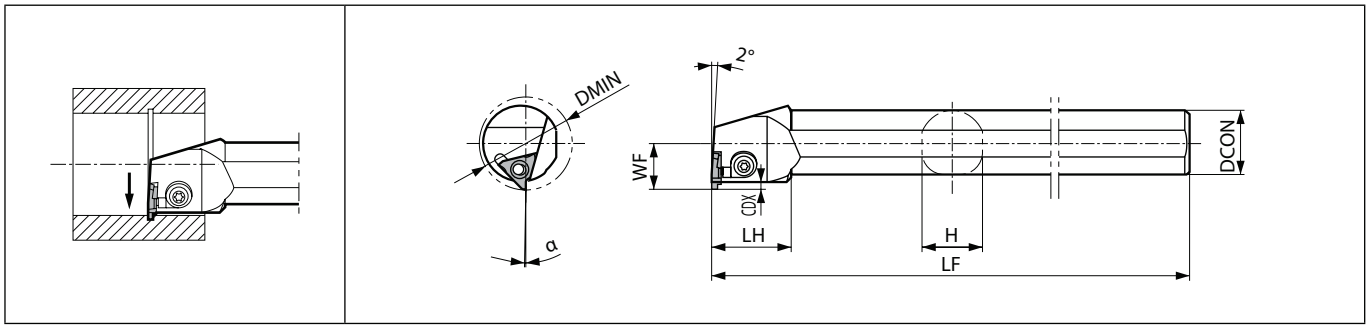

Right-hand shown | Left-hand Insert for Right-hand Toolholder, Right-hand Insert for Left-hand Toolholder.

Toolholder dimensions

Description	Availability		Dimension (mm)								Spare parts		Applicable inserts G6~G12
	R	L	DMIN	DCON	CDX	H	LH	LF	WF				
KIGBA [®] /L 3525-16	●	●	35	25	2.8	23	30	220	17.5	LGBA-16 ¹ / ₈ S	FT-15	GBA32 ¹ / ₈ type	
KIGBA [®] /L 4032-22	●	●	40	32	3	30	30	250	23	LGBA-22 ¹ / ₈ S	FT-15	GBA43 ¹ / ₈ type	

CDX shows the distance from the toolholder to the cutting edge.

Available Grooving Depth depends on the insert.

KIGBA[®]/L 3525-16 : CDX of the applicable insert (GBA32)

4032-22 : CDX of the applicable insert (GBA43) (1) 2.0 mm (CDX < 3.0 mm) (2) 3.0 mm (CDX ≥ 3.0 mm)

Clamp Set : LGBA-○○LS for Right-hand Toolholder, and LGBA-○○RS for Left-hand Toolholder.

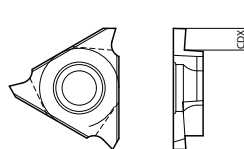

Rake Angle (α) after Installment of GBA insert

GBA32 [®] /L○○○-○○○		GBA43 [®] /L○○○-○○○		GBA43 [®] /L○○○-○○○R (Full-R)		
α	Insert Grades	α	Insert Grades	α	Insert Grades	Full-R Description
+1°	TN620, TN90, PV7040 PR930, PR1215, PR1625, PR905 KPD001, KPD010	-9°	KBN510, KBN525	+1°	TN620, TN90, PV7040 PR930, PR1215, PR1625, PR905	050R~150R
		+1°	TN620, TC40, TN90, PV7040 PR930, PR1215, PR1625, PR905 KPD001, KPD010			
+11°	KW10	+11°	KW10	+5°	TN620, TN90, PV7040 PR930, PR1215, PR1625, PR905	200R
				+5°	KW10	050R~200R

Rake Angle (α) after Installment of GBA-GM insert

α	Insert Description
+1°	GBA43 [®] /L 150-020GM
+6°	GBA43 [®] /L 175-020GM
	GBA43 [®] /L 265-030GM
+3°	GBA43 [®] /L 300-030GM
	GBA43 [®] /L 400-040GM

α indicates the rake angle at the center of the edge width, after installing insert.

Rake Angle (α) after Installment of GBA-MY insert





α	Insert Description
+6°	GBA43 [®] /L 175-020MY
+5°	GBA43 [®] /L 350-030MY
	GBA43 [®] /L 400-040MY

α indicates the rake angle at the center of the edge width, after installing insert.

● : Standard item R : Right-hand only L : Left-hand only □ : Check availability

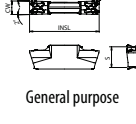

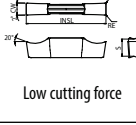
GDM/GDG

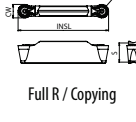
Insert		Description	No. of edges	Dimension (mm)				Tolerance (mm)		Carbide			Cermet	Applicable toolholder G91			
				CW	S	RE	INSL	CW min.	CW max.	PVD	-	-					
										PRI215	PRI225	PRI335	GW15	TNG20	TNG90		
				Carbon steel / Alloy steel				☺	☹	☺	☹	☹	☹	☹	☹	☹	P
				Stainless steel				☺	☹	☹	☹	☹	☹	☹	☹	☹	M
				Cast iron				☹	☹	☹	☹	☹	☹	☹	☹	☹	K
				Non-ferrous metals				☹	☹	☹	☹	☹	☹	☹	☹	☹	N
				Titanium alloy				☹	☹	☹	☹	☹	☹	☹	☹	☹	S
				Hard materials (~ 40HRC)				☹	☹	☹	☹	☹	☹	☹	☹	☹	H
				Hard materials (40HRC ~)				☹	☹	☹	☹	☹	☹	☹	☹		
  General purpose	GDM	2013N-020GMI	2	2	4.3	0.2	13.5	-0.03	+0.03	●	●	●	●	●	●	KGDI [®] /L...-2	
	GDM	3015N-040GMI	2	3	4.6	0.4	15.5	-0.03	+0.03	●	●	●	●	●	●	KGDI [®] /L...-3	
	GDM	4020N-040GMI	2	4	4.3	0.4	20	-0.03	+0.03	●	●	●	●	●	●	KGDI [®] /L...-4	
	GDM	5020N-040GMI 5020N-080GMI	2	5	4.3	0.4 0.8	20	-0.04	+0.04	●	●	●	●	●	●	KGDI [®] /L...-4 KGDI [®] /L...-5	
  Low cutting force	GDG	3015N-020GS	2	3	4.6	0.2	15.6	-0.02	+0.02	●	●	●	●	●	●	KGDI [®] /L...-3	
	GDG	4020N-040GS	2	4	4.3	0.4	20	-0.02	+0.02	●	●	●	●	●	●	KGDI [®] /L...-4	
	GDG	5020N-040GS	2	5	4.3	0.4	20	-0.02	+0.02	●	●	●	●	●	●	KGDI [®] /L...-4 KGDI [®] /L...-5	
  Full R / Copying	GDM	3015N-150R-CM	2	3	4.6	1.5	16.3	-0.03	+0.03	●	●	●	●	●	●	KGDI [®] /L...-3	
	GDM	4020N-200R-CM	2	4	4.3	2	20	-0.03	+0.03	●	●	●	●	●	●	KGDI [®] /L...-4	
	GDM	5020N-250R-CM	2	5	4.3	2.5	21	-0.04	+0.04	●	●	●	●	●	●	KGDI [®] /L...-4 KGDI [®] /L...-5	

Recommended cutting conditions G147

● : Standard item R : Right-hand only L : Left-hand only ☐ : Check availability

G

Grooving

External

Internal

Face

KGDI (Internal grooving)

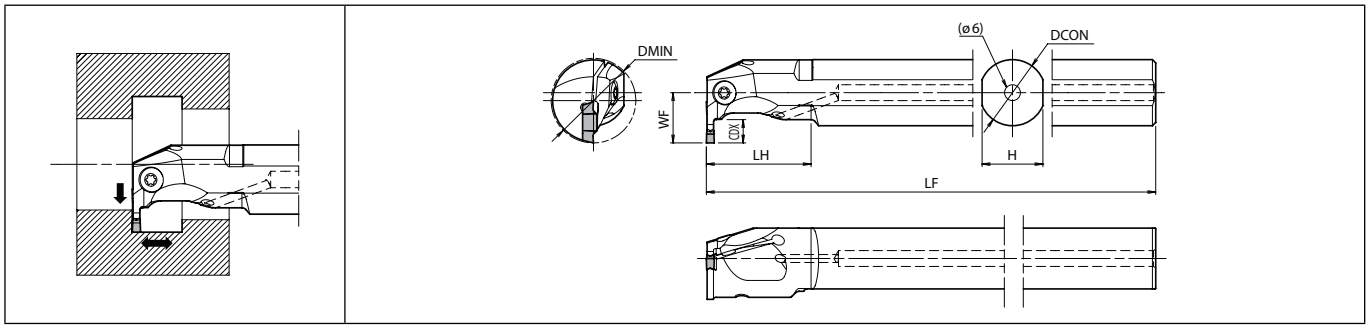

Right-hand shown

Toolholder dimensions

Description	Availability		Dimension (mm)											Coolant hole	Spare parts				Applicable inserts G90
			R	L	DMIN			DCON	CDX	H	LH	LF	WF		CW min.	CW max.	Clamp screw (Torx)	Screw	
	with GMI/GS	with CM			*with CM	SB-5TR	GS-50										LW-3	LTW-20	
KGDI ^{1/2} 1816B-2 2520B-2 3225B-2	●	●	18			16	4.5	15	25	150	9.5			Yes	-	GS-50	LW-3	-	GDM2013N-020GMI
	●	●	25	-	-	20	6	18	30	180	14.5				SB-5TR	-	-	LTW-20	
	●	●	32			25	7	23	40	200	19								
KGDI ^{1/2} 2016B-3 2520B-3 3225B-3	●	●	20	21		16	5.5	15	25	150	11.5			Yes	-	GS-50	LW-3	-	GDM3015N-...
	●	●	25	26	-	20	6	18	30	180	14.5				SB-5TR	-	-	LTW-20	
	●	●	32	33		25	8	23	40	200	19								
KGDI ^{1/2} 3225B-4 4032B-4	●	●	32	40	34	25	8.5	23	40	200	19			Yes	SB-5TR	-	-	LTW-20	GDM4020N-...
	●	●	40	48	42	32	11	29	50	220	23.5								
KGDI ^{1/2} 3225B-5 4032B-5	●	●	32	37	34	25	8.5	23	40	200	19			Yes	SB-5TR	-	-	LTW-20	GDM5020N-...
	●	●	40	45	42	32	11	29	50	220	23.5								



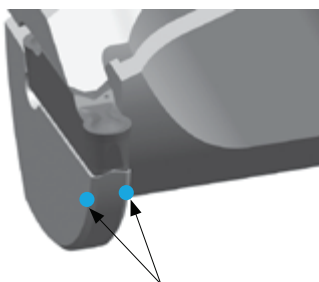

* Possible by slightly chamfering toolholder's tip about 0.5 mm

Additional processing of toolholder tip when CM chipbreaker is installed

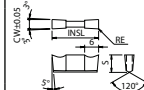

* By slightly chamfering the holder tip of about 0.5 mm, the cutting diameter can be minimized.

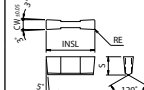
GH/GHU

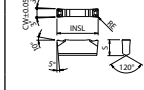
Cutting edge preparation				Material										P					
				Carbon steel / Alloy steel										✱	M				
Symbol	Specification	Example																	
S	Chamfered and R-honed	S01020	0.10mm × 20° chamfered and R-honed																
T	Chamfered	T01020	0.10mm × 20° chamfered																
				Titanium alloy										N					
				Hard materials (~ 40HRC)										S					
				Hard materials (40HRC ~)										H					
Insert		Description		Edge preparation type	No. of edges	Dimension (mm)				Tolerance (mm)		Carbide		Ceramic		Cermet		Applicable toolholder G93	
						CW	S	RE	INSL	CW min.	CW max.	CB9025	PVD	PVD	-	AG6N	AG5		TC40
		GH	4020-02 4020-05	-	2	4	7.5	0.2 0.5	20	-0.05	+0.05	●	●			●	●		KIGHR4532B-4 KIGHR5540B-4 KIGHR6550B-4
		GH	4520-02 4520-05	-	2	4.5	7.5	0.2 0.5	20	-0.05	+0.05					●	●		KIGHR4532B-5 KIGHR5540B-5 KIGHR6550B-5
		GH	5020-02 5020-05	-	2	5	7.5	0.2 0.5	20	-0.05	+0.05	●	●			●	●		KIGHR4532B-7 KIGHR5540B-7 KIGHR6550B-7
		GH	5520-02 5520-05	-	2	5.5	7.5	0.2 0.5	20	-0.05	+0.05					●	●		KIGHR4532B-4 KIGHR5540B-4 KIGHR6550B-4
		GH	6020-02 6020-05	-	2	6	7.5	0.2 0.5	20	-0.05	+0.05	●	●			●	●		KIGHR4532B-5 KIGHR5540B-5 KIGHR6550B-5
		GH	6520-02 6520-05	-	2	6.5	7.5	0.2 0.5	20	-0.05	+0.05					●	●		KIGHR4532B-7 KIGHR5540B-7 KIGHR6550B-7
		GH	7020-02 7020-05	-	2	7	7.5	0.2 0.5	20	-0.05	+0.05	●	●			●	●		KIGHR4532B-4 KIGHR5540B-4 KIGHR6550B-4
		GH	7520-02 7520-05	-	2	7.5	7.5	0.2 0.5	20	-0.05	+0.05					●	●		KIGHR4532B-5 KIGHR5540B-5 KIGHR6550B-5
		GH	4020-05	S01020 T01020	2	4	7.5	0.5	20	-0.05	+0.05			●	●			KIGHR4532B-4 KIGHR5540B-4 KIGHR6550B-4	
		GH	5020-05	S01020 T01020	2	5	7.5	0.5	20	-0.05	+0.05			●	●			KIGHR4532B-5 KIGHR5540B-5 KIGHR6550B-5	
		GH	6020-05	T01020	2	6	7.5	0.5	20	-0.05	+0.05					●	●		KIGHR4532B-7 KIGHR5540B-7 KIGHR6550B-7
		GH	7020-05	T01020	2	7	7.5	0.5	20	-0.05	+0.05					●	●		KIGHR4532B-4 KIGHR5540B-4 KIGHR6550B-4
		GHU	40-20	-	2	4	7.5	0.25	20	-0.05	+0.05	●					●	KIGHR4532B-4 KIGHR5540B-4 KIGHR6550B-4	
		GHU	50-20	-	2	5	7.5	0.3	20	-0.05	+0.05	●					●	KIGHR4532B-5 KIGHR5540B-5 KIGHR6550B-5	
		GHU	60-20	-	2	6	7.5	0.3	20	-0.05	+0.05	●					●	KIGHR4532B-4 KIGHR5540B-4 KIGHR6550B-4	

Recommended cutting conditions G65

● : Standard item R : Right-hand only L : Left-hand only □ : Check availability

KIGH (Internal grooving / Deep grooving)

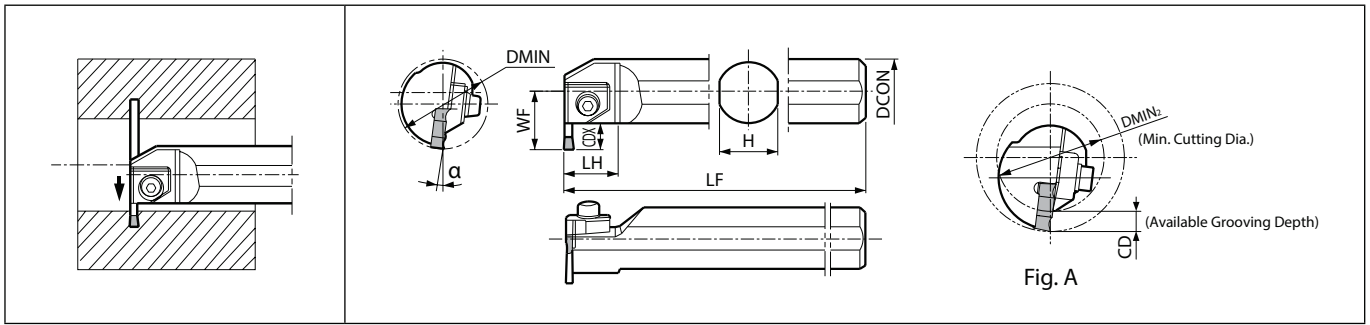

Right-hand shown

Toolholder dimensions

Description	Availability	Dimension (mm)								Spare parts					Applicable inserts G92
										Clamp (L)	Clamp bolt	Spring	Washer	Wrench	
		R	DMIN	DCON	CDX	H	LH	LF	WF						
KIGHR 4532B-4	●	45	32		30		200	28.2	CGH-1L	HH6X25	SP-6	W-6	LW-5	GH4020-... / GHU40-... GH4520-...	
5540B-4	●	55	40	12	38	27	250	32.3							
6550B-4	●	65	50		48		300	37.3							
KIGHR 4532B-5	●	45	32		30		200	28.2	CGH-1L	HH6X25	SP-6	W-6	LW-5	GH5020-... / GHU50-... / GH5520-... GH6020-... / GHU60-... / GH6520-...	
5540B-5	●	55	40	12	38	27	250	32.3							
6550B-5	●	65	50		48		300	37.3							
KIGHR 5540B-7	●	55	40	12	38	27	250	32.3	CGH-2L	HH6X25	SP-6	W-6	LW-5	GH7020-... / GH7520-... / GH8020-...	

CDX shows the distance from the toolholder to the cutting edge. For the available grooving depth (CD), ref. to „List of Min. Available Cutting Diameter and Groove Depth“.

LH depends on the insert's edge width.

Rake Angle (α) after Installation of GH / GHU insert

GH○○○○○○○		GHU○○○○○	
α	Insert Grades	α	Insert Grades
-5°	A65, A66N, PT600M	+5°	TN60 CR9025
+5°	TC40		
+15°	TN90, TC60 PR930 KW10		





List of the Min. Cutting Diameter and Grooving Depth (Refer to Fig. A)

Toolholder Description	DMINz (Min. Cutting Dia.)						
	ø110	ø70	ø65	ø60	ø55	ø45	
KIGHR 4532B-○	ø110	ø70	ø65	ø60	ø55	ø45	
5540B-○	ø70	ø60	ø55				
6550B-○	ø65						
Available Grooving Depth CD (mm)	12	11.5	11	10	9	Under 8	

● : Standard item R : Right-hand only L : Left-hand only □ : Check availability

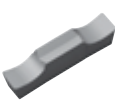
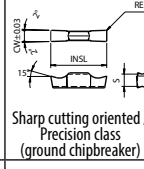

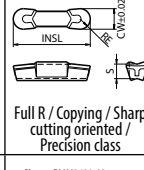
GMM/GMG/GMGA

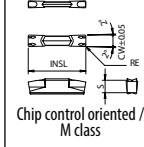
		Carbon steel / Alloy steel		Stainless steel		Cast iron		Non-ferrous metals		Titanium alloy		Hard materials (~ 40HRC)		Hard materials (40HRC ~)		
		P		M		K		N		S		H				
Insert	Description	No. of edges	Dimension (mm)				Tolerance (mm)		Carbide					Cermét	Applicable toolholder G95	
			CW	S	RE	INSL	CW min.	CW max.	CVD		PVD		-			-
									CB9025	PR905	PR915	PR930				
	 Sharp cutting oriented / Precision class (ground chipbreaker)	2	8	5.5	0.5	30	-0.03	+0.03	●	●	●	●	●			
	 Full R / Copying / Sharp cutting oriented / Precision class	2	8	5.5	4	30	-0.02	+0.02					●			KIGM [®] /L6540B-8 KIGMUR6540B-8
	 Shows GMM2420-G2 Chip control oriented / M class	2	8	5.5	0.8	30	-0.05	+0.05	●	●	●	●				

If using a full-R insert with KIGM-8 toolholder, you need to modify the corner of insert adapter of toolholder.

Recommended cutting conditions  G143

G

Grooving

External

Internal

Face

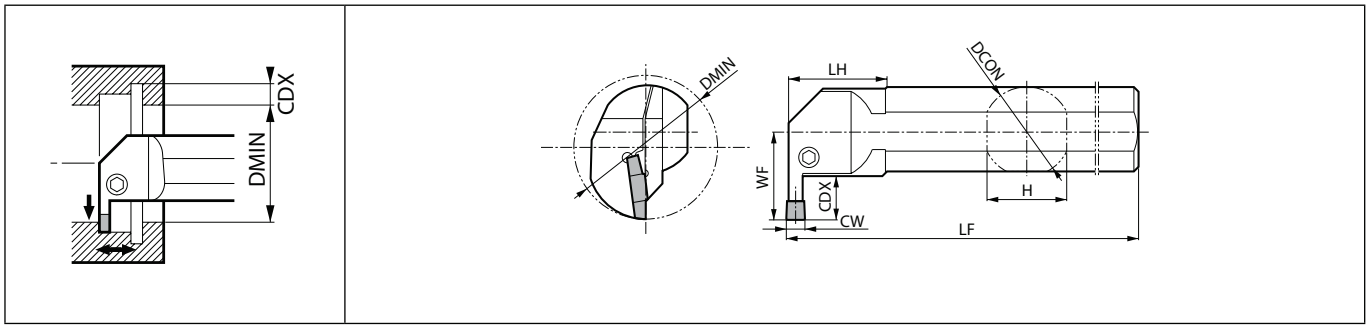

● : Standard item R : Right-hand only L : Left-hand only □ : Check availability

KIGM-8 (Internal grooving)



Right-hand shown

Toolholder dimensions

Description	Availability		Dimension (mm)										Spare parts		Applicable inserts ➔ G94
													Clamp bolt	Wrench	
	R	L	DMIN	DCON	CDX	H	LH	LF	WF	CW min.	CW max.				
KIGM%L 6540B-8	●	●	65	40	20	36	41	300	41	8	8	HH6X20	LW-5	GM..8030-...	

CDX shows available grooving depth.



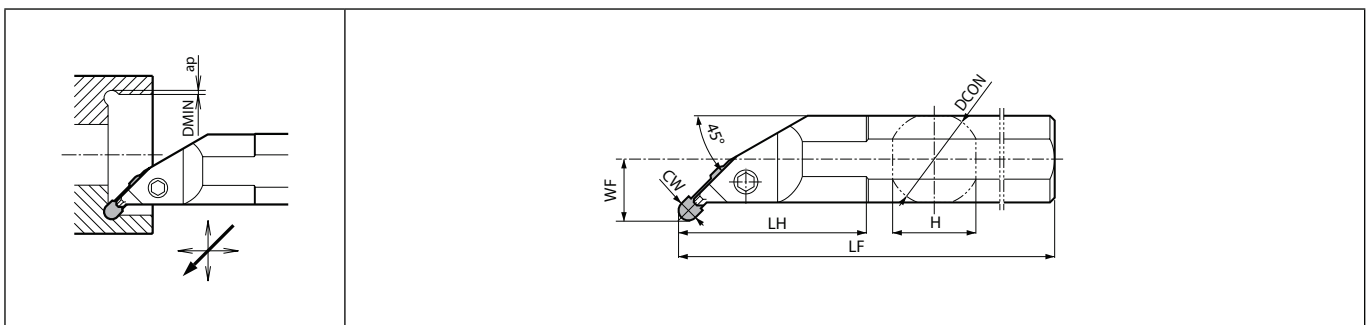

KIGMU-8 (Internal grooving / Undercut grooving)



Right-hand shown

Toolholder dimensions

Description	Availability		Dimension (mm)										Spare parts		Applicable inserts ➔ G94
													Clamp bolt	Wrench	
	R	DMIN	DCON	H	LH	ap	LF	WF	CW min.	CW max.					
KIGMUR 6540B-8	●	65	40	36	83	2.2	300	26	8	8	HH6X20	LW-5	GM..8030-...		

CDX shows available grooving depth.

ap shows the distance from the internal face of the workpiece.

GIA

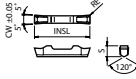
		Carbon steel / Alloy steel		●	○	P							
		Stainless steel		●	○	M							
		Cast iron				K							
		Non-ferrous metals				N							
		Titanium alloy				S							
		Hard materials (~ 40HRC)		●	○	H							
		Hard materials (40HRC ~)											
Insert	Description	No. of edges	Dimension (mm)				Tolerance (mm)		Carbide		CVD	Cermet	Applicable toolholder G97
			CW	S	RE	INSL	CW min.	CW max.	CR9025	TN60			
  Molded Chipbreaker	GIA 30	2	3	5	0.2	25	-0.05	+0.05	●	●			KGIA3232B-3 KGIA4332B-3 KGIA5140B-3
	GIA 40	2	4	5	0.25	25	-0.05	+0.05	●	●			KGIA3232B-4 KGIA4332B-4 KGIA5140B-4
	GIA 50	2	5	5	0.3	30	-0.05	+0.05	●	●			KGIA5640B-5 KGIA6650B-5



Grooving

External
Internal
Face

GIA inserts - molded chipbreaker

Workpiece material	Recommended insert grades (Vc: m/min)		(1) f for grooving (mm/rev) (2) f for turning (mm/rev) (3) ap for turning (mm)			Remarks
	Cermet	CVD Coated carbide	GIA 30	GIA 40	GIA 50	
Carbon steel	☆ 60~120	★ 60~120	(1) 0.04~0.08 (2) 0.02~0.08 (3) Max. 0.3	(1) 0.04~0.09 (2) 0.02~0.08 (3) Max. 0.4	(1) 0.05~0.1 (2) 0.05~0.08 (3) Max. 0.5	Coolant
Alloy steel	☆ 60~100	★ 60~100	(1) 0.04~0.07 (2) 0.02~0.07 (3) Max. 0.3	(1) 0.04~0.07 (2) 0.02~0.07 (3) Max. 0.4	(1) 0.05~0.08 (2) 0.05~0.08 (3) Max. 0.5	
Stainless steel	-	★ 60~80	(1) 0.04~0.07 (2) 0.02~0.07 (3) Max. 0.3	(1) 0.04~0.07 (2) 0.02~0.07 (3) Max. 0.4	(1) 0.05~0.08 (2) 0.05~0.08 (3) Max. 0.5	

★ :1st recommendation ☆ :2nd recommendation

● : Standard item R : Right-hand only L : Left-hand only □ : Check availability

KGIA (Internal grooving / Deep grooving)

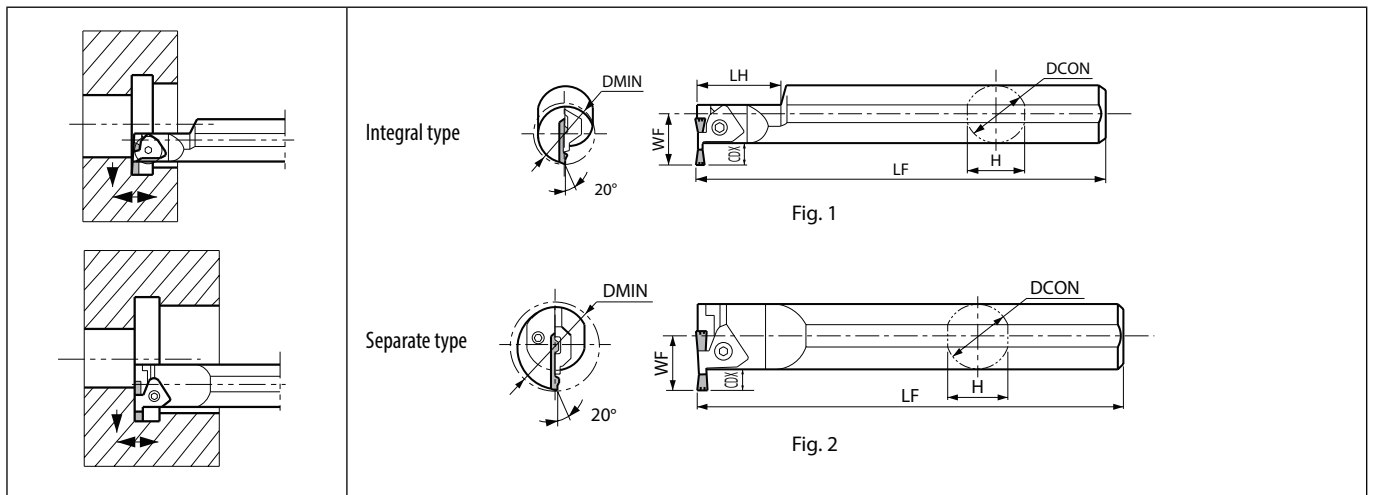

Right-hand shown

Toolholder dimensions

Description	Availability	Dimension (mm)								Fig.	Spare parts				Applicable inserts ➔ G96
		R	DMIN	DCON	CDX	H	LH	LF	WF		Clamp bolt	Clamp	Spring	Wrench	
KGIAR 3232B-3 4332B-3 5140B-3	●	32	32	10	30.4	45	200	26.5	1	HH5X15	CGIA-3R	SP-5	LW-4	GIA30	
	●	43			30	-		26.3							
	●	51	40	38	-	250	30.3	2							
KGIAR 3232B-4 4332B-4 5140B-4	●	32	32	10	30.4	45	200	26.5	1	HH5X15	CGIA-4R	SP-5	LW-4	GIA40	
	●	43			30	-		26.3							
	●	51	40	38	-	250	30.3	2							
KGIAR 5640B-5 6650B-5	●	56	40	15	38	-	250	35.3	2	HH5X15	CGIA-5R	SP-5	LW-4	GIA50	
	●	66			48	-		300							40.3

CDX shows available grooving depth.



Composition

Type	Spare Parts		Toolholder	Blade	Clamp Screw	Wrench
	Toolholder Description					
Integral Type	KGIAR	3232B-3	-	-	-	-
Separate Type	KGIAR	4332B-3	KGIAR32H	BGIAR43-3	SB-40140TR	FT-15
		5140B-3	KGIAR40H	BGIAR51-3		
Integral Type	KGIAR	3232B-4	-	-	-	-
Separate Type	KGIAR	4332B-4	KGIAR32H	BGIAR43-4	SB-40140TR	FT-15
		5140B-4	KGIAR40H	BGIAR51-4		
Separate Type	KGIAR	5640B-5	KGIAR40H	BGIAR56-5	SB-40140TR	FT-15
		6650B-5	KGIAR50H	BGIAR66-5		

● : Standard item R : Right-hand only L : Left-hand only □ : Check availability



GMM-V

		Carbon steel / Alloy steel		Stainless steel		Cast iron		Non-ferrous metals		Titanium alloy		Hard materials (~ 40HRC)		Hard materials (40HRC ~)	
		P		M		K		N		S		H			
Insert	Description	No. of edges	Dimension (mm)				Tolerance (mm)		Carbide				Cermét	Applicable toolholder	
			CW	S	RE	INSL	CW min.	CW max.	CVD		PVD				
									CB9025	PR905	PR915	PR930			KW10
	GMM 3015-040V Chip control oriented / M class	2	3	4.3	0.4	15.5	-0.05	+0.05	●	●	●	●	●	●	KIGM%....B-3V
	GMM 4020-040V Chip control oriented / M class	2	4	4.3	0.4	20	-0.05	+0.05	●	●	●	●	●	●	KIGM%....B-4V
	GMM 5020-080V Chip control oriented / M class	2	5	4.3	0.8	20	-0.05	+0.05	●	●	●	●	●		

It is not recommended to use this for KIGM-V Internal Grooving Toolholders which require GMM...V type inserts with the 18° front relief angle, because the relief angle of the insert used for GMM4020-04 toolholder is 10°.

Recommended cutting conditions  G143

● : Standard item R : Right-hand only L : Left-hand only □ : Check availability

External dia. of the groove DAXN / DAXX

External dia. of the groove within DAXN ~ DAXX are the available range for the initial grooving on the unprocessed workpiece (Ref. to Fig. 1)

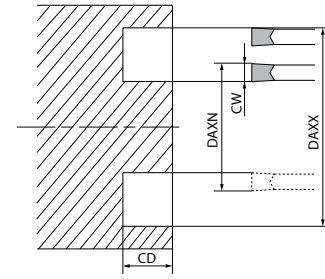
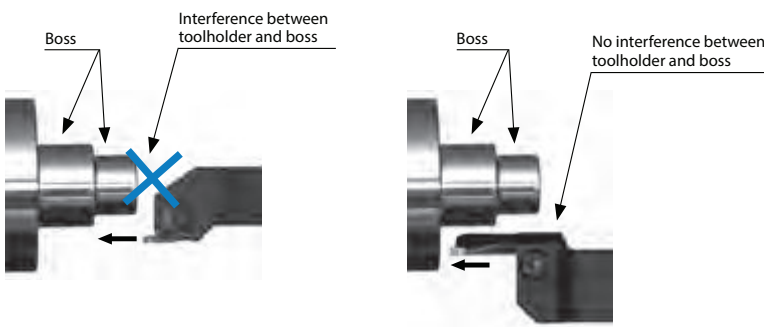

Fig.1

Caution for face grooving

1. When face grooving, the suitable toolholder depends on the length of the boss



2. Selection of face grooving toolholder

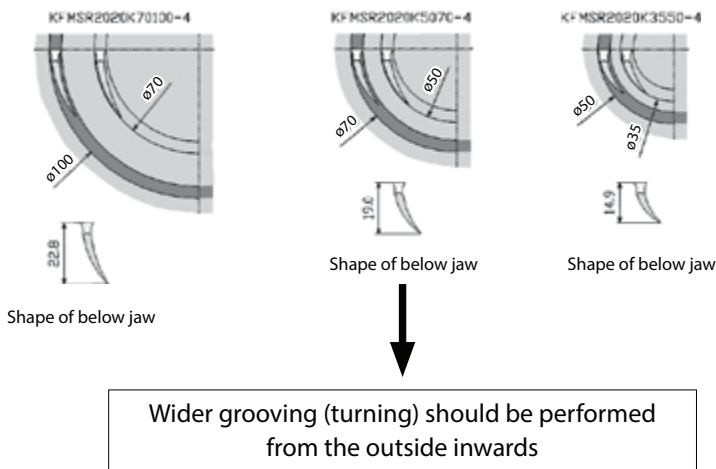

3. Interference of face grooving toolholder

e.g.) KFMSR2525M70100-4

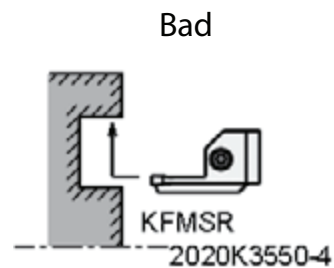
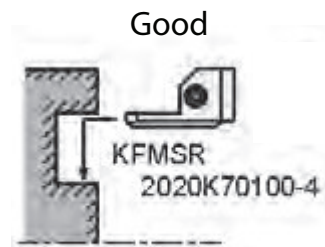
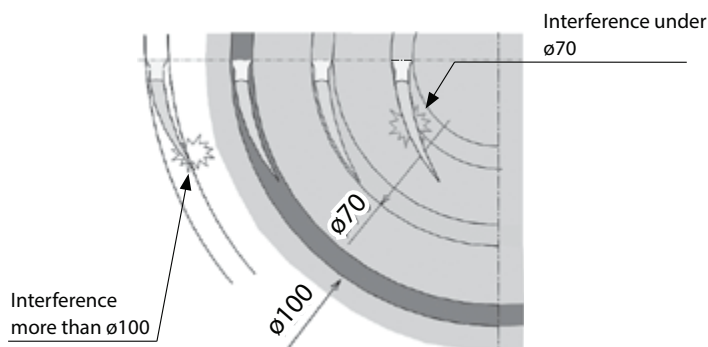

Example of usage for the face grooving toolholder

When face grooving, KFMSR2525M70100-4 should be between $\varnothing 70 \sim \varnothing 100$ for grooving the outer diameter at first. If the workpiece is machined at a diameter $\varnothing 100$ or $\varnothing 70$, the jaw of toolholder interferes with the workpiece.

Small diameter face grooving $\phi 6\sim$

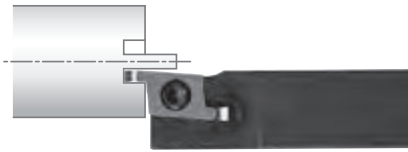

Type	STW
External dia. of the groove (min.)	$\phi 6$
Edge width (mm)	0.5~2.0
Grooving depth (mm)	1.0~3.0
See Page	G106

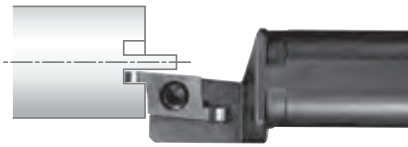
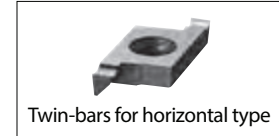

Type	S.-STW
External dia. of the groove (min.)	$\phi 6$
Edge width (mm)	0.5~2.0
Grooving depth (mm)	1.0~3.0
See Page	G107

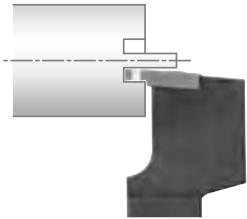

Type	STWS
External dia. of the groove (min.)	$\phi 6$
Edge width (mm)	0.5~2.0
Grooving depth (mm)	1.0~3.0
See Page	G109

G

Grooving

Small diameter face grooving $\phi 8\sim$

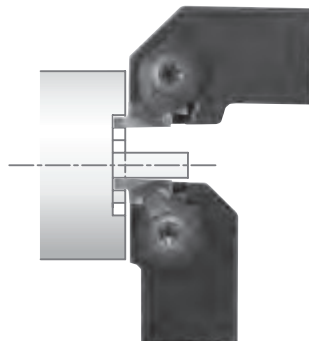

Type	GFVS-AA
External dia. of the groove (min.)	$\phi 8$
Edge width (mm)	1.0~3.0
Grooving depth (mm)	2.2
See Page	G125



Type	GFVT-AA
External dia. of the groove (min.)	$\phi 8$
Edge width (mm)	1.0~3.0
Grooving depth (mm)	2.2
See Page	G125

Small diameter face grooving $\phi 5\sim, \phi 8\sim$

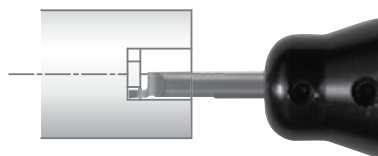

Type	EZFG
External dia. of the groove (min.)	$\phi 5, \phi 6, \phi 8$
Edge width (mm)	1.0~3.0
Grooving depth (mm)	1.5~3.0
See Page	G103

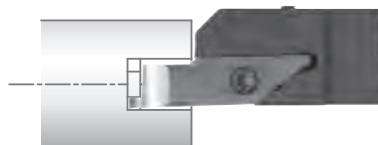
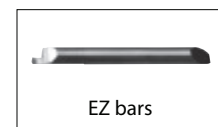

Type	VNFG
External dia. of the groove (min.)	$\phi 8$
Edge width (mm)	1.0~3.0
Grooving depth (mm)	2.0~3.0
See Page	G105

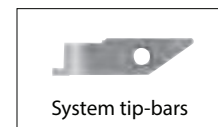

Face grooving $\phi 20\sim$

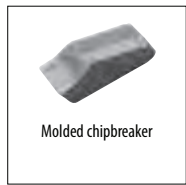

Type	KFTB
External dia. of the groove (min.)	$\phi 65\sim\phi 250$
Edge width (mm)	4.0~5.0
Grooving depth (mm)	25~38
See Page	G140

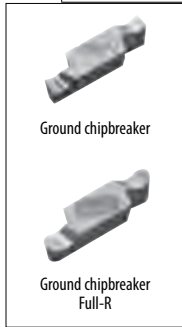

Type	GFV
External dia. of the groove (min.)	$\phi 20\sim\phi 150$
Edge width (mm)	2.0~6.0
Grooving depth (mm)	2.2~8.1
See Page	G127

Type	GFVS
External dia. of the groove (min.)	$\phi 35\sim\phi 150$
Edge width (mm)	2.5~6.0
Grooving depth (mm)	4.6~8.1
See Page	G129

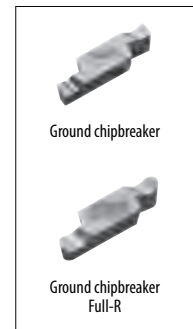
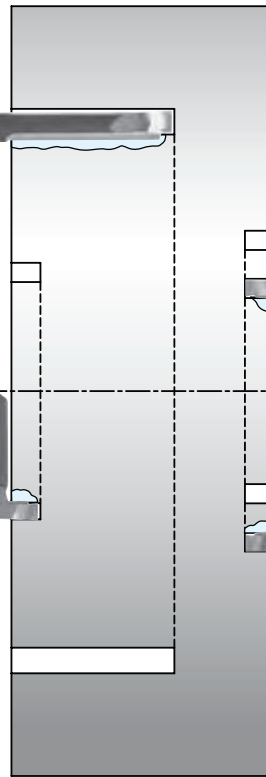

Type	GFVT
External dia. of the groove (min.)	$\phi 35\sim\phi 150$
Edge width (mm)	2.5~6.0
Grooving depth (mm)	4.6~8.1
See Page	G130

KGDF face grooving $\phi 25\sim$

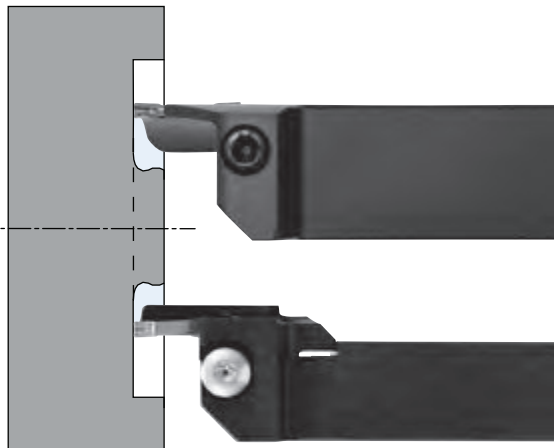

Type	KGDF-Z
External dia. of the groove (min.)	$\phi 50$
Edge width (mm)	3.0~5.0
Grooving depth (mm)	15
See Page	G118

Type	*KGDF
External dia. of the groove (min.)	$\phi 25$
Edge width (mm)	2.0~6.0
Grooving depth (mm)	6~32
See Page	G114~G117

* The separate type toolholders can accept all the blades if their hand is matching.

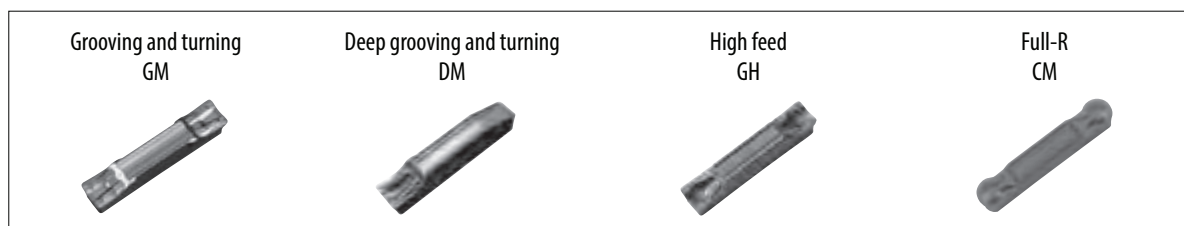

Face grooving & turning $\phi 25\sim$

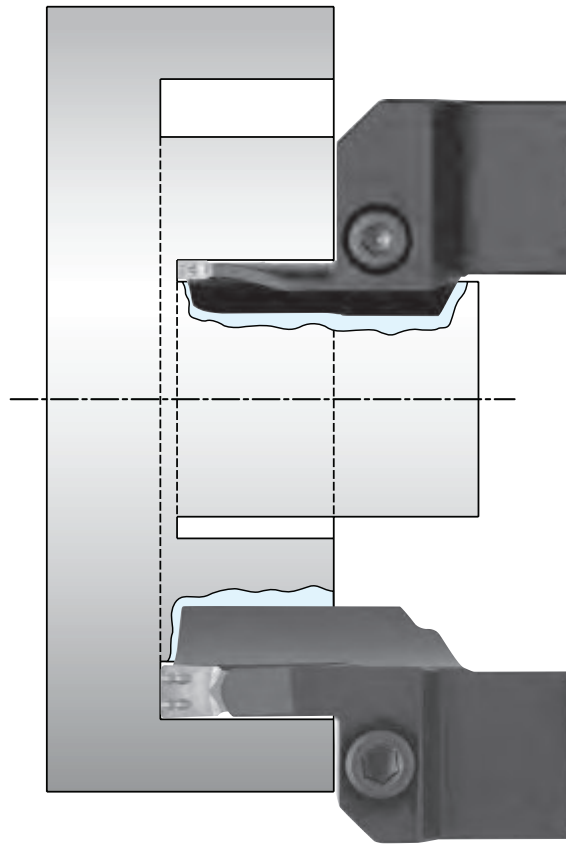

Type	KFMS
External dia. of the groove (min.)	$\phi 25\sim\phi 235$
Edge width (mm)	3.0~6.0
Grooving depth (mm)	13~32
See Page	G135

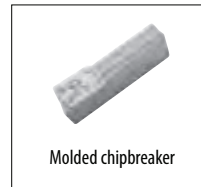

Molded chipbreaker

Type	KFMS-8
External dia. of the groove (min.)	$\phi 54\sim\phi 155$
Edge width (mm)	8.0
Grooving depth (mm)	25
See Page	G138

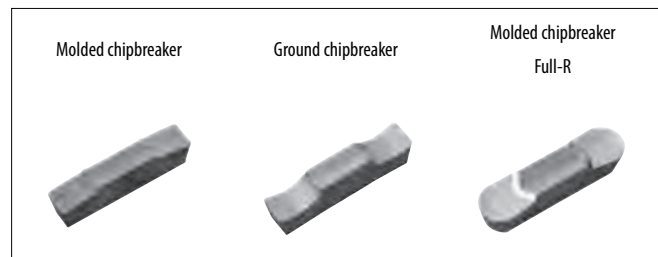

Molded chipbreaker

Ground chipbreaker

Molded chipbreaker
Full-R

Face grooving $\phi 35\sim$

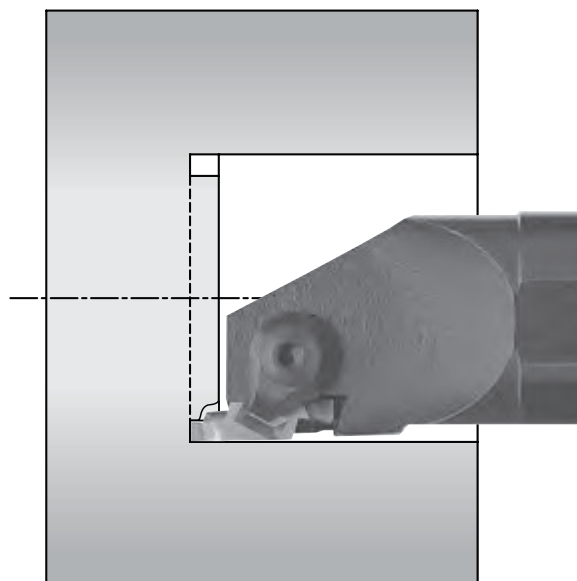

Type	GIFV
External dia. of the groove (min.)	$\phi 35\sim\phi 50$
Edge width (mm)	2.0~6.0
Grooving depth (mm)	2.2~8.1
See Page	G133

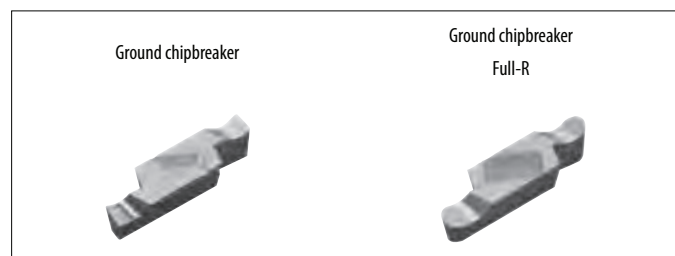

Ground chipbreaker

Ground chipbreaker
Full-R

EZFG (Internal grooving / Face grooving)

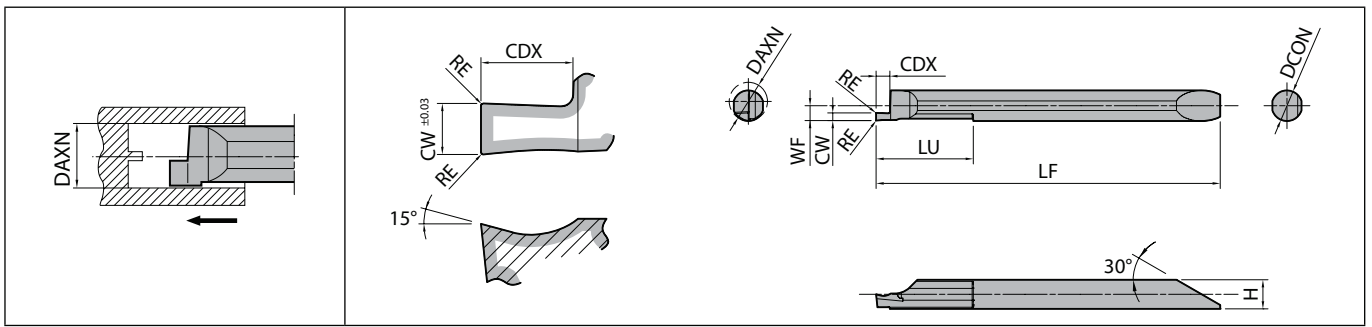

Right-hand shown

Dimensions

Description	No. of edges	External dia. of the groove (mm)	Dimension (mm)									Tolerance (mm)				Carbide			Applicable sleeve F38~F43		
			DAXN (min.)	CW	CDX	RE	DCON	H	LF	LU	WF	CW min.	CW max.	RE min.	RE max.	PVD		-			
																PR1225				GW05	
																R	L			R	
EZFG ^{R/L} 050040-100 050040-150	1	5	1 1.5	1.5 2	0.05	4	3.8	45	12	1.9	-0.03	+0.03	-0.013	+0.013	●	●	●	EZH040...			
EZFG ^{R/L} 060050-100 060050-150 060050-200	1	6	1 1.5 2	1.5 2.5 3	0.05	5	4.8	53.2	15	2.4	-0.03	+0.03	-0.013	+0.013	●	●	●	EZH050...			
EZFG ^{R/L} 080070-100 080070-150 080070-200 080070-300	1	8	1 1.5 2 3	2 2.5 3 3	0.05	7	6.8	64.2	25	3.4	-0.03	+0.03	-0.013	+0.013	●	●	●	EZH070...			

CDX shows available grooving depth.

Recommended cutting conditions **G104**

EZ Bars Identification System

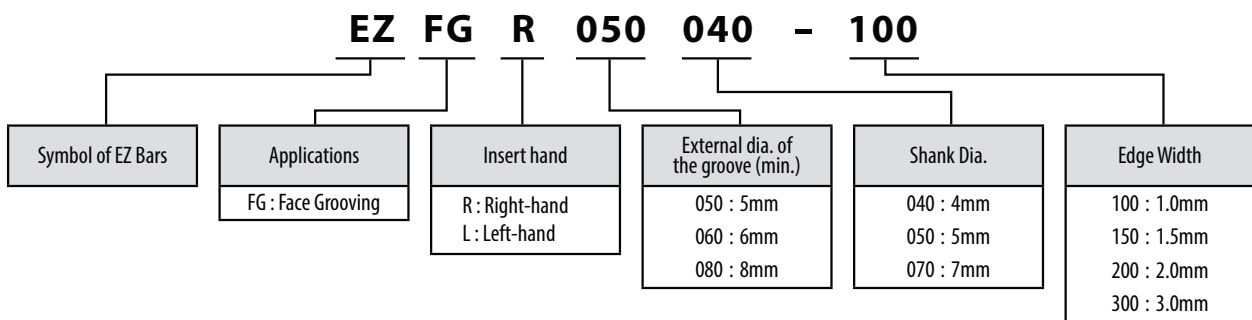

● : Standard item R : Right-hand only L : Left-hand only □ : Check availability

EZ bars are sold in 1 piece boxes



Applicable sleeves

Sleeve				Applicable insert for internal face grooving		Applicable machine manufacturer
EZH-CT (Adjustable overhang length with coolant hole) F39	EZH-HP (Adjustable overhang length) F41	EZH-ST F43	Sleeve shank dia.	EZFG	Shank dia.	
			DCON(mm)		DCON(mm)	
-	-	EZH 04012ST-80 05012ST-80 07012ST-80	12	EZFG ⁹⁰ /L 050040-... EZFG ⁹⁰ /L 060050-... EZFG ⁹⁰ /L 080070-...	4 5 7	(General purpose)
-	EZH 04016HP-100 05016HP-100 07016HP-100	EZH 04016ST-100 05016ST-100 07016ST-100	16	EZFG ⁹⁰ /L 050040-... EZFG ⁹⁰ /L 060050-... EZFG ⁹⁰ /L 080070-...	4 5 7	(General purpose)
EZH 04019CT-120 05019CT-120 07019CT-120	EZH 04019HP-120 05019HP-120 07019HP-120	EZH 04019ST-120 05019ST-120 07019ST-120	19.05	EZFG ⁹⁰ /L 050040-... EZFG ⁹⁰ /L 060050-... EZFG ⁹⁰ /L 080070-...	4 5 7	Citizen Machinery
EZH 04020CT-120 05020CT-120 07020CT-120	EZH 04020HP-120 05020HP-120 07020HP-120	EZH 04020ST-120 05020ST-120 07020ST-120	20	EZFG ⁹⁰ /L 050040-... EZFG ⁹⁰ /L 060050-... EZFG ⁹⁰ /L 080070-...	4 5 7	Eguro Tsugami Citizen Machinery (General purpose)
EZH 04022CT-135 05022CT-135 07022CT-135	EZH 04022HP-135 05022HP-135 07022HP-135	EZH 04022ST-135 05022ST-135 07022ST-135	22	EZFG ⁹⁰ /L 050040-... EZFG ⁹⁰ /L 060050-... EZFG ⁹⁰ /L 080070-...	4 5 7	Star Micronics Nomura DS Tsugami
EZH 04025.0CT-135 05025.0CT-135 07025.0CT-135	EZH 04025.0HP-135 05025.0HP-135 07025.0HP-135	EZH 04025.0ST-135 05025.0ST-135 07025.0ST-135	25	EZFG ⁹⁰ /L 050040-... EZFG ⁹⁰ /L 060050-... EZFG ⁹⁰ /L 080070-...	4 5 7	Eguro Tsugami Citizen Machinery (General purpose)
EZH 04025.4CT-120 05025.4CT-120 07025.4CT-120	EZH 04025.4HP-120 05025.4HP-120 07025.4HP-120	EZH 04025.4ST-120 05025.4ST-120 07025.4ST-120	25.4	EZFG ⁹⁰ /L 050040-... EZFG ⁹⁰ /L 060050-... EZFG ⁹⁰ /L 080070-...	4 5 7	Citizen Machinery

- Choose sleeves (DCB) to meet with DCON dimension of Face Grooving Inserts.
- Adjustment Pin cannot be installed to EZH-ST sleeves. To adjust overhang of the bar, please use EZH-CT / HP sleeves.
- Machine manufacturers in random order

Recommended cutting conditions

Workpiece material	Insert grades		EZFG ⁹⁰ /L 050040-100 EZFG ⁹⁰ /L 060050-100 EZFG ⁹⁰ /L 080070-100	EZFG ⁹⁰ /L 050040-150 EZFG ⁹⁰ /L 060050-150 EZFG ⁹⁰ /L 080070-150	EZFG ⁹⁰ /L 060050-200 EZFG ⁹⁰ /L 080070-200	EZFG ⁹⁰ /L 080070-300	Remarks
	MEGACOAT	Carbide					
	PR1225	GW05	f (mm/rev)				
Carbon steel / Alloy steel	★ 30~100	-	~0.02	~0.03	~0.04	~0.05	Coolant
Stainless steel	★ 30~80	-	~0.01	~0.02	~0.02	~0.03	
Non-ferrous metals	-	★ ~300	~0.03	~0.05	~0.06	~0.08	

★ : 1st recommendation



VNFG

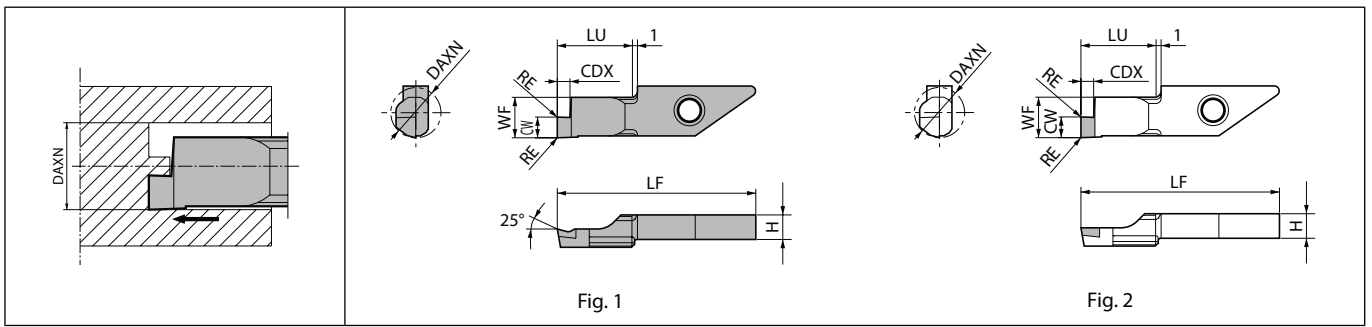

Right-hand shown

Dimensions

Description	No. of edges	External dia. of the groove (mm)		Dimension (mm)								Tolerance (mm)		Fig.	Carbide			PCD	Applicable toolholder F48~F51
		DAXN (min.)	DAXX (max.)	CW	CDX	RE	H	LF	LU	WF	CW min.	CW max.	PVD						
													PR1225		PR930	KW10	KPD001		
VNFGR 0810-10 0820-10 0830-10	1	8 (0)	∞ (∞)	1	2	0.05	3.9	29.6	10	7.3	-0.03	+0.03	1	●	●	●		SVNR...-12N S...-SVNR12N S...-SVNR12SN	
VNFGR 0820-10NB 0830-10NB	1			2	3									2	3	2	3		2

CDX shows available grooving depth.

External dia. of the groove DAXN (0) means that you can make the initial groove within DAXN ~ DAXX and then widen it to the center.

Recommended cutting conditions

Workpiece material	Recommended insert grades (Vc: m/min)			VNFG0810	VNFG0820	VNFG0830	Remarks
	MEGACOAT	PVD Coated Carbide	Carbide				
	PR1225	PR930	KW10				
Carbon steel / Alloy steel	★ 30~100	☆ 30~100		~0.02	~0.04	~0.05	Coolant
Stainless steel	★ 30~100	☆ 30~80		~0.01	~0.02	~0.03	
Non-ferrous metals			★ ~300	~0.04	~0.06	~0.08	

★:1st recommendation ☆:2nd recommendation

CBN & PCD Inserts are sold in 1 piece boxes

System tip-bars are sold in 5 piece boxes

● : Standard item R : Right-hand only L : Left-hand only □ : Check availability MTO : Made to order



TWFG (Horizontal type)

Insert		Description		External dia. of the groove (mm)		Dimension (mm)			Tolerance (mm)		Angle (°)	Carbide			Applicable toolholder G106 G107
				DAXN (min.)	DAXX (max.)	CW	CDX	RE	CW min.	CW max.	RA	PVD	-		
												Carbon steel / Alloy steel			P
												Stainless steel			M
												Cast iron			K
												Non-ferrous metals			N
												Titanium alloy			S
												Hard materials (~ 40HRC)			H
												Hard materials (40HRC ~)			
	TWFG L 050	2	6 (0)	∞ (∞)	0.5	1	0.05	-0.03	+0.03	1.5	●	●	Applicable inserts: STWL.....-15 S...-STWL15		
	080				0.8	1.5					●	●			
	100				1	2.2					●	●			
	125				1.25	2.2					●	●			
	150				1.5	2.2					●	●			
	180				1.8	3					●	●			
	200				2	3					●	●			

CDX shows available grooving depth.

External dia. of the groove DAXN (0) means that you can make the initial groove within DAXN ~ DAXX and then widen it to the center.

Left-hand shown

Recommended cutting conditions **G109**

Grooving

STW (Face grooving, Square shank for horizontal type insert)

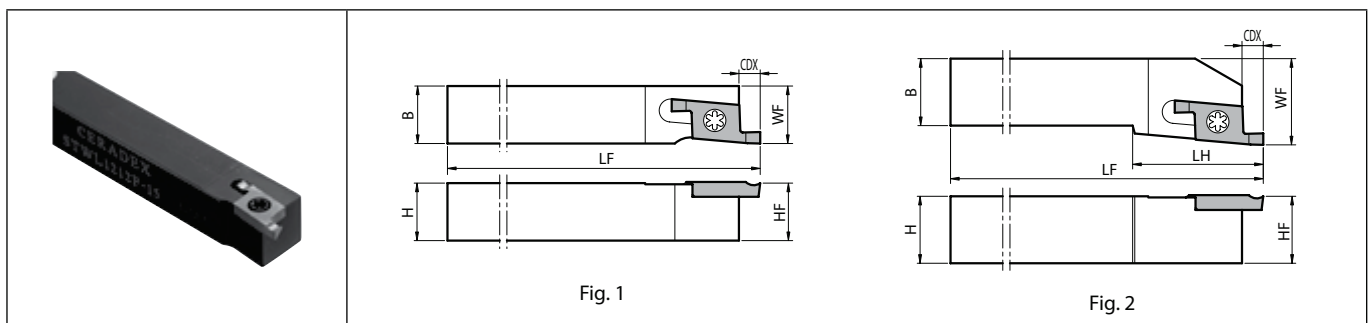

Left-hand shown | Left-hand Insert for Left-hand Toolholder. | (For right-hand toolholder for boring, See page F56.)

Toolholder dimensions

Description	Availability	Dimension (mm)							Fig.	Spare parts		Applicable inserts G106	
		L	CDX	H	B	LH	HF	LF		WF	Screw		Wrench
STWL 1010F-15	●	3	10	10	-	10	10	1	SB-3080TR	LTW-10S	TWFG L...		
1212F-15	●					85							
1212K-15	●					12						12	12
1616K-15	●					16						16	16
STWL 2020K-15	●	3	20	20	25	20	25	2	SB-3080TR	LTW-10S	TWFG L...		
2525M-15	●					25						25	25

CDX shows the distance from the toolholder to the cutting edge. Available Groove Depth : „CDX“ of Insert.

● : Standard item R : Right-hand only L : Left-hand only □ : Check availability

G106

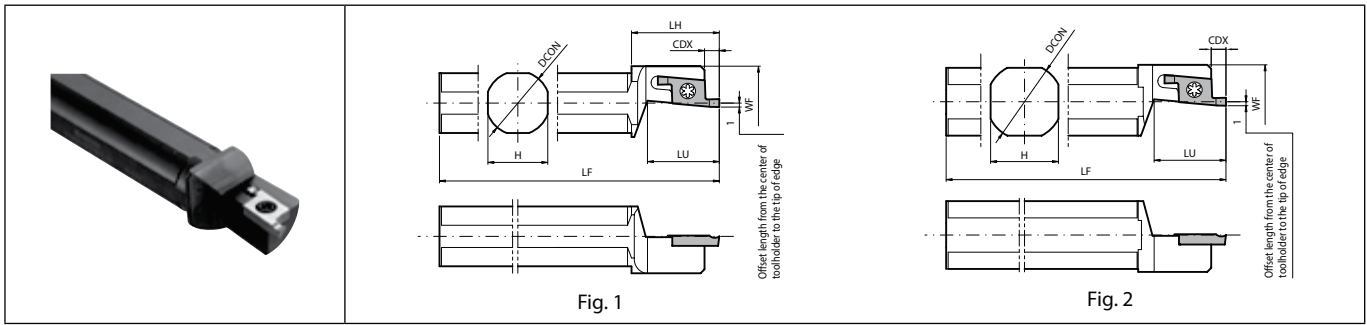

Twin-bars are sold in 5 piece boxes

STW (Face grooving, Round shank for horizontal type insert)



Left-hand shown | Left-hand Insert for Left-hand Toolholder. | (For right-hand toolholder for boring, See page F57.)

Toolholder dimensions

Description	Availability	Dimension (mm)								Coolant hole	Fig.	Spare parts		Applicable inserts ➔ G106
		L	DCON	CDX	H	LH	LF	LU	WF			Screw	Wrench	
														
S12F- STWL15	●	12	3	11	22	80	18	20	No	1	SB-3080TR	LTW-10S	TWFG...	
S14H- STWL15	●	14		13		100								
S15F- STWL15	●	15.875		15		85								
S16F- STWL15	●	16	3	17	-	90	18	18.5	No	2	SB-3080TR	LTW-10S	TWFG...	
S19G- STWL15	●	19.05		17		120								
S19K- STWL15	●	19.05		18		90								
S20G- STWL15	●	20	3	18	-	120	19.5	19.5	No	2	SB-3080TR	LTW-10S	TWFG...	
S20K- STWL15	●	20		20		125								
S22K- STWL15	●	22		20		125								
S25.0J- STWL15	●	25	3	23	-	110	22	24.5	No	2	SB-3080TR	LTW-10S	TWFG...	
S25K- STWL15	●	25.4		23		120								25

CDX shows the distance from the toolholder to the cutting edge. Available Groove Depth : „CDX“ of Insert.



● : Standard item R : Right-hand only L : Left-hand only □ : Check availability

TWFGT

Insert		Description		No. of edges	External dia. of the groove (mm)			Dimension (mm)			Tolerance (mm)		Angle (°)	Carbide			Applicable toolholder G109
					DAXN (min.)	DAXX (max.)		CW	CDX	RE	CW min.	CW max.		RA%	PVD	-	
		TWFGTR 050		2	6 (0)	∞ (∞)	0.5	1	0.05	-0.03	+0.03	1.5	●	●	●	●	
		080					0.8	1.5					●	●			
		100					1	2.2					●	●			
		125					1.25	2.2					●	●			
		150					1.5	2.2					●	●			
		180					1.8	3					●	●			
		200					2	3					●	●			
Recommended cutting conditions G109																	

CDX shows available grooving depth.
 External dia. of the groove DAXN (0) means that you can make the initial groove within DAXN ~ DAXX and then widen it to the center.
 Right-hand shown



Grooving

- External
- Internal
- Face

● : Standard item R : Right-hand only L : Left-hand only □ : Check availability

Twin-bars are sold in 5 piece boxes

G108

STWS (Face grooving)

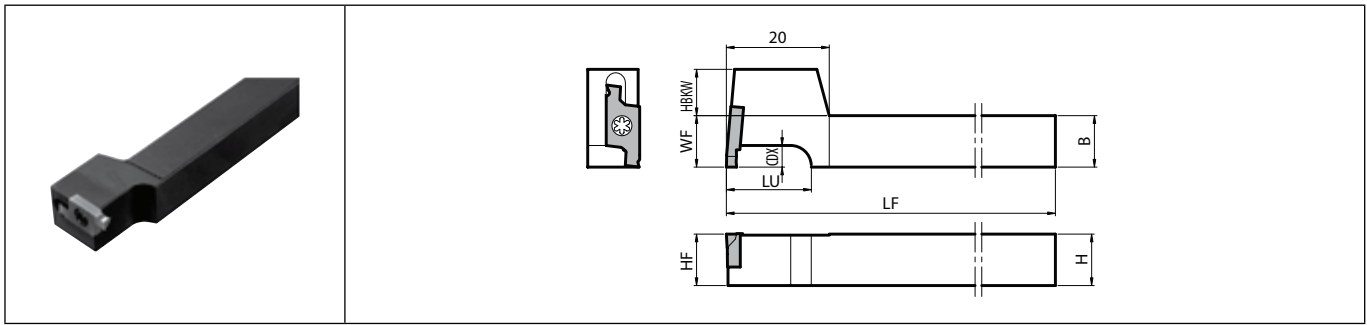

Right-hand shown

Toolholder dimensions

Description	Availability	Dimension (mm)									Spare parts		Applicable inserts G108
		R	H	B	LU	HF	HBKW	LF	CDX	WF	Screw	Wrench	
		STWSR	1010F-15T	●	10	10	16	10	9	85	3	10	
	1010JX-15T	●						120					
	1212F-15T	●	12	12		12	7	85		12			
	1212JX-15T	●						120					
	1616JX-15T	●	16	16	20	16	3			16			

CDX shows the distance from the toolholder to the cutting edge. Available Groove Depth : „CDX“ of Insert.

Recommended cutting conditions TWFG / TWFGT

Workpiece material	Recommended insert grades (Vc:m/min)			TWFGLO50	TWFGLO80	TWFGLO100	TWFGLO125	TWFGLO150	TWFGLO180	Remarks	
	MEGACOAT	PVD coated carbide	Carbide	TWFGTR050	TWFGTR080	TWFGTR100	TWFGTR125	TWFGTR150	TWFGTR180		TWFGTR200
	PR1535	PR1025	KW10	f (mm/rev)							
Carbon steel / Alloy steel	★ 30~100	☆ 30~100	-	~0.02	~0.03	~0.04				Coolant	
Stainless steel	★ 30~80	☆ 30~80	-	~0.01	~0.02	~0.02					
Non-ferrous metals	-	-	★ ~300	~0.03	~0.04	~0.06					

★ :1st recommendation ☆ :2nd recommendation

● : Standard item R : Right-hand only L : Left-hand only □ : Check availability



KGDF: Face grooving

Separate type toolholder (toolholder + blade) and Integral type toolholder are available.
Adaptable to a wide range of face grooving applications by changing blades

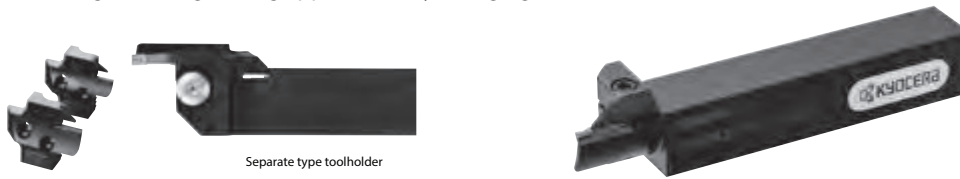

Insert clamping system "W grip"

Unique "W Grip" (insert anti-slip structure) provides stable machining quality

1. Prevents abnormal machining surface and / or insert breakage resulting from slip of insert.
2. Improves repetitive installation accuracy of insert (GDFM and GDFMS inserts are not applicable to KGD external grooving, cut-off and KGDI internal grooving toolholders.)

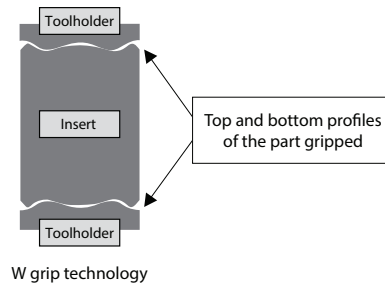

G



Grooving

Smooth chip control

For general purpose GM chipbreaker, for high feed grooving GH chipbreaker, for deep grooving DM chipbreaker

Advantages of chipbreaker

GM: General purpose	GH: High feed grooving	DM: Deep grooving
<p>Smooth surface from cutting edge to the far side: Enhances breaking of chips and maintains their evacuation direction constant.</p> <p>Gradually raised surface: Keeps curling of chips in constant shape.</p> <p>Flat cutting edge line: Improves chip control.</p> <p>Steep surface near the cutting edge: Good chip control during shoulder grooving.</p>	<p>Concave part in middle: Control chips upward.</p> <p>Dots jutt out center side: Changes chip shape smoothly. Stable chip control during shoulder grooving.</p> <p>Slope portion: Constantly curled chips.</p> <p>Negative cutting edge line: Improvement of strong edge.</p> <p>Curved lead edge: Keeps chips in constant shape.</p>	<p>Concave part in middle: Enhances breaking of chips.</p> <p>Inflated inner surface: Enhances breaking of chips and maintains their evacuation direction constant.</p> <p>Smooth surface up to the far side standing wall: Reduces cutting force, enhances breaking of chips and maintains their evacuation in constant direction.</p>

Chip control of GM chipbreaker

Face grooving ($\phi 62$)

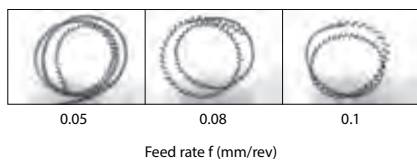

Side grooving

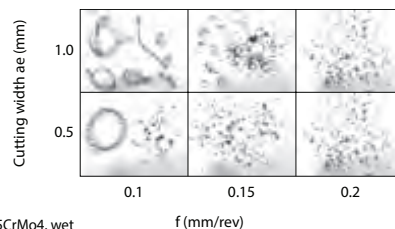

Turning

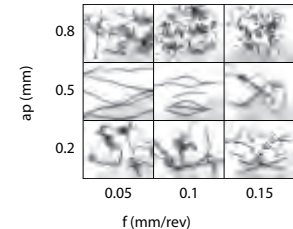

Cutting conditions: $V_c = 150$ m/min, $f = 0.05 \sim 0.2$ mm/rev, GDFM5020N-040GM, 15CrMo4, wet

GDFM/GDMFS

		Carbon steel / Alloy steel		Stainless steel		Cast iron		Non-ferrous metals		Titanium alloy		Hard materials (~ 40HRC)		Hard materials (40HRC ~)		P		M		K		N		S		H			
Insert	Description	No. of edges	Dimension (mm)				Tolerance (mm)		Carbide			Cermet		Applicable toolholder G114 ~ G120															
			CW	S	RE	INSL	CW min.	CW max.	PVD			-																	
									PR1715	PR1725	GW15	TiN60	TiN90																
	GDFM 2020N-020GM	2	2	3.9	0.2	21	-0.03	+0.03	●	●	●	●	●	●	●	●	●	●	●	●	●	●	●	●	●	●	●	KGDF [®] /L...-2...	
	GDFM 3020N-030GM	2	3	4.3	0.3	20	-0.03	+0.03	●	●	●	●	●	●	●	●	●	●	●	●	●	●	●	●	●	●	●	KGDF [®] /L...-3...	
	GDFM 4020N-040GM	2	4	4.5	0.4	20	-0.03	+0.03	●	●	●	●	●	●	●	●	●	●	●	●	●	●	●	●	●	●	●	KGDF [®] /L...-4...	
	GDFM 5020N-040GM 5020N-080GM	2	5	4.5	0.4 0.8	20	-0.04	+0.04	●	●	●	●	●	●	●	●	●	●	●	●	●	●	●	●	●	●	●	●	KGDF [®] /L...-5...
	GDFM 6020N-040GM 6020N-080GM	2	6	4.5	0.4 0.8	20	-0.04	+0.04	●	●	●	●	●	●	●	●	●	●	●	●	●	●	●	●	●	●	●	●	KGDF [®] /L...-6...
	GDFM 4020N-040GH	2	4	4.5	0.4	20	-0.03	+0.03	●	●	●	●	●	●	●	●	●	●	●	●	●	●	●	●	●	●	●	KGDF [®] /L...-4...	
	GDFM 5020N-040GH 5020N-080GH	2	5	4.5	0.4 0.8	20	-0.04	+0.04	●	●	●	●	●	●	●	●	●	●	●	●	●	●	●	●	●	●	●	KGDF [®] /L...-5...	
	GDFM 6020N-040GH 6020N-080GH	2	6	4.5	0.4 0.8	20	-0.04	+0.04	●	●	●	●	●	●	●	●	●	●	●	●	●	●	●	●	●	●	●	KGDF [®] /L...-6...	
	GDFM 3020N-030DM	2	3	4.3	0.3	20	-0.03	+0.03	●	●	●	●	●	●	●	●	●	●	●	●	●	●	●	●	●	●	●	KGDF [®] /L...-3...	
	GDFM 4020N-040DM	2	4	4.5	0.4	20	-0.03	+0.03	●	●	●	●	●	●	●	●	●	●	●	●	●	●	●	●	●	●	●	KGDF [®] /L...-4...	
	GDFM 5020N-040DM	2	5	4.5	0.4	20	-0.04	+0.04	●	●	●	●	●	●	●	●	●	●	●	●	●	●	●	●	●	●	●	KGDF [®] /L...-5...	
	GDFM 6020N-040DM	2	6	4.5	0.4	20	-0.04	+0.04	●	●	●	●	●	●	●	●	●	●	●	●	●	●	●	●	●	●	●	KGDF [®] /L...-6...	
	GDFMS 3020N-030DM	1	3	4.3	0.3	20	-0.03	+0.03	●	●	●	●	●	●	●	●	●	●	●	●	●	●	●	●	●	●	●	KGDF [®] /L...-3...	
	GDFMS 4020N-040DM	1	4	4.5	0.4	20	-0.03	+0.03	●	●	●	●	●	●	●	●	●	●	●	●	●	●	●	●	●	●	●	KGDF [®] /L...-4...	
	GDFMS 5020N-040DM	1	5	4.5	0.4	20	-0.04	+0.04	●	●	●	●	●	●	●	●	●	●	●	●	●	●	●	●	●	●	●	KGDF [®] /L...-5...	
	GDFMS 6020N-040DM	1	6	4.5	0.4	20	-0.04	+0.04	●	●	●	●	●	●	●	●	●	●	●	●	●	●	●	●	●	●	●	KGDF [®] /L...-6...	
	GDFG 3020N-020GS	2	3	4.3	0.2	20	-0.2	+0.2	●	●	●	●	●	●	●	●	●	●	●	●	●	●	●	●	●	●	●	KGDF [®] /L...-3...	
	GDFG 4020N-040GS	2	4	4.5	0.4	20	-0.2	+0.2	●	●	●	●	●	●	●	●	●	●	●	●	●	●	●	●	●	●	●	KGDF [®] /L...-4...	
	GDFG 5020N-040GS	2	5	4.5	0.4	20	-0.2	+0.2	●	●	●	●	●	●	●	●	●	●	●	●	●	●	●	●	●	●	●	KGDF [®] /L...-5...	
	GDFG 6020N-040GS	2	6	4.5	0.4	20	-0.2	+0.2	●	●	●	●	●	●	●	●	●	●	●	●	●	●	●	●	●	●	●	KGDF [®] /L...-6...	
	GDFM 3020N-150R-CM	2	3	4.3	1.5	20	-0.03	+0.03	●	●	●	●	●	●	●	●	●	●	●	●	●	●	●	●	●	●	●	KGDF [®] /L...-3...	
	GDFM 4020N-200R-CM	2	4	4.5	2	21	-0.03	+0.03	●	●	●	●	●	●	●	●	●	●	●	●	●	●	●	●	●	●	●	KGDF [®] /L...-4...	
	GDFM 5020N-250R-CM	2	5	4.5	2.5	21	-0.04	+0.04	●	●	●	●	●	●	●	●	●	●	●	●	●	●	●	●	●	●	●	KGDF [®] /L...-5...	
	GDFM 6020N-300R-CM	2	6	4.5	3	22	-0.04	+0.04	●	●	●	●	●	●	●	●	●	●	●	●	●	●	●	●	●	●	●	KGDF [®] /L...-6...	

GDFM40/50/60-CM differs from other descriptions in length (INSL) to avoid interference of a toolholder with workpiece.

Recommended cutting conditions G122

Inserts identification system

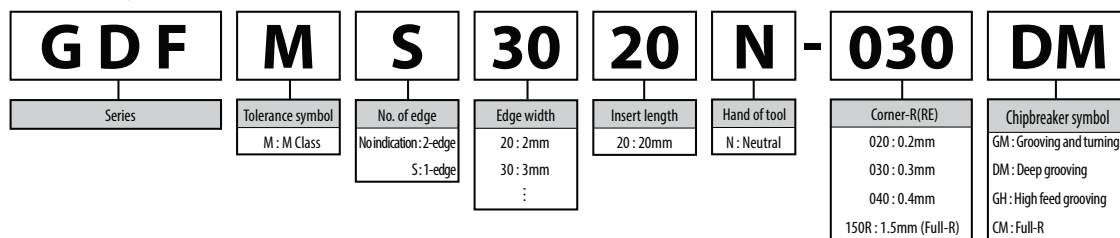



●: Standard item R: Right-hand only L: Left-hand only □: Check availability

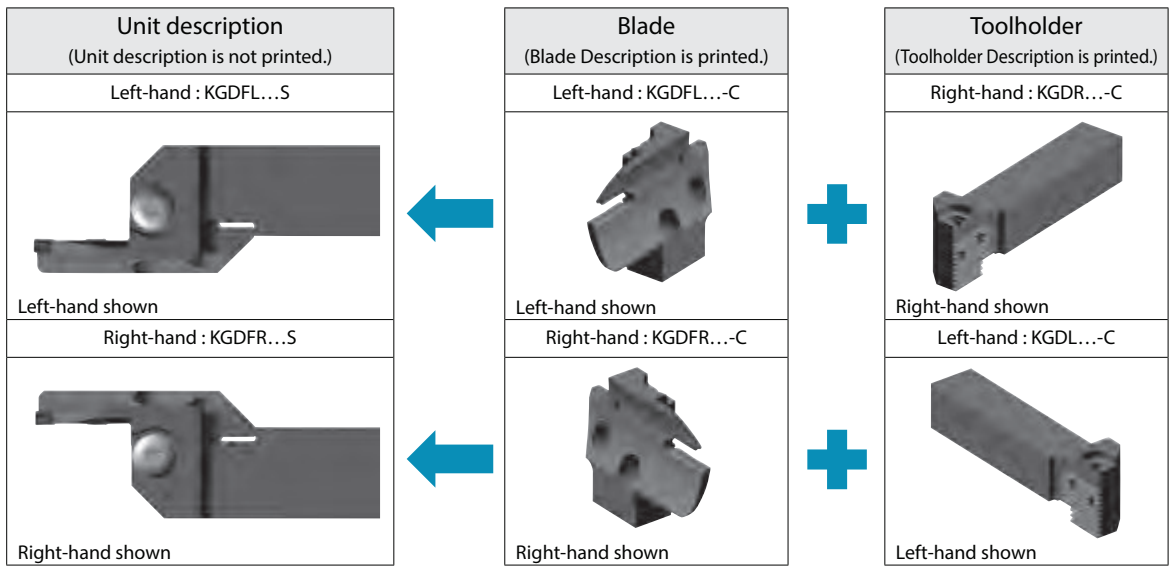

KGDF: Toolholder assembly identification

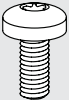

- Right-hand blade for left-hand toolholder, left-hand blade for right-hand toolholder.
- The unit description is not printed on the product. It is printed on the box label.
- Combination of the toolholder and blade (both separately sold) can make up the corresponding assembly.
- The insert clamping screw (BH6X10TR), blade fixing screw (SB-60120TR) and wrench (LTW-25) which are included in the toolholder can be used.

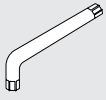
Clamp Bolt (for Insert Clamp)	Clamp Screw (for Blade)	Wrench
		
BH6X10TR	SB-60120TR	LTW-25

G



Grooving

- External
- Internal
- Face

External dia. of the groove DAXN / DAXX

External dia. of the groove within DAXN ~ DAXX are the available range for the initial grooving on the unprocessed workpiece (Ref. to Fig. 1). Then, you can widen it up to the center towards the inside (excluding the models listed in the right table) and towards the outside according to machine limits.

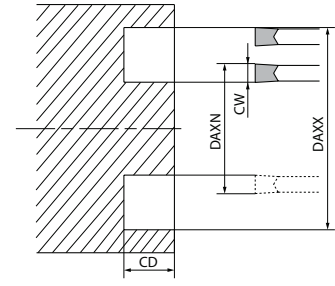
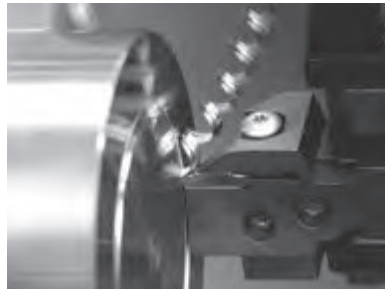

Fig. 1

Limit of Turning toward Center

Turning towards the Center causes the toolholder to interfere with the groove wall depending on the initial cut's diameter.

Description	DMIN2	25	26	27	28 and over
	ød (mm)				
KGDF ⁹⁰ /L-25-3A-C + KGD ¹ /h2020-C	Interference	4	2	0	0 (No remaining Boss)
KGDF ⁹⁰ /L-25-3A-C + KGD ¹ /h2525-C					
KGDF ⁹⁰ /L-25-4A-C + KGD ¹ /h2020-C					
KGDF ⁹⁰ /L-25-4A-C + KGD ¹ /h2525-C					
KGDF ⁹⁰ /L-25-5B-C + KGD ¹ /h2020-C					
KGDF ⁹⁰ /L-25-5B-C + KGD ¹ /h2525-C					
KGDF ⁹⁰ /L-25-6B-C + KGD ¹ /h2020-C	9	4	1	1	0 (No remaining Boss)
KGDF ⁹⁰ /L-25-6B-C + KGD ¹ /h2525-C					

e.g.)

Toolholder assembled from KGDFR-25-3A-C and KGDL2020-C with ø25 as first cut towards the center, it will cause a rubbing with the toolholder cartridge if ød is 4.0mm.



Grooving

KGDF (Face grooving / 0° separate type)

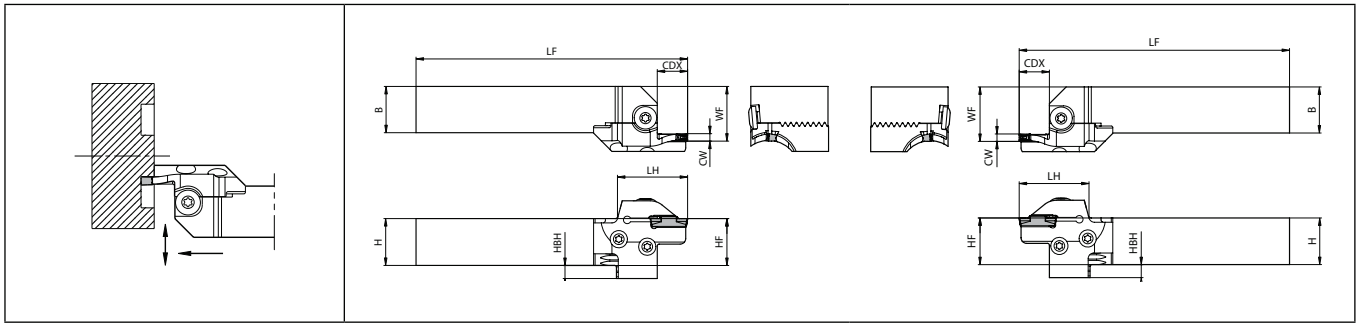

Right-hand shown
(Right-hand blade and left-hand toolholder)

Left-hand shown
(Left-hand blade and right-hand toolholder)

Toolholder dimensions (Blade and toolholder)

Shank angle	Cutting width CW (mm)	Shank size (mm)	Max. depth of cut CDX (mm)	External dia. of the groove (mm)		Blade description G121	Toolholder description G43	Dimension (mm)							
				DAXX (min.)	DAXX (max.)			H	B	LH	HF	HBH	LF	WF	
0°	20	6	6	25	30	KGDFR -25-2A-C	KGDL2020-C	20	20	33	20	12	115		
				30	35									-30-2A-C	
				35	45									-35-2A-C	
				45	60									-45-2A-C	
				60	80									-60-2A-C	
				80	100									-80-2A-C	
		100	130	-100-2A-C											
		13	15	6	6	25		30	KGDFR -25-2B-C						
						30		35		-30-2B-C					
						35		45		-35-2B-C					
						45		60		-45-2B-C					
						60		80		-60-2B-C					
	80					100	-80-2B-C								
	100	130	-100-2B-C												
	25	6	6	6	25	30	KGDFR -25-2A-C	KGDL2525-C	25	25	33	25	7	140	
					30	35									-30-2A-C
					35	45									-35-2A-C
					45	60									-45-2A-C
					60	80									-60-2A-C
					80	100									-80-2A-C
		100	130	-100-2A-C											
		13	15	6	6	25	30		KGDFR -25-2B-C						
						30	35			-30-2B-C					
						35	45			-35-2B-C					
45						60	-45-2B-C								
60						80	-60-2B-C								
80	100					-80-2B-C									
100	130	-100-2B-C													
32	6	6	6	25	30	KGDFR -25-2A-C	KGDL3232-C	32	32	33	32	-	160		
				30	35									-30-2A-C	
				35	45									-35-2A-C	
				45	60									-45-2A-C	
				60	80									-60-2A-C	
				80	100									-80-2A-C	
	100	130	-100-2A-C												
	13	15	6	6	25	30		KGDFR -25-2B-C							
					30	35			-30-2B-C						
					35	45			-35-2B-C						
					45	60			-45-2B-C						
					60	80			-60-2B-C						
80					100	-80-2B-C									
100	130	-100-2B-C													

1. KGDF: Right-hand blade for left-hand toolholder, left-hand blade for right-hand toolholder.
The toolholder is applicable for all blade with suitable hand.

Applicable inserts **G111**

2. CDX: Maximum depth to which processing can be made. (If the CDX is 20 mm or more, the maximum groove-depth of groove made by the 2-edge insert will be 18 mm.)
Above toolholders are applicable to Cut-off, too.

3. The insert clamping Screw (BH6X10TR), blade fixing Screw (SB-60120TR) and Wrench (LTW-25) which are included in the toolholder can be used.

Toolholder dimensions (Blade and toolholder)

Shank angle	Cutting width CW (mm)	Shank size (mm)	Max. depth of cut CDX (mm)	External dia. of the groove (mm)		Blade description G121	Toolholder description G43	Dimension (mm)						
				DAXX (min.)	DAXX (max.)			H	B	LH	HF	HBH	LF	WF
0°	3	□20	13	25	30	KGDF%: -25-3A-C	KGD ¹ / ₆ 2020-C	20	20	38	20	12	120	24.5
				30	40	KGDF%: -30-3A-C								
				40	50	KGDF%: -40-3A-C								
				50	65	KGDF%: -50-3B-C								
				65	85	KGDF%: -65-3B-C								
				85	110	KGDF%: -85-3B-C								
		110	145	KGDF%: -110-3B-C										
		22	50	KGDF%: -50-3C-C	KGD ¹ / ₆ 2525-C	25		25	38	25	7	145	29.5	
		65	85	KGDF%: -65-3C-C										
		85	110	KGDF%: -85-3C-C										
		110	145	KGDF%: -110-3C-C										
		25	85	KGDF%: -85-3C-C										
	110	145	KGDF%: -110-3C-C											
	13	25	KGDF%: -25-3A-C	KGD ¹ / ₆ 3232-C	32	32	38	32	-	165	36.5			
	30	40	KGDF%: -30-3A-C											
	40	50	KGDF%: -40-3A-C											
	50	65	KGDF%: -50-3B-C											
	65	85	KGDF%: -65-3B-C											
	85	110	KGDF%: -85-3B-C											
	110	145	KGDF%: -110-3B-C											
	22	50	KGDF%: -50-3C-C				KGD ¹ / ₆ 2020-C	20	20	38	20	12	120	24.5
	65	85	KGDF%: -65-3C-C											
	85	110	KGDF%: -85-3C-C											
	110	145	KGDF%: -110-3C-C											
25	85	KGDF%: -85-3C-C												
110	145	KGDF%: -110-3C-C												
13	25	KGDF%: -25-4A-C	KGD ¹ / ₆ 2525-C	25	25	38	25	7	145	29.5				
35	50	KGDF%: -35-4B-C												
50	70	KGDF%: -50-4B-C												
70	100	KGDF%: -70-4B-C												
100	150	KGDF%: -100-4B-C												
150	220	KGDF%: -150-4B-C												
220	∞	KGDF%: -220-4B-C												
25	35	KGDF%: -35-4C-C				KGD ¹ / ₆ 3232-C	32	32	48	-	175	36.5		
50	70	KGDF%: -50-4C-C												
70	100	KGDF%: -70-4C-C												
100	150	KGDF%: -100-4C-C												
150	220	KGDF%: -150-4C-C												
220	∞	KGDF%: -220-4C-C												
13	25	KGDF%: -25-4A-C	KGD ¹ / ₆ 2020-C	20	20	38	20	12	120	24.5				
35	50	KGDF%: -35-4B-C												
50	70	KGDF%: -50-4B-C												
70	100	KGDF%: -70-4B-C												
100	150	KGDF%: -100-4B-C												
150	220	KGDF%: -150-4B-C												
220	∞	KGDF%: -220-4B-C												
25	35	KGDF%: -35-4C-C				KGD ¹ / ₆ 2525-C	25	25	48	-	155	29.5		
50	70	KGDF%: -50-4C-C												
70	100	KGDF%: -70-4C-C												
100	150	KGDF%: -100-4C-C												
150	220	KGDF%: -150-4C-C												
220	∞	KGDF%: -220-4C-C												
13	25	KGDF%: -25-4A-C	KGD ¹ / ₆ 3232-C	32	32	48	-	175	36.5					
35	50	KGDF%: -35-4B-C												
50	70	KGDF%: -50-4B-C												
70	100	KGDF%: -70-4B-C												
100	150	KGDF%: -100-4B-C												
150	220	KGDF%: -150-4B-C												
220	∞	KGDF%: -220-4B-C												
25	35	KGDF%: -35-4C-C				KGD ¹ / ₆ 2020-C	20	20	36	-	163	29.5		
50	70	KGDF%: -50-4C-C												
70	100	KGDF%: -70-4C-C												
100	150	KGDF%: -100-4C-C												
150	220	KGDF%: -150-4C-C												
220	∞	KGDF%: -220-4C-C												

1. KGDF: Right-hand blade for left-hand toolholder, left-hand blade for right-hand toolholder.

The toolholder is applicable for all blade with suitable hand.

2. CDX: Maximum depth to which processing can be made. (If the CDX is 20 mm or more, the maximum groove-depth of groove made by the 2-edge insert will be 18 mm.)

Above toolholders are applicable to Cut-off, too.

3. The insert clamping Screw (BH6X10TR), blade fixing Screw (SB-60120TR) and Wrench (LTW-25) which are included in the toolholder can be used.

Applicable inserts G111



Toolholder dimensions (Blade and toolholder)

Shank angle	Cutting width CW (mm)	Shank size (mm)	Max. depth of cut CDX (mm)		Blade description ➔ G121	Toolholder description ➔ G43	Dimension (mm)																		
			DAXN (min.)	DAXX (max.)			H	B	LH	HF	HBH	LF	WF												
			External dia. of the groove (mm)																						
0°	5	□20	15	25	35	KGDF ^{F%} -25-5B-C	KGDF ^{F%} -25-5C-C	20	20	38	20	12	120												
				35	50									-35-5B-C											
				50	75									-50-5B-C											
				75	115									-75-5B-C											
				115	180									-115-5B-C											
				180	235									-180-5B-C											
			235	∞	-235-5B-C																				
			20	25	35	KGDF ^{F%} -25-5C-C								43	125										
				35	50									-35-5C-C											
				50	75									-50-5C-C											
				75	115									-75-5C-C											
				115	180									-115-5C-C											
				180	235									-180-5C-C											
			25	180	235	KGDF ^{F%} -180-5C-C								48	130										
				235	∞											-235-5C-C									
				75	115											KGDF ^{F%} -75-5D-C	55	137							
				115	180														-115-5D-C						
				180	235														-180-5D-C						
		32		235	∞					KGDF ^{F%} -235-5D-C			55			137									
			25	35	KGDF ^{F%} -25-5B-C	KGDF ^{F%} -25-5C-C								25	25				38	7	145				
			35	50																		-35-5B-C			
			50	75													-50-5B-C								
			75	115													-75-5B-C								
			115	180													-115-5B-C								
		180	235	-180-5B-C																					
		235	∞	-235-5B-C																					
		20	25	35	KGDF ^{F%} -25-5C-C					43			150												
			35	50						-35-5C-C															
			50	75						-50-5C-C															
			75	115						-75-5C-C															
			115	180						-115-5C-C															
			180	235						-180-5C-C															
		25	180	235	KGDF ^{F%} -180-5C-C					48			155												
			235	∞												-235-5C-C									
			75	115												KGDF ^{F%} -75-5D-C	55	162							
			115	180																		-115-5D-C			
			180	235																		-180-5D-C			
			32	235												∞			KGDF ^{F%} -235-5D-C		55	162			
		25		35	KGDF ^{F%} -25-5B-C					KGDF ^{F%} -25-5C-C			32			32							38	-	165
		35		50																					
		50		75													-50-5B-C								
		75		115													-75-5B-C								
		115		180													-115-5B-C								
		180	235	-180-5B-C																					
		235	∞	-235-5B-C																					
		20	25	35	KGDF ^{F%} -25-5C-C												43	170							
			35	50													-35-5C-C								
			50	75													-50-5C-C								
75	115		-75-5C-C																						
115	180		-115-5C-C																						
180	235		-180-5C-C																						
25	180	235	KGDF ^{F%} -180-5C-C	48	175																				
	235	∞					-235-5C-C																		
	75	115					KGDF ^{F%} -75-5D-C	55	182																
	115	180									-115-5D-C														
	180	235									-180-5D-C														
	32	235					∞				KGDF ^{F%} -235-5D-C	55					182								

1. KGDF: Right-hand blade for left-hand toolholder, left-hand blade for right-hand toolholder.

Applicable inserts ➔ G111

The toolholder is applicable for all blade with suitable hand.

2. CDX: Maximum depth to which processing can be made. (If the CDX is 20 mm or more, the maximum groove-depth of groove made by the 2-edge insert will be 18 mm.)

Above toolholders are applicable to Cut-off, too.

Toolholder dimensions (Blade and toolholder)

Shank angle	Cutting width CW (mm)	Shank size (mm)	Max. depth of cut CDX (mm)	External dia. of the groove (mm)		Blade description ➔ G121	Toolholder description ➔ G43	Dimension (mm)																	
				DAXN (min.)	DAXX (max.)			H	B	LH	HF	HBH	LF	WF											
0°	6	□20	15	25	35	KGDF ^{F/L} -25-6B-C	KGD ^{L/R} 2020-C	20	20	38	20	12	24.5												
				35	50	-35-6B-C																			
				50	75	-50-6B-C																			
				75	115	-75-6B-C																			
				115	180	-115-6B-C																			
				180	235	-180-6B-C																			
			235	∞	-235-6B-C																				
			20	25	35	KGDF ^{F/L} -25-6C-C				43				125											
				35	50	-35-6C-C																			
				50	75	-50-6C-C																			
				75	115	-75-6C-C																			
				115	180	-115-6C-C																			
				180	235	-180-6C-C																			
			25	235	∞	-235-6C-C				48				130											
				75	115	KGDF ^{F/L} -75-6D-C									55	137									
				115	180	-115-6D-C																			
				180	235	-180-6D-C																			
				235	∞	-235-6D-C																			
		32		25	35	KGDF ^{F/L} -25-6B-C											KGD ^{L/R} 2525-C	25	25	25	7	29.5			
			35	50	-35-6B-C																				
			50	75	-50-6B-C																				
			75	115	-75-6B-C																				
			115	180	-115-6B-C																				
			180	235	-180-6B-C																				
		235	∞	-235-6B-C																					
		20	25	35	KGDF ^{F/L} -25-6C-C	43				150															
			35	50	-35-6C-C																				
			50	75	-50-6C-C																				
			75	115	-75-6C-C																				
			115	180	-115-6C-C																				
			180	235	-180-6C-C																				
		25	235	∞	-235-6C-C	48				155															
			75	115	KGDF ^{F/L} -75-6D-C									55	162										
			115	180	-115-6D-C																				
			180	235	-180-6D-C																				
			235	∞	-235-6D-C																				
			32	25	35											KGDF ^{F/L} -25-6B-C							KGD ^{L/R} 3232-C	32	32
		35		50	-35-6B-C																				
		50		75	-50-6B-C																				
		75		115	-75-6B-C																				
		115		180	-115-6B-C																				
		180		235	-180-6B-C																				
		235	∞	-235-6B-C																					
		20	25	35	KGDF ^{F/L} -25-6C-C	43				170															
			35	50	-35-6C-C																				
			50	75	-50-6C-C																				
			75	115	-75-6C-C																				
			115	180	-115-6C-C																				
180	235		-180-6C-C																						
25	235	∞	-235-6C-C	48	175																				
	75	115	KGDF ^{F/L} -75-6D-C			55	182																		
	115	180	-115-6D-C																						
	180	235	-180-6D-C																						
	235	∞	-235-6D-C																						
	32	25	35					KGDF ^{F/L} -25-6B-C	KGD ^{L/R} 3232-C	32	32	32	-	36.5											
35		50	-35-6B-C																						
50		75	-50-6B-C																						
75		115	-75-6B-C																						
115		180	-115-6B-C																						
180		235	-180-6B-C																						
235	∞	-235-6B-C																							
20	25	35	KGDF ^{F/L} -25-6C-C	43	170																				
	35	50	-35-6C-C																						
	50	75	-50-6C-C																						
	75	115	-75-6C-C																						
	115	180	-115-6C-C																						
	180	235	-180-6C-C																						
25	235	∞	-235-6C-C	48	175																				
	75	115	KGDF ^{F/L} -75-6D-C			55	182																		
	115	180	-115-6D-C																						
	180	235	-180-6D-C																						
	235	∞	-235-6D-C																						
	32	25	35					KGDF ^{F/L} -25-6B-C							KGD ^{L/R} 3232-C	32	32	32	-	36.5					
35		50	-35-6B-C																						
50		75	-50-6B-C																						
75		115	-75-6B-C																						
115		180	-115-6B-C																						
180		235	-180-6B-C																						
235	∞	-235-6B-C																							
20	25	35	KGDF ^{F/L} -25-6C-C	43	170																				
	35	50	-35-6C-C																						
	50	75	-50-6C-C																						
	75	115	-75-6C-C																						
	115	180	-115-6C-C																						
	180	235	-180-6C-C																						
25	235	∞	-235-6C-C	48	175																				
	75	115	KGDF ^{F/L} -75-6D-C			55	182																		
	115	180	-115-6D-C																						
	180	235	-180-6D-C																						
	235	∞	-235-6D-C																						

1. KGDF: Right-hand blade for left-hand toolholder, left-hand blade for right-hand toolholder.

The toolholder is applicable for all blade with suitable hand.

2. CDX: Maximum depth to which processing can be made. (If the CDX is 20 mm or more, the maximum groove-depth of groove made by the 2-edge insert will be 18 mm.)

Above toolholders are applicable to Cut-off, too.

Applicable inserts ➔ G111



KGDF-Z (Face grooving)

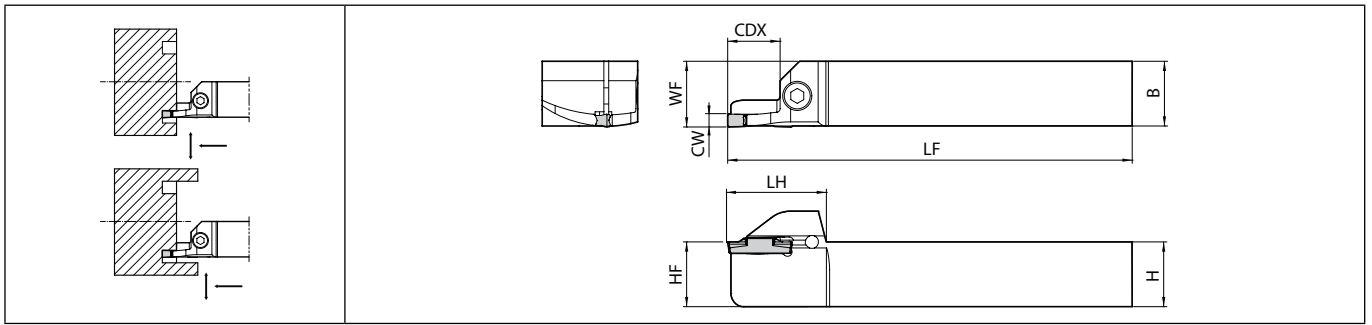

Right-hand shown

Toolholder dimensions

Description	Availability		External dia. of the groove (mm)		Dimension (mm)							Spare parts		Applicable inserts G111	
	R	L	DAXN (min.)	DAXX (max.)	CW	CDX	H	B	LH	HF	LF	WF	Clamp bolt 		Wrench
KGDF%L 2020K50-3B-Z	●	●	50	65	3	15	20	20	30.5	20	125	20.3	HH5X16	LW-4	GDFM 3020... GDFMS 3020... GDFG 3020...
2020K65-3B-Z	●	●	65	85											
2020K85-3B-Z	●	●	85	110											
2020K110-3B-Z	●	●	110	145											
2525M50-3B-Z	●	●	50	65											
2525M65-3B-Z	●	●	65	85											
2525M85-3B-Z	●	●	85	110											
2525M110-3B-Z	●	●	110	145											
KGDF%L 2020K50-4B-Z	●	●	50	70	4	15	20	20	30.5	20	125	20.3	HH5X16	LW-4	GDFM 4020... GDFMS 4020... GDFG 4020...
2020K70-4B-Z	●	●	70	100											
2020K100-4B-Z	●	●	100	150											
2525M50-4B-Z	●	●	50	70											
2525M70-4B-Z	●	●	70	100											
2525M100-4B-Z	●	●	100	150											
KGDF%L 2020K50-5B-Z	●	●	50	75	5	15	20	20	30.5	20	125	20.3	HH5X16	LW-4	GDFM 5020... GDFMS 5020... GDFG 5020...
2020K75-5B-Z	●	●	75	115											
2020K115-5B-Z	●	●	115	180											
2525M50-5B-Z	●	●	50	75											
2525M75-5B-Z	●	●	75	115											
2525M115-5B-Z	●	●	115	180											

KGDF-Z toolholder identification system

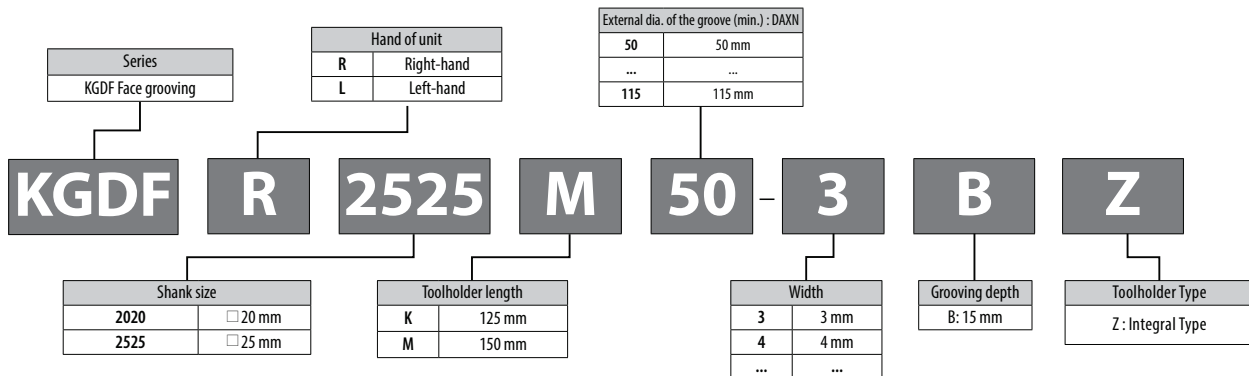

● : Standard item R : Right-hand only L : Left-hand only □ : Check availability

KGDF (Face grooving / 90° separate type)

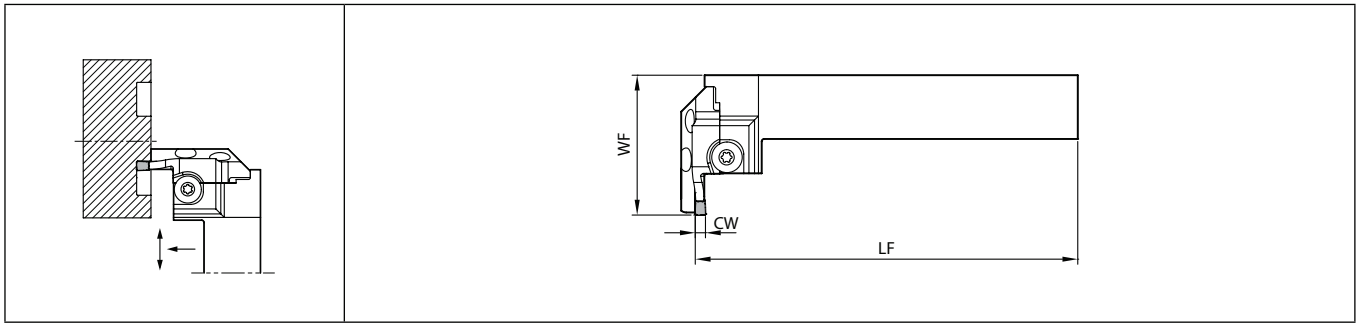

Right-hand shown (Right-hand blade and right-hand toolholder)

Toolholder dimensions (Blade and toolholder)

Shank angle	Cutting width CW (mm)	Shank size (mm)	Max. depth of cut CDX (mm)	External dia. of the groove (mm)		Blade description ➔ G121	Toolholder description ➔ G43	Dimension (mm)			
				DAXX (min.)	DAXX (max.)			LF	WF		
90°	2	20	6	25	30	KGDFR -25-2A-C	KGDSR2020-C	125	49.7		
				30	35					-30-2A-C	
				35	45					-35-2A-C	
				45	60					-45-2A-C	
				60	80					-60-2A-C	
				80	100					-80-2A-C	
		100	130	-100-2A-C							
		13	25	30	KGDFR -25-2B-C	52.7					
		30	35	30	KGDFR -30-2B-C						
		35	45	35	KGDFR -35-2B-C						
		45	60	45	KGDFR -45-2B-C						
		60	80	60	KGDFR -60-2B-C						
	80	100	80	KGDFR -80-2B-C							
	100	130	100	KGDFR -100-2B-C							
	15	25	30	KGDFR -25-2B-C	54.7						
	30	35	30	KGDFR -30-2B-C							
	35	45	35	KGDFR -35-2B-C							
	45	60	45	KGDFR -45-2B-C							
	60	80	60	KGDFR -60-2B-C							
	80	100	80	KGDFR -80-2B-C							
	100	130	100	KGDFR -100-2B-C							
	90°	2	25	6	25	30	KGDFR -25-2A-C	KGDSR2525-C	150	49.7	
					30	35					-30-2A-C
					35	45					-35-2A-C
45					60	-45-2A-C					
60					80	-60-2A-C					
80					100	-80-2A-C					
100			130	-100-2A-C							
13			25	30	KGDFR -25-2B-C	52.7					
30			35	30	KGDFR -30-2B-C						
35			45	35	KGDFR -35-2B-C						
45			60	45	KGDFR -45-2B-C						
60			80	60	KGDFR -60-2B-C						
80		100	80	KGDFR -80-2B-C							
100		130	100	KGDFR -100-2B-C							
15		25	30	KGDFR -25-2B-C	54.7						
30		35	30	KGDFR -30-2B-C							
35		45	35	KGDFR -35-2B-C							
45		60	45	KGDFR -45-2B-C							
60		80	60	KGDFR -60-2B-C							
80		100	80	KGDFR -80-2B-C							
100		130	100	KGDFR -100-2B-C							
90°		3	20	13	25	30	KGDF% -25-3A-C	KGDS% 2020-C	125	52.7	
					30	40					-30-3A-C
					40	50					-40-3A-C
	50				65	KGDF% -50-3B-C					
	65				85		-65-3B-C				
	85				110		-85-3B-C				
	110		145	-110-3B-C							
	22		50	65	KGDF% -50-3C-C						
	65		85	-65-3C-C							
	85		110	-85-3C-C							
	110		145	-110-3C-C							
	25		85	110	KGDF% -85-3B-C						
	110	145	-110-3B-C								
	145	180	-145-3B-C								
	22	50	65	KGDF% -50-3C-C							
	65	85	-65-3C-C								
	85	110	-85-3C-C								
	110	145	-110-3C-C								
	90°	25	25	15	25	30	KGDF% -25-3A-C	KGDS% 2525-C	150	54.7	
					30	40					-30-3A-C
					40	50					-40-3A-C
			50		65	KGDF% -50-3B-C					
			65		85		-65-3B-C				
			85		110		-85-3B-C				
110		145	-110-3B-C								
22		50	65	KGDF% -50-3C-C							
65		85	-65-3C-C								
85		110	-85-3C-C								
110		145	-110-3C-C								

Shank angle	Cutting width CW (mm)	Shank size (mm)	Max. depth of cut CDX (mm)	External dia. of the groove (mm)		Blade description ➔ G121	Toolholder description ➔ G43	Dimension (mm)			
				DAXX (min.)	DAXX (max.)			LF	WF		
90°	4	20	15	13	25	35	KGDFR -25-4A-C	KGDS% 2020-C	125	52.7	
				35	50	50					KGDFR -35-4B-C
				50	70	70					KGDFR -50-4B-C
				70	100	100					KGDFR -70-4B-C
				100	150	150					KGDFR -100-4B-C
				150	220	220					KGDFR -150-4B-C
		220	∞	∞	KGDFR -220-4B-C						
		25	35	50	KGDFR -35-4C-C	64.7					
		50	70	50			KGDFR -50-4C-C				
		70	100	70			KGDFR -70-4C-C				
		100	150	100			KGDFR -100-4C-C				
		150	220	150			KGDFR -150-4C-C				
	220	∞	220	KGDFR -220-4C-C							
	15	13	25	35	KGDFR -25-4A-C	54.7					
	35	50	50	KGDFR -35-4B-C							
	50	70	70	KGDFR -50-4B-C							
	70	100	100	KGDFR -70-4B-C							
	100	150	150	KGDFR -100-4B-C							
	150	220	220	KGDFR -150-4B-C							
	220	∞	220	KGDFR -220-4B-C							
	25	35	50	KGDFR -35-4C-C	64.7						
	50	70	50			KGDFR -50-4C-C					
	70	100	70			KGDFR -70-4C-C					
	100	150	100			KGDFR -100-4C-C					
150	220	150	KGDFR -150-4C-C								
220	∞	220	KGDFR -220-4C-C								

Applicable inserts ➔ G111

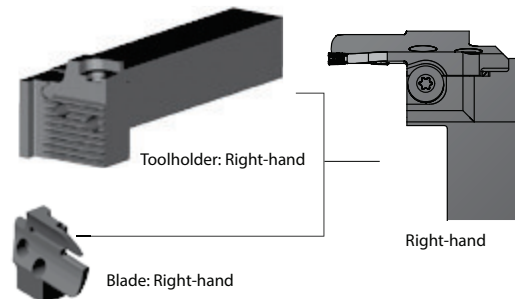

- KGDF 90° type is not available as unit (Toolholder + blade). Please purchase toolholder and blade separately.
- Right-hand Blade for Right-hand Toolholder, Left-hand Blade for Left-hand Toolholder.
- The insert clamping Screw (BH6X10TR), blade fixing Screw (SB-60120TR) and Wrench (LTW-25) which are included in the toolholder can be used.

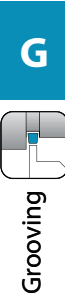

Toolholder dimensions (Blade and toolholder)

Shank angle	Cutting width CW (mm)	Shank size (mm)	Max. depth of cut CD _X (mm)		Blade description G121	Toolholder description G43	Dimension (mm)		
			DAXN (min.)	DAXX (max.)			LF	WF	
			External dia. of the groove (mm)						
90°	5	□20	25	35	KGDF ^{9/1} -25-5B-C	KGDS ^{9/1} .2020-C	125	54.7	
			35	50					-35-5B-C
			50	75					-50-5B-C
			75	115					-75-5B-C
			115	180					-115-5B-C
			180	235					-180-5B-C
		235	∞	-235-5B-C					
		20	35	KGDF ^{9/1} -25-5C-C	59.7				
		35	50						-35-5C-C
		50	75						-50-5C-C
		75	115						-75-5C-C
		115	180						-115-5C-C
	180	235	-180-5C-C						
	235	∞	-235-5C-C						
	25	32	KGDF ^{9/1} -75-5D-C	71.7					
	75	115				-115-5D-C			
	115	180				-180-5D-C			
	180	235				-235-5D-C			
	5	□25	25	35		KGDF ^{9/1} -25-5B-C	KGDS ^{9/1} .2525-C	150	54.7
			35	50	-35-5B-C				
			50	75	-50-5B-C				
			75	115	-75-5B-C				
			115	180	-115-5B-C				
			180	235	-180-5B-C				
235		∞	-235-5B-C						
20		35	KGDF ^{9/1} -25-5C-C	59.7					
35		50			-35-5C-C				
50		75			-50-5C-C				
75		115			-75-5C-C				
115		180			-115-5C-C				
180	235	-180-5C-C							
235	∞	-235-5C-C							
25	32	KGDF ^{9/1} -75-5D-C	71.7						
75	115			-115-5D-C					
115	180			-180-5D-C					
180	235			-235-5D-C					

Shank angle	Cutting width CW (mm)	Shank size (mm)	Max. depth of cut CD _X (mm)		Blade description G121	Toolholder description G43	Dimension (mm)		
			DAXN (min.)	DAXX (max.)			LF	WF	
			External dia. of the groove (mm)						
90°	6	□20	25	35	KGDF ^{9/1} -25-6B-C	KGDS ^{9/1} .2020-C	125	54.7	
			35	50					-35-6B-C
			50	75					-50-6B-C
			75	115					-75-6B-C
			115	180					-115-6B-C
			180	235					-180-6B-C
		235	∞	-235-6B-C					
		20	35	KGDF ^{9/1} -25-6C-C	59.7				
		35	50						-35-6C-C
		50	75						-50-6C-C
		75	115						-75-6C-C
		115	180						-115-6C-C
	180	235	-180-6C-C						
	235	∞	-235-6C-C						
	25	32	KGDF ^{9/1} -75-6D-C	71.7					
	75	115			-115-6D-C				
	115	180			-180-6D-C				
	180	235			-235-6D-C				
	6	□25	25	35	KGDF ^{9/1} -25-6B-C	KGDS ^{9/1} .2525-C	150	54.7	
			35	50					-35-6B-C
			50	75					-50-6B-C
			75	115					-75-6B-C
			115	180					-115-6B-C
			180	235					-180-6B-C
235		∞	-235-6B-C						
20		35	KGDF ^{9/1} -25-6C-C	59.7					
35		50			-35-6C-C				
50		75			-50-6C-C				
75		115			-75-6C-C				
115		180			-115-6C-C				
180	235	-180-6C-C							
235	∞	-235-6C-C							
25	32	KGDF ^{9/1} -75-6D-C	71.7						
75	115			-115-6D-C					
115	180			-180-6D-C					
180	235			-235-6D-C					

- KGDF 90° type is not available as unit (Toolholder + blade). Please purchase toolholder and blade separately.
 - Right-hand Blade for Right-hand Toolholder, Left-hand Blade for Left-hand Toolholder.
 - The insert clamping Screw (BH6X10TR), blade fixing Screw (SB-60120TR) and Wrench (LTW-25) which are included in the toolholder can be used.
- Applicable inserts G111

Face grooving blade identification system

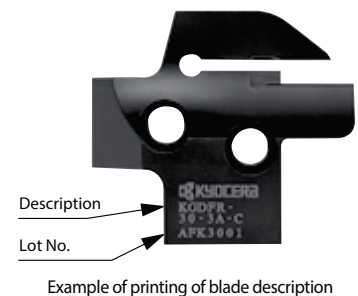
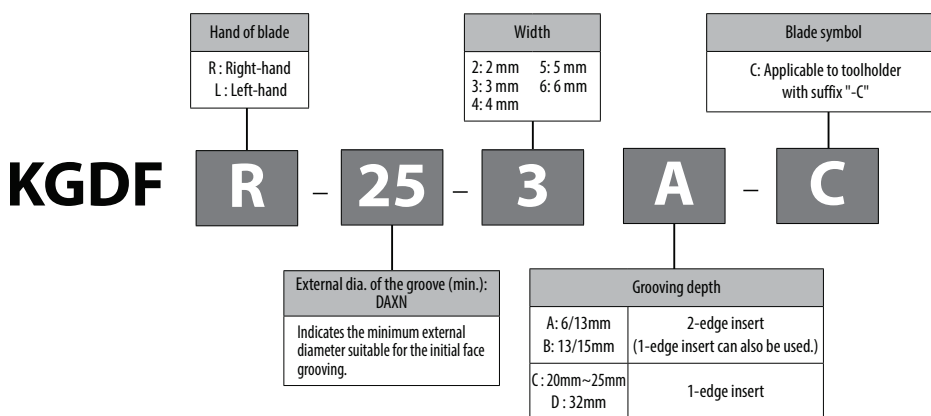

Blade dimensions

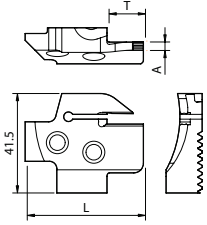
Shape	Blade description	Availability		External dia. of the groove (mm)		Dimension (mm)			Cutting width CW (mm)	Applicable inserts ➔ G111	Applicable toolholder ➔ G43
		R	L	DAXN (min.)	DAXX (max.)	L	T	A			
	KGDFR	-25-2A-C	●		25	30	44.35	6	1.5	2	GDFM 2020N-020GM
		-30-2A-C	●		30	35					
		-35-2A-C	●		35	45					
		-45-2A-C	●		45	60					
		-60-2A-C	●		60	80					
		-80-2A-C	●		80	100					
	KGDFR	-100-2A-C	●		100	130					
		-25-2B-C	●		25	30	47.35	13	15	3	GDFM 3020... GDFMS 3020... GDFG 3020...
		-30-2B-C	●		30	35					
		-35-2B-C	●		35	45					
		-45-2B-C	●		45	60					
		-60-2B-C	●		60	80					
	-80-2B-C	●		80	100						
	KGDF%	-100-2B-C	●		100	130					
		-25-3A-C	●	●	25	30	47.35	13	2	3	GDFM 4020... GDFMS 4020... GDFG 4020...
		-30-3A-C	●	●	30	40					
		-40-3A-C	●	●	40	50					
		-50-3B-C	●	●	50	65					
		-65-3B-C	●	●	65	85					
	-85-3B-C	●	●	85	110						
	KGDF%	-110-3B-C	●	●	110	145					
		-50-3C-C	●	●	50	65	56.35	22	25	4	GDFM 5020... GDFMS 5020... GDFG 5020...
		-65-3C-C	●	●	65	85					
	-85-3C-C	●	●	85	110						
	KGDF%	-110-3C-C	●	●	110	145					
		-25-4A-C	●	●	25	35	49.35	15	3	4	GDFM 6020... GDFMS 6020... GDFG 6020...
		-35-4B-C	●	●	35	50					
		-50-4B-C	●	●	50	70					
		-70-4B-C	●	●	70	100					
		-100-4B-C	●	●	100	150					
	-150-4B-C	●	●	150	220						
	KGDF%	-220-4B-C	●	●	220	∞					
		-35-4C-C	●	●	35	50	59.35	25	5	6	GDFM 6020... GDFMS 6020... GDFG 6020...
		-50-4C-C	●	●	50	70					
		-70-4C-C	●	●	70	100					
		-100-4C-C	●	●	100	150					
		-150-4C-C	●	●	150	220					
	-220-4C-C	●	●	220	∞						
	KGDF%	-25-5B-C	●	●	25	35	49.35	15	4	5	GDFM 5020... GDFMS 5020... GDFG 5020...
		-35-5B-C	●	●	35	50					
		-50-5B-C	●	●	50	75					
		-75-5B-C	●	●	75	115					
		-115-5B-C	●	●	115	180					
		KGDF%	-180-5B-C	●	●	180	235				
			-235-5B-C	●	●	235	∞				
			-25-5C-C	●	●	25	35	54.35	20	32	
		-35-5C-C	●	●	35	50					
		-50-5C-C	●	●	50	75					
		KGDF%	-75-5C-C	●	●	75	115				
			-115-5C-C	●	●	115	180				
			-180-5C-C	●	●	180	235				
			-235-5C-C	●	●	235	∞				
			-75-5D-C	●	●	75	115	66.35	32	5	
	-115-5D-C		●	●	115	180					
	-180-5D-C	●	●	180	235						
	KGDF%	-235-5D-C	●	●	235	∞					
		-25-6B-C	●	●	25	35	49.35	15	5	6	GDFM 6020... GDFMS 6020... GDFG 6020...
		-35-6B-C	●	●	35	50					
		-50-6B-C	●	●	50	75					
		-75-6B-C	●	●	75	115					
-115-6B-C		●	●	115	180						
KGDF%		-180-6B-C	●	●	180	235					
		-235-6B-C	●	●	235	∞					
		-25-6C-C	●	●	25	35	54.35	20	25	6	
-35-6C-C		●	●	35	50						
-50-6C-C		●	●	50	75						
KGDF%		-75-6C-C	●	●	75	115					
		-115-6C-C	●	●	115	180					
		-180-6C-C	●	●	180	235					
		-235-6C-C	●	●	235	∞					
	-75-6D-C	●	●	75	115	66.35	32	5	6		
	-115-6D-C	●	●	115	180						
-180-6D-C	●	●	180	235							
KGDF%	-235-6D-C	●	●	235	∞						

● : Standard item R : Right-hand only L : Left-hand only □ : Check availability



Recommended cutting conditions

Workpiece material	Recommended insert grades (Vc: m/min)				Remarks
	Cermet		MEGACOAT		
	TN620	TN90	PR1225	PR1215	
Carbon steel	☆ 60~200	☆ 80~200	★ 60~160	☆ 80~160	Coolant
Alloy steel	☆ 60~160	☆ 70~160	★ 60~150	☆ 60~150	
Stainless steel	-	-	★ 50~120	☆ 50~120	
Cast iron	-	-	-	★ 80~160	

★ : 1st recommendation ☆ : 2nd recommendation

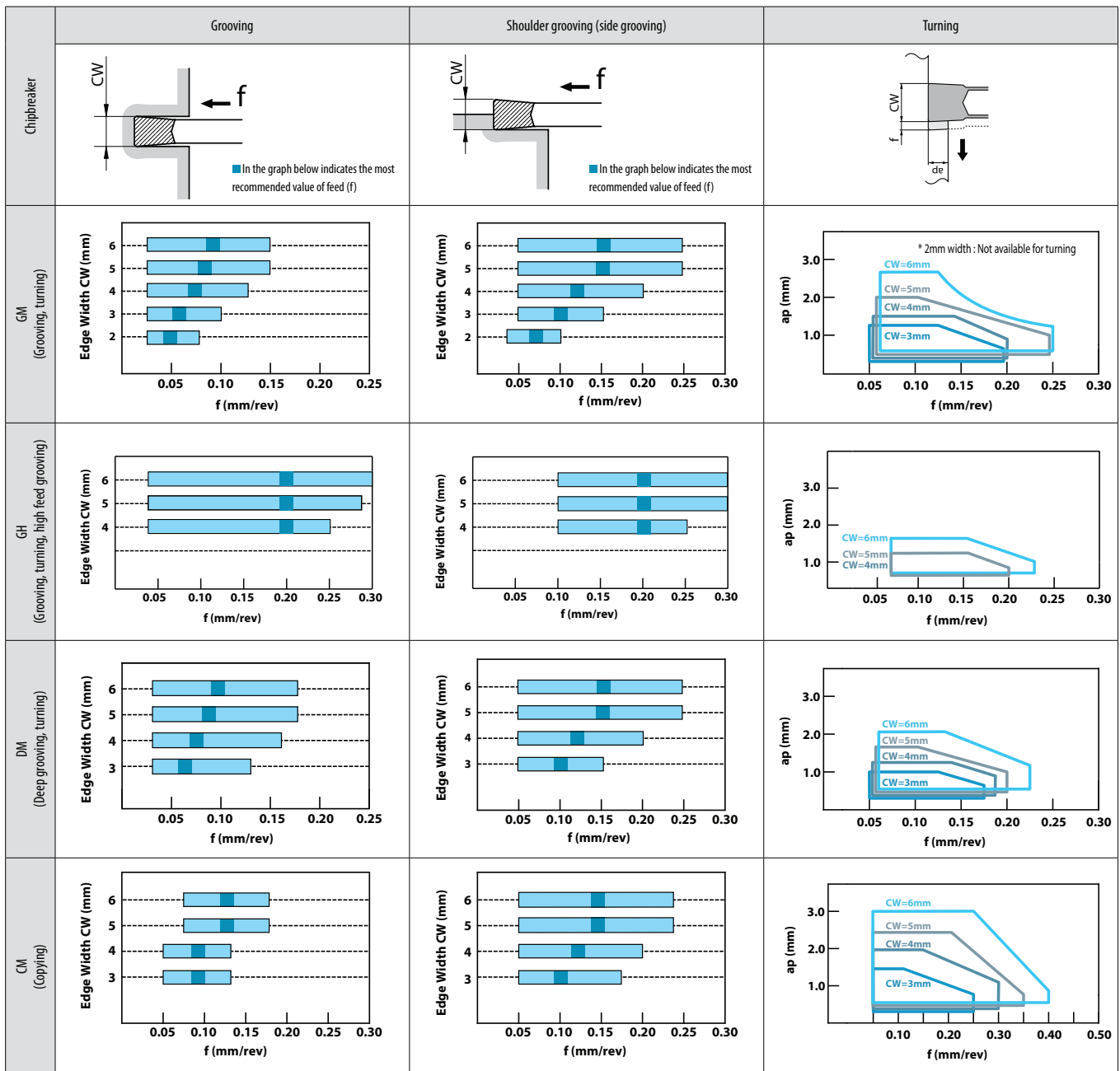

When shoulder grooving

- If ap is set smaller, set feed higher.
- If ap is set larger, set feed lower.

Workpiece material: C50

1. The above values are based on the condition that the CDX of toolholder is 15 mm or less.

Guide for face grooving

1. Toolholder selection

Check the range of applicable "external diameter of the groove" as well as the groove width and depth.

2. Cutting conditions (Feed rate: f)

When machining on steel, set the feed rate (f) so that chips are created in a helical form in cut-off.

3. How to widen the groove (plunge milling and turning)

Start machining from the outside and then proceed to the inside.

Chip control will be better in this way.

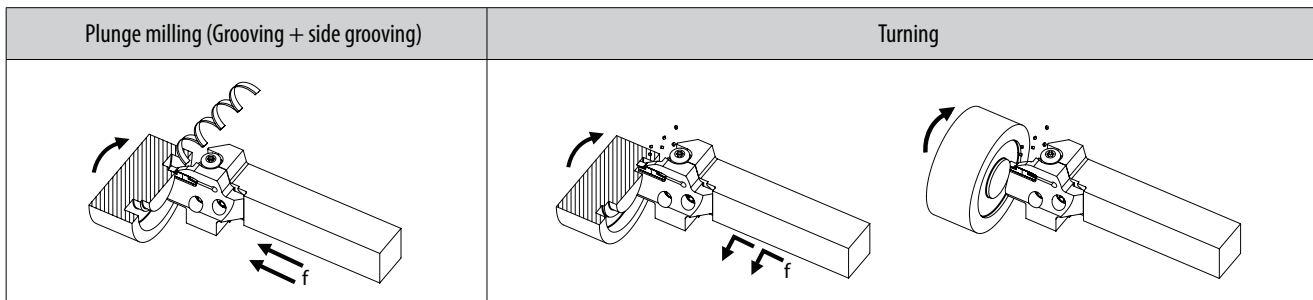
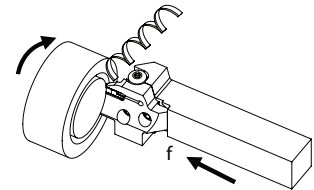

4. Guide for turning

A. When the cutting amount (ap) is over 0.5 mm

1. Perform plunge milling.
2. Return the cutting by 0.1 mm. Failure to pull the tool back before traverse machining will result in an unbalanced load applied on only one side of the cutting edge.
3. Perform turning (Ref. to Fig. 1)

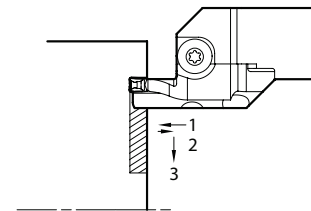
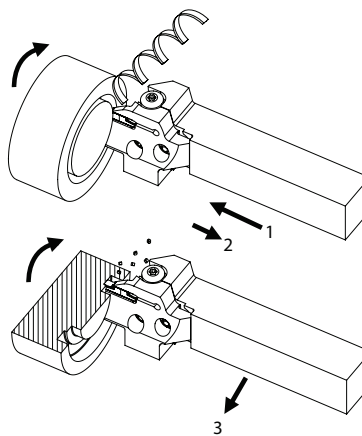

Fig. 1

When widening the face groove width (Ref. to Fig. 2).

- Apply the "step turning".
- Then perform finishing.

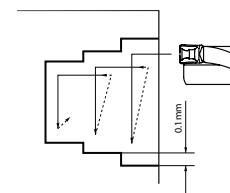

Fig. 2

B. When the cutting amount (ap) is under 0.5 mm

1. Perform Plunge milling.
 2. Perform turning.
- Machining without interruption is possible.
(Ref. to Fig. 3)

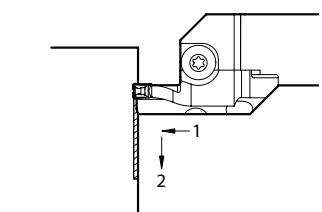
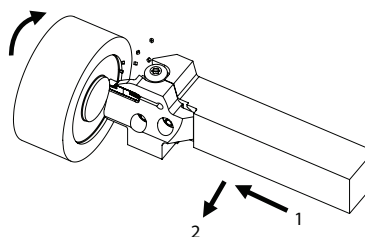

Fig. 3

GVF-AA

Insert		Description		Dimension (mm)							Tolerance (mm)		Carbide			Applicable toolholder G125
				No. of edges	CW	CDX	S	RE	INSL	W1	CW min.	CW max.	PVD	-		
														PR1225	PR930	
				Carbon steel / Alloy steel							● ○		P			
				Stainless steel							● ○		M			
				Cast iron							● ○		K			
				Non-ferrous metals							● ○		N			
				Titanium alloy							● ○		S			
				Hard materials (~ 40HRC)							● ○		H			
				Hard materials (40HRC ~)							● ○		H			
	GVFR	100-005AA	1	2.2	4.5	0.05	12	4.3	-0.02	+0.02	●	●	●	GFVSL...-08AA GFVTL...-08AA		
		200-005AA	2								●	●	●			
		300-005AA	3								●	●	●			
	GVFL	100-005AA	1	2.2	4.5	0.05	12	4.3	-0.02	+0.02	●	●	●	GFVSR...-08AA GFVTR...-08AA		
		200-005AA	2								●	●	●			
		300-005AA	3								●	●	●			

CDX shows available grooving depth.

GVF^{PR}L...005AA inserts are not compatible with GVF^{PR}L...-○○○A (See Page G126) inserts because their Side Relief Angle is 10°.

External dia. of the groove of GFVS-AA (apply to GFVT-AA)

Description	External dia. of the groove (mm)		Applicable inserts
	DAXN (min.)	DAXX (max.)	
GFVS ^{PR} L 2020K-08AA 2525M-08AA	8 (0)	∞ (∞)	GVF ^{PR} /R...-...AA

● It is available to infinity ∞ in case of machining the first groove bigger than DAXN.

● When machining towards the outer diameter then there is no MAX. limit to the further groove machining.

● When machining the initial groove on the face at DAXN ø8

If the initial groove is made smaller than this, the toolholder interferes with the workpiece.

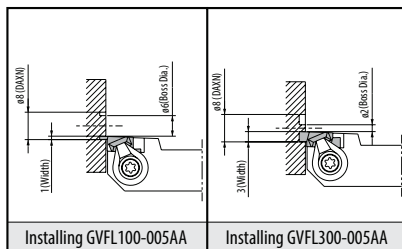

● When widening the groove width to inner diameter.

For machining up to the center of the workpiece regardless of insert width.

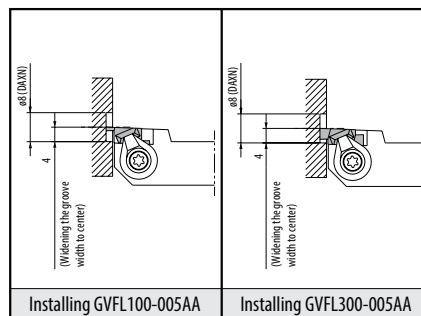

Recommended cutting conditions GFVS-AA / GFVT-AA

Workpiece material	Recommended insert grades (Vc: m/min)			Grooving f (mm/rev)	Turning*		Remarks
	MEGACOAT	PVD coated carbide	Carbide		ap (mm)	f (mm/rev)	
	PR1225	PR930	KW10				
Carbon steel / Alloy steel	★ 50~100	☆ 50~100		0.01~0.05	Max. 0.5	0.01~0.05	Coolant
Stainless steel	★ 50~80	☆ 50~80		0.01~0.03	Max. 0.3	0.01~0.02	
Non-ferrous metals			★ ~200	0.01~0.08	Max. 0.5	0.01~0.08	

* ap has to be set for less than corner-R(RE) when turning of edge width 1.0 mm (GVF^{PR}L100-005AA).

★ :1st recommendation ☆ :2nd recommendation

● : Standard item R : Right-hand only L : Left-hand only □ : Check availability

G124

GFVS-AA (Face grooving)

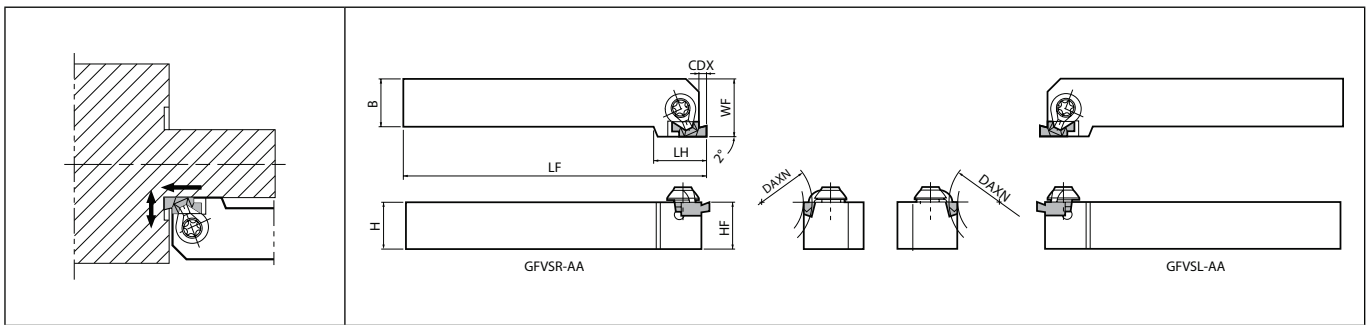

Left-hand Insert for Right-hand Toolholder, Right-hand Insert for Left-hand Toolholder.

Toolholder dimensions

Description	Availability		External dia. of the groove (mm)		Dimension (mm)							Spare parts		Applicable inserts ➔ G124
												Clamp set	Wrench	
	R	L	DAXN (min.)	DAXX (max.)	CDX	H	B	LH	HF	LF	WF			
GFVS ^{R/L} 2020K-08AA 2525M-08AA	●	●	8	∞	2.2	20	20	18	20	125	25	CPS-5V	FT-15	GVF ^{R/L} ...-...AA
	●	●	(0)	(∞)		25	25		25	150	32			

CDX shows available grooving depth.

The value () of External dia. of the groove (DAXX) is the maximum outer diameter value after the initial groove between DAXN ~ DAXX. (It is possible to widen the groove to infinity ∞).

The value () of External dia. of the groove (DAXN) is the minimum diameter of the boss which remains in the center when widening the groove width to a smaller value after the initial groove between DAXN ~ DAXX.

GFVT-AA (Face grooving)

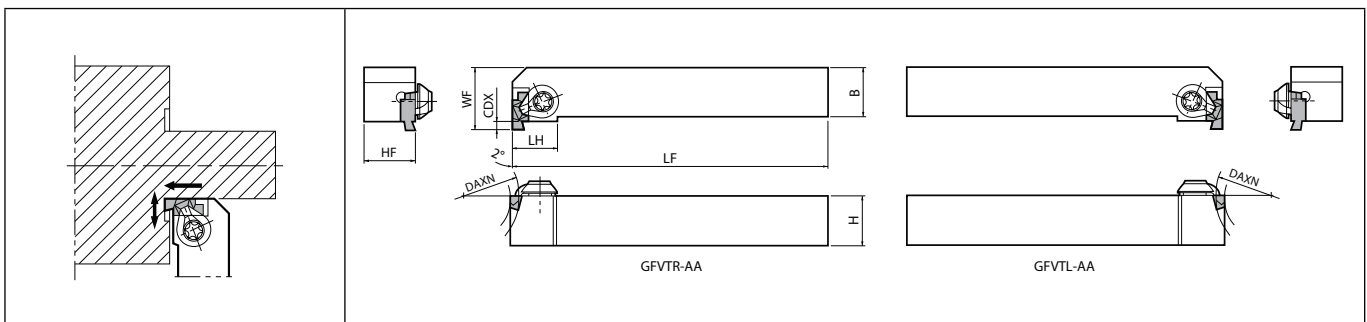

Left-hand Insert for Right-hand Toolholder, Right-hand Insert for Left-hand Toolholder.

Toolholder dimensions

Description	Availability		External dia. of the groove (mm)		Dimension (mm)							Spare parts		Applicable inserts ➔ G124
												Clamp set	Wrench	
	R	L	DAXN (min.)	DAXX (max.)	CDX	H	B	LH	HF	LF	WF			
GFVT ^{R/L} 2020K-08AA 2525M-08AA	●	●	8	∞	2.2	20	20	14	20	125	25	CPS-5V	FT-15	GVF ^{R/L} ...-...AA
	●	●	(0)	(∞)		25	25		25	150	32			

CDX shows available grooving depth.





The value () of External dia. of the groove (DAXX) is the maximum outer diameter value after the initial groove between DAXN ~ DAXX. (It is possible to widen the groove to infinity ∞).

The value () of External dia. of the groove (DAXN) is the minimum diameter of the boss which remains in the center when widening the groove width to a smaller value after the initial groove between DAXN ~ DAXX.

● : Standard item R : Right-hand only L : Left-hand only □ : Check availability

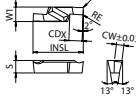

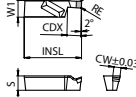
GVF

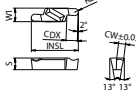
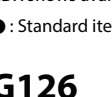
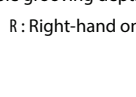
Insert		Description		Dimension (mm)							Tolerance (mm)		Carbide					Cermet	PCD	Applicable toolholder G127~ G129				
				No. of edges	CW	CDX	S	RE	INSL	W1	CW min.	CW max.	PVD	- PR125 PR930	- KW10	- TC40	- TC60	- KP0010						
																			Carbon steel / Alloy steel					
				Stainless steel							●		●					●	M					
				Cast iron							●		●					●	K					
				Non-ferrous metals							●		●					●	N					
				Titanium alloy							●		●					●	S					
				Hard materials (~ 40HRC)							●		○					○	H					
				Hard materials (40HRC ~)							○		○					○	H					
 <p>External Internal Face</p>		GVFR	200-020A	2															GVFR....-201A GIFVR....-201A					
			230-020A	2.3																	GVFL....-201A GIFVL....-201A			
			250-020A	2.5																		GVFR....-1B *1 GFVSL....-1B GFVTL....-1B GIFVR....-1B		
			270-020A	2.7																			GVFR....-2B *2 GFVSL....-2B GFVTL....-2B GIFVR....-2B	
			290-020A	2.9																				GVFL....1B *3 GFVSR....1B GFVTR....1B GIFVL....1B
			340-020A	3.4	2.3	4.5	0.2	12	4.3	-0.03	+0.03	●	●	●	●	●	●	●		●				
		GVFL	200-020A	2																GVFR....-1C *5 GFVSL....-1C GFVTL....-1C GIFVR....-1C				
			230-020A	2.3																	GVFR....-2C GFVSL....-2C GFVTL....-2C GIFVR....-2C			
			250-020A	2.5																		GVFL....1C GFVSR....1C GFVTR....1C GIFVL....1C		
			270-020A	2.7																			GVFL....2C GFVSR....2C GFVTR....2C GIFVL....2C	
			290-020A	2.9																				GVFR....-1C *5 GFVSL....-1C GFVTL....-1C GIFVR....-1C
			340-020A	3.4	2.3	4.5	0.2	12	4.3	-0.03	+0.03	●	●	●	●	●	●	●	●					
		GVFR	250-020B	2.5	4.8															GVFR....-1B *1 GFVSL....-1B GFVTL....-1B GIFVR....-1B				
			300-020B	3	4.8																GVFR....-2B *2 GFVSL....-2B GFVTL....-2B GIFVR....-2B			
			350-020B	3.5	4.8																	GVFR....-1B *3 GFVSR....-1B GFVTR....-1B GIFVL....-1B		
400-020B	4		5.3															GVFR....-2B *4 GFVSR....-2B GFVTR....-2B GIFVL....-2B						
430-020B	4.3		5.3																GVFR....-1C *5 GFVSL....-1C GFVTL....-1C GIFVR....-1C					
460-020B	4.6		5.3																				GVFR....-2C GFVSL....-2C GFVTL....-2C GIFVR....-2C	
GVFL	250-020B	2	2.5	4.8		5	0.2	20	5.8	-0.03	+0.03	●	●	●	●	●	●			GVFR....-1B *1 GFVSL....-1B GFVTL....-1B GIFVR....-1B				
	300-020B	3	2.5	4.8																	GVFR....-2B *2 GFVSL....-2B GFVTL....-2B GIFVR....-2B			
	350-020B	4	2.5	4.8																		GVFR....-1B *3 GFVSR....-1B GFVTR....-1B GIFVL....-1B		
	400-020B	5	2.5	4.8														GVFR....-2B *4 GFVSR....-2B GFVTR....-2B GIFVL....-2B						
	430-020B	6	2.5	4.8															GVFR....-1C *5 GFVSL....-1C GFVTL....-1C GIFVR....-1C					
	460-020B	7	2.5	4.8																			GVFR....-2C GFVSL....-2C GFVTL....-2C GIFVR....-2C	
GVFR	350-040C	1	3.5	6.8	7	0.4	27	7	-0.03	+0.03	●	●	●	●	●	●	●			GVFR....-1B *1 GFVSL....-1B GFVTL....-1B GIFVR....-1B				
	400-040C	2	3.5	6.8																	GVFR....-2B *2 GFVSL....-2B GFVTL....-2B GIFVR....-2B			
	450-040C	3	3.5	6.8																		GVFR....-1B *3 GFVSR....-1B GFVTR....-1B GIFVL....-1B		
	500-040C	4	3.5	6.8														GVFR....-2B *4 GFVSR....-2B GFVTR....-2B GIFVL....-2B						
	550-040C	5	3.5	6.8															GVFR....-1C *5 GFVSL....-1C GFVTL....-1C GIFVR....-1C					
	600-040C	6	3.5	6.8																			GVFR....-2C GFVSL....-2C GFVTL....-2C GIFVR....-2C	
GVFL	350-040C	1	3.5	6.8	7	0.4	27	7	-0.03	+0.03	●	●	●	●	●	●	●			GVFR....-1B *1 GFVSL....-1B GFVTL....-1B GIFVR....-1B				
	400-040C	2	3.5	6.8																	GVFR....-2B *2 GFVSL....-2B GFVTL....-2B GIFVR....-2B			
	450-040C	3	3.5	6.8																		GVFR....-1B *3 GFVSR....-1B GFVTR....-1B GIFVL....-1B		
	500-040C	4	3.5	6.8														GVFR....-2B *4 GFVSR....-2B GFVTR....-2B GIFVL....-2B						
	550-040C	5	3.5	6.8															GVFR....-1C *5 GFVSL....-1C GFVTL....-1C GIFVR....-1C					
	600-040C	6	3.5	6.8																			GVFR....-2C GFVSL....-2C GFVTL....-2C GIFVR....-2C	
 <p>1-edge</p>		GVFR	250-020B	1	2.5	4.8														*1 *2 *3 *4 *5				
			300-020B	2	3	4.8																		
			400-020B	3	4	5.3	5	0.2	20	5.8	-0.03	+0.03	●	●	●	●	●				●	MT0		
		GVFL	250-020B	1	2.5	4.8															*1 *2 *3 *4 *5			
			400-020B	2	3	4.8														MT0				
 <p>Full R / Copying</p>		GVFR	200-100AR	2														GVFR....-201A GIFVR....-201A						
			250-125AR	2.5																	GVFL....-201A GIFVL....-201A			
			300-150AR	3	2.3	4.5	1.5	1	12	4.3	-0.03	+0.03	●	●	●	●	●		●	*1 *2 *3 *4				
		GVFL	200-100AR	2	2																*1 *2 *3 *4			
			250-125AR	2.5																*1 *2 *3 *4				
		GVFR	300-150BR	2	3	4.8												*1 *2 *3 *4						
			400-200BR	3	4	5.3														*1 *2 *3 *4				
		GVFL	300-150BR	2	3	4.8	5	1.5	2	20	5.8	-0.03	+0.03	●	●	●	●	●	*1 *2 *3 *4					
			400-200BR	3	4	5.3														*1 *2 *3 *4				

Right-hand shown
CDX shows available grooving depth.

● : Standard item R : Right-hand only L : Left-hand only □ : Check availability MT0 : Made to order

Recommended cutting conditions G146

CBN & PCD Inserts are
sold in 1 piece boxes

GVF (Face grooving)

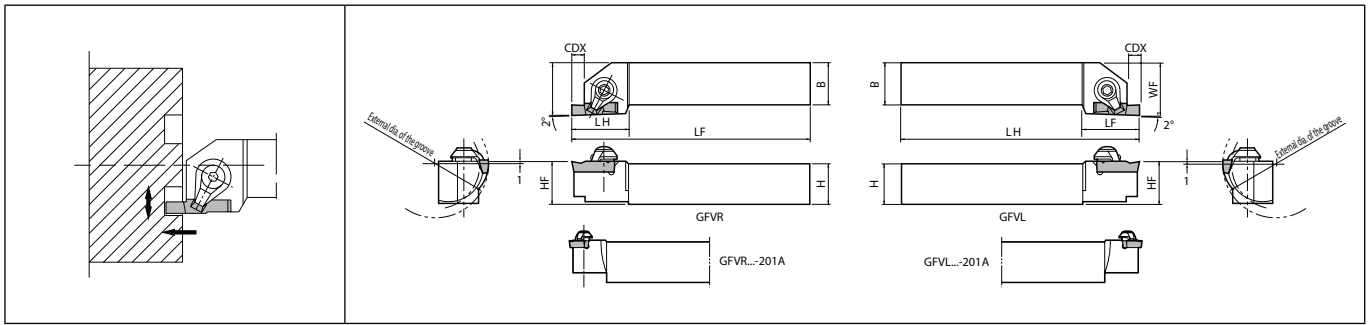

Right-hand Insert for Right-hand Toolholder, Left-hand Insert for Left-hand Toolholder.

Toolholder dimensions

Description	Availability		External dia. of the groove (mm)		Dimension (mm)							Spare parts				Applicable inserts G126													
												Clamp set	Clamp set	Wrench	Wrench														
	R	L	DAXN (min.)	DAXX (max.)	CDX	H	B	LH	HF	LF	WF																		
GVF ^{R/L} 2020K-201A 2525M-201A	●	●	20 (12)	∞ (∞)	2.2	20	20	20	21	125	25	CPS-5V	-	-	FT-15	GVF ^{R/L} 200 ~ 340...A GVF ^{R/L} 200 ~ 300...AR													
GVF ^{R/L} 2020K-351B 2525M-351B	●	●	35 (25)	50 (∞)	4.6	20	20	28	21	125	25	-	CPS-6V	LW-3	-	GVF ^{R/L} 250 ~ 350...B GVF ^{R/L} 300-150BR													
2020K-352B 2525M-352B	●	●			5.1	20	20	28	21	125	25					25	30	26	150	32	GVF ^{R/L} 400 ~ 490...B GVF ^{R/L} 400-200BR								
2020K-501B 2525M-501B	●	●	50 (25)	70 (∞)	4.6	20	20	28	21	125	25					-	CPS-6V	LW-3	-	GVF ^{R/L} 250 ~ 350...B GVF ^{R/L} 300-150BR									
2020K-502B 2525M-502B	●	●			5.1	20	20	28	21	125	25									25	30	26	150	32	GVF ^{R/L} 400 ~ 490...B GVF ^{R/L} 400-200BR				
2020K-701B 2525M-701B	●	●	70 (25)	100 (∞)	4.6	20	20	28	21	125	25									-	CPS-8V	LW-4	-	GVF ^{R/L} 250 ~ 350...B GVF ^{R/L} 300-150BR					
2020K-702B 2525M-702B	●	●			5.1	20	20	28	21	125	25													25	30	26	150	32	GVF ^{R/L} 400 ~ 490...B GVF ^{R/L} 400-200BR
GVF ^{R/L} 2525M-501C 2525M-502C	●	●	50 (25)	70 (∞)	6.6	25	25	35	26	150	32													-	CPS-8V	LW-4	-	GVF ^{R/L} 350 ~ 450...C GVF ^{R/L} 500 ~ 600...C	
2525M-701C 2525M-702C	●	●			70 (25)																							100 (∞)	6.6
2525M-1001C 2525M-1002C	●	●	100 (25)	150 (∞)	6.6																							8.1	GVF ^{R/L} 350 ~ 450...C GVF ^{R/L} 500 ~ 600...C
2525M-1501C 2525M-1502C	●	●			150 (25)																							250 (∞)	6.6

CDX shows available grooving depth.

The value () of External dia. of the groove (DAXX) is the maximum outer diameter value after the initial groove between DAXN ~ DAXX. (It is possible to widen the groove to infinity ∞).

The value () of External dia. of the groove (DAXN) is the minimum diameter of the boss which remains in the center when widening the groove width to a smaller value after the initial groove between DAXN ~ DAXX.

Standard toolholders are designed with the edge position 1.0 mm above the center. When using non-standard toolholders, set the edge position 1.0 mm above the center.

Selection of Toolholder & Insert

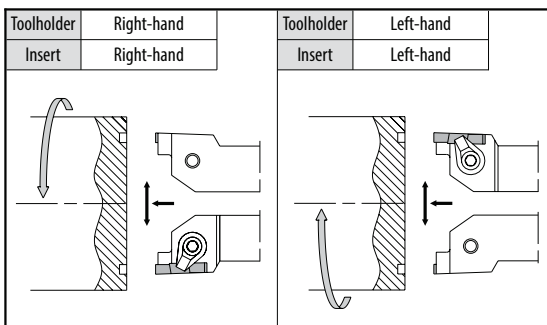

● : Standard item R : Right-hand only L : Left-hand only □ : Check availability



External dia. of the groove of GVF

(1) e.g.) GVF^{R/L}...-201A

Description	External dia. of the groove (mm)		Applicable inserts
	DAXN (min.)	DAXX (max.)	
GVF ^{R/L} 2020K-201A	20	∞	GVF ^{R/L} 200 ~ 340...A
2525M-201A	(12)	(∞)	GVF ^{R/L} 200 ~ 300...AR

• It is available to infinity ∞ in case of machining the first groove bigger than DAXN.

• When machining towards the outer diameter then there is no MAX. limit to the further groove machining.

• When machining the initial groove on the face at DAXN $\phi 20$

If the initial groove is made smaller than this, the toolholder interferes with the workpiece. Boss Dia. depends on insert width.

• When widening the groove width to inner diameter.

Face groove diameter DAXN (12) is the limit; the toolholder interferes with the workpiece in case of smaller than $\phi 12$. The toolholder interferes with the workpiece when closer to the center.

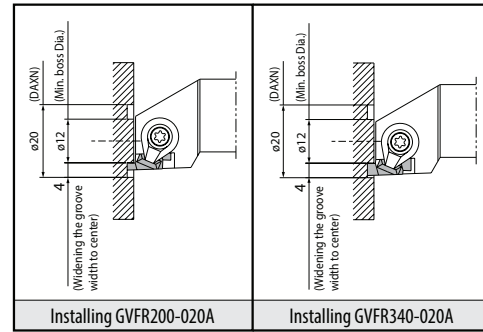
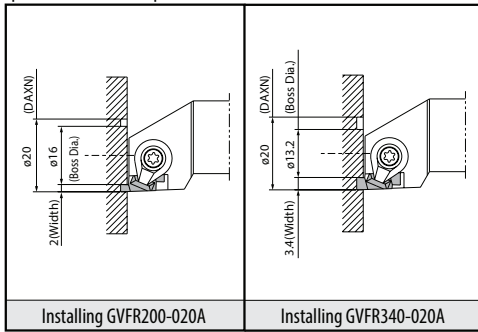

G

Grooving

(2) e.g.) GVF^{R/L}...-351B/352B (same as GVF^{R/L}...-○○○B or GVF^{R/L}...-○○○C)

Description	External dia. of the groove (mm)		Applicable inserts
	DAXN (min.)	DAXX (max.)	
GVF ^{R/L} 2020K-351B	35 (25)	50 (∞)	GVF ^{R/L} 250 ~ 350...B
2525M-351B			GVF ^{R/L} 300-150BR
2020K-352B			GVF ^{R/L} 400 ~ 490...B
2525M-352B			GVF ^{R/L} 400-200BR

• It is possible to widen the groove to infinity ∞ when machining the initial groove within DAXN ~ DAXX and then widening to outer diameter.

• When machining the initial groove on the face at DAXN $\phi 35$

If the initial groove is made smaller than this, the toolholder interferes with the workpiece. Boss Dia. depends on insert width.

• When machining the initial groove on the face at DAXX $\phi 50$.

If the initial groove is made larger than this, the toolholder interferes with the workpiece. Boss Dia. depends on insert width.

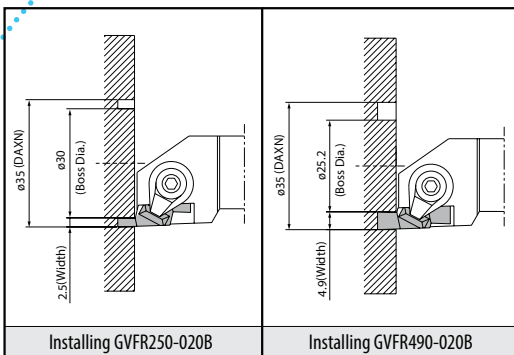

When widening the groove width to inner diameter.

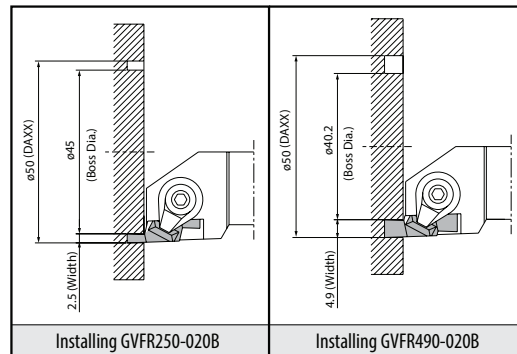

• When widening the groove width to inner diameter.

$\phi 25$ Boss Dia. is the limitation regardless of insert width, even widening the groove width to the center from the initial groove at DAXN ($\phi 35$) or DAXX ($\phi 50$). The toolholder interferes with the workpiece when closer to the center.

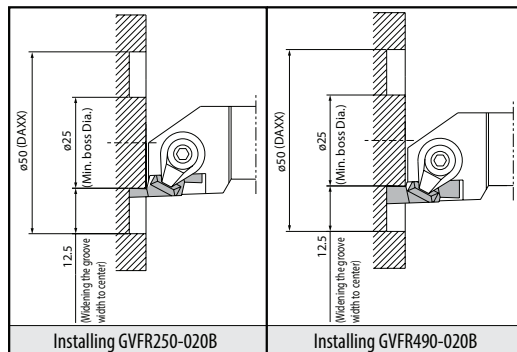
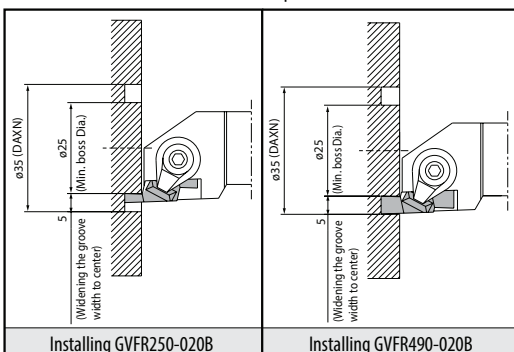

GFVS (Face grooving)

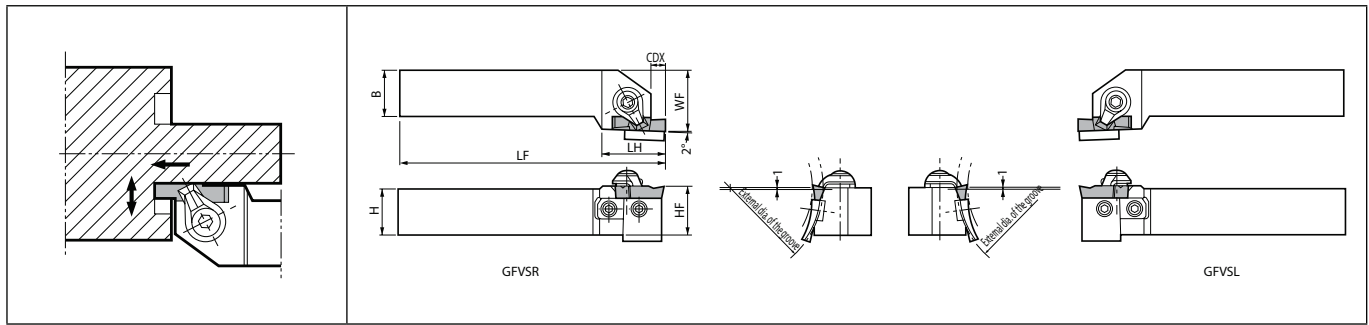

Left-hand Insert for Right-hand Toolholder, Right-hand Insert for Left-hand Toolholder. This toolholder can machine various face grooving diameters by replacing the blade.

Toolholder dimensions

Description	Availability		External dia. of the groove (mm)		Dimension (mm)							Spare parts				Applicable inserts G126																					
												Blade	Bolt	Clamp set	Wrench																						
	R	L	DAXN (min.)	DAXX (max.)	CDX	H	B	LH	HF	LF	WF																										
GFVS%L 2020K-351B 2525M-351B 2020K-352B 2525M-352B 2020K-501B 2525M-501B 2020K-502B 2525M-502B 2020K-701B 2525M-701B 2020K-702B 2525M-702B	●	●	35 (25)	50 (∞)	5.1 (4.6)	20	20	30	21	125	25	SF%L-351B	HH4X12	CPS-6V	LW-3	GVF% _R 250 ~ 350-...B GVF% _R 300-150BR																					
	●	●			5.1 (5.1)	20	20	30	21	125	25						SF%L-352B	GVF% _R 400 ~ 490-...B GVF% _R 400-200BR																			
	●	●	50 (25)	70 (∞)	5.1 (4.6)	20	20	30	21	125	25	SF%L-501B					HH4X12	CPS-6V	LW-3	GVF% _R 250 ~ 350-...B GVF% _R 300-150BR																	
	●	●			5.1 (5.1)	20	20	30	21	125	25										SF%L-502B	GVF% _R 400 ~ 490-...B GVF% _R 400-200BR															
	●	●	70 (25)	100 (∞)	5.1 (4.6)	20	20	30	21	125	25	SF%L-701B									HH4X12	CPS-6V	LW-3	GVF% _R 250 ~ 350-...B GVF% _R 300-150BR													
	●	●			5.1 (5.1)	20	20	30	21	125	25														SF%L-702B	GVF% _R 400 ~ 490-...B GVF% _R 400-200BR											
	GFVS%L 2525M-501C 2525M-502C 2525M-701C 2525M-702C 2525M-1001C 2525M-1002C 2525M-1501C 2525M-1502C	●	●	50 (25)	70 (∞)	8.1 (*5.1)	25	25	32	26	150	32													SF%L-501C	HH4X12	CPS-8V	LW-4	GVF% _R 350 ~ 450-...C GVF% _R 500 ~ 600-...C								
		●	●			8.1 (8.1)																			SF%L-502C					GVF% _R 350 ~ 450-...C GVF% _R 500 ~ 600-...C							
		●	●	70 (25)	100 (∞)	8.1 (*5.1)																			SF%L-701C					HH4X12	CPS-8V	LW-4	GVF% _R 350 ~ 450-...C GVF% _R 500 ~ 600-...C				
		●	●			8.1 (8.1)																			SF%L-702C									GVF% _R 350 ~ 450-...C GVF% _R 500 ~ 600-...C			
		●	●	100 (25)	150 (∞)	8.1 (*5.1)																			SF%L-1001C									HH4X12	CPS-8V	LW-4	GVF% _R 350 ~ 450-...C GVF% _R 500 ~ 600-...C
		●	●			8.1 (8.1)																			SF%L-1002C												
●		●	150 (25)	250 (∞)	8.1 (*5.1)	SF%L-1501C							HH4X12	CPS-8V	LW-4	GVF% _R 350 ~ 450-...C GVF% _R 500 ~ 600-...C																					
●		●			8.1 (8.1)	SF%L-1502C																			GVF% _R 350 ~ 450-...C GVF% _R 500 ~ 600-...C												

CDX shows available grooving depth.

The value () of External dia. of the groove (DAXX) is the maximum outer diameter value after the initial groove between DAXN ~ DAXX. (It is possible to widen the groove to infinity ∞).

The value () of External dia. of the groove (DAXN) is the minimum diameter of the boss which remains in the center when widening the groove width to a smaller value after the initial groove between DAXN ~ DAXX.

Standard toolholders are designed with the edge position 1.0 mm above the center. When using non-standard toolholders, set the edge position 1.0 mm above the center.

CDX shows the distance from the toolholder to the cutting edge. The grooving depth is the mentioned in ().

GFVS is composed of a base-holder and a blade. If the blade should be damaged, replace it with a new blade as listed in the table on G131.

(e.g.) GFVSR2020K-HB + SFR-351B = GFVSR2020K-351B

*GVF%_R400~450-040C: CDX is 6.6

GFVT (Face grooving)

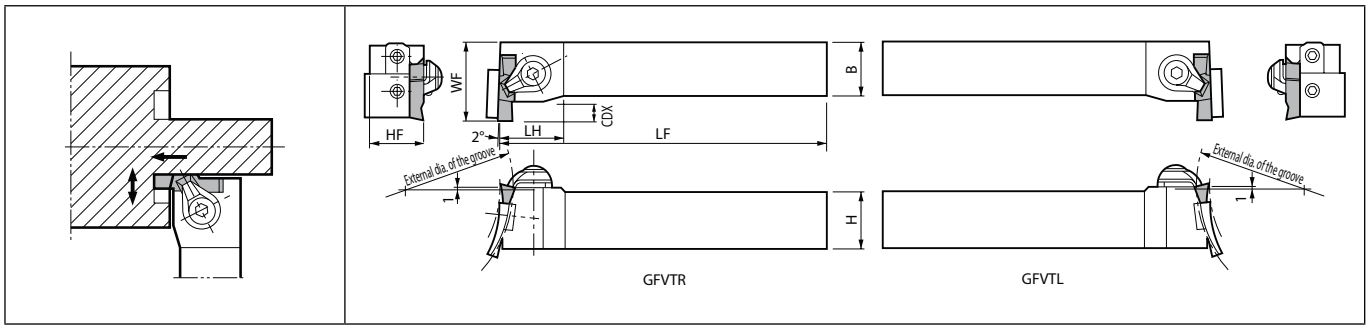

Left-hand Insert for Right-hand Toolholder, Right-hand Insert for Left-hand Toolholder.
This toolholder can machine various face grooving diameters by replacing the blade.

Toolholder dimensions

Description	Availability		External dia. of the groove (mm)		Dimension (mm)							Spare parts				Applicable inserts G126
												Blade	Bolt	Clamp set	Wrench	
	R	L	DAXN (min.)	DAXX (max.)	CDX	H	B	LH	HF	LF	WF					
GFVT ^{90°} 2020K-351B	●	●	35 (25)	50 (∞)	5.1 (4.6)	20	20	22	21	125	30	SF ^{90°} /L-351B	HH4X12	CPS-6V	LW-3	GVF ^{90°} /r250 ~ 350-...B GVF ^{90°} /r300-150BR GVF ^{90°} /r400 ~ 490-...B GVF ^{90°} /r400-200BR
2525M-351B	●	●				20	20	22	21	125	30					
2020K-352B	●	●			5.1 (5.1)	20	20	22	21	125	30	SF ^{90°} /L-352B				
2525M-352B	●	●				25	25	25	26	150	35					
2020K-501B	●	●	50 (25)	70 (∞)	5.1 (4.6)	20	20	22	21	125	30	SF ^{90°} /L-501B				
2525M-501B	●	●				25	25	25	26	150	35					
2020K-502B	●	●			5.1 (5.1)	20	20	22	21	125	30	SF ^{90°} /L-502B				
2525M-502B	●	●				25	25	25	26	150	35					
2020K-701B	●	●	70 (25)	100 (∞)	5.1 (4.6)	20	20	22	21	125	30	SF ^{90°} /L-701B				
2525M-701B	●	●				25	25	25	26	150	35					
2020K-702B	●	●			5.1 (5.1)	20	20	22	21	125	30	SF ^{90°} /L-702B				
2525M-702B	●	●				25	25	25	26	150	35					
GFVT ^{90°} 2525M-501C	●	●	50 (25)	70 (∞)	8.1 (*5.1)	25	25	27	26	150	38	SF ^{90°} /L-501C	HH4X12	CPS-8V	LW-4	GVF ^{90°} /r350 ~ 450-...C GVF ^{90°} /r500 ~ 600-...C GVF ^{90°} /r350 ~ 450-...C GVF ^{90°} /r500 ~ 600-...C GVF ^{90°} /r350 ~ 450-...C GVF ^{90°} /r500 ~ 600-...C GVF ^{90°} /r350 ~ 450-...C GVF ^{90°} /r500 ~ 600-...C GVF ^{90°} /r350 ~ 450-...C GVF ^{90°} /r500 ~ 600-...C
2525M-502C	●	●										8.1 (8.1)				
2525M-701C	●	●	70 (25)	100 (∞)	8.1 (*5.1)							SF ^{90°} /L-701C				
2525M-702C	●	●										8.1 (8.1)				
2525M-1001C	●	●	100 (25)	150 (∞)	8.1 (*5.1)							SF ^{90°} /L-1001C				
2525M-1002C	●	●										8.1 (8.1)				
2525M-1501C	●	●	150 (25)	250 (∞)	8.1 (*5.1)							SF ^{90°} /L-1501C				
2525M-1502C	●	●										8.1 (8.1)				

CDX shows available grooving depth.

The value () of External dia. of the groove (DAXX) is the maximum outer diameter value after the initial groove between DAXN ~ DAXX. (It is possible to widen the groove to infinity ∞).

The value () of External dia. of the groove (DAXN) is the minimum diameter of the boss which remains in the center when widening the groove width to a smaller value after the initial groove between DAXN ~ DAXX.

Standard toolholders are designed with the edge position 1.0 mm above the center. When using non-standard toolholders, set the edge position 1.0 mm above the center.

CDX shows the distance from the toolholder to the cutting edge. The grooving depth is the mentioned in ().

GFVT is composed of a base-holder and a blade. If the blade should be damaged, replace it with a new blade as listed in the table on G131.

(e.g.) GFVTR2020K-HB + SFR-351B = GFVTR2020K-351B

*GVF^{90°}/r400~450-040C: CDX is 6.6

● : Standard item R : Right-hand only L : Left-hand only □ : Check availability

Selection of Toolholder & Insert

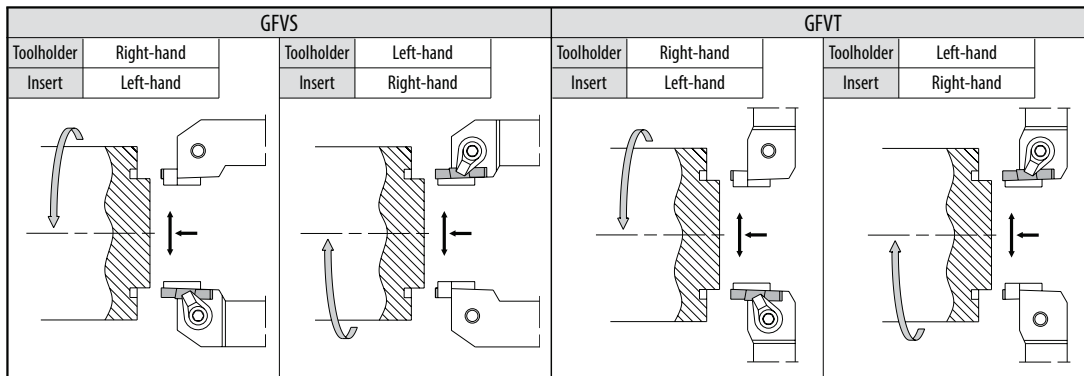

Combination of Base-Holder & Blade

Toolholder Description (Stamped below)	Stock		Blade Description	Toolholder Description (Unit Description)		Example of installation (GFVS)	How to refer to the face grooving toolholder and blade
	R	L					
GFVS ^{R/L} 2020K-HB GFVT ^{R/L} 2020K-HB	●	●	SF ^{R/L} -351B -352B -501B -502B -701B -702B	GFVS ^{R/L} 2020K	-351B		<p>Q : Though "GFVSR2525M-HC" is marked on the face grooving toolholder, the size of cutting dia. is unknown. How could it be found out?</p> <p>A : Take off the blade. Description of the blade is listed on the back of the blade. Using the description, check the description of the toolholder in the catalog. If "SFR-1001C" is integrated to "GFVSR2525M-HC", the description of the toolholder is "GVFSR2525M-1001C".</p>
				GFVT ^{R/L} 2020K	-352B		
					-501B		
					-502B		
					-701B		
					-702B		
GFVS ^{R/L} 2525M-HB GFVT ^{R/L} 2525M-HB	●	●	SF ^{R/L} -351B -352B -501B -502B -701B -702B	GFVS ^{R/L} 2525M	-351B		
				GFVT ^{R/L} 2525M	-352B		
					-501B		
					-502B		
					-701B		
					-702B		
GFVS ^{R/L} 2525M-HC GFVT ^{R/L} 2525M-HC	●	●	SF ^{R/L} -501C -502C -701C -702C -1001C -1002C -1501C -1502C	GFVS ^{R/L} 2525M	-501C		
				GFVT ^{R/L} 2525M	-502C		
					-701C		
					-702C		
					-1001C		
					-1002C		
					-1501C		
					-1502C		

• Right-hand Blade for Right-hand Toolholder, Left-hand Blade for Left-hand Toolholder.
• Installation of GFVT is also pursuing example of installation of GFVS.

Blade Dimensions

Shape	Description	Stock		Dimension (mm)				External dia. of the groove (mm)		Applicable Inserts	Applicable Toolholders
		R	L	L	H	T	W	DAXN (min.)	DAXX (max.)		
<p>Stamped side</p> <p>Top shape of 501C, 701C, 1001C, 1501C</p>	SF ^{R/L} -351B	●	●	30.5	11	4.7	2.0	35	50	GVF ^{R/L} 250~350-020B	GVF(S/T) ^{R/L} ○○○○□ -○○○B (Toolholder Stamp GVF(S/T) ^{R/L} ○○○○□-HB)
	SF ^{R/L} -352B	●	●							GVF ^{R/L} 300-150BR	
	SF ^{R/L} -501B	●	●							GVF ^{R/L} 400~490-020B	
	SF ^{R/L} -502B	●	●							GVF ^{R/L} 400-200BR	
	SF ^{R/L} -701B	●	●							GVF ^{R/L} 250~350-020B	
	SF ^{R/L} -702B	●	●							GVF ^{R/L} 300-150BR	
	SF ^{R/L} -501C	●	●	35	15	7.5	2.8	50	70	GVF ^{R/L} 400~490-020B	
	SF ^{R/L} -502C	●	●							GVF ^{R/L} 400-200BR	
	SF ^{R/L} -701C	●	●							GVF ^{R/L} 250~350-020B	
	SF ^{R/L} -702C	●	●							GVF ^{R/L} 300-150BR	
	SF ^{R/L} -1001C	●	●							GVF ^{R/L} 400~490-020B	
	SF ^{R/L} -1002C	●	●							GVF ^{R/L} 400-200BR	
SF ^{R/L} -1501C	●	●	35	20	7.5	2.8	70	100	GVF ^{R/L} 350~450-040C	GVF(S/T) ^{R/L} ○○○○□ -○○○C (Toolholder Stamp GVF(S/T) ^{R/L} ○○○○□-HC)	
SF ^{R/L} -1502C	●	●							GVF ^{R/L} 500~600-040C		
	●	●							GVF ^{R/L} 350~450-040C		
	●	●							GVF ^{R/L} 500~600-040C		
	●	●							GVF ^{R/L} 350~450-040C		
	●	●							GVF ^{R/L} 500~600-040C		

- Right-hand shown
- Right-hand Blade for Right-hand Toolholder, Left-hand Blade for Left-hand Toolholder.

External dia. of the groove of GFVS / GFVT

e.g.) GFVS^{R/L}...-351B/352B
 (same as GFVS^{R/L}...-○○○B, ...-○○○C → G129
 GFVT^{R/L}...-○○○B, ...-○○○C → G130)

Description	External dia. of the groove (mm)		Applicable inserts
	DAXN (min.)	DAXX (max.)	
GFVS ^{R/L} 2020K-351B	35	50	GVF ^{R/L} 250 ~ 350...B
2525M-351B			GVF ^{R/L} 300-150BR
2020K-352B			GVF ^{R/L} 400 ~ 490...B
2525M-352B			GVF ^{R/L} 400-200BR

● It is possible to widen the groove to infinity ∞ when machining the initial groove within DAXN ~ DAXX and then widening to outer diameter.

- When machining the initial groove on the face at DAXN ø35
- When machining the initial groove on the face at DAXX ø50

If the initial groove is made smaller than this, the toolholder interferes with the workpiece. Boss Dia. depends on insert width.

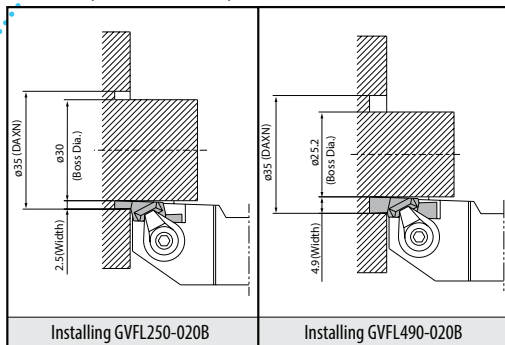

If the initial groove is made larger than this, the toolholder interferes with the workpiece. Boss Dia. depends on insert width.

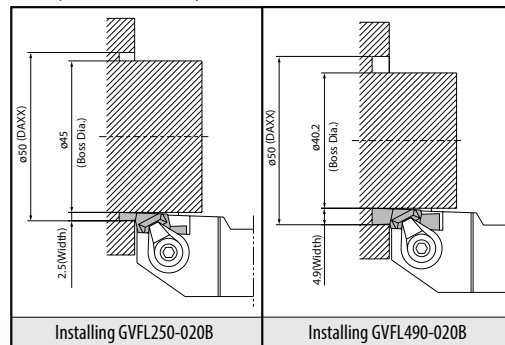

- When widening the groove width to inner diameter

ø25 Boss Dia. is the limitation regardless of insert width, even widening the groove width to the center from the initial groove at DAXN (ø35) or DAXX (ø50). The toolholder interferes with the workpiece when closer to the center.

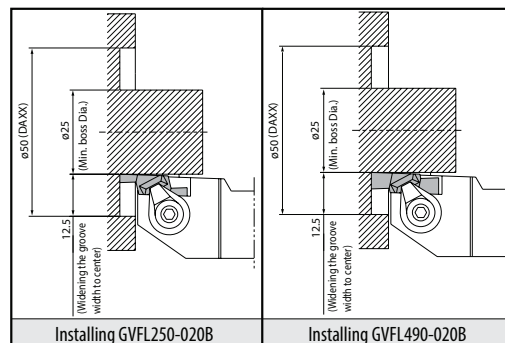
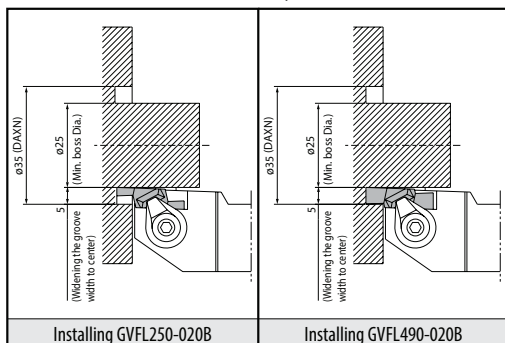

● : Standard item R : Right-hand only L : Left-hand only □ : Check availability

GIFV (Face grooving)

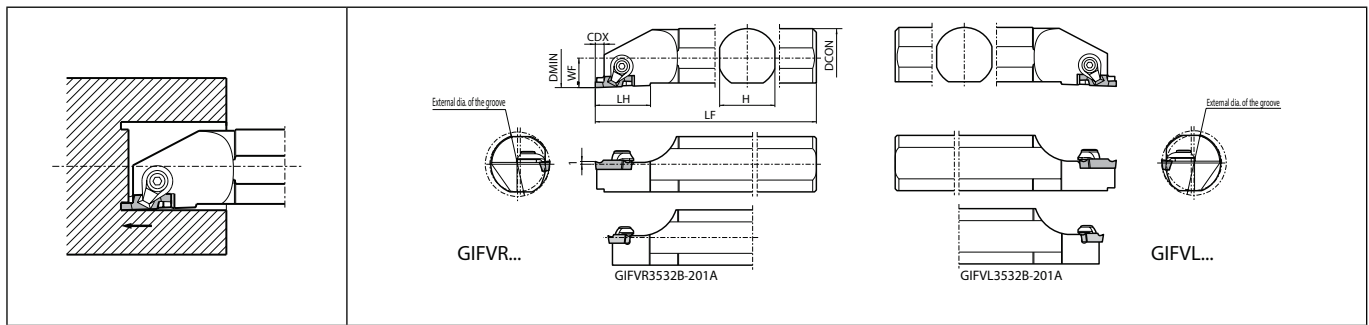

Right-hand Insert for Right-hand Toolholder, Left-hand Insert for Left-hand Toolholder.

Toolholder dimensions

Description	Availability		External dia. of the groove (mm)	Dimension (mm)										Spare parts				Applicable inserts G126
				R	L	DAXN (min.)	DAXX (max.)	DMIN	DCON	CDX	H	LH	LF	WF	Clamp set	Clamp set	Wrench	
GIFV ^{R/L} 3532B-201A	●	●	35 (12)	∞	35	32	2.2	30	23	250	16	CPS-5V	-	-	FT-15	GVF ^{R/L} ...A(R)		
GIFV ^{R/L} 3532B-351B 3532B-352B 5032B-501B 5032B-502B	●	●	35 (25)	∞	35	4.6	30	30	250	16	-	CPS-6V	LW-3	-	-	GVF ^{R/L} 250 ~ 350...B(R)		
	●	●				5.1										GVF ^{R/L} 400 ~ 490...B(R)		
	●	●	50 (25)	∞	50	4.6										GVF ^{R/L} 250 ~ 350...B(R)		
	●	●				5.1										GVF ^{R/L} 400 ~ 490...B(R)		
GIFV ^{R/L} 5032B-501C 5032B-502C	●	●	50 (25)	70	∞	50	6.6	30	35	250	16	-	CPS-8V	LW-4	-	GVF ^{R/L} 350 ~ 450-040C		
	●	●					8.1									GVF ^{R/L} 500 ~ 600-040C		

CDX shows available grooving depth.

Standard toolholders are designed with the edge position 1.0 mm above the center.

External dia. of the groove depends on the application.

Applications	Description	Internal dia. of the groove (min.)	External dia. of the groove		Remarks
			DAXN [min.]	DAXX [max.]	
	GIFV ^{R/L} 3532B-201A	-	35	∞	-
	GIFV ^{R/L} 3532B-351B			50	
	GIFV ^{R/L} 3532B-352B			∞	
	GIFV ^{R/L} 5032B-501B				
	GIFV ^{R/L} 5032B-502B				
GIFV ^{R/L} 5032B-501C	70				
GIFV ^{R/L} 5032B-502C	70				
	GIFV ^{R/L} 3532B-201A	12	35	∞	If $\phi D1 \geq 58-2CW$, the Face Grooving Dia. can be expanded to Internal dia. of the groove (min.) toward the Center. CW = Edge Width
	GIFV ^{R/L} 3532B-351B			50	
	GIFV ^{R/L} 3532B-352B			∞	
	GIFV ^{R/L} 5032B-501B				
	GIFV ^{R/L} 5032B-502B				
GIFV ^{R/L} 5032B-501C	70				
GIFV ^{R/L} 5032B-502C	70				
	GIFV ^{R/L} 3532B-201A	12	35	∞	-
	GIFV ^{R/L} 3532B-351B			50	
	GIFV ^{R/L} 3532B-352B			∞	
	GIFV ^{R/L} 5032B-501B				
	GIFV ^{R/L} 5032B-502B				
GIFV ^{R/L} 5032B-501C	70				
GIFV ^{R/L} 5032B-502C	70				



The value () of External dia. of the groove (max.) is the maximum outer diameter value after the initial groove between DAXN ~ DAXX (It is possible to widen the groove to infinity ∞).

The value () of Internal dia. of the groove (min.) is the minimum diameter of the boss which remains in the center when widening the groove width to a smaller value after the initial groove between DAXN ~ DAXX.

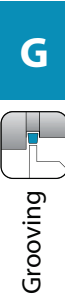
● : Standard item R : Right-hand only L : Left-hand only □ : Check availability



FMM/FMN

		Carbon steel / Alloy steel		Stainless steel		Cast iron		Non-ferrous metals		Titanium alloy		Hard materials (~ 40HRC)		Hard materials (40HRC ~)		
Insert	Description	No. of edges	Dimension (mm)				Tolerance (mm)		Carbide				Cermets	Applicable toolholder G135, G136		
			CW	S	RE	INSL	CW min.	CW max.	CVD		PVD					
									CP9025	PR905	PR915	PR930			KW10	TN90
 Chip control oriented / M class	FMM 30-03	1	3	3.5	0.3	12	-0.05	+0.05	●	●	●	●	●	●	●	KFMS%L...-3
	FMM 40-04	1	4	3.5	0.4	12	-0.05	+0.05	●	●	●	●	●	●	●	KFMS%L...-4
	FMM 50-04	1	5	3.5	0.4	12	-0.05	+0.05	●	●	●	●	●	●	●	KFMS%L...-5
	FMM 60-04	1	6	3.5	0.4	12	-0.05	+0.05	●	●	●	●	●	●	●	
 Sharp cutting oriented / M class	FMN 3	1	3	3.5	0.25	12	-0.05	+0.05	●		●	●	●	●	●	KFMS%L...-3
	FMN 4	1	4	3.5	0.25	12	-0.05	+0.05	●		●	●	●	●	●	KFMS%L...-4
	FMN 5	1	5	3.5	0.25	12	-0.05	+0.05	●		●	●	●	●	●	KFMS%L...-5
	FMN 6	1	6	3.5	0.25	12	-0.05	+0.05	●		●	●	●	●	●	

FMN inserts are only for Deep Grooving and not applicable for Turning.

Recommended cutting conditions

Workpiece material	Recommended insert grades (Vc: m/min)						Face grooving (FMM / FMN)			Turning (FMM)			Remarks
	Cermets		CVD coated carbide		PVD coated carbide		Edge width (mm)			Edge width (mm)			
	TN90	CP9025	PR915	PR930	PR905	KW10	3.0	4.0	5.0 / 6.0	3.0	4.0	5.0 / 6.0	
							f (mm/rev)			f (mm/rev)			
Carbon steel	☆ 100~220	☆ 80~200	☆ 80~200	★ 80~200	-	-	0.03~0.05	0.03~0.08	0.05~0.10	0.05~0.10	0.05~0.25	0.10~0.30	Coolant
Alloy steel	☆ 80~200	☆ 70~180	☆ 70~180	★ 70~180	-	-	0.03~0.05	0.03~0.08	0.05~0.10	0.05~0.10	0.05~0.25	0.10~0.30	
Stainless steel	☆ 70~160	☆ 60~150	★ 60~150	☆ 60~150	-	-	0.03~0.05	0.03~0.08	0.05~0.10	0.05~0.10	0.05~0.25	0.10~0.30	
Cast iron	-	-	-	-	★ 80~180	☆ 70~150	0.03~0.05	0.03~0.08	0.05~0.10	0.05~0.10	0.05~0.25	0.10~0.30	
Aluminum alloys	-	-	-	-	-	★ 200~500	0.03~0.05	0.03~0.08	0.05~0.10	0.05~0.10	0.05~0.25	0.10~0.30	
Brass	-	-	-	-	-	★ 100~200	0.03~0.05	0.03~0.08	0.05~0.10	0.05~0.10	0.05~0.25	0.10~0.30	

• Set the feed rate 1/100 of edge width on the first groove and check chip evacuation.

• FMN type Inserts are only for deep grooving, and when used for turning, set to ap = 0.2 mm and under.

★: 1st recommendation ☆: 2nd recommendation

Refer to the notes below for turning conditions

ap and f of FMM

	Recommended cutting conditions	
ap (MAX.) (mm)	under 50% of edge width	ap ≤ 0.5CW
f (MAX.) (mm/rev)	under 3~5% of edge width	f ≤ [0.03(Min.) ~ 0.05(Max.)]cw

ap x f should be as follows.

Load (mm ²)	Edge Width(mm)	3.0	4.0	5.0	6.0
ap x f		~0.09	~0.14	~0.25	~0.36

ap x f ≤ 0.01CW²

● : Standard item R : Right-hand only L : Left-hand only □ : Check availability

KFMS (Face grooving)

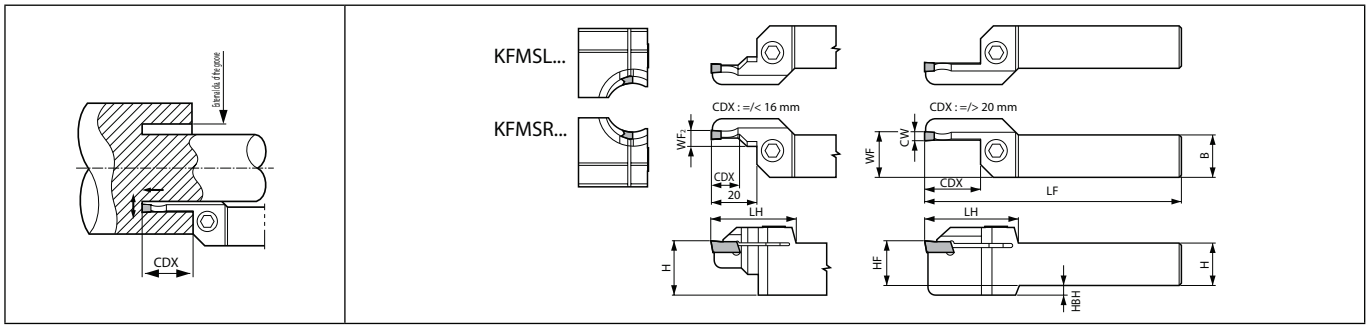

Toolholder dimensions

Description	Availability		External dia. of the groove (mm)		Dimension (mm)													Spare parts		Applicable inserts G134
					R	L	DAXN (min.)	DAXX (max.)	CDX	H	B	LH	HF	HBH	LF	WF	WF ₂	CW	Clamp bolt	
KFMS% 2020K2530-3 2020K3040-3 2020K4050-3 2020K5065-3 2020K6585-3 2020K85110-3 2020K110145-3	●		25	30	13	20	20	39	-	125	20.7	6.1	3	HH5X20	LW-4	FMM30-03 FMN3				
	●		30	40																
	●		40	50	22	20	20	41	20	-	125	20.7	6.1	3	HH5X20		LW-4			
	●		50	65																
	●		65	85	25	20	20	44	20	5	-	-	3	HH5X20	LW-4					
	●		85	110																
	●		110	145	13	25	25	41	25	-	150	25.7	6.1	3	HH5X25		LW-4			
	●	●	25	30																
●	●	30	40	22	25	25	44	25	-	150	25.7	6.1	3	HH5X25	LW-4					
●	●	40	50																	
●	●	50	65	25	25	25	44	25	-	150	25.7	6.1	3	HH5X25	LW-4					
●	●	65	85																	
●	●	85	110	12	20	20	39	-	125	20.7	7.1	4	HH5X20	LW-4	FMM40-04 FMN4					
●		25	30																	
●		30	40	25	25	25	44	20	-	125	20.7	7.1	4	HH5X20		LW-4				
●		40	50																	
●		50	70	25	25	25	44	20	5	-	-	4	HH5X20	LW-4						
●		70	100																	
●		100	150	12	25	25	39	-	150	25.7	7.1	4	HH5X25	LW-4						
●		150	220																	
●		150	220	20	25	25	44	-	150	25.7	-	4	HH5X25	LW-4						
●		220	∞																	
●	●	25	35	12	25	25	39	-	150	25.7	7.1	4	HH5X25	LW-4						
●	●	35	50																	
●	●	50	70	20	25	25	44	-	150	25.7	-	4	HH5X25	LW-4						
●	●	70	100																	
●	●	70	100	25	25	25	44	-	150	25.7	-	4	HH5X25	LW-4						
●	●	100	150																	
●	●	100	150	25	25	25	44	-	150	25.7	-	4	HH5X25	LW-4						
●	●	150	220																	
●	●	150	220	∞	25	25	44	-	150	25.7	-	4	HH5X25	LW-4						
●	●	220	∞																	







CDX shows available grooving depth.

External dia. of the groove : The diameter range of the initial groove.

● : Standard item R : Right-hand only L : Left-hand only □ : Check availability



Toolholder dimensions

Description	Availability		External dia. of the groove (mm)		Dimension (mm)										Spare parts		Applicable inserts ➔ G134		
	R	L	DAXN (min.)	DAXX (max.)	CDX	H	B	LH	HF	HBH	LF	WF	WF ₂	CW					
KFMS ^{R/L} 2020K2535-5 2020K3550-5 2020K5075-5 2020K75115-5 2020K115180-5 2020K180235-5 2020K235800-5	●		25	35	20			39		-	125	20.7 (21.2)			5	5 (6)			FMM50-04 FMN5 FMM60-04 FMN6
	●		35	50															
	●		50	75															
	●		75	115															
	●		115	180															
	●		180	235															
2525M2535-5 2525M3550-5 2525M5075-5 2525M75115-5 2525M115180-5 2525M180235-5 2525M235800-5	●	●	25	35	20			39		-	150	25.7 (26.2)			5 (6)			FMM50-04 FMN5 FMM60-04 FMN6	
	●	●	35	50															
	●	●	50	75															
	●	●	75	115															
	●	●	115	180															
	●	●	180	235															
●	●	235	∞																

CDX shows available grooving depth.
 External dia. of the groove : The diameter range of the initial groove.
 For KFMS^{R/L}...-5 toolholder can hold a 6 mm width insert. () value shows the dimension of a 6mm width insert.

G



Grooving

Selection of Toolholder & Insert

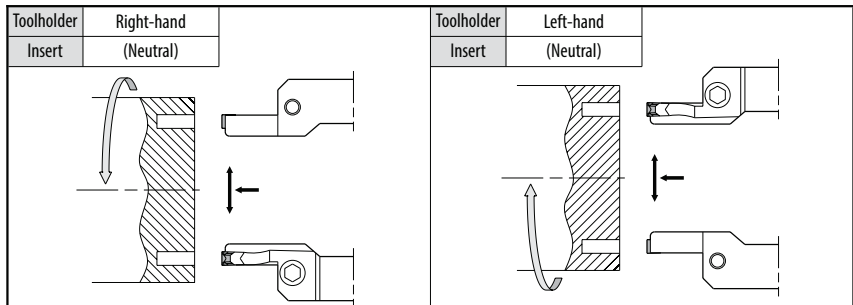



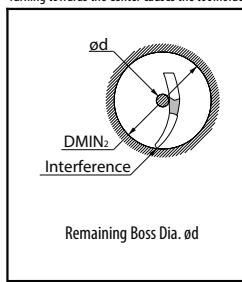

Limit of Turning toward Center

Turning towards the Center causes the toolholder to interfere with the groove wall depending on the initial cut's diameter.

Description	DMIN ₂			
	25	26	27	28 and over
	e.g.) KFMSR 2525M2530-3 with ø25 as first cut towards the center, it will cause a rubbing with the toolholder cartridge if ød is 4.0mm. *() value shows the Dimension using FMM60-04 Insert.			
	ød (mm)			
KFMS ^{R/L} 2020K2530-3	4	2	0	0
KFMS ^{R/L} 2525M2530-3				
KFMS ^{R/L} 2020K2535-4	6	3	0	(No remaining Boss)
KFMS ^{R/L} 2525M2535-4				
KFMS ^{R/L} 2020K2535-5	7	4	1	Boss)
KFMS ^{R/L} 2525M2535-5	*(5)	*(2)	*(0)	

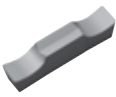
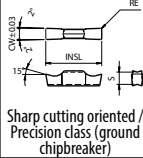
● : Standard item R : Right-hand only L : Left-hand only □ : Check availability

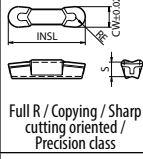
GMM/GMG/GMGA

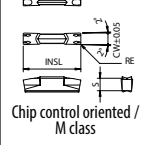
		Carbon steel / Alloy steel		Stainless steel		Cast iron		Non-ferrous metals		Titanium alloy		Hard materials (~ 40HRC)		Hard materials (40HRC ~)	
Insert	Description	No. of edges	Dimension (mm)				Tolerance (mm)		Carbide				Cermét	Applicable toolholder G138	
			CW	S	RE	INSL	CW min.	CW max.	CVD		PVD				
									CR9025	PR905	PR915	PR930			KW10
	 <p>GMG 8030-050MG</p> <p>Sharp cutting oriented / Precision class (ground chipbreaker)</p>	2	8	5.5	0.5	30	-0.03	+0.03	●	●	●	●	●		
	 <p>GMGA 8030-400R</p> <p>Full R / Copying / Sharp cutting oriented / Precision class</p>	2	8	5.5	4	30	-0.02	+0.02					●		
	 <p>GMM 8030-080MW</p> <p>Chip control oriented / M class</p>	2	8	5.5	0.8	30	-0.05	+0.05	●	●	●	●			

If using a full-R insert with KFMS-8 toolholder, you need to modify the corner of insert adapter of toolholder.

Recommended cutting conditions G143



Grooving

● : Standard item R : Right-hand only L : Left-hand only □ : Check availability

KFMS-8 (Face grooving)

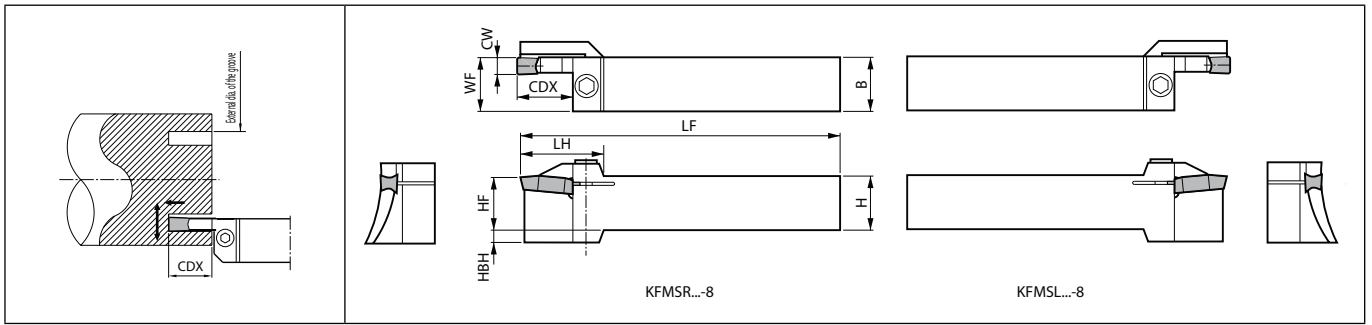

Toolholder dimensions

Description	Availability		External dia. of the groove (mm)		Dimension (mm)										Spare parts		Applicable inserts G137	
															Clamp bolt	Wrench		
	R	L	DAXN (min.)	DAXX (max.)	CDX	H	B	LH	HF	HBH	LF	WF	CW					
KFMS [®] /L 2525M5464-8 2525M6382-8 2525M80115-8 2525M105160-8 2525M155510-8 3232P155510-8	●	●	54 (0)	64 (∞)	25	25	25	41	25	6	150	26	8			GMG8030-050MG GMGA8030-400R GMM8030-080MW		
	●	●	63 (0)	82 (∞)													2.4	
	●	●	80 (0)	115 (∞)														
	●	●	105 (0)	160 (∞)				43	32	-							170	33
	●	●	155 (0)	510 (∞)														
	●							32	32									

CDX shows available grooving depth.

The value () of External dia. of the groove (DAXX) is the maximum outer diameter value after the initial groove between DAXN ~ DAXX. (It is possible to widen the groove to infinity ∞).

The value () of External dia. of the groove (DAXN) is the minimum diameter of the boss which remains in the center when widening the groove width to a smaller value after the initial groove between DAXN ~ DAXX.

● : Standard item R : Right-hand only L : Left-hand only □ : Check availability

FTK

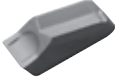
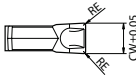
Insert		Description		No. of edges	Dimension (mm)		Tolerance (mm)		Carbide			Applicable toolholder ➔ G140
					CW	RE	CW min.	CW max.	CVD	PVD	-	
									CR9025	PR930	RW10	
 	FTK 4		1	4	0.25	-0.05	+0.05	●	●			KFTB®/...-4S
	FTK 5		1	5	0.25	-0.05	+0.05	●	●			

Recommended cutting conditions ➔ G146

● : Standard item R : Right-hand only L : Left-hand only □ : Check availability



Grooving

KFTB (Face grooving)

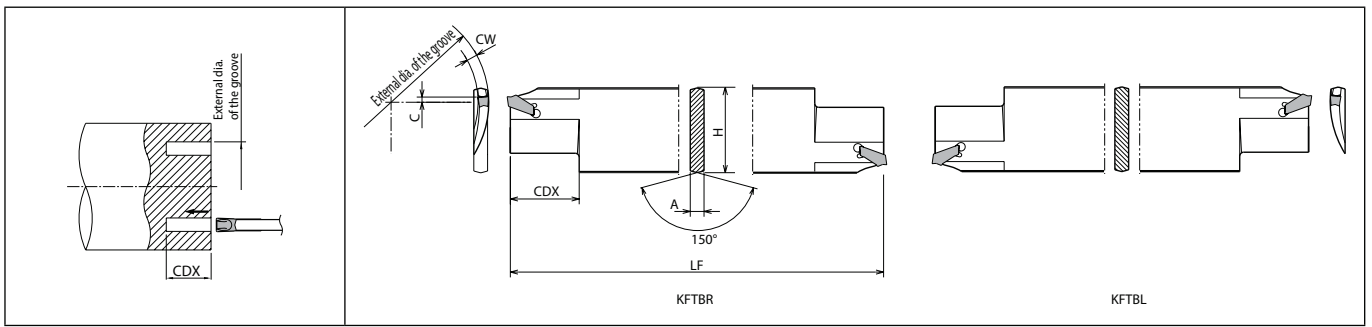

Toolholder dimensions

Description	Availability		External dia. of the groove (mm)		Dimension (mm)						Applicable inserts G139	Applicable tool block H50, H51
	R	L	DAXN (min.)	DAXX (max.)	CDX	H	A	C	LF	CW		
KFTB% 65100-4S 90150-4S 150250-4S 250800-4S	●	●	65	100	25	32	5.2	0	150	4	FTK4	KPKTB...32JCT KTKTB...32 KTKTBF...32
	●	●	90	150	30							
	●	●	140	250	30							
	●	●	230	∞	30							
KFTB% 90150-5S 150250-5S 250800-5S	●	●	90	150	30	32	5.2	0	150	5	FTK5	
	●	●	150	250	32							
	●	●	250	∞	38							

CDX shows available grooving depth.
 External dia. of the groove : The diameter range of the initial groove.
 The insert has Self-Clamping system and it is not suitable for tight tolerance grooves (tolerance±0.05mm).
 Lightly tap an Insert with a Plastic hammer. (End of insert does not touch toolholder.)
 KFTB%65100-4S toolholder is designed with the edge position 4 mm above the Center.
 Dimension H shows virtual apex distance.

Selection of Blade and Insert

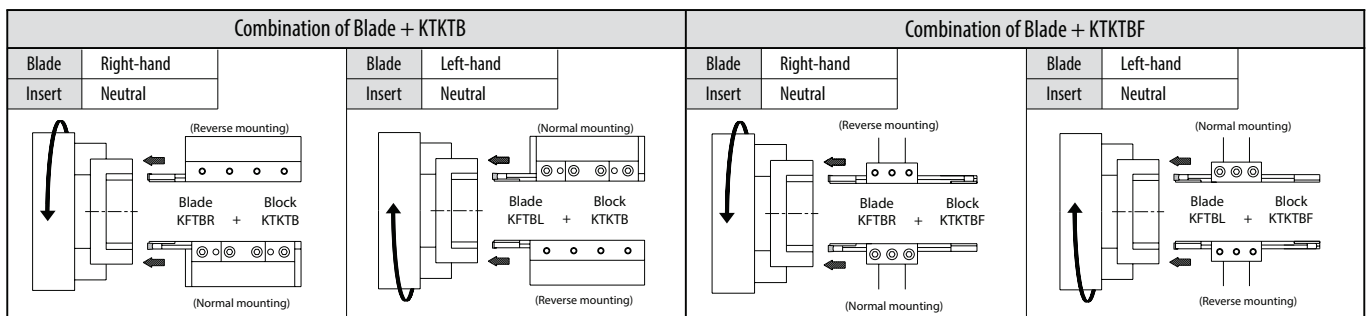

● : Standard item R : Right-hand only L : Left-hand only □ : Check availability

GBA inserts - ground chipbreaker

Workpiece material	Recommended insert grades (Vc: m/min)											(1) f for grooving (mm/rev) (2) f for turning (mm/rev) (3) ap for turning (mm)					Remarks	
	MEGACOAT cermet		Cemet			MEGACOAT		PVD coated carbide		Carbide	CBN	PCD	GBA○○○%L 033~120...	GBA○○○%L 125~225...	GBA○○○%L 230~325...	GBA○○○%L 330~350...		GBA○○○%L 400~480...
	PV7040	TN620	TC40	TN90	PR1215	PR1625	PR930	PR905	KW10	KBNS10 KBNS25	KP0001 (KP0010)							
Carbon steel	☆ 150~240	★ 80~220	☆ 150~220	☆ 150~220	★ 80~200	★ 80~180	☆ 80~180	-	-	-	-	(1) 0.03~0.08 (2) Not recom. (3) Max. 0.3	(1) 0.04~0.09 (2) 0.04~0.09 (3) Max. 0.3	(1) 0.05~0.1 (2) 0.05~0.1 (3) Max. 0.5	(1) 0.05~0.12 (2) 0.05~0.1 (3) Max. 0.5	(1) 0.05~0.12 (2) 0.05~0.1 (3) Max. 0.8		
Alloy steel	☆ 130~220	★ 80~200	☆ 130~200	☆ 130~200	★ 80~180	★ 80~160	☆ 80~160	-	-	-	-	(1) 0.03~0.07 (2) Not recom. (3) Max. 0.3	(1) 0.04~0.08 (2) 0.04~0.08 (3) Max. 0.3	(1) 0.05~0.09 (2) 0.05~0.09 (3) Max. 0.5	(1) 0.05~0.1 (2) 0.05~0.1 (3) Max. 0.5	(1) 0.05~0.1 (2) 0.05~0.1 (3) Max. 0.8		
Stainless steel	-	-	-	☆ 70~150	☆ 60~150	★ 60~130	☆ 60~130	-	-	-	-	(1) 0.03~0.07 (2) Not recom. (3) Not recom.	(1) 0.04~0.08 (2) 0.04~0.08 (3) Max. 0.3	(1) 0.05~0.09 (2) 0.05~0.09 (3) Max. 0.5	(1) 0.05~0.1 (2) 0.05~0.1 (3) Max. 0.5	(1) 0.05~0.1 (2) 0.05~0.1 (3) Max. 0.8		
Cast iron	-	-	-	-	-	-	-	★ 80~180	☆ 60~120	★ 150~400	-	(1) 0.03~0.08 (2) Not recom. (3) Not recom.	(1) 0.04~0.09 (2) 0.04~0.09 (3) Max. 0.3	(1) 0.05~0.1 (2) 0.05~0.1 (3) Max. 0.5	(1) 0.05~0.12 (2) 0.05~0.1 (3) Max. 0.5	(1) 0.05~0.12 (2) 0.05~0.1 (3) Max. 0.8		
Aluminum alloys	-	-	-	-	-	-	-	-	★ 150~400	-	★ 150~2,000	(1) 0.05~0.12 (2) Not recom. (3) Not recom.	(1) 0.05~0.15 (2) 0.05~0.15 (3) Max. 0.5	(1) 0.05~0.15 (2) 0.05~0.15 (3) Max. 0.8	(1) 0.08~0.15 (2) 0.08~0.15 (3) Max. 0.8	(1) 0.08~0.15 (2) 0.08~0.15 (3) Max. 0.8		
Brass	-	-	-	-	-	-	-	-	★ 150~300	-	★ 200~800	(1) 0.05~0.12 (2) Not recom. (3) Not recom.	(1) 0.05~0.15 (2) 0.05~0.15 (3) Max. 0.5	(1) 0.05~0.15 (2) 0.05~0.15 (3) Max. 0.8	(1) 0.08~0.15 (2) 0.08~0.15 (3) Max. 0.8	(1) 0.08~0.15 (2) 0.08~0.15 (3) Max. 0.8		
Hard materials	-	-	-	-	-	-	-	-	-	★ 80~120	-	-	(1) 0.02~0.05 (2) Not recom. (3) Not recom.	(1) 0.03~0.07 (2) 0.01~0.04 (3) Max. 0.1	-	-		

* Above cutting condition is for external grooving. Set both cutting speed and feed 10% lower for internal grooving.

★:1st recommendation ☆:2nd recommendation

GBA inserts - GM chipbreaker

Workpiece material	Recommended insert grades (Vc: m/min)			(1) f for grooving (mm/rev) (2) f for turning (mm/rev) (3) ap for turning (mm)					Remarks
	Cermet	MEGACOAT NANO	MEGACOAT	GBA43%L 140-010GM	GBA43%L 150-020GM	GBA43%L 175-020GM~230-020GM	GBA43%L 250-030GM~350-030GM	GBA43%L 400-040GM	
	TN620	PR1625	PR1215						
Carbon steel	★ 80~240	★ 80~220	☆ 80~220	(1) 0.03~0.1 (2) 0.03~0.08 (3) Max. 0.2	(1) 0.03~0.12 (2) 0.03~0.08 (3) Max. 0.3	(1) 0.03~0.12 (2) 0.03~0.09 (3) Max. 0.3	(1) 0.04~0.15 (2) 0.05~0.1 (3) Max. 0.5	(1) 0.05~0.15 (2) 0.05~0.1 (3) Max. 0.8	
Alloy steel	★ 80~220	★ 80~200	☆ 80~200	(1) 0.03~0.1 (2) 0.03~0.08 (3) Max. 0.2	(1) 0.03~0.12 (2) 0.03~0.08 (3) Max. 0.3	(1) 0.03~0.12 (2) 0.03~0.09 (3) Max. 0.3	(1) 0.04~0.15 (2) 0.05~0.1 (3) Max. 0.5	(1) 0.05~0.15 (2) 0.05~0.1 (3) Max. 0.8	
Stainless steel	-	★ 60~150	☆ 60~150	(1) 0.03~0.1 (2) 0.03~0.08 (3) Max. 0.2	(1) 0.03~0.1 (2) 0.03~0.08 (3) Max. 0.3	(1) 0.03~0.1 (2) 0.03~0.09 (3) Max. 0.3	(1) 0.04~0.12 (2) 0.05~0.1 (3) Max. 0.5	(1) 0.04~0.12 (2) 0.05~0.1 (3) Max. 0.8	

* Above cutting condition is for external grooving. Set both cutting speed and feed 20% lower for internal grooving.

★:1st recommendation ☆:2nd recommendation

GBA inserts - MY chipbreaker

Workpiece material	Recommended insert grades (Vc: m/min)		(1) f for grooving (mm/rev) (2) f for turning (mm/rev) (3) ap for turning (mm)					Remarks
	Cermet		GBA43%L 175-020MY~200-020MY	GBA43%L 230-020MY~265-030MY	GBA43%L 300-030MY	GBA43%L 330-030MY~350-030MY	GBA43%L 400-040MY	
	TN6020							
Carbon steel	☆ 150~220		(1) 0.03~0.08 (2) 0.03~0.08 (3) Max. 0.3	(1) 0.04~0.09 (2) 0.04~0.09 (3) Max. 0.3	(1) 0.05~0.1 (2) 0.05~0.1 (3) Max. 0.5	(1) 0.05~0.12 (2) 0.05~0.1 (3) Max. 0.5	(1) 0.05~0.12 (2) 0.05~0.1 (3) Max. 0.8	
Alloy steel	☆ 130~200		(1) 0.03~0.07 (2) 0.03~0.1 (3) Max. 0.3	(1) 0.04~0.08 (2) 0.04~0.08 (3) Max. 0.3	(1) 0.05~0.09 (2) 0.05~0.09 (3) Max. 0.5	(1) 0.05~0.1 (2) 0.05~0.1 (3) Max. 0.5	(1) 0.05~0.1 (2) 0.05~0.1 (3) Max. 0.8	
Stainless steel	☆ 70~150		(1) 0.03~0.07 (2) 0.03~0.1 (3) Max. 0.3	(1) 0.04~0.08 (2) 0.04~0.08 (3) Max. 0.3	(1) 0.05~0.09 (2) 0.05~0.09 (3) Max. 0.5	(1) 0.05~0.1 (2) 0.05~0.1 (3) Max. 0.5	(1) 0.05~0.1 (2) 0.05~0.1 (3) Max. 0.8	

* Above cutting condition is for external grooving. Set both cutting speed and feed 10% lower for internal grooving.

★:1st recommendation ☆:2nd recommendation



Grooving

Recommended cutting conditions

GBF

Workpiece material	Recommended insert grades (Vc: m/min)			(1) f for grooving (mm/rev)				Remarks
	MEGACOAT	MEGACOAT NANO	Carbide	(2) f for turning (mm/rev)				
	PR1215	PR1535	GW15	(3) ap for turning (mm)				
				GBF32 [®] /L 025 – 053	GBF32 [®] /L 065 – 095	GBF32 [®] /L 100 – 145	GBF3 [®] /L 150 – 300	
Carbon steel	★ 80~180	☆ 70~160	-	(1) 0.01~0.05	(1) 0.02~0.07	(1) 0.03~0.08	(1) 0.03~0.08	
				(2) Not recom.	(2) Not recom.	(2) 0.03~0.06	(2) 0.03~0.06	
				(3) Not recom.	(3) Not recom.	(3) Max. 0.2	(3) Max. 0.2	
Alloy steel	★ 80~180	☆ 70~160	-	(1) 0.01~0.04	(1) 0.02~0.06	(1) 0.03~0.07	(1) 0.03~0.07	
				(2) Not recom.	(2) Not recom.	(2) 0.02~0.05	(2) 0.02~0.05	
				(3) Not recom.	(3) Not recom.	(3) Max. 0.2	(3) Max. 0.2	
Stainless steel	☆ 60~130	★ 50~120	-	(1) 0.01~0.04	(1) 0.02~0.06	(1) 0.03~0.07	(1) 0.03~0.07	
				(2) Not recom.	(2) Not recom.	(2) 0.02~0.05	(2) 0.02~0.05	
				(3) Not recom.	(3) Not recom.	(3) Max. 0.2	(3) Max. 0.2	
Cast iron	-	-	★ 60~100	(1) 0.01~0.05	(1) 0.02~0.07	(1) 0.03~0.08	(1) 0.03~0.08	
				(2) Not recom.	(2) Not recom.	(2) 0.03~0.06	(2) 0.03~0.06	
				(3) Not recom.	(3) Not recom.	(3) Max. 0.2	(3) Max. 0.2	
Aluminum	-	-	★ 150~400	(1) 0.01~0.05	(1) 0.02~0.07	(1) 0.03~0.08	(1) 0.03~0.08	
				(2) Not recom.	(2) Not recom.	(2) 0.03~0.06	(2) 0.03~0.06	
				(3) Not recom.	(3) Not recom.	(3) Max. 0.2	(3) Max. 0.2	
Brass	-	-	★ 150~300	(1) 0.01~0.04	(1) 0.02~0.06	(1) 0.03~0.07	(1) 0.03~0.07	
				(2) Not recom.	(2) Not recom.	(2) 0.02~0.05	(2) 0.02~0.05	
				(3) Not recom.	(3) Not recom.	(3) Max. 0.2	(3) Max. 0.2	

★:1st recommendation ☆:2nd recommendation

GBF-000F inserts (RE=0.00)

Workpiece Material	Recommended insert grades (Vc: m/min)			(1) f for grooving (mm/rev)				Remarks
	MEGACOAT	MEGACOAT NANO	Carbide	(2) f for turning (mm/rev)				
	PR1215	PR1535	GW15	(3) ap for turning (mm)				
				GBF32 [®] /L 025 ~ 053 - 000F	GBF32 [®] /L 065 ~ 095 - 000F	GBF32 [®] /L 100 ~ 145 - 000F	GBF32 [®] /L 150 ~ 200 - 000F	
Carbon steel	★ 80 ~ 180	☆ 70 ~ 160	-	(1) 0.005~0.03	(1) 0.01~0.04	(1) 0.01~0.05	(1) 0.01~0.05	
				(2) Not recom.	(2) Not recom.	(2) 0.01~0.04	(2) 0.01~0.04	
				(3) Not recom.	(3) Not recom.	(3) MAX. 0.2	(3) MAX. 0.2	
Alloy steel	★ 80 ~ 180	☆ 70 ~ 160	-	(1) 0.005~0.025	(1) 0.01~0.03	(1) 0.01~0.04	(1) 0.01~0.04	
				(2) Not recom.	(2) Not recom.	(2) 0.01~0.03	(2) 0.01~0.03	
				(3) Not recom.	(3) Not recom.	(3) MAX. 0.2	(3) MAX. 0.2	
Stainless steel	☆ 60 ~ 130	★ 50 ~ 120	-	(1) 0.005~0.02	(1) 0.01~0.025	(1) 0.01~0.03	(1) 0.01~0.03	
				(2) Not recom.	(2) Not recom.	(2) 0.01~0.025	(2) 0.01~0.025	
				(3) Not recom.	(3) Not recom.	(3) MAX. 0.2	(3) MAX. 0.2	
Cast iron	-	-	★ 60 ~ 100	(1) 0.005~0.03	(1) 0.01~0.04	(1) 0.01~0.05	(1) 0.01~0.05	
				(2) Not recom.	(2) Not recom.	(2) 0.01~0.04	(2) 0.01~0.04	
				(3) Not recom.	(3) Not recom.	(3) MAX. 0.2	(3) MAX. 0.2	
Aluminum	-	-	★ 150 ~ 400	(1) 0.005~0.03	(1) 0.01~0.04	(1) 0.01~0.05	(1) 0.01~0.05	
				(2) Not recom.	(2) Not recom.	(2) 0.01~0.04	(2) 0.01~0.04	
				(3) Not recom.	(3) Not recom.	(3) MAX. 0.2	(3) MAX. 0.2	
Brass	-	-	★ 150 ~ 300	(1) 0.01~0.03	(1) 0.01~0.04	(1) 0.01~0.05	(1) 0.01~0.05	
				(2) Not recom.	(2) Not recom.	(2) 0.01~0.04	(2) 0.01~0.04	
				(3) Not recom.	(3) Not recom.	(3) MAX. 0.2	(3) MAX. 0.2	

★:1st recommendation ☆:2nd recommendation

GBF-GL inserts

Workpiece Material	Recommended insert grades (Vc: m/min)		(1) f for grooving (mm/rev)				Remarks
	MEGACOAT	MEGACOAT NANO	(2) f for turning (mm/rev)				
	PR1215	PR1535	(3) ap for turning (mm)				
			GBF32R075 - 005GL	GBF32R095 - 100-005GL	GBF32R150 - 200-010GL	GBF32R300 - 010GL	
Carbon Steel	★ 80 ~ 180	☆ 70 ~ 160	(1) 0.02~0.07	(1) 0.03~0.08	(1) 0.03~0.08	(1) 0.04~0.1	
			(2) Not recom.	(2) 0.03~0.06	(2) 0.03~0.06	(2) 0.04~0.08	
			(3) Not recom.	(3) MAX. 0.2	(3) MAX. 0.3	(3) MAX. 0.5	
Alloy Steel	★ 80 ~ 180	☆ 70 ~ 160	(1) 0.02~0.06	(1) 0.03~0.07	(1) 0.03~0.07	(1) 0.04~0.09	
			(2) Not recom.	(2) 0.03~0.06	(2) 0.03~0.06	(2) 0.04~0.08	
			(3) Not recom.	(3) MAX. 0.2	(3) MAX. 0.3	(3) MAX. 0.5	
Stainless Steel	☆ 60 ~ 130	★ 50 ~ 120	(1) 0.02~0.06	(1) 0.03~0.07	(1) 0.03~0.07	(1) 0.04~0.09	
			(2) Not recom.	(2) 0.03~0.06	(2) 0.03~0.06	(2) 0.04~0.08	
			(3) Not recom.	(3) MAX. 0.2	(3) MAX. 0.3	(3) MAX. 0.5	

★:1st recommendation ☆:2nd recommendation

G

Grooving

GMG / GMM / GMN / GMGA

Workpiece material	Recommended insert grades (Vc: m/min)						Grooving				Turning				Remarks
	Cermet TN90	CVD coated carbide CP9025	PVD coated carbide			Carbide KW10	Edge width (mm)				Edge width (mm)				
			PR915	PR930	PR905		2.0~3.0	4.0	5.0	6.0 / 8.0	2.0~3.0	4.0	5.0	6.0 / 8.0	
							f (mm/rev)				f (mm/rev)				
Carbon steel	☆ 100~220	☆ 80~200	☆ 80~200	★ 80~200	-	-	0.05~0.15	0.10~0.25	0.15~0.35	0.20~0.35	0.10~0.20	0.15~0.30	0.20~0.40	0.25~0.40	Coolant
Alloy steel	☆ 80~200	☆ 70~180	☆ 70~180	★ 70~180	-	-	0.05~0.15	0.10~0.25	0.15~0.35	0.20~0.35	0.10~0.20	0.15~0.30	0.20~0.40	0.25~0.40	
Stainless steel	☆ 70~160	☆ 60~150	★ 60~150	☆ 60~150	-	-	0.05~0.15	0.10~0.20	0.15~0.35	0.20~0.35	0.10~0.20	0.15~0.25	0.20~0.40	0.25~0.40	
Cast iron	-	-	-	-	★ 100~200	☆ 70~150	0.05~0.20	0.10~0.30	0.15~0.40	0.20~0.40	0.10~0.25	0.15~0.35	0.20~0.45	0.25~0.45	
Aluminum alloys	-	-	-	-	-	★ 200~500	0.05~0.20	0.08~0.25	0.10~0.25	0.12~0.30	0.10~0.20	0.10~0.25	0.10~0.25	0.15~0.30	
Brass	-	-	-	-	-	★ 100~200	0.05~0.15	0.08~0.20	0.10~0.25	0.12~0.30	0.10~0.20	0.10~0.25	0.10~0.25	0.15~0.30	

★:1st recommendation ☆:2nd recommendation

Refer to the notes below for turning conditions

1. When using KGM toolholder

	Recommended cutting conditions	
ap (MAX.) (mm)	80% or under of edge width	ap ≤ 0.8CW
f (MAX.) (mm/rev)	10% or under of edge width	f ≤ 0.1CW

(ap) x (f) shall not exceed 1/2 of ap (MAX.) x f (MAX.)

Load(mm ²)	Edge width(mm)	2.0~2.5	3.0	4.0	5.0	6.0	8.0
ap x f		~0.20	~0.36	~0.64	~1.00	~1.44	~2.56

$$ap \times f \leq \frac{1}{2} \times 0.8CW \times 0.1CW = 0.04CW^2$$

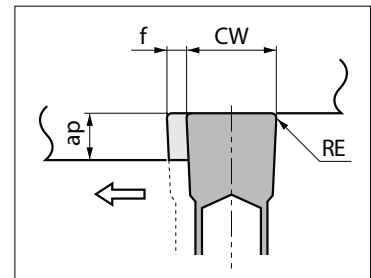

2. When using KGM-T toolholder (Deep grooving type) - use 90% of KGM conditions

3. When using KGMM / KGMS / KFMS-8 Toolholder

	Recommended cutting conditions	
ap (MAX.) (mm)	50% or under of edge width	ap ≤ 0.5CW
f (MAX.) (mm/rev)	4% or under of edge width	f ≤ 0.04CW

(ap) x (f) should be as follows. (50% or under of KGM)

Load(mm ²)	Edge width(mm)	2.0~2.5	3.0	4.0	5.0	6.0	8.0
ap x f		~0.10	~0.18	~0.32	~0.50	~0.72	~1.28

$$ap \times f \leq 0.02CW^2$$

4. When using KIGM toolholder

	Recommended cutting conditions	
ap (MAX.) (mm)	70% or under of Edge Width	ap ≤ 0.7CW
f (MAX.) (mm/rev)	8% or under of Edge Width	f ≤ 0.08CW

(ap) x (f) should be as follows: 70% or under of KGM

Load(mm ²)	Edge width(mm)	3.0	4.0	5.0
ap x f		~0.25	~0.44	~0.70

$$ap \times f \leq 0.04CW^2$$

GMG / GMM / GMGA 8030 - face grooving

Workpiece material	Recommended insert grades (Vc: m/min)						Face grooving		Turning		Remarks
	Cermet TN90	CVD coated carbide CP9025	PVD coated carbide			Carbide KW10	Edge width (mm)		Edge width (mm)		
			PR915	PR930	PR905		8.0		8.0		
							f (mm/rev)		f (mm/rev)		
Carbon steel	☆ 100~220	☆ 80~160	☆ 80~160	★ 80~160	-	-	0.1~0.2		0.1~0.25		Coolant
Alloy steel	☆ 80~160	☆ 70~160	☆ 70~160	★ 70~160	-	-	0.1~0.2		0.1~0.25		
Stainless steel	☆ 70~140	☆ 60~130	★ 60~130	☆ 60~130	-	-	0.1~0.2		0.1~0.25		
Cast iron	-	-	-	-	★ 80~180	☆ 70~130	0.1~0.3		0.1~0.35		
Aluminum alloys	-	-	-	-	-	★ 200~300	0.08~0.25		0.08~0.30		
Brass	-	-	-	-	-	★ 100~150	0.08~0.25		0.08~0.30		

★:1st recommendation ☆:2nd recommendation

Recommended cutting conditions

EZG

Workpiece material	Insert grades (Vc : m/min)		EZGR030030-...S	EZG%040040-... EZG%050050-... EZG%040040-...S EZG%050050-...S	EZG%060060-... EZG%070070-... EZG%080070-... EZG%060060-...S EZG%070070-...S EZG%080070-...S	Remarks
	MEGACOAT	Carbide				
	PR1225	GW05				
Carbon steel / Alloy steel	★ 30~100	-	~0.02	~0.03	~0.05	Coolant
Stainless steel	★ 30~80	-	~0.01	~0.02	~0.03	
Non-ferrous metals	-	★ ~300	-	~0.05	~0.08	

★ :1st recommendation

G

VNG

Workpiece material	Recommended insert grades (Vc : m/min)			VNG04 VNG05	VNG06 VNG07	Remarks
	MEGACOAT	PVD Coated carbide	Carbide			
	PR1225	PR930	KW10			
Carbon steel / Alloy steel	★ 30~100	☆ 30~100		~0.03	~0.05	Coolant
Stainless steel	★ 30~80	☆ 30~80		~0.02	~0.03	
Non-ferrous metals			★ ~300	~0.05	~0.08	

★ :1st recommendation ☆ :2nd recommendation

SIGC

Workpiece material	Recommended insert grades (Vc : m/min)		(1) f for grooving (mm/rev)			Remarks
	MEGACOAT NANO PLUS	MEGACOAT NANO	(2) f for turning (mm/rev)			
	PR1725	PR1535	(3) ap for turning (mm)			
Carbon steel	★ 50~80	☆ 50~80	GC08 [®] /L...	GC10 [®] /L, GC12 [®] /L 100 ~ 200...	GC10 [®] /L, GC12 [®] /L 250 ~ 300...	Coolant
			(1) 0.01~0.03	(1) 0.02~0.04	(1) 0.02~0.04	
			(2) 0.01~0.03	(2) 0.02~0.04	(2) 0.02~0.04	
(3) Max. 0.05	(3) Max. 0.05	(3) Max. 0.1				
Alloy steel	★ 50~80	☆ 50~80	(1) 0.01~0.03	(1) 0.02~0.04	(1) 0.02~0.04	
			(2) 0.01~0.03	(2) 0.02~0.04	(2) 0.02~0.04	
			(3) Max. 0.05	(3) Max. 0.05	(3) Max. 0.1	
Stainless steel	☆ 50~80	★ 50~80	(1) 0.01~0.03	(1) 0.01~0.03	(1) 0.01~0.03	
			(2) 0.01~0.03	(2) 0.01~0.03	(2) 0.01~0.03	
			(3) Max. 0.05	(3) Max. 0.05	(3) Max. 0.1	

★ :1st recommendation ☆ :2nd recommendation

Ground chipbreaker: GE^β/...A(R), GE^β/...B(R)

Workpiece material	Recommended insert grades (Vc: m/min)				(1) f for grooving (mm/rev)			Remarks
	Cermet	MEGACOAT	PVD coated carbide	Carbide	(2) f for turning (mm/rev)			
					(3) ap for turning (mm)			
					GE ^β /L 100~200-010A 100~200-100AR	GE ^β /L 100~200-010B 100~200-100BR	GE ^β /L 250~300-020B	
Carbon steel	☆ 50~80	★ 50~80	☆ 50~80	-	(1) 0.01~0.03 (2) 0.01~0.03 (3) Max. 0.05	(1) 0.02~0.04 (2) 0.02~0.04 (3) Max. 0.05	(1) 0.02~0.04 (2) 0.02~0.04 (3) Max. 0.1	
Alloy steel	☆ 50~80	★ 50~80	☆ 50~80	-	(1) 0.01~0.03 (2) 0.01~0.03 (3) Max. 0.05	(1) 0.02~0.04 (2) 0.02~0.04 (3) Max. 0.05	(1) 0.02~0.04 (2) 0.02~0.04 (3) Max. 0.1	
Stainless steel	-	★ 50~80	☆ 50~80	-	(1) 0.01~0.03 (2) 0.01~0.03 (3) Max. 0.05	(1) 0.01~0.03 (2) 0.01~0.03 (3) Max. 0.05	(1) 0.01~0.03 (2) 0.01~0.03 (3) Max. 0.1	
Cast iron	-	-	-	★ 50~80	(1) 0.01~0.03 (2) 0.01~0.03 (3) Max. 0.05	(1) 0.02~0.04 (2) 0.02~0.04 (3) Max. 0.05	(1) 0.02~0.04 (2) 0.02~0.04 (3) Max. 0.1	
Aluminum	-	-	-	★ 50~100	(1) 0.01~0.03 (2) 0.01~0.03 (3) Max. 0.1	(1) 0.02~0.04 (2) 0.02~0.04 (3) Max. 0.1	(1) 0.02~0.04 (2) 0.02~0.04 (3) Max. 0.2	
Brass	-	-	-	★ 50~100	(1) 0.01~0.03 (2) 0.01~0.03 (3) Max. 0.1	(1) 0.02~0.04 (2) 0.02~0.04 (3) Max. 0.1	(1) 0.02~0.04 (2) 0.02~0.04 (3) Max. 0.2	

* Use PVD coated grade or carbide for turning with edge width 1mm. (GE^β/L 100-005A / 100-005B) ★:1st recommendation ☆:2nd recommendation

Ground chipbreaker: GE^β/...C(R), GE^β/...D(R), GE^β/...E

Workpiece material	Recommended insert grades (Vc: m/min)				(1) f for grooving (mm/rev)						Remarks
	Cermet	MEGACOAT	PVD coated carbide	Carbide	(2) f for turning (mm/rev)						
					(3) ap for turning (mm)						
					GE ^β /L 100~200-010C 200-100CR	GE ^β /L 250~350-020C 250~300-150CR			GE ^β /L 300~400-020D 300-150DR		
Carbon steel	☆ 120~180	★ 60~140	☆ 60~140	-	(1) 0.03~0.08 (2) 0.03~0.08 (3) Max. 0.3	(1) 0.03~0.08 (2) 0.03~0.08 (3) Max. 0.3	(1) 0.04~0.09 (2) 0.04~0.09 (3) Max. 0.3	(1) 0.04~0.09 (2) 0.04~0.09 (3) Max. 0.3	(1) 0.05~0.12 (2) 0.05~0.1 (3) Max. 0.5	(1) 0.05~0.12 (2) 0.05~0.1 (3) Max. 0.5	(1) 0.05~0.12 (2) 0.05~0.1 (3) Max. 0.5
Alloy steel	☆ 100~160	★ 60~120	☆ 60~120	-	(1) 0.03~0.07 (2) 0.03~0.1 (3) Max. 0.3	(1) 0.03~0.07 (2) 0.03~0.1 (3) Max. 0.3	(1) 0.04~0.08 (2) 0.04~0.08 (3) Max. 0.3	(1) 0.04~0.08 (2) 0.04~0.08 (3) Max. 0.3	(1) 0.05~0.1 (2) 0.05~0.1 (3) Max. 0.5	(1) 0.05~0.1 (2) 0.05~0.1 (3) Max. 0.5	(1) 0.05~0.1 (2) 0.05~0.1 (3) Max. 0.5
Stainless steel	☆ 70~130	★ 60~110	☆ 60~110	-	(1) 0.03~0.07 (2) 0.03~0.1 (3) Max. 0.3	(1) 0.03~0.07 (2) 0.03~0.1 (3) Max. 0.3	(1) 0.04~0.08 (2) 0.04~0.08 (3) Max. 0.3	(1) 0.04~0.08 (2) 0.04~0.08 (3) Max. 0.3	(1) 0.05~0.1 (2) 0.05~0.1 (3) Max. 0.5	(1) 0.05~0.1 (2) 0.05~0.1 (3) Max. 0.5	(1) 0.05~0.1 (2) 0.05~0.1 (3) Max. 0.5
Cast iron	-	-	-	★ 60~100	(1) 0.03~0.08 (2) 0.03~0.08 (3) Max. 0.3	(1) 0.03~0.08 (2) 0.03~0.08 (3) Max. 0.3	(1) 0.04~0.09 (2) 0.04~0.09 (3) Max. 0.3	(1) 0.04~0.09 (2) 0.04~0.09 (3) Max. 0.3	(1) 0.05~0.12 (2) 0.05~0.1 (3) Max. 0.5	(1) 0.05~0.12 (2) 0.05~0.1 (3) Max. 0.5	(1) 0.05~0.12 (2) 0.05~0.1 (3) Max. 0.5
Aluminum	-	-	-	★ 150~300	(1) 0.05~0.12 (2) 0.05~0.12 (3) Max. 0.5	(1) 0.05~0.12 (2) 0.05~0.12 (3) Max. 0.5	(1) 0.05~0.15 (2) 0.05~0.15 (3) Max. 0.5	(1) 0.05~0.15 (2) 0.05~0.15 (3) Max. 0.5	(1) 0.08~0.15 (2) 0.08~0.15 (3) Max. 0.8	(1) 0.08~0.15 (2) 0.08~0.15 (3) Max. 0.8	(1) 0.08~0.15 (2) 0.08~0.15 (3) Max. 0.8
Brass	-	-	-	★ 100~250	(1) 0.05~0.12 (2) 0.05~0.12 (3) Max. 0.5	(1) 0.05~0.12 (2) 0.05~0.12 (3) Max. 0.5	(1) 0.05~0.15 (2) 0.05~0.15 (3) Max. 0.5	(1) 0.05~0.15 (2) 0.05~0.15 (3) Max. 0.5	(1) 0.08~0.15 (2) 0.08~0.15 (3) Max. 0.8	(1) 0.08~0.15 (2) 0.08~0.15 (3) Max. 0.8	(1) 0.08~0.15 (2) 0.08~0.15 (3) Max. 0.8

* Use PVD coated grade or carbide for turning with edge width 1mm. (GE^β/L 100-010C / 100-010D / 100-010E) ★:1st recommendation ☆:2nd recommendation

Molded chipbreakers: GER...CM, GER...DM, GER...EM

Workpiece material	Recommended insert grades (Vc: m/min)				(1) f for grooving (mm/rev)						Remarks
	Cermet	MEGACOAT	PVD coated carbide	Carbide	(2) f for turning (mm/rev)						
					(3) ap for turning (mm)						
					GER 150~200-010CM	GER 250~350-020CM			GER 300~400-020DM		
Carbon steel	-	★ 60~160	☆ 60~160	-	(1) 0.03~0.1 (2) 0.03~0.1 (3) Max. 1.0	(1) 0.03~0.12 (2) 0.03~0.1 (3) Max. 1.5	(1) 0.04~0.12 (2) 0.04~0.1 (3) Max. 1.5	(1) 0.05~0.12 (2) 0.05~0.1 (3) Max. 1.5	(1) 0.05~0.12 (2) 0.05~0.1 (3) Max. 1.5	(1) 0.05~0.12 (2) 0.05~0.1 (3) Max. 1.5	
Alloy steel	-	★ 60~140	☆ 60~140	-	(1) 0.03~0.1 (2) 0.03~0.1 (3) Max. 1.0	(1) 0.03~0.1 (2) 0.03~0.1 (3) Max. 1.5	(1) 0.04~0.12 (2) 0.04~0.1 (3) Max. 1.5	(1) 0.05~0.12 (2) 0.05~0.1 (3) Max. 1.5	(1) 0.05~0.12 (2) 0.05~0.1 (3) Max. 1.5	(1) 0.05~0.12 (2) 0.05~0.1 (3) Max. 1.5	
Stainless steel	-	★ 60~110	☆ 60~110	-	(1) 0.03~0.08 (2) 0.03~0.1 (3) Max. 1.0	(1) 0.03~0.08 (2) 0.03~0.1 (3) Max. 1.5	(1) 0.04~0.08 (2) 0.04~0.1 (3) Max. 1.5	(1) 0.05~0.1 (2) 0.05~0.1 (3) Max. 1.5	(1) 0.05~0.1 (2) 0.05~0.1 (3) Max. 1.5	(1) 0.05~0.1 (2) 0.05~0.1 (3) Max. 1.5	

★: 1st recommendation ☆: 2nd recommendation



Grooving

GV Inserts - ground chipbreaker

Workpiece material	Recommended insert grades (Vc : m/min)						f (mm/rev) = (1) grooving, (2) turning ap (mm) = (3) turning						Remarks
	Cermet			MEGA COAT	PVD coated carbide	Carbide	GV ⁹ /L 100~300...SS 100~300...S	GV ⁹ /L 145~185...B	GV ⁹ /L 200~280...B	GV ⁹ /L 300~400...B			
	TN90	TC40	TC60	PR1225	PR930	KW10	GV ⁹ /L 100~340...A 200~300...AR		GV ⁹ /L 200-100BR	GV ⁹ /L 300-150BR	GV ⁹ /L 280~300...C	GV ⁹ /L 340~400...C	
Carbon steel	☆ 120~180	☆ 120~180	☆ 80~120	★ 80~160	☆ 80~140	-	(1) 0.03~0.08 (2) 0.03~0.08 (3) Max. 0.3	(1) 0.03~0.08 (2) 0.03~0.08 (3) Max. 0.3	(1) 0.04~0.09 (2) 0.04~0.09 (3) Max. 0.3	(1) 0.05~0.12 (2) 0.05~0.1 (3) Max. 0.5	(1) 0.04~0.09 (2) 0.04~0.09 (3) Max. 0.3	(1) 0.05~0.12 (2) 0.05~0.1 (3) Max. 0.5	(1) 0.05~0.12 (2) 0.05~0.1 (3) Max. 0.5
Alloy steel	☆ 100~160	☆ 100~160	☆ 80~100	★ 80~140	☆ 80~120	-	(1) 0.03~0.07 (2) 0.03~0.1 (3) Max. 0.3	(1) 0.03~0.07 (2) 0.03~0.1 (3) Max. 0.3	(1) 0.04~0.08 (2) 0.04~0.08 (3) Max. 0.3	(1) 0.05~0.1 (2) 0.05~0.1 (3) Max. 0.5	(1) 0.04~0.08 (2) 0.04~0.08 (3) Max. 0.3	(1) 0.05~0.1 (2) 0.05~0.1 (3) Max. 0.5	(1) 0.05~0.1 (2) 0.05~0.1 (3) Max. 0.5
Stainless steel	☆ 70~130	-	☆ 60~100	★ 60~130	☆ 60~110	-	(1) 0.03~0.07 (2) 0.03~0.1 (3) Max. 0.3	(1) 0.03~0.07 (2) 0.03~0.1 (3) Max. 0.3	(1) 0.04~0.08 (2) 0.04~0.08 (3) Max. 0.3	(1) 0.05~0.1 (2) 0.05~0.1 (3) Max. 0.5	(1) 0.04~0.08 (2) 0.04~0.08 (3) Max. 0.3	(1) 0.05~0.1 (2) 0.05~0.1 (3) Max. 0.5	(1) 0.05~0.1 (2) 0.05~0.1 (3) Max. 0.5
Cast iron	-	-	-	-	-	★ 60~100	(1) 0.03~0.08 (2) 0.03~0.08 (3) Max. 0.3	(1) 0.03~0.08 (2) 0.03~0.08 (3) Max. 0.3	(1) 0.04~0.09 (2) 0.04~0.09 (3) Max. 0.3	(1) 0.05~0.12 (2) 0.05~0.1 (3) Max. 0.5	(1) 0.04~0.09 (2) 0.04~0.09 (3) Max. 0.3	(1) 0.05~0.12 (2) 0.05~0.1 (3) Max. 0.5	(1) 0.05~0.12 (2) 0.05~0.1 (3) Max. 0.5
Aluminum alloys	-	-	-	-	-	★ 150~300	(1) 0.05~0.12 (2) 0.05~0.12 (3) Max. 0.5	(1) 0.05~0.12 (2) 0.05~0.12 (3) Max. 0.5	(1) 0.05~0.15 (2) 0.05~0.15 (3) Max. 0.5	(1) 0.08~0.15 (2) 0.08~0.15 (3) Max. 0.8	(1) 0.05~0.15 (2) 0.05~0.15 (3) Max. 0.5	(1) 0.08~0.15 (2) 0.08~0.15 (3) Max. 0.8	(1) 0.08~0.15 (2) 0.08~0.15 (3) Max. 0.8
Brass	-	-	-	-	-	★ 100~250	(1) 0.05~0.12 (2) 0.05~0.12 (3) Max. 0.5	(1) 0.05~0.12 (2) 0.05~0.12 (3) Max. 0.5	(1) 0.05~0.15 (2) 0.05~0.15 (3) Max. 0.5	(1) 0.08~0.15 (2) 0.08~0.15 (3) Max. 0.8	(1) 0.05~0.15 (2) 0.05~0.15 (3) Max. 0.5	(1) 0.08~0.15 (2) 0.08~0.15 (3) Max. 0.8	(1) 0.08~0.15 (2) 0.08~0.15 (3) Max. 0.8

* Use MEGACOAT, PVD coated carbide or carbide for turning with edge width 1mm (GV⁹/L 100SS / 100S / 100A)

★ :1st recommendation ☆ :2nd recommendation

GVF Inserts - ground chipbreaker

Workpiece material	Recommended insert grades (Vc : m/min)						f (mm/rev) = (1) grooving, (2) turning ap (mm) = (3) turning					Remarks
	Cermet			MEGACOAT	PVD coated carbide	Carbide	GVF ⁹ /L 200~340...A	GVF ⁹ /L 250~350...B	GVF ⁹ /L 400~490...B	GVF ⁹ /L 350~450...C	GVF ⁹ /L 500~600...C	
	TN90	TC40	TC60	PR1225	PR930	KW10	GVF ⁹ /L 200-100AR ~300-150AR	GVF ⁹ /L 300-150BR	GVF ⁹ /L 400-200BR			
Carbon steel	☆ 150~220	☆ 150~220	☆ 100~150	★ 80~200	☆ 80~180	-	(1) 0.03~0.08 (2) 0.03~0.08 (3) Max. 0.3	(1) 0.04~0.09 (2) 0.04~0.09 (3) Max. 0.3	(1) 0.05~0.1 (2) 0.05~0.1 (3) Max. 0.5	(1) 0.05~0.12 (2) 0.05~0.1 (3) Max. 0.5	(1) 0.05~0.12 (2) 0.05~0.1 (3) Max. 0.8	
Alloy steel	☆ 130~200	☆ 130~200	☆ 80~130	★ 80~180	☆ 80~160	-	(1) 0.03~0.07 (2) 0.03~0.1 (3) Max. 0.3	(1) 0.04~0.08 (2) 0.04~0.08 (3) Max. 0.3	(1) 0.05~0.09 (2) 0.05~0.09 (3) Max. 0.5	(1) 0.05~0.1 (2) 0.05~0.1 (3) Max. 0.5	(1) 0.05~0.1 (2) 0.05~0.1 (3) Max. 0.8	
Stainless steel	☆ 70~150	-	☆ 60~100	★ 80~150	☆ 60~130	-	(1) 0.03~0.07 (2) 0.03~0.1 (3) Max. 0.3	(1) 0.04~0.08 (2) 0.04~0.08 (3) Max. 0.3	(1) 0.05~0.09 (2) 0.05~0.09 (3) Max. 0.5	(1) 0.05~0.1 (2) 0.05~0.1 (3) Max. 0.5	(1) 0.05~0.1 (2) 0.05~0.1 (3) Max. 0.8	
Cast iron	-	-	-	-	-	★ 60~100	(1) 0.03~0.08 (2) 0.03~0.08 (3) Max. 0.3	(1) 0.04~0.09 (2) 0.04~0.09 (3) Max. 0.3	(1) 0.05~0.1 (2) 0.05~0.1 (3) Max. 0.5	(1) 0.05~0.12 (2) 0.05~0.1 (3) Max. 0.5	(1) 0.05~0.12 (2) 0.05~0.1 (3) Max. 0.8	
Aluminum alloys	-	-	-	-	-	★ 150~400	(1) 0.05~0.12 (2) 0.05~0.12 (3) Max. 0.5	(1) 0.05~0.15 (2) 0.05~0.15 (3) Max. 0.5	(1) 0.05~0.15 (2) 0.05~0.15 (3) Max. 0.8	(1) 0.05~0.15 (2) 0.08~0.15 (3) Max. 0.8	(1) 0.08~0.15 (2) 0.08~0.15 (3) Max. 0.8	
Brass	-	-	-	-	-	★ 150~300	(1) 0.05~0.12 (2) 0.05~0.12 (3) Max. 0.5	(1) 0.05~0.15 (2) 0.05~0.15 (3) Max. 0.5	(1) 0.05~0.15 (2) 0.05~0.15 (3) Max. 0.8	(1) 0.08~0.15 (2) 0.08~0.15 (3) Max. 0.8	(1) 0.08~0.15 (2) 0.08~0.15 (3) Max. 0.8	

Apply a sufficient amount of coolant

The ap should be under 0.5 mm if a good surface finish is required

★ :1st recommendation ☆ :2nd recommendation

FTK

Workpiece material	Recommended insert grades (Vc : m/min)				Edge width (mm)		Remarks
	Cermet	CVD coated carbide	PVD coated carbide	Carbide	4.0	5.0	
	TN90	CR9025	PR930	KW10	f (mm/rev)		
Carbon steel	☆ 120~200	★ 80~180	☆ 60~130	-	0.05~0.15	0.05~0.15	
Alloy steel	☆ 100~160	★ 70~150	☆ 60~130	-	0.05~0.15	0.05~0.15	
Stainless steel	☆ 80~150	☆ 60~140	☆ 50~120	-	0.05~0.15	0.05~0.15	
Cast iron	-	-	-	★ 50~100	0.10~0.30	0.10~0.30	
Aluminum alloys	-	-	-	★ 200~450	0.05~0.25	0.05~0.25	
Brass	-	-	-	★ 100~200	0.05~0.25	0.05~0.25	

★ :1st recommendation ☆ :2nd recommendation

GMN inserts (CBN / PCD)

Workpiece material	Recommended insert grades (Vc : m/min)		f (mm/rev) = (1) grooving, (2) turning ap (mm) = (3) turning				Remarks
	CBN	PCD	GMN2	GMN3	GMN4, GMN5	GMN6	
	KBNS10, KBNS25	KPD001 (KPD010)					
Aluminum alloys	-	★ 150~2,000	(1) 0.05~0.15 (2) 0.05~0.15 (3) Max. 0.5	(1) 0.05~0.15 (2) 0.05~0.15 (3) Max. 0.8	(1) 0.08~0.18 (2) 0.08~0.18 (3) Max. 0.8	(1) 0.10~0.20 (2) 0.10~0.20 (3) Max. 0.8	
Brass	-	★ 200~800	(1) 0.05~0.15 (2) 0.05~0.15 (3) Max. 0.5	(1) 0.05~0.15 (2) 0.05~0.15 (3) Max. 0.8	(1) 0.08~0.18 (2) 0.08~0.18 (3) Max. 0.8	(1) 0.10~0.20 (2) 0.10~0.20 (3) Max. 0.8	
Cast iron	★ 150~400	-	(1) 0.04~0.09 (2) 0.04~0.09 (3) Max. 0.3	(1) 0.05~0.1 (2) 0.05~0.1 (3) Max. 0.5	(1) 0.05~0.12 (2) 0.05~0.12 (3) Max. 0.5	(1) 0.05~0.15 (2) 0.05~0.15 (3) Max. 0.8	
Hard materials	★ 80~120	-	(1) 0.02~0.05 (2) 0.01~0.03 (3) Max. 0.1	(1) 0.03~0.07 (2) 0.01~0.05 (3) Max. 0.2	(1) 0.03~0.08 (2) 0.03~0.08 (3) Max. 0.3	(1) 0.05~0.1 (2) 0.05~0.1 (3) Max. 0.4	

★ :1st recommendation

G

Grooving

KGDI - recommended cutting conditions (Vc)

Workpiece material	Chipbreaker	Recommended insert grades (Vc: m/min)						Remarks
		Cermet		MEGACOAT NANO	MEGACOAT		Carbide	
		TN620	TN90	PR1535	PR1225	PR1215	GW15	
Carbon steel	GMI CM GS	☆ 100~220	☆ 100~220	☆ 80~150	★ 80~200	☆ 100~200	-	Coolant
Alloy steel		☆ 80~200	☆ 80~200	☆ 70~150	★ 70~180	☆ 80~180	-	
Stainless steel		☆ 70~180	☆ 70~180	★ 60~150	☆ 60~150	☆ 60~150	-	
Cast iron		-	-	-	-	★ 100~200	-	
Aluminum alloys		-	-	-	-	-	★ 200~500	
Brass		-	-	-	-	-	★ 100~200	

★: 1st recommendation ☆: 2nd recommendation

KGDI - recommended cutting conditions (f and ap)

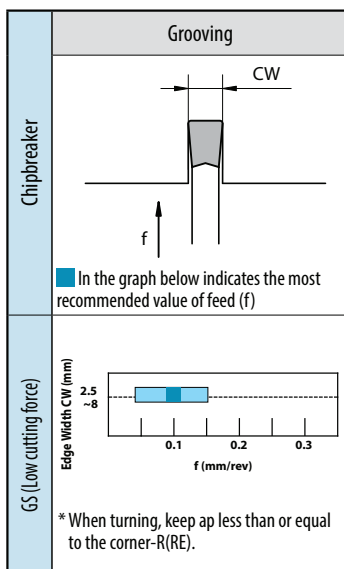
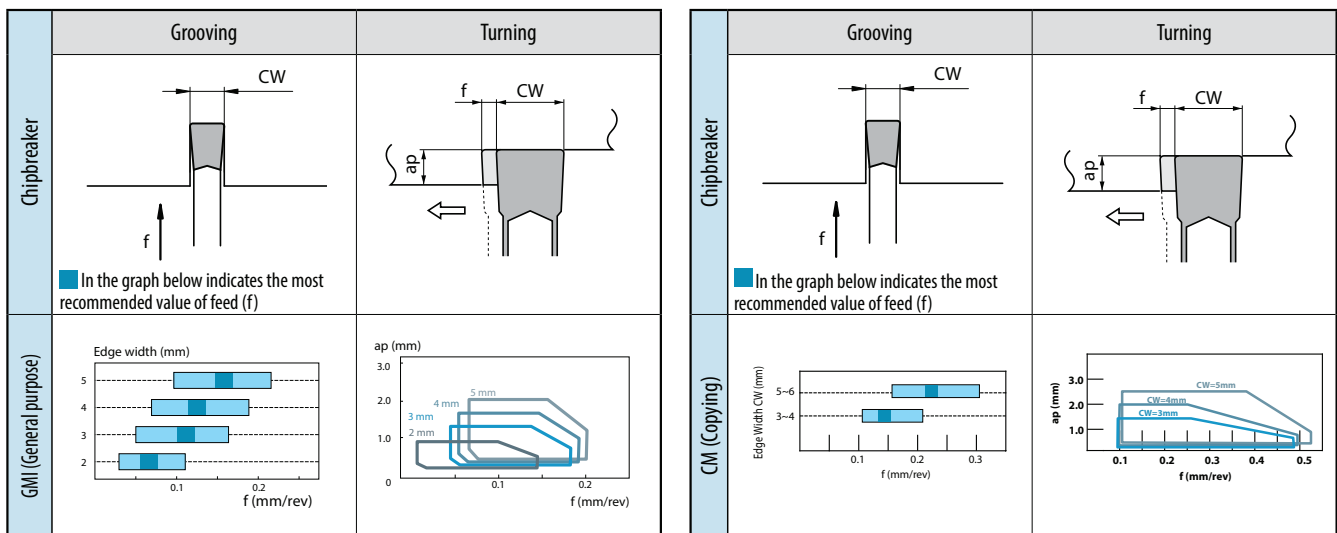

Additional processing of toolholder tip when CM chipbreaker is installed

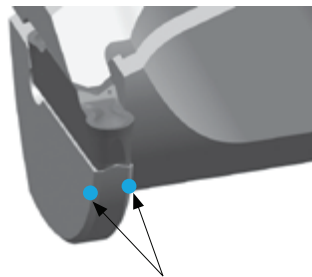

* By slightly chamfering the holder tip of about 0.5 mm, the cutting diameter can be minimized.



Guide for External Grooving

Point (I) (Turning after Grooving)

- 1) Grooving Depth 0.5mm or over : For roughing (Refer to Fig. 1)
Before turning, pull the tool back about 0.1mm after grooving, instead of turning subsequent to grooving.
(Failure to pull the tool back before traverse machining will result in an unbalanced load applied on only one side of the cutting edge.)
- 2) Grooving Depth 0.5mm or under : For finishing (Refer to Fig. 2)
Turning subsequent to grooving is possible because shallow groove depths relate a small load on the cutting edge. (Retention time is not necessary.)

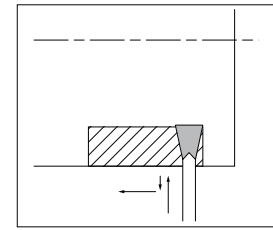

Before turning, pull the tool back about 0.1mm after grooving.
(Grooving Depth 0.5mm or over at roughing)

Fig. 1

Point (II)

- 1) When widening the groove width (Refer to Fig. 3), apply the "Step Turning."
- 2) The widened groove and side walls should be finished last.
(For better chip control, ap 0.5mm or over is recommended.)

Note) If the workpiece is not supported at the center, reduce the feed rate when grooving towards center.

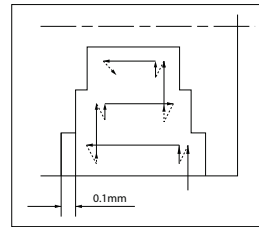
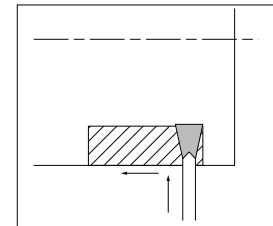

Fig. 3



Turning subsequent to grooving
(Grooving Depth 0.5mm or under at finishing)

Fig. 2

G

Grooving

Guide for Face Grooving

<Toolholder Selection>

- 1) Choose the best tool depending on the groove width.
External dia. of the groove listed in the catalog indicates the available range (between DAXN and DAXX) for the initial grooving on the unprocessed workpiece (Ref. to Fig. 1).



- 2) Confirm Grooving Depth (CD)



- 3) It is recommended to install the toolholder in the reverse position. (Fig. 2)
(This will provide smooth chip flow and chip clearance.)

<Guide for turning>

Turning direction should be from the outer diameter to the inner diameter as shown in Fig. 3
This improves chip evacuation.

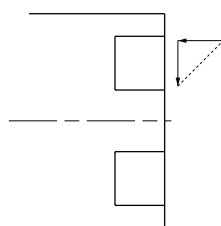

Fig. 3

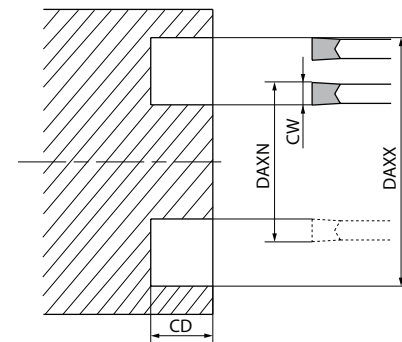

Fig. 1

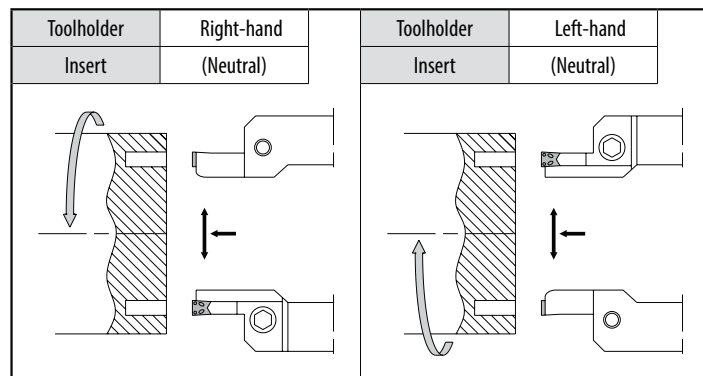

Fig. 2 Toolholder's hand and rotation

Guide for Face Grooving (Continued)

Point (I) (Turning after Grooving)

1) Grooving Depth 0.5mm or over : For roughing (Refer to Fig. 4)

Before turning, pull the tool back about 0.1mm after grooving.
(Failure to pull the tool back before traverse machining will result in an unbalanced load applied on only one side of the cutting edge.)

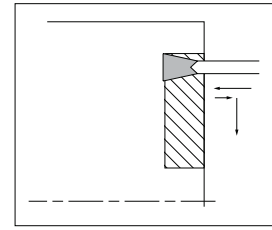

Before turning, pull the tool back about 0.1mm after grooving.
(Grooving Depth 0.5mm or over at roughing)

Fig. 4

2) Grooving Depth 0.5mm or under : For finishing (Refer to Fig. 5)

Turning subsequent to grooving is possible because shallow groove depths relate a small load on the cutting edge.
(Retention time is not necessary.)

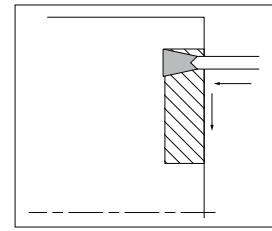

Turning subsequent to grooving
(Grooving Depth 0.5mm or under at finishing)

Fig. 5

Point (II)

1) When widening the groove width. (Ref. to Fig. 6)

Apply the "Step Turning".

2) The widened groove and side walls should be finished last.

(For better chip control, ap 0.5mm or over is recommended.)

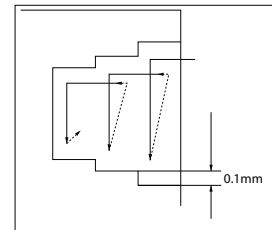
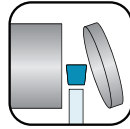

Fig. 6

Trouble shooting

Trouble	Countermeasures
Whitish trace remains at the groove bottom.	<p>(1) Increase the cutting speed for finishing process only. (This can handle most of the cases.) If the method is not successful, try (2) as follows.</p> <p>(2) Check the insert edge's parallelness. (Adjustment: Apply the insert edge to the workpiece face and adjust the toolholder within the angle of $\pm 5^\circ$. (Fig. 7))</p> <p>Fig. 7</p>
Chips are entangled.	<p>(1) Install the toolholder in the reverse position. Adjust the coolant flow to the cutting edge.</p> <p>(2) When widening the groove, do not machine one deep groove. Instead, repeat shallow grooving and turning.</p>
Insert cracks when turning.	Reverse the facing direction.
Groove is not straight.	<p>Check the edge's parallelness. Decrease the feed rate.</p>



Introduction		H2
Small diameter cut-off		H6
TKF type	KTKF	H9
	KTKF-JCTM	H15
	KTKF-S	H18
KGD type		H20
GDM/GDMS/GDG type	KGD (Integral type for automatic lathe)	H22
	KGDS (for sub spindle tooling)	H24
	KGD-JCTM (Integral type for automatic lathe)	H27
	KGD (Integral type)	H28
	KGD-S (Integral type)	H29
	KGD-S (Integral type)	H30
	KGD-JCT (Integral type)	H31
KGM type		H34
KGM type	KGM/KGM-T/KGMM/KGMS	H38
PKM type		H46
PKM type	KPKB-JCT/KPKB	H48
	Toolblocks	H50
	KPKH-JCT/KPKH (Integral type)	H55
1-edge-cut-off inserts		H58
TKN/TK type	KTKB-SS/KTKB-S	H60
	KTKH-S (Integral type)	H61

Product Lineup

For small diameter cut-off (automatic lathes) CUTDIA ~ø16 mm	KTKF (H9, H10, H12) 	KTKF-JCTM (H15) 		KTKF-S (H18) 	
KGD (Bolt clamp) CUTDIA ~ø51 mm	KGD (H22, H28) 	KGD-JCTM (for automatic lathes) (H27) 	KGD-S (H29) 	KGD-JCT (H31) 	KGDS (H24)
KGM (Bolt clamp) CUTDIA ~ø60 mm	KGM (H38, H39) 	KGM-T (H40) 			
KPK (1-edge) CUTDIA ~ø120	Toolholder Type CUTDIA ø35 ~ ø79	KPKH(-JCT) (H55, H56) 		Blade type CUTDIA ø32 ~ ø120	KPKB(-JCT) (H48, H49)
KTKB KTKH (1-edge) CUTDIA ~ø120	Toolholder Type CUTDIA ø30 ~ ø79	KTKH-S (H61) 		Blade type CUTDIA ø32 ~ ø120	KTKB-S(S) (H60)



Cut-off Tools

Series Name	Shape	Advantage	Applications
For small diameter cut-off		<ol style="list-style-type: none"> 1) Insert clamp is side screw type from lateral side 2) 2-edge insert 3) Max. Cut-off Dia. : ø16 	<ol style="list-style-type: none"> 1) For cut-off and grooving of small workpieces 2) For automatic lathe, small machine
KGD		<ol style="list-style-type: none"> 1) Insert is clamped from top side 2) 1-edge and 2-edge inserts available 3) Integral type and separate type are available 4) Max. Cut-off Dia. : ø50 	<ol style="list-style-type: none"> 1) PM chipbreaker --- for cut-off 2) PH chipbreaker --- for cut-off (high feed rate) for grooving 3) PG chipbreaker --- for cut-off (for automatic lathe), sharp-cutting oriented 4) PF chipbreaker --- for cut-off (for automatic lathe), low feed 5) PQ chipbreaker --- for cut-off (for automatic lathe), medium feed
KGM		<ol style="list-style-type: none"> 1) Insert is clamped from top side 2) 1-edge and 2-edge inserts available 3) Max. Cut-off Dia. : ø60 	<ol style="list-style-type: none"> 1) For cut-off and grooving of small workpieces 2) For automatic lathe, small machine 3) TMR Chipbreaker provides stable chip control up to high feed rate ranges
KPK		<ol style="list-style-type: none"> 1) Self-clamping System that Opens and Closes the Contact Surface with a Wrench 2) 1-edge insert 3) Molded Chipbreaker 4) Blade Type JCT Type for High-pressure Coolant (Internal Coolant) is Available 5) Max. Cut-off Dia. : ø100 	<ol style="list-style-type: none"> 1) For cut-off and deep grooving 2) PM Chipbreaker --- General Purpose PH Chipbreaker --- For Tough Edge / High Feed Rate
KTKB KTKH		<ol style="list-style-type: none"> 1) Self-Clamping System Tap the insert lightly with a plastic hammer to set it in the pocket 2) 1-edge insert 3) Blade type and Integral Shank type 4) Max. Cut-off Dia. : ø120 	<ol style="list-style-type: none"> 1) For cut-off and deep grooving 2) Standard chipbreaker is general cut-off type Feed rate : 0.1mm/rev or over P Chipbreaker is for cut-off at low feed rates Feed rate : 0.03~0.08mm/rev

Tool Selection

		For Small Diameter Cut-off	KGD	KGM	KPK	KTKB / KTKH
Insert	1. Insert's Edge Number 1-edge Insert--For Larger Dia. Workpiece (Max. $\phi 120$) 2-edge Insert--For Smaller Dia. Workpiece Cost per corner is reduced	-	-	-	✓	✓
	2. Use a neutral angle insert if there is no limit to the finished shape.	TKF...S TKF...NB	GDM GDMS	GMM	PKM	TKN
	3. Insert with lead angle is recommended to prevent remaining boss.	TKF...DR	GDM- ^{R/L} (Fig. 2)	GMM- ^{R/L} (Fig. 2)	PKM- ^{R/L} (Fig. 1)	TK ^{R/L} (Fig. 1)
	4. If you want to make the remaining boss smaller when machining small or thin parts, use sharp corner and lead angle insert.	TKF...DR	-	GMM- ^{R/L} (Fig. 2)	-	-
	5. Use the minimum width insert suitable for the machining.	✓	✓	✓	✓	✓
Toolholder	1. Use a suitable toolholder (blade) for the workpiece dia.	✓	✓	✓	✓	✓
	2. Use a more rigid toolholder (blade).	✓	✓	✓	✓	✓
	3. Use a back clamp toolholder if there is no space for clamping tools from top side (automatic lathe).	✓	-	-	-	-

How to select cut-off inserts with / without lead angle (Including sharp corner)

1. Use a neutral angle insert if there is no limit to the finished shape.
2. Use an angled insert to reduce the size of the remaining boss.
3. Use a sharp-cornered lead-angled insert to make the remaining boss much smaller when machining small parts and thin parts.

Hand of lead angle	N (Neutral)	R (Right-hand)	L (Left-hand)
Angled insert can reduce the burr size when cutting off. When using a larger lead angle, cutting force becomes smaller, but the feed rate should be reduced.			

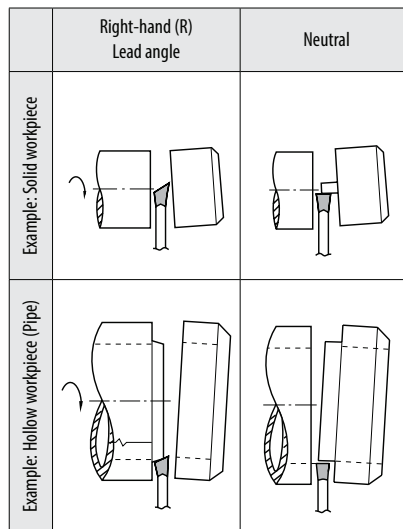

Fig.1

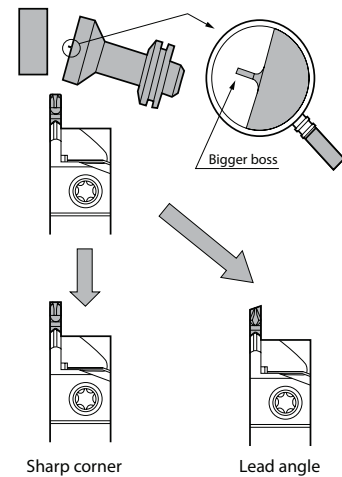

Fig.2

Caution

1. For PKM, PKM-^{R/L}, TKN and TK^{R/L}, set the cutting edge height 0.1~0.2 mm above the center height (Fig. 3)
For other toolholders, set the cutting edge to the center height.
2. Be sure to perform wet processing. Apply enough coolant to the cutting edge.
3. Keep a constant rate during processing so that optimum product life will be achieved.
4. Cut off as close to the chuck as possible.
5. Lower the feed rate to 1/2 to 1/3 at the near center to prevent impact caused by machining.

Overuse of insert and toolholder (blade) may cause insert breakage and toolholder (blade) damage.
Do not rework the insert and toolholder (blade) to prevent damage.
Clean the insert pocket well with compressed air when replacing insert.

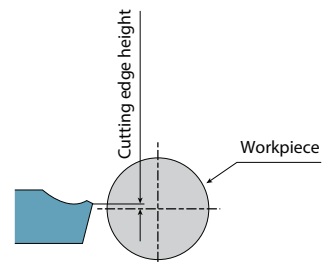
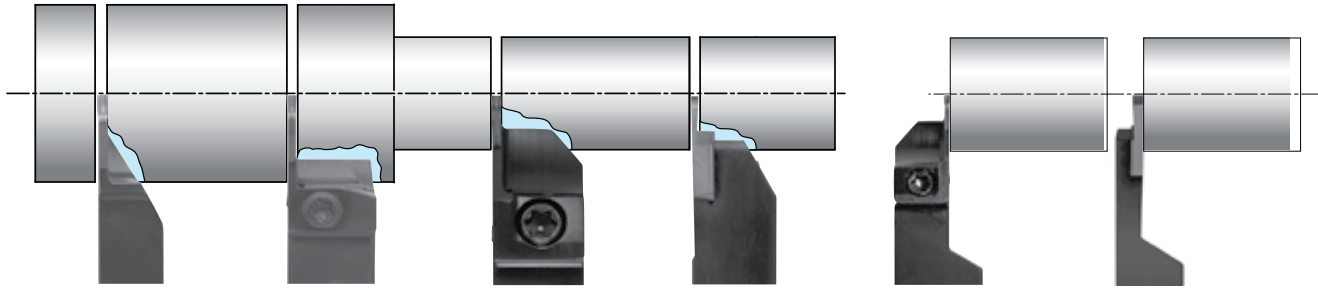

Fig. 3 (PKM, PKM-^{R/L}, TKN, TK^{R/L})

Small dia. cut-off ~ $\phi 51$

Small shank



KPKH / KTKH-S	KGM	KGD / KGD-JCTM	KTKF	KGDS	KTKF-S
CUTDIA: ~ $\phi 45$ Shank: $\square 20 \sim 25$ (KPKH) $\square 10 \sim 25$ (KTKH-S) CW: 3.0~4.0 (KPKH) 2.2~4.1 (KTKH-S) Self clamp	CUTDIA: ~ $\phi 32$ Shank: $\square 10 \sim 16$ CW: 1.5~4.0 Top clamp	CUTDIA: ~ $\phi 51$ Shank: $\square 10 \sim 25$ CW: 1.3~4.0 Top clamp	CUTDIA: ~ $\phi 16$ Shank: $\square 10 \sim 25$ CW: 0.5~2.0 Lateral side clamp	CUTDIA: ~ $\phi 24$ Shank: $\square 16$ CW: 1.3~3.0 Top clamp	CUTDIA: ~ $\phi 16$ Shank: $\square 10 \sim 12$ CW: 0.5~2.0 Lateral side clamp
H55 H56 H61	H38 H39 H40	H22 H27	H9, H10, H12, H15	H24	H18

H
Cut-Off

For KPKH



PM chipbreaker for general cut-off



PH chipbreaker Tough edge



For KTKH-S



Chipbreaker for general cut-off



Chipbreaker for low feed cut-off

Chipbreaker edge shape	TK insert, Cut-off (Self clamp)		
	General cut-off		Low feed cut-off
	Chamfer + R honed	Sharp edge	R honed
			

For KTKF / KTKF-S

2-edge



Low cutting force

2-edge

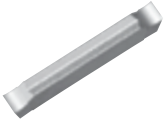

Sharp cutting PG chipbreaker



Low feed PF chipbreaker



Medium feed PQ chipbreaker



(15° Lead angle)



(15° Lead angle)



(15° Lead angle)



KTKH-S (Self clamp)



KGD (Top clamp)



KTKF (Lateral side clamp)

General cut-off ~ ϕ 120

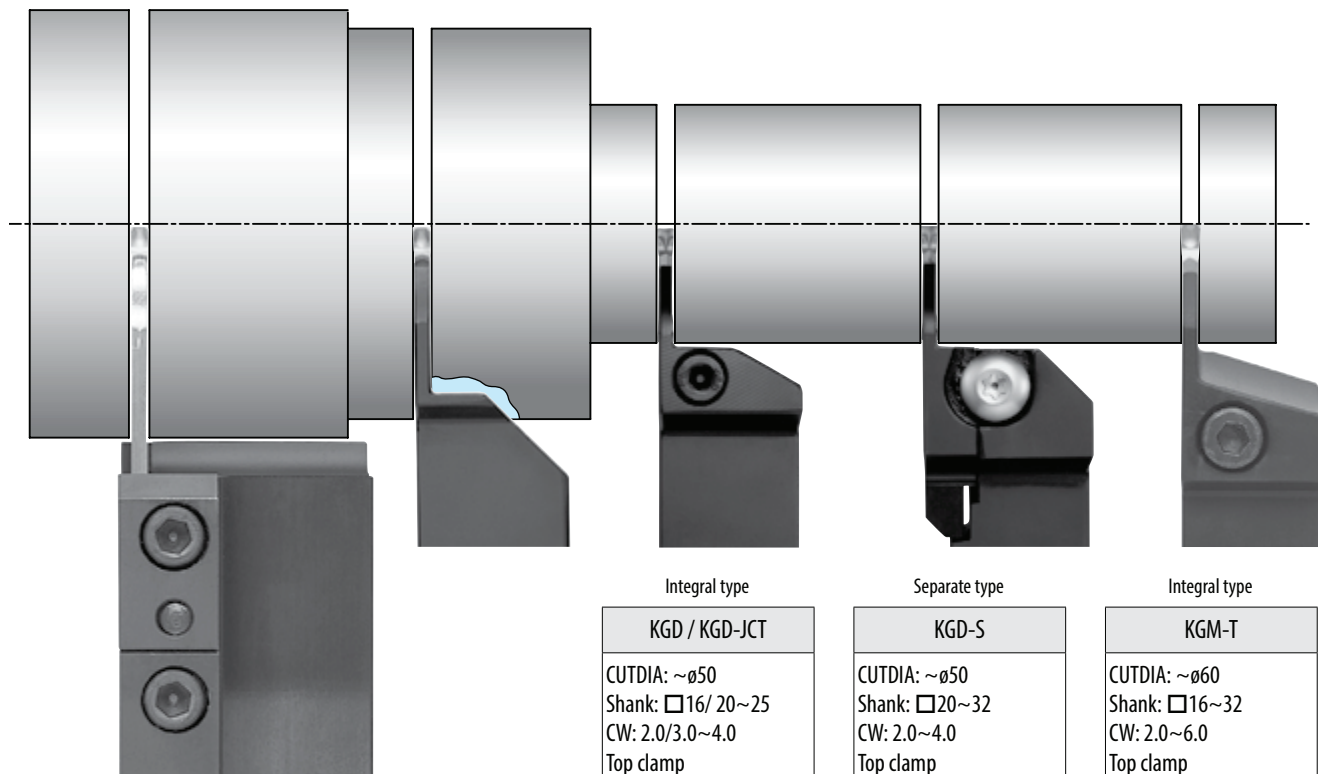

Integral type	Separate type	Integral type
KGD / KGD-JCT	KGD-S	KGM-T
CUTDIA: $\sim\phi$ 50 Shank: \square 16/ 20 \sim 25 CW: 2.0/3.0 \sim 4.0 Top clamp	CUTDIA: $\sim\phi$ 50 Shank: \square 20 \sim 32 CW: 2.0 \sim 4.0 Top clamp	CUTDIA: $\sim\phi$ 60 Shank: \square 16 \sim 32 CW: 2.0 \sim 6.0 Top clamp

Blade + Toolblock	Integral type
KPKB / KTKB	KPKH / KTKH-S
CUTDIA: $\sim\phi$ 120 Toolblock: \square 16 \sim 32 CW: 1.6 \sim 6.0 (KPKB) 1.6 \sim 9.6 (KTKB) Self clamp	CUTDIA: $\sim\phi$ 79 Shank: \square 20 \sim 25 CW: 2.0 \sim 5.0 (KPKH) 3.1 \sim 5.1 (KTKH-S) Self clamp

H48, H49, H60

H55, H56, H61

H28, H31

H29

H40

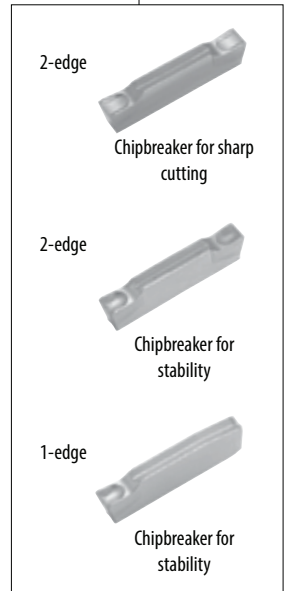
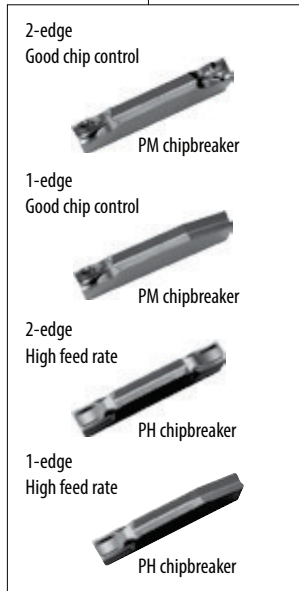
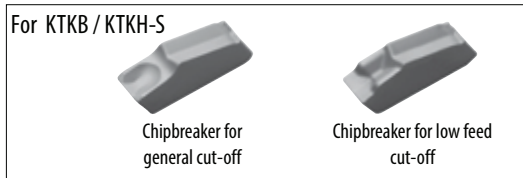
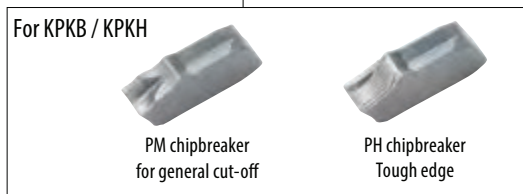

Blade + Toolblock		Separate type	Integral type		
KPKB	KTKB	KGD-S	KTKH-S	KGD / KGD-JCT	KGM-T



TKF12

		Carbon steel / Alloy steel											P												
		Stainless steel											M												
		Cast iron											K												
		Non-ferrous metals											N												
Insert	Description	No. of edges	Dimension (mm)						Angle (°)	Tolerance (mm)		Carbide				Applicable toolholder H9, H10 H12, H15 H18									
			CW	S	D1	RE	W1	CUTDIA		PSIRR	CW min.	CW max.	DLC	PVD	-										
	TKF12R 050-S 070-S 100-S 125-S 150-S 200-S	2	0.5 0.7 1 1.25 1.5 2	8.7	5	0.03	3	5 8 12 12 12 12	0	-0.03	+0.03	●	●	●	●	KTKFR...-12 KTKFR...-12-Y KTKFR-12JCTM KTKFR...-12SA KTKFR...-12SB									
	TKF12L 050-S 070-S 100-S 125-S 150-S 200-S		0.5 0.7 1 1.25 1.5 2									●	●	●	●		KTKFL...-12 KTKFL-12JCTM KTKFL...-12SA KTKFL...-12SB								
	TKF12R 100-T 150-T 200-T		1 1.5 2									●	●	●	●		KTKFR...-12 KTKFR...-12-Y KTKFR-12JCTM KTKFR...-12SA KTKFR...-12SB								
	TKF12L 100-T 150-T 200-T		1 1.5 2									●	●	●	●		KTKFL...-12 KTKFL-12JCTM KTKFL...-12SA KTKFL...-12SB								
	TKF12R 050-S-16DR 070-S-16DR 100-S-16DR 125-S-16DR 150-S-16DR 200-S-16DR		0.5 0.7 1 1.25 1.5 2									8.7	5	0.03	3		5 8 12 12 12 12	16	-0.03	+0.03	●	●	●	●	KTKFR...-12 KTKFR...-12-Y KTKFR-12JCTM KTKFR...-12SA KTKFR...-12SB
	TKF12L 050-S-16DR 070-S-16DR 100-S-16DR 125-S-16DR 150-S-16DR 200-S-16DR		0.5 0.7 1 1.25 1.5 2																		●	●	●	●	
TKF12R 100-T-16DR 150-T-16DR 200-T-16DR	1 1.5 2	●	●	●	●	KTKFR...-12 KTKFR...-12-Y KTKFR-12JCTM KTKFR...-12SA KTKFR...-12SB																			
TKF12L 100-T-16DR 150-T-16DR 200-T-16DR	1 1.5 2	●	●	●	●	KTKFL...-12 KTKFL-12JCTM KTKFL...-12SA KTKFL...-12SB																			
TKF12R 050-NB 070-NB 100-NB 150-NB 200-NB	0.5 0.7 1 1.5 2	8.7	5	0	3	5 8 12 12 12 12	0	-0.03	+0.03	●	●					●					●	KTKFR...-12 KTKFR...-12-Y KTKFR-12JCTM KTKFR...-12SA KTKFR...-12SB			
TKF12L 050-NB 070-NB 100-NB 150-NB 200-NB	0.5 0.7 1 1.5 2									●	●					●					●		KTKFL...-12 KTKFL-12JCTM KTKFL...-12SA KTKFL...-12SB		

Lead angle (PSIRR) shows the angle when installed in toolholder.
As Fig. 1 of H11 shows, the cut-off diameter of the insert (CUTDIA) is indicated when the top of the cut-off edge progresses 1 mm from the center.
Right-hand shown

● : Standard item R : Right-hand only L : Left-hand only □ : Check availability

H6



TKF12

		Carbon steel / Alloy steel		Stainless steel		Cast iron		Non-ferrous metals				P		M		K		N	
Insert	Description	No. of edges	Dimension (mm)						Angle (°)	Tolerance (mm)		Carbide		Applicable toolholder H9, H10 H12, H15 H18					
			CW	S	D1	RE	W1	CUTDIA		CW min.	CW max.	PVD	-						
	TKF12R 050-NB-20DR	2	0.5	8.7	5	0	3	5	20	-0.03	+0.03	●	●	KTKFR...-12 KTKFR...-12-Y KTKFR-12JCTM KTKFR...-12SA KTKFR...-12SB					
	TKF12R 070-NB-20DR		8					●				●							
	TKF12R 100-NB-20DR		12					●				●							
	TKF12R 150-NB-20DR		12					●				●							
	TKF12R 200-NB-20DR		12					●				●							
	TKF12L 050-NB-20DR	2	0.5	8.7	5	0	3	5	20	-0.03	+0.03	●	●	KTKFL...-12 KTKFL-12JCTM KTKFL...-12SA KTKFL...-12SB					
	TKF12L 070-NB-20DR		8					●				●							
	TKF12L 100-NB-20DR		12					●				●							
	TKF12L 150-NB-20DR		12					●				●							
	TKF12L 200-NB-20DR		12					●				●							

Lead angle (PSIRR) shows the angle when installed in toolholder.

As Fig. 1 of H11 shows, the cut-off diameter of the insert (CUTDIA) is indicated when the top of the cut-off edge progresses 1 mm from the center. Right-hand shown

Inserts identification system

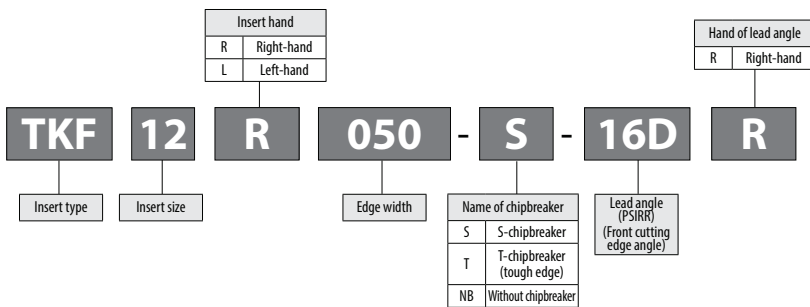
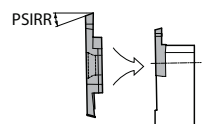
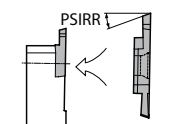
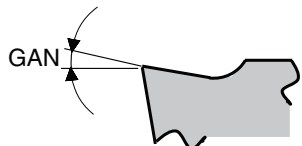

Table 1

Toolholder	Right-hand	Toolholder	Left-hand
Insert	Right-hand	Insert	Left-hand
Lead angle	Right-hand	Lead angle	Right-hand
			







Descriptions of Chipbreaker Edge Shape

Edge Shape	S Chipbreaker		T Chipbreaker (Tough Edge)		NB (Without Chipbreaker)	
	GAN	Description	GAN	Description	GAN	Description
	15°	TKF12...-S	12°	TKF...-T TKF...-T-16DR	0°	TKF...-NB TKF...-NB-20DR
	20°	TKF16...-S TKF16...-S-16DR				
	25°	TKF12...-S-16DR				

● : Standard item R : Right-hand only L : Left-hand only □ : Check availability



TKF16

		Carbon steel / Alloy steel											☺	☹	☹	☹	P		
		Stainless steel											☺	☹	☹	☹	M		
		Cast iron											☹	☹	☹	☹	K		
		Non-ferrous metals											☹	☹	☹	☹	N		
Insert	Description	No. of edges	Dimension (mm)						Angle (°)	Tolerance (mm)		Carbide				Applicable toolholder H9, H15 H18			
			CW	S	D1	RE	W1	CUTDIA		PSIRR	CW min.	CW max.	DLC	PVD					
	TKF16R 150-S 200-S	2	1.5 2	9.5	5	0.05	4	16	0	-0.03	+0.03	●	●	●	●	●	●	KTKFR...-16 KTKFR-16JCTM KTKFR...-16SA KTKFR...-16SB	
	TKF16L 150-S 200-S		1.5 2									●	●	●	●	●	●		●
	TKF16R 150-T 200-T	2	1.5 2	9.5	5	0.08	4	16	0	-0.03	+0.03	●	●	●	●	●	●	KTKFR...-16 KTKFR-16JCTM KTKFR...-16SA KTKFR...-16SB	
	TKF16L 150-T 200-T		1.5 2									●	●	●	●	●	●		●
	TKF16R 150-S-16DR 200-S-16DR	2	1.5 2	9.5	5	0.05	4	16	16	-0.03	+0.03	●	●	●	●	●	●	KTKFR...-16 KTKFR-16JCTM KTKFR...-16SA KTKFR...-16SB	
	TKF16L 150-S-16DR 200-S-16DR		1.5 2									●	●	●	●	●	●		●
	TKF16R 150-T-16DR 200-T-16DR	2	1.5 2	9.5	5	0.08	4	16	16	-0.03	+0.03	●	●	●	●	●	●	KTKFR...-16 KTKFR-16JCTM KTKFR...-16SA KTKFR...-16SB	
	TKF16L 150-T-16DR 200-T-16DR		1.5 2									●	●	●	●	●	●		●
	TKF16R 150-NB 200-NB	2	1.5 2	9.5	5	0	4	16	0	-0.03	+0.03	●	●	●	●	●	●	KTKFR...-16 KTKFR-16JCTM KTKFR...-16SA KTKFR...-16SB	
	TKF16L 150-NB 200-NB		1.5 2									●	●	●	●	●	●		●
	TKF16R 150-NB-20DR 200-NB-20DR	2	1.5 2	9.5	5	0	4	16	20	-0.03	+0.03	●	●	●	●	●	●	KTKFR...-16 KTKFR-16JCTM KTKFR...-16SA KTKFR...-16SB	
	TKF16L 150-NB-20DR 200-NB-20DR		1.5 2									●	●	●	●	●	●		●

Lead angle (PSIRR) shows the angle when installed in toolholder.

As Fig. 1 of H11 shows, the cut-off diameter of the insert (CUTDIA) is indicated when the top of the cut-off edge progresses 1 mm from the center.

Right-hand shown

● : Standard item R : Right-hand only L : Left-hand only □ : Check availability

H8



KTKF

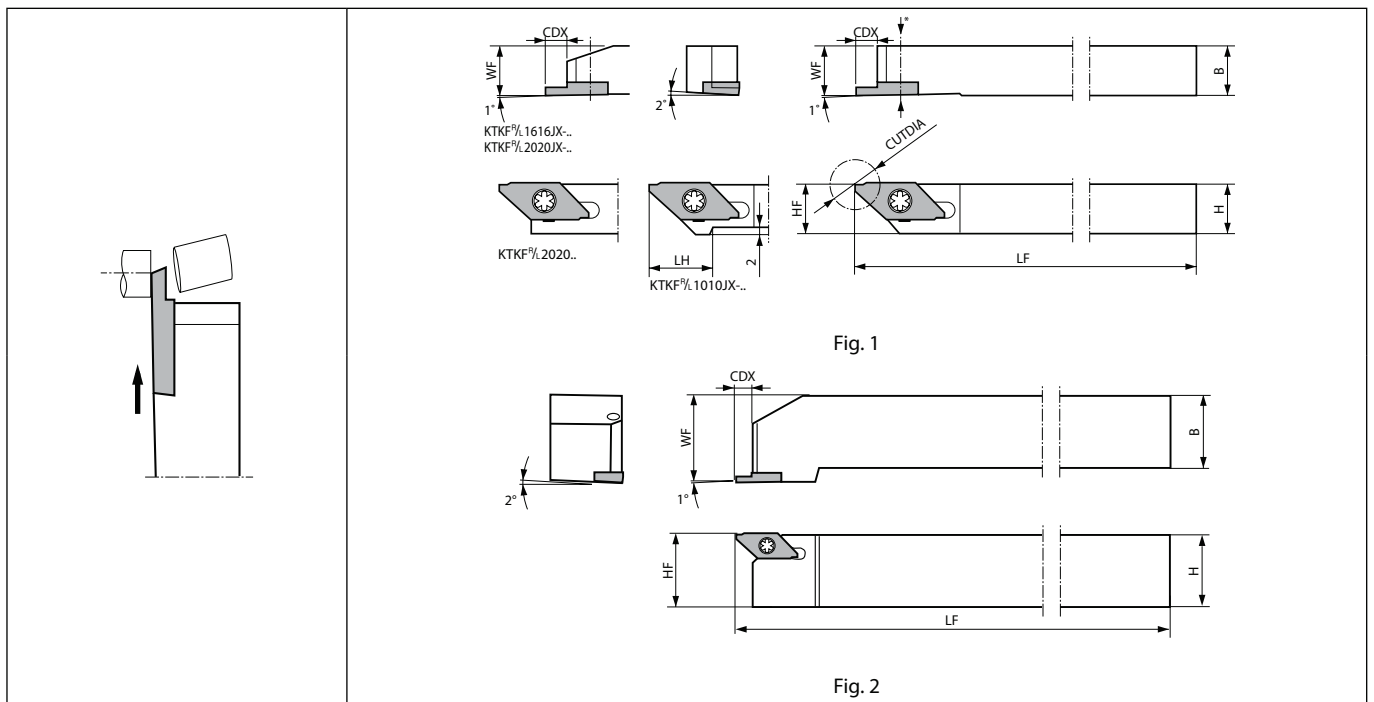

Right-hand shown | Right-hand Insert for Right-hand Toolholder, Left-hand Insert for Left-hand Toolholder.



Toolholder dimensions

Description	Availability		Dimension (mm)								Fig.	Spare parts		Applicable inserts H6~H8
												Screw	Wrench	
	R	L	CDX	H	B	LH	HF	LF	WF					
KTKF% 1010JX-12 1212F-12 1212JX-12 1616JX-12 2020JX-12 2525M-12	●	●	6	10	10	15	10	120	10	1	SB-4590TRWN	FT-10	TKF12%...	
	●	●		12	12	-	12	85	12					
	●	●		16	16	-	16	120	16					
	●	●		20	20	-	20	20	20					
	●	●		25	25	-	25	150	30					2
	●			25	25	-	25	150	30				2	
KTKF% 1010JX-16 1212F-16 1212JX-16 1616JX-16 2020JX-16 2525M-16	●	●	8	10	10	20	10	120	10	1	SB-4590TRWN	FT-10	TKF16%...	
	●	●		12	12	-	12	85	12					
	●	●		16	16	-	16	120	16					
	●	●		20	20	-	20	20	20					
	●	●		25	25	-	25	150	30					2
	●			25	25	-	25	150	30				2	

CDX shows the distance from the toolholder to the cutting edge.

Recommended cutting conditions H19

● : Standard item R : Right-hand only L : Left-hand only □ : Check availability

KTKF (Goose-neck holder)

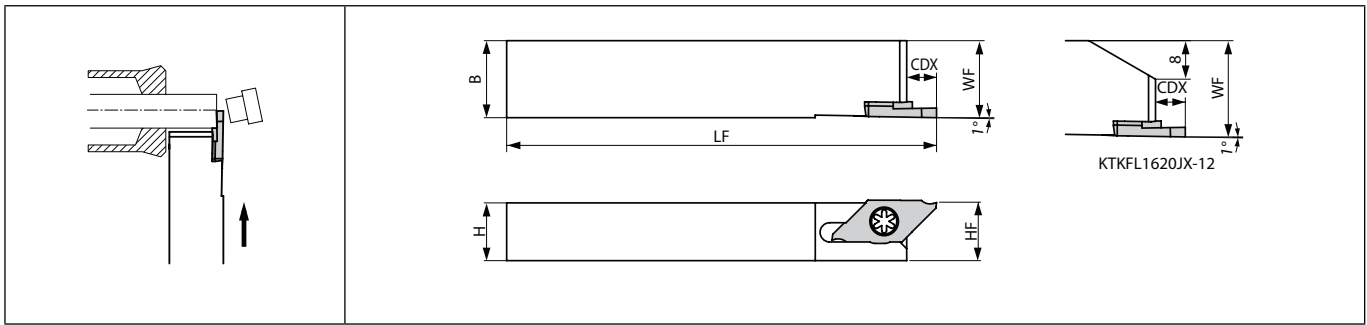

Left-hand shown | Left-hand Insert for Left-hand Toolholder.

Toolholder dimensions

Description	Availability	Dimension (mm)						Spare parts		Applicable inserts ➡ H6, H7
								Screw	Wrench	
		L	CDX	H	B	HF	LF	WF		
KTKFL 1216JX-12 1620JX-12	●	6	12	16	12	120	16	SB-4590TRWN	FT-10	TKF12L...
	●		16	20	16		20			

CDX shows the distance from the toolholder to the cutting edge.

Recommended cutting conditions ➡ H19



● : Standard item R : Right-hand only L : Left-hand only □ : Check availability

How to Use

1) When using main spindle only

Maximum cutting diameter is CUTDIA (Fig.1).
 Even if the cutting edge runs beyond the center line (Fig.2),
 the insert does not contact the workpiece, since the workpiece falls off.
 (The clearance between the insert and the workpiece is 0.2 mm)

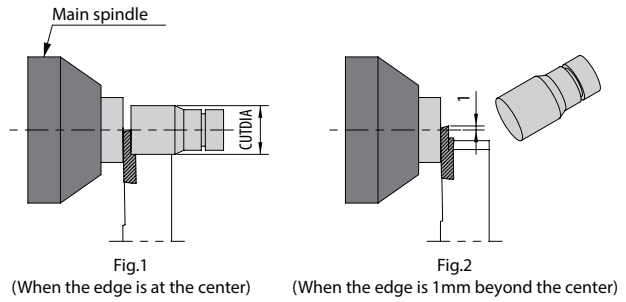

2) When using both main and sub spindles

In this case, when the cutting edge runs beyond the center line, the insert will contact the workpiece, since the workpiece does not fall off.
 Therefore the programmed distance beyond the center must be considered.
 e.g.) When the cutting edge is programmed to run 1mm beyond the center.
 Workpiece maximum, CUTDIA2 (Fig.4) = [CUTDIA - 1 mm × 2] (mm)
 (The clearance between the insert and the workpiece is 0.2 mm)

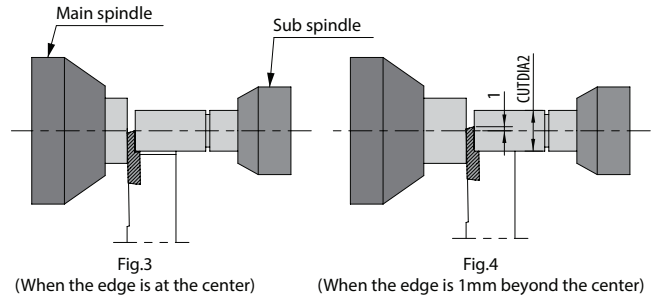

How to select edge preparation

Troubleshooting

Problems	Countermeasures	Countermeasures						
		Lead angle (PSIRR)		Edge width		Name of chipbreaker		
		Neutral (0°)	Yes	Narrower	Wider	S	T	NB
Insert fracture	Insert fracture prevention							
Long cutting time	Cutting time reduction	Effective			Effective		Effective	Effective
Entangled chips	Prevention of chip entanglement	Effective		Effective		Effective		
Large boss remain	Small boss remain		Effective	Effective		Effective		
Ring remain (Hollow workpiece)	Prevention of ring remain		Effective	Effective		Effective		
Deformation of hollow workpiece (pipe)	Preventing deformation		Effective	Effective		Effective		



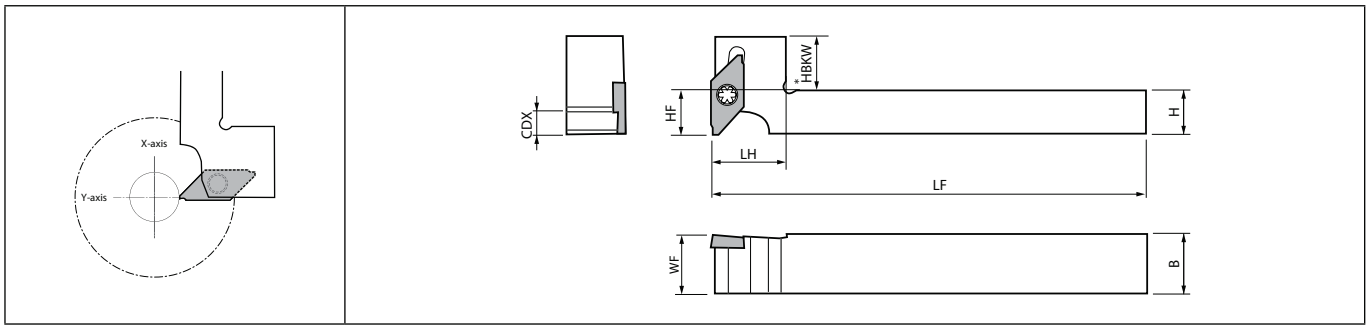

KTKF (Y-axis toolholder)



Right-hand shown | Right-hand Insert for Right-hand Toolholder.

Toolholder dimensions

Description	Availability	Dimension (mm)									Spare parts		Applicable inserts ➔ H6, H7
		R	CDX	H	B	LH	HF	HBKW	LF	WF	Screw	Wrench	
													
KTKFR 1216JX-12-Y 1616JX-12-Y	● ●	6	12 16	16	20 25	12 16	15 11	120	16	SB-4590TRWN	FT-10	TKF12R...	

CDX shows the distance from the toolholder to the cutting edge.

Recommended cutting conditions ➔ H19



Cut-Off

●: Standard item R: Right-hand only L: Left-hand only □: Check availability

Precautions for using Y-axis toolholder

Do not use Y-axis toolholders side by side to prevent interference. (Only two Y-axis holder can be used at the same time)

With interference

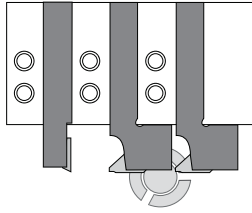

Without interference

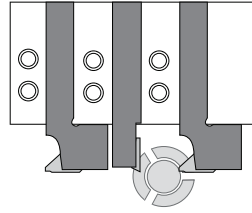

Standard toolholders may be mounted between two Y-axis toolholders

When changing the tool, set the retracted position with reference to the cutting edge of the Y-axis holder. (When exchanging from tool B to D)

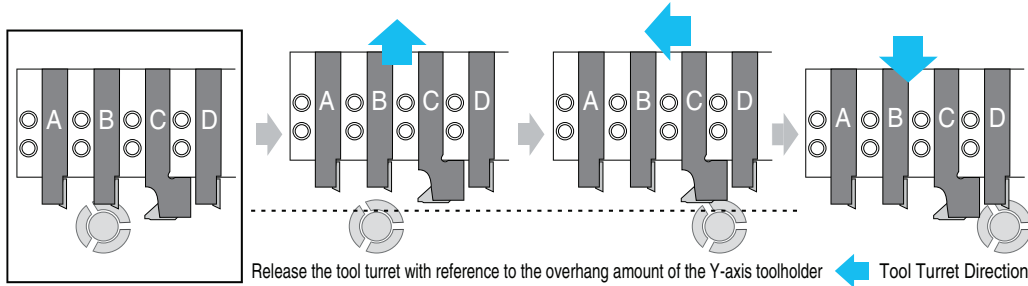

Release the tool turret with reference to the overhang amount of the Y-axis toolholder ← Tool Turret Direction

Note that using other toolholders together will result in different outside diameters

(Unit : mm)

Y-axis Toolholder Overhang	Examples	Overhang Amount L			
		Available Outside Cutting Diameter (d)	20	22	25
20		A	Without Restriction	Without Restriction	Without Restriction
		B	13.0	13.0	13.0
		C	Without Restriction	Without Restriction	Without Restriction
25		A	38.0	58.0	Without Restriction
		B	14.9	13.6	13.0
		C	45.0	60.0	Without Restriction



Direct coolant cut-off toolholders for automatic lathe

KTKF-JCTM

Finely breaks chips into small pieces. Superior chip control performance when machining difficult-to-cut material and stainless steel. Superior cooling action improves tool life.

1 Superior chip control performance

Discharges coolant in two directions toward rake surface of insert. Finely breaks chips into small pieces.

Coolant discharge structure comparison

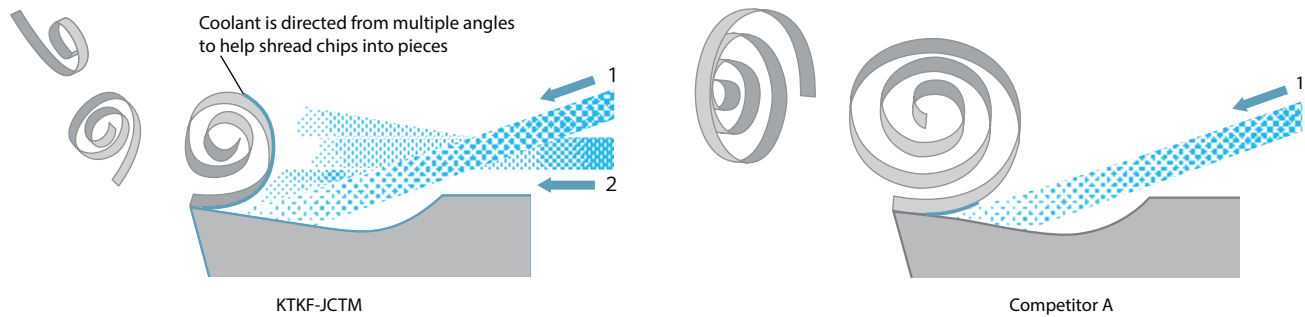

Chip control comparison (Internal evaluation)

SUS304				TAB6400 (Ti-6Al-4V)			
f (mm/rev)	0.01	0.02	0.03	f (mm/rev)	0.01	0.02	0.03
KTKF-JCTM				KTKF-JCTM			
Competitor A				Competitor A			

Cutting conditions: Vc = 80 m/min, Wet (Oil-based) lubricating pressure: 1.5 MPa (Internal)
Workpiece: φ12 mm

Coolant Flow Rate Comparison (Internal evaluation)

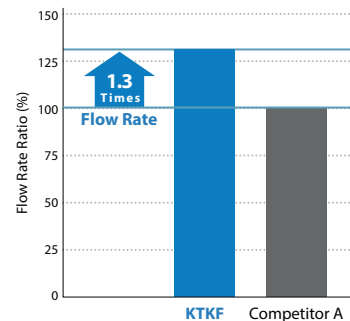

2 Superior cooling action improves tool life

Coolant is directed from the flank face of the insert as well. An ample supply of coolant to the tool edge area helps to further suppress insert wear.



Wear resistance comparison (Internal evaluation)

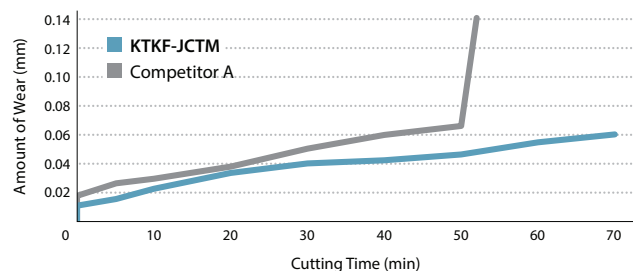

Cutting conditions: Vc = 100 m/min, f = 0.02 mm/rev, Wet (Oil-based)
Lubricating Pressure: 1.5 MPa (Internal) Workpiece material: TAB6400 (Ti-6Al-4v) φ12

KTKFR-JCTM (Coolant-through holders)

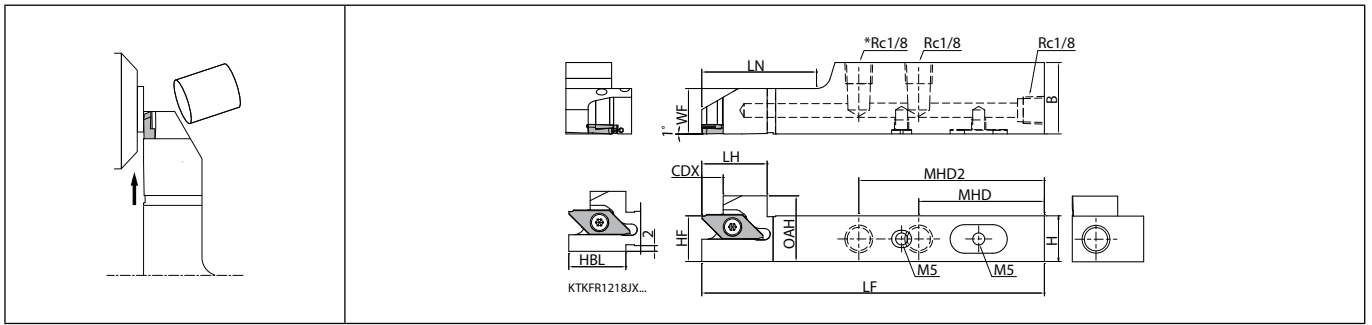

Right-hand shown | Right-hand Insert for Right-hand Toolholder. | KTKFR12-JCTM : 2-Rc1/8

Toolholder dimensions

Description	Availability		Dimension (mm)											Coolant hole	Spare parts				Applicable inserts H6~H8
	R	CDX	H	B	LH	OAH	MHD	MHD2	HF	HBL	LF	LN	WF		Plug	Plug	Screw	Wrench	
	KTKFR 1218JX-12JCTM	●		12	18	20	19	54	-	12	20		28		12	Yes	GP-1	HSSX4LP	
KTKFR 1625JX-12JCTM	●	7.5	16		23	27	44	65	16		120	40	16						
KTKFR 2025JX-12JCTM	●		20	25	23	27	44	65	20			40	20						
KTKFR 1625JX-16JCTM	●		16		23	27	44	65	16		120	40	16	Yes	GP-1	HSSX4LP	SB-4590TRWN	FT-10	TKF16R...
KTKFR 2025JX-16JCTM	●	9.6	20	25	23	27	44	65	20			41	20						

Recommended cutting conditions H19

KTKFL-JCTM (Coolant-through holders)

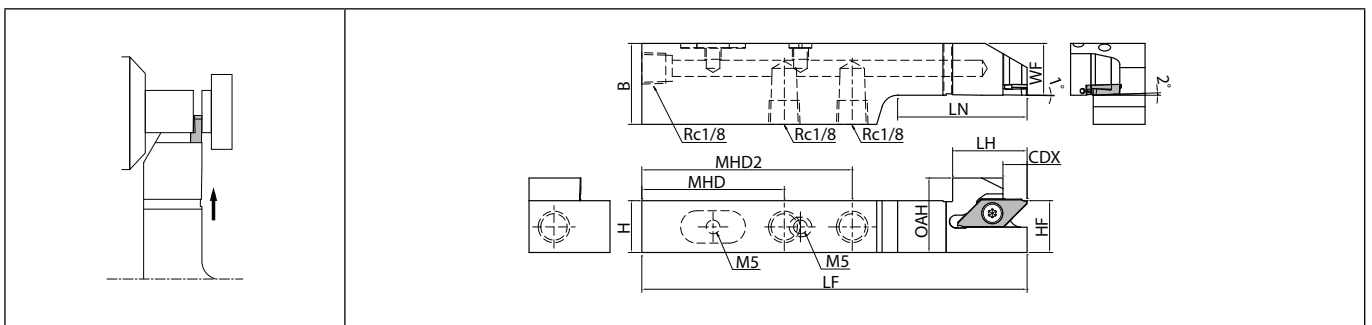

Left-hand shown | Left-hand Insert for Left-hand Toolholder.

Toolholder dimensions

Description	Availability		Dimension (mm)											Coolant hole	Spare parts				Applicable inserts H6~H8
	L	CDX	H	B	LH	OAH	MHD	MHD2	HF	LF	LN	WF	Plug		Plug	Screw	Wrench		
	KTKFL 1625JX-12JCTM	●		16	25	23	23	44	65	16	120	40	16		Yes	GP-1	HSSX4LP	SB-4590TRWN	
KTKFL 2025JX-12JCTM	●	7.5	20		27	44	65	20			40	20							
KTKFL 1625JX-16JCTM	●		16		23	27	44	65	16	120	40	16	Yes	GP-1	HSSX4LP	SB-4590TRWN	FT-10	TKF16L...	
KTKFL 2025JX-16JCTM	●	9.6	20	25	23	27	44	65	20			41	20						

Recommended cutting conditions H19

● : Standard item R : Right-hand only L : Left-hand only □ : Check availability



Coolant pipe parts

Pipe parts will be required separately if internal coolant is used.

Without coupling (Pump pressure: Up to 20 MPa)

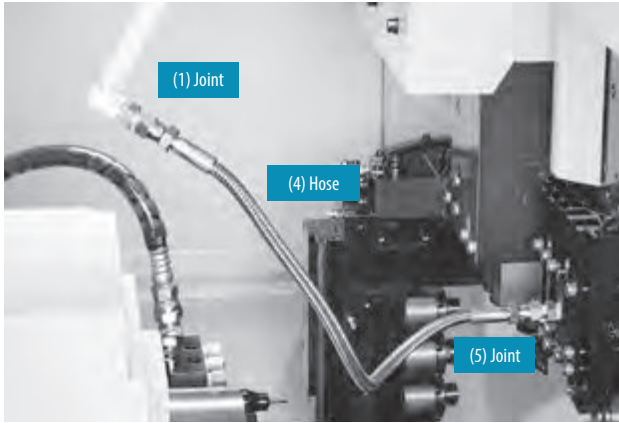

With coupling (Pump pressure: Up to 7.5 MPa)

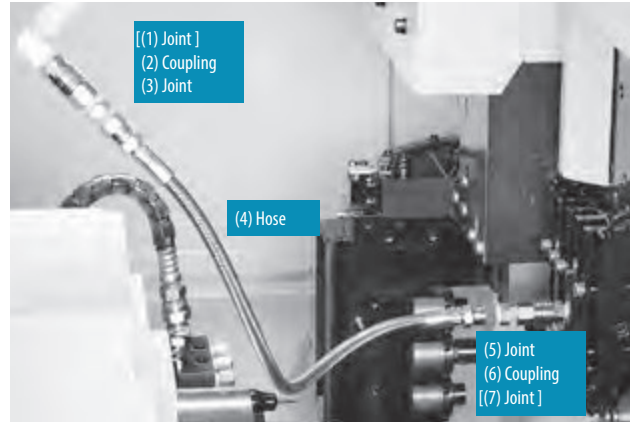

Combination part description (Example)

Spare parts	Description
(1) Joint	J-ST-R1/8-G1/8
(4) Hose	HS-G1/8-G1/8-500
(5) Joint	J-ST-R1/8-G1/8

Convert the thread standards on the machine's side (Rc1/4, Rc1/8, NPT1/8, etc.) to the thread standard on the hose side (G1/8) for use.
Use sealing agents such as seal tapes when installing piping parts.

Combination part description (Example)

Spare parts	Description
[(1) Joint]	-
(2) Coupling	CP-ST-R1/8,P-ST-RC1/8
(3) Joint	J-ST-R1/8-G1/8
(4) Hose	HS-G1/8-G1/8-500
(5) Joint	J-ST-R1/8-G1/8
(6) Coupling	P-ST-RC1/8,CP-ST-R1/8
[(7) Joint]	-

Convert the thread standards on the machine's side (Rc1/4, Rc1/8, NPT1/8, etc.) to thread standards of the coupling (Rc1/8, etc.) or hose (G1/8) for use.
Use sealing agents such as seal tapes when installing piping parts.

Without coupling (Pump pressure: Up to 20 MPa)



With coupling (Pump pressure: Up to 7.5 MPa)

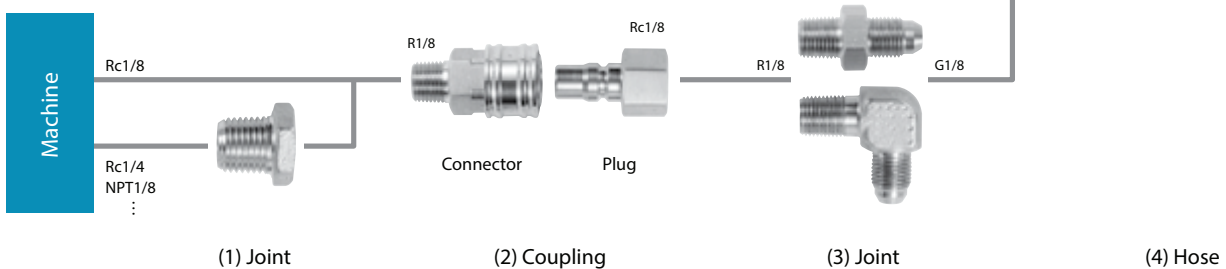

Piping installation parts description

Joint [(1)(3)(5)(7)]

Pressure resistance: ~20.0MPa

Exterior	Description	Thread standard	Std.
	J-ST-R1/4-G1/8	R1/4 ⇔ G1/8	●
	J-ST-NPT1/8-G1/8	NPT1/8 ⇔ G1/8	●
	J-ST-R1/8-G1/8	R1/8 ⇔ G1/8	●
	J-AN-R1/8-G1/8		●
	J-ST-R1/4-RC1/8	R1/4 ⇔ Rc1/8	●
	J-ST-NPT1/8-RC1/8	NPT1/8 ⇔ Rc1/8	●
	J-ST-R1/8-RC1/8	Rc1/8 ⇔ R1/8 (Extension Joint)	●

Coupling [(2)(6)]

Pressure resistance: ~7.5MPa

Exterior	Description	Thread standard	Std.
	CP-ST-R1/8	R1/8	●
	P-ST-RC1/8	Rc1/8	●

Hose (4)

Pressure resistance: ~20.0MPa

Exterior	Description	Thread standard	Total length (mm)	Std.
	HS-G1/8-G1/8-200	G1/8	200	●
	HS-G1/8-G1/8-300		300	●
	HS-G1/8-G1/8-400		400	●
	HS-G1/8-G1/8-500		500	●
	HS-G1/8-G1/8-600		600	●
	HS-G1/8-G1/8-800		800	●

Cautions

1. Make sure machine door is completely closed before use of these parts.
2. Use appropriate seal for the male thread of the piping parts and make sure the connection is secure.
Use plugs to seal off unused coolant holes.
3. Connect and fasten the coolant hose firmly.
4. The use of copper washers may cause leakage but will have no effect on the performance.
5. Commercial piping parts can be used if the thread standards are same. Check the pressure resistance before use.
6. Regularly changing the coolant filter is recommended.

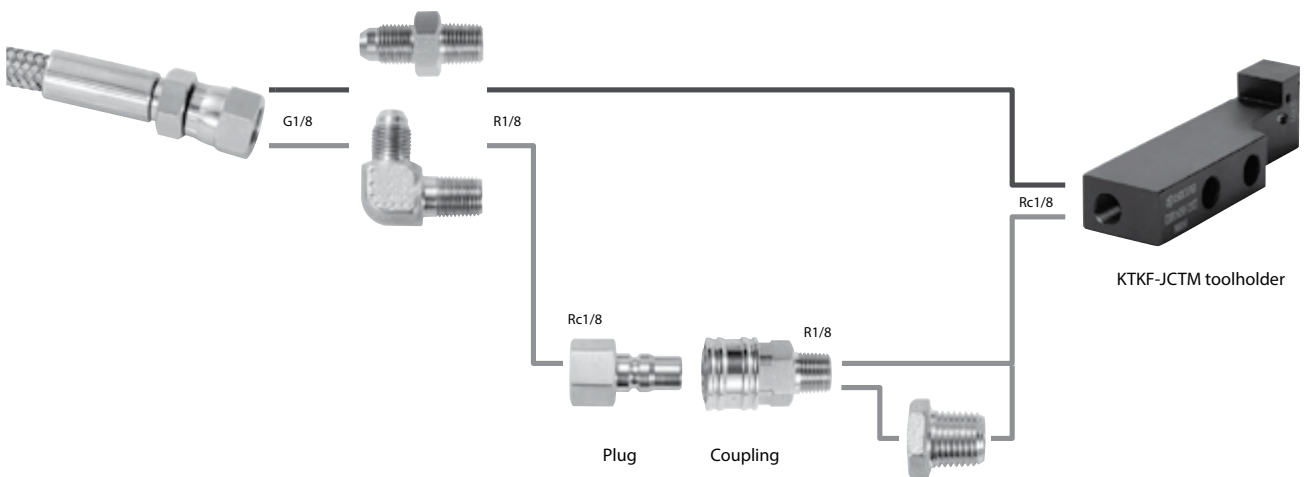

(4) Hose

(5) Joint

(6) Coupling

(7) Joint (Extension joint)

● : Standard item R : Right-hand only L : Left-hand only □ : Check availability



KTKF-S (Cut-off / for sub spindle tooling)

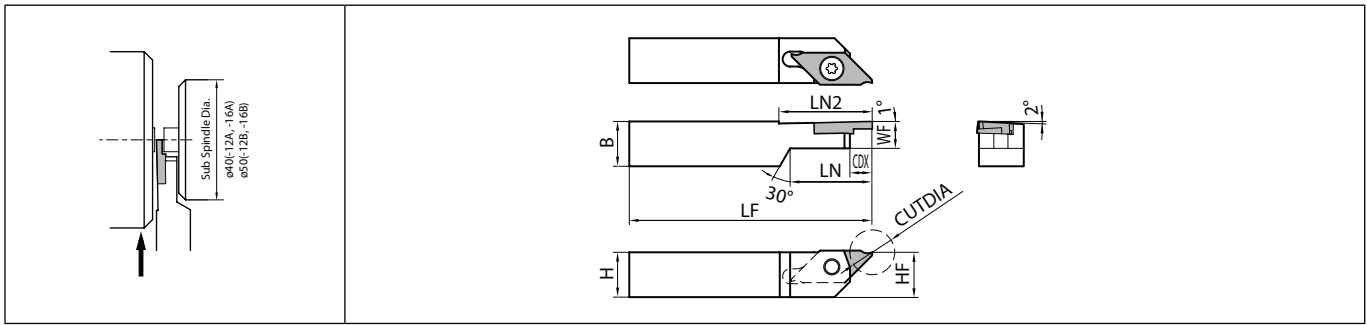

Right-hand shown | Right-hand Insert for Right-hand Toolholder.

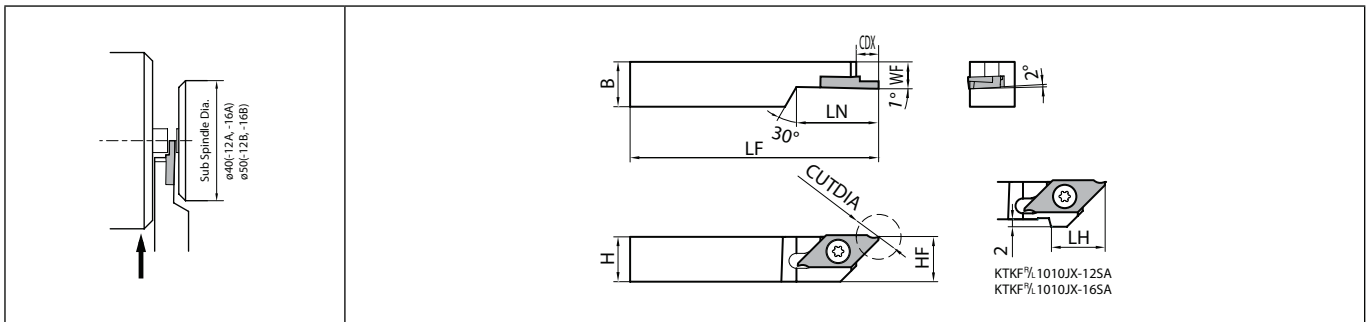

Left-hand shown | Left-hand Insert for Left-hand Toolholder.



Toolholder dimensions

Description	Availability		Dimension (mm)									Spare parts		Applicable inserts H6~H8
												Screw	Wrench	
	R	L	CDX	H	B	LH	HF	LF	LN	LN2	WF			
KTKF% 1010JX-12SA	●	●	6	10	10	15	10	120	22	26	7.2	SB-4570TRN	FT-10	TKF12%...
KTKF% 1212F-12SA	●	●		12	12	-	12	85						
KTKF% 1010JX-16SA	●	●	8	10	10	20	10	120	22	30	7.2	SB-4570TRN	FT-10	TKF16%...
KTKF% 1212F-16SA	●	●		12	12	-	12	85						
KTKF% 1212JX-16SB	●	●												

CDX shows the distance from the toolholder to the cutting edge.
 Cut-off diameter (CUTDIA) depends on the insert edge width.
 Only Right-hand is available for LN2 dimension.

Recommended cutting conditions **H19**

● : Standard item R : Right-hand only L : Left-hand only □ : Check availability

KTKF / KTKF-S Selection Reference

KTKF

- Both Right-hand and Left-hand types are applicable to gang tool post.
- Basically Left-hand type is used for cut-off operation using a sub spindle.

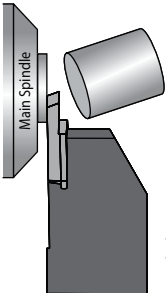
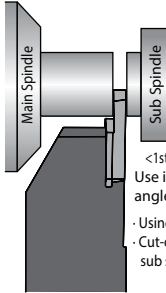
KTKFR (Right-hand toolholder)	KTKFL (Left-hand toolholder)
 <p><1st. Recommendation> Use insert with lead angle to remove boss. · Not using sub spindle · Cut-off operation near main spindle side</p>	 <p><1st. Recommendation> Use insert without lead angle. · Using sub spindle · Cut-off operation near sub spindle side</p>

KTKF-S

- When machining workpiece with small diameter, use KTKF-S to reduce overhang distance from the main spindle.

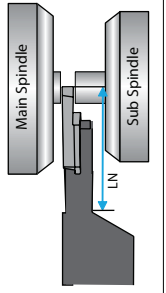
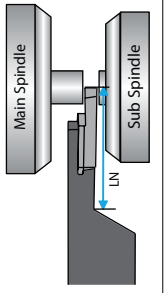
KTKFR-SA/B (Right-hand toolholder)	KTKFL-SA/B (Left-hand toolholder)
 <p><How to select> Hand of Toolholder · Long workpiece and more rigidity · Cut-off operation near main spindle side <How to select> LN dimension · Sub Spindle Dia. ø40→22 (SA type) ø50→26 (SB type)</p>	 <p><How to select> Hand of Toolholder · Short workpiece and less rigidity · Cut-off operation near sub spindle side <How to select> LN dimension · Sub Spindle Dia. ø40→22 (SA type) ø50→26 (SB type)</p>

Recommended cutting conditions (TKF12 / 16)







Workpiece material	Recommended insert grades (Vc: m/min)					TKF12						TKF16		Remarks		
	MEGACOAT NANO PLUS	MEGACOAT NANO	MEGACOAT	DLC coated carbide	Carbide	Edge width CW (mm)						1.5	2.0			
						0.5	0.7	1.0	1.25	1.5	2.0					
	PR1725	PR1535	PR1225	PDL025	KW10	f (mm/rev)										
Carbon steel	★ 70 ~ 170 (50 ~ 140)	☆ 70 ~ 150 (50 ~ 120)	☆ 70 ~ 150 (50 ~ 120)	-	-	0.01 ~ 0.02	0.01 ~ 0.03	0.01 ~ 0.04 (0.01 ~ 0.05)	0.01 ~ 0.04	0.01 ~ 0.04 (0.02 ~ 0.1)	0.01 ~ 0.04 (0.02 ~ 0.1)	0.02 ~ 0.07 (0.02 ~ 0.1)	0.02 ~ 0.07 (0.02 ~ 0.1)	Coolant		
Alloy steel	★ 70 ~ 170 (50 ~ 140)	☆ 70 ~ 150 (50 ~ 120)	☆ 70 ~ 150 (50 ~ 120)	-	-	0.01 ~ 0.02	0.01 ~ 0.03	0.01 ~ 0.04 (0.01 ~ 0.05)	0.01 ~ 0.04	0.01 ~ 0.04 (0.02 ~ 0.1)	0.01 ~ 0.04 (0.02 ~ 0.1)	0.02 ~ 0.07 (0.02 ~ 0.1)	0.02 ~ 0.07 (0.02 ~ 0.1)			
Stainless steel	☆ 60 ~ 140 (40 ~ 120)	★ 60 ~ 120 (40 ~ 100)	☆ 60 ~ 120 (40 ~ 100)	-	-	0.005 ~ 0.015	0.01 ~ 0.02	0.01 ~ 0.02 (0.01 ~ 0.03)	0.01 ~ 0.02	0.01 ~ 0.02 (0.01 ~ 0.05)	0.01 ~ 0.02 (0.01 ~ 0.05)	0.01 ~ 0.04 (0.01 ~ 0.05)	0.01 ~ 0.04 (0.01 ~ 0.05)			
Cast iron	-	-	-	-	★ 50 ~ 100	0.01 ~ 0.03	0.01 ~ 0.04	0.01 ~ 0.05	0.01 ~ 0.05	0.01 ~ 0.05	0.01 ~ 0.05	0.02 ~ 0.08	0.02 ~ 0.08			
Aluminum alloys	-	-	-	★ 200 ~ 500	☆ 200 ~ 450	0.01 ~ 0.03	0.01 ~ 0.04	0.01 ~ 0.05	0.01 ~ 0.05	0.01 ~ 0.05	0.01 ~ 0.05	0.02 ~ 0.08	0.02 ~ 0.08			
Brass	-	-	-	-	★ 100 ~ 200	0.01 ~ 0.03	0.01 ~ 0.04	0.01 ~ 0.06	0.01 ~ 0.06	0.01 ~ 0.06	0.01 ~ 0.06	0.02 ~ 0.1	0.02 ~ 0.1			

*(:):Tough edge type (TKF.T.)

★: 1st Recommendation ☆: 2nd Recommendation



GDM/GDMS/GDG

		Carbon steel / Alloy steel		Stainless steel		Cast iron		Non-ferrous metals		P		M		K		N		
Insert	Description	No. of edges	Dimension (mm)				Angle (°)	Tolerance (mm)		Carbide					Applicable toolholder H22, H24, H27 H28, H29, H31			
			CW	S	RE	INSL		PSIR%	CW min.	CW max.	DLC	PVD	-					
														PR1215		PR1225	PR1535	GM15
	GDM 1316N-003PF 1316N-015PF	2	1.3	3.7	0.03	16	-	-0.04	+0.04	●	●	●	●	●	●	●	●	KGDF/L...-1.3(D16) KGDS/L...-1.3B
	GDM 1516N-003PF 1516N-015PF				0.03					●	●	●	●	●	●	KGDF/L...-1.5(D16) KGDS/L...-1.5B		
	GDM 2020N-003PF 2020N-015PF	2	0.03	●	●	●				●	●	KGDF/L...-2(...) KGDS/L...-2B						
	GDM 2520N-003PF 2520N-015PF	2.5	0.03	●	●	●				●	●	KGDF/L...-2(...), KGDF/L...-2.4(...) KGDS/L...-2B						
	GDM 3020N-003PF 3020N-015PF	3	0.03	●	●	●				●	●	KGDF/L...-2(...), KGDF/L...-2.4(...) KGDF/L...-3(...), KGDS/L...-2B						
	GDM 1316R-003PF-15D 1316L-003PF-15D	2	1.3	3.7	0.03	15	-0.04	+0.04	●	●	●	●	●	●	●	●	KGDF/L...-1.3(D16) KGDS/L...-1.3B	
	GDM 1516R-003PF-15D 1516L-003PF-15D 1516R-015PF-15D				0.03				●	●	●	●	●	KGDF/L...-1.5(D16) KGDS/L...-1.5B				
	GDM 2020R-003PF-15D 2020L-003PF-15D 2020R-015PF-15D	2	0.03	●	●				●	●	●	KGDF/L...-2(...) KGDS/L...-2B						
	GDM 2520R-003PF-15D 2520L-003PF-15D 2520R-015PF-15D	2.5	0.03	●	●				●	●	●	KGDF/L...-2(...), KGDF/L...-2.4(...) KGDS/L...-2B						
	GDM 3020R-003PF-15D 3020L-003PF-15D 3020R-015PF-15D	3	0.03	●	●				●	●	●	KGDF/L...-2(...), KGDF/L...-2.4(...) KGDF/L...-3(...), KGDS/L...-2B						
	GDM 2020N-010PQ	2	2.5	4.3	0.1	20	-	-0.03	+0.03	●	●	●	●	●	●	●	KGDF/L...-2(...) KGDS/L...-2B	
	GDM 2520N-010PQ									●	●	●	●	●	●	KGDF/L...-2(...), KGDF/L...-2.4(...) KGDS/L...-2B		
	GDM 3020N-010PQ									●	●	●	●	●	●	KGDF/L...-2(...), KGDF/L...-2.4(...) KGDF/L...-3(...), KGDS/L...-2B		
	GDM 2020R-010PQ-15D	2	2.5	4.3	0.1	20	15	-0.03	+0.03	●	●	●	●	●	●	●	KGDF/L...-2(...) KGDS/L...-2B	
	GDM 2520R-010PQ-15D									●	●	●	●	●	●	KGDF/L...-2(...), KGDF/L...-2.4(...) KGDS/L...-2B		
	GDM 3020R-010PQ-15D									●	●	●	●	●	●	KGDF/L...-2(...), KGDF/L...-2.4(...) KGDF/L...-3(...), KGDS/L...-2B		
	GDG 2020N-005PG	2	2.5	4.3	0.05	20	-	-0.02	+0.02	●	●	●	●	●	●	●	KGDF/L...-2(...) KGDS/L...-2B	
	GDG 2520N-005PG									●	●	●	●	●	●	KGDF/L...-2(...), KGDF/L...-2.4(...) KGDS/L...-2B		
	GDG 3020N-005PG									●	●	●	●	●	●	KGDF/L...-2(...), KGDF/L...-2.4(...) KGDF/L...-3(...), KGDS/L...-2B		
	GDG 2020R-005PG-15D	2	2.5	4.3	0.05	20	15	-0.02	+0.02	●	●	●	●	●	●	●	KGDF/L...-2(...) KGDS/L...-2B	
	GDG 2520R-005PG-15D									●	●	●	●	●	●	KGDF/L...-2(...), KGDF/L...-2.4(...) KGDS/L...-2B		
	GDG 3020R-005PG-15D									●	●	●	●	●	●	KGDF/L...-2(...), KGDF/L...-2.4(...) KGDF/L...-3(...), KGDS/L...-2B		

Handed insert shows Right-hand
Using the PF / PM chipbreaker (for cut-off) for grooving cannot create a flat bottom (Ref. to the right figure).

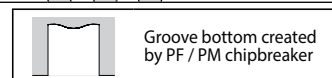

● : Standard item R : Right-hand only L : Left-hand only □ : Check availability

GDM/GDMS/GDG

Insert		Description	No. of edges	Dimension (mm)					Angle (°)	Tolerance (mm)		Carbide	Applicable toolholder H22, H27~H29, H31
				CW	S	RE	INSL	PSIR%L		CW min.	CW max.		
				Carbon steel / Alloy steel						P			
				Stainless steel						M			
				Cast iron						K			
				Non-ferrous metals						N			
 General purpose	GDM 2020N-020PM	2										KGD [®] /L...-2(...) KGD [®] /L...-2B	
	GDM 2520N-020PM	2	2.5	4.3		20	-	-0.03	+0.03			KGD [®] /L...-2(...), KGD [®] /L...-2.4(...) KGD [®] /L...-2B	
	GDM 3020N-025PM	2	3									KGD [®] /L...-2(...), KGD [®] /L...-2.4(...) KGD [®] /L...-3(...), KGD [®] /L...-2B	
	GDM 4020N-030PM	2	4									KGD [®] /L...-3(...), KGD [®] /L...-3... KGD [®] /L...-4T...	
 General purpose	GDM 2020R-020PM-6D	2										KGD [®] /L...-2(...) KGD [®] /L...-2B	
	GDM 2520R-020PM-6D	2	2.5	4.3		20	6	-0.03	+0.03			KGD [®] /L...-2(...), KGD [®] /L...-2.4(...) KGD [®] /L...-2B	
	GDM 3020R-025PM-6D	2	3									KGD [®] /L...-2(...), KGD [®] /L...-2.4(...) KGD [®] /L...-3(...), KGD [®] /L...-2B	
 General purpose	GDMS 2020N-020PM	1	2	4.3	0.2	20	-	-0.03	+0.03			KGD [®] /L...-2(...) KGD [®] /L...-2B	
	GDMS 3020N-025PM	1	3		0.25							KGD [®] /L...-2(...), KGD [®] /L...-2.4(...) KGD [®] /L...-3(...), KGD [®] /L...-2B	
	GDMS 4020N-030PM	1	4		0.3							KGD [®] /L...-3(...), KGD [®] /L...-3... KGD [®] /L...-4T...	
 General purpose	GDMS 2020R-020PM-6D	1	2	4.3	0.2	20	6	-0.03	+0.03			KGD [®] /L...-2(...) KGD [®] /L...-2B	
	GDMS 3020R-025PM-6D	1	3		0.25							KGD [®] /L...-2(...), KGD [®] /L...-2.4(...) KGD [®] /L...-3(...), KGD [®] /L...-2B	
	GDMS 4020R-030PM-6D	1	4		0.3							KGD [®] /L...-3(...), KGD [®] /L...-3... KGD [®] /L...-4T...	
 High feed	GDM 2020N-020PH	2			0.2	20	-	-0.03	+0.03			KGD [®] /L...-2(...) KGD [®] /L...-2B	
	GDM 3020N-030PH	2	3	4.3	0.3							KGD [®] /L...-2(...), KGD [®] /L...-2.4(...) KGD [®] /L...-3(...), KGD [®] /L...-2B	
	GDM 4020N-030PH	2	4		0.3							KGD [®] /L...-3(...), KGD [®] /L...-3... KGD [®] /L...-4T...	
 1-edge / High feed	GDMS 2020N-020PH	1	2	4.3	0.2	20	-	-0.03	+0.03			KGD [®] /L...-2(...) KGD [®] /L...-2B	
	GDMS 3020N-030PH	1	3		0.3							KGD [®] /L...-2(...), KGD [®] /L...-2.4(...) KGD [®] /L...-3(...), KGD [®] /L...-2B	
	GDMS 4020N-030PH	1	4		0.3							KGD [®] /L...-3(...), KGD [®] /L...-3... KGD [®] /L...-4T...	

Handed insert shows Right-hand
Using the PF / PM chipbreaker (for cut-off) for grooving cannot create a flat bottom (Ref. to the right figure).

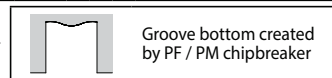

Inserts identification system

Tolerance symbol		Edge width				Hand of tool		Chipbreaker symbol			
G	Ground insert	13	1.3 mm	25	2.5 mm	R	Right-hand	PF	Cut-off (Low feed)	PM	Cut-off (General purpose)
M	M class	15	1.5 mm	30	3 mm	L	Left-hand	PQ	Cut-off (Medium feed)	PH	Grooving and cut-off (High feed rate)
		20	2 mm	40	4 mm	N	Neutral	PG	Cut-off (Low cutting force)		

GD	M	S	30	20	R	-	025	PM	-	6D
Series	No. of edge		Insert length		Corner-R (RE)			Lead angle		
Grooving / Cut-off GD Series	No indication 2-edge S 1-edge		16 16 mm 20 20 mm		003 0.03 mm 020 0.2 mm 005 0.05 mm 025 0.25 mm 010 0.1 mm 030 0.3 mm 015 0.15 mm			No indication 0° 6D 6° 15D 15°		

● : Standard item R : Right-hand only L : Left-hand only □ : Check availability

KGD (for Automatic Lathe)

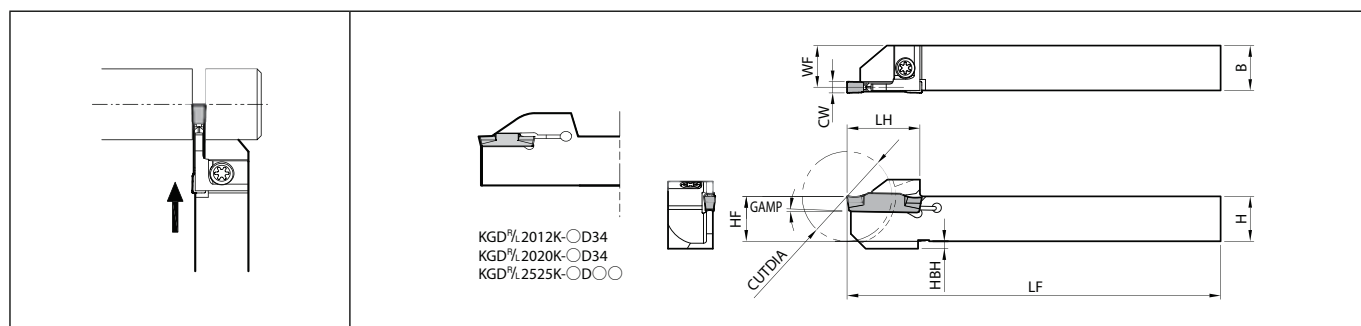

Right-hand shown

Toolholder dimensions

Description	Availability		Dimension (mm)													Angle	Spare parts					Applicable inserts H20, H21
																	Clamp bolt	Screw	Screw	Wrench	Wrench	
KGD% 1010JX-1.3D16 1010JX-1.3 1212F-1.3D16 1212JX-1.3D16 1212F-1.3 1212JX-1.3	R	L	CUTDIA	H	B	LH	HF	HBH	LF	WF	CW min.	CW max.	GAMP (°)						GDM1316...			
	●	●	16	10	10	18	10		120	9.9			5	-	SB-40120TR	-	-	LTW-15S				
	●	●	20							9.5												
	●	●	16					2	85	11.3	1.3	1.3										
	●	●	12	12	12	19.5	12		120	11.5												
	●	●	24						85	11.5												
KGD% 1010JX-1.5D16 1010JX-1.5 1212F-1.5D16 1212JX-1.5D16 1212F-1.5 1212JX-1.5	R	L	CUTDIA	H	B	LH	HF	HBH	LF	WF	CW min.	CW max.	GAMP (°)						GDM1516...			
	●	●	16	10	10	18	10		120	9.7			5	-	SB-40120TR	-	-	LTW-15S				
	●	●	20							9.4												
	●	●	16					2	85	11.7	1.5	1.5										
	●	●	12	12	12	19.5	12		120	11.4												
	●	●	24						85	11.4												
KGD% 1010JX-2 1212F-2 1212JX-2 1616JX-2 2012K-2D34 2020K-2D34 2525K-2D34	R	L	CUTDIA	H	B	LH	HF	HBH	LF	WF	CW min.	CW max.	GAMP (°)						GDG2020... GDM2020... GDMS2020... GDG2520... GDM2520... GDG3020... GDM3020... GDMS3020...			
	●	●	20	10	10	18	10		120	9.2			1	-	SB-40120TR	-	-	LTW-15S				
	●	●	24	12	12	19.5	12	2	85	11.2												
	●	●	32	16	16	24.5	16		120	15.2	2	3										
	●	●	20	12	12	19.5	12		11.2													
	●	●	34	20	20	32.5	20	-	125	19.2			0	HH5X16	-		LW-4	-				
	●	●	25	25	25	25			24.2													
	●	●	20	10	10	18	10		120	9				1	-	SB-40120TR	-	-		LTW-15S		
KGD% 1010JX-2.4 1212F-2.4 1212JX-2.4 1616JX-2.4 2012K-2.4D34 2020K-2.4D34 2525K-2.4D34	R	L	CUTDIA	H	B	LH	HF	HBH	LF	WF	CW min.	CW max.	GAMP (°)						GDG2520... GDM2520... GDG3020... GDM3020... GDMS3020...			
	●	●	24	12	12	19.5	12	2	85	11			1	-	SB-40120TR	-	-	LTW-15S				
	●	●	32	16	16	24.5	16		120	15	2.4	3										
	●	●	20	12	12	19.5	12		11													
	●	●	34	20	20	32.5	20	-	125	19			0	HH5X16	-		LW-4	-				
	●	●	25	25	25	25			24													
	●	●	20	10	10	18	10		120	9				1	-	SB-40120TR	-	-		LTW-15S		
	●	●	24	12	12	19.5	12	2	120	10.8	3	3	1	-	SB-40120TR	-	-	LTW-15S				
KGD% 1616JX-3 1616JX-3D38 1913K-3D38 2012JX-3D42 2012JX-3D51 2020JX-3D42 2020JX-3D51 2525K-3D51	R	L	CUTDIA	H	B	LH	HF	HBH	LF	WF	CW min.	CW max.	GAMP (°)						GDG3020... GDM3020... GDMS3020... GDM4020... GDMS4020...			
	●	●	32	16	16	24.5	16		120	14.8			1	-	SB-40120TR	-	-	LTW-15S				
	●	●	38	19	13	29	19		125	11.8												
	●	●	42			31			10.8	3	4											
	●	●	51	20	12	36	20	-	120	18.8			1	-	SE-50125TR	-	-	LTW-20				
	●	●	42	20	20	31	20		120	18.8												
	●	●	51	25	25	41.5	25		125	23.8			0	HH5X16	-		LW-4	-				
	●	●	32	16	16	24.5	16		120	14.8												
	●	●	38	19	13	29	19		125	11.8												
	●	●	42			31			10.8	3	4											

4mm width Insert cannot be installed in KGD% 1212JX-3

Recommended tightening torque of clamp screw : 2.0N·m (SB-40120TR), 2.5N·m (SE-50125TR), 6.5N·m (HH5X16)

When machining the material greater than ø36 mm with KGD%...-3D38, KGD%...-3D42 and KGD%...-3D51 toolholders, please use 1-edge inserts.

Maximum cutting diameter for 2-edge inserts is ø36 mm.

● : Standard item R : Right-hand only L : Left-hand only □ : Check availability

Recommended cutting conditions H32, H33

Toolholder identification system

KGD / KGDS (for automatic lathe)

KGD
KGDS

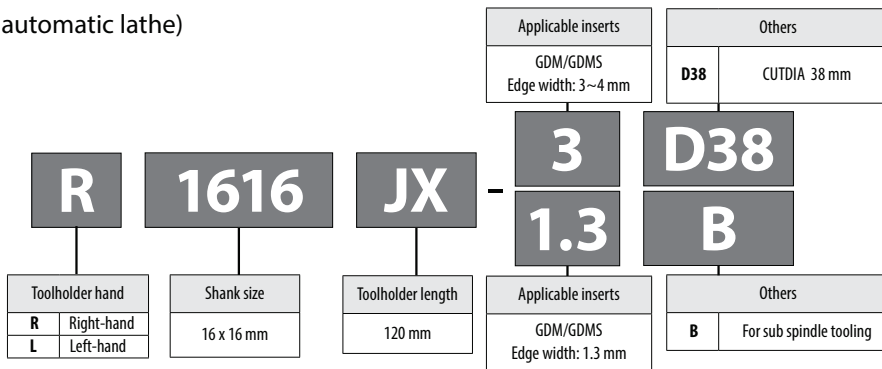

KGDS (Cut-off / for sub spindle tooling)

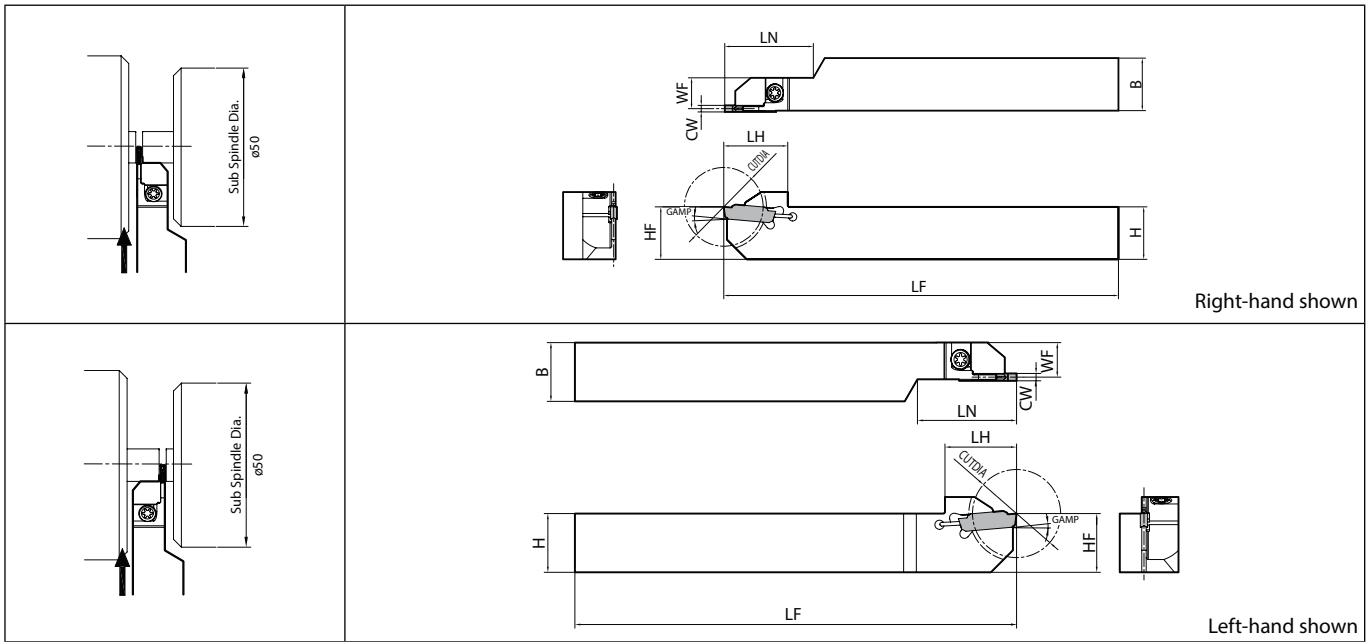

H



Cut-Off

Toolholder dimensions

Description	Availabi- lity		Dimension (mm)											Angle GAMP (°)	Spare parts		Applicable inserts ➔ H20, H21				
			R	L	CUTDIA	H	B	LH	HF	LF	LN	WF	CW		Screw 	Wrench 					
	min.	max.																			
KGDS%L 1616JX-1.3B	●	●													9.5	1.3	1.3	SB-40120TR	LTW-15S	GDM1316...	
1616JX-1.5B	●	●	24	16	16	19.5	16	120	27					9.4	1.5	1.5					GDM1516...
1616JX-2B	●	●												9.2	2	3					GDG2020..., GDM2020..., GDMS2020..., GDG2520..., GDM2520..., GDG3020..., GDM3020..., GDMS3020...

Recommended cutting conditions ➔ H32, H33

● : Standard item R : Right-hand only L : Left-hand only □ : Check availability

KGD / KGDS Selection Reference

KGD

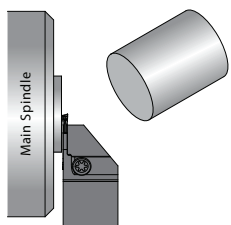
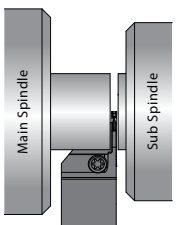
Standard type	
<ul style="list-style-type: none"> Both Right-hand and Left-hand types are applicable to gang tool post. Basically Left-hand type is used for cut-off operation using a sub spindle. 	
KGDR (Right-hand toolholder)	KGDL (Left-hand toolholder)
	
<p><1st. Recommendation> Use insert with lead angle to remove boss.</p> <ul style="list-style-type: none"> Not using sub spindle Cut-off operation near main spindle side 	<p><1st. Recommendation> Use insert without lead angle.</p> <ul style="list-style-type: none"> Using sub spindle Cut-off operation near sub spindle side

KGDS

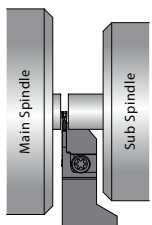
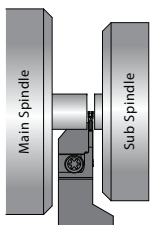
Sub spindle type	
<ul style="list-style-type: none"> When machining workpiece with small diameter, use KGDS to reduce overhang distance from the main spindle. 	
KGDSR (Right-hand toolholder)	KGDSL (Left-hand toolholder)
	
<ul style="list-style-type: none"> Long workpiece and more rigidity Cut-off operation near main spindle side 	<ul style="list-style-type: none"> Short workpiece and less rigidity Cut-off operation near sub spindle side



Direct coolant cut-off toolholders for automatic lathe

KGD-JCTM (for automatic lathe)

1 Optimized coolant hole position

2 Discharge coolant towards the flank face of the insert

Directing coolant towards the cutting edge lengthens tool life.

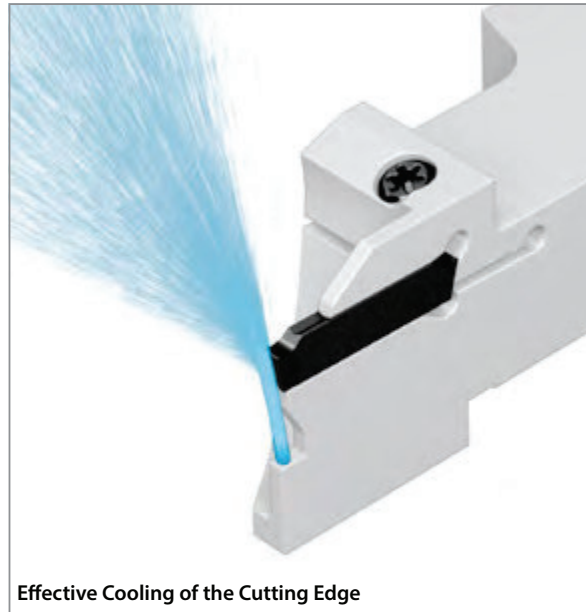

Effective Cooling of the Cutting Edge

Coolant discharging

KGD-JCTM

Competitor A

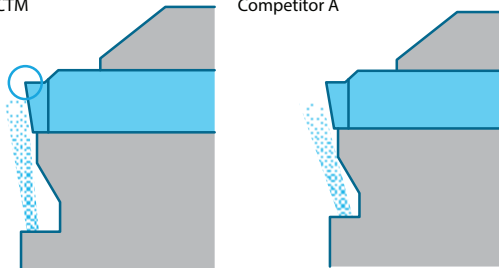

Sufficient cooling towards the cutting edge

Coolant does not flow directly towards the cutting edge

H



Cut-Off

Wear resistance comparison (Internal evaluation)

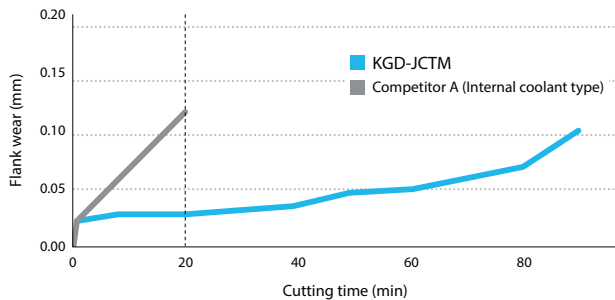

Cutting conditions: $V_c = 80$ m/min, $f = 0.06$ mm/rev (~2 mm : $f = 0.02$ mm/rev),
 KGDR1625JX-2JCTM, GDM2020N-015PF PR1535 (CW: 2.0 mm)
 Workpiece material : SUS304 (ø25) Internal coolant (1.5MPa) Cut-off

Cutting edge condition (after machining 20min)

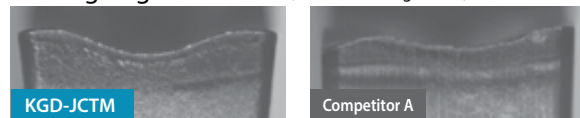

High density and high speeds coolant provides effective cooling of the cutting edge
 Superior cooling action improves tool life

KGD (Integral type)

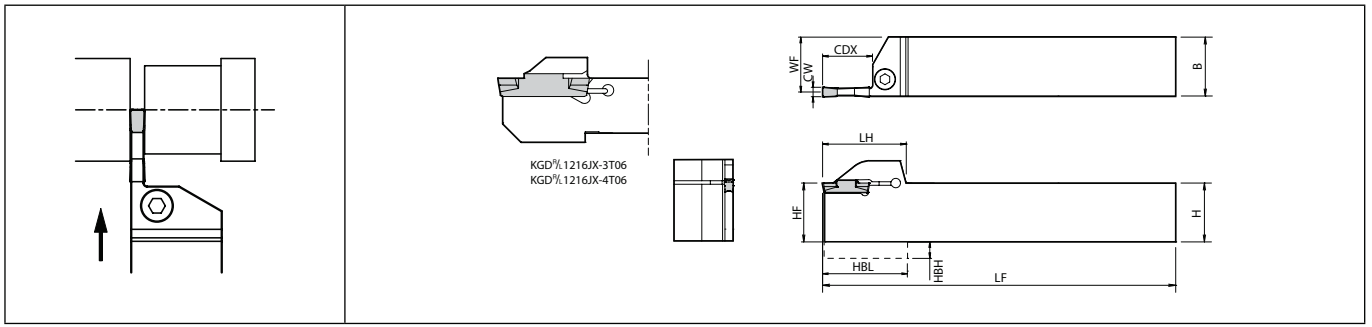

Right-hand shown

Toolholder dimensions

Description	Availability		Dimension (mm)											Spare parts				Applicable inserts H20, H21
			R	L	CDX	H	B	LH	HF	HBH	HBL	LF	WF	CW min.	CW max.	Clamp bolt	Screw	
	KGD% 1616H-2T06 1616H-2T10 1616H-2T17 2012K-2T17 2020K-2T06 2020K-2T10 2020K-2T17 2525M-2T06 2525M-2T10 2525M-2T17	●	●	6	16	16	27.7 30.2 31.2	16	4	28 30.5 31.5	100	15.2			HH5X16	-	LW-4	
KGD% 2012K-2.4T17 2020K-2.4T17	●	●	17	20	20	32.5	20	-	-	125	11 19	2.4	3	HH5X16	-	LW-4	-	GDG2520..., GDM2520..., GDG3020... GDM3020..., GDMS3020...
KGD% 1216JX-3T06 1616H-3T06 1616H-3T10 1616H-3T20 2012K-3T20 2020K-3T06 2020K-3T10 2020K-3T20 2525M-3T06 2525M-3T10 2525M-3T20	●	●	6	12	16	19.5 27.7 30.2 34.2	12	2	19 28 30.5 34.5	120	14.8			HH5X16	SE-5012STR	-	LW-4	LW-20 GDG3020... GDM3020... GDMS3020... GDM4020... GDMS4020...
KGD% 1216JX-4T06 2020K-4T10 2020K-4T20 2525M-4T10 2525M-4T20 2525M-4T25	●	●	6	12	16	19.5 30.5 34.5	12	2	19	120	14.3			HH5X16	SE-5012STR	-	LW-4	GDM4020... GDMS4020...

CDX : Maximum depth to which processing can be made. (If the CDX is 20 mm or more, the maximum groove-depth of groove made by the 2-edge insert will be 18 mm.)

Recommended tightening torque of clamp bolt : 6.5N·m (HH5X16), 8.0N·m (HH6X25), 2.5N·m (SE-5012STR)

Above toolholders are applicable to external grooving, too.

Recommended cutting conditions H32, H33

Toolholder identification system

KGD (Integral type)

KGD **R** **1616** **H** - **2** **T** **06**

Toolholder hand R Right-hand L Left-hand	Shank size 16 × 16 mm	Toolholder length 100mm	Applicable inserts GDM/GDMS 2~3 mm	Max. depth of cut 06: 6 mm
--	--------------------------	----------------------------	--	-------------------------------

● : Standard item R : Right-hand only L : Left-hand only □ : Check availability

KGD-S (0° separate type)

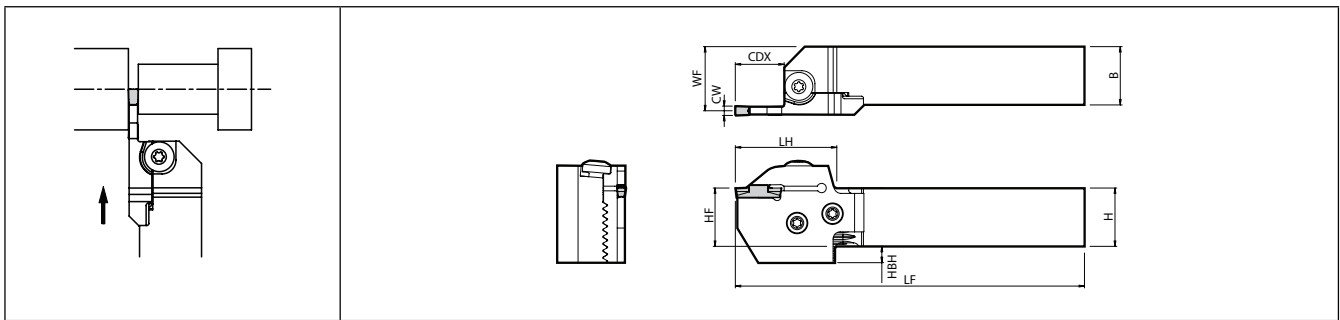

Right-hand shown (Right-hand blade and right-hand toolholder)

Toolholder dimensions (Blade and toolholder)

Shank angle	Width (mm)	Max. depth of cut (mm)	Shank size (mm)	Unit description	Availability		Blade description G43	Toolholder description G43	Dimension (mm)										Spare parts				
					R	L			CDX	H	B	LH	HF	HBH	LF	WF	CW min.	CW max.	Clamp bolt (for insert clamp)	Screw (for blade)	Wrench		
0°	2	17	20	KGD% 2020X-2T17S	●		KGD%L-2T17-C	KGD% 2020-C	20	20		20	12	122	23.4	2	3	BH6X10TR	SB-60120TR	LTW-25			
				KGD% 2525X-2T17S	●	●			KGD% 2525-C	17	25	25	40	25	7						147	28.4	
				No unit description ⇨					KGD% 3232-C	32	32		32	-	167						35.4		
	3	10	10	20	KGD% 2020X-3T10S	●		KGD%L-3T10-C	KGD% 2020-C	20	20		20	12	115	23	3				4		
					KGD% 2525X-3T10S	●	●			KGD% 2525-C	10	25	25	33	25	7						140	28
					No unit description ⇨					KGD% 3232-C	32	32		32	-	160						35	
	20	20	20	20	KGD% 2020X-3T20S	●	●	KGD%L-3T20-C	KGD% 2020-C	20	20		20	12	125	23	3				4		
					KGD% 2525X-3T20S	●	●			KGD% 2525-C	20	25	25	43	25	7						150	28
					KGD% 3232X-3T20S	●				KGD% 3232-C	32	32		32	-	170						35	
	4	10	10	20	KGD% 2020X-4T10S	●		KGD%L-4T10-C	KGD% 2020-C	20	20		20	12	115	22.5	4				5		
					KGD% 2525X-4T10S	●				KGD% 2525-C	10	25	25	33	25	7						140	27.5
					No unit description ⇨					KGD% 3232-C	32	32		32	-	160						34.5	
20		20	20	20	KGD% 2020X-4T20S	●		KGD%L-4T20-C	KGD% 2020-C	20	20		20	12	125	22.5	4	5					
					KGD% 2525X-4T20S	●	●			KGD% 2525-C	20	25	25	43	25	7			150	27.5			
					KGD% 3232X-4T20S	●				KGD% 3232-C	32	32		32	-	170			34.5				
25	25	25	25	KGD% 2020X-4T25S	●	●	KGD%L-4T25-C	KGD% 2020-C	20	20		20	12	130	22.5	4	5						
				KGD% 2525X-4T25S	●	●			KGD% 2525-C	25	25	25	48	25	7			155	27.5				
				KGD% 3232X-4T25S	●				KGD% 3232-C	32	32		32	-	175			34.5					

- When using the toolholder in normal mounting position, the lower jaw of toolholder may interfere with the tool presetter.
- The toolholder and blade descriptions are printed on the toolholder body. (Unit description is not printed.)
KGD-S: Right-hand blade for right-hand toolholder, left-hand blade for left-hand toolholder.
The toolholder is applicable for all blade with suitable hand.
- When the unit description is not available (No unit description) and/or stock status is "", please purchase toolholder and blade separately.
- CDX: Maximum depth to which processing can be made. (If the CDX is 20 mm or more, the maximum groove-depth of groove made by the 2-edge insert will be 18 mm.)
- Recommended tightening torque of clamp bolt for insert : 6.5N·m (Groove width 2 ~ 4mm)
- Above toolholders are applicable to external grooving, too.

Applicable inserts **H20, H21**
Recommended cutting conditions **H32, H33**

Toolholder identification system

KGD (Separate type / Unit description)

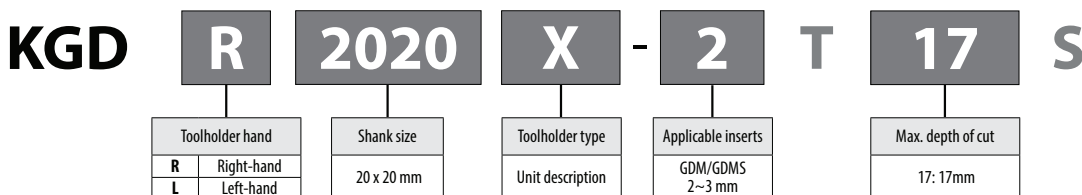

● : Standard item R : Right-hand only L : Left-hand only □ : Check availability



Great for High Pressure Coolant External Grooving and Cut-off

KGD-JCT

Coolant is directed from two directions towards the flank face of the insert
Improved Chip Control and Longer Tool Life for External Grooving and Cutting-off

1 Excellent Chip Control

Coolant towards the rake face

Coolant hole position and angle improve chip control

Chip Control Comparison (Internal evaluation)

KGD-JCT showed better chip control performance even at lower feed rates

$f = 0.05 \text{ mm/rev}$ (1.5MPa)

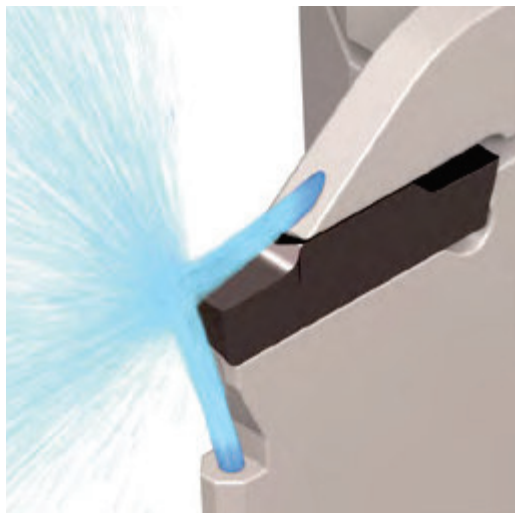

Cutting Conditions : $V_c = 150 \text{ m/min}$, $d = 8 \text{ mm}$, $f = 0.05 \text{ mm/rev}$, Wet
Edge Width 4 mm Workpiece Material : 15CrMo4 Grooving

2 Cooling the Cutting Edge Leads to Longer Tool Life

Coolant towards the rake surface and the flank face of the insert
Directing coolant towards the cutting edge lengthens tool life

Wear Resistance Comparison (Internal evaluation)

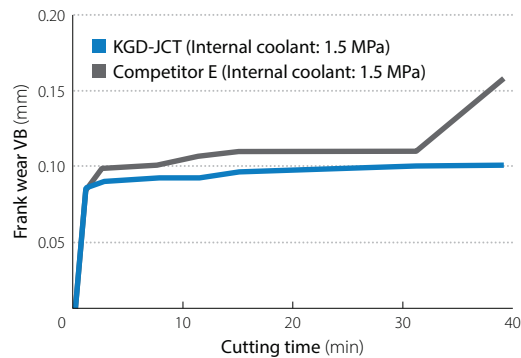
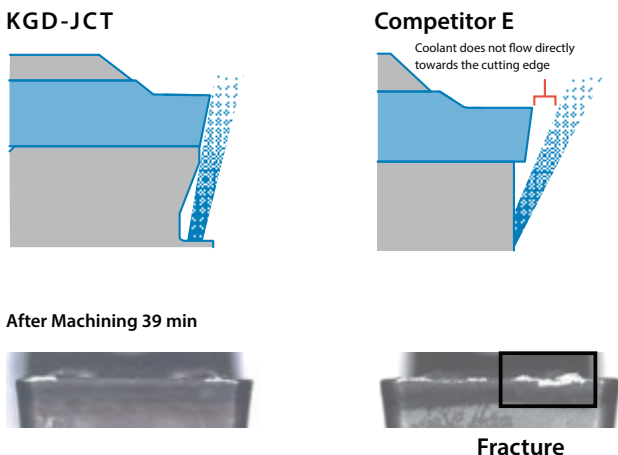

Cutting Conditions : $V_c = 180 \text{ m/min}$, $d = 9 \text{ mm}$, $f = 0.15 \text{ mm/rev}$, Wet
Edge Width 4 mm Workpiece Material : 15CrMo4 Grooving

KGD-JCT Minimizes Wear and Provides Longer Tool Life without Insert Fracturing

KGD-JCT (Coolant-through holders)

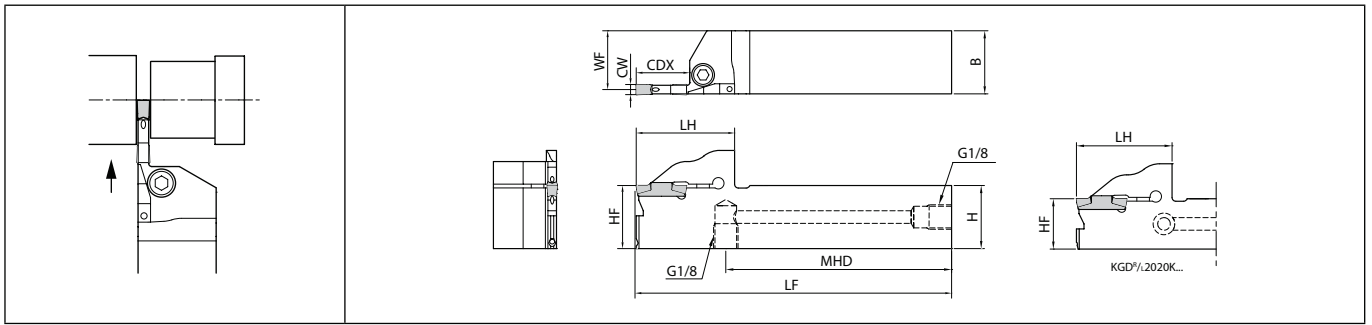

Right-hand shown | Pressure Resistance : ~15MPa

Toolholder dimensions

Description	Availability		Dimension (mm)										Spare parts			Applicable inserts ● H20, H21	
													Clamp bolt	Plug	Wrench		
	R	L	CDX	H	B	LH	HF	LF	WF	MHD	CW min.	CW max.					
KGD [®] /L 2020K-3T06JCT 2020K-3T10JCT 2020K-3T20JCT 2525K-3T06JCT 2525K-3T10JCT 2525K-3T20JCT	●	●	6			31.5											HH5X16 HSG1/8X8.0 LW-4 GDG3020... GDM3020... GDMS3020... GDM4020... GDMS4020...
	●	●	10	20	20	34	20		18.8	94.2							
	●	●	20			38		125		90.2							
	●	●	6			31.5				96.5							
	●	●	10	25	25	34	25		23.8	94.5							
KGD [®] /L 2020K-4T10JCT 2020K-4T20JCT 2525K-4T10JCT 2525K-4T20JCT 2525K-4T25JCT	●	●	10			34				94.2							HH5X16 HSG1/8X8.0 LW-4 GDM4020... GDMS4020...
	●	●	20	20	20	38			18.3	90.2							
	●	●	10			34		125		94.5							
	●	●	20	25	25	39	25		23.3	89.5							
	●	●	25			44				84.5							

Please see page D12 for piping parts of coolant-through holders.

Recommended cutting conditions ● H32, H33



Toolholder identification system

KGD (Integral type)

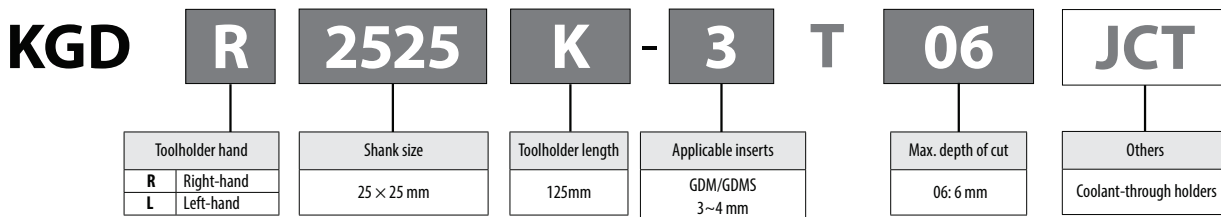

● : Standard item R : Right-hand only L : Left-hand only □ : Check availability

KGD recommended cutting conditions (PF/PQ/PG chipbreaker)

Workpiece material	Recommended insert grades (Vc: m/min)			f (mm/rev)						Remarks
				PF (RE = 0.03 mm)			PF (RE = 0.15 mm)			
	MEGACOAT NANO	MEGACOAT		Edge width CW (mm)						
PR1535	PR1225	PR1215	1.3 / 1.5	2.0	2.5 / 3.0	1.3 / 1.5	2.0	2.5 / 3.0		
Carbon steel	☆ 70 ~ 150	★ 70 ~ 150	☆ 70 ~ 180	0.01 ~ 0.04	0.02 ~ 0.06	0.02 ~ 0.08	0.01 ~ 0.05	0.03 ~ 0.08	0.04 ~ 0.10	
Alloy steel	☆ 70 ~ 150	★ 70 ~ 150	☆ 70 ~ 180							
Stainless steel	★ 60 ~ 120	☆ 60 ~ 120	☆ 60 ~ 150							
Cast iron	-	-	★ 80 ~ 200							

★: 1st Recommendation ☆: 2nd Recommendation

Workpiece Material	Recommended insert grades (Vc: m/min)					f (mm/rev)				Remarks
						PQ		PG		
	MEGACOAT NANO	MEGACOAT		DLC coated carbide	Carbide	Edge width CW (mm)				
PR1535	PR1225	PR1215	PDL025	GW15	2.0	2.5 / 3.0	2.0	2.5 / 3.0		
Carbon steel	☆ 70 ~ 150	★ 70 ~ 150	☆ 70 ~ 180	-	-	0.03 ~ 0.1	0.04 ~ 0.12	0.01 ~ 0.04	0.01 ~ 0.05	
Alloy steel	☆ 70 ~ 150	★ 70 ~ 150	☆ 70 ~ 180	-	-					
Stainless steel	★ 60 ~ 120	☆ 60 ~ 120	☆ 60 ~ 150	-	-	0.02 ~ 0.07	0.02 ~ 0.08	0.01 ~ 0.03	0.01 ~ 0.04	
Cast iron	-	-	★ 80 ~ 200	-	☆ 50 ~ 100	0.04 ~ 0.1	0.04 ~ 0.12	0.01 ~ 0.04	0.01 ~ 0.05	
Aluminum Alloys	-	-	-	★ 200 ~ 500	☆ 200 ~ 450	-	-	0.01 ~ 0.05	0.01 ~ 0.06	
Brass	-	-	-	-	★ 100 ~ 200	-	-	0.01 ~ 0.07	0.01 ~ 0.08	

★: 1st Recommendation ☆: 2nd Recommendation

Application map

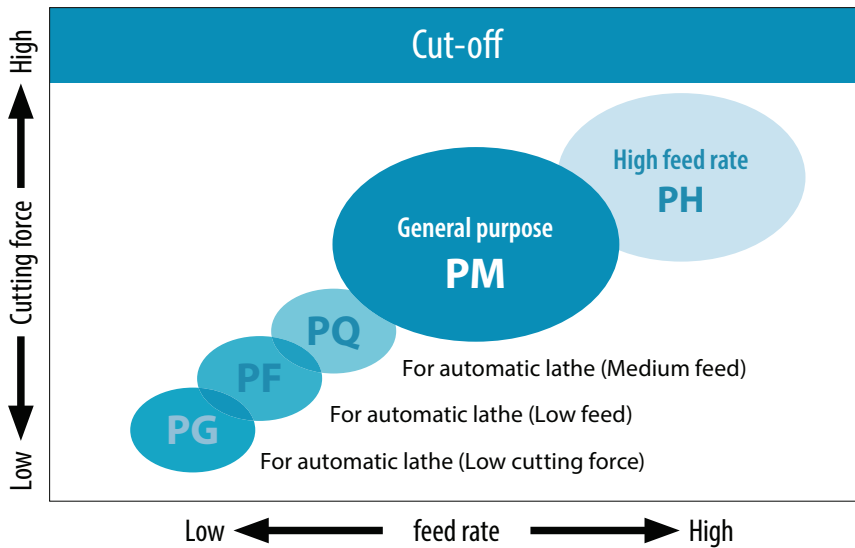

KGD recommended cutting conditions (PM / PH chipbreaker)

Workpiece material	Recommended insert grades (Vc: m/min)			f (mm/rev)			Remarks
	MEGACOAT NANO	MEGACOAT		PM	PH		
		PR1535	PR1225	PR1215	Edge width CW (mm)		
				2 ~ 4	2	3 ~ 4	
Carbon steel	☆ 80 ~ 200	★ 80 ~ 200	☆ 100 ~ 200	0.08 ~ 0.18	0.10 ~ 0.25	0.15 ~ 0.28	Coolant
Alloy steel	☆ 70 ~ 180	★ 70 ~ 180	☆ 80 ~ 180				
Stainless steel	★ 60 ~ 150	☆ 60 ~ 150	☆ 60 ~ 150	0.06 ~ 0.12	0.05 ~ 0.12	0.08 ~ 0.15	
Cast iron	-	-	★ 100 ~ 200	0.08 ~ 0.18	0.10 ~ 0.25	0.15 ~ 0.28	

★: 1st Recommendation ☆: 2nd Recommendation

Example of feed [In the graph indicates the most recommended value of feed (f)]

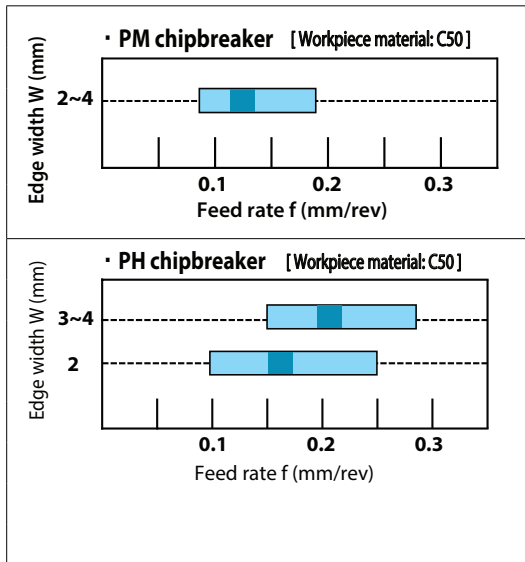







Caution (Cut-off)

1. Be sure to perform wet processing. Apply enough coolant to the cutting edge.
2. Keep a constant rate during processing so that optimum product life will be achieved.
3. Cut-off as close to the chuck as possible.
4. Lower the feed rate to 1/2 to 1/3 at the near center to prevent impact caused by machining.







GM/GMM/GMN/GM^{R/L}

		Carbon steel / Alloy steel		Stainless steel		Cast iron		Non-ferrous metals		P		M		K		N		
Insert	Description	No. of edges	Dimension (mm)				Tolerance (mm)		Carbide					Applicable toolholder H38~H40				
			CW	S	RE	INSL	CW min.	CW max.	CVD		PVD				Cermet			
									CR9025	PR915	PR930	PRT115	KW10			TN90		
	GMM 1520-MT	2	1.5	4.3	0 0.05	20	-0.05	+0.05	●	●	●	●	●	●	●	●	●	KGM [®] /L...-1.5(-85)
	GMM 2020-MT	2	2	4.3	0 0.05	20	-0.05	+0.05	●	●	●	●	●	●	●	●	●	KGM [®] /L...-1.5(-85) KGM [®] /L...-2(...)
	GMM 2520-MT	2	2.5	4.3	0 0.05	20	-0.05	+0.05	●	●	●	●	●	●	●	●	●	KGM [®] /L...-2(...) KGM [®] /L...-2.5(-85)
	GMM 3020-MT	2	3	4.3	0 0.05	20	-0.05	+0.05	●	●	●	●	●	●	●	●	●	KGM [®] /L...-2(...), KGM [®] /L...-2.5(-85) KGM [®] /L...-3(T20)
	GMM 1520-NB	2	1.5	4.3	0	20	-0.05	+0.05	●	●	●	●	●	●	●	●	●	KGM [®] /L...-1.5(-85)
	GMM 2020-NB	2	2	4.3	0	20	-0.05	+0.05	●	●	●	●	●	●	●	●	●	KGM [®] /L...-1.5(-85) KGM [®] /L...-2(...)
	GMM 2520-NB	2	2.5	4.3	0	20	-0.05	+0.05	●	●	●	●	●	●	●	●	●	KGM [®] /L...-2(...) KGM [®] /L...-2.5(-85)
	GMM 3020-NB	2	3	4.3	0	20	-0.05	+0.05	●	●	●	●	●	●	●	●	●	KGM [®] /L...-2(...), KGM [®] /L...-2.5(-85) KGM [®] /L...-3(T20)
	GMM 2020-TK	2	2	4.3	0.2	20	-0.05	+0.05	●	●	●	●	●	●	●	●	●	KGM [®] /L...-1.5(-85) KGM [®] /L...-2(...)
	GMM 2520-TK	2	2.5	4.3	0.2	20	-0.05	+0.05	●	●	●	●	●	●	●	●	●	KGM [®] /L...-2(...) KGM [®] /L...-2.5(-85)
	GMM 3020-TK	2	3	4.3	0.25	20	-0.05	+0.05	●	●	●	●	●	●	●	●	●	KGM [®] /L...-2(...), KGM [®] /L...-2.5(-85) KGM [®] /L...-3(T20)
	GMM 2020-TMR	2	2	4.3	0.2	20	-0.05	+0.05	●	●	●	●	●	●	●	●	●	KGM [®] /L...-1.5(-85) KGM [®] /L...-2(...)
	GMM 2520-TMR	2	2.5	4.3	0.2	20	-0.05	+0.05	●	●	●	●	●	●	●	●	●	KGM [®] /L...-2(...) KGM [®] /L...-2.5(-85)
	GMM 3020-TMR	2	3	4.3	0.25	20	-0.05	+0.05	●	●	●	●	●	●	●	●	●	KGM [®] /L...-2(...), KGM [®] /L...-2.5(-85) KGM [®] /L...-3(T20)
	GMN 2-TK	1	2	4.3	0.2	20	-0.05	+0.05	●	●	●	●	●	●	●	●	●	KGM [®] /L...-1.5(-85) KGM [®] /L...-2(...)
	GMN 3-TK	1	3	4.3	0.25	20	-0.05	+0.05	●	●	●	●	●	●	●	●	●	KGM [®] /L...-2(...), KGM [®] /L...-2.5(-85) KGM [®] /L...-3(T20)
	GMN 4-TK	1	4	4.3	0.3	20	-0.05	+0.05	●	●	●	●	●	●	●	●	●	KGM [®] /L...-3(T20), KGM [®] /L...-4(T.)
	GMN 2.2	1	2.2	4.3	0.17	20	-0.05	+0.05	●	●	●	●	●	●	●	●	●	KGM [®] /L...-2(...)
	GMN 3	1	3	4.3	0.2	20	-0.05	+0.05	●	●	●	●	●	●	●	●	●	KGM [®] /L...-2(...), KGM [®] /L...-2.5(-85) KGM [®] /L...-3(T20)
	GMN 4	1	4	4.3	0.25	20	-0.05	+0.05	●	●	●	●	●	●	●	●	●	KGM [®] /L...-3(T20), KGM [®] /L...-4(T.)
	GMN 5	1	5	4.3	0.8	20	-0.05	+0.05	●	●	●	●	●	●	●	●	●	KGM [®] /L...-4(T.), KGM [®] /L...-5(T25)
	GMN 6	1	6	4.3	0.8	20	-0.05	+0.05	●	●	●	●	●	●	●	●	●	KGM [®] /L...-5(T25), KGM [®] /L...-6T30

● : Standard item R : Right-hand only L : Left-hand only □ : Check availability

GM/GMM/GMN/GM^{R/L}







		Carbon steel / Alloy steel		Stainless steel		Cast iron		Non-ferrous metals		P		M		K		N		
Insert	Description	No. of edges	Dimension (mm)				Angle (°)	Tolerance (mm)		Carbide					Cermets	Applicable toolholder H38~H40		
			CW	S	RE	INSL		PSIR ^{R/L}	CW min.	CW max.	CR9025	PVD					KW10	TN90
												PR905	PR915	PR930				
	GMM 1520R-MT-15D	2	1.5	4.3	0 0.05	20	15	-0.05	+0.05									KGM ^{R/L} ...-1.5(-85)
	GMM 2020R-MT-15D 2020R-MT-15D 2020L-MT-15D	2	2	4.3	0 0.05 0	20	15	-0.05	+0.05									KGM ^{R/L} ...-1.5(-85) KGM ^{R/L} ...-2(...)
	GMM 2520R-MT-15D	2	2.5	4.3	0 0.05	20	15	-0.05	+0.05									KGM ^{R/L} ...-2(...) KGM ^{R/L} ...-2.5(-85)
	GMM 3020R-MT-15D 3020R-MT-15D 3020L-MT-15D	2	3	4.3	0 0.05 0	20	15	-0.05	+0.05									KGM ^{R/L} ...-2(...), KGM ^{R/L} ...-2.5(-85) KGM ^{R/L} ...-3(T20)
	GMM 2020R-TK-8D	2	2	4.3	0.2	20	8	-0.05	+0.05									KGM ^{R/L} ...-1.5(-85) KGM ^{R/L} ...-2(...)
	GMM 2520R-TK-8D	2	2.5	4.3	0.2	20	8	-0.05	+0.05									KGM ^{R/L} ...-2(...) KGM ^{R/L} ...-2.5(-85)
	GMM 3020R-TK-8D	2	3	4.3	0.25	20	8	-0.05	+0.05									KGM ^{R/L} ...-2(...), KGM ^{R/L} ...-2.5(-85) KGM ^{R/L} ...-3(T20)
	GMM 2020R-TMR-6D	2	2	4.3	0.2	20	6	-0.05	+0.05									KGM ^{R/L} ...-1.5(-85) KGM ^{R/L} ...-2(...)
	GMM 2520R-TMR-6D	2	2.5	4.3	0.2	20	6	-0.05	+0.05									KGM ^{R/L} ...-2(...) KGM ^{R/L} ...-2.5(-85)
	GMM 3020R-TMR-6D	2	3	4.3	0.25	20	6	-0.05	+0.05									KGM ^{R/L} ...-2(...), KGM ^{R/L} ...-2.5(-85) KGM ^{R/L} ...-3(T20)
	GMR 2-TK-8D	1	2	4.3	0.2	20	8	-0.05	+0.05									KGM ^{R/L} ...-1.5(-85) KGM ^{R/L} ...-2(...)
	GMR 3-TK-8D	1	3	4.3	0.25	20	8	-0.05	+0.05									KGM ^{R/L} ...-2(...), KGM ^{R/L} ...-2.5(-85) KGM ^{R/L} ...-3(T20)
	GMR 4-TK-8D	1	4	4.3	0.3	20	8	-0.05	+0.05									KGM ^{R/L} ...-3(T20), KGM ^{R/L} ...-4(T.)
	GMR 2.2-8D GML 2.2-8D	1	2.2	4.3	0.17	20	8	-0.05	+0.05									KGM ^{R/L} ...-2(...)
	GMR 2.2-15D	1	2.2	4.3	0	20	15	-0.05	+0.05									KGM ^{R/L} ...-2(...)
	GMR 3-4D GML 3-4D	1	3	4.3	0.2	20	4	-0.05	+0.05									KGM ^{R/L} ...-2(...), KGM ^{R/L} ...-2.5(-85) KGM ^{R/L} ...-3(T20)
	GMR 4-4D GML 4-4D	1	4	4.3	0.25	20	4	-0.05	+0.05									KGM ^{R/L} ...-3(T20), KGM ^{R/L} ...-4(T.)

Handed insert shows Right-hand

● : Standard item R : Right-hand only L : Left-hand only □ : Check availability



Edge preparation

Series	MT-chipbreaker		TK-chipbreaker		TMR-chipbreaker	Without chipbreaker (NB)	
Edge prep.	Chamfer + R honed	Chamfer + R honed	Chamfer + R honed	Sharp Edge	Chamfer + R honed	R honed	Sharp Edge
	Corner-R (RE) = 0.05	Sharp corner	Corner-R (RE) = 0.2-0.3	Corner-R (RE) = 0.2-0.3	Corner-R (RE) = 0.2	Corner-R (RE) = 0.05	Sharp Corner
							
	CR9025/PR915	PR930/KW10	CR9025/PR915	PR930/KW10	PR1115	CR9025	PR930/KW10

· Sharp edge specification can reduce cutting force by 40% less than that of chamfer edge.

Series	Advantage
GMM-MT	Specific chipbreaker for cut-off operations requiring sharp cutting performance. Minimizes the boss.
GMM-NB	Cutting edge is flat with non-chipbreaker. It works well for brass, etc.
GMM-TK	Stable design with chipbreaker for cut-off. Large corner-R. 2-edge for economical performance.
GMM-TK	Same chipbreaker geometry as GMM-TK. 1-edge. Wide application range.
GMN (Std.) (No indication)	Mainly for deep grooving, but available for groove widening and turning due to projection near side cutting edge. 1-edge and wide application range. Available for cut-off applications.

H



Cut-Off

TMR-chipbreaker

Advantages

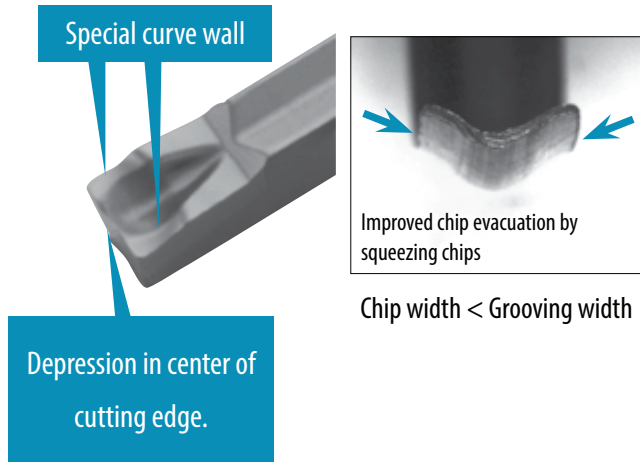

GMM chipbreaker MAP

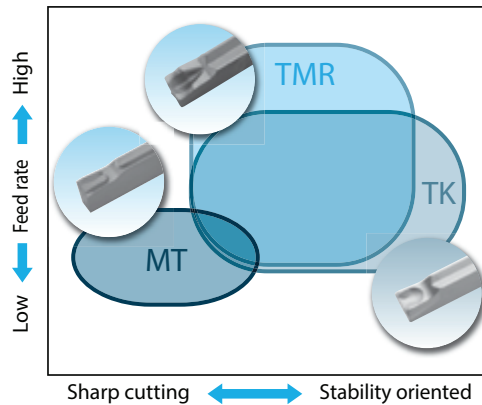

TMR application range

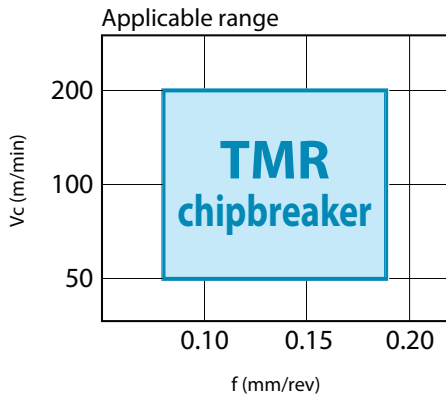

TMR-chipbreaker enables stable chip control also for high feed rates

Good chip control even when cutting speed (spindle revolution) is increased.

(Workpiece Material: 15CrMo4, ø30, constant spindle revolution)

Description	n=1,060min ⁻¹ (Vc=100m/min)		n=2,123min ⁻¹ (Vc=200m/min)	
	f=0.12mm/rev	f=0.18mm/rev	f=0.12mm/rev	f=0.18mm/rev
GMM 3020-TMR (Neutral)				
GMM 3020R-TMR-6D (Lead angle)				

Recommended Cutting Conditions

Workpiece Material	Vc (m/min)	f (mm/rev)
Carbon Steel	60 ~ 200	0.08 ~ 0.18
Alloy Steel	60 ~ 150	
Stainless Steel	50 ~ 140	

Workpiece Surface Roughness

TMR Chipbreaker provides good surface roughness on the workpiece end face at high feed rate ranges.

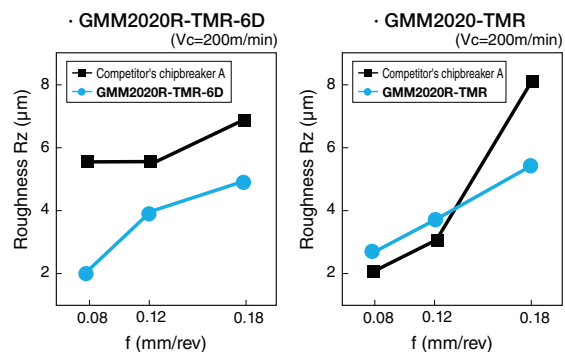

KGM (for Automatic Lathe)

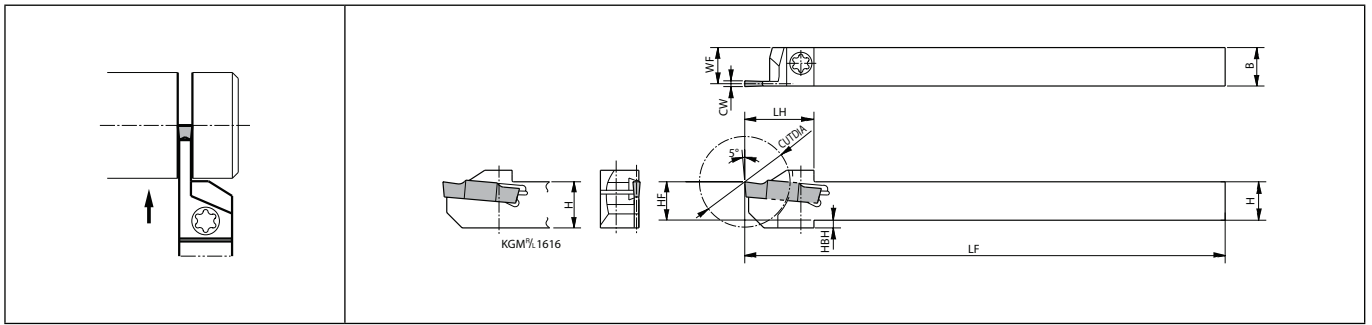

Right-hand shown

Toolholder dimensions

Description	Availability		Dimension (mm)										Spare parts		Applicable inserts ➔ H34, H35	
													Screw	Wrench		
	R	L	CUTDIA	H	B	LH	HF	HBH	LF	WF	CW min.	CW max.				
KGM%L 1010JX-1.5 1212F-1.5-85 1212JX-1.5	●	●	18	10	10	18	10		120	9.4	1.5	2	SE-40120TR	LTW-15S	GMM1520... GMM2020... GM_2-TK(-8D)	
	●		23	12	12	19	12	2	85	11.4						
	●	●							120							
KGM%L 1010JX-2 1212F-2-85 1212JX-2 1616JX-2	●	●	18	10	10	18	10		120	9.15	2	3	SE-40120TR	LTW-15S	GMM2020... GM_2-TK(-8D) GM_2.2(-.D) GM_3(...)	
	●	●	23	12	12	19	12	2	85	11.15						
	●	●							120							
	●	●	30	16	16	24.5	16	-		15.15			SE-50125TR	LTW-20		
KGM%L 1212F-2.5-85 1212JX-2.5 1616JX-2.5	●		23	12	12	19	12	2	85	11	2.4	3	SE-40120TR	LTW-15S	GMM2520... GMM3020... GM_3(...)	
	●	●							120							15
	●	●							30				16	16		24.5
KGM%L 1616JX-3	●	●	30	16	16	24.5	16	-	120	14.8	3	4	SE-50125TR	LTW-20	GMM3020..., GM_3(...), GM_4(...)	

KGM will be switched to KGD=> H22

Recommended cutting conditions ➔ H43



● : Standard item R : Right-hand only L : Left-hand only □ : Check availability

KGM

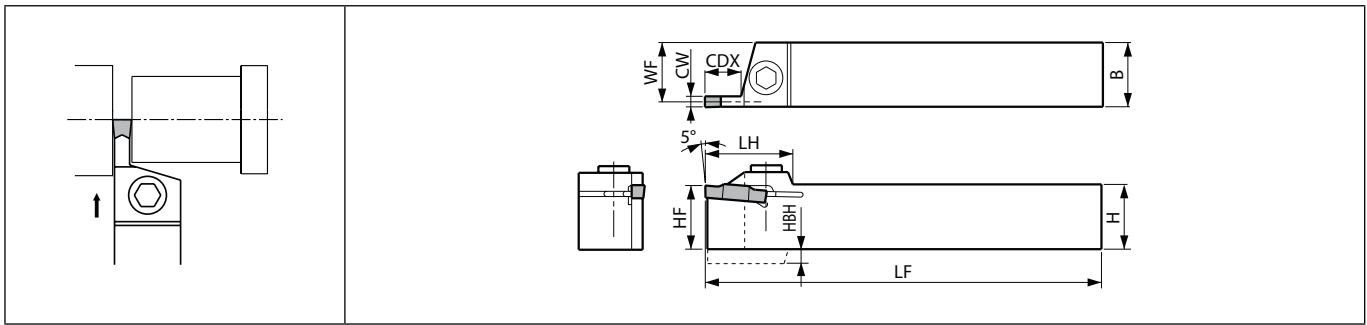

Right-hand shown

Toolholder dimensions

Description	Availability		Dimension (mm)										Spare parts				Applicable inserts H34, H35
													Clamp bolt	Screw	Wrench	Wrench	
	R	L	CDX	H	B	LH	HF	HBH	LF	WF	CW min.	CW max.					
KGM [®] /L 1212H-3 1616H-3 2020K-3 2525M-3	●		9	12	12	27	12	4	100	10.8	3	3	-	SB-5TR	-	LTW-20	GMG3020..., GM_3(...)
	●			16	16		16	14.8	4	HH5X16		-	LW-4	-	GMG3020..., GM_3(...), GM_4(...)		
	●	●		20	20		20	18.8		HH5X25		-	LW-4	-	GMG3020..., GM_3(...), GM_4(...)		
	●	●		25	25		25	23.8	HH5X25	-		LW-4	-	GMG3020..., GM_3(...), GM_4(...)			
KGM [®] /L 2020K-4 2525M-4	●		10	20	20	27	20	-	125	18.3	4	5	HH5X16	-	LW-4	-	GM_4(...) GMN5
	●	●		25	25		25	23.3	HH5X25	-		LW-4	-	GM_4(...) GMN5			
KGM [®] R 2020K-5 2525M-5	●		10	20	20	27	20	-	125	17.8	5	6	HH5X16	-	LW-4	-	GMN5 GMN6
	●			25	25		25	22.8	HH5X25	-		LW-4	-	GMN5 GMN6			
KGM [®] /L 2525M-8	●	●	25	25	25	40	25	7.5	150	22	8	8	HH6X25	-	LW-5	-	G48~G50 GM_8030..., GMGA8030...R

CDX shows available grooving depth.

4mm width Insert can be installed in KGM[®]/L 1212H-3, but is not recommended due to the toolholder's rigidity.

KGM will be switched to KGD=> H28

Recommended cutting conditions H43



KGM (Deep grooving)

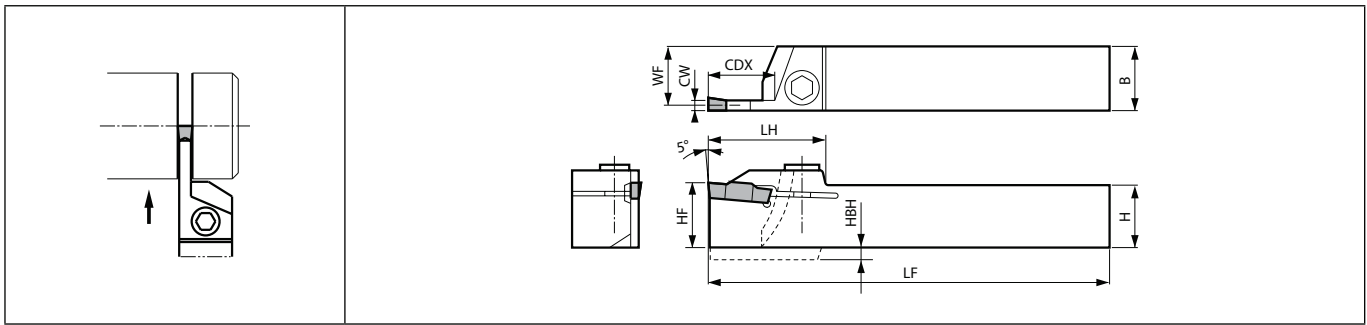

Right-hand shown

Toolholder dimensions

Description	Availability		Dimension (mm)											Spare parts				Applicable inserts H34, H35
														Clamp bolt	Screw	Wrench	Wrench	
	R	L	CDX	H	B	LH	HF	HBH	LF	WF	CW min.	CW max.						
KGM [®] /L 2012K-2T17 2020K-2T17 2525M-2T17		●	17	20	12	33	20	20	11.15	2	3	-	SB-STR	-	LTW-20	GMM2020..., GM_2-TK(-8D) GM_2.2(-..D), GM_3(...)		
	●	●		20	20							19.15	HH5X16	-	LW-4		-	
	●	●		25	25	25	150	24.15	HH5X25	-	LW-4	-						
KGM [®] /L 1616H-3T20 2012K-3T20 2020K-3T20 2525M-3T20	●		20	16	16	36	20	4	100	14.8	3	4	HH5X16	-	LW-4	-	GMG3020... GM_3(...) GM_4(...)	
		●		20	12								10.8	-	SB-STR	-		LTW-20
	●	●		20	20	18.8	HH5X16	-	LW-4	-								
	●	●		25	25	25	150	23.8	HH5X25	-	LW-4	-						
KGM [®] /L 2020K-4T20 2525M-4T20 2525M-4T25	●		20	20	20	36	20	4	125	18.3	4	5	HH5X16	-	LW-4	-	GM_4(...) GMN5	
	●	●		25	25								25	150	23.3	HH5X25		-
	●	●		25	25	41	25	150	23.3	HH5X25	-	LW-4	-					
KGM [®] /L 2525M-5T25 3232P-5T25	●	●	25	25	25	42	32	32	150	22.8	5	6	HH5X25	-	LW-4	-	GMN5 GMN6	
	●	●		32	32								170	29.8	HH5X25	-		LW-4
KGMR 2525M-6T30	●		30	25	25	45	25		150	22.4	6	6	HH5X25	-	LW-4	-	GMN6	

CDX shows the distance from the toolholder to the cutting edge. Ref. to the Table (H42) for the relationship between the available grooving depth and the cutting dia.

When using GMG / GMM (2-edge) insert, set the groove depth under 15 mm.











KGM will be switched to KGD=> H28

Recommended cutting conditions H43

● : Standard item R : Right-hand only L : Left-hand only □ : Check availability



Applicable Inserts

Applications See Page	Grooving / Turning G48	Grooving / Turning G48	Grooving G49	Full-R / Copying G49	Full-R / Copying G50	Cut Off / Deep Grooving H34, H35	Cut Off / Deep Grooving H34	Cut Off / Deep Grooving H34, H35	Cut Off / Deep Grooving H34, H35	Cut Off / Deep Grooving H34, H35
Insert										
Toolholder Description								TMR		
KGM [®] /L...1.5	-	-	-	-	-	GMM1520..MT GMM2020..MT GMM1520 [®] /L...MT GMM2020 [®] /L...MT	GMM1520..NB GMM2020..NB	GMM2020..T GMM2020R..T	GMN2..TK GMR2..TK	-
KGM [®] /L...2(T)	GMM2420..MW GMM3020..MW	GMG3020..MS GMM3020..MS	GMG2520..MG GMG3020..MG	GMG3020..R GMM3020..R	-	GMM2020..MT GMM2520..MT GMM3020..MT GMM2020 [®] /L...MT GMM2520 [®] /L...MT GMM3020 [®] /L...MT	GMM2020..NB GMM2520..NB GMM3020..NB	GMM2020..T GMM2520..T GMM3020..T GMM2020R..T GMM2520R..T GMM3020R..T	GMN2..TK GMN3..TK GMR2..TK GMR3..TK	GMN2.2 GMN3 GM [®] /L.2.2 GM [®] /L.3
KGM [®] /L...2.5	GMM2420..MW GMM3020..MW	GMG3020..MS GMM3020..MS	GMG2520..MG GMG3020..MG	GMG3020..R GMM3020..R	-	GMM2520..MT GMM3020..MT GMM2520 [®] /L...MT GMM3020 [®] /L...MT	GMM2520..NB GMM3020..NB	GMM2520..T GMM3020..T GMM2520R..T GMM3020R..T	GMN3..TK GMR3..TK	GMN3 GM [®] /L.3
KGM [®] /L...3(T)	GMM3020..MW GMM4020..MW	GMG3020..MS GMM3020..MS GMG4020..MS GMM4020..MS	GMG3020..MG GMG3520..MG GMG4020..MG GMM4020..MG	GMG3020..R GMM3020..R GMG4020..R GMM4020..R	-	GMM3020..MT GMM3020 [®] /L...MT	GMM3020..NB	GMM3020..T GMM3020R..T	GMN3..TK GMN4..TK GMR3..TK GMR4..TK	GMN3 GMN4 GM [®] /L.3 GM [®] /L.4
KGM [®] /L...4(T)	GMM4020..MW GMM5020..MW	GMG4020..MS GMM4020..MS GMG5020..MS GMM5020..MS	GMG4020..MG GMG5020..MG	GMG4020..R GMM4020..R GMG5020..R GMM5020..R	-	-	-	-	GMN4..TK GMR4..TK	GMN4 GMN5 GM [®] /L.4
KGM [®] /L...5T	GMM5020..MW GMM6020..MW	GMG5020..MS GMM5020..MS GMG6020..MS GMM6020..MS	GMG5020..MG GMG6020..MG	GMG5020..R GMM5020..R GMG6020..R GMM6020..R	GMGA6020..R	-	-	-	-	GMN5 GMN6
KGM [®] /L...6T	GMM6020..MW	GMG6020..MS GMM6020..MS	GMG6020..MG	GMG6020..R GMM6020..R	GMGA6020..R	-	-	-	-	GMN6
KGM [®] /L...8	GMM8030..MW	-	GMG8030..MG	-	GMGA8030..R	-	-	-	-	-

Recommended Cutting Conditions  H43



Possible cutting diameter of KGM / KGM-T type

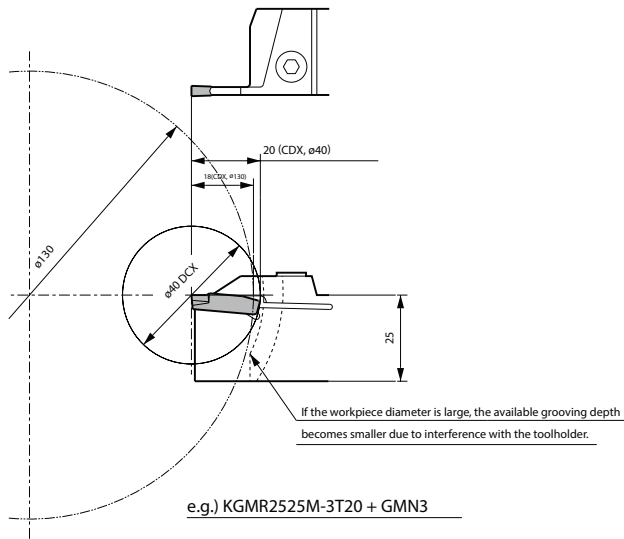

There is a limit to available grooving depth depending on the workpiece diameter.



KGM (for automatic lathe) Possible Cutting Diameter and Available Grooving Depth Table

Toolholder Description		DCX (Cutting Dia.)															
KGM ^{R/L}	1010 □ -1.5...	-	-	-	-	-	-	-	-	18	21	26	38	76	∞		
	1212 □ -1.5...	-	-	-	-	23	27	37	71	∞	∞	∞	∞				
	1010 □ -2...	-	-	-	-	-	-	-	-	18	21	26	38	76			
	1212 □ -2...	-	-	-	-	23	27	37	71	∞							
	1616 □ -2...	30	37	47	68	89	131	∞	∞	∞							
	1212 □ -2.5...	-	-	-	-	23	27	37	71	∞							
	1616 □ -2.5...	30	37	47	68	89	131	∞	∞	∞							
	1616 □ -3...	30	37	47	68	89	131	∞	∞	∞							
Available Grooving Depth CDX (mm)		15	14	13	12	11.5	11	10	9	8	7	6	5	4	3	2	1

KGM-T Possible Cutting Diameter and Available Grooving Depth Table (GMN, GM^{R/L} when using 1-edge insert)

Toolholder Description		DCX (Cutting Dia.)													
KGM ^{R/L}	2012K-2T17	-	-	-	-	-	-	-	-	-	66	80	130	260	∞
	2020K-2T17	-	-	-	-	-	-	-	-	-	66	80	130	260	
	2525M-2T17	-	-	-	-	-	-	-	-	-	66	80	130	260	
	1616H-3T20	-	-	-	-	-	40	54	70	100	180	∞			
	2012K-3T20	-	-	-	-	-	40	54	70	100	180	∞			
	2020K-3T20	-	-	-	-	-	40	54	70	100	180	∞			
	2525M-3T20	-	-	-	-	-	40	90	130	240	∞	∞	∞		
	2020K-4T20	-	-	-	-	-	40	90	130	240	∞	∞	∞		
	2525M-4T20	-	-	-	-	-	40	90	130	240	∞	∞	∞		
	2525M-4T25	-	-	50	140	240	∞	∞	∞	∞	∞	∞	∞		
	2525M-5T25	-	-	50	140	240	∞	∞	∞	∞	∞	∞	∞		
	3232P-5T25	-	-	50	140	240	∞	∞	∞	∞	∞	∞	∞		
	2525M-6T30	100	300	∞	∞	∞	∞	∞	∞	∞	∞	∞	∞		
Available Grooving Depth CDX (mm)		30	27	25	23	22	20	19	18	17	16	15	14	13 or under	

Recommended cutting conditions (GMM-MT, GMM-TK, GMM-NB)

Workpiece material	Recommended insert grades (Vc: m/min)				Edge width CW (mm)				Remarks
	CVD coated carbide	PVD coated carbide		Carbide	1.5	2.0 / 2.5	3.0	4.0	
	CR9025	PR915	PR930	KW10	f (mm/rev)				
Carbon steel	☆ 80 ~ 180	★ 60 ~ 150	☆ 60 ~ 130	-	0.01 ~ 0.04	0.02 ~ 0.15	0.03 ~ 0.20	0.08 ~ 0.30	Coolant
Alloy steel	☆ 70 ~ 150	★ 60 ~ 150	☆ 60 ~ 130	-	0.01 ~ 0.04	0.02 ~ 0.15	0.03 ~ 0.20	0.08 ~ 0.30	
Stainless steel	☆ 60 ~ 140	★ 50 ~ 140	☆ 50 ~ 120	-	0.01 ~ 0.03	0.02 ~ 0.10	0.03 ~ 0.15	0.08 ~ 0.25	
Cast iron	-	-	-	★ 50 ~ 100	0.01 ~ 0.05	0.05 ~ 0.12	0.10 ~ 0.25	0.10 ~ 0.30	
Aluminum alloys	-	-	-	★ 200 ~ 450	0.01 ~ 0.05	0.05 ~ 0.10	0.05 ~ 0.20	0.05 ~ 0.25	
Brass	-	-	-	★ 100 ~ 200	0.01 ~ 0.05	0.05 ~ 0.10	0.05 ~ 0.15	0.05 ~ 0.20	

· When machining Steel and Stainless Steel by Insert of PR930, decrease the feed rate by 20%.

★: 1st Recommendation ☆: 2nd Recommendation

Recommended cutting conditions (GMM-TMR)

Workpiece material	Vc (m/min)	f (mm/rev)	Remarks
Carbon steel	60 ~ 200	0.08 ~ 0.18	Coolant
Alloy steel	60 ~ 150		
Stainless steel	50 ~ 140		

H



Cut-Off

High-Performance Cut-Off Solutions

KPK Series

Easy Insert Replacement Reduces Downtime

High Performance, Long Tool Life and Stable Machining with Strong Clamping Mechanism

1 Easy Insert Replacement

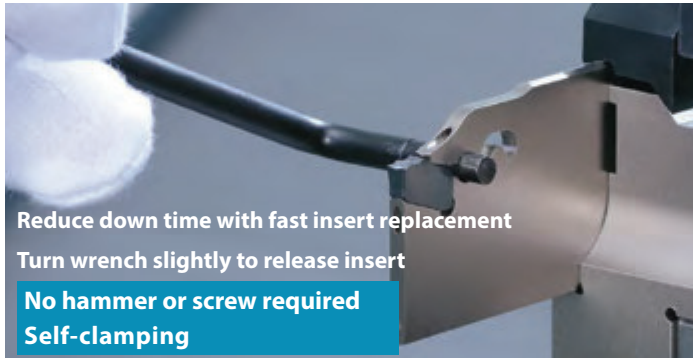

Reduce down time with fast insert replacement
Turn wrench slightly to release insert
No hammer or screw required
Self-clamping



2 Firm Insert Clamp Ensures Added Safety and Security

The firmly secured insert uses three contact surfaces to eliminate sliding or chattering

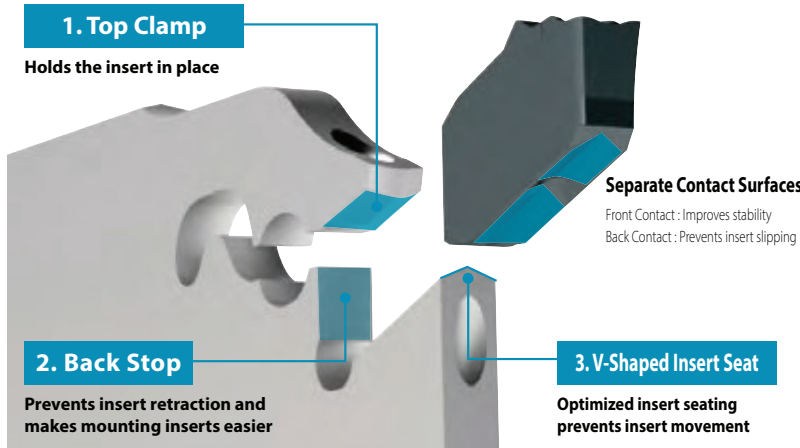

Insert Deviation Comparison (Internal evaluation)

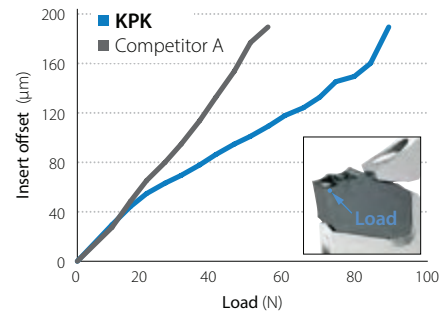

Measured tool : KPKB32-3 PKM30N-025PM

Cutting Performance Comparison (Internal evaluation)

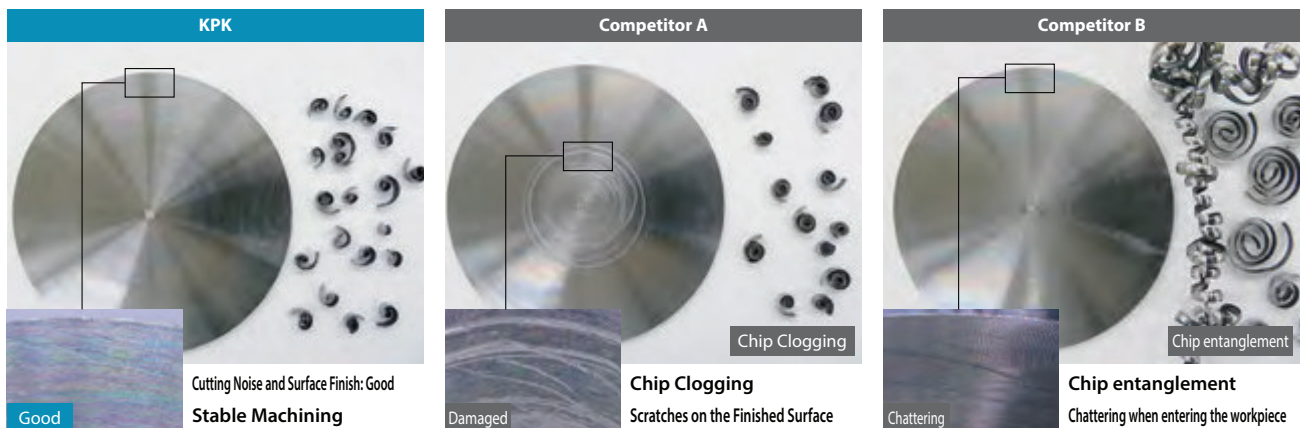

Cutting Conditions : $n = 320 \text{ min}^{-1}$ (constant), $V_c = \sim 100 \text{ m/min}$, $f = 0.12 \text{ mm/rev}$, Wet (External coolant) Workpiece Material : 34CrMo4 ($\phi 100$) Edge Width : 3mm

H

Cut-Off

3 Unique Chipbreaker for Long Tool Life and Stable Machining

Advanced chipbreaker technology inherited from KGD lineup provides excellent chip control



General purpose
PM Chipbreaker

Insert grade
 For Steel : PR1625
 For Stainless steel : PR1535
 For Cast Iron and Aluminum : GW15



For Tough edge and High-feed machining
PH Chipbreaker

Insert grade
 For Steel : PR1625
 For Stainless steel : PR1535

Wear Resistance Comparison (Internal evaluation)

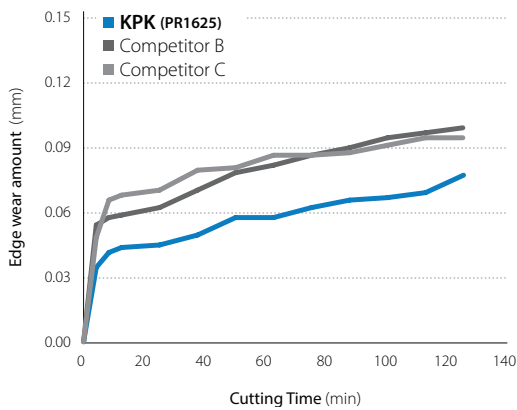

Cutting Conditions : $n = 955 \text{ min}^{-1}$ (constant), $V_c \sim 150 \text{ m/min}$
 $f = 0.12 \text{ mm/rev}$ ($\sim \phi 10$: $f = 0.05 \text{ mm/rev}$) Wet (External coolant)
 Workpiece Material : 15CrMo4 ($\phi 50$) Edge Width : 3 mm (PM Chipbreaker)

Chip Control Comparison (Internal evaluation)

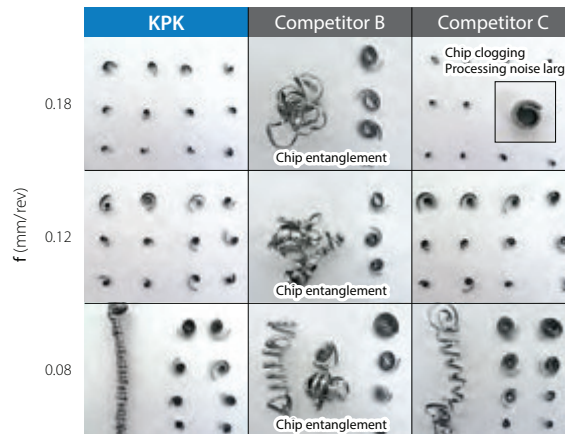

Cutting Conditions : $n = 780 \text{ min}^{-1}$ (constant), $V_c \sim 120 \text{ m/min}$, Wet (External coolant)
 Workpiece Material : 15CrMo4 ($\phi 50$) Edge Width : 3 mm (PM Chipbreaker)



4 Rigid Toolblock Prevents Chattering and Provides Internal Coolant

KPKTB-JCT

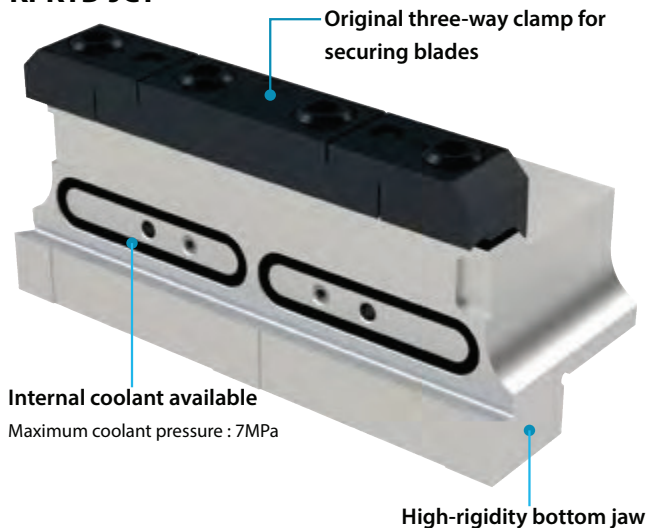

Chattering Resistance Comparison (Internal evaluation)

Comparison of areas where stable machining is possible by changing the overhang amount of blade by 1 mm

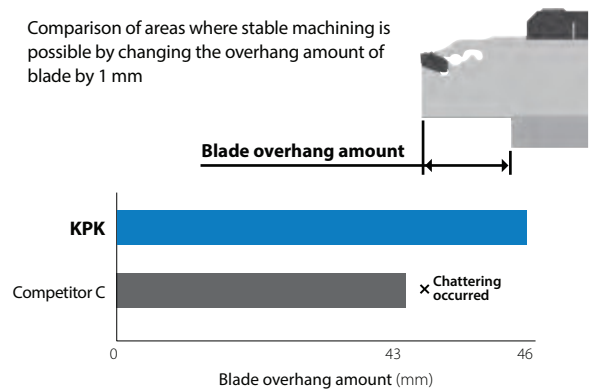





Cutting Conditions : $n = 650 \text{ min}^{-1}$ (constant), $V_c \sim 100 \text{ m/min}$, $f = 0.12 \text{ mm/rev}$
 Wet (Internal Coolant : Normal pressure) Workpiece Material : 34CrMo4($\phi 50$),
 Edge Width : 3 mm (PM Chipbreaker)

Check

KTKTB type is compatible with internal coolant with an optional internal connector. ($\sim 1 \text{ MPa}$)

*Refer to page H56 for the supply method (Type C).

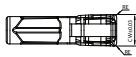
PKM

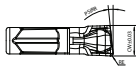
Insert		Description		No. of edges		Dimension (mm)		Angle (°)	Tolerance (mm)		Carbide			Applicable toolholder H48, H49, H55, H56	
						CW	RE		PSIR%	CW min.	CW max.	PVD			
												PR1535	PR1625		GW15
						Carbon steel / Alloy steel			Stainless steel		Cast iron		Non-ferrous metals		
  <p>General purpose</p>	PKM 16N-015PM	1.6	0.15	1	-	-0.03	+0.03	●	●	●	KPKB19-1, KPKB26-1(JCT) KPKB32-1(JCT)				
	PKM 20N-020PM	2	0.2					●	●	●	KPKB19-2, KPKB26-2(JCT) KPKB32-2(JCT), KPKH%L2020K-2(JCT)				
	PKM 24N-020PM	2.4	0.2					●	●	●	KPKB19-2, KPKB26-2(JCT) KPKB32-2(JCT), KPKH%L2020K-2(JCT)				
	PKM 30N-025PM	3	0.25					●	●	●	KPKB26-3(JCT), KPKB32-3(JCT) KPKH%L...-3(JCT), KPKH%L...-3D45				
	PKM 40N-030PM	4	0.3					●	●	●	KPKB26-4(JCT), KPKB32-4(JCT) KPKH%L...-4(JCT), KPKH%L...-4D45				
	PKM 48N-030PM	4.8	0.3					●	●	●	KPKB26-5(JCT), KPKB32-5(JCT) KPKH%L2525M-5				
	PKM 50N-030PM	5	0.3					●	●	●	KPKB26-5(JCT), KPKB32-5(JCT) KPKH%L2525M-5				
	PKM 60N-035PM	6	0.35					●	●	●	KPKB32-6(JCT)				
  <p>High feed</p>	PKM 20N-020PH	2	0.2	1	-	-0.03	+0.03	●	●	●	KPKB19-2, KPKB26-2(JCT) KPKB32-2(JCT), KPKH%L2020K-2(JCT)				
	PKM 30N-030PH	3	0.3					●	●	●	KPKB26-3(JCT), KPKB32-3(JCT) KPKH%L...-3(JCT), KPKH%L...-3D45				
	PKM 40N-030PH	4	0.3					●	●	●	KPKB26-4(JCT), KPKB32-4(JCT) KPKH%L...-4(JCT), KPKH%L...-4D45				
	PKM 50N-030PH	5	0.3					●	●	●	KPKB26-5(JCT), KPKB32-5(JCT) KPKH%L2525M-5				
	PKM 60N-040PH	6	0.4					●	●	●	KPKB32-6(JCT)				
  <p>General purpose with lead angle</p>	PKM 16R-015PM-6D 16L-015PM-6D	1.6	0.15	1	6	-0.03	+0.03	●	●	●	KB19-1, KPKB26-1(JCT)KPKB32-1(JCT)				
	PKM 20R-020PM-6D 20L-020PM-6D	2	0.2					●	●	●	KPKB19-2, KPKB26-2(JCT) KPKB32-2(JCT), KPKH%L2020K-2(JCT)				
	PKM 24R-020PM-6D 24L-020PM-6D	2.4	0.2					●	●	●	KPKB19-2, KPKB26-2(JCT) KPKB32-2(JCT), KPKH%L2020K-2(JCT)				
	PKM 30R-025PM-6D 30L-025PM-6D	3	0.25					●	●	●	KPKB26-3(JCT), KPKB32-3(JCT) KPKH%L...-3(JCT), KPKH%L...-3D45				
	PKM 40R-030PM-6D 40L-030PM-6D	4	0.3					●	●	●	KPKB26-4(JCT), KPKB32-4(JCT) KPKH%L...-4(JCT), KPKH%L...-4D45				
	PKM 50R-030PM-6D 50L-030PM-6D	5	0.3					●	●	●	KPKB26-5(JCT), KPKB32-5(JCT) KPKH%L2525M-5				

Handed insert shows Right-hand

● : Standard item R : Right-hand only L : Left-hand only □ : Check availability



Lead Angle Direction and Usage

1. If there is no restriction on the finished shape, use an insert without lead angle.
2. Insert with lead angle is recommended to prevent remaining boss.
3. If you want to make the remaining boss smaller when machining small or thin parts, use insert with lead angle.

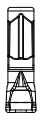
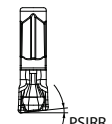
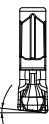
Hand of Lead Angle	N (Neutral)	R (Right hand)	L (Left hand)
			
	· Inserts with lead angle (PSIR %) reduce burrs at cut-off machining. · The larger the lead angle (PSIR %), the smaller the cutting force. The feed also needs to be smaller.		

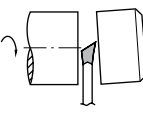
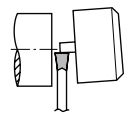
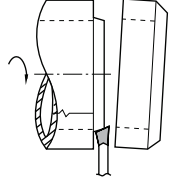
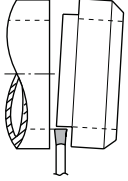
	Right hand (R) Lead angle	Neutral	Right hand (R) Lead angle	Neutral
Solid Workpiece			Hollow Workpiece (Pipe)	
				

Caution

1. Set cutting edge height 0.1mm above core height.
 2. Machining with ample supply of coolant is recommended.
 3. Keep a constant rate during processing so that optimum product life will be achieved.
 4. Cut off as close to the chuck as possible.
 5. To prevent impacts, reduce feed rate by 1/2 ~ 1/3 when nearing the center of the workpiece.
- Overuse of insert and toolholder (blade) may cause insert breakage and toolholder (blade) damage.

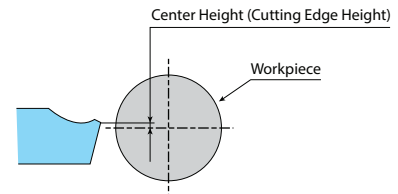

KPKB-JCT (Coolant-through holders)

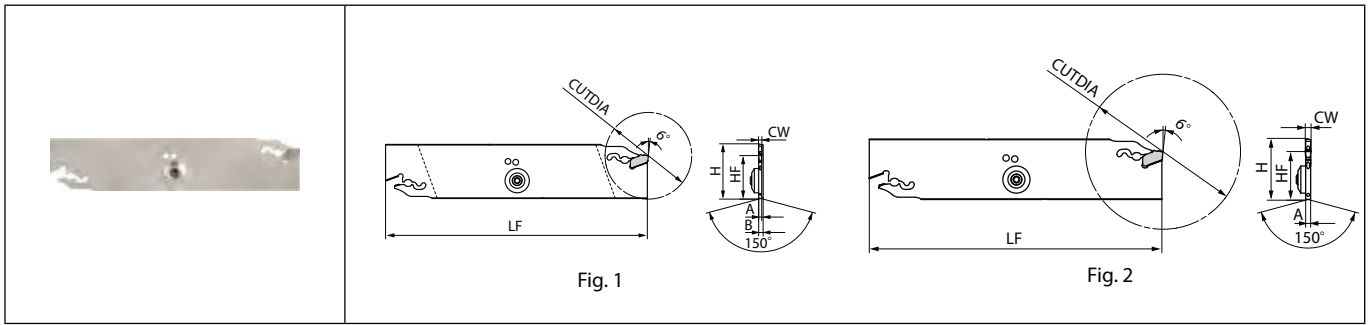

with coolant supply | Applicable Pressure : ~7MPa

Toolholder dimensions

Description	Availability	Dimension (mm)							Coolant hole Fig.	Spare parts				Applicable inserts H46	Applicable tool block H50, H51
		CUTDIA	A	B	H	HF	LF	CW		Coolant cap	Releasing wrench	Screw	Wrench		
KPKB 26-1JCT	●	35	1.4	2.6	26	21.4	110	1.6	1	CCP-4	LPW-5	SB-4065TR	FT-15	PKM16...	KPKTB...-26JCT KTKTB...-26
KPKB 26-2JCT	●	50	1.8					2							
KPKB 26-3JCT	●	75	2.6	2.4											
KPKB 26-4JCT	●	80	3.4	3	Yes	4									
KPKB 26-5JCT	●	80	4.2	-	-	-	4.8								
							5								
KPKB 32-1JCT	●	35	1.4	2.6	32	25	150	1.6	1	CCP-4	LPW-5	SB-4065TR	FT-15	PKM16...	KPKTB...-32JCT KTKTB...-32 KTKTBF...-32
KPKB 32-2JCT	●	50	1.8					2							
KPKB 32-3JCT	●	100	2.6	2.4											
KPKB 32-4JCT	●	120	3.4	3	Yes	4									
KPKB 32-5JCT	●	120	4.2	-	-	-	4.8								
							5								
KPKB 32-6JCT	●	5.4	5.4	6											

See page H52 for insert mounting and removal instructions
When using internal coolant with KTKTB, KTKTBF type toolblocks, coolant supply piping (CCN -5) sold separately.
H: Length between virtual vertices

Recommended cutting conditions H57

Minimum /maximum overhang length while using internal coolant

Description	Overhang length	
	min.	max.
KPKB26-1JCT	15	34.5
KPKB26-2/3/4JCT	20	40
KPKB26-5JCT	23	43
KPKB32-1JCT	KPKTB20-32JCT	18
	KPKTB25-32JCT	13
	KPKTB32-32JCT	
KPKB32-2/3/4JCT	KPKTB20-32JCT	27.5
	KPKTB25-32JCT	22.5
	KPKTB32-32JCT	
KPKB32-5/6JCT	KPKTB20-32JCT	31.5
	KPKTB25-32JCT	26.5
	KPKTB32-32JCT	

● : Standard item R : Right-hand only L : Left-hand only □ : Check availability

KPKB

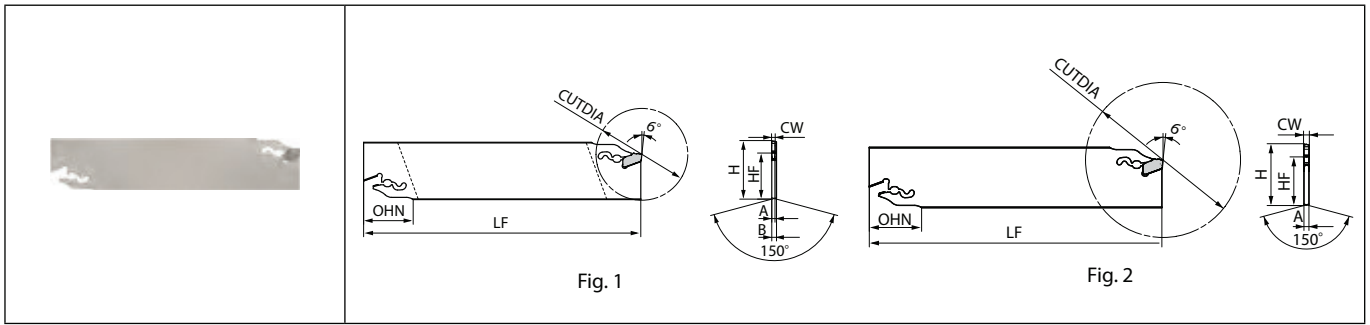

Toolholder dimensions

Description	Availability	Dimension (mm)							Coolant hole	Fig.	Spare parts Releasing wrench	Applicable inserts H46	Applicable tool block H50, H51	
		CUTDIA	A	B	H	HF	LF	CW						
KPKB 19-1	●	32	1.4	2.6	19	15.7	86	1.6	No	1	LPW-5	PKM16... PKM20... PKM24...	KTKTB..-19	
	●	40	1.8	-				2						2.4
KPKB 26-1	●	35	1.4	2.6	26	21.4	110	1.6	No	2	LPW-5	PKM16... PKM20... PKM24... PKM30... PKM40... PKM48... PKM50...	KPKTB..-26JCT KTKTB..-26	
	●	50	1.8	-				2						2.4
	●	75	2.6	-				3						4
	●	80	3.4	-				4						4.8
	●	80	4.2	-				5						5
KPKB 32-1	●	35	1.4	2.6	32	25	150	1.6	No	1	LPW-5	PKM16... PKM20... PKM24... PKM30... PKM40... PKM48... PKM50... PKM60...	KPKTB..-32JCT KTKTB..-32 KTKTBF..-32	
	●	50	1.8					2						2.4
	●	100	2.6					3						4
	●	100	3.4					4						4.8
	●	120	4.2					5						5
	●	120	5.4					6						6

See page H52 for insert mounting and removal instructions
H: Length between virtual vertices

Recommended cutting conditions H57



KPKTB-JCT (Coolant-through type)

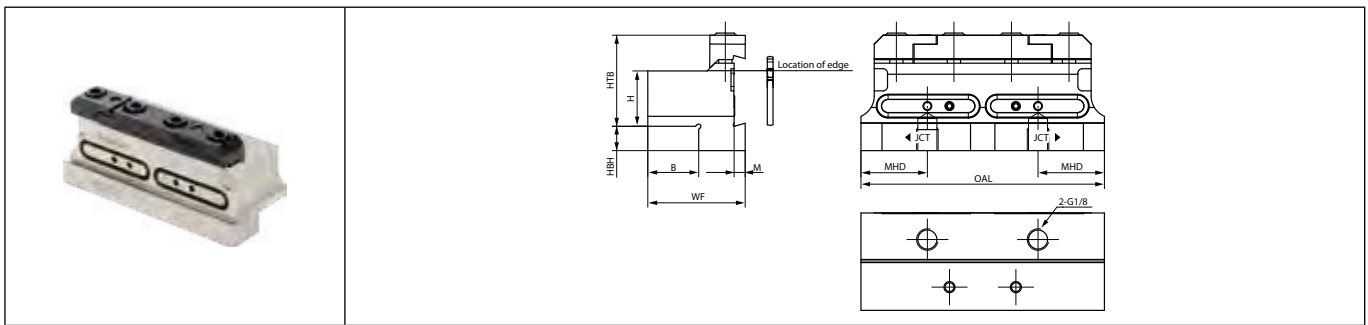

Toolholder dimensions

Description	Availability	Dimension (mm)										Coolant hole	Spare parts						Applicable blade ● G140 ● H48 ● H49 ● H60
		H	B	HBH	HTB	M	MHD	OAL	WF	Clamp bolt	Clamp set (separate type)		O-ring	Plug	Screw	Wrench			
KPKTB 20-26JCT	●	20	19	12.4	33	4	23.5	86	39	Yes	HH6X16	BCS-2	GR-020	HSG1/8X8.0	HS3X4	LW-5	KPKB26-__JCT, KTKB26-__		
20-32JCT	●			16	5		25	100	40			Yes	BCS-3		GR-026			HS4X4	
25-32JCT	●	25	23	11		41	30	110	44	Yes		BCS-4	GR-029		HS4X4			LW-5	KPKB32-__JCT KTKB32-__ KFTB [®] /L...-4S KFTB [®] /L...-5S
32-32JCT	●	32	29	5	50	50		Yes											

Includes only one HSG1/8X8.0 plug.
 KPKTB-JCT type block is also compatible with conventional KTKB type blades.
 See page H54 for coolant piping parts.
 When using internal coolant, the coolant may appear to leak slightly, but this should not affect machining performance.
 (If the O-ring is damaged, order separately.)



● : Standard item R : Right-hand only L : Left-hand only □ : Check availability

KTKTB

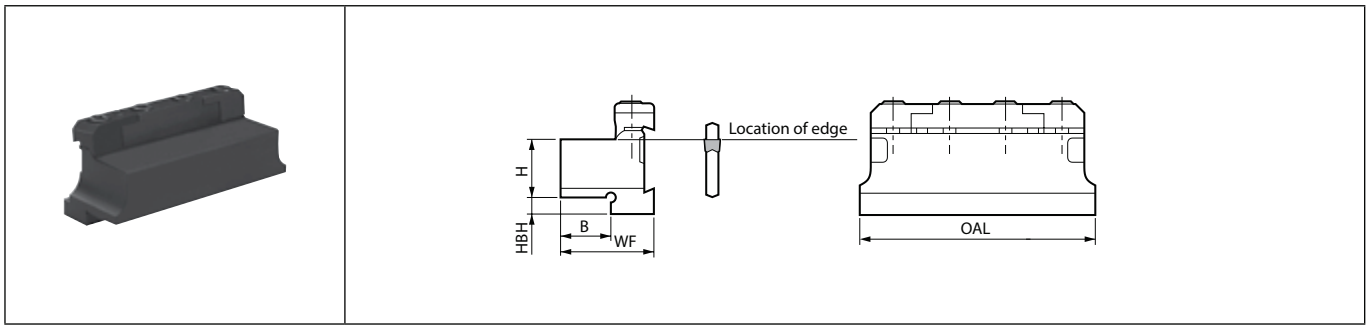

Toolholder dimensions

Description	Availability	Dimension (mm)					Spare parts				Applicable blade	
							Clamp bolt	Clamp set (integral type)	Clamp set (separate type)	Wrench	Cut-off	Face grooving
		H	B	HBH	OAL	WF						
KTKTB 16-19 20-19	●	16	15.5	4	76	29.5	HH5X25	BCS-1	-	LW-4	KPKB19-_ KTKB19-1SS, KTKB19-2S	-
KTKTB 16-26 20-26	●	16	15.5	13	86	31.5	HH6X30	-	BCS-2	LW-5	KPKB26-_(JCT) KTKB26-1SS, KTKB26-_ _S	-
KTKTB 20-32 25-32 32-32	●	20	19	13	100	38	HH6X30	-	BCS-3	LW-5	KPKB32-_(JCT) KTKB32-1SS, KTKB32-_ KTKB%L32-_ _S	KFTB%L...-4S KFTB%L...-5S
	●	25	23	8	110	42			BCS-4			
	●	32	29	5	110	48						



KTKTBF

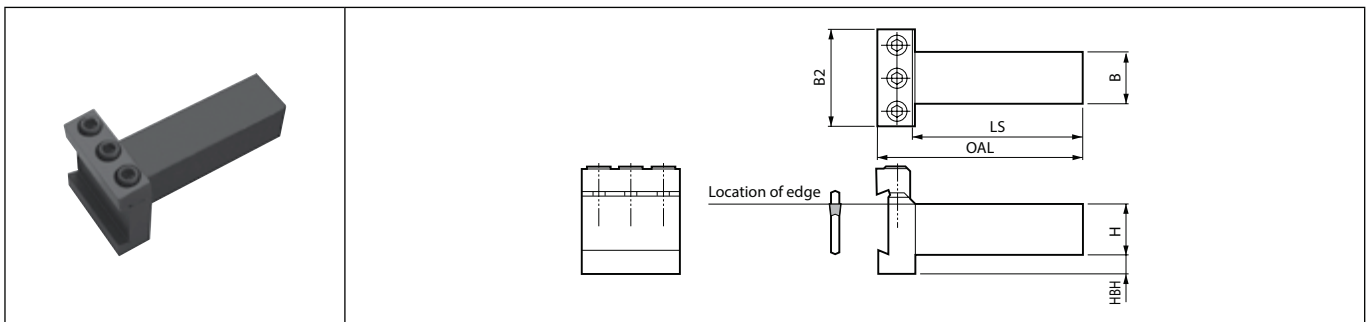

Toolholder dimensions

Description	Availability	Dimension (mm)						Spare parts			Applicable blade	
								Clamp bolt	Clamp set (integral type)	Wrench	Cut-off	Face grooving
		H	B	B2	HBH	LS	OAL					
KTKTBF 25-32 32-32	●	25	25	48	9.5	84.5	102	HH6X30	BCS-5	LW-5	KPKB32-_(JCT) KTKB32-1SS, KTKB32-_ KTKB%L32-_ _S	KFTB%L...-4S KFTB%L...-5S
	●	32	32	48	2.5	99.5	117					

● : Standard item R : Right-hand only L : Left-hand only □ : Check availability

How to mount and remove the insert

1. Use compressed air or other measures to remove chips from the insert mounting part and wrench insertion space and put in the wrench.
2. Turn the wrench.
3. Put in the insert into insert mounting part. (When removing the insert, follow the same procedure and remove it at step 3.)
4. Please clamp it while gently pressing it makes contact with the back end of blade's surface.
5. Make sure that the insert is set straight.

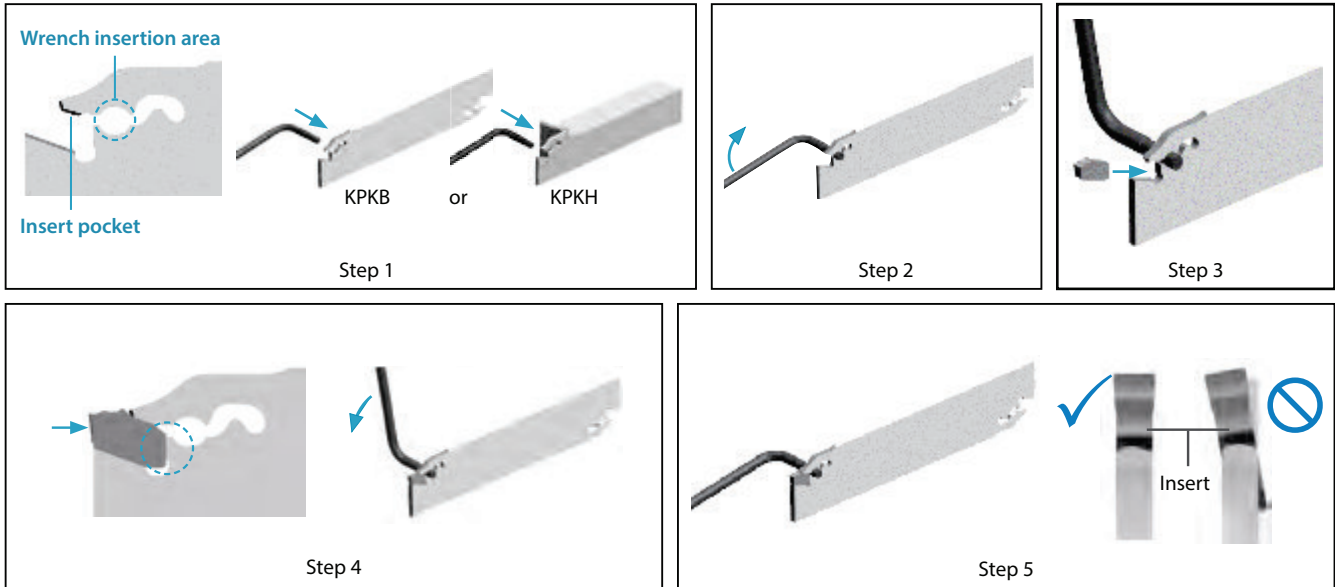

H

Cut-Off

Installation Guide

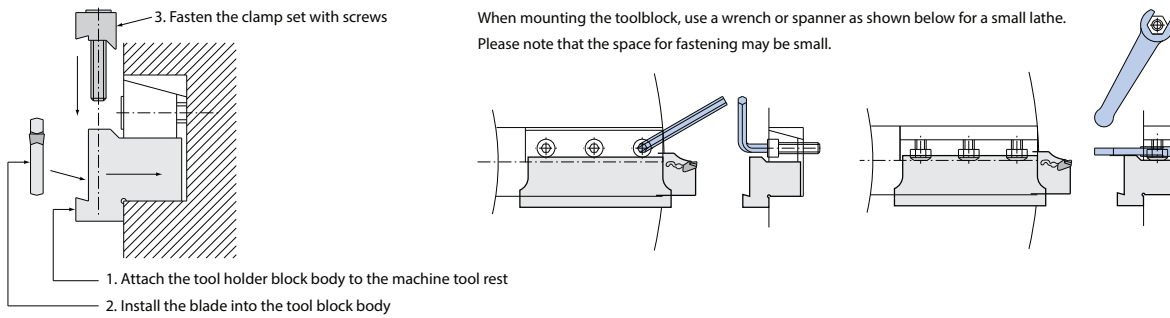

How to install the tool holder block and blade

Correct blade installation

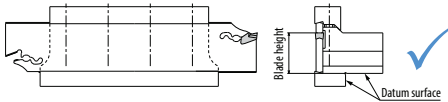

Incorrect blade installation

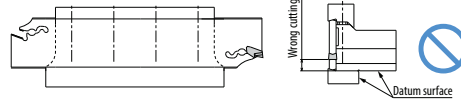

Incorrect Clamp Set Orientation

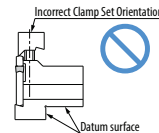

If the clamp set is mounted in the reverse direction, a large gap is created between the tool holder block main body and the clamp set as shown in the left figure. If you continue to use the product, the blade may break off. Reinstall in the correct orientation.

Internal coolant supply method Supplies according to machine specifications and requirements

A : Coolant Hose Assembly

See page H54

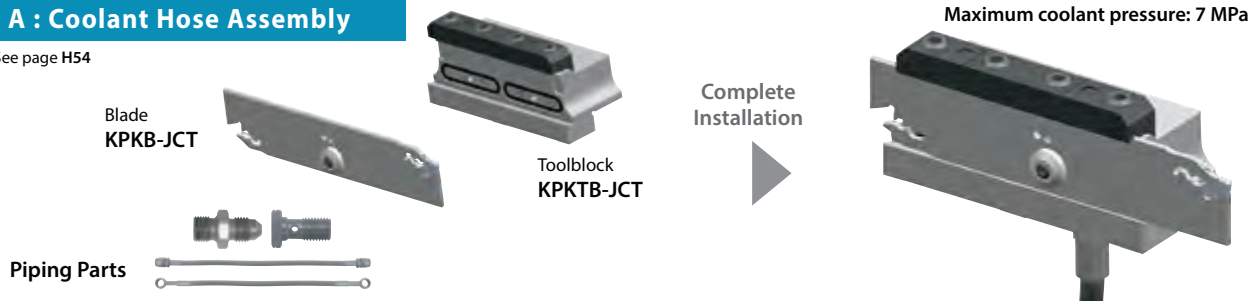

B : VDI Holder Assembly

(Internal coolant type)

Maximum coolant pressure: 7 MPa

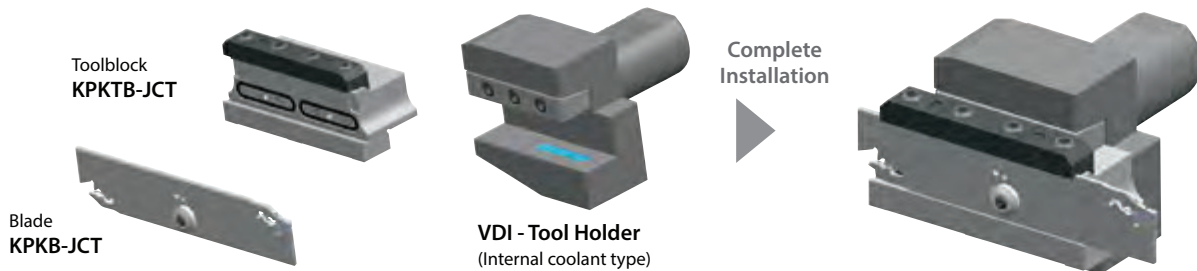

C : Coolant Pipe Assembly

See page H54

Maximum coolant pressure: 1 MPa



Coolant supply pipe mounting method

Attach to the blade with the supplied screw
Form pipe to the required shape and connect it to the piping of the machine.

Cautions

When mounting KPKB-JCT blade

When using internal coolant, keep the arrow (▼) on the blade within the range marked on the toolblock.

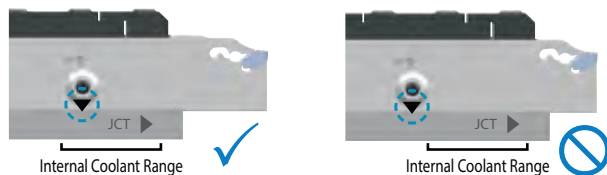

When the cap and coolant supply pipe are mounted

Coolant cannot be supplied correctly if it is mounted in the wrong position.

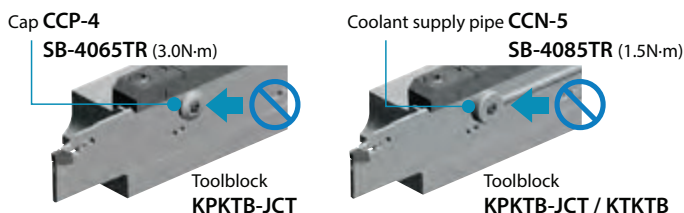

When using a toolblock

When using the discharge port B1 (B2), use a sealant for the filler cap (HSG 1/8 X 8.0) of the accessory part of the coolant supply port A1 (A2).

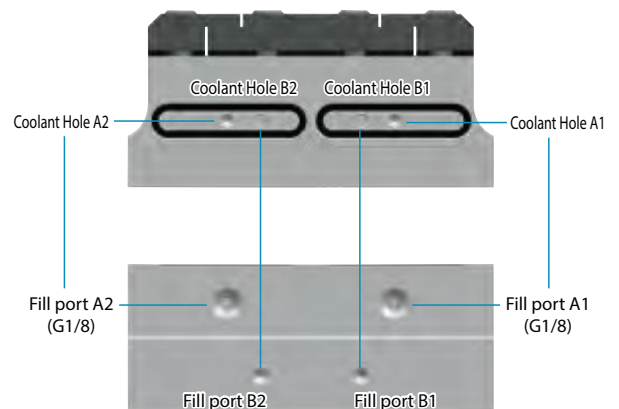

A : Coolant Hose Assembly

Connection method and piping parts

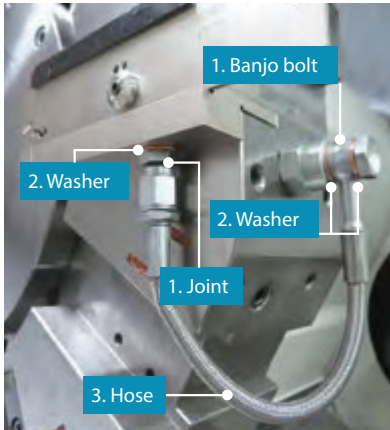

Easy Connection with High Pressure Hose and Joint

Even without a high pressure pump, internal coolant can be used at a normal pressure.

Banjo bolt available for angled hose connection

<Piping Installation Guide>

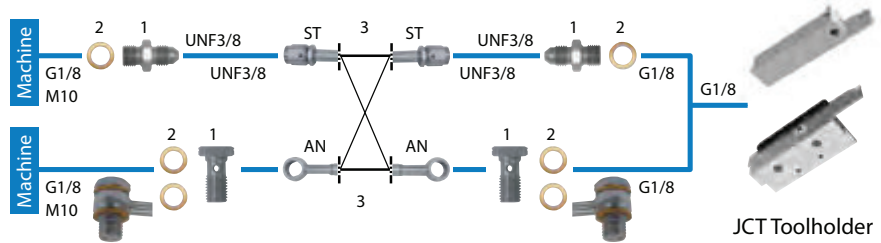

Depending on machine specifications and piping methods, **1.Joint / Banjo bolt x 2 2.Washer x 2-4 3.Hose x 1**

1. Joint / Banjo bolt (Sold separately)

Pressure Resistance : ~30MPa

Shape	Description	Stock	Thread Standard	
			Thread connection to the machine	
	J-G1/8-UNF3/8	●	G1/8	
	J-M10X1.5-UNF3/8	●	M10X1.5	
Banjo bolt (for angled hose)	BB-G1/8	●	G1/8	
	BB-M10X1.5	●	M10X1.5	

2.Washer (Sold separately)

Pressure Resistance : ~30MPa

Shape	Description	Stock
	WS-10	●

*Use 2 washers for a banjo bolt

3.Hose (Sold separately)

Pressure Resistance : ~30MPa

Shape	Description	Stock	Thread Standard		Dimension (mm)
					L
Straight/Straight	HS-ST-ST-200	●	UNF3/8	UNF3/8	200
	HS-ST-ST-250	●			250
Straight/Angled	HS-ST-AN-200	●	UNF3/8	-	200
	HS-ST-AN-250	●			(Banjo bolt)
Angled/Angled	HS-AN-AN-200	●	-	-	200
	HS-AN-AN-250	●			(Banjo bolt)

Cautions

1. Make sure machine door is completely closed before use of these parts.
2. Use appropriate seal for the male thread of the piping parts and make sure the connection is secure.
Use plugs to seal off unused coolant holes.
3. Connect and fasten the coolant hose firmly.
4. The use of copper washers may cause leakage but will have no effect on the performance.
5. Commercial piping parts can be used if the thread standards are same. Check the pressure resistance before use.
6. Regularly changing the coolant filter is recommended.

C : Coolant Pipe Assembly

Piping Parts

Coolant supply pipe (Sold separately)

Pressure Resistance : ~1MPa

Shape	Description	Stock	Dimension				Parts (Screw)
			A	B	C	D	
	CCN-5	●	190	16	5	6	SB-4085TR

Use wrench (FT-15) supplied with the blade when connecting.

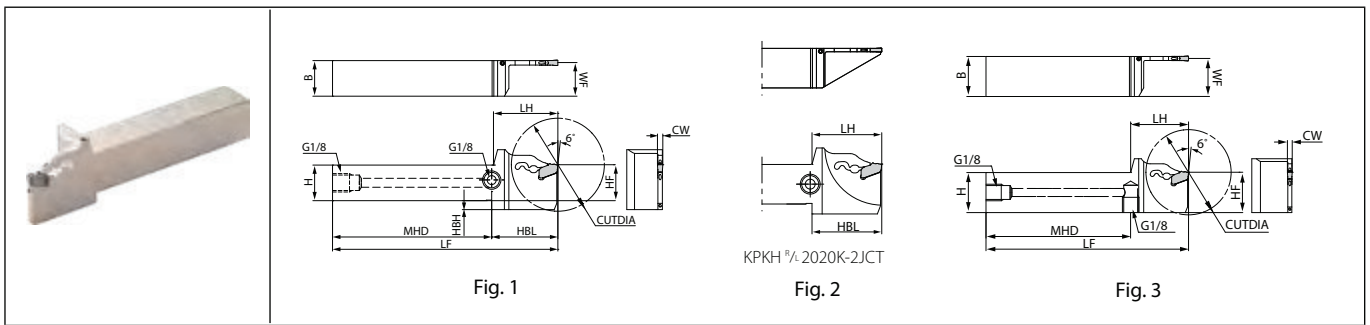

● : Std. Item

KPKH-JCT (Coolant-through holders)



Right-hand shown

Toolholder dimensions

Description	Availability		Dimension (mm)													Coolant hole	Fig.	Spare parts		Applicable inserts ➡ H46
	R	L	CUTDIA	H	B	LH	MHD	HF	HBH	HBL	LF	WF	CW	Plug	Releasing wrench					
																				
KPKH ^{3/4} 2020K-2JCT	●	●	38	20	20	35.1	89	20	5	35.1	125	19.15	2 2.4	Yes	2	HSG1/8X8.0	LPW-5	PKM20... PKM24...		
KPKH ^{3/4} 2020K-3JCT 2525K-3JCT	●	●	52	20	20	36	88	20	5	37	125	18.75	3	Yes	1 3	HSG1/8X8.0	LPW-5	PKM30...		
	●	●	53	25	25		89	25	-	-		23.75								
KPKH ^{3/4} 2020K-4JCT 2525K-4JCT	●	●	62	20	20	42.5	83	20	5	42	125	18.35	4	Yes	1 3	HSG1/8X8.0	LPW-5	PKM40...		
	●	●	68	25	25		82	25	-	-		23.35								

See page H52 for insert mounting and removal instructions
See page H54 for coolant piping parts.

Recommended cutting conditions ➡ H57



KPKH

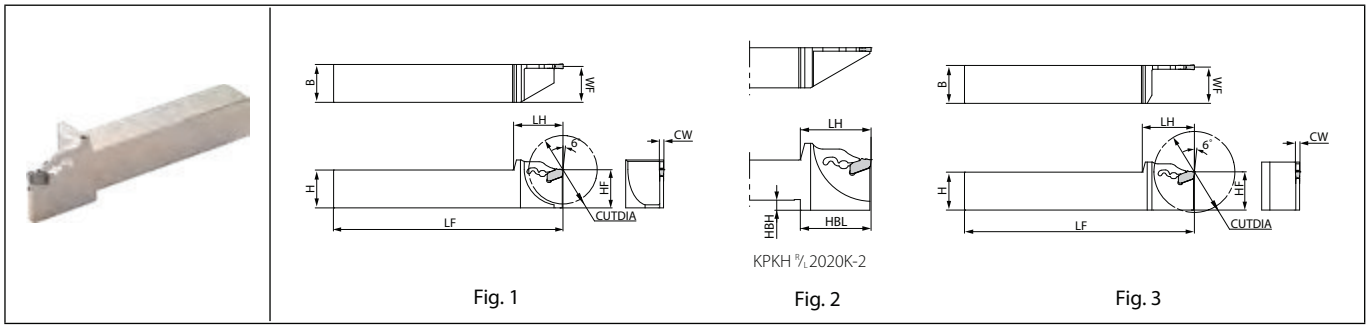

Right-hand shown

Toolholder dimensions

Description	Availability		Dimension (mm)											Coolant hole	Fig.	Spare parts	Applicable inserts ● H46					
	R	L	CUTDIA	H	B	LH	HF	HBH	HBL	LF	WF	CW	Releasing wrench									
KPKH% 2020K-2	●	●	38	20	20	33.1	20	5	33.1	125	19.15	2	No	2	LPW-5	PKM20... PKM24...						
KPKH% 2020K-3	●	●	52	20	20	34	20	-	-	125	18.75	3	No	3		PKM30...						
2525M-3	●	●	53	25	25		25			150	23.75											
KPKH% 2020K-4	●	●	62	20	20	40.5	20			-	-	125				18.35	4	No	3	PKM40...		
2525M-4	●	●	68	25	25		25					150				23.35						
KPKH% 2525M-5	●	●	79	25	25	45.9	25					150				22.95	4.8			5	No	1
KPKH% 2020K-3D35	●	●	35	20	20	32.5	20					-			-	125	18.75			3	No	1
2525M-3D45	●	●	45	25	25		25	150	23.75													
KPKH% 2020K-4D45	●	●	45	20	20	35	20	-	-				125	18.35		4	No			1		
2525M-4D45	●	●	45	25	25		25			150	23.35											

See page H52 for insert mounting and removal instructions

Recommended cutting conditions ● H57



● : Standard item R : Right-hand only L : Left-hand only □ : Check availability

Recommended cutting conditions

PM Chipbreaker

Workpiece material	Recommended insert grades (Vc: m/min)			f (mm/rev)			Remarks
	MEGACOAT NANO		Carbide	Edge width CW (mm)			
	PR1625	PR1535	GW15	1.6	2 ~ 4	4.8 ~ 6	
Carbon steel	★ 80 – 220	☆ 80 – 220	-	0.03 – 0.12	0.08 – 0.18	0.10 – 0.22	Coolant
Alloy steel	★ 70 – 200	☆ 70 – 200	-				
Stainless steel	☆ 60 – 150	★ 60 – 150	-	0.03 – 0.08	0.06 – 0.12	0.08 – 0.15	
Cast iron	-	-	★ 50 – 100	0.03 – 0.08	0.08 – 0.18	0.10 – 0.22	
Aluminum Alloys	-	-	★ 200 – 450	0.03 – 0.08	0.08 – 0.18	0.10 – 0.22	
Brass	-	-	★ 100 – 200				

Reduce feed to 1/2 ~ 1/3 at the center of the workpiece.

PH Chipbreaker

Workpiece material	Recommended insert grades (Vc: m/min)			f (mm/rev)			Remarks
	MEGACOAT NANO		Carbide	Edge width CW (mm)			
	PR1625	PR1535	GW15	2	3 ~ 4	5 ~ 6	
Carbon steel	★ 80 – 220	☆ 80 – 220	-	0.10 – 0.22	0.15 – 0.28	0.15 – 0.35	Coolant
Alloy steel	★ 70 – 200	☆ 70 – 200	-				
Stainless steel	☆ 60 – 150	★ 60 – 150	-	0.05 – 0.12	0.08 – 0.15	0.08 – 0.18	
Cast iron	-	-	-	-	-	-	
Aluminum Alloys	-	-	-	-	-	-	
Brass	-	-	-				

Reduce feed to 1/2 ~ 1/3 at the center of the workpiece.

H



Cut-Off

TKN/TK

Insert		Description		Dimension (mm)		Angle (°)	Tolerance (mm)		Carbide					Cermet	Applicable toolholder H60, H61	
				No. of edges	CW		RE	PSIR%/L	CW min.	CW max.	CVD	PVD	-			-
						CR9025								PR1535		
									<input checked="" type="checkbox"/>	<input type="checkbox"/>	<input type="checkbox"/>	<input type="checkbox"/>	<input type="checkbox"/>	<input type="checkbox"/>	P	
									<input type="checkbox"/>	<input checked="" type="checkbox"/>	<input type="checkbox"/>	<input type="checkbox"/>	<input type="checkbox"/>	<input type="checkbox"/>	M	
									<input type="checkbox"/>	<input type="checkbox"/>	<input checked="" type="checkbox"/>	<input type="checkbox"/>	<input type="checkbox"/>	<input type="checkbox"/>	K	
									<input type="checkbox"/>	<input type="checkbox"/>	<input type="checkbox"/>	<input checked="" type="checkbox"/>	<input type="checkbox"/>	<input type="checkbox"/>	N	
		TKN 1.6	1.6	1	1.6	0.15	-	-0.05	+0.05	<input checked="" type="checkbox"/>	<input checked="" type="checkbox"/>	<input checked="" type="checkbox"/>	<input checked="" type="checkbox"/>	<input checked="" type="checkbox"/>	TKTB...-1SS	
		TKN 2	2	1	2.2	0.2	-	-0.05	+0.05	<input checked="" type="checkbox"/>	<input checked="" type="checkbox"/>	<input checked="" type="checkbox"/>	<input checked="" type="checkbox"/>	<input checked="" type="checkbox"/>	<input checked="" type="checkbox"/>	TKTB19-2S, KTKB26-2S, KTKB32-2S, KTKH%/L...-2S
		TKN 2.4	2.4	1	2.4	0.2	-	-0.05	+0.05	<input checked="" type="checkbox"/>	<input checked="" type="checkbox"/>	<input checked="" type="checkbox"/>	<input checked="" type="checkbox"/>	<input checked="" type="checkbox"/>	<input checked="" type="checkbox"/>	TKTB19-2S, KTKB26-2S, KTKB32-2S, KTKH%/L...-2S
		TKN 3	3	1	3.1	0.25	-	-0.05	+0.05	<input checked="" type="checkbox"/>	<input checked="" type="checkbox"/>	<input checked="" type="checkbox"/>	<input checked="" type="checkbox"/>	<input checked="" type="checkbox"/>	<input checked="" type="checkbox"/>	TKTB26-3S, KTKB32-3S, KTKH%/L...-3S, KTKH%/L...-3T.S
		TKN 4	4	1	4.1	0.3	-	-0.05	+0.05	<input checked="" type="checkbox"/>	<input checked="" type="checkbox"/>	<input checked="" type="checkbox"/>	<input checked="" type="checkbox"/>	<input checked="" type="checkbox"/>	<input checked="" type="checkbox"/>	TKTB26-4S, KTKB32-4S, KTKH%/L...-4S, KTKH%/L...-4T2S
		TKN 4.8	4.8	1	4.8	0.3	-	-0.05	+0.05	<input checked="" type="checkbox"/>	<input checked="" type="checkbox"/>	<input checked="" type="checkbox"/>	<input checked="" type="checkbox"/>	<input checked="" type="checkbox"/>	<input checked="" type="checkbox"/>	TKTB26-5S, KTKB32-5S, KTKH%/L.2525M-5S
		TKN 5	5	1	5.1	0.3	-	-0.05	+0.05	<input checked="" type="checkbox"/>	<input checked="" type="checkbox"/>	<input checked="" type="checkbox"/>	<input checked="" type="checkbox"/>	<input checked="" type="checkbox"/>	<input checked="" type="checkbox"/>	TKTB26-5S, KTKB32-5S, KTKH%/L.2525M-5S
		TKN 6	6	1	6.4	0.35	-	-0.05	+0.05	<input checked="" type="checkbox"/>	<input checked="" type="checkbox"/>	<input checked="" type="checkbox"/>	<input checked="" type="checkbox"/>	<input checked="" type="checkbox"/>	<input checked="" type="checkbox"/>	TKTB32-6S
		TKN 8	8	1	8	0.4	-	-0.05	+0.05	<input checked="" type="checkbox"/>	<input checked="" type="checkbox"/>	<input checked="" type="checkbox"/>	<input checked="" type="checkbox"/>	<input checked="" type="checkbox"/>	<input checked="" type="checkbox"/>	TKTB%/L.32-8S
		TKN 9	9	1	9.6	0.45	-	-0.05	+0.05	<input checked="" type="checkbox"/>	<input checked="" type="checkbox"/>	<input checked="" type="checkbox"/>	<input checked="" type="checkbox"/>	<input checked="" type="checkbox"/>	<input checked="" type="checkbox"/>	TKTB%/L.32-9S
		TKN 1.6-P	1.6	1	1.6	0.2	-	-0.05	+0.05	<input checked="" type="checkbox"/>	<input checked="" type="checkbox"/>	<input checked="" type="checkbox"/>	<input checked="" type="checkbox"/>	<input checked="" type="checkbox"/>	TKTB...-1SS	
		TKN 2-P	2	1	2.2	0.2	-	-0.05	+0.05	<input checked="" type="checkbox"/>	<input checked="" type="checkbox"/>	<input checked="" type="checkbox"/>	<input checked="" type="checkbox"/>	<input checked="" type="checkbox"/>	TKTB19-2S, KTKB26-2S, KTKB32-2S, KTKH%/L...-2S	
		TKN 3-P	3	1	3.1	0.25	-	-0.05	+0.05	<input checked="" type="checkbox"/>	<input checked="" type="checkbox"/>	<input checked="" type="checkbox"/>	<input checked="" type="checkbox"/>	<input checked="" type="checkbox"/>	TKTB26-3S, KTKB32-3S, KTKH%/L...-3S, KTKH%/L...-3T.S	
		TKR 1.6	1.6	1	1.6	0.15	8	-0.05	+0.05	<input checked="" type="checkbox"/>	<input checked="" type="checkbox"/>	<input checked="" type="checkbox"/>	<input checked="" type="checkbox"/>	<input checked="" type="checkbox"/>	TKTB...-1SS	
		TKL 1.6	1.6	1	1.6	0.15	8	-0.05	+0.05	<input checked="" type="checkbox"/>	<input checked="" type="checkbox"/>	<input checked="" type="checkbox"/>	<input checked="" type="checkbox"/>	<input checked="" type="checkbox"/>	TKTB...-1SS	
		TKR 2	2	1	2.2	0.2	8	-0.05	+0.05	<input checked="" type="checkbox"/>	<input checked="" type="checkbox"/>	<input checked="" type="checkbox"/>	<input checked="" type="checkbox"/>	<input checked="" type="checkbox"/>	TKTB19-2S, KTKB26-2S, KTKB32-2S, KTKH%/L...-2S	
		TKL 2	2	1	2.2	0.2	8	-0.05	+0.05	<input checked="" type="checkbox"/>	<input checked="" type="checkbox"/>	<input checked="" type="checkbox"/>	<input checked="" type="checkbox"/>	<input checked="" type="checkbox"/>	TKTB19-2S, KTKB26-2S, KTKB32-2S, KTKH%/L...-2S	
		TKR 2.4	2.4	1	2.4	0.2	8	-0.05	+0.05	<input checked="" type="checkbox"/>	<input checked="" type="checkbox"/>	<input checked="" type="checkbox"/>	<input checked="" type="checkbox"/>	<input checked="" type="checkbox"/>	TKTB19-2S, KTKB26-2S, KTKB32-2S, KTKH%/L...-2S	
		TKL 2.4	2.4	1	2.4	0.2	8	-0.05	+0.05	<input checked="" type="checkbox"/>	<input checked="" type="checkbox"/>	<input checked="" type="checkbox"/>	<input checked="" type="checkbox"/>	<input checked="" type="checkbox"/>	TKTB19-2S, KTKB26-2S, KTKB32-2S, KTKH%/L...-2S	
		TKR 3	3	1	3.1	0.25	8	-0.05	+0.05	<input checked="" type="checkbox"/>	<input checked="" type="checkbox"/>	<input checked="" type="checkbox"/>	<input checked="" type="checkbox"/>	<input checked="" type="checkbox"/>	TKTB26-3S, KTKB32-3S, KTKH%/L...-3S, KTKH%/L...-3T.S	
TKL 3	3	1	3.1	0.25	8	-0.05	+0.05	<input checked="" type="checkbox"/>	<input checked="" type="checkbox"/>	<input checked="" type="checkbox"/>	<input checked="" type="checkbox"/>	<input checked="" type="checkbox"/>	TKTB26-3S, KTKB32-3S, KTKH%/L...-3S, KTKH%/L...-3T.S			
TKR 4	4	1	4.1	0.3	8	-0.05	+0.05	<input checked="" type="checkbox"/>	<input checked="" type="checkbox"/>	<input checked="" type="checkbox"/>	<input checked="" type="checkbox"/>	<input checked="" type="checkbox"/>	TKTB26-4S, KTKB32-4S, KTKH%/L...-4S, KTKH%/L...-4T2S			
TKL 4	4	1	4.1	0.3	8	-0.05	+0.05	<input checked="" type="checkbox"/>	<input checked="" type="checkbox"/>	<input checked="" type="checkbox"/>	<input checked="" type="checkbox"/>	<input checked="" type="checkbox"/>	TKTB26-4S, KTKB32-4S, KTKH%/L...-4S, KTKH%/L...-4T2S			
TKR 5	5	1	5.1	0.3	8	-0.05	+0.05	<input checked="" type="checkbox"/>	<input checked="" type="checkbox"/>	<input checked="" type="checkbox"/>	<input checked="" type="checkbox"/>	<input checked="" type="checkbox"/>	TKTB26-5S, KTKB32-5S, KTKH%/L.2525M-5S			
TKL 5	5	1	5.1	0.3	8	-0.05	+0.05	<input checked="" type="checkbox"/>	<input checked="" type="checkbox"/>	<input checked="" type="checkbox"/>	<input checked="" type="checkbox"/>	<input checked="" type="checkbox"/>	TKTB26-5S, KTKB32-5S, KTKH%/L.2525M-5S			
		TKR 1.6-P	1.6	1	1.6	0.2	8	-0.05	+0.05	<input checked="" type="checkbox"/>	<input checked="" type="checkbox"/>	<input checked="" type="checkbox"/>	<input checked="" type="checkbox"/>	<input checked="" type="checkbox"/>	TKTB...-1SS	
		TKL 1.6-P	1.6	1	1.6	0.2	8	-0.05	+0.05	<input checked="" type="checkbox"/>	<input checked="" type="checkbox"/>	<input checked="" type="checkbox"/>	<input checked="" type="checkbox"/>	<input checked="" type="checkbox"/>	TKTB...-1SS	
		TKR 2-P	2	1	2.2	0.2	8	-0.05	+0.05	<input checked="" type="checkbox"/>	<input checked="" type="checkbox"/>	<input checked="" type="checkbox"/>	<input checked="" type="checkbox"/>	<input checked="" type="checkbox"/>	TKTB19-2S, KTKB26-2S, KTKB32-2S, KTKH%/L...-2S	
		TKL 2-P	2	1	2.2	0.2	8	-0.05	+0.05	<input checked="" type="checkbox"/>	<input checked="" type="checkbox"/>	<input checked="" type="checkbox"/>	<input checked="" type="checkbox"/>	<input checked="" type="checkbox"/>	TKTB19-2S, KTKB26-2S, KTKB32-2S, KTKH%/L...-2S	
TKR 3-P	3	1	3.1	0.25	8	-0.05	+0.05	<input checked="" type="checkbox"/>	<input checked="" type="checkbox"/>	<input checked="" type="checkbox"/>	<input checked="" type="checkbox"/>	<input checked="" type="checkbox"/>	TKTB26-3S, KTKB32-3S, KTKH%/L...-3S, KTKH%/L...-3T.S			
TKL 3-P	3	1	3.1	0.25	8	-0.05	+0.05	<input checked="" type="checkbox"/>	<input checked="" type="checkbox"/>	<input checked="" type="checkbox"/>	<input checked="" type="checkbox"/>	<input checked="" type="checkbox"/>	TKTB26-3S, KTKB32-3S, KTKH%/L...-3S, KTKH%/L...-3T.S			

Handed insert shows Right-hand

TKN - cut-off tools

Cutting range	Chipbreaker	Advantage
General cut-off	Standard (No indication)	General cut-off type for feed rates over 0.1mm/rev Superior chip evacuation
Low feed cut-off	P	Chipbreaker specially designed for low feed machining on automatic lathes, etc. Chips are controlled at feed rate 0.03~0.08mm/rev

Inserts edge preparation

Edge preparation	Chamfer + R honed	Sharp edge	R honed
Standard chipbreaker	TN90 / PR1535 / CR9025 / PR660	PR930 / KW10	-
P-chipbreaker	-	-	TN620 / TN90 / CR9025 / PR1535 / PR660 / PR930 / KW10

Sharp edge specification can reduce cutting force by 40% less than that of chamfer edge.

● : Standard item R : Right-hand only L : Left-hand only □ : Check availability

How to select cut-off inserts with / without lead angle (Including sharp corner)

1. Use a neutral angle insert if there is no limit to the finished shape.
2. Use an angled insert to reduce the size of the remaining boss.
3. Use a sharp-cornered lead-angled insert to make the remaining boss much smaller when machining small parts and thin parts.

Hand of lead angle	N (Neutral)	R (Right-hand)	L (Left-hand)
Angled insert can reduce the burr size when cutting off. When using a larger lead angle, cutting force becomes smaller, but the feed rate should be reduced.			

	Right-hand (R) Lead angle	Neutral
Example: Solid workpiece		
Example: Hollow workpiece (Pipe)		

Fig.1

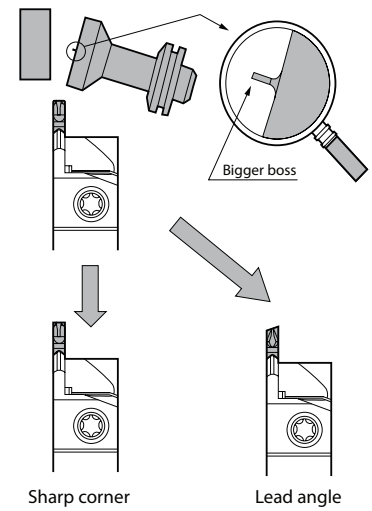

Fig.2

Caution

1. For TKN and TK^{R/L}, set the cutting edge height 0.1~0.2 mm above the center height (Fig. 3)
For other toolholders, set the cutting edge to the center height.
2. Be sure to perform wet processing. Apply enough coolant to the cutting edge.
3. Keep a constant rate during processing so that optimum product life will be achieved.
4. Cut off as close to the chuck as possible.
5. Lower the feed rate to 1/2 to 1/3 at the near center to prevent impact caused by machining.

Overuse of insert and toolholder (blade) may cause insert breakage and toolholder (blade) damage.
Do not rework the insert and toolholder (blade) to prevent damage.
Clean the insert pocket well with compressed air when replacing insert.

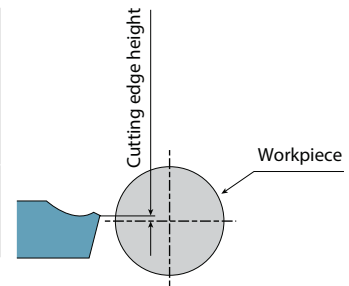

Fig. 3 (TKN, TK^{R/L})

Set up (TKN / TK^{R/L})

1. Tap the insert lightly with a plastic hammer to push it into the extent that it cannot be removed by hand. (Fig.1)
(Pull it to the point where it does not fall out when picked up lightly with fingers)
2. Remove the insert with the supplied wrench. (Fig.2)

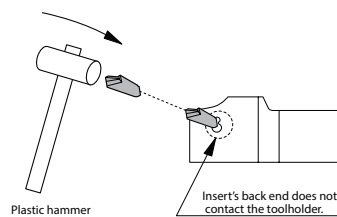

Fig.1: How to attach inserts

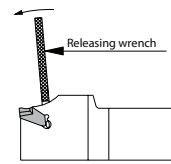
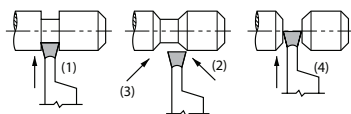

Fig.2: How to detach inserts

Application example of cut-off

1. Cut-off after chamfering

- (1) Grooving (2)(3) Chamfering (4) Cut-off



2. Wide grooving

- (1)~(5) Groove widening
- (6) Finishing
(Value of "ap" shall be under the value of Corner-R)

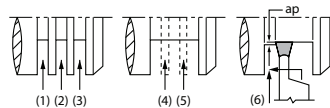

(In order to prevent both corners' unequal wear)



KTKB

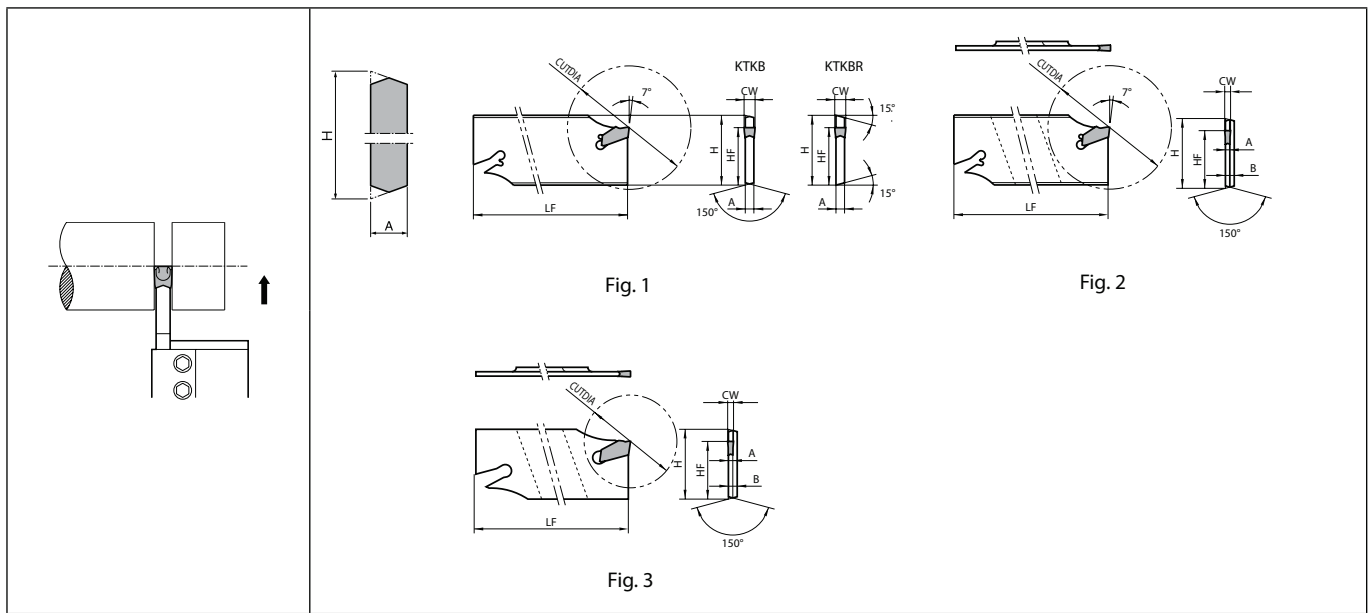

Toolholder dimensions

Description	Availability	Dimension (mm)							Fig.	Spare parts Releasing wrench	Applicable inserts H58	Applicable tool block H50, H51
		CUTDIA	A	B	H	HF	LF	CW				
KTKB 19-1SS 26-1SS 32-1SS	● ● ●	32 35	1.2	2.4	19 26 32	15.7 21.4 25	86 110 150	1.6	3	TKN1.6, TKN1.6-P TK%1.6, TKR1.6-P TKN2, TKN2-P TK%2, TK%2.2-P TKN2.4, TK%2.4 TKN3, TKN3-P, TK%3, TK%3-P TKN4, TK%4 TKN5, TK%5 TKN6 TKN8 TKN9	KTKTB16-19, KTKTB20-19 KTKTB16-26, KTKTB20-26, KPCTB20-26JCT KTKTB20-32, KTKTB25-32, KTKTB32-32 KTKTBF25-32, KTKTBF32-32, KPCTB20-32JCT KPCTB25-32JCT, KPCTB32-32JCT KTKTB16-19, KTKTB20-19 KTKTB16-26 KTKTB20-26 KPCTB20-26JCT KTKTB20-32 KTKTB25-32 KTKTB32-32 KTKTBF25-32 KPCTB20-32JCT KPCTB25-32JCT KPCTB32-32JCT	
KTKB 19-2S	●	40	1.8	-	19	15.7	86	2.2 2.4	1			
KTKB 26-2S 26-3S 26-4S 26-5S	● ● ● ●	50 75 80	1.8 2.6 3.4 4.2	-	26	21.4	110	2.2 2.4 3.1 4.1 4.8 5.1	1			
KTKB 32-2S 32-3S 32-4S 32-5S 32-6S	● ● ● ● ●	50 100 120	1.8 2.6 3.4 4.2 5.4	2.6	32	25	150	2.2 2.4 3.1 4.1 4.8 5.1 6.4	2 1			
KTKBR 32-8S KTKBL 32-8S	R L	120	6.8	-	32	25	150	8	1			
KTKBR 32-9S	R	120	8	-	32	25	150	9.6	1			

Suffix "-SS" means silver coating.
 Releasing wrench is "LTK-5".
 How to attach inserts, See Page H59.
 Dimension H shows virtual apex distance.

● : Standard item R : Right-hand only L : Left-hand only □ : Check availability

H60

KTKH

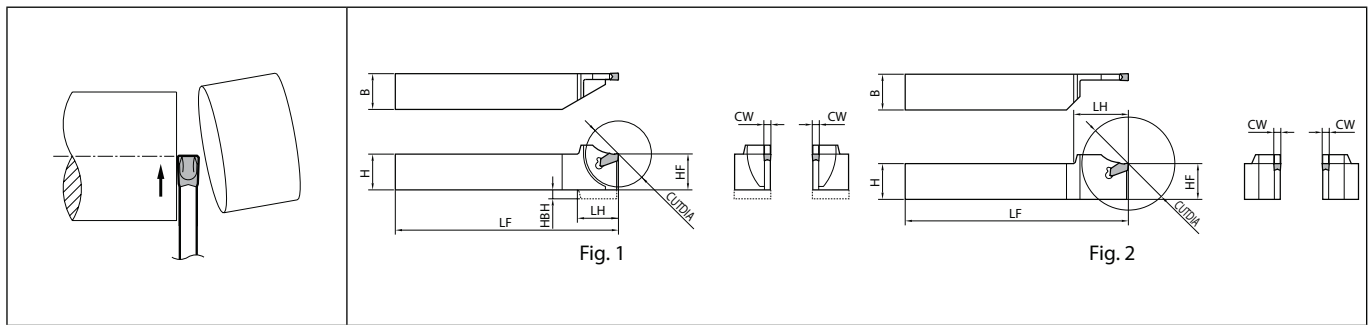

Right-hand shown

Toolholder dimensions

Description	Availability		Dimension (mm)										Fig.	Spare parts		Applicable inserts H58
														Releasing wrench		
	R	L	CUTDIA	H	B	LH	HF	HBH	LF	CW						
KTKH%L 1010F-2S 1212H-2S 1612H-2S 1616H-2S 2012K-2S 2020K-2S	●	●	28	10	10	18.6	10	5	80	2.2	2.4	1	LTK-5	TKN2 TKN2-P TK%L2 TK%L2-P TKN2.4 TK%L2.4		
	●	●	31	16	12	19.8	16	-	100							
	●	●	36	20	12	22.8	20	-	125							
	●	●	36	20	12	22.8	20	-	125							
	●	●	36	20	12	22.8	20	-	125							
KTKH%L 1612H-3S 1616H-3S 2012K-3S 2020K-3S 2525M-3S	●	●	35	16	12	21.7	16	4	100	3.1	2	1	LTK-5	TKN3 TKN3-P TK%L3 TK%L3-P		
	●	●	40	20	12	25.3	20	-	125							
	●	●	51	20	20	31	-	-	150							
	●	●	52	25	25	31.5	25	-	150							
	●	●	52	25	25	31.5	25	-	150							
KTKH%L 2012K-4S 2020K-4S 2525M-4S	●	●	43	20	12	26.3	20	-	125	4.1	2	1	LTK-5	TKN4 TK%L4		
	●	●	59	20	20	35	-	-	150							
	●	●	66	25	25	38	25	-	150							
KTKH%L 2525M-5S	●	●	77	25	25	43.5	25	-	150	5.1	2	1	LTK-5	TKN5 TK%L5		
	●	●	77	25	25	43.5	25	-	150							
KTKH%L 2020K-3T17S 2525M-3T22S	●	●	33	20	20	21.8	20	-	125	3.1	1	1	LTK-5	TKN3, TKN3-P TK%L3, TK%L3-P		
	●	●	43	25	25	26.8	25	-	150							
KTKH%L 2020K-4T22S 2525M-4T22S	●	●	44	20	20	26.8	20	-	125	4.1	1	1	LTK-5	TKN4 TK%L4		
	●	●	44	25	25	26.8	25	-	150							

How to attach inserts, See Page H59.

● : Standard item R : Right-hand only L : Left-hand only □ : Check availability



Recommended cutting conditions (TKN, TK^{R/L})

Workpiece material	Recommended insert grades (Vc: m/min)						Edge width CW (mm)					Remarks
	Cermet		CVD coated carbide	MEGACOAT NANO	PVD coated carbide	Carbide	1.6	2.2 / 2.4	3.1	4.1	4.8 ~ 9.6	
	TN620	TN90	CR9025	PR1535	PR930	KW10	f (mm/rev)					
Carbon steel	☆ 60 ~ 200	☆ 120 ~ 200	★ 80 ~ 180	☆ 60 ~ 150	☆ 60 ~ 130	-	0.02 ~ 0.08	0.04 ~ 0.18	0.05 ~ 0.25	0.08 ~ 0.30	0.15 ~ 0.40	Coolant
Alloy steel	☆ 60 ~ 160	☆ 100 ~ 160	★ 70 ~ 150	☆ 60 ~ 150	☆ 60 ~ 130	-	0.02 ~ 0.08	0.04 ~ 0.18	0.05 ~ 0.25	0.08 ~ 0.30	0.15 ~ 0.40	
Stainless steel	☆ 60 ~ 150	☆ 80 ~ 150	☆ 60 ~ 140	★ 50 ~ 120	☆ 60 ~ 140	-	0.02 ~ 0.06	0.04 ~ 0.12	0.05 ~ 0.18	0.08 ~ 0.25	0.10 ~ 0.30	
Cast iron	-	-	-	-	-	★ 50 ~ 100	0.02 ~ 0.08	0.05 ~ 0.12	0.10 ~ 0.25	0.10 ~ 0.30	0.15 ~ 0.35	
Aluminum alloys	-	-	-	-	-	★ 100 ~ 450	0.02 ~ 0.10	0.05 ~ 0.10	0.05 ~ 0.20	0.05 ~ 0.25	0.10 ~ 0.25	
Brass	-	-	-	-	-	★ 100 ~ 200	0.02 ~ 0.10	0.05 ~ 0.10	0.05 ~ 0.15	0.05 ~ 0.20	0.10 ~ 0.25	

★: 1st Recommendation ☆: 2nd Recommendation

H



Cut-Off



Introduction		J2
Threading inserts		J6
Metric	External threading	J6
	Internal threading	J7
Unified	External threading	J8
	Internal threading	J9
Parallel pipe, Whitworth	External threading	J10
	Internal threading	J11
Tapered pipe	External threading	J12
	Internal threading	J13
American national tapered pipe	External threading	J14
	Internal threading	J15
60° type (Partial profile/M, UN)	External threading	J16
	Internal threading	J17
55° type (Partial profile/G, R, Rc, W)	External threading	J18
	Internal threading	J19
30° type (Trapezoidal)	External threading	J20
	Internal threading	J21
Threading toolholders		J22
External toolholders	KTN/KTNS/KTN-JCT	J22
	S-KTN	J25
Internal toolholders	SIN/CIN	J26
Multipurpose threading tools		J28
TKFT for small parts machining	KTKF	J29
Threading tools		J34
TTX	KTTX/S-KTTX	J35
TT for external threading	KTT	J37
TT for internal threading	KITG	J39
EZ Bars for micro internal threading	EZT	J40
System Tip-Bars for micro internal threading	VNT	J44
TPGB for internal threading	S-STWP/S-STWP-E	J47
Recommended cutting conditions		J48
Depth of cut and number of passes		J49
Applicable toolholders and inserts		J58
Threading methods		J63
Thread types and basic profiles		J65

Tooling application table (External thread)

Thread types	Metric	Unified	Parallel pipe	Whitworth	Tapered pipe	American national tapered pipe	30° trapezoidal	
	M	UN, UNC UNF, UNEF	G(PF)	W	R(PT) (BSPT)	NPT	Tr	
Thread shape								
Toolholder shape	Pitch	mm	TPI	TPI	TPI	TPI	mm	
 KTN J22 (KTN-JCT) J23	Full profile	0.5~5.0 (0.5~3.0) J6	24~8 (24~8) J8	19~11 (19~11) J10	16~11 (16~11) J10	28~11 (28~11) J12	18~11.5 (18~11.5) J14	-
	Partial profile	0.5~5.0 (0.5~3.0) J16	48~5 (48~8) J16	28~11 (28~11) J18	40~5 (40~8) J18	28~11 (28~11) J18	-	2.0~5.0 (2.0~3.0) J20
 KTNS J24	Full profile	0.5~3.0 J6	24~8 J8	19~11 J10	16~11 J10	28~11 J12	18~11.5 J14	-
	Partial profile	0.5~3.0 J16	48~8 J16	28~11 J18	40~8 J18	28~11 J18	-	2.0~3.0 J20
 Sleeve holder S-KTN J25	Full profile	0.5~3.0 J6	24~8 J8	19~11 J10	16~11 J10	28~11 J12	18~11.5 J14	-
	Partial profile	0.5~3.0 J16	48~8 J16	28~11 J18	40~8 J18	28~11 J18	-	2.0~3.0 J20
 KIT J37	Full profile	1.0~2.0 J36	-	-	-	-	-	-
	Partial profile	0.5~3.5 J36	56~8 J36	28~11 J36	24~7 J36	28~11 J36	-	-
 KTTX J35	Full profile	0.5~2.0 J34	56~14 J34	28~11 J34	24~11 J34	28~11 J34	-	-
	Partial profile	0.5~2.0 J34	56~14 J34	28~11 J34	24~11 J34	28~11 J34	-	-
 S-KTTX J35	Full profile	0.5~2.0 J34	56~14 J34	28~11 J34	24~11 J34	28~11 J34	-	-
	Partial profile	0.5~2.0 J34	56~14 J34	28~11 J34	24~11 J34	28~11 J34	-	-
 KTKF J29	Full profile	0.2~1.5 J29	64~18 J29	28~19 J29	40~16 J29	28~19 J29	-	-
	Partial profile	0.2~1.5 J29	64~18 J29	28~19 J29	40~16 J29	28~19 J29	-	-
 KTKF / KTKF-Y J30, J31 (Goose-neck holder / Y-axis holder)	Full profile	0.2~1.5 J29	64~18 J29	28~19 J29	40~16 J29	28~19 J29	-	-
	Partial profile	0.2~1.5 J29	64~18 J29	28~19 J29	40~16 J29	28~19 J29	-	-

Pitch inside () indicates KTN-JCT.

Tooling application table (Internal thread)

Thread types	Metric	Unified	Parallel pipe	Whitworth	Tapered pipe	American national tapered pipe	30° trapezoidal	
	M	UN, UNC UNF, UNEF	G(PF) Rp(PS)	W	Rc(PT) (BSPT)	NPT	Tr	
Thread shape								
Pitch	mm	TPI	TPI	TPI	TPI	TPI	mm	
Toolholder shape								
 Ezt J40	Partial profile	0.5~1.75 J40	36~16 J40	28~19 J40	24~18 J40	28~19 J40	18~14 J40	-
 Vnt J44	Partial profile	0.75~1.5 J44	28~18 J44	-	-	-	-	-
 Sint J26	Full profile	0.5~5.0 J7	24~8 J9	19~11 J11	16~11 J11	28~11 J13	18~11.5 J15	-
 Sint J26	Partial profile	0.5~5.0 J17	48~5 J17	28~11 J19	40~5 J19	28~11 J19	-	2.0~5.0 J21
 Cin J27	Full profile	1.0~5.0 J7	24~8 J9	19~11 J11	16~11 J11	14~11 J13	18~11.5 J15	-
 Cin J27	Partial profile	0.5~5.0 J17	48~5 J17	28~11 J19	40~5 J19	28~11 J19	-	2.0~5.0 J21
 Kitg J39	Partial profile	0.5~3.0 J38	48~8 J38	28~11 J38	24~8 J38	28~11 J38	-	-
 Stwp J47	Partial profile	0.75~3.5 J46	28~8 J46	-	-	-	-	-

For parallel pipe and tapered pipe, the average values are only to be used if specifically recommendation.



Threading

Threading insert with molded chipbreaker

TQ chipbreaker

Increase productivity with improved chip control

Improved tool life with new insert grades

1 Stable chip control

Stable chip control with asymmetric chipbreaker design

Chipbreaker geometry

Stable chip control regardless of cutting direction

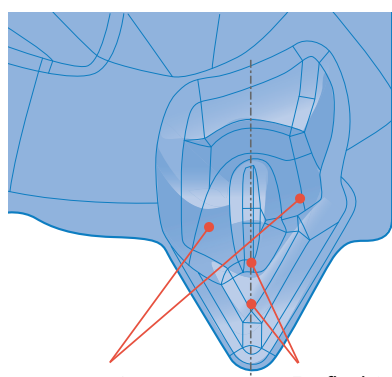

For radial infeed
Asymmetric dot design controls chip-flow direction

For flank infeed /
Modified flank infeed
Breaks chips easily with shallow breaker depth

Chip control performance (Internal evaluation)

Radial infeed

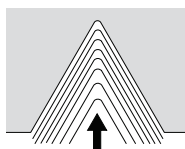

TQ chipbreaker



Competitor A

Modified Flank infeed

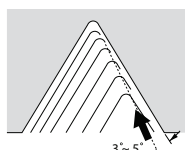

TQ chipbreaker



Competitor A

Cutting conditions: $V_c = 150$ m/min, $a_p = 0.12$ mm (4th pass), $L = 25$ mm, wet, 16ER150 ISO type M45×1.5 workpiece material: 15CrMo4

2 Low cutting force and suppressed vibration

Strong edge and low cutting force

Comparison of cutting force radial infeed (Internal evaluation)

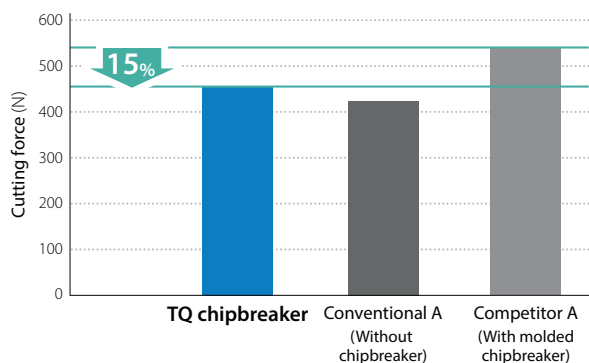

Cutting conditions: $V_c = 150$ m/min, wet, 16ER150 ISO type
Cutting force shows the average of 6 passes, M35×1.5 workpiece material: 15CrMo4

Cutting force comparison modified flank infeed (Internal evaluation)

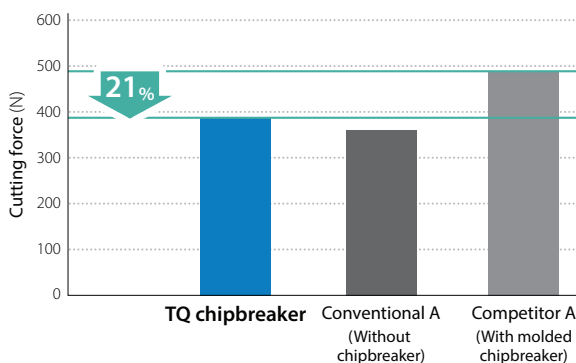

Cutting conditions: $V_c = 150$ m/min, adjusted angle: 5 degrees, wet, 16ER150 ISO type
Cutting force shows the average of 6 passes, M35×1.5 workpiece material: 15CrMo4

3 Improved tool life with new insert grades

For steel machining PR1215
For Stainless steel machining PR1515 (First recommendation) PR1535 (Stability focused)

Wear resistance comparison (Internal evaluation)

Workpiece material : 34CrMo4

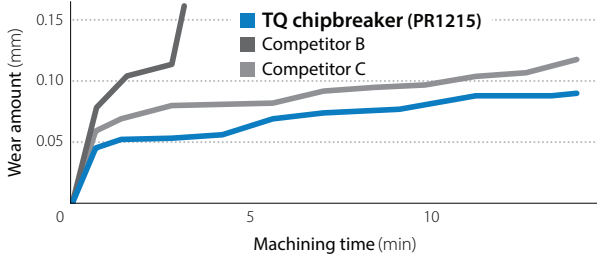

Cutting conditions: Vc = 150 m/min, TP = 1.5 mm, number of passes = 6, wet, 16ER150 ISO type Radial infeed

Workpiece material : X5CrNi1810

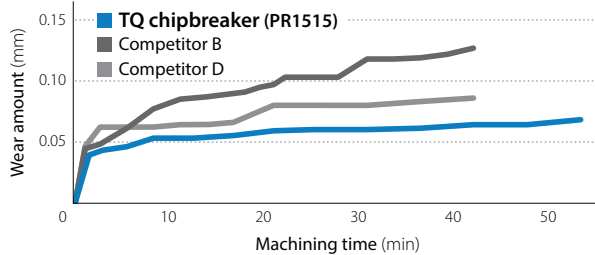

Cutting conditions: Vc = 100 m/min, TP = 1.5 mm, number of passes = 8, wet, 16ER150 ISO type Radial infeed

KTKF

“Threading” is added to small parts machining special tool series

For threading

TKFT



Applicable for various type of threading

Metric (M)	Parallel pipe [G(PF)]
Unified (UN)	Tapered pipe [R(PT) (BSPT)]

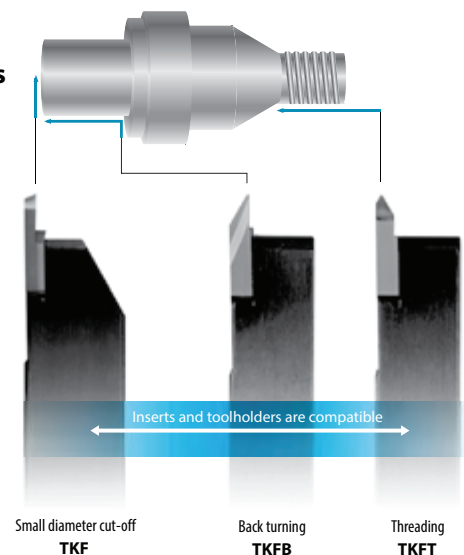

J
Threading

Threading insert features

Full profile and partial profile





	Insert shape	Function	Features
Full profile		Wiper edge	(1) Burr-free thread surface; high quality (Smooth feeling) (2) Leave the workpiece diameter slightly oversized for full topping (3) Every pitch size requires a specific insert
Partial profile			(1) Thread's corner tends to be sharp edged (2) Thread's O.D. or I.D. need to be finished to the size before threading (3) One insert can machine various pitch sizes

Thread precision

Thread types		Thread precision		
		Strict ←		→ loose
Metric	External	4h (1st class)	6g (2nd class)	8g (3rd class)
	Internal	5H (1st class)	6H (2nd class)	7H (3rd class)
Unified	External	3A	2A	1A
	Internal	3B	2B	1B
Applicable precision with		*⊖	✓	✓

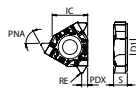
* Not recommended if strict thread precision is required.

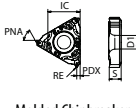
External threading (Metric)

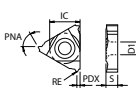
Insert		Description		Material					Dimension (mm)					Carbide					Applicable toolholder ➔ J22~J25
				Thread type	Symbol thread type	Pitch (mm)	Profile type	Thread angle PNA (°)	IC	S	D1	RE	PDX	PVD			GW15	TC60	
														PR1115	PR1215	PR1515			
		Carbon steel / Alloy steel										●					P		
		Stainless steel										●					M		
		Cast iron										●					K		
		Non-ferrous metals										●					N		
 	16ER 100ISO-TF 125ISO-TF 150ISO-TF 175ISO-TF 200ISO-TF 250ISO-TF 300ISO-TF	Metric	M	1	Full profile	60	9.525	3.68	4	0.12	0.8	●	●	●	-	-	-	-	
				1.25						0.15	0.9	●	●	●					
				1.5						0.19	1	●	●	●					
				1.75						0.22	1.6	●	●	●					
  Molded Chipbreaker	16ER 100ISO-TQ 125ISO-TQ 150ISO-TQ 175ISO-TQ 200ISO-TQ 250ISO-TQ 300ISO-TQ	Metric	M	1	Full profile	60	9.525	3.68	4	0.12	0.8	●	●	●	-	-	-	-	
				1.25						0.15	0.9	●	●	●					
				1.5						0.19	1	●	●	●					
				1.75						0.22	1.6	●	●	●					
 	16ER 050ISO 075ISO 100ISO 125ISO 150ISO 175ISO 200ISO 250ISO	Metric	M	0.5	Full profile	60	9.525	3.68	4	0.06	0.4	●	●	●	-	-	-	-	
				0.75						0.09	0.53	●	●	●					
				1						0.12	0.8	●	●	●					
				1.25						0.15	0.9	●	●	●					
				1.5						0.19	1	●	●	●					
				1.75						0.22	1.5	●	●	●					
	16EL 050ISO 075ISO 100ISO 125ISO 150ISO 200ISO	16EL 050ISO 075ISO 100ISO 125ISO 150ISO 200ISO	Metric	M	0.5	Full profile	60	9.525	3.68	4	0.06	0.4	●	●	●	-	-	-	-
					0.75						0.09	0.53	●	●	●				
					1						0.12	0.8	●	●	●				
					1.25						0.15	0.9	●	●	●				
					1.5						0.19	1	●	●	●				
					2						0.25	1.5	●	●	●				
22ER 300ISO 350ISO 400ISO 450ISO 500ISO	22ER 300ISO 350ISO 400ISO 450ISO 500ISO	Metric	M	3	Full profile	60	12.7	4.9	4.85	0.41	2.1	●	●	●	-	-	-	-	
				3.5						0.48	2.1	●	●	●					
				4						0.55	2.8	●	●	●					
				4.5						0.62	2.8	●	●	●					
				5						0.7	2.8	●	●	●					

Right-hand shown

Recommended cutting conditions ➔ J48
Depth of Cut & Number of Passes ➔ J49

Threading

Threading inserts identification system (Full profile)

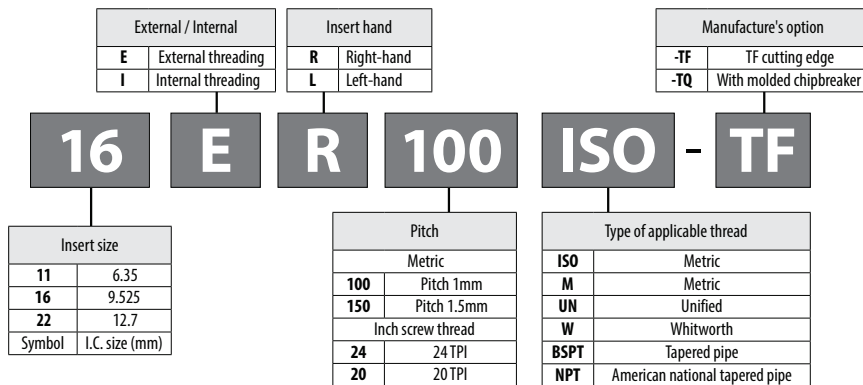

● : Standard item R : Right-hand only L : Left-hand only □ : Check availability

Threading inserts are sold in 5 piece boxes

TC60 (Threading inserts) are sold in 10 piece boxes

Internal threading (Metric)

Insert		Description		Thread type				Dimension (mm)					Carbide					Cermet	Applicable toolholder ➔ J26, J27			
								IC	S	D1	RE	PDX	PVD			GW15	TC60					
													PR1115	PR1215	PR1515							
		Carbon steel / Alloy steel				●										P						
		Stainless steel				●										M						
		Cast iron				●										K						
		Non-ferrous metals				●										N						
		11R	100ISO-TF 125ISO-TF 150ISO-TF 175ISO-TF	Metric	M	1 1.25 1.5 1.75	Full profile	60	6.35	3.18	3	0.07 0.08 0.11 0.12	0.8 1.1 1.1 1.1	●●●●	●●●●	●●●●	●●●●			SINR...-11E SINR...-11		
		16R	100ISO-TF 125ISO-TF 150ISO-TF 175ISO-TF 200ISO-TF 250ISO-TF 300ISO-TF	Metric	M	1 1.25 1.5 1.75 2 2.5 3	Full profile	60	9.525	3.68	4	0.07 0.08 0.11 0.12 0.14 0.17 0.19	0.8 1.1 1.1 1.1 1.5 1.5 1.6	●●●●	●●●●	●●●●	●●●●	●●●●			SINR...-16 CINR...-16	
	 Molded Chipbreaker	11IR	100ISO-TQ 125ISO-TQ 150ISO-TQ 175ISO-TQ	Metric	M	1 1.25 1.5 1.75	Full profile	60	6.35	3.18	3	0.07 0.08 0.11 0.12	0.8 1.1 1.1 1.1	●●●●	●●●●	●●●●	●●●●			SINR...-11E SINR...-11		
	 Molded Chipbreaker	16IR	100ISO-TQ 125ISO-TQ 150ISO-TQ 175ISO-TQ 200ISO-TQ 250ISO-TQ 300ISO-TQ	Metric	M	1 1.25 1.5 1.75 2 2.5 3	Full profile	60	9.525	3.68	4	0.07 0.08 0.11 0.12 0.14 0.17 0.19	0.8 1.1 1.1 1.1 1.5 1.5 1.6	●●●●	●●●●	●●●●	●●●●	●●●●			SINR...-16 CINR...-16	
		11IR	050ISO	Metric	M	0.5 0.75 1 1.25 1.5 1.75 2	Full profile	60	6.35	3.18	3	0.03 0.05 0.07 0.08 0.11 0.12 0.14	0.55 0.68 0.8 1.1 1.1 1.1 0.9	●●●●	●●●●	●●●●	●●●●	●●●●			SINR...-11E SINR...-11	
			11IL									100ISO 150ISO	1 1.5	0.07 0.11	0.8 1.1	●●●●	●●●●	●●●●	●●●●			SINL...-11E SINL...-11
		16IR	100ISO	Metric	M	1 1.25 1.5 1.75 2 2.5 3	Full profile	60	9.525	3.68	4	0.07 0.08 0.11 0.12 0.14 0.16 0.19	0.8 1.1 1.1 1.1 1.5 1.5 1.6	●●●●	●●●●	●●●●	●●●●	●●●●	●●●●			SINR...-16 CINR...-16
			16IL									100ISO 150ISO 200ISO	1 1.5 2	0.07 0.11 0.14	0.8 1.1 1.5	●●●●	●●●●	●●●●	●●●●			SINL...-16 CINL...-16
		22IR	300ISO 350ISO 400ISO 450ISO 500ISO	Metric	M	3 3.5 4 4.5 5	Full profile	60	12.7	4.9	4.85	0.19 0.23 0.26 0.3 0.34	1.8 2.1 2.8 2.8 2.8	●●●●	●●●●	●●●●	●●●●	●●●●	●●●●			SINR...-22 CINR...-22

Right-hand shown





Recommended cutting conditions ➔ J48
Depth of Cut & Number of Passes ➔ J49

● : Standard item R : Right-hand only L : Left-hand only □ : Check availability

Threading inserts are sold in 5 piece boxes

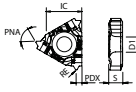
TC60 (Threading inserts) are sold in 10 piece boxes

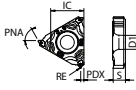
External threading (Unified)

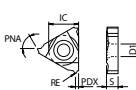
Insert		Description		Material							Dimension (mm)					Carbide			Cermets	Applicable toolholder J22~J25	
				Carbon steel / Alloy steel							IC	S	D1	RE	PDX	PRI115	PRI215	PRI515			PRI535
				Stainless steel																	
				Cast iron																	
Non-ferrous metals																					
Thread type	Symbol thread type	Pitch (TPI)	Profile type	Thread angle PNA (°)	IC	S	D1	RE	PDX	PRI115	PRI215	PRI515	PRI535	TC60							
 	16ER	08UN-TF	Unified	UN UNF	8	Full profile	60	9.525	3.68	4	0.43	1.75	●	●	●	●	●	●			
		10UN-TF			10						0.34	1.5	●	●	●	●					
		12UN-TF			12						0.27	1.5	●	●	●	●					
		13UN-TF			13						0.25	1.5	●	●	●	●					
		14UN-TF			14						0.23	1.5	●	●	●	●					
		16UN-TF			16						0.2	1.1	●	●	●	●					
		18UN-TF			18						0.18	1	●	●	●	●					
20UN-TF	20	0.15	1	●	●	●	●														
24UN-TF	24	0.12	0.8	●	●	●	●														
  <p>Molded Chipbreaker</p>	16ER	08UN-TQ	Unified	UN UNF	8	Full profile	60	9.525	3.68	4	0.43	1.75	●	●	●	●	●	●			
		10UN-TQ			10						0.34	1.5	●	●	●	●					
		12UN-TQ			12						0.27	1.5	●	●	●	●					
		13UN-TQ			13						0.25	1.5	●	●	●	●					
		14UN-TQ			14						0.23	1.5	●	●	●	●					
		16UN-TQ			16						0.2	1.1	●	●	●	●					
		18UN-TQ			18						0.18	1	●	●	●	●					
20UN-TQ	20	0.15	1	●	●	●	●														
24UN-TQ	24	0.12	0.8	●	●	●	●														
 	16ER	12UN	Unified	UN UNF	12	Full profile	60	9.525	3.68	4	0.27	1.5	●	●	●	●	●	●			
		14UN			14						0.23	1.5	●	●	●	●					
		16UN			16						0.2	1.1	●	●	●	●					
		18UN			18						0.18	1	●	●	●	●					
		20UN			20						0.16	1	●	●	●	●					
		24UN			24						0.13	0.8	●	●	●	●					
22ER	08UN	Unified	UN UNF	8	Full profile	60	12.7	4.9	4.85	0.43	2.1	●	●	●	●	●	●	●			

Right-hand shown

Recommended cutting conditions J48
Depth of Cut & Number of Passes J49

J
Threading

● : Standard item R : Right-hand only L : Left-hand only □ : Check availability

Threading inserts are sold in 5 piece boxes

TC60 (Threading inserts) are sold in 10 piece boxes

Internal threading (Unified)

Insert		Description		Thread type		Symbol thread type		Pitch (TPI)		Profile type		Thread angle PNA (°)		Dimension (mm)					Carbide			Cermets	Applicable toolholder J26, J27		
														IC	S	D1	RE	PDX	PVD					TC60	
																			PRI115	PRI215	PRI515				PRI535
		Carbon steel / Alloy steel																		P					
		Stainless steel																		M					
		Cast iron																		K					
		Non-ferrous metals																		N					
		16R	08UN-TF	Unified	UN UNF	Full profile	60	9.525	3.68	4	0.21	1.8	●	●	●	●	●	●	●	●	SINR...-16 CINR...-16				
			10UN-TF										0.17	1.5	●	●	●	●	●						
			12UN-TF										0.14	1.5	●	●	●	●	●						
			13UN-TF										0.13	1.5	●	●	●	●	●						
			14UN-TF										0.12	1.5	●	●	●	●	●						
			16UN-TF										0.1	1.1	●	●	●	●	●						
			18UN-TF										0.09	1	●	●	●	●	●						
			20UN-TF										0.08	1	●	●	●	●	●						
			24UN-TF										0.06	0.8	●	●	●	●	●						
													16R	08UN-TQ	Unified	UN UNF	Full profile	60	9.525	3.68		4	0.21	1.8	●
	10UN-TQ			0.17	1.5	●	●	●	●	●															
	12UN-TQ			0.14	1.5	●	●	●	●	●															
	13UN-TQ			0.13	1.5	●	●	●	●	●															
	14UN-TQ			0.12	1.5	●	●	●	●	●															
	16UN-TQ			0.1	1.1	●	●	●	●	●															
	18UN-TQ			0.09	1	●	●	●	●	●															
	20UN-TQ			0.08	1	●	●	●	●	●															
	24UN-TQ			0.06	0.8	●	●	●	●	●															
				16R	12UN	Unified	UN UNF	Full profile	60	9.525	3.68	4	0.14	1.5							●				●
			14UN	0.12	1.5								●	●	●	●	●								
			16UN	0.1	1.1								●	●	●	●	●								
			18UN	0.09	1								●	●	●	●	●								
			20UN	0.07	1								●	●	●	●	●								
			24UN	0.05	0.8								●	●	●	●	●								
22R	08UN	Unified	UN UNF	8	Full profile	60	12.7	4.9	4.85	0.2	1.8	●	●	●	●	●	●	SINR...-22 CINR...-22							

Right-hand shown

Recommended cutting conditions J48
Depth of Cut & Number of Passes J49



● : Standard item R : Right-hand only L : Left-hand only □ : Check availability

Threading inserts are sold in 5 piece boxes

TC60 (Threading inserts) are sold in 10 piece boxes

External threading (Parallel pipe G(PF), Whitworth W)

Insert		Description		Thread type	Symbol thread type	Pitch (TPI)		Profile type	Thread angle PNA (°)	Dimension (mm)					Carbide				Cermetal	Applicable toolholder J22~J25
						G(PF)	W			IC	S	D1	RE	PDX	PVD					
															PR1115	PR1215	PR1515	PR1535		
		16ER	11W-TF	Parallel pipe Whitworth	G(PF) W	11	11	Full profile	55	9.525	3.68	4	0.3	1.5	●	●	●	●	-	KTNR...-16 KTNR...-16F KTNR...-16JCT KTNSR...-16 S...-KTNL16
			14W-TF			14	14						0.23	1.5	●	●	●	●		
			16W-TF			-	16						0.19	1.1	●	●	●	●		
		16ER	11W-TQ	Parallel pipe Whitworth	G(PF) W	11	11	Full profile	55	9.525	3.68	4	0.3	1.5	●	●	●	●	-	KTNR...-16 KTNR...-16F KTNR...-16JCT KTNSR...-16 S...-KTNL16
			14W-TQ			14	14						0.23	1.5	●	●	●	●		
			16W-TQ			-	16						0.19	1.1	●	●	●	●		
		16ER	11W	Parallel pipe Whitworth	G(PF) W	11	11	Full profile	55	9.525	3.68	4	0.3	1.5	●	●	●	●	-	KTNR...-16 KTNR...-16F KTNR...-16JCT KTNSR...-16 S...-KTNL16
			14W			14	14						0.23	1.5	●	●	●	●		
			19W			19	-						0.16	1	●	●	●	●		

Right-hand shown

Recommended cutting conditions J48
Depth of Cut & Number of Passes J50



Threading

● : Standard item R : Right-hand only L : Left-hand only □ : Check availability

Threading inserts are sold in 5 piece boxes

TC60 (Threading inserts) are sold in 10 piece boxes

Internal threading (Parallel pipe G(PF), Whitworth W)

Insert		Description		Thread type	Symbol thread type	Pitch (TPI)		Profile type	Thread angle PNA (°)	Dimension (mm)					Carbide			Cermet	Applicable toolholder J26, J27	
						G(PF)	W			IC	S	D1	RE	PDX	PVD					
															PR1115	PR1215	PR1515			PR1535
		161R	11W-TF 14W-TF 16W-TF 19W-TF	Parallel pipe Whitworth	G(PF) W	11 14 - 19	11 14 16 -	Full profile	55	9.525	3.68	4	0.3 0.23 0.19 0.16	1.5 1.5 1.1 1	●	●	●	●	●	
		161R	11W-TQ 14W-TQ 16W-TQ 19W-TQ	Parallel pipe Whitworth	G(PF) W	11 14 - 19	11 14 16 -	Full profile	55	9.525	3.68	4	0.3 0.23 0.19 0.16	1.5 1.5 1.1 1	●	●	●	●	●	
		161R	11W 14W	Parallel pipe Whitworth	G(PF) W	11 14	11 14	Full profile	55	9.525	3.68	4	0.3 0.23	1.5	●	●			●	

No wiper effect is expected when threading the internal whitworth screw using 161R○W insert.
Right-hand shown

Recommended cutting conditions J48
Depth of Cut & Number of Passes J50





● : Standard item R : Right-hand only L : Left-hand only □ : Check availability

Threading inserts are sold in 5 piece boxes

TC60 (Threading inserts) are sold in 10 piece boxes

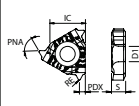

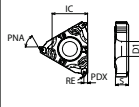
External threading (Tapered pipe R(PT)(BSPT))

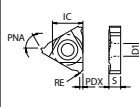
Insert		Description							Carbon steel / Alloy steel					P				
									Stainless steel					M				
									Cast iron					K				
					Non-ferrous metals					N								
Thread type	Symbol thread type	Pitch (TPI)	Profile type	Thread angle PNA (°)	Dimension (mm)					Carbide			Cermets	Applicable toolholder ➔ J22~J25				
					IC	S	D1	RE	PDX	PVD								
										PR1115	PR1215	PR1515			PR1535	GW15	TC60	
		16ER	11BSPT-TF 14BSPT-TF 19BSPT-TF 28BSPT-TF	Tapered pipe	R,(PT) (BSPT)	11	Full profile	55	9.525	3.68	4	0.29	1.6	●	●	●	●	●
						14						0.22	1.6	●	●	●		
						19						0.16	1	●	●	●		
						28						0.1	0.8	●	●	●		
		16ER	11BSPT-TQ 14BSPT-TQ 19BSPT-TQ 28BSPT-TQ	Tapered pipe	R,(PT) (BSPT)	11	Full profile	55	9.525	3.68	4	0.29	1.6	●	●	●	●	●
						14						0.22	1.6	●	●	●		
						19						0.16	1	●	●	●		
						28						0.1	0.8	●	●	●		
		16ER	11BSPT 14BSPT 19BSPT 28BSPT	Tapered pipe	R,(PT) (BSPT)	11	Full profile	55	9.525	3.68	4	0.29	1.6	●	●	●	●	●
						14						0.22	1.6	●	●	●		
						19						0.16	1	●	●	●		
						28						0.1	0.8	●	●	●		

Right-hand shown

Recommended cutting conditions ➔ J48
Depth of Cut & Number of Passes ➔ J50







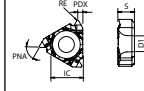

Threading

● : Standard item R : Right-hand only L : Left-hand only □ : Check availability

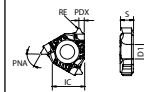
Threading inserts are sold in 5 piece boxes

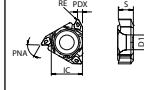
TC60 (Threading inserts) are sold in 10 piece boxes

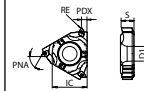
Internal threading (Tapered pipe Rc(PT)(BSPT))

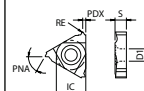
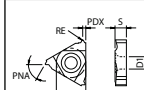
Insert		Description		Material					Dimension (mm)					Carbide				Applicable toolholder ➔ J26, J27		
				Thread type	Symbol thread type	Pitch (TPI)	Profile type	Thread angle PNA (°)	IC	S	D1	RE	PDX	PVD			Cermet			
														PR1115	PR1215	PR1515			PR1535	GW15
		Carbon steel / Alloy steel										●				P				
		Stainless steel										●				M				
		Cast iron										●				K				
		Non-ferrous metals										●				N				
		111R	14BSPT-TF 19BSPT-TF 28BSPT-TF	Tapered pipe	Rc(PT) (BSPT)	14 19 28	Full profile	55	6.35	3.18	3	0.22 0.16 0.1	0.97 0.78 0.6	●	●	●	●	●	●	SINR...-11E SINR...-11
		161R	11BSPT-TF 14BSPT-TF	Tapered pipe	Rc(PT) (BSPT)	11 14	Full profile	55	9.525	3.68	4	0.29 0.22	1.5 0.97	●	●	●	●	●	●	SINR...-16 CINR...-16
	 Molded Chipbreaker	111R	14BSPT-TQ 19BSPT-TQ 28BSPT-TQ	Tapered pipe	Rc(PT) (BSPT)	14 19 28	Full profile	55	6.35	3.18	3	0.22 0.16 0.1	0.97 0.78 0.6	●	●	●	●	●	●	SINR...-11E SINR...-11
	 Molded Chipbreaker	161R	11BSPT-TQ 14BSPT-TQ	Tapered pipe	Rc(PT) (BSPT)	11 14	Full profile	55	9.525	3.68	4	0.29 0.22	1.5 0.97	●	●	●	●	●	●	SINR...-16 CINR...-16
		111R	14BSPT 19BSPT 28BSPT	Tapered pipe	Rc(PT) (BSPT)	14 19 28	Full profile	55	6.35	3.18	3	0.22 0.16 0.1	0.97 0.78 0.6	●	●	●	●	●	●	SINR...-11E SINR...-11
		161R	11BSPT 14BSPT	Tapered pipe	Rc(PT) (BSPT)	11 14	Full profile	55	9.525	3.68	4	0.29 0.22	1.5 0.97	●	●	●	●	●	●	SINR...-16 CINR...-16

Right-hand shown

Recommended cutting conditions ➔ J48
Depth of Cut & Number of Passes ➔ J50

● : Standard item R : Right-hand only L : Left-hand only □ : Check availability

Threading inserts are sold in 5 piece boxes

TC60 (Threading inserts) are sold in 10 piece boxes

External threading (American national tapered pipe NPT)

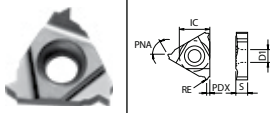
Insert		Description		Thread type				Dimension (mm)					Carbi- de			Cerm et	Applicable toolholder ● J22~J25
								IC	S	D1	RE	PDX	PRI115	GW15	TC60		
								Carbon steel / Alloy steel					●			P	
								Stainless steel					●			M	
								Cast iron					●			K	
								Non-ferrous metals					●			N	
		16ER 11.5NPT 14NPT 18NPT		American national tapered pipe NPT 11.5 14 18 Full profile 60				IC	S	D1	RE	PDX	PRI115	GW15	TC60	KTNR...-16 KTNR...-16F KTNR...-16JCT KTNSR...-16 S...-KTNL16	
								9.525	3.68	4	0.06 0.05 0.04	1.5 1.5 0.9	● ● ●	● ● ●	● ● ●		

Right-hand shown

Recommended cutting conditions ● J48
 Depth of Cut & Number of Passes ● J50



Threading

● : Standard item R : Right-hand only L : Left-hand only □ : Check availability

Threading inserts are
sold in 5 piece boxes

TC60 (Threading inserts) are
sold in 10 piece boxes

Internal threading (American national tapered pipe NPT)

Insert		Description		Thread type				Dimension (mm)					Carbide			Cermets	Applicable toolholder ➔ J26, J27																																						
								IC	S	D1	RE	PDX	PVD	GW15	TC60																																								
				Carbon steel / Alloy steel									●				P																																						
				Stainless steel									●				M																																						
				Cast iron									●				K																																						
				Non-ferrous metals									●				N																																						
161R		11.5NPT 14NPT 18NPT		American national tapered pipe NPT				11.5 14 18				Full profile				60				9.525					3.68					4					0.06 0.05 0.04					1.5 1.5 0.9					● ● ●			● ● ●			● ● ●			SINR...-16 CINR...-16	

Right-hand shown

Recommended cutting conditions ➔ J48
Depth of Cut & Number of Passes ➔ J50

● : Standard item R : Right-hand only L : Left-hand only □ : Check availability

Threading inserts are sold in 5 piece boxes

TC60 (Threading inserts) are sold in 10 piece boxes



Threading

External threading (60° Partial profile / Metric, Unified)

Insert		Description		Thread type		Symbol thread type		Pitch				Profile type		Thread angle PNA (°)		Dimension (mm)					Carbide		Applicable toolholder J22~J25			
								Metric (mm)		Unified (TPI)						IC	S	D1	RE	PDX	PVD			GW15	TC60	
								min.	max.	min.	max.										PR1115	PR1215				PR1515
		Carbon steel / Alloy steel																	P							
		Stainless steel																	M							
		Cast iron																	K							
		Non-ferrous metals																	N							
		16ER	A60-TF AG60-TF G60-TF	Metric Unified	M UN/UNF	0.5 0.5 1.75	1.5 3 3	48 48 14	16 8 8	Partial profile	60	9.525	3.68	4	0.06 0.06 0.22	1 1.6 1.6	●	●	●	●			KTNR...-16 KTNR...-16F KTNR...-16JCT KTNSR...-16 S...-KTNL16			
		16ER	A60-TQ AG60-TQ G60-TQ	Metric Unified	M UN/UNF	0.5 0.5 1.75	1.5 3 3	48 48 14	16 8 8	Partial profile	60	9.525	3.68	4	0.06 0.06 0.22	1 1.6 1.6	●	●	●	●						
		16ER	6001 6002 A60 AG60 G60	Metric Unified	M UN/UNF	1 1.5 0.5 1.75	2.5 2.5 3 3	24 16 48 48 14	11 11 8 8 8	Partial profile	60	9.525	3.68	4	0.1 0.2 0.06 0.06 0.22	1.5 1.5 1 1.7 1.7										
		22ER	N60	Metric Unified	M UN/UNF	3.5	5	7	5	Partial profile	60	12.7	4.9	4.85	0.48	2.5	●						KTNR...-22			

Right-hand shown

Recommended cutting conditions J48
Depth of Cut & Number of Passes J50, J51, J54

Threading inserts identification system (Partial profile)

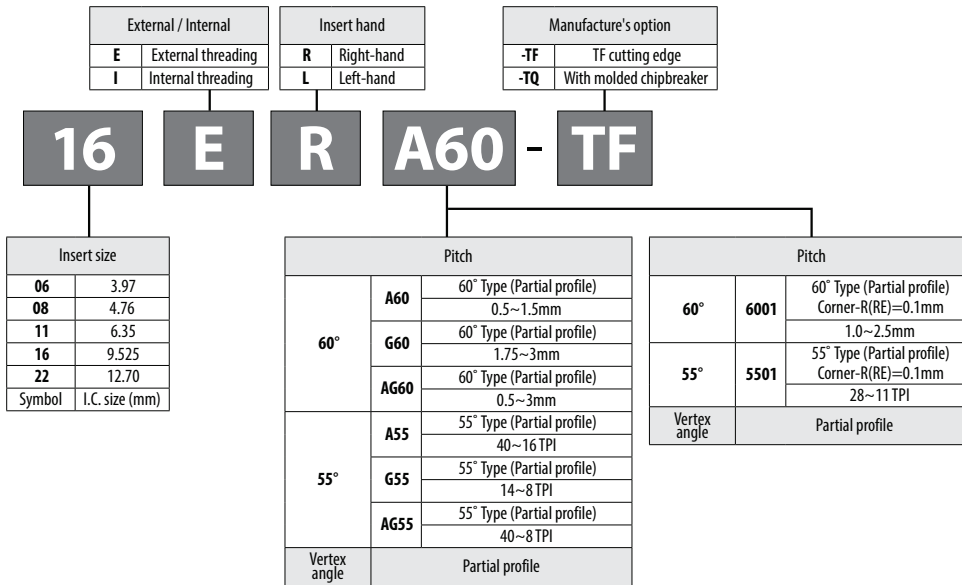

Note) Pitch and threads per inch of an insert without wiper depend on the size of insert.

Example of shape of A, G and AG

Description	Dimension(mm)		
	RE	PDX	HC
16ER A60-TF	0.06	1.00	1.5
16ER G60-TF	0.22	1.60	2.6
16ER AG60-TF	0.06	1.60	2.7

● : Standard item R : Right-hand only L : Left-hand only □ : Check availability

Threading inserts are sold in 5 piece boxes

TC60 (Threading inserts) are sold in 10 piece boxes

Internal threading (60° Partial profile / Metric, Unified)

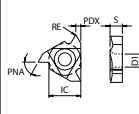
Insert		Description		Thread type	Symbol thread type	Pitch				Profile type	Thread angle PNA (°)	Dimension (mm)					Carbide	Cermets	Applicable toolholder ➔ J26, J27
						Metric (mm)		Unified (TPI)				IC	S	D1	RE	PDX			
						min.	max.	min.	max.										
						min.	max.	min.	max.										
		06IR	60005	Metric	M	0.75	1.25	28	20	Partial profile	60	3.97	1.91	2.3	0.05	0.6	●		SINR...-06E
		08IR	60007			1	1.75	20	16			4.76	2.38	2.3	0.07	0.8	●		SINR...-08E
		11IR	60005 A60			0.75 0.5	1.5 1.5	32 48	16 16			6.35	3.18	3	0.05 0.02	1	●	●	SINR...-11E SINR...-11
		16IR	6001 60015 A60 AG60 G60			1.5	2.5	16	10			9.525	3.68	4	0.1	1.5	●	●	SINR...-16 CINR...-16
						2.5	2.5	11	10						0.15	1.5	●	●	
						0.5	1.5	48	16						0.02	1	●	●	
						0.5	3	48	8						0.02	1.7	●	●	
		1.75	3			14	8	0.11	1.7			●	●						
		22IR	N60			3.5	5	7	5			12.7	4.9	4.85	0.22	2.5	●	●	SINR...-22 CINR...-22

Right-hand shown

Recommended cutting conditions ➔ J48
Depth of Cut & Number of Passes ➔ J51, J52, J54

Corner-R(RE) selection for partial profiling insert

	External threading	Internal threading	Metric, Unified thread
Metric unified	RE ≤ 0.1443TP	RE ≤ 0.0720TP	Corner-R(RE) at Internal threading is almost half of that of External
Parallel pipe (Whitworth) Tapered pipe	(For both external and Internal thread) RE ≤ 0.1373TP		Parallel pipe, Tapered pipe, Whitworth thread Same Corner-R(RE) for both External and Internal threading

RE: Corner-R TP: Pitch ($= \frac{25.4}{n}$) n: TPI

● : Standard item R : Right-hand only L : Left-hand only □ : Check availability





Threading inserts are sold in 5 piece boxes

TC60 (Threading inserts) are sold in 10 piece boxes

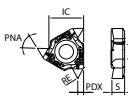

Threading

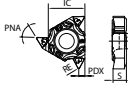
External threading (55° Partial profile / G, R, W)

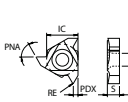
Insert		Description		Thread type	Symbol thread type	Pitch				Profile type	Thread angle PNA (°)	Dimension (mm)					Carbide					Applicable toolholder J22~J25		
						G(PF), R(PT) (TPI)		W (TPI)				IC	S	D1	RE	PDX	PVD						Cermat	
						min.	max.	min.	max.								PR1115	PR1215	PR1515	PR1535	GW15			TC60
																	•	•	•	•	•			•
		16ER	A55-TF	Parallel / Tapered pipe Whitworth	G(PF) R(PT) W	28	19	40	16	Partial profile	55	9.525	3.68	4	0.06	1	•	•	•	•	-	-	-	
			AG55-TF			28	11	40	8						0.06	1.6	•	•	•	•				
			G55-TF			14	11	14	8						0.22	1.6	•	•	•	•				
		16ER	A55-TQ	Parallel / Tapered pipe Whitworth	G(PF) R(PT) W	28	19	40	16	Partial profile	55	9.525	3.68	4	0.06	1	•	•	•	•	-	-	-	
			AG55-TQ			28	11	40	8						0.06	1.6	•	•	•	•				
			G55-TQ			14	11	14	8						0.22	1.6	•	•	•	•				
		16ER	5501	Parallel / Tapered pipe Whitworth	G(PF) R(PT) W	28	11	24	10	Partial profile	55	9.525	3.68	4	0.1	1.5					•	•	•	
			5502			14	11	16	9						0.2	1.5								
		22ER	A55	Parallel / Tapered pipe Whitworth	G(PF) R(PT) W	28	19	40	16	Partial profile	55	12.7	4.9	4.85	0.06	1					•	•	•	
			AG55			28	11	40	8						0.06	1.65								
			G55			14	11	14	8					0.22	1.7									
			N55			-	-	7	5							•							KTNR...-22	

Right-hand shown

Recommended cutting conditions J48
Depth of Cut & Number of Passes J52~J54

Threading

• : Standard item R : Right-hand only L : Left-hand only □ : Check availability

Threading inserts are sold in 5 piece boxes

TC60 (Threading inserts) are sold in 10 piece boxes

Internal threading (55° Partial profile / G, Rc, W)

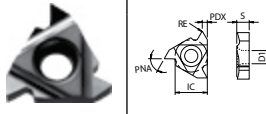
Insert		Description		Thread type		Symbol thread type		Pitch		Profile type		Thread angle PNA (°)		Dimension (mm)						Carbide		Applicable toolholder J26, J27							
														G(PF), Rc(PT) (TPI)		W (TPI)		IC	S	D1	RE		PDX	PVD	Cerm				
														min.	max.	min.	max.									PR115	GW15	TC60	
		06IR	5501	Parallel / Tapered pipe Whitworth	G(PF) R(PT) W	28		24		Partial profile	55	3.97	1.91	2.3	0.1	0.6	●				SINR..-06E								
		08IR	5501			28	19	24	20								55	4.76	2.38	2.3	0.1	0.8	●				SINR..-08E		
		11IR	55005 A55			28	14	24	14								55	6.35	3.18	3	0.05	1.1	●	●				SINR..-11E SINR..-11	
		16IR	5501 5502 A55 AG55 G55			28	11	24	11								55	9.525	3.68	4	0.1	1.5	●	●					SINR..-16 CINR..-16
						14	11	16	11												0.2	1.5	●	●					
						28	19	40	16												0.06	1	●	●					
22IR	N55	28	11	40	8	55	12.7	4.9	4.85	0.47	2.5	●	●					SINR..-22 CINR..-22											
		14	11	14	8							0.06	1.7	●	●														

Right-hand shown

Recommended cutting conditions J48
Depth of Cut & Number of Passes J52~J54



● : Standard item R : Right-hand only L : Left-hand only □ : Check availability

Threading inserts are sold in 5 piece boxes

TC60 (Threading inserts) are sold in 10 piece boxes

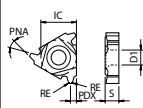

External threading (30° Trapezoidal Tr)

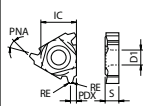
Insert		Description		Material					Dimension (mm)					Coating		Applicable toolholder J22~J25
				Carbon steel / Alloy steel	Stainless steel	Cast iron	Non-ferrous metals	IC	S	D1	RE	PDX	PVD	Cermet		
Thread type	Symbol thread type	Pitch (mm)	Profile type	Thread angle PNA (°)						PRT115	TC60					
		16ER	200TR 300TR	30° type (Trapezoidal)	Tr	2 3	Partial profile	30	9.525	3.68	4	0.2	1.6	●	●	KTNR...-16 KTNR...-16F KTNR...-16JCT KTNSR...-16 S...-KTNL16
		22ER	400TR 500TR	30° type (Trapezoidal)	Tr	4 5	Partial profile	30	12.7	4.9	4.85	0.2	2.5	●	●	

Right-hand shown

Recommended cutting conditions J48
Depth of Cut & Number of Passes J53

J





Threading

● : Standard item R : Right-hand only L : Left-hand only □ : Check availability

Threading inserts are sold in 5 piece boxes

TC60 (Threading inserts) are sold in 10 piece boxes

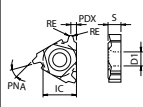
Internal threading (30° Trapezoidal Tr)

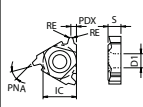
Insert		Description		Material					Dimension (mm)					PVD	Carbide	Applicable toolholder ➡ J26, J27
				Carbon steel / Alloy steel	Stainless steel	Cast iron	Non-ferrous metals	IC	S	D1	RE	PDX				
Thread type	Symbol thread type	Pitch (mm)	Profile type	Thread angle PNA (°)	IC	S	D1	RE	PDX	PRT115	PR115	PR115	PR115	PR115	PR115	
		16IR 200TR 300TR	30° type (Trapezoidal)	Tr	2 3	Partial profile	30	9.525	3.68	4	0.2	1.6	●	●	SINR..-16 CINR..-16	
		22IR 400TR 500TR	30° type (Trapezoidal)	Tr	4 5	Partial profile	30	12.7	4.9	4.85	0.2	2.5	●	●	SINR..-22 CINR..-22	

Right-hand shown

Recommended cutting conditions ➡ J48
Depth of Cut & Number of Passes ➡ J53

● : Standard item R : Right-hand only L : Left-hand only □ : Check availability

Threading inserts are sold in 5 piece boxes

TC60 (Threading inserts) are sold in 10 piece boxes



KTN (External threading)

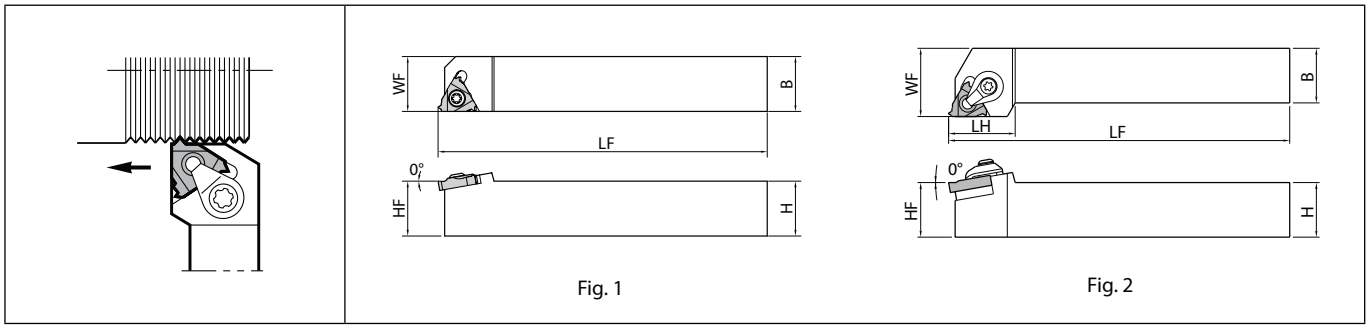

Right-hand shown | Right-hand Insert for Right-hand Toolholder, Left-hand Insert for Left-hand Toolholder.

Toolholder dimensions

Description	Availability		Dimension (mm)							Fig.	Applicable inserts J6, J8, J10 J12, J14, J16 J18, J20
	R	L	H	B	LH	HF	LF	WF			
KTN ^{R/L} 1216JX-16F 1616H-16 1616JX-16F 2020H-16 2020JX-16F 2020K-16 2525M-16	●	●	12	-	-	12	120	16	1	16E ^{R/L} ...	
	●	●	16	16	25	16	100	20	2		
	●	●			-		120	16	1		
	●	●			25		100	25	2		
	●	●	20	20	-	20	120	20	1		
	●	●			25		125	25	2		
	●	●	25	25	25	25	150	30	2		
KTN ^R 2525M-22 3225P-22	●		25	25	29	25	150	32	2	22ER...	
	●		32	34	32	32	170	32	2		

Description	Spare parts							
	Clamp set	Clamp set	Screw	Shim screw	Shim	Wrench	Wrench	Wrench
KTN ^{R/L} 1216JX-16F 1616H-16 1616JX-16F 2020H-16 2020JX-16F 2020K-16 2525M-16	-		SB-3.5TR	-	-		-	LTW-15S
	CPS-5S		-	SP3X8	TN-32		FT-15	-
	-		SB-3.5TR	-	-		-	LTW-15S
	CPS-5S	-	-	SP3X8	TN-32	-	FT-15	-
	-		SB-3.5TR	-	-		-	LTW-15S
	CPS-5S		-	SP3X8	TN-32		FT-15	-
KTN 2525M-22 3225P-22	-	CPS-6S	-	SP3X8	TN-43	LW-3	-	-

● : Standard item R : Right-hand only L : Left-hand only □ : Check availability

KTN-JCT (External threading, Coolant-through holders)

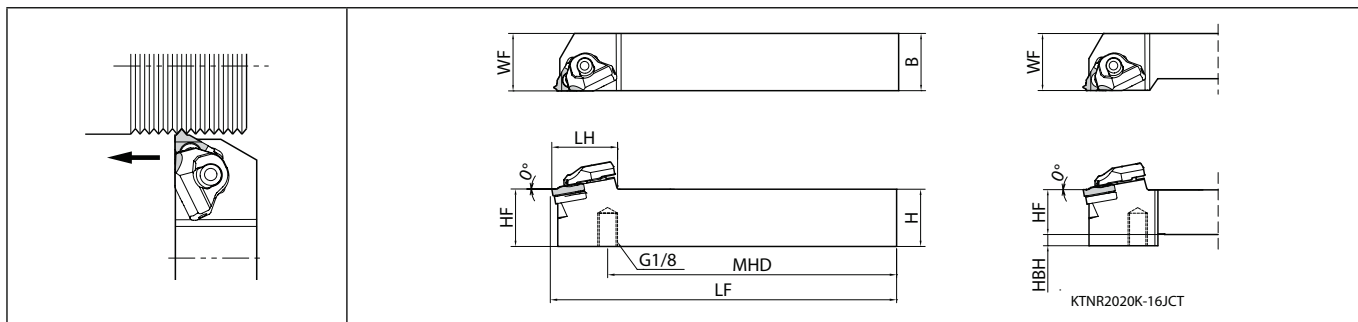

Right-hand shown | Right-hand Insert for Right-hand Toolholder. | Pressure Resistance : ~15MPa

Toolholder dimensions

Description	Availability	Dimension (mm)										Coolant hole	Spare parts					Applicable inserts ● J6, J8, J10 J12, J14, J16 J18, J20
		R	H	B	LH	MHD	HF	HBH	LF	WF	Clamp set		Pipe connection	Shim screw	Shim	Wrench		
KTR 2020K-16JCT	●	20	20	33.3	100.7	20	5	125	25	Yes		FP-12	SP3X8	TN-32	FT-15	16ER...		
2525M-16JCT	●	25	25	-	125.7	25	-	150										

Please see page D12 for piping parts of coolant-through holders.

Only the O-ring (SS-035) included with the pipe connection can be ordered.



Threading

KTNS (External threading)

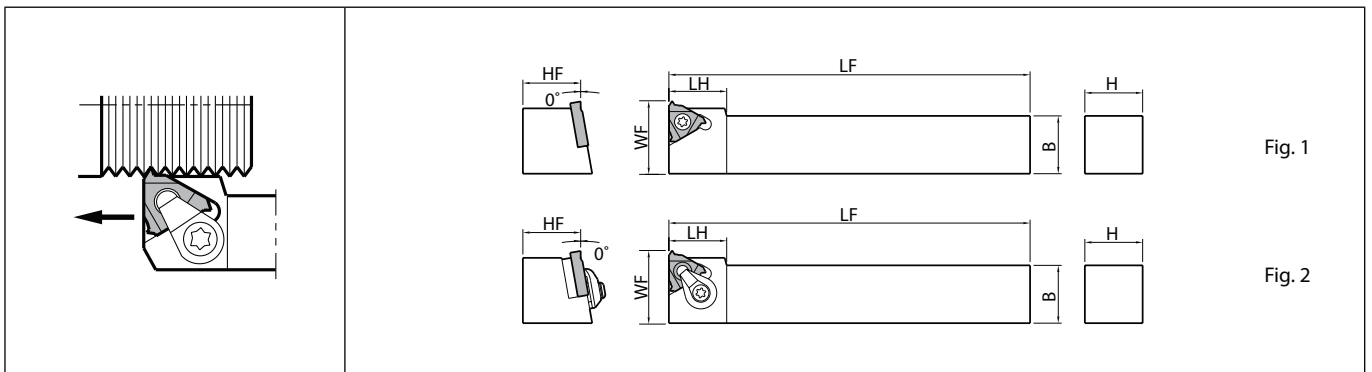

Right-hand shown | Right-hand Insert for Right-hand Toolholder.

Toolholder dimensions

Description	Availability	Dimension (mm)						Fig.	Spare parts					Applicable inserts ● J6, J8, J10 ● J12, J14, J16 ● J18, J20
									Clamp set	Screw	Shim screw	Shim	Wrench	
		R	H	B	LH	HF	LF		WF					
KTNSR 1010H-16	●	10	10	16	10	100	16	1	-	SB-3.5TR	-	-	-	16ER...
1212K-16	●	12	12	18	12	125	18	2	CPS-5S	-	SP3X8	TN-32	FT-15	
1616K-16	●	16	16	20	16	22	22							
2020K-16	●	20	20	20	20	27.4	27.4							



Threading

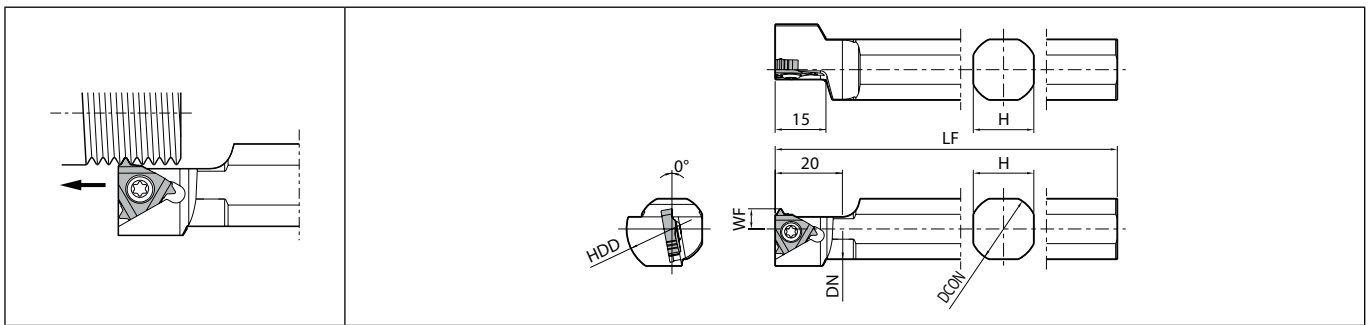

● : Standard item R : Right-hand only L : Left-hand only □ : Check availability

S-KTN (External threading)



Left-hand shown | Right-hand Insert for Left-hand Toolholder.

Toolholder dimensions

Description	Availability	Dimension (mm)						Spare parts		Applicable inserts ● J6, J8, J10 J12, J14, J16 J18, J20	
		L	DCON	H	DN	HDD	LF	WF	Screw		Wrench
											
S16F- KTNL16	●	16	15	15	27	85	6	SB-3.5TR	LTW-15S	16ER...	
S19K- KTNL16	●	19.05	17	18		120					
S20K- KTNL16	●	20	18	19		120					
S22K- KTNL16	●	22	20	21	100	10	SB-3.5TR	LTW-15S			
S25.0H- KTNL16	●	25	23	24					120		
S25K- KTNL16	●	25.4							120		



Threading

● : Standard item R : Right-hand only L : Left-hand only □ : Check availability

SIN

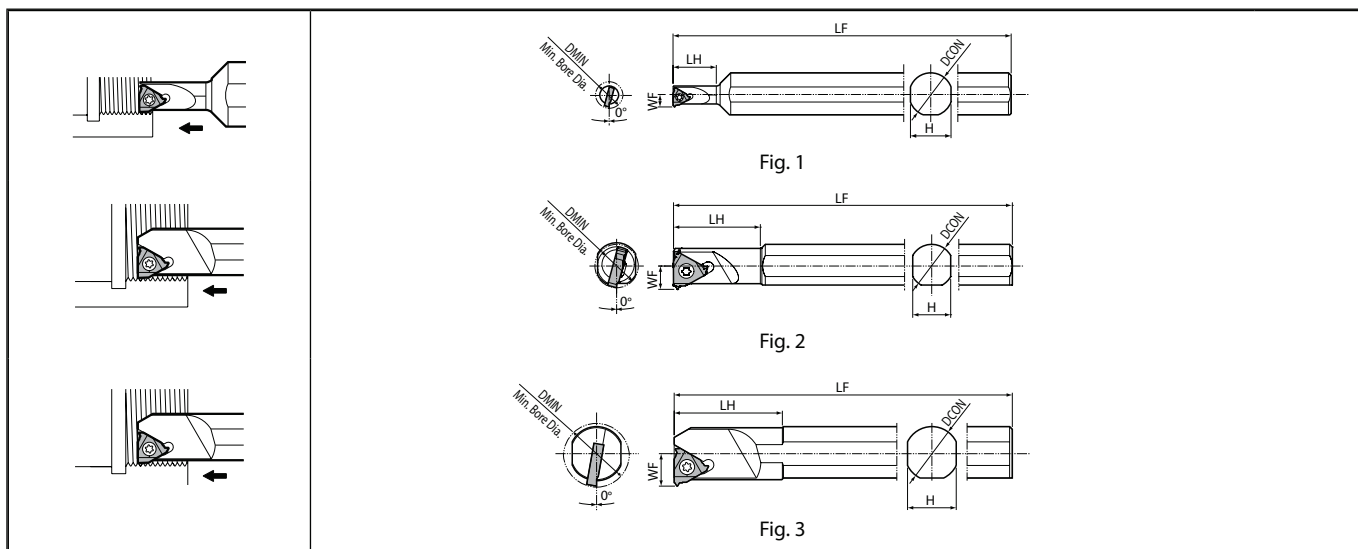

Right-hand shown | Right-hand Insert for Right-hand Toolholder, Left-hand Insert for Left-hand Toolholder.

Toolholder dimensions

Description	Availability		Dimension (mm)							Fig.	Spare parts			Applicable inserts ● J7, J9, J11 ● J13, J15, J17 ● J19, J21
											Screw	Wrench	Wrench	
	R	L	DMIN	DCON	H	LH	LF	WF						
SINR 0612S-06E	●		6.4	12	11	10	100	3.8	1	SB-2040TR	-	FT-6	061R...	
SINR 0816S-08E	●		7.8	16	15	16	125	4	1	SB-2050TR	-	FT-6	081R...	
SIN ^{R/L} 1216S-11E	●	●	12	16	14	25	150	6.3	1	SB-2TR	-	FT-8	111 ^{R/L} ...	
SIN ^{R/L} 1516S-11	●	●	15			30		7.5						
SIN ^{R/L} 1616S-16	●	●	16	16	14	32	150	8.6	2	SB-3.5TR	FT-15	-	161 ^{R/L} ...	
SIN ^{R/L} 2016S-16	●	●	20			37		10						
SIN ^{R/L} 2420S-16	●	●	24			20		18	40					180
SINR 2420S-22	●		24	20	18	40	180	13.5	3	SB-4085TR	FT-15	-	221R...	

● : Standard item R : Right-hand only L : Left-hand only □ : Check availability

CIN

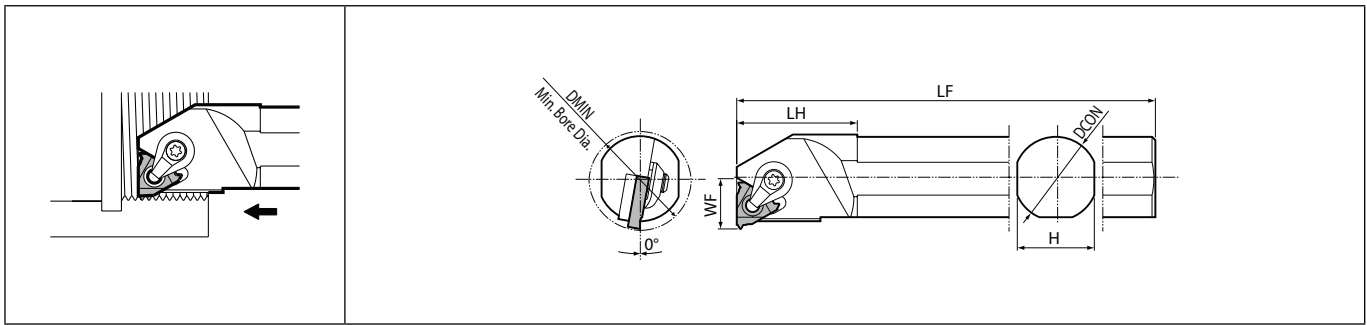

Right-hand shown | Right-hand Insert for Right-hand Toolholder, Left-hand Insert for Left-hand Toolholder.

Toolholder dimensions

Description	Availability		Dimension (mm)						Spare parts						Applicable inserts J7, J9, J11 J13, J15, J17 J19, J21
									Clamp set	Clamp set	Shim screw	Shim	Wrench	Wrench	
	R	L	DMIN	DCON	H	LH	LF	WF							
CIN ^{R/L} 3025S-16	●	●	30	25	23	36	200	15		-	SP3X8	TN-32	-	FT-15	16I ^{R/L} ...
3732S-16	●		37	32	30	45	250	18.5							
CIN ^R 3025S-22	●		30	25	23	40	200	16.5	-	CPS-6S	SP3X8	TN-43	LW-3	-	22I ^R ...
3732S-22	●		37	32	30	45	250	20							



Threading

Guide for internal threading

For internal threading, pay extra attention to “stabilizing bore dia.” and “chip evacuation”.

1. “Stabilizing bore dia.”

Because small pitch Internal threading has small corner-R (RE), there is variation in the bore dia. which may greatly influence the tool life of an insert. In order to eliminate the variation in the bore dia., “0” Cutting (zero cutting) should be performed as the zero pass, before the first pass in threading. The bore dia. is cut with the specified dimension, and the first pass of threading becomes stable.

2. “Chip evacuation”

If machining process is continued when chips are tangled with a toolholder and other parts of the machine, it may cause damages to the insert. Therefore, please ensure that there are no tangled chips in the machine by the following method.

<When processing the first workpiece>

Set the program with the “single block”

Keep the threading starting point 50 mm~100 mm away from the side of workpiece, and confirm that coolant is flushing down the chips for each pass.

<When processing the second workpiece and later>

Ensure that chips are not tangled; then, start the continuous run.

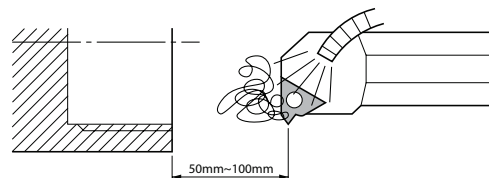

● : Standard item R : Right-hand only L : Left-hand only □ : Check availability

TKFT

		Carbon steel / Alloy steel										●	●	●	●	P		
		Stainless steel										○	○	○	○	M		
		Cast iron										■	■	■	■	K		
		Non-ferrous metals										■	■	■	■	N		
Insert	Description	Thread type	Symbol thread type	Dimension (mm)								Carbide				Applicable toolholder ➡ J29~J31		
				CW	S	D1	RE	W1	PDX	PDX1	PVD							
											PR1225	PR1535	PR1725	KW10				
 Right-hand shown Left-hand shown	TKFT12 RA6000 TKFT12 RB6000	Metric Unified	M UN	2.5	8.7	5.2	Max. 0.05 Flat	3	0.4	2.1	2.1	●	●	●	●	KTKFR...12(-Y)		
	TKFT12 RA60005 TKFT12 RB60005			2.5	8.7	5.2	0.05	3	0.8	1.7	1.7	0.8	●	●	●		●	
	TKFT12 RN6001			2.5	8.7	5.2	0.1	3	1.25	1.25	●	●	●	●	●			
	TKFT12 RA55005 TKFT12 RB55005	Parallel/Tapered pipe Whitworth	G, R, W	2.5	8.7	5.2	0.05	3	0.8	1.7	1.7	0.8	●	●	●		●	
	TKFT12 LA6000 TKFT12 LB6000			Metric Unified	M UN	2.5	8.7	5.2	Max. 0.05 Flat	3	2.1	0.4	2.1	●	●		●	●
	TKFT12 LA60005 TKFT12 LB60005					2.5	8.7	5.2	0.05	3	1.7	0.8	0.8	1.7	●		●	●
	TKFT12 LN6001	2.5	8.7			5.2	0.1	3	1.25	1.25	●	●	●	●	●			
	TKFT12 LA55005 TKFT12 LB55005	Parallel/Tapered pipe Whitworth	G, R, W	2.5	8.7	5.2	0.05	3	1.7	0.8	1.7	0.8	●	●	●		●	
	TKFT12 LA55005 TKFT12 LB55005			2.5	8.7	5.2	0.05	3	0.8	1.7	0.8	1.7	●	●	●		●	

Photo shows Right-hand

Recommended cutting conditions ➡ J33
Depth of Cut & Number of Passes ➡ J33

Threading

Description	Thread type	Symbol thread type	Pitch				Profile type	Thread angle PNA (°)
			M (mm)		UN, G, R, W (TPI)			
			min.	max.	min.	max.		
TKFT12 RA6000 TKFT12 RB6000	Metric Unified	M UN	0.2	0.6	64	48	Partial profile	60
TKFT12 RA60005 TKFT12 RB60005			0.5	1.25	48	24		60
TKFT12 RN6001			1	1.5	24	18		60
TKFT12 RA55005 TKFT12 RB55005	Parallel/Tapered pipe Whitworth	G, R, W	-	-	40	16	Partial profile	55
TKFT12 LA6000 TKFT12 LB6000			Metric Unified	M UN	0.2	0.6		64
TKFT12 LA60005 TKFT12 LB60005	0.5	1.25			48	24	60	
TKFT12 LN6001	1	1.5			24	18	60	
TKFT12 LA55005 TKFT12 LB55005	Parallel/Tapered pipe Whitworth	G, R, W	-	-	40	16	Partial profile	55
TKFT12 LA55005 TKFT12 LB55005			-	-	40	16		55

● : Standard item R : Right-hand only L : Left-hand only □ : Check availability

KTKF (Threading)

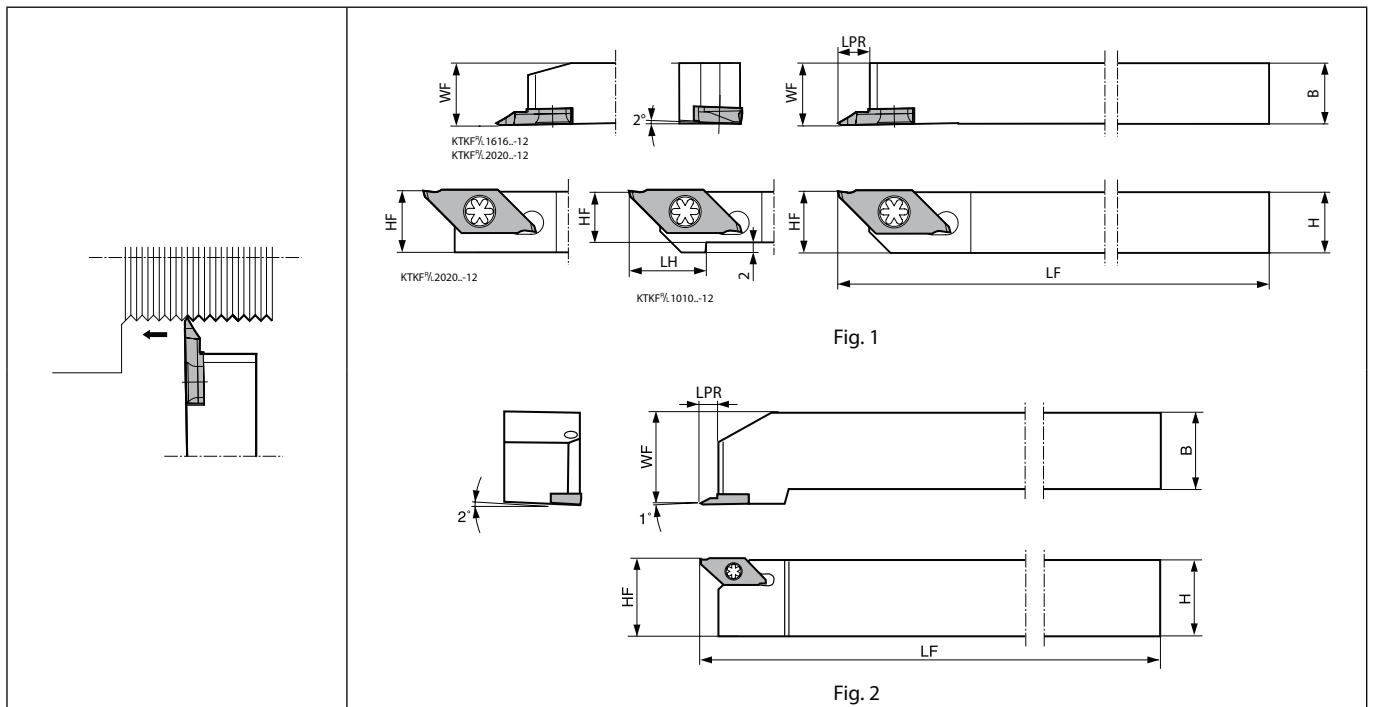

Right-hand shown | Right-hand Insert for Right-hand Toolholder, Left-hand Insert for Left-hand Toolholder.

Toolholder dimensions

Description	Availability		Dimension (mm)							Spare parts		Applicable inserts ➔ J28	
										Screw	Wrench		
	R	L	H	B	LH	LPR	HF	LF	WF	Fig.			
KTKF%L 1010JX-12	●	●	10	10	15	6	10	120	10	1	SB-4590TRWN	FT-10	TKFT12%L...
1212F-12	●	●	12	12	12		85	12					
1212JX-12	●	●	16	16	16		120	16					
1616JX-12	●	●	20	20	20		20	20					
2020JX-12	●	●	25	25	25		150	30	2				
2525M-12	●												TKFT12R...

LPR shows the distance from the toolholder to the cutting edge.
See Page H15 for internal coolant type (coolant-through holders)

Threading inserts identification system (Ref. to Table 1)

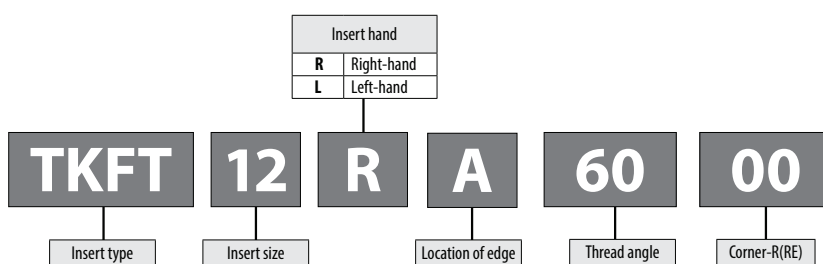
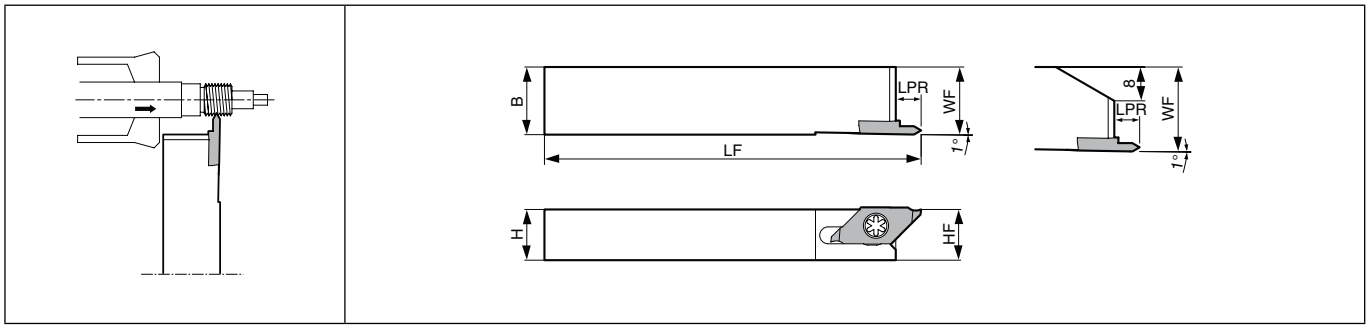

Table 1

Right-hand insert		
A type TKFT12RA..	B type TKFT12RB..	N type TKFT12RN..
Left-hand insert		
A type TKFT12LA..	B type TKFT12LB..	N type TKFT12LN..

● : Standard item R : Right-hand only L : Left-hand only □ : Check availability

KTKF (Threading, Goose-neck holder)



Left-hand shown | Left-hand Insert for Left-hand Toolholder.

Toolholder dimensions

Description	Availability	Dimension (mm)						Spare parts		Applicable inserts J28
								Screw	Wrench	
		L	H	B	LPR	HF	LF	WF		
KTKFL 1216JX-12	●	12	16		12		16	SB-4590TRWN	FT-10	TKFT12L...
1620JX-12	●	16	20	6	16	120	20			

LPR shows the distance from the toolholder to the cutting edge.



Threading

Swiss tool automatic lathe (Guide bush system)

Goose-neck holder is applicable to automatic lathes whose toolholder does not move to longitudinal direction (Z-axis direction).

Conventional tool

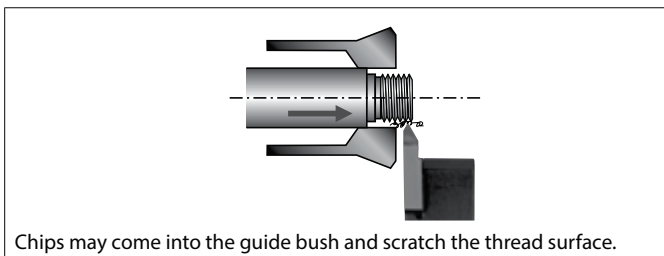

Goose-neck holder

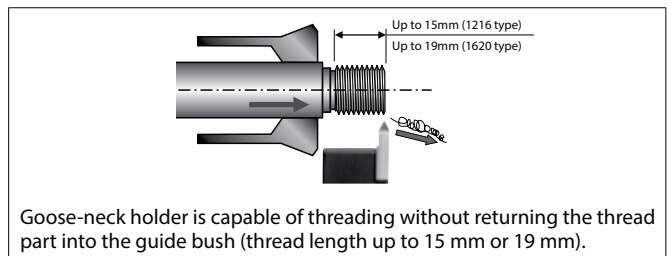

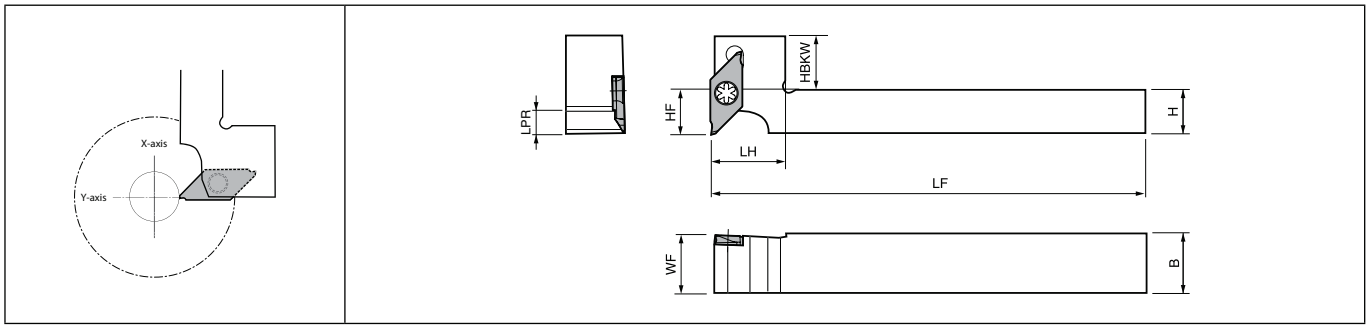

● : Standard item R : Right-hand only L : Left-hand only □ : Check availability

KTKF-Y (Threading, Y-axis toolholder)



Right-hand shown | Right-hand Insert for Right-hand Toolholder.

Toolholder dimensions

Description	Availability	Dimension (mm)									Spare parts		Applicable inserts ➔ J28
		R	H	B	LH	HF	LPR	HBKW	LF	WF	Screw	Wrench	
													
KTKFR 1216JX-12-Y 1616JX-12-Y	● ●	12 16	16	20 25	12 16	6	15 11	120	16	SB-4590TRWN	FT-10	TKFT12R...	

LPR shows the distance from the toolholder to the cutting edge.



Threading

Precautions for using Y-axis toolholder

Do not use Y-axis toolholders side by side to prevent interference. (Only two Y-axis holder can be used at the same time)

With interference

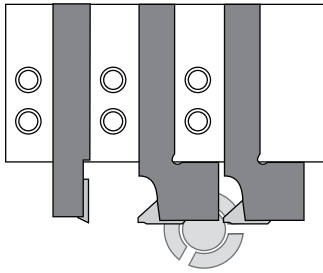

Without interference

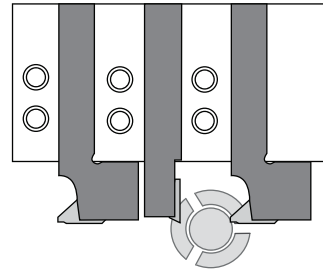

Standard toolholders may be mounted between two Y-axis toolholders

When changing the tool, set the retracted position with reference to the cutting edge of the Y-axis holder. (When exchanging from tool B to D)

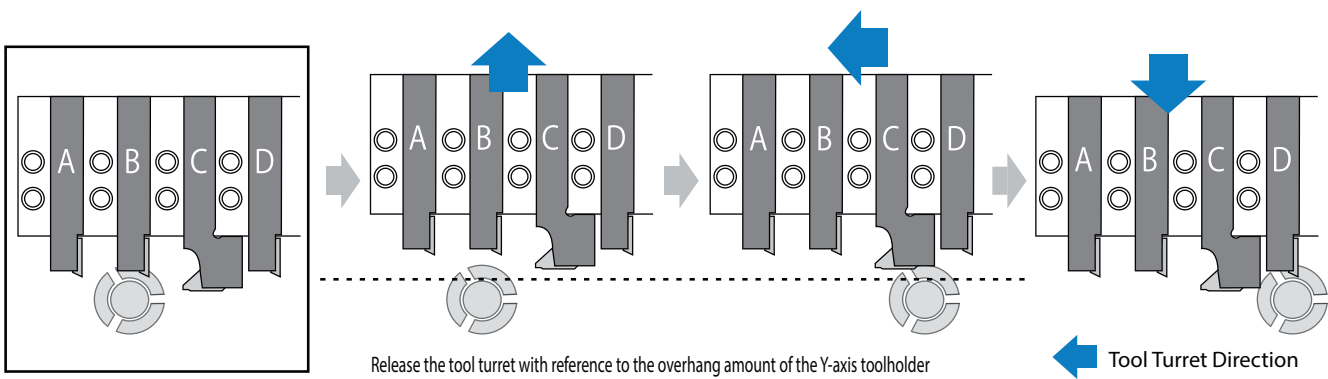

Threading

Note that using other toolholders together will result in different outside diameters

(Unit : mm)

Y-axis Toolholder Overhang	Examples	Overhang Amount L			
		Available Outside Cutting Diameter(φ)	20	22	25
20		A	Without Restriction	Without Restriction	Without Restriction
		B	13.0	13.0	13.0
		C	Without Restriction	Without Restriction	Without Restriction
25		A	38.0	58.0	Without Restriction
		B	14.9	13.6	13.0
		C	45.0	60.0	Without Restriction

Recommended cutting conditions

Workpiece material	Recommended insert grades			
	MEGACOAT NANO PLUS	MEGACOAT NANO	MEGACOAT	Carbide
	PR1725	PR1535	PR1225	KW10
Carbon steel	Vc = 70 ~170 m/mim			-
	First ap (Radial): 0.2mm and under			
Alloy steel	Vc = 70 ~170 m/mim			-
	First ap (Radial): 0.2 mm and under			
Stainless steel	Vc = 60~100 m/mim			-
	First ap (Radial): 0.15 mm and under			
Cast iron	-			Vc = 100 m/mim
	-			First ap (Radial): 0.2 mm and under
Aluminum alloys	-			Vc = 150~400 m/mim
	-			First ap (Radial): 0.2 mm and under
Brass	-			Vc = 150~300 m/mim
	-			First ap (Radial): 0.15 mm and under

- Coolant is recommended.
 - In case of threading stainless steel, please set two to three passes more than <ap - passes> listed below.

Depth of cut & number of passes

TKFT 60° / 55° Partial profile

(ap shows the value of radial ap)

Type	Pitch (mm/TPI)	Description	Corner-R (RE)	Total ap (mm)	No. of passes	1	2	3	4	5	6	7	8	9	10	11			
Metric	External thread	TKFT 12R/L A/B6000	Max 0.05 Flat	0.15	4	0.06	0.04	0.03	0.02										
				0.19	4	0.07	0.06	0.04	0.02										
				0.23	4	0.08	0.07	0.06	0.04										
				0.27	5	0.08	0.07	0.06	0.04	0.02									
				0.30	5	0.10	0.08	0.06	0.04	0.02									
				0.34	6	0.10	0.08	0.06	0.04	0.04	0.02								
		TKFT 12R/L A/B6000 12R/L A/B60005	0.05	0.38	6	0.10	0.10	0.07	0.05	0.04	0.02								
				0.33	5	0.10	0.10	0.07	0.04	0.02									
		TKFT 12R/L A/B6000 12R/L A/B60005	0.05	0.45	Max 0.05 Flat	0.45	7	0.10	0.10	0.08	0.06	0.05	0.04	0.02					
				0.40	6	0.10	0.10	0.08	0.06	0.04	0.02								
		TKFT 12R/L A/B60005	0.05	0.48	0.05	0.48	6	0.10	0.10	0.10	0.10	0.06	0.02						
				0.52	7	0.10	0.10	0.10	0.08	0.07	0.05	0.02							
				0.56	7	0.10	0.10	0.10	0.10	0.08	0.06	0.02							
				0.71	8	0.15	0.15	0.12	0.10	0.08	0.06	0.03	0.02						
0.66	7			0.18	0.15	0.12	0.10	0.06	0.03	0.02									
0.90	9			0.20	0.18	0.13	0.10	0.10	0.07	0.05	0.05	0.02							
TKFT 12R/L A/B60005 12R/L N6001	0.10	0.85	8	0.20	0.18	0.13	0.10	0.10	0.07	0.05	0.02								
		1.04	10	0.20	0.18	0.14	0.12	0.10	0.10	0.08	0.05	0.05	0.02						
Parallel pipe	External thread	TKFT 12R/L A/B55005	0.05	0.67	7	0.18	0.15	0.12	0.10	0.06	0.04	0.02							
			0.05	1.01	9	0.20	0.18	0.14	0.12	0.12	0.10	0.08	0.05	0.02					
Whitworth	External thread	TKFT 12R/L A/B55005	0.05	0.79	8	0.18	0.18	0.12	0.10	0.08	0.07	0.04	0.02						
			0.05	0.96	9	0.20	0.20	0.15	0.10	0.10	0.08	0.06	0.05	0.02					
			0.05	1.07	10	0.20	0.18	0.15	0.12	0.10	0.10	0.08	0.07	0.05	0.02				
			0.05	1.21	11	0.20	0.18	0.15	0.15	0.12	0.10	0.10	0.08	0.07	0.05	0.04	0.02		



TTX

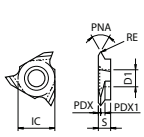

Insert		Description		Thread type	Symbol thread type	Pitch				Profile type	Thread angle PNA (°)	Dimension (mm)						Carbide			Applicable toolholder J35
						M (mm) G, R (TPI)		UN, W (TPI)				IC	S	D1	RE	PDX	PDX1	PVD	-	-	
						min.	max.	min.	max.												
 	TTX32R 6000	Metric Unified	M UN	0.5	1	56	32	Partial profile	60	9.525	3.18	4.4	0	0.6	1.12						
	TTX32R 6000S			0.5	1	48	32		60	9.525	3.18	4.4	0.05	0.6	1.12	●	●	●			
	TTX32R 6001			1	2	28	14		60	9.525	3.18	4.4	0.1	1.1	1.62	●	●	●			
	TTX32R 6000S			0.5	56	48	60		9.525	3.18	4.4	0	0.3	1.12	●	●					
	TTX32R 6000SS			0.5	48	60	9.525		3.18	4.4	0.05	0.3	1.12	●	●	●					
	TTX32R 5501			Parallel/ Tapered pipe Whitworth	G R W	28	19		24	20	55	9.525	3.18	4.4	0.1	0.75	1.01	●	●	●	
	TTX32R 5501S	19	11			20	11	55	9.525	3.18	4.4	0.15	1.2	1.46	●	●					

Right-hand shown

Recommended cutting conditions J48
Depth of Cut & Number of Passes J56

Threading

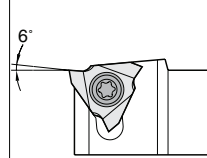
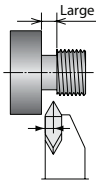
TT and TTX

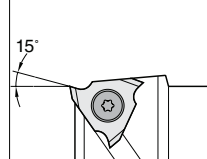
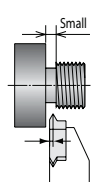
Type	Shape	Features		
		Rake Angle after Installation	Condition	Dead Space
TT		 <p>6°</p>	<ul style="list-style-type: none"> One insert can machine various pitch sizes 	 <p>Large</p>
TTX		 <p>15°</p>	<ul style="list-style-type: none"> The Least Cutting Force Thread to shoulder (Less dead space) One Insert can machine various pitch sizes (less than TT) 	 <p>Small</p>

● : Standard item R : Right-hand only L : Left-hand only □ : Check availability

PR930 / PR1115 (Threading inserts) are sold in 5 piece boxes

KW10 / TC60 (Threading inserts) are sold in 10 piece boxes

KTTX

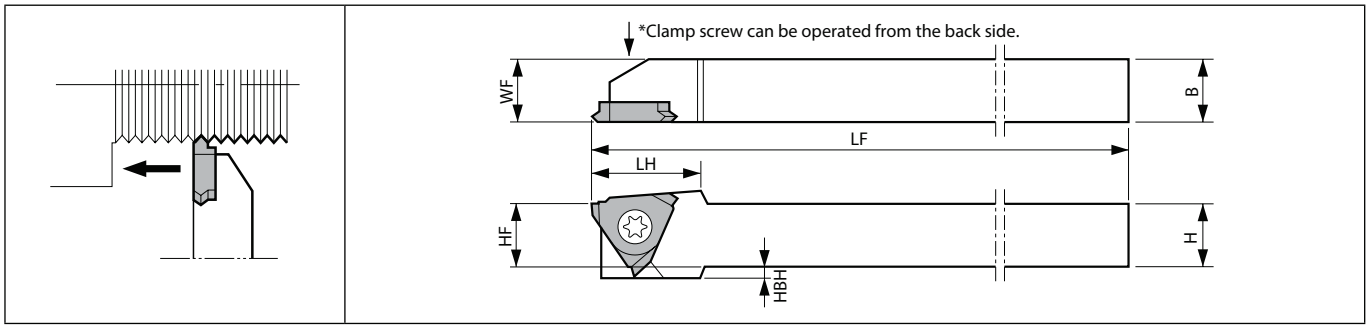

Thread to shoulder | Right-hand shown | Right-hand Insert for Right-hand Toolholder.

Toolholder dimensions

Description	Availability	Dimension (mm)							Spare parts		Applicable inserts ➔ J34	
		R	H	B	LH	HF	HBH	LF	WF	Screw		Wrench
		KTTXR	●	10	10	17.6	10	2	120	10		SB-4070TRW
1212F-16F	●	12	12	12	85		12					
1212JX-16F	●	16	16	16	120	16						
1616JX-16F	●	16	16	20	125	20						
2020K-16F	●	20	20	20	125	20						

S-KTTX

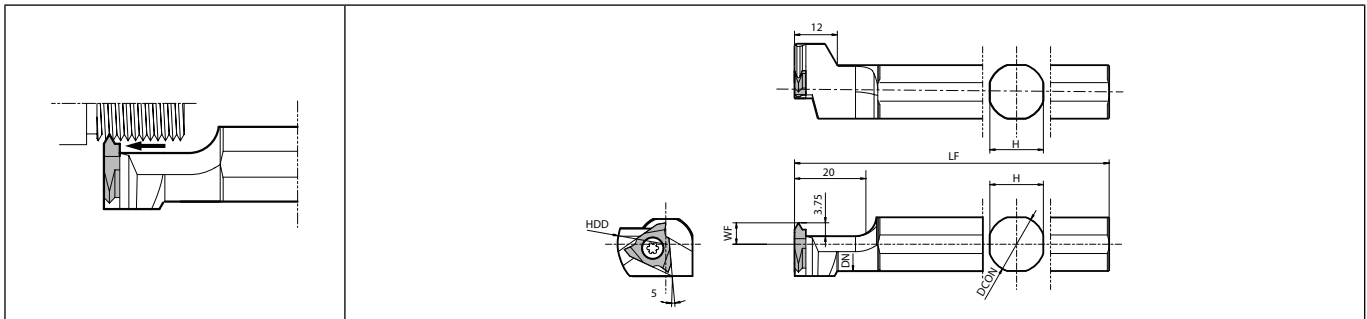

Thread to shoulder | Left-hand shown | Right-hand Insert for Left-hand Toolholder.

Toolholder dimensions

Description	Availability	Dimension (mm)							Spare parts		Applicable inserts ➔ J34
		L	DCON	H	DN	HDD	LF	WF	Screw	Wrench	
		S12F- KTTXL16	●	12	11	11	27	80	6	SB-4070TRW	
S14H- KTTXL16	●	14	13	13	100						
S15F- KTTXL16	●	15.875	15	14.6	85						
S16F- KTTXL16	●	16			90						
S19G- KTTXL16	●	19.05	17	17.6	120						
S19K- KTTXL16	●	20	18	18.6	90						
S20G- KTTXL16	●				120						
S20K- KTTXL16	●	25	23	23.6	100						
S25.0H- KTTXL16	●				10	120					
S25K- KTTXL16	●	25.4									

● : Standard item R : Right-hand only L : Left-hand only □ : Check availability



Threading

TT (External threading)

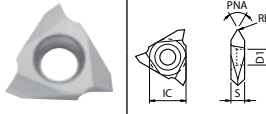
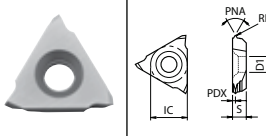
Insert		Description		Thread type	Symbol thread type	Pitch				Profile type	Thread angle PNA (°)	Dimension (mm)					Carbide			Applicable toolholder ➡ J37
						M (mm) G, PT (TPI)		UN, W (TPI)				IC	S	D1	RE	PDX	PVD		-	
						min.	max.	min.	max.								PR1115	PR930		
		TT32R	6000	Metric	M	UN	0.5	56	10	60	9.525	3.18	4.4	0	-	●	○	●	KTTR....-16	
			6001				6002	6003						1		2.5	24			16
		TT32L	6000	Metric	M	UN	0.5	56	10	60	9.525	3.18	4.4	0	-	●	○	●	KTTL....-16	
			6001				6002	1						2.5		24	16			0.1
		TT32R	5501	Parallel/ Tapered pipe	G PT W	28	11	24	10	55	60	12.7	4.76	5.5	0.1	-	●	○	●	KTTR....-16
			5502			14	11	14	10						0.2		●	●		
		TT32L	5501	Whitworth	G PT W	28	11	24	10	55	60	12.7	4.76	5.5	0.1	-	●	○	●	KTTL....-16
			5502			14	11	14	10						0.2		●	●		
		TT43R	6001	Metric	M	UN	1	24	8	60	12.7	4.76	5.5	0.1	-	●	○	●	KTTR....-22	
			6002				6003	6004						1.5		3.5	16			11
		TT43L	6001	Metric	M	UN	1	24	8	60	12.7	4.76	5.5	0.1	-	●	○	●	KTTL....-22	
			6002				1.5	3.5						16		11	0.2			●
		TT43R	5501	Parallel/ Tapered pipe	G PT W	28	11	24	7	55	60	12.7	4.76	5.5	0.1	-	●	○	●	KTTR....-22
			5502			5503	11	11	10						0.2		●	●		
		TT43L	5501	Whitworth	G PT W	28	11	24	7	55	60	12.7	4.76	5.5	0.1	-	●	○	●	KTTL....-22
5502	14		11			16	10	0.2	●						●		●			
		TT43ER	100M	Metric	M	-		Full profile	60	12.7	4.76	5.5	0.12	-	●	○	●	KTTR....-22		
			125M			1.25	0.15						0.8		●					
			150M			1.5	0.19						0.9		●					
			200M			2	1						1		●					
							1.7						1.7		●					

Right-hand shown

Recommended cutting conditions ➡ J48
 Depth of Cut & Number of Passes ➡ J55, J56

● : Standard item R : Right-hand only L : Left-hand only □ : Check availability

PR930 / PR1115 (Threading inserts) are sold in 5 piece boxes

KW10 / TC60 (Threading inserts) are sold in 10 piece boxes

KTT

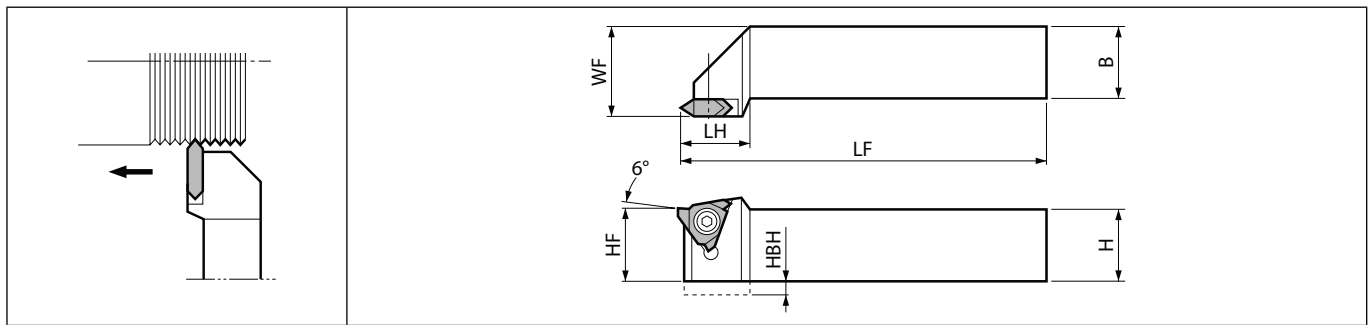

Right-hand shown | Right-hand Insert for Right-hand Toolholder, Left-hand Insert for Left-hand Toolholder.

Toolholder dimensions

Description	Availability		Dimension (mm)								Spare parts					Applicable inserts ➔ J36
											Screw	Screw	Wrench	Wrench	Wrench	
	R	L	H	B	LH	HF	HBH	LF	WF							
KTT [®] / _L 1010F-16 1212H-16 1616H-16 2020K-16 2525M-16	●	●	10	10	18	10	4	80	12	SB-4070TRS			-	FT-10	TT32 [®] / _L ...	
	●	●	12	12		12	2	100	16				-	-		-
	●	●	16	16		16	-	125	25	SB-4TR			FT-15	-		
	●	●	20	20		20	-	150	30				-	-		-
KTT [®] / _L 2020K-22 2525M-22	●	●	20	20	25	20	-	125	25	-	GS-50	LW-3	-	-	TT43 [®] / _L ... TT43ER...M	
	●	●	25	25		25	-	150	30	-	-	-	-	-		

● : Standard item R : Right-hand only L : Left-hand only □ : Check availability



Threading

TT (Internal threading)

		Carbon steel / Alloy steel								● ○		P					
		Stainless steel								● ○		M					
		Cast iron								● ○		K					
		Non-ferrous metals								● ○		N					
Insert	Description	Thread type	Symbol thread type	Pitch				Profile type	Thread angle PNA (°)	Dimension (mm)				Carbide			Applicable toolholder J39
				M(mm) G, PT (TPI)		UN, W (TPI)				IC	S	D1	RE	PVD	-		
				min.	max.	min.	max.									PR1115	
	TT32R 6000 6001	Metric Unified	M UN	0.5	2.5	48	10	60	9.525	3.18	4.4	0	●	●	KITGL...-16		
	TT32L 6000 6001			1.5	2.5	48	10					0	●	●			
	TT32R 5501 5502	Parallel/Tapered pipe Whitworth	G PT W	28	11	24	10	55	12.7	4.76	5.5	0.1	●	●	KITGL...-16		
	TT32L 5501 5502			-	-	16	18					0.2	●	●			
	TT43R 6001 6002	Metric Unified	M UN	1.5	3	16	10	60	12.7	4.76	5.5	0.1	●	●	KITGL...-22		
	TT43L 6001 6002			3	3	8	8					0.2	●	●			
	TT43R 5501 5502 5503	Parallel/Tapered pipe Whitworth	G PT W	28	11	24	8	55	12.7	4.76	5.5	0.1	●	●	KITGL...-22		
	TT43L 5501 5502			14	11	16	8					0.2	●	●			
				28	11	24	8					0.3	●	●			
				14	11	16	8					0.1	●	●	KITGR...-22		

Right-hand shown

Recommended cutting conditions J48
Depth of Cut & Number of Passes J55, J56

● : Standard item R : Right-hand only L : Left-hand only □ : Check availability

PR930 / PR1115 (Threading inserts) are sold in 5 piece boxes

KW10 / TC60 (Threading inserts) are sold in 10 piece boxes

KITG

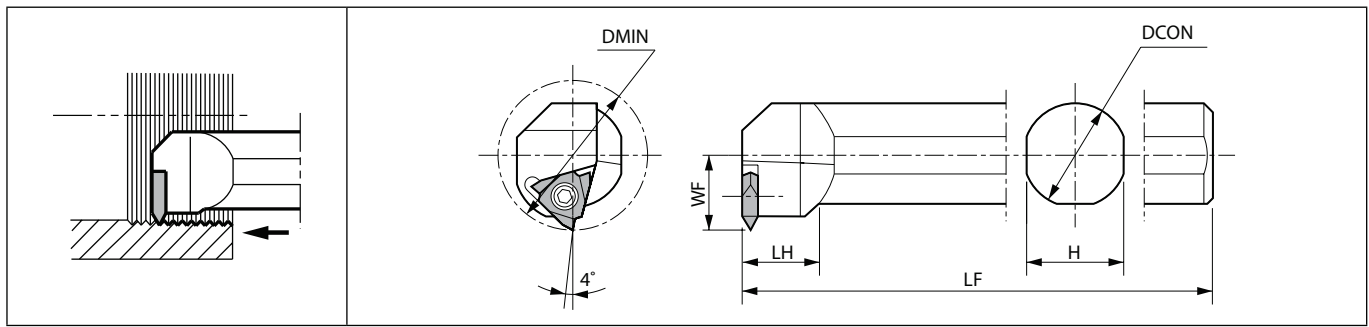

Right-hand shown | Left-hand Insert for Right-hand Toolholder, Right-hand Insert for Left-hand Toolholder.

Toolholder dimensions

Description	Availability		Dimension (mm)							Spare parts				Applicable inserts ➔ J38
										Screw	Screw	Wrench	Wrench	
	R	L	DMIN	DCON	H	LH	LF	WF						
KITG%L 3525T-16	●	●	35	25	23	18	220	17.5	SB-4TR	-	-	FT-15	TT32 ^{1/2} /R...	
KITG%L 4532T-22	●	●	45	32	30	20	250	22.5	-	GS-50	LW-3	-	TT43 ^{1/2} /R...	

Max. available Pitch : KITG%L.3525T-16...TP 2.5mm or 10TPI, KITG%L.4532T-22...TP 3.0mm or 8TPI.



Threading

EZT (Internal threading)

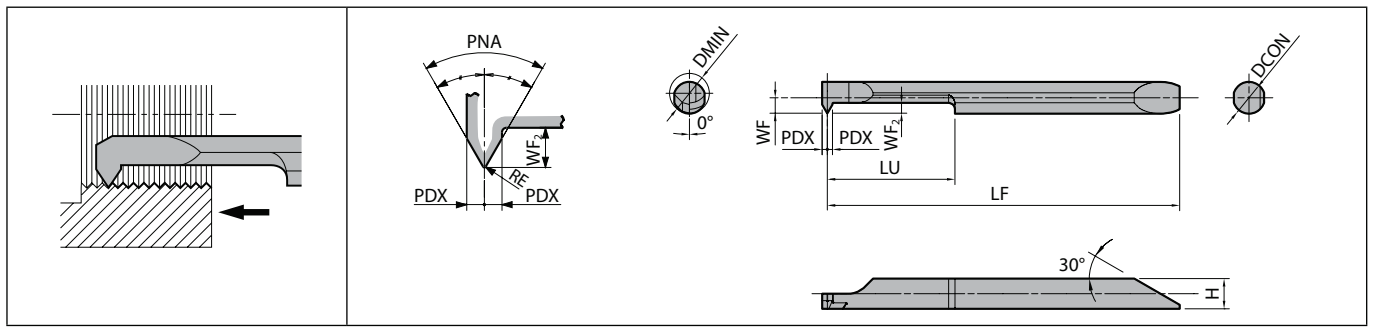

Right-hand shown

Dimensions

Description	No. of edges	Dimension (mm)									Thread angle PNA (°)	Tolerance (mm)		Carbide		Applicable Thread					
		DMIN	DCON	H	LF	LU	WF	WF ₂	PDX	RE		RE min.	RE max.	PVD PR1225	- GW05	Metric		Unified		American National Tapered Pipe	
																Nominal Thread	Pitch (mm)	Nominal Thread	Pitch (TPI)	Nominal Thread	Pitch (TPI)
EZTR 030025-60-002 035030-60-002 040035-60-004 050040-60-004 060050-60-004 070060-60-004	1	3	2.5	2.3	34.5	6	1.19	1	0.5	0.02	60°	0.01	0.01	●	●	M4 and over (Fine Thread : M3.5 and over)	0.35~0.8	No.8-32UNC No.8-36UNF and over	36~32	-	-
		3.5	3	2.8	38.4	8.4	1.44	1.2	0.6					●	●	M4.5 and over (Fine Thread : M4.5 and over)	0.5~1.0	No.10-24UNC No.8-36UNF and over	36~24	-	-
		4	3.5	3.3	41.4	10.4	1.69	1.3	0.65					●	●	M5 and over (Fine Thread : M6 and over)	0.75~1.25	No.12-24UNC No.12-28UNF and over	28~20	-	-
		5	4	3.8	44.35	15.35	1.94	1.3	0.65					●	●	M7 and over (Fine Thread : M6 and over)	0.75~1.5	1/4-20UNC 1/4-28UNF and over	28~18	-	-
		6	5	4.8	52.4	19.2	2.44	1.6	0.8					●	●	M8 and over (Fine Thread : M7 and over)	0.75~1.5	5/16-18UNC 5/16-24UNF and over	24~16	1/4NPT 3/8NPT	18
		7	6	5.8	60.2	24	2.94	2	1					●	●	M9 and over (Fine Thread : M8 and over)	0.75~1.75	3/8-16UNC 3/8-24UNF and over	24~16	1/4NPT and over	18,14
														Whitworth		Parallel Pipe / Tapered Pipe					
EZTR 060050-55-008 080070-55-008	1	6	5	4.8	52.4	19.2	2.44	1.6	0.8	0.085	55°	0.015	0.015	●	●	W10 TPI24 and over	24~20	G1/16 and over R1/16 and over	28	-	-
		8	7	6.8	63.2	24	3.44	2	1					●	●	W11 TPI20 and over	20~18	G1/8 and over R1/8 and over	28,19	-	-

For American National Tapered Pipe (NPT), use EZTR...-60-004. ● J43

Applicable sleeves ● J41
Recommended cutting conditions ● J42
Depth of Cut & Number of Passes ● J42, J43

● : Standard item R : Right-hand only L : Left-hand only □ : Check availability

EZ bars are sold in 1 piece boxes



Applicable sleeves

Sleeve description				Applicable inserts		Applicable machine manufacturer
EZH-CT (Adjustable overhang length / with coolant hole) F38, F39	EZH-HP (Adjustable overhang length) F40, F41	EZH-ST F42, F43	Sleeve shank dia. DCON (mm)	EZT	Shank dia. DCON (mm)	
		EZH 02512ST-80 03012ST-80 03512ST-80 04012ST-80 05012ST-80 06012ST-80 07012ST-80	12	EZTR030025-... EZTR035030-... EZTR040035-... EZTR050040-... EZTR060050-... EZTR070060-... EZTR080070-...	2.5 3 3.5 4 5 6 7	(General purpose)
	EZH 02516HP-100 03016HP-100 03516HP-100 04016HP-100 05016HP-100 06016HP-100 07016HP-100	EZH 02516ST-100 03016ST-100 03516ST-100 04016ST-100 05016ST-100 06016ST-100 07016ST-100	16	EZTR030025-... EZTR035030-... EZTR040035-... EZTR050040-... EZTR060050-... EZTR070060-... EZTR080070-...	2.5 3 3.5 4 5 6 7	(General purpose)
EZH 02519CT-120 03019CT-120 03519CT-120 04019CT-120 05019CT-120 06019CT-120 07019CT-120	EZH 02519HP-120 03019HP-120 03519HP-120 04019HP-120 05019HP-120 06019HP-120 07019HP-120	EZH 02519ST-120 03019ST-120 03519ST-120 04019ST-120 05019ST-120 06019ST-120 07019ST-120	19.05	EZTR030025-... EZTR035030-... EZTR040035-... EZTR050040-... EZTR060050-... EZTR070060-... EZTR080070-...	2.5 3 3.5 4 5 6 7	Citizen machinery
EZH 02520CT-120 03020CT-120 03520CT-120 04020CT-120 05020CT-120 06020CT-120 07020CT-120	EZH 02520HP-120 03020HP-120 03520HP-120 04020HP-120 05020HP-120 06020HP-120 07020HP-120	EZH 02520ST-120 03020ST-120 03520ST-120 04020ST-120 05020ST-120 06020ST-120 07020ST-120	20	EZTR030025-... EZTR035030-... EZTR040035-... EZTR050040-... EZTR060050-... EZTR070060-... EZTR080070-...	2.5 3 3.5 4 5 6 7	Eguro Tsugami Citizen machinery (General purpose)
EZH 02522CT-135 03022CT-135 03522CT-135 04022CT-135 05022CT-135 06022CT-135 07022CT-135	EZH 02522HP-135 03022HP-135 03522HP-135 04022HP-135 05022HP-135 06022HP-135 07022HP-135	EZH 02522ST-135 03022ST-135 03522ST-135 04022ST-135 05022ST-135 06022ST-135 07022ST-135	22	EZTR030025-... EZTR035030-... EZTR040035-... EZTR050040-... EZTR060050-... EZTR070060-... EZTR080070-...	2.5 3 3.5 4 5 6 7	Star micronics Nomura DS Tsugami
EZH 02525.0CT-135 03025.0CT-135 03525.0CT-135 04025.0CT-135 05025.0CT-135 06025.0CT-135 07025.0CT-135	EZH 02525.0HP-135 03025.0HP-135 03525.0HP-135 04025.0HP-135 05025.0HP-135 06025.0HP-135 07025.0HP-135	EZH 02525.0ST-135 03025.0ST-135 03525.0ST-135 04025.0ST-135 05025.0ST-135 06025.0ST-135 07025.0ST-135	25	EZTR030025-... EZTR035030-... EZTR040035-... EZTR050040-... EZTR060050-... EZTR070060-... EZTR080070-...	2.5 3 3.5 4 5 6 7	Eguro Tsugami Citizen machinery (General purpose)
EZH 02525.4CT-120 03025.4CT-120 03525.4CT-120 04025.4CT-120 05025.4CT-120 06025.4CT-120 07025.4CT-120	EZH 02525.4HP-120 03025.4HP-120 03525.4HP-120 04025.4HP-120 05025.4HP-120 06025.4HP-120 07025.4HP-120	EZH 02525.4ST-120 03025.4ST-120 03525.4ST-120 04025.4ST-120 05025.4ST-120 06025.4ST-120 07025.4ST-120	25.4	EZTR030025-... EZTR035030-... EZTR040035-... EZTR050040-... EZTR060050-... EZTR070060-... EZTR080070-...	2.5 3 3.5 4 5 6 7	Citizen machinery

Choose sleeves (DCB) to meet with DCON dimension of bar.

Adjustment Pin cannot be installed to EZH-ST sleeves. To adjust overhang of the bar, please use EZH-CT / HP sleeves.

Machine manufacturers in random order.



Threading

Recommended cutting conditions

Workpiece material	Recommended insert grades (Vc: m/min)	
	MEGACOAT	Carbide
	PR1225	GW15
Carbon steel / Alloy steel	★ 30~50	-
Stainless steel	★ 30~50	-
Non-ferrous metals	-	★ 30~50

★: 1st Recommendation

<Note>

- 1) The standard cutting speed is $V_c=30\sim50$ m/min.
The table feed may not follow the expected conditions when machining small diameter workpieces at high speeds.
- 2) Coolant is recommended.

Depth of cut & number of passes (Metric: M)

Pitch (mm)	Total ap (mm)	No. of passes	1Pass	2Pass	3Pass	4Pass	5Pass	6Pass	7Pass	8Pass	9Pass	10Pass	11Pass	12Pass	13Pass	14Pass	15Pass	16Pass	17Pass	18Pass	19Pass	20Pass
0.5	0.3	9	0.05	0.05	0.04	0.04	0.03	0.03	0.02	0.02	0.02											
0.7	0.42	10	0.06	0.05	0.05	0.05	0.05	0.04	0.04	0.03	0.03	0.02										
0.75	0.45	10	0.06	0.06	0.05	0.05	0.05	0.04	0.04	0.04	0.03	0.03										
0.8	0.48	11	0.06	0.06	0.05	0.05	0.05	0.04	0.04	0.04	0.03	0.03	0.03									
1.00	0.61	12	0.07	0.07	0.06	0.06	0.06	0.05	0.05	0.05	0.04	0.04	0.03	0.03								
1.25	0.77	14	0.07	0.07	0.07	0.07	0.06	0.06	0.06	0.06	0.05	0.05	0.04	0.04	0.04	0.03						
1.50	0.93	17	0.07	0.07	0.07	0.07	0.07	0.06	0.06	0.06	0.06	0.05	0.05	0.05	0.04	0.04	0.04	0.04	0.03			
1.75	1.1	20	0.07	0.07	0.07	0.07	0.07	0.07	0.06	0.06	0.06	0.06	0.06	0.05	0.05	0.05	0.05	0.04	0.04	0.04	0.03	0.03

Depth of cut & number of passes (Whitworth)

TPI	Total ap (mm)	No. of passes	1Pass	2Pass	3Pass	4Pass	5Pass	6Pass	7Pass	8Pass	9Pass	10Pass	11Pass	12Pass	13Pass	14Pass	15Pass	16Pass	17Pass
24	0.65	13	0.07	0.07	0.06	0.06	0.06	0.05	0.05	0.05	0.04	0.04	0.04	0.03	0.03				
20	0.81	15	0.07	0.07	0.07	0.07	0.06	0.06	0.06	0.06	0.05	0.05	0.05	0.04	0.04	0.03	0.03		
18	0.91	17	0.07	0.07	0.07	0.07	0.07	0.06	0.06	0.06	0.06	0.05	0.05	0.05	0.04	0.04	0.03	0.03	0.03

Depth of cut & number of passes (Unified: UN, UNC, UNF, UNEF)

TPI	Total ap (mm)	No. of passes	1Pass	2Pass	3Pass	4Pass	5Pass	6Pass	7Pass	8Pass	9Pass	10Pass	11Pass	12Pass	13Pass	14Pass	15Pass	16Pass	17Pass	18Pass
36	0.44	10	0.06	0.06	0.06	0.05	0.05	0.05	0.04	0.03	0.02	0.02								
32	0.5	11	0.06	0.06	0.06	0.05	0.05	0.05	0.04	0.04	0.03	0.03	0.03							
28	0.55	12	0.07	0.06	0.05	0.05	0.05	0.05	0.05	0.04	0.04	0.03	0.03	0.03						
24	0.65	12	0.07	0.07	0.06	0.06	0.06	0.06	0.05	0.05	0.05	0.05	0.04	0.03						
20	0.78	14	0.07	0.07	0.07	0.06	0.06	0.06	0.06	0.06	0.06	0.05	0.05	0.04	0.04	0.03				
18	0.88	17	0.07	0.07	0.07	0.06	0.06	0.06	0.06	0.06	0.05	0.05	0.05	0.04	0.04	0.04	0.04	0.03	0.03	
16	0.99	18	0.07	0.07	0.07	0.07	0.06	0.06	0.06	0.06	0.06	0.06	0.05	0.05	0.05	0.05	0.04	0.04	0.04	0.03

Parallel pipe: G(PF), Rp(PS)

Nominal thread Symbol (Previous symbol)	TPI	Internal thread (G, Rp)		Same root's radius	
		Insert	Bore dia.		
G 1/16 (-)	28	EZTR	060050-55-008	6.56	0.12
G 1/8 (PF 1/8)			080070-55-008	8.57	
G 1/4 (PF 1/4)	19	EZTR	080070-55-008	11.45	0.18
G 3/8 (PF 3/8)				14.95	

Tapered pipe: R, Rc(PT)(BSPT)

Nominal thread Symbol (Previous symbol)	TPI	Internal thread (Rc)		Same root's radius	
		Insert	Bore dia.		
R 1/16, Rc 1/16 (-)	28	EZTR	060050-55-008	-	0.12
R 1/8, Rc 1/8 (PT 1/8)			080070-55-008	-	
R 1/4, Rc 1/4 (PT 1/4)	19	EZTR	080070-55-008	-	0.18
R 3/8, Rc 3/8 (PT 3/8)				-	

• When using "EZT type" for Parallel pipe / Tapered pipe threading, thread's corners become sharp edged due to its Partial profile, and the shape will not be the same as the standard shape for Parallel pipe / tapered pipe.

Depth of cut & number of passes (Parallel pipe / Tapered pipe)

TPI	Total ap (mm)	No. of passes	1 Pass	2 Pass	3 Pass	4 Pass	5 Pass	6 Pass	7 Pass	8 Pass	9 Pass	10 Pass	11 Pass	12 Pass	13 Pass	14 Pass	15 Pass	16 Pass	17 Pass	18 Pass	
28	0.61	12	0.07	0.07	0.06	0.06	0.06	0.05	0.05	0.05	0.04	0.04	0.03	0.03							
19	0.95	18	0.07	0.07	0.07	0.07	0.06	0.06	0.06	0.06	0.06	0.05	0.05	0.05	0.04	0.04	0.04	0.04	0.03	0.03	

Application of American national tapered pipe thread (NPT)

Nominal thread	TPI	Internal thread		
		Toolholder	Insert	
			Partial profile	Full profile
1/16 NPT 1/8 NPT	27	No tools available		
1/4 NPT 3/8 NPT	18	EZH Sleeves	EZTR060050-60-004 EZTR070060-60-004	-
1/2 NPT 3/4 NPT	14	EZH Sleeves	EZTR070060-60-004	-
1/2 NPT 3/4 NPT	14	SINR1616S-16 SINR2016S-16	-	16IR14NPT

• Application of NPTF thread

NPTF is the thread for sealing pipes without using any sealing material.

Thread symbol is similar to NPT but the tolerance is different from that of NPT, therefore the above inserts are not available for NPTF.

Depth of cut & number of passes (American national tapered pipe)

TPI	Total ap (mm)	No. of passes	1 Pass	2 Pass	3 Pass	4 Pass	5 Pass	6 Pass	7 Pass	8 Pass	9 Pass	10 Pass	11 Pass	12 Pass	13 Pass	14 Pass	15 Pass	16 Pass	17 Pass	18 Pass	19 Pass
18	1.23	16	0.18	0.14	0.12	0.12	0.10	0.09	0.08	0.08	0.07	0.06	0.05	0.04	0.03	0.03	0.02	0.02			
14	1.56	19	0.18	0.16	0.14	0.14	0.12	0.10	0.09	0.09	0.08	0.07	0.07	0.06	0.05	0.05	0.04	0.04	0.03	0.03	0.02

VNT

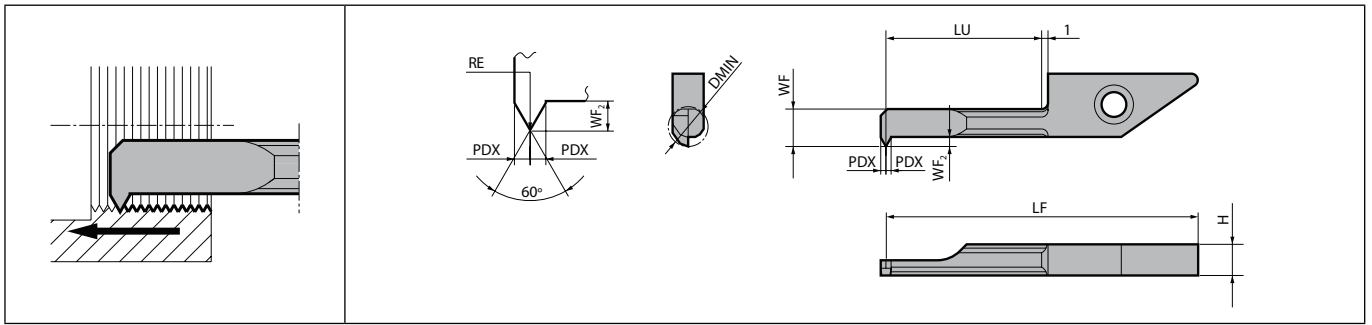

Right-hand shown

Dimensions

Description	No. of edges	Dimension (mm)								Tolerance (mm)		Carbide			Applicable Thread				Applicable toolholder F48~F51
		DMIN	H	LF	LU	WF	WF ₂	PDX	RE	RE min.	RE max.	PVD			Metric		Unified		
												PR1225	PR930	KW10	Nominal Thread	Pitch (mm)	Nominal Thread	Pitch (TPI)	
VNTR 045-11	1	4.5	3.9	30.2	10.4	3.6	1.3	0.6	0.05	0.02	0	●	●	●	M6 and over	0.75~1.25	1/4-20UNC, 1/4-28UNF and over	28~20	SVNR...-12N SVNSR-12-11N S...-SVNR12N S...-SVNR12SN
060-11		6		30	10.2	4.6	1.6					0.8	●	●	●	M8 and over	0.75~1.50	5/16-18UNC, 5/16-24UNF and over	

Recommended cutting conditions J45
Depth of Cut & Number of Passes J45



Threading

● : Standard item R : Right-hand only L : Left-hand only □ : Check availability

System tip-bars are sold in 5 piece boxes

Recommended cutting condition

Workpiece material	Recommended insert grades (Vc: m/min)		
	MEGACOAT	PVD coated carbide	Carbide
	PR1225	PR930	KW10
Carbon steel	★ 30~50	☆ 30~50	-
Stainless steel	★ 30~50	☆ 30~50	-
Non-ferrous metals	-	-	★ 30~50

<Note>

- 1) The standard cutting speed is Vc=30~50m/min. The table feed may not follow the expected conditions when machining small diameter workpieces at high speeds.
2) Coolant is recommended.

Depth of cut and number of passes (Metric: M)

Pitch (mm)	Total ap (mm)	No. of passes	1	2	3	4	5	6	7	8	9	10	11	12	13	14	15	16	17
0.75	0.44	10	0.06	0.06	0.05	0.05	0.05	0.04	0.04	0.03	0.03	0.03							
1.00	0.60	12	0.07	0.07	0.06	0.06	0.06	0.05	0.05	0.04	0.04	0.04	0.03	0.03					
1.25	0.76	14	0.07	0.07	0.07	0.07	0.06	0.06	0.06	0.05	0.05	0.05	0.04	0.04	0.04	0.03			
1.50	0.92	17	0.07	0.07	0.07	0.07	0.07	0.06	0.06	0.06	0.05	0.05	0.05	0.05	0.04	0.04	0.04	0.04	0.03

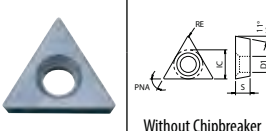

TPGB

Insert		Description		Material																Applicable toolholder J47		
				Carbon steel / Alloy steel																	P	
				Stainless steel																	M	
Cast iron																K						
Non-ferrous metals																N						
No. of edges	Dimension (mm)				Angle (°)		Pitch				Profile type	Thread type	Symbol thread type	Coating								
	IC	S	D1	RE	AN	PNA	M (mm)		UN (TPI)					- Carbide	Cermets		-					
							min.	max.	min.	max.					PVD	-						
																KW10	PV720	PV730	TN60	TN620		
	TPGB 1102005 110201	3	6.35	2.38	3.7	0.05 0.1	11	60	0.75 1.5	1.5	28 16	16	Partial profile	Metric Unified	M UN	●	●	●	●	●	...	STW ^P L11-12(E)
	TPGB 1103005 110301 110302	3	6.35	3.18	3.3	0.05 0.1 0.2	11	60	0.75 1.5 3	3.5	28 16 8	11 8 8	Partial profile	Metric Unified	M UN	●	●	●	●	●	...	STW ^P L11-16(E) STW ^P L11-20(E) STW ^P L11-25(E)

Recommended cutting conditions J48
Depth of Cut & Number of Passes J57

J



Threading

● : Standard item R : Right-hand only L : Left-hand only □ : Check availability

S-STWP

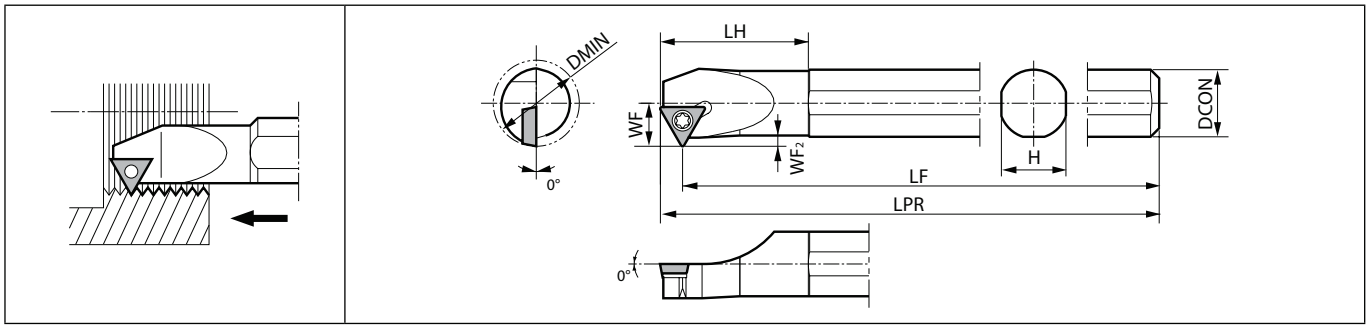

This toolholder is also available for threading. | Right-hand shown

Toolholder dimensions

Description	Availability		Dimension (mm)								GAMMO (°)	Coolant hole	Pitch max (mm)	Spare parts		Applicable inserts ➔ J46
	R	L	DMIN	DCON	H	LH	LPR	LF	WF	WF ₂				Screw	Wrench	
	S10M- STWPR11-12	●		12	10	9.2	23	150	144.5	6				1	0	
S12M- STWPR11-16	●		16	12	11	30			8	1.5		2				
S16Q- STWPR11-20	●		20	16	15	35	180	174.5	10	2		3				
S20R- STWPR11-25	●		25	20	19	40	200	194.5	12.5	2.5		3.5				

WF₂ : shows the Max. available ap.

S-STWP

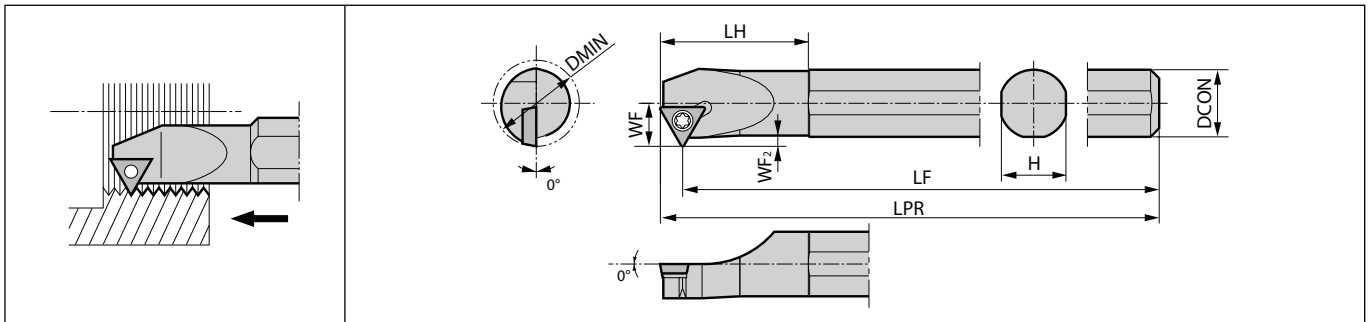

This toolholder is also available for threading. | Right-hand shown

Toolholder dimensions

Description	Availability		Dimension (mm)								GAMMO (°)	Coolant hole	Pitch max (mm)	Spare parts		Applicable inserts ➔ J46
	R	L	DMIN	DCON	H	LH	LPR	LF	WF	WF ₂				Screw	Wrench	
	S10M- STWP ^{P/L} 11-12E	●	●	12	10	9.2	23	150	144.5	6				1	0	
S12M- STWP ^{P/L} 11-16E	●	●	16	12	11	30			8	1.5		2				
S16R- STWP ^{P/L} 11-20E	●	●	20	16	15	35	200	194.5	10	2		3				
S20X- STWP ^{P/L} 11-25E	●	●	25	20	19	40	220	214.5	12.5	2.5		3.5				

WF₂ : shows the Max. available ap.

● : Standard item R : Right-hand only L : Left-hand only □ : Check availability



Threading

KTN / KTNS / SIN / CIN / S-KTN

Workpiece material	Recommended insert grades (Vc: m/min)					
	Cermet	MEGACOAT	MEGACOAT NANO		PVD coated carbide	Carbide
	TC60	PR1215	PR1515	PR1535	PR1115	GW15
Carbon steel	☆ 100~150	★ 100~150	-	-	☆ 100~150	-
First ap (Radial)	0.3 mm and under	0.3 mm and under			0.3 mm and under	
Alloy steel	☆ 100~150	★ 100~150	-	-	☆ 100~150	-
First ap (Radial)	0.3 mm and under	0.3 mm and under			0.3 mm and under	
Stainless steel	☆ 60~80	-	☆ 60~100	★ 40~80	☆ 60~80	-
First ap (Radial)	0.25 mm and under		0.25 mm and under	0.25 mm and under	0.25 mm and under	
Cast iron	-	-	-	-	-	★ 100
First ap (Radial)						0.3 mm and under
Aluminum alloys	-	-	-	-	-	★ 150~400
First ap (Radial)						0.3 mm and under
Brass	-	-	-	-	-	★ 150~300
First ap (Radial)						0.3mm and under

For O6IR / O8IR, please lower it to a figure under 40% of above condition list

KTT

Workpiece material	Recommended insert grades (Vc: m/min)			
	Cermet	PVD coated carbide		Carbide
	TC60	PR930	PR1115	KW10
Carbon steel	☆ 100~150	☆ 100~150	★ 100~150	-
First ap (Radial)	0.3 mm and under	0.3 mm and under	0.3 mm and under	
Alloy steel	☆ 100~150	☆ 100~150	★ 100~150	-
First ap (Radial)	0.3 mm and under	0.3 mm and under	0.3 mm and under	
Stainless steel	☆ 60~80	☆ 60~80	★ 60~80	-
First ap (Radial)	0.25 mm and under	0.25 mm and under	0.25 mm and under	
Cast iron	-	-	-	★ 100
First ap (Radial)				0.3 mm and under
Aluminum alloys	-	-	-	★ 150~400
First ap (Radial)				0.3 mm and under
Brass	-	-	-	★ 150~300
First ap (Radial)				0.3 mm and under

S-STWP(-E)

Workpiece material	Recommended insert grades (Vc: m/min)			
	Cermet		PVD coated cermet	Carbide
	TN620	TN60	PV720	KW10
Carbon steel	☆ 100~150	☆ 100~150	★ 100~150	-
First ap (Radial)	0.25 mm and under	0.25 mm and under	0.25 mm and under	
Alloy steel	☆ 100~150	☆ 100~150	★ 100~150	-
First ap (Radial)	0.25 mm and under	0.25 mm and under	0.25 mm and under	
Stainless steel	-	-	-	-
First ap (Radial)				
Cast iron	-	-	-	★ 100
First ap (Radial)				0.25 mm and under
Aluminum alloys	-	-	-	★ 150~400
First ap (Radial)				0.25 mm and under
Brass	-	-	-	★ 150~300
First ap (Radial)				0.25 mm and under

KTTX / S-KTTX

Workpiece material	Recommended insert grades (Vc: m/min)			
	Cermet	PVD coated carbide		Carbide
	TC60	PR930	PR1115	KW10
Carbon steel	☆ 100~150	☆ 100~150	★ 100~150	-
First ap (Radial)	0.3 mm and under	0.3 mm and under	0.3 mm and under	
Alloy steel	☆ 100~150	☆ 100~150	★ 100~150	-
First ap (Radial)	0.3 mm and under	0.3 mm and under	0.3 mm and under	
Stainless steel	☆ 60~80	☆ 60~80	★ 60~80	-
First ap (Radial)	0.25 mm and under	0.25 mm and under	0.25 mm and under	
Cast iron	-	-	-	★ 100
First ap (Radial)				0.3 mm and under
Aluminum alloys	-	-	-	★ 150~400
First ap (Radial)				0.3 mm and under
Brass	-	-	-	★ 150~300
First ap (Radial)				0.3 mm and under

KITG

Workpiece material	Recommended insert grades (Vc: m/min)			
	Cermet	PVD coated carbide		Carbide
	TC60	PR930	PR1115	KW10
Carbon steel	☆ 100~150	☆ 100~150	★ 100~150	-
First ap (Radial)	0.3 mm and under	0.3 mm and under	0.3 mm and under	
Alloy steel	☆ 100~150	☆ 100~150	★ 100~150	-
First ap (Radial)	0.3 mm and under	0.3 mm and under	0.3 mm and under	
Stainless steel	☆ 60~80	☆ 60~80	★ 60~80	-
First ap (Radial)	0.25 mm and under	0.25 mm and under	0.25 mm and under	
Cast iron	-	-	-	★ 100
First ap (Radial)				0.3 mm and under
Aluminum alloys	-	-	-	★ 150~400
First ap (Radial)				0.3 mm and under
Brass	-	-	-	★ 150~300
First ap (Radial)				0.3 mm and under

★: 1st Recommendation ☆: 2nd Recommendation

• Coolant is recommended.

• In case of using cermet insert, honing the edge with hand lapper enables higher stability.

• In case of threading Stainless steel, please set two to three passes more than previous description of <Depth of cut & number of passes>.

11/16 (Full profile)

(ap shows the value of radial ap)

Type	Pitch / TPI		Description	HC (mm)	Total ap (mm)	No. of Passes	1	2	3	4	5	6	7	8	9	10	11	12	13	14	15	16	17	18	19		
	mm / TPI	mm / TPI																									
Parallel pipe	External thread	19 TPI	16ER 19W-TF/TQ	0.89	0.97	6	0.27	0.22	0.18	0.15	0.10	0.05															
		14 TPI	14W-TF/TQ	1.19	1.27	9	0.27	0.22	0.18	0.16	0.11	0.10	0.10	0.08	0.05												
		11 TPI	11W-TF/TQ	1.50	1.58	12	0.27	0.22	0.18	0.16	0.12	0.12	0.12	0.10	0.10	0.10	0.07	0.07	0.05								
	Internal thread	19 TPI	16IR 19W-TF/TQ	0.88	0.96	6	0.25	0.21	0.20	0.15	0.10	0.05															
		14 TPI	14W-TF/TQ	1.19	1.27	9	0.27	0.22	0.18	0.16	0.11	0.10	0.10	0.08	0.05												
		11 TPI	11W-TF/TQ	1.50	1.58	12	0.27	0.22	0.18	0.16	0.12	0.12	0.12	0.10	0.10	0.10	0.07	0.07	0.05								
Whitworth	External thread	16 TPI	16ER 16W-TF/TQ	1.05	1.13	8	0.25	0.21	0.18	0.16	0.12	0.08	0.08	0.05													
		14 TPI	14W-TF/TQ	1.19	1.27	9	0.27	0.22	0.18	0.16	0.11	0.10	0.10	0.08	0.05												
		11 TPI	11W-TF/TQ	1.50	1.58	12	0.27	0.22	0.18	0.16	0.12	0.12	0.12	0.10	0.10	0.10	0.07	0.07	0.05								
	Internal thread	16 TPI	16IR 16W-TF/TQ	1.05	1.13	8	0.25	0.21	0.18	0.16	0.12	0.08	0.08	0.05													
		14 TPI	14W-TF/TQ	1.19	1.27	9	0.27	0.22	0.18	0.16	0.11	0.10	0.10	0.08	0.05												
		11 TPI	11W-TF/TQ	1.50	1.58	12	0.27	0.22	0.18	0.16	0.12	0.12	0.12	0.10	0.10	0.10	0.07	0.07	0.05								
Tapered pipe	External thread	28 TPI	16ER 28BSPT-TF/TQ	0.58	0.63	5	0.20	0.15	0.13	0.11	0.04																
		19 TPI	19BSPT-TF/TQ	0.86	0.94	6	0.26	0.20	0.18	0.15	0.10	0.05															
		14 TPI	14BSPT-TF/TQ	1.16	1.24	9	0.22	0.20	0.18	0.16	0.14	0.12	0.10	0.10	0.08	0.04											
		11 TPI	11BSPT-TF/TQ	1.48	1.56	12	0.26	0.22	0.18	0.16	0.12	0.12	0.11	0.10	0.10	0.10	0.07	0.07	0.05								
		28 TPI	16ER 28BSPT	0.58	0.63	5	0.20	0.15	0.13	0.11	0.04																
		19 TPI	19BSPT	0.86	0.94	6	0.26	0.20	0.18	0.15	0.10	0.05															
	Internal thread	28 TPI	11IR 28BSPT-TF/TQ	0.58	0.63	5	0.20	0.16	0.13	0.10	0.04																
		19 TPI	19BSPT-TF/TQ	0.86	0.94	7	0.22	0.20	0.18	0.14	0.10	0.06	0.04														
		14 TPI	14BSPT-TF/TQ	1.16	1.24	9	0.22	0.20	0.18	0.16	0.14	0.12	0.10	0.10	0.08	0.04											
		28 TPI	11IR 28BSPT	0.58	0.63	5	0.20	0.16	0.13	0.10	0.04																
		19 TPI	19BSPT	0.86	0.94	7	0.22	0.20	0.18	0.14	0.10	0.06	0.04														
		14 TPI	14BSPT	1.16	1.24	9	0.22	0.20	0.18	0.16	0.14	0.12	0.10	0.10	0.08	0.04											
American national tapered pipe	External thread	18 TPI	16ER 18NPT	1.14	1.22	13	0.20	0.16	0.14	0.12	0.10	0.10	0.08	0.08	0.07	0.06	0.05	0.04	0.02								
		14 TPI	14NPT	1.46	1.54	15	0.20	0.18	0.15	0.14	0.13	0.12	0.11	0.10	0.09	0.08	0.07	0.06	0.05	0.04	0.02						
		11.5 TPI	11.5NPT	1.77	1.85	16	0.22	0.20	0.18	0.16	0.15	0.14	0.13	0.12	0.10	0.10	0.08	0.08	0.07	0.06	0.04	0.02					
	Internal thread	18 TPI	16IR 18NPT	1.14	1.22	13	0.20	0.16	0.14	0.12	0.10	0.10	0.08	0.08	0.07	0.06	0.05	0.04	0.02								
		14 TPI	14NPT	1.46	1.54	15	0.20	0.18	0.15	0.14	0.13	0.12	0.11	0.10	0.09	0.08	0.07	0.06	0.05	0.04	0.02						
		11.5 TPI	11.5NPT	1.77	1.85	16	0.22	0.20	0.18	0.16	0.15	0.14	0.13	0.12	0.10	0.10	0.08	0.08	0.07	0.06	0.04	0.02					

60°/ 55° (Partial profile)

(ap shows the value of radial ap)

Type	Pitch / TPI		Description	Corner-R (RE)	Total ap (mm)	No. of Passes	1	2	3	4	5	6	7	8	9	10	11	12	13	14	15	16	17	18	19		
	mm / TPI	mm / TPI																									
Metric	External thread	0.5 mm	16ER A60-TF/TQ	0.06	0.33	5	0.10	0.08	0.07	0.05	0.03																
			AG60-TF/TQ	0.06	0.33	5	0.10	0.08	0.07	0.05	0.03																
		0.75 mm	16ER A60-TF/TQ	0.06	0.51	6	0.14	0.11	0.09	0.07	0.06	0.04															
			AG60-TF/TQ	0.06	0.51	6	0.14	0.11	0.09	0.07	0.06	0.04															
		1.00 mm	16ER A60-TF/TQ	0.06	0.70	7	0.18	0.13	0.12	0.09	0.08	0.06	0.04														
			AG60-TF/TQ	0.06	0.70	7	0.18	0.13	0.12	0.09	0.08	0.06	0.04														
		1.25 mm	16ER A60-TF/TQ	0.06	0.89	8	0.18	0.15	0.14	0.12	0.10	0.08	0.07	0.05													
			AG60-TF/TQ	0.06	0.89	8	0.18	0.15	0.14	0.12	0.10	0.08	0.07	0.05													
		1.50 mm	16ER A60-TF/TQ	0.06	1.08	9	0.21	0.17	0.16	0.14	0.11	0.09	0.08	0.07	0.05												
			AG60-TF/TQ	0.06	1.08	9	0.21	0.17	0.16	0.14	0.11	0.09	0.08	0.07	0.05												
		1.75 mm	16ER G60-TF/TQ	0.22	1.11	8	0.24	0.20	0.18	0.16	0.13	0.10	0.06	0.04													
			AG60-TF/TQ	0.06	1.27	11	0.22	0.20	0.18	0.13	0.11	0.09	0.09	0.08	0.07	0.05											
	2.00 mm	16ER G60-TF/TQ	0.22	1.30	10	0.24	0.20	0.18	0.16	0.14	0.12	0.09	0.07	0.06	0.04												
		AG60-TF/TQ	0.06	1.46	11	0.25	0.22	0.20	0.16	0.14	0.12	0.10	0.09	0.08	0.06	0.04											
	2.50 mm	16ER G60-TF/TQ	0.22	1.67	12	0.25	0.22	0.20	0.18	0.16	0.14	0.12	0.12	0.10	0.08	0.06	0.04										
		AG60-TF/TQ	0.06	1.84	13	0.25	0.22	0.20	0.19	0.17	0.16	0.14	0.11	0.10	0.09	0.09	0.07	0.05									
	3.00 mm	16ER G60-TF/TQ	0.22	2.05	14	0.25	0.23	0.22	0.20	0.18	0.16	0.14	0.13	0.12	0.11	0.10	0.09	0.07	0.05								
		AG60-TF/TQ	0.06	2.22	15	0.27	0.25	0.22	0.20	0.18	0.16	0.14	0.13	0.12	0.11	0.10	0.09	0.08	0.05								
	Internal thread	0.5 mm	16ER A60	0.06	0.33	5	0.10	0.08	0.07	0.05	0.03																
			AG60	0.06	0.33	5	0.10	0.08	0.07	0.05	0.03																
		0.75 mm	16ER A60	0.06	0.51	6	0.14	0.11	0.09	0.07	0.06	0.04															
			AG60	0.06	0.51	6	0.14	0.11	0.09	0.07	0.06	0.04															
		1.00 mm	16ER A60	0.06	0.70	7	0.18	0.13	0.12	0.09	0.08	0.06	0.04														
			AG60	0.06	0.70	7	0.18	0.13	0.12	0.09	0.08	0.06	0.04														
1.25 mm		16ER A60	0.06	0.89	8	0.18	0.15	0.14	0.12	0.10																	

60° / 55° (Partial profile)

(ap shows the value of radial ap)

Type	Pitch / TPI	Description	Corner-R (RE)	Total ap (mm)	No. of passes	1	2	3	4	5	6	7	8	9	10	11	12	13	14	15	16	17	18	19		
Whitworth	External thread	48 TPI 16ER A55 AG55	0.06	0.37	5	0.12	0.09	0.07	0.05	0.04																
		24 TPI 16ER A55 AG55	0.06	0.79	7	0.18	0.16	0.14	0.11	0.08	0.07	0.05														
		20 TPI 16ER A55 AG55	0.06	0.96	8	0.20	0.18	0.15	0.13	0.10	0.08	0.07	0.05													
		18 TPI 16ER A55 AG55	0.06	1.07	9	0.20	0.17	0.16	0.14	0.11	0.09	0.08	0.07	0.05												
		16 TPI 16ER A55 AG55	0.06	1.22	11	0.20	0.18	0.16	0.13	0.11	0.10	0.09	0.08	0.07	0.05											
		14 TPI 16ER G55 AG55	0.22	1.20	9	0.22	0.19	0.17	0.15	0.13	0.12	0.10	0.08	0.07												
		12 TPI 16ER G55 AG55	0.22	1.64	12	0.24	0.22	0.20	0.18	0.15	0.12	0.12	0.09	0.07	0.05											
		11 TPI 16ER G55 AG55	0.22	1.60	12	0.24	0.22	0.20	0.18	0.16	0.14	0.13	0.10	0.08	0.06	0.05	0.04									
		10 TPI 16ER G55 AG55	0.22	1.78	13	0.24	0.22	0.20	0.18	0.17	0.16	0.15	0.13	0.12	0.09	0.07	0.05									
		9 TPI 16ER G55 AG55	0.22	2.01	14	0.24	0.22	0.20	0.19	0.18	0.16	0.15	0.14	0.12	0.11	0.10	0.09	0.08	0.05							
		8 TPI 16ER G55 AG55	0.22	2.29	15	0.28	0.26	0.24	0.22	0.19	0.16	0.14	0.13	0.12	0.12	0.11	0.10	0.09	0.08	0.05						
		7 TPI		2.43	16	0.30	0.27	0.25	0.22	0.20	0.18	0.16	0.14	0.12	0.11	0.10	0.10	0.09	0.08	0.06	0.05					
		6 TPI	22ER N55	2.92	18	0.30	0.27	0.25	0.23	0.22	0.20	0.18	0.17	0.16	0.15	0.14	0.13	0.12	0.11	0.10	0.08	0.06	0.05			
		5 TPI		3.60	21	0.30	0.28	0.27	0.26	0.25	0.24	0.22	0.20	0.19	0.18	0.17	0.16	0.15	0.14	0.13	0.11	0.10	0.08	0.06	0.05	0.07
	Internal thread	28 TPI 061R 081R 5501	0.10	0.65	13	0.07	0.07	0.06	0.06	0.06	0.05	0.05	0.05	0.04	0.04	0.04	0.03	0.03								
		19 TPI 081R 5501	0.10	0.81	15	0.07	0.07	0.07	0.07	0.06	0.06	0.06	0.06	0.05	0.05	0.05	0.04	0.04	0.03	0.03						
		24 TPI	111R A55	0.72	7	0.16	0.14	0.12	0.10	0.08	0.07	0.05														
		20 TPI		0.87	8	0.16	0.15	0.14	0.13	0.11	0.08	0.06	0.04													
		18 TPI		0.97	8	0.20	0.18	0.16	0.14	0.10	0.08	0.06	0.05													
		16 TPI		1.10	9	0.20	0.18	0.16	0.14	0.12	0.10	0.08	0.07	0.05												
		24 TPI	161R A55 AG55	0.06	0.72	7	0.16	0.14	0.12	0.10	0.08	0.07	0.05													
		20 TPI	161R A55 AG55	0.06	0.87	8	0.16	0.15	0.14	0.13	0.11	0.08	0.06	0.04												
		18 TPI	161R A55 AG55	0.06	0.97	8	0.20	0.18	0.16	0.14	0.10	0.08	0.06	0.05												
		16 TPI	161R A55 AG55	0.06	1.10	9	0.20	0.18	0.16	0.14	0.12	0.10	0.08	0.07	0.05											
		14 TPI	161R G55 AG55	0.22	1.06	8	0.21	0.19	0.17	0.15	0.12	0.10	0.07	0.05												
		12 TPI	161R G55 AG55	0.22	1.27	11	0.20	0.18	0.17	0.15	0.13	0.10	0.09	0.08	0.07	0.06	0.04									
		11 TPI	161R G55 AG55	0.22	1.42	10	0.24	0.22	0.20	0.18	0.15	0.12	0.10	0.09	0.07	0.05										
		10 TPI	161R G55 AG55	0.22	1.59	12	0.24	0.22	0.20	0.18	0.16	0.14	0.12	0.10	0.08	0.06	0.05	0.04								
9 TPI	161R G55 AG55	0.22	1.79	12	0.24	0.22	0.20	0.18	0.17	0.16	0.15	0.13	0.12	0.10	0.07	0.05										
8 TPI	161R G55 AG55	0.22	2.05	14	0.24	0.23	0.22	0.20	0.18	0.16	0.15	0.14	0.12	0.11	0.10	0.08	0.07	0.05								
7 TPI	221R N55	2.09	14	0.24	0.23	0.22	0.20	0.19	0.17	0.15	0.14	0.13	0.12	0.10	0.08	0.07	0.05									
6 TPI		2.53	16	0.30	0.28	0.25	0.23	0.21	0.20	0.18	0.16	0.13	0.11	0.10	0.10	0.09	0.08	0.06	0.05							
5 TPI		3.14	19	0.30	0.28	0.27	0.26	0.24	0.22	0.20	0.18	0.16	0.15	0.14	0.12	0.11	0.10	0.10	0.08	0.06	0.05					
30° trapezoidal	External thread	2.0 mm 16ER 200TR	-	1.25	10	0.22	0.20	0.17	0.16	0.13	0.12	0.10	0.07	0.05	0.03											
		3.0 mm 16ER 300TR	-	1.75	14	0.24	0.20	0.18	0.16	0.15	0.14	0.12	0.11	0.10	0.10	0.10	0.07	0.05	0.03							
		4.0 mm 22ER 400TR	-	2.24	15	0.26	0.23	0.22	0.20	0.20	0.18	0.16	0.15	0.14	0.13	0.12	0.10	0.07	0.05	0.03						
	Internal thread	5.0 mm 22ER 500TR	-	2.73	17	0.28	0.26	0.24	0.22	0.21	0.20	0.19	0.18	0.16	0.15	0.14	0.13	0.12	0.10	0.07	0.05	0.03				
		2.0 mm 161R 200TR	-	1.25	10	0.22	0.20	0.17	0.16	0.13	0.12	0.10	0.07	0.05	0.03											
		3.0 mm 161R 300TR	-	1.75	14	0.24	0.20	0.18	0.16	0.15	0.14	0.12	0.11	0.10	0.10	0.10	0.07	0.05	0.03							



Corner-R(RE) selection for partial profiling insert

Metric unified	External threading	Internal threading	Metric, Unified thread
	$RE \leq 0.1443TP$	$RE \leq 0.0720TP$	Corner-R(RE) at Internal threading is almost half of that of External
Parallel pipe (Whitworth) Tapered pipe	(For both external and Internal thread) $RE \leq 0.1373TP$		Parallel pipe, Tapered pipe, Whitworth thread Same Corner-R(RE) for both External and Internal threading

RE: Corner-R TP: Pitch (= $-\frac{25.4}{n}$) n: TPI

TT (60° / 55°, Partial profile) Part 1

(ap shows the value of radial ap)

Type	Pitch / TPI		Description	Corner-R (RE)	Total ap (mm)	No. of passes	1	2	3	4	5	6	7	8	9	10	11	12	13	14	15	16	17			
	mm	TPI																								
Metric (60°)	External thread	0.50 mm	TT32 ⁹ / _L 6000	0.00	0.38	6	0.10	0.10	0.07	0.05	0.04	0.02														
		0.70 mm	TT32 ⁹ / _L 6000	0.00	0.53	7	0.10	0.10	0.10	0.08	0.07	0.06	0.02													
		0.75 mm	TT32 ⁹ / _L 6000	0.00	0.57	8	0.10	0.10	0.10	0.08	0.08	0.05	0.04	0.02												
		0.80 mm	TT32 ⁹ / _L 6000	0.00	0.61	8	0.10	0.10	0.10	0.10	0.08	0.06	0.05	0.02												
		1.00 mm	TT32 ⁹ / _L 6000	0.00	0.76	8	0.15	0.12	0.12	0.11	0.10	0.08	0.06	0.02												
			TT32/43 ⁹ / _L 6001	0.10	0.66	6	0.20	0.15	0.12	0.10	0.07	0.02														
		1.25 mm	TT32 ⁹ / _L 6000	0.00	0.95	9	0.18	0.16	0.14	0.12	0.10	0.10	0.08	0.05	0.02											
			TT32/43 ⁹ / _L 6001	0.10	0.85	7	0.25	0.20	0.13	0.10	0.10	0.05	0.02													
		1.50 mm	TT32 ⁹ / _L 6000	0.00	1.14	10	0.20	0.18	0.16	0.14	0.12	0.10	0.10	0.07	0.05	0.02										
			TT32/43 ⁹ / _L 6001	0.10	1.04	9	0.25	0.18	0.14	0.12	0.10	0.10	0.08	0.05	0.02											
			6002	0.20	0.94	8	0.25	0.18	0.14	0.12	0.10	0.08	0.05	0.02												
		1.75 mm	TT32 ⁹ / _L 6000	0.00	1.33	11	0.25	0.23	0.20	0.13	0.10	0.10	0.10	0.08	0.07	0.05	0.02									
			TT32/43 ⁹ / _L 6001	0.10	1.23	10	0.25	0.23	0.20	0.13	0.10	0.10	0.08	0.07	0.05	0.02										
			6002	0.20	1.13	9	0.25	0.23	0.20	0.13	0.10	0.08	0.07	0.05	0.02											
		2.00 mm	TT32 ⁹ / _L 6000	0.00	1.52	12	0.25	0.23	0.20	0.16	0.13	0.10	0.10	0.10	0.10	0.08	0.05	0.02								
			TT32/43 ⁹ / _L 6001	0.10	1.42	11	0.25	0.23	0.20	0.16	0.13	0.10	0.10	0.10	0.08	0.05	0.02									
			6002	0.20	1.32	10	0.25	0.23	0.20	0.16	0.13	0.10	0.10	0.08	0.05	0.02										
		2.50 mm	TT32 ⁹ / _L 6000	0.00	1.89	13	0.27	0.25	0.20	0.18	0.17	0.15	0.14	0.14	0.13	0.10	0.08	0.06	0.02							
	TT32/43 ⁹ / _L 6001		0.10	1.79	12	0.27	0.25	0.20	0.18	0.17	0.15	0.14	0.13	0.12	0.10	0.06	0.02									
	6002		0.20	1.69	11	0.27	0.25	0.20	0.18	0.17	0.15	0.14	0.13	0.10	0.08	0.02										
	6003		0.30	1.59	11	0.27	0.25	0.20	0.18	0.17	0.15	0.12	0.10	0.08	0.05	0.02										
	3.00 mm	TT43 ⁹ / _L 6001	0.10	2.17	14	0.30	0.25	0.23	0.20	0.20	0.18	0.16	0.14	0.14	0.12	0.10	0.08	0.05	0.02							
		6002	0.20	2.07	13	0.30	0.25	0.23	0.20	0.20	0.18	0.15	0.14	0.13	0.12	0.10	0.05	0.02								
		6003	0.30	1.97	12	0.30	0.25	0.23	0.20	0.20	0.18	0.15	0.14	0.12	0.10	0.08	0.02									
		6004	0.40	1.87	12	0.30	0.25	0.23	0.20	0.20	0.18	0.14	0.12	0.10	0.08	0.05	0.02									
	3.50 mm	TT43 ⁹ / _L 6001	0.10	2.55	16	0.30	0.27	0.23	0.22	0.20	0.18	0.18	0.16	0.16	0.14	0.14	0.12	0.10	0.08	0.05	0.02					
		6002	0.20	2.45	15	0.30	0.27	0.23	0.22	0.20	0.18	0.18	0.16	0.16	0.14	0.14	0.10	0.10	0.10	0.05	0.02					
		6003	0.30	2.35	14	0.30	0.27	0.23	0.22	0.20	0.18	0.18	0.16	0.15	0.14	0.12	0.10	0.08	0.02							
		6004	0.40	2.25	14	0.30	0.27	0.23	0.22	0.20	0.18	0.18	0.16	0.14	0.12	0.10	0.08	0.05	0.02							
		6004	0.40	2.25	14	0.30	0.27	0.23	0.22	0.20	0.18	0.18	0.16	0.14	0.12	0.10	0.08	0.05	0.02							
	Internal thread	0.50 mm	TT32 ⁹ / _L 6000	0.00	0.32	5	0.12	0.08	0.06	0.04	0.02															
		0.70 mm	TT32 ⁹ / _L 6000	0.00	0.45	6	0.15	0.10	0.08	0.06	0.04	0.02														
		0.75 mm	TT32 ⁹ / _L 6000	0.00	0.49	6	0.15	0.12	0.08	0.07	0.05	0.02														
		0.80 mm	TT32 ⁹ / _L 6000	0.00	0.52	6	0.15	0.12	0.10	0.08	0.05	0.02														
		1.00 mm	TT32 ⁹ / _L 6000	0.00	0.65	7	0.15	0.14	0.12	0.10	0.08	0.04	0.02													
		1.25 mm	TT32 ⁹ / _L 6000	0.00	0.81	8	0.18	0.16	0.14	0.12	0.10	0.05	0.04	0.02												
1.50 mm		TT32 ⁹ / _L 6000	0.00	0.97	9	0.20	0.18	0.16	0.14	0.10	0.08	0.05	0.04	0.02												
		TT32/43 ⁹ / _L 6001	0.10	0.87	8	0.20	0.18	0.16	0.14	0.08	0.05	0.04	0.02													
1.75 mm		TT32 ⁹ / _L 6000	0.00	1.14	10	0.20	0.18	0.16	0.13	0.12	0.10	0.10	0.08	0.05	0.02											
		TT32/43 ⁹ / _L 6001	0.10	1.04	9	0.20	0.18	0.16	0.13	0.12	0.10	0.08	0.05	0.02												
2.00 mm		TT32 ⁹ / _L 6000	0.00	1.30	12	0.20	0.18	0.16	0.13	0.13	0.12	0.10	0.10	0.08	0.05	0.03	0.02									
		TT32/43 ⁹ / _L 6001	0.10	1.20	11	0.20	0.18	0.16	0.13	0.13	0.12	0.10	0.08	0.05	0.03	0.02										
2.50 mm		TT32 ⁹ / _L 6000	0.00	1.62	14	0.23	0.20	0.18	0.18	0.13	0.13	0.12	0.10	0.10	0.08	0.07	0.05	0.03	0.02							
		TT32/43 ⁹ / _L 6001	0.10	1.52	13	0.23	0.20	0.18	0.18	0.13	0.13	0.12	0.10	0.08	0.07	0.05	0.03	0.02								
3.00 mm		TT43 ⁹ / _L 6001	0.10	1.85	15	0.25	0.22	0.20	0.18	0.14	0.14	0.13	0.12	0.10	0.10	0.08	0.07	0.05	0.02							
		6002	0.20	1.75	14	0.25	0.22	0.20	0.18	0.14	0.14	0.13	0.12	0.10	0.08	0.07	0.05	0.05	0.02							
Parallel pipe / Tapered pipe (55°)		External thread	28TPI	TT32 ⁹ / _L 5501	0.10	0.61	5	0.20	0.18	0.15	0.06	0.02														
			19TPI	TT32/43 ⁹ / _L 5501	0.10	0.95	8	0.20	0.18	0.15	0.13	0.12	0.10	0.05	0.02											
	14TPI		TT32/43 ⁹ / _L 5501	0.10	1.34	10	0.25	0.22	0.20	0.16	0.14	0.12	0.10	0.08	0.05	0.02										
			5502	0.20	1.22	9	0.25	0.22	0.20	0.18	0.12	0.10	0.08	0.05	0.02											
	11TPI		TT32/43 ⁹ / _L 5501	0.10	1.73	13	0.25	0.22	0.22	0.20	0.18	0.14	0.12	0.10	0.10	0.08	0.05	0.05	0.02							
			5502	0.20	1.62	12	0.25	0.22	0.22	0.20	0.18	0.14	0.12	0.10	0.08	0.05	0.04	0.02								
	5503	0.30	1.50	11	0.25	0.22	0.20	0.18	0.16	0.14	0.12	0.10	0.07	0.04	0.02											
	Internal thread	28TPI	TT32/43 ⁹ / _L 5501	0.10	0.61	6	0.18	0.15	0.12	0.08	0.06	0.02														
		19TPI	TT32/43 ⁹ / _L 5501	0.10	0.95	7	0.20	0.18	0.16	0.14	0.12	0.10	0.05													
		14TPI	TT32/43 ⁹ / _L 5501	0.10	1.34	10	0.20	0.18	0.18	0.16	0.14	0.14	0.11	0.10	0.08	0.05										

TPGB (60°, Partial profile)

(ap shows the value of radial ap)

Type	Pitch / TPI	Description	Corner-R (RE)	Total ap (mm)	No. of passes	1	2	3	4	5	6	7	8	9	10	11	12	13	14	15	16	17																						
	mm / TPI																																											
Metric (60°)	Internal thread	0.75 mm	TPGB 1102005 1103005	0.05	0.44	5	0.15	0.12	0.10	0.05	0.02																																	
		0.80 mm	TPGB 1102005 1103005	0.05	0.47	5	0.15	0.14	0.10	0.06	0.02																																	
		1.00 mm	TPGB 1102005 1103005	0.05	0.60	6	0.18	0.14	0.12	0.10	0.04	0.02																																
		1.25 mm	TPGB 1102005 1103005	0.05	0.76	7	0.18	0.16	0.14	0.12	0.10	0.04	0.02																															
		1.50 mm	TPGB 1102005 1103005	0.05	0.92	8	0.20	0.18	0.16	0.14	0.10	0.08	0.04	0.02																														
		1.75 mm	TPGB 1102005 1103005	0.05	1.09	9	0.20	0.18	0.16	0.14	0.13	0.12	0.10	0.04	0.02																													
		2.00 mm	TPGB 1102005 1103005	0.05	1.25	11	0.20	0.18	0.16	0.14	0.13	0.12	0.10	0.10	0.06	0.04	0.02																											
		2.50 mm	TPGB 1102005 1103005	0.05	1.57	13	0.23	0.20	0.18	0.18	0.14	0.13	0.12	0.10	0.08	0.07	0.07	0.05	0.02																									
		3.00 mm	TPGB 1102005 1103005	0.05	1.90	15	0.25	0.22	0.20	0.18	0.14	0.14	0.13	0.12	0.12	0.10	0.08	0.08	0.07	0.05	0.02																							
		3.50 mm	TPGB 1102005 1103005	0.05	2.22	16	0.25	0.22	0.20	0.18	0.18	0.16	0.16	0.14	0.14	0.12	0.10	0.10	0.08	0.07	0.05	0.02																						

Guide for internal threading

For internal threading, pay extra attention to “stabilizing bore dia.” and “chip evacuation”.

1. “Stabilizing bore dia.”

Because small pitch Internal threading has small corner-R (RE), there is variation in the bore dia. which may greatly influence the tool life of an insert. In order to eliminate the variation in the bore dia., “0” Cutting (zero cutting) should be performed as the zero pass, before the first pass in threading. The bore dia. is cut with the specified dimension, and the first pass of threading becomes stable.

2. “Chip evacuation”

If machining process is continued when chips are tangled with a toolholder and other parts of the machine, it may cause damages to the insert. Therefore, please ensure that there are no tangled chips in the machine by the following method.

<When processing the first workpiece>

Set the program with the “single block”
Keep the threading starting point 50 mm~100 mm away from the side of workpiece, and confirm that coolant is flushing down the chips for each pass.

<When processing the second workpiece and later>

Ensure that chips are not tangled; then, start the continuous run.

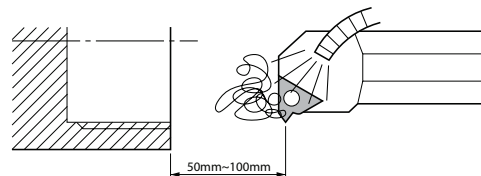

In applicable toolholder / insert lists on J58- J62, right-hand insert / right-hand toolholder descriptions are listed based on the previous TNN type inserts. For other applicable inserts / toolholders or stock availability of left-hand, see each relevant page and J64.

Parallel pipe [G(PF), Rp(PS)]

Nominal thread Symbol (Previous symbol)	TPI	External thread (G)			Internal thread (G, Rp)			Bore dia.	Same root's radius
		Toolholder	Insert		Toolholder	Insert			
	Partial profile		Full profile	Partial profile		Full profile			
G 1/16 (-)	28	KTNR ○○○○□-16 KTNSR ○○○○□-16 S ○○□-KTNL16	16ERA55-TF/TQ 16ERAG55-TF/TQ 16ERA55 16ERAG55	-	SINR0612S-06E (EZT ⚡ J40)	06IR5501	-	6.56	0.12
G 1/8 (PF 1/8)								8.57	
G 1/4 (PF 1/4)	19	KTNR ○○○○□-16 KTNSR ○○○○□-16 S ○○□-KTNL16	16ERA55-TF/TQ 16ERAG55-TF/TQ 16ERA55 16ERAG55	16ER19W-TF/TQ 16ER19W	SINR0816S-08E (EZT ⚡ J40)	08IR5501	-	11.45	0.18
G 3/8 (PF 3/8)								14.95	
G 1/2 (PF 1/2)	14	KTNR ○○○○□-16 KTNSR ○○○○□-16 S ○○□-KTNL16	16ERAG55-TF/TQ 16ERAG55-TF/TQ 16ERAG55 16ERAG55	16ER14W-TF/TQ 16ER14W	SINR1516S-11 SINR1616S-16	11IR55005	-	18.63	0.25
G 5/8 (PF 5/8)								20.59	
G 3/4 (PF 3/4)								24.12	
G 7/8 (PF 7/8)								27.88	
G 1 (PF 1)	11	KTNR ○○○○□-16 KTNSR ○○○○□-16 S ○○□-KTNL16	16ERAG55-TF/TQ 16ERAG55-TF/TQ 16ERAG55 16ERAG55	16ER11W-TF/TQ 16ER11W	SINR2420S-16	16IRAG55 16IRG55 16IR5501 16IR5502	16IR11W-TF/TQ 16IR11W	30.29	0.32
G 1 1/8 (PF 1 1/8)								34.94	
G 1 1/4 (PF 1 1/4)								38.95	
Hereafter, all the threads are 11 TPI and the root's radius 0.32. The same tool for G1 1/4 is recommended.									

Threading

Tapered pipe [R Rc(PT)(BSPT)]

Nominal thread Symbol (Previous symbol)	TPI	External thread (R)			Internal thread (Rc)			Bore dia.	Same root's radius
		Toolholder	Insert		Toolholder	Insert			
	Partial profile		Full profile	Partial profile		Full profile			
R 1/16, Rc 1/16 (-)	28	KTNR ○○○○□-16 KTNSR ○○○○□-16 S ○○□-KTNL16	(16ERA55-TF/TQ) (16ERAG55-TF/TQ) (16ERA55) (16ERAG55)	16ER28BSPT-TF/TQ 16ER28BSPT	SINR0612S-06E (EZT ⚡ J40)	06IR5501	-	0.12	
R 1/8, Rc 1/8 (PT 1/8)									
R 1/4, Rc 1/4 (PT 1/4)	19	KTNR ○○○○□-16 KTNSR ○○○○□-16 S ○○□-KTNL16	(16ERA55-TF/TQ) (16ERAG55-TF/TQ) (16ERA55) (16ERAG55)	16ER19BSPT-TF/TQ 16ER19BSPT	SINR0816S-08E (EZT ⚡ J40)	08IR5501	-	0.18	
R 3/8, Rc 3/8 (PT 3/8)									
R 1/2, Rc 1/2 (PT 1/2)	14	KTNR ○○○○□-16 KTNSR ○○○○□-16 S ○○□-KTNL16	(16ERAG55-TF/TQ) (16ERAG55-TF/TQ) (16ERAG55) (16ERAG55)	16ER14BSPT-TF/TQ 16ER14BSPT	SINR1516S-11 SINR1616S-16	(11IR55005)	11IR14BSPT-TF/TQ 11IR14BSPT	0.25	
R 3/4, Rc 3/4 (PT 3/4)									
R 1, Rc 1 (PT 1)									
R 1 1/4, Rc 1 1/4 (PT 1 1/4)	11	KTNR ○○○○□-16 KTNSR ○○○○□-16 S ○○□-KTNL16	(16ERAG55-TF/TQ) (16ERAG55-TF/TQ) (16ERAG55) (16ERAG55)	16ER11BSPT-TF/TQ 16ER11BSPT	SINR2420S-16	(16IRAG55) (16IRG55) (16IR5501) (16IR5502)	16IR11BSPT-TF/TQ 16IR11BSPT	0.32	
R 1 1/2, Rc 1 1/2 (PT 1 1/2)									
Hereafter, all the threads are 11 TPI and the root's radius 0.32. The same tool for R1 1/2 is recommended.					Hereafter, all the threads are 11 TPI and the root's radius 0.32. The same tool for Rc1 1/2 is recommended.				

1) The largest size of minimum diameter toolholder is recommended for Internal threading toolholders.

Therefore it is available if minimum diameter is smaller than recommended toolholders.

(e.g.) SINR2420S-16 (Min. Bore dia.: ø24mm) is recommended for the Tool of G7/8 Internal threading from the above table, but SINR2016S-16 can also be used.

2) When using "Partial profile" for Tapered pipe threading, thread's corners become sharp edged, and the shape will not be the same as the standard shape for Tapered pipe.

American national tapered pipe (NPT)

Nominal thread	TPI	External thread			Internal thread		
		Toolholder	Insert		Toolholder	Insert	
			Partial profile	Full profile		Partial profile	Full profile
1/16 NPT 1/8 NPT	27	KTTR ○○○○□-16 KTXR ○○○○□-16F	TT32R6000 TTX32R6000	-	No tools available		
1/4 NPT 3/8 NPT	18	KTNR ○○○○□-16 KTNSR ○○○○□-16 S○○□-KTNL16	-	16ER18NPT	EZH Sleeves J41	EZTR060050-60-004 EZTR070060-60-004	-
1/4 NPT 3/4 NPT	14	KTNR ○○○○□-16 KTNSR ○○○○□-16 S○○□-KTNL16	-	16ER14NPT	EZH Sleeves J41	EZTR070060-60-004	-
1/2 NPT 3/4 NPT	14	KTNR ○○○○□-16 KTNSR ○○○○□-16 S○○□-KTNL16	-	16ER14NPT	SINR1616S-16 SINR2016S-16	-	16IR14NPT
1 NPT 1 1/2 NPT 2 NPT	11.5	KTNR ○○○○□-16 KTNSR ○○○○□-16 S○○□-KTNL16	-	16ER11.5NPT	SINR2420S-16 CINR3025S-16 CINR3732S-16	-	16IR11.5NPT

• Application of NPTF thread
 NPTF is the thread for sealing pipes without using any sealing material.
 Thread symbol is similar to NPT but the tolerance is different from that of NPT, therefore the above inserts are not available for NPTF.

30° Trapezoidal (Tr)

The JIS Standard Trapezoidal Size to be machined by previous TNN Insert are shown.

Nominal thread	Pitch (mm)	External thread			Internal thread			Bore dia.		
		Toolholder	Insert		Toolholder	Insert				
			Partial profile	Full profile		Partial profile	Full profile			
Tr 16X2 Tr 18X2 Tr 20X2	2	No tools available			No tools available	-	-	14.00		
Tr 22X3 Tr 24X3 Tr 26X3	3	KTNR ○○○○□-16 KTNSR ○○○○□-16 S○○□-KTNL16	16ER200TR	-	SINR1616S-16	16IR200TR	-	16.00 18.00		
Tr 28X3 Tr 30X3 Tr 32X3 Tr 34X3 Tr 36X3 Tr 38X3 Tr 40X3	3				SINR2420S-16	16IR300TR	-	25.00 27.00 29.00		
Tr 42X3 Tr 44X3 Tr 46X3 Tr 48X3 Tr 50X3 Tr 52X3 Tr 55X3 Tr 60X3 Tr 65X3	3				CINR3025S-16	16IR300TR	-	31.00 33.00 35.00 37.00		
Tr 70X4 Tr 75X4 Tr 80X4 Tr 90X4 Tr 95X4 Tr 100X4 Tr 105X4 Tr 110X4	4				CINR3732S-16	16IR300TR	-	39.00 41.00 43.00 45.00 47.00 49.00 52.00 57.00 62.00		
					22ER400TR	-	CINR3732S-22	22IR400TR	-	66.00 71.00 76.00 86.00 91.00 96.00 101.00 106.00

• TM thread: TM thread (old JIS 30° trapezoidal thread) has been discontinued. But if the "Nominal dia. X pitch" is the same, the above Tr thread can be used.
 • TW thread: TW thread is 29° trapezoidal thread, therefore the above inserts are not available.



Threading

Metric coarse thread: M

Nominal thread	Pitch (mm)	Internal thread			
		Toolholder	Insert		Bore dia.
			Partial profile	Full profile	
M1	0.25 0.5	No tools available	-	-	0.73
M3			-	-	2.46
M4			EZTR030025-60-002	-	3.24
M5	0.8	-	EZTR040035-60-004	-	4.13
M6	1.0	-	VNTR045-11	-	4.92
M7	1.0	-	EZTR050040-60-004	-	5.92
M8	1.25	-	VNTR045-11	-	
			EZTR060050-60-004	-	
			VNTR060-11	-	
M9	1.25	-	SINR0612S-06E	06IR60005	7.65
			SINR0612S-06E	06IR60005	
M10	1.5	SINR0816S-08E	08IR60007	-	8.38
M11	1.5	-	-	-	9.38
M12	1.75	SINR0816S-08E	08IR60007	-	10.11
M16	2.0	SINR1216S-11E	-	11IR200ISO	13.84
M18	2.5	No tools available			15.29
M20	2.5	SINR1616S-16	Table 5	16IR250ISO-□□	17.29
M22	2.5	-	-	-	19.29
M24	3.0	SINR2016S-16	Table 4	16IR300ISO-□□	20.75
M27	3.0	-	-	-	23.75
M30	3.5	SINR2420S-22	-	22IR350ISO	26.21
M33	3.5	-	-	-	29.21
M36	4.0	CINR3025S-22	22IRN60	22IR400ISO	31.67
M39	4.0	-		22IR450ISO	34.67
M42	4.5	CINR3732S-22		22IR500ISO	37.13
M45	4.5	-		-	40.13
M48	5.0	CINR3732S-22		-	42.59
M52	5.0	-	-	-	46.59
M56	5.5	* Threading of M56 and over is not available due to too large pitch size.			50.05

Metric fine thread: M

Nominal thread	Pitch (mm)	Internal thread			
		Toolholder	Insert		Bore dia.
			Partial profile	Full profile	
M14x1.5	1.5	SINR1216S-11E	11IRA60	11IR150ISO-□□	12.38
M14x1.25	1.25		11IR60005	11IR125ISO-□□	12.65
M14x1.0	1.0		-	11IR100ISO-□□	12.92
M15x1.5	1.5	SINR1216S-11E	11IRA60	11IR150ISO-□□	13.38
M15x1.0	1.0		11IR60005	11IR100ISO-□□	13.92
M16x1.5	1.5	SINR1216S-11E	11IRA60	11IR150ISO-□□	14.38
M16x1.0	1.0		11IR60005	11IR100ISO-□□	14.92
M17x1.5	1.5	SINR1516S-11	11IRA60	11IR150ISO-□□	15.38
M17x1.0	1.0		11IR60005	11IR100ISO-□□	15.92
M18x2.0	2.0	SINR1516S-11	-	11IR200ISO	15.84
M18x1.5	1.5	SINR1616S-16	Table 2	16IR150ISO-□□	16.38
M18x1.0	1.0		Table 3	16IR100ISO-□□	16.92
M20x2.0	2.0	SINR1616S-16	Table 1	16IR200ISO-□□	17.84
M20x1.5	1.5		Table 2	16IR150ISO-□□	18.38
M20x1.0	1.0		Table 3	16IR100ISO-□□	18.92
M22x2.0	2.0	SINR1616S-16	Table 1	16IR200ISO-□□	19.84
M22x1.5	1.5		Table 2	16IR150ISO-□□	20.38
M22x1.0	1.0	SINR2016S-16	Table 3	16IR100ISO-□□	20.92
M24x2.0	2.0	SINR2016S-16	Table 1	16IR200ISO-□□	21.84
M24x1.5	1.5		Table 2	16IR150ISO-□□	22.38
M24x1.0	1.0		Table 3	16IR100ISO-□□	22.92
M25x2.0	2.0	SINR2016S-16	Table 1	16IR200ISO-□□	22.84
M25x1.5	1.5		Table 2	16IR150ISO-□□	23.38
M25x1.0	1.0		Table 3	16IR100ISO-□□	23.92
M26x1.5	1.5	SINR2420S-16	Table 2	16IR150ISO-□□	24.38
M27x2.0	2.0		Table 1	16IR200ISO-□□	24.84
M27x1.5	1.5	SINR2420S-16	Table 2	16IR150ISO-□□	25.38
M27x1.0	1.0		Table 3	16IR100ISO-□□	25.92
M28x2.0	2.0	SINR2420S-16	Table 1	16IR200ISO-□□	25.84
M28x1.5	1.5		Table 2	16IR150ISO-□□	26.38
M28x1.0	1.0		Table 3	16IR100ISO-□□	26.92
M30x3.0	3.0	SINR2420S-22	-	22IR300ISO	26.75
		SINR2420S-16	Table 4	16IR300ISO-□□	
M30x2.0	2.0	SINR2420S-16	Table 1	16IR200ISO-□□	27.84
M30x1.5	1.5		Table 2	16IR150ISO-□□	28.38
M30x1.0	1.0		Table 3	16IR100ISO-□□	28.92
M32x2.0	2.0		SINR2420S-16	Table 1	16IR200ISO-□□
M32x1.5	1.5	CINR3025S-16	Table 2	16IR150ISO-□□	30.38
M33x3.0	3.0	SINR2420S-22	-	22IR300ISO	29.75
		SINR2420S-16	Table 4	16IR300ISO-□□	
M33x2.0	2.0	CINR3025S-16	Table 1	16IR200ISO-□□	30.84
M33x1.5	1.5		Table 2	16IR150ISO-□□	31.38
M35x1.5	1.5	CINR3025S-16	Table 2	16IR150ISO-□□	33.38
M36x3.0	3.0	CINR3025S-22	-	22IR300ISO	32.75
			CINR3025S-16	Table 4	
M36x2.0	2.0	CINR3025S-16	Table 1	16IR200ISO-□□	33.84
M36x1.5	1.5		Table 2	16IR150ISO-□□	34.38
M38x1.5	1.5	CINR3025S-16	Table 2	16IR150ISO-□□	36.38
M39x3.0	3.0	CINR3025S-22	-	22IR300ISO	35.75
			CINR3025S-16	Table 4	
M39x2.0	2.0	CINR3025S-16	Table 1	16IR200ISO-□□	36.84
M39x1.5	1.5	CINR3732S-16	Table 2	16IR150ISO-□□	37.38
M40x3.0	3.0	CINR3025S-22	-	22IR300ISO	36.75
			CINR3025S-16	Table 4	
M40x2.0	2.0	CINR3732S-16	Table 1	16IR200ISO-□□	37.84
M40x1.5	1.5		Table 2	16IR150ISO-□□	38.38
M42x4.0	4.0	CINR3732S-22	22IRN60	22IR400ISO	37.67
M42x3.0	3.0	CINR3732S-16	-	22IR300ISO	38.75
			Table 4	16IR300ISO-□□	
M42x2.0	2.0	CINR3732S-16	Table 1	16IR200ISO-□□	39.84
M42x1.5	1.5	CINR3732S-16	Table 2	16IR150ISO-□□	40.38
M45x4.0	4.0	* Threading of M45 and over can be machined by the same tool for M42. (TP=4.0, 3.0, 2.0, 1.5)			40.67

Table 1 (TP=2.0 mm)	Table 2 (TP=1.5 mm)	Table 3 (TP=1.0 mm)
16IRG60 16IRAG60 16IR6001	16IRA60 16IRAG60 16IR6001	16IRA60 16IRAG60

Table 4 (TP=3.0 mm)	Table 5 (TP=2.5 mm)
16IRG60 16IRAG60	16IRG60 16IRAG60 16IR6001 16IR6001S

Metric fine thread: M

Nominal thread	Pitch (mm)	Internal thread				
		Toolholder	Insert		Bore dia.	
			Partial profile	Full profile		
M1x0.2	0.2	No tools available	-	-	0.78	
M3x0.35			-	-	2.62	
M3.5x0.35			EZTR030025-60-002	-	3.12	
M4.5x0.5	0.5	-	EZTR035030-60-002	-	3.96	
M5x0.5	0.5	-	-	-	4.46	
M6x0.75	0.75	-	VNTR045-11	-	5.19	
M7x0.75	0.75	-	EZTR050040-60-004	-	6.20	
		-	VNTR060-11	-		
M8x1.0	1.0	-	EZTR060050-60-004	-	6.92	
			VNTR060-11	-		
			SINR0612S-06E	06IR60005		-
M8x0.75	0.75	-	EZTR060050-60-004	-	7.19	
			VNTR060-11	-		
			SINR0612S-06E	06IR60005		-
M9x1.0	1.0	-	EZTR070060-60-004	-	7.92	
			VNTR060-11	-		
			SINR0612S-06E	06IR60005		-
			SINR0816S-08E	08IR60007		-
M9x0.75	0.75	-	EZTR070060-60-004	-	8.19	
			VNTR060-11	-		
M10x1.25	1.25	-	VNTR060-11	-	8.65	
			SINR0816S-08E	08IR60007		-
M10x1.0	1.0	-	VNTR060-11	-	8.92	
			SINR0816S-08E	08IR60007		-
			-	VNTR060-11		-
M10x0.75	0.75	-	SINR0612S-06E	06IR60005	9.19	
			-	VNTR060-11		-
M11x1.0	1.0	-	VNTR060-11	-	9.92	
			SINR0816S-08E	08IR60007		-
			-	VNTR060-11		-
M11x0.75	0.75	-	SINR0612S-06E	06IR60005	10.19	
M12x1.5	1.5	SINR0816S-08E	08IR60007	-	10.38	
M12x1.25	1.25				10.65	
M12x1.0	1.0				10.92	

Above shows the usage example of applicable toolholder / insert.



Unified coarse thread: UNC

Nominal thread	TPI	Internal thread			
		Toolholder	Insert		Bore dia.
			Partial profile	Full profile	
2-56 UNC	56	No tools available	-	-	1.69
6-32 UNC	32		-	-	2.65
8-32 UNC	32		-	-	3.31
10-24 UNC	24	-	EZTR030025-60-002	-	3.68
12-24 UNC	24	-	EZTR035030-60-002	-	4.34
1/4-20 UNC	20	-	EZTR040035-60-004	-	4.98
		-	EZTR050040-60-004	-	6.41
		-	VNTR045-11	-	7.81
5/16-18 UNC	18	-	EZTR060050-60-004	-	9.15
		-	VNTR060-11	-	10.58
3/8-16 UNC	16	-	EZTR070060-60-004	-	12.00
7/16-14 UNC	14	No tools available			13.38
1/2-13 UNC	13	No tools available			16.30
9/16-12 UNC	12	No tools available			19.17
5/8-11 UNC	11	No tools available			21.96
3/4-10 UNC	10	SINR1616S-16	16IRAG60	16IR10UN(-□□)	24.65
7/8-9 UNC	9	SINR2016S-16	16IRG60	-	27.82
1-8 UNC	8	SINR2016S-16	16IRG60	16IR08UN(-□□)	30.34
1 1/8-7 UNC	7	SINR2420S-22	22IRN60	-	33.52
1 1/4-7 UNC	7	SINR2420S-22		-	38.95
1 3/8-6 UNC	6	CINR3025S-22		-	44.69
1 1/2-6 UNC	6	CINR3025S-22	-		
1 3/4-5 UNC	5	CINR3732S-22	-		
2-4 1/2 UNC	4 1/2	* 2-4 1/2 UNC and over cannot be machined, because no inserts are available for the TPI.			

Unified extra fine thread: UNEF

Nominal thread	TPI	Internal thread				
		Toolholder	Insert		Bore dia.	
			Partial profile	Full profile		
12-32UNEF	32	-	EZTR035030-60-002	-	4.63	
1/4-32UNEF					5.49	
5/16-32UNEF					7.08	
3/8-32UNEF					8.67	
7/16-28UNEF	28	SINR0612S-06E	06IR60005	-	10.13	
1/2-28UNEF					11.72	
9/16-24UNEF	24	SINR1216S-11E	11IRA60	-	13.14	
5/8-24UNEF					14.73	
11/16-24UNEF		SINR1516S-11	11IR60005	-	16.32	
3/4-20UNEF	20	SINR1616S-16	16IRA60	16IRAG60	16IR24UN(-□□)	
13/16-20UNEF					17.68	
7/8-20UNEF		SINR2016S-16			16IR20UN(-□□)	19.26
15/16-20UNEF		20.85				
1-20UNEF					22.44	
1 1/16-18UNEF	18	SINR2416S-16	16IRA60	16IRAG60	24.03	
1 1/8-18UNEF					25.46	
1 3/16-18UNEF		27.05				
1 1/4-18UNEF		28.63				
1 5/16-18UNEF		30.22				
1 3/8-18UNEF		31.81				
1 7/16-18UNEF		33.40				
1 1/2-18UNEF		34.98				
1 9/16-18UNEF		36.57				
1 5/8-18UNEF		38.16				
1 11/16-18UNEF	CINR3732S-16	16IR18UN(-□□)	39.75			
			41.33			

Unified fine thread: UNF

Nominal thread	TPI	Internal thread			
		Toolholder	Insert		Bore dia.
			Partial profile	Full profile	
0-80 UNF	80	No tools available	-	-	1.18
6-40 UNF	40		-	-	2.82
8-36 UNF	36		-	-	3.40
10-32 UNF	32	-	EZTR030025-60-002	-	3.97
12-28 UNF	28	-	EZTR035030-60-002	-	4.50
1/4-28 UNF	28	-	EZTR040035-60-004	-	5.37
		-	EZTR050040-60-004	-	6.79
		-	VNTR045-11	-	8.38
5/16-24 UNF	24	-	EZTR060050-60-004	-	9.74
		-	VNTR060-11	-	11.33
		SINR0612S-06E	06IR60005	-	12.76
3/8-24 UNF	24	-	EZTR070060-60-004	-	14.35
		SINR0612S-06E	06IR60005	-	17.33
7/16-20 UNF	20	SINR0816S-08E	08IR60007	-	20.26
1/2-20 UNF	20	SINR0816S-08E	08IR60007	-	23.10
9/16-18 UNF	18	SINR1216S-11E	11IRA60	-	26.28
5/8-18 UNF					11IR60005
3/4-16 UNF	16	SINR1516S-11	11IRA60	-	32.63
		SINR1516S-11	11IR60005	-	36.81
7/8-14 UNF	14	SINR2016S-16	16IRAG60	16IR16UN(-□□)	
1-12 UNF	12	SINR2016S-16	16IRG60	16IR14UN(-□□)	
1 1/8-12 UNF	12	SINR2420S-16	16IRG60	16IR12UN(-□□)	23.10
1 1/4-12 UNF	12	SINR2420S-16	16IRG60		26.28
1 3/8-12 UNF	12	SINR2420S-16	16IRG001		29.46
1 1/2-12 UNF	12	CINR3025S-16	-	-	32.63
					36.81



Whitworth coarse thread: W

Nominal thread	TPI	Internal thread			Bore dia.
		Toolholder	Insert		
			Partial profile	Full profile	
W 1/4	20	No tools available	-	-	4.91
W 5/16	18		-	-	6.34
W 3/8	16	No tools available	-	-	7.73
W 7/16	14		-	-	9.06
W 1/2	12		-	-	10.30
W 9/16	12		-	-	11.89
W 5/8	11		-	-	13.26
W 3/4	10		-	-	16.17
W 7/8	9	SINR1616S-16	16IRAG55	-	19.03
W 1	8	SINR2016S-16	16IRG55	-	21.80
W 1 1/8	7	SINR2420S-22	22IRN55	-	24.47
W 1 1/4		-	-	-	27.64
W 1 3/8	6	CINR3025S-22	22IRN55	-	30.13
W 1 1/2					33.30
W 1 5/8	5	-	-	-	35.52
W 1 3/4	5	CINR3732S-22	22IRN55	-	38.69
W 1 7/8	4 1/2	No tools available	-	-	41.23
W 2					44.41
W 2 1/4	4	-	-	-	49.96



Whitworth fine thread: W

Nominal thread	TPI	Internal thread			Bore dia.				
		Toolholder	Insert						
			Partial profile	Full profile					
W9.5 TPI 24	24	SINR0816S-08E	08IR5501	-	8.30				
W10 TPI 24		-	EZTR060050-55-008		8.80				
W10.5 TPI 24		-	-		9.30				
W9.5 TPI 20	20	SINR0816S-08E	08IR5501	-	8.06				
W10 TPI 20		-	-		8.56				
W10.5 TPI 20		-	-		9.06				
W11 TPI 20		-	EZTR060050-55-008		9.56				
W11.5 TPI 20		-	EZTR080070-55-008		10.06				
W12 TPI 20		-	-		10.56				
W12.5 TPI 20		-	-		11.06				
W13 TPI 20	-	-	11.56						
W13.5 TPI 20	20	SINR1216S-11E	11IRA55 11IR55005	-	12.06				
W11 TPI 18	18	No tools available			9.40				
W11.5 TPI 18		-			9.90				
W12 TPI 18		-			10.40				
W12.5 TPI 18		-			10.90				
W14 TPI 18		-			12.40				
W14.5 TPI 18	18	SINR1216S-11E	11IRA55 11IR55005	-	12.90				
W15 TPI 18		-	-	13.40					
W16 TPI 18		-	-	14.40					
W13 TPI 16	16	No tools available			11.20				
W13.5 TPI 16		-			11.70				
W14 TPI 16	16	SINR1216S-11E	11IRA55 11IR55005	-	12.20				
W14.5 TPI 16		-	-	12.70					
W15 TPI 16		-	-	13.20					
W17 TPI 16	16	SINR1516S-11	-	-	15.20				
W18 TPI 16	16	SINR1616S-16	16IRAG55	(16IR16W-□□)	16.20				
W19 TPI 16			16IRG55		17.20				
W20 TPI 16			16IR5501 16IR5502		18.20				
W16 TPI 14	14	SINR1216S-11E	11IRA55	-	13.94				
W17 TPI 14		-	11IR55005		14.94				
W18 TPI 14	14	SINR1516S-11	-	-	15.94				
W21 TPI 14	14	SINR1616S-16	16IRAG55	(16IR14W-□□)	18.94				
W22 TPI 14					19.94				
W23 TPI 14	14	SINR2016S-16	16IRAG55	(16IR14W-□□)	20.94				
W24 TPI 14			16IRG55		21.94				
W25 TPI 14			16IR5501		22.94				
W26 TPI 14			16IR5502		23.94				
W19 TPI 12			12		SINR1616S-16	16IRAG55 16IRG55 16IR5501 16IR5502	-	16.60	
W20 TPI 12	17.60								
W21 TPI 12	18.60								
W22 TPI 12	19.60								
W28 TPI 12	12	SINR2420S-16		-				25.60	
W30 TPI 12		27.60							
W32 TPI 12	12	CINR3025S-16		16IRAG55 16IRG55 16IR5501 16IR5502				-	29.60
W34 TPI 12									31.60
W35 TPI 12									32.60
W36 TPI 12									33.60
W38 TPI 12									35.60
W40 TPI 12									12
W42 TPI 12			39.60						
W44 TPI 12	41.60								
W45 TPI 12	42.60								
W46 TPI 12	43.60								
W48 TPI 12	45.60								
W50 TPI 12	47.60								
.				
.				
.				
W23 TPI 10	10	SINR2016S-16	16IRAG55	-	20.12				
W24 TPI 10					21.12				
W25 TPI 10					22.12				
W26 TPI 10					23.12				
W28 TPI 9	9	SINR2420S-16	16IRAG55	-	24.80				
W30 TPI 9					26.80				
W32 TPI 9					28.80				
W34 TPI 8	8	CINR3025S-16	-	-	30.40				
W35 TPI 8					31.40				
W36 TPI 8					32.40				
W38 TPI 8					34.40				
W40 TPI 8					36.40				
W42 TPI 8					38.40				
W44 TPI 7	7	CINR3732S-22	22IRN55	-	39.89				
W45 TPI 7					40.89				
W46 TPI 7					41.89				
W48 TPI 7					43.89				
W50 TPI 7					45.89				
W52 TPI 7	47.89								
W55 TPI 6	6	CINR3732S-22	22IRN55	-	50.20				
W58 TPI 6					53.20				
W60 TPI 6					55.20				
W62 TPI 6					57.20				
.					.				
W72 TPI 6	67.20								
W75 TPI 5	5	CINR3732S-22	22IRN55	-	69.24				
.					.				
.					.				
W105 TPI 5	4	-	-	-	99.24				
W110 TPI 4					No tools available	-	-	102.8	
.								.	
.				

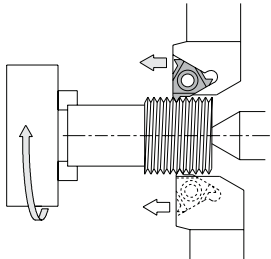
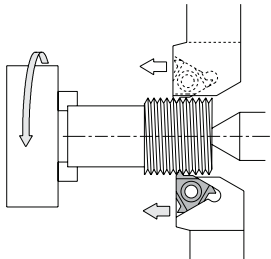
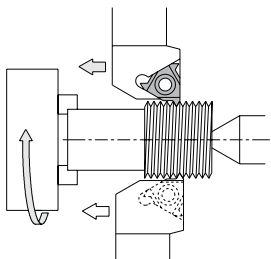
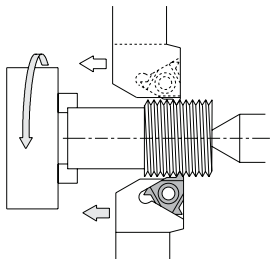
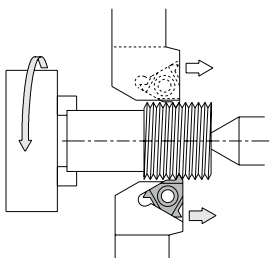
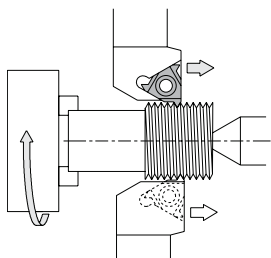
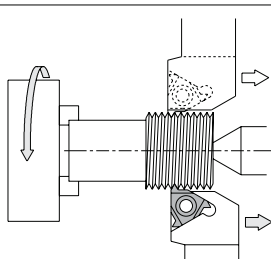
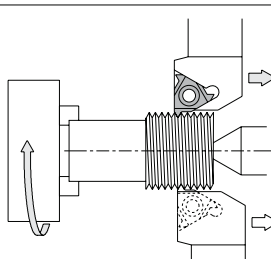
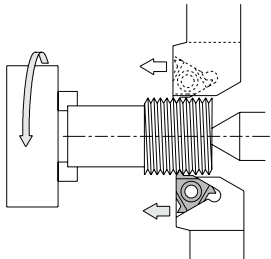
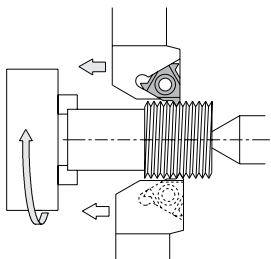
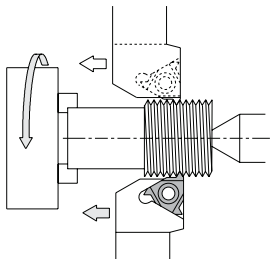
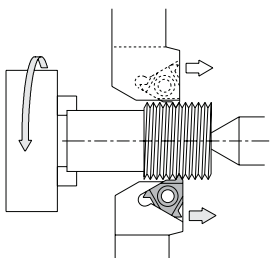
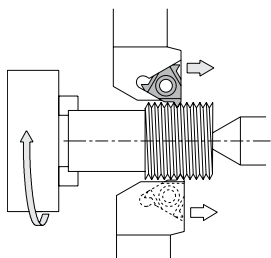
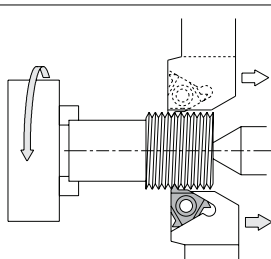
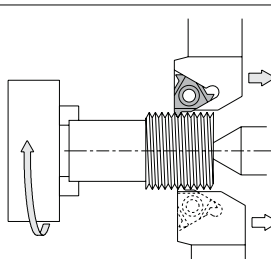

Threading

External threading (Left-hand thread / Right-hand thread)

		External thread													
Left-hand thread	Left-hand thread	<table border="1"> <tr><th>Toolholder</th><td>Left-hand</td></tr> <tr><th>Insert</th><td>Left-hand</td></tr> <tr><th>The direction of spindle revolution</th><td>M04</td></tr> </table> 	Toolholder	Left-hand	Insert	Left-hand	The direction of spindle revolution	M04	<table border="1"> <tr><th>Toolholder</th><td>Right-hand</td></tr> <tr><th>Insert</th><td>Right-hand</td></tr> <tr><th>The direction of spindle revolution</th><td>M03</td></tr> </table> 	Toolholder	Right-hand	Insert	Right-hand	The direction of spindle revolution	M03
		Toolholder	Left-hand												
		Insert	Left-hand												
		The direction of spindle revolution	M04												
	Toolholder	Right-hand													
	Insert	Right-hand													
	The direction of spindle revolution	M03													
	<table border="1"> <tr><th>Toolholder</th><td>Right-hand</td></tr> <tr><th>Insert</th><td>Right-hand</td></tr> <tr><th>The direction of spindle revolution</th><td>M04</td></tr> </table> 	Toolholder	Right-hand	Insert	Right-hand	The direction of spindle revolution	M04	<table border="1"> <tr><th>Toolholder</th><td>Left-hand</td></tr> <tr><th>Insert</th><td>Left-hand</td></tr> <tr><th>The direction of spindle revolution</th><td>M03</td></tr> </table> 	Toolholder	Left-hand	Insert	Left-hand	The direction of spindle revolution	M03	
Toolholder	Right-hand														
Insert	Right-hand														
The direction of spindle revolution	M04														
Toolholder	Left-hand														
Insert	Left-hand														
The direction of spindle revolution	M03														
<table border="1"> <tr><th>Toolholder</th><td>Left-hand</td></tr> <tr><th>Insert</th><td>Left-hand</td></tr> <tr><th>The direction of spindle revolution</th><td>M03</td></tr> </table> 	Toolholder	Left-hand	Insert	Left-hand	The direction of spindle revolution	M03	<table border="1"> <tr><th>Toolholder</th><td>Right-hand</td></tr> <tr><th>Insert</th><td>Right-hand</td></tr> <tr><th>The direction of spindle revolution</th><td>M04</td></tr> </table> 	Toolholder	Right-hand	Insert	Right-hand	The direction of spindle revolution	M04		
Toolholder	Left-hand														
Insert	Left-hand														
The direction of spindle revolution	M03														
Toolholder	Right-hand														
Insert	Right-hand														
The direction of spindle revolution	M04														
<table border="1"> <tr><th>Toolholder</th><td>Right-hand</td></tr> <tr><th>Insert</th><td>Right-hand</td></tr> <tr><th>The direction of spindle revolution</th><td>M03</td></tr> </table> 	Toolholder	Right-hand	Insert	Right-hand	The direction of spindle revolution	M03	<table border="1"> <tr><th>Toolholder</th><td>Left-hand</td></tr> <tr><th>Insert</th><td>Left-hand</td></tr> <tr><th>The direction of spindle revolution</th><td>M04</td></tr> </table> 	Toolholder	Left-hand	Insert	Left-hand	The direction of spindle revolution	M04		
Toolholder	Right-hand														
Insert	Right-hand														
The direction of spindle revolution	M03														
Toolholder	Left-hand														
Insert	Left-hand														
The direction of spindle revolution	M04														
Right-hand thread	<table border="1"> <tr><th>Toolholder</th><td>Right-hand</td></tr> <tr><th>Insert</th><td>Right-hand</td></tr> <tr><th>The direction of spindle revolution</th><td>M03</td></tr> </table> 	Toolholder	Right-hand	Insert	Right-hand	The direction of spindle revolution	M03	<table border="1"> <tr><th>Toolholder</th><td>Left-hand</td></tr> <tr><th>Insert</th><td>Left-hand</td></tr> <tr><th>The direction of spindle revolution</th><td>M04</td></tr> </table> 	Toolholder	Left-hand	Insert	Left-hand	The direction of spindle revolution	M04	
	Toolholder	Right-hand													
	Insert	Right-hand													
	The direction of spindle revolution	M03													
Toolholder	Left-hand														
Insert	Left-hand														
The direction of spindle revolution	M04														
<table border="1"> <tr><th>Toolholder</th><td>Left-hand</td></tr> <tr><th>Insert</th><td>Left-hand</td></tr> <tr><th>The direction of spindle revolution</th><td>M04</td></tr> </table> 	Toolholder	Left-hand	Insert	Left-hand	The direction of spindle revolution	M04	<table border="1"> <tr><th>Toolholder</th><td>Right-hand</td></tr> <tr><th>Insert</th><td>Right-hand</td></tr> <tr><th>The direction of spindle revolution</th><td>M03</td></tr> </table> 	Toolholder	Right-hand	Insert	Right-hand	The direction of spindle revolution	M03		
Toolholder	Left-hand														
Insert	Left-hand														
The direction of spindle revolution	M04														
Toolholder	Right-hand														
Insert	Right-hand														
The direction of spindle revolution	M03														
<table border="1"> <tr><th>Toolholder</th><td>Right-hand</td></tr> <tr><th>Insert</th><td>Right-hand</td></tr> <tr><th>The direction of spindle revolution</th><td>M04</td></tr> </table> 	Toolholder	Right-hand	Insert	Right-hand	The direction of spindle revolution	M04	<table border="1"> <tr><th>Toolholder</th><td>Left-hand</td></tr> <tr><th>Insert</th><td>Left-hand</td></tr> <tr><th>The direction of spindle revolution</th><td>M03</td></tr> </table> 	Toolholder	Left-hand	Insert	Left-hand	The direction of spindle revolution	M03		
Toolholder	Right-hand														
Insert	Right-hand														
The direction of spindle revolution	M04														
Toolholder	Left-hand														
Insert	Left-hand														
The direction of spindle revolution	M03														
<table border="1"> <tr><th>Toolholder</th><td>Left-hand</td></tr> <tr><th>Insert</th><td>Left-hand</td></tr> <tr><th>The direction of spindle revolution</th><td>M03</td></tr> </table> 	Toolholder	Left-hand	Insert	Left-hand	The direction of spindle revolution	M03	<table border="1"> <tr><th>Toolholder</th><td>Right-hand</td></tr> <tr><th>Insert</th><td>Right-hand</td></tr> <tr><th>The direction of spindle revolution</th><td>M04</td></tr> </table> 	Toolholder	Right-hand	Insert	Right-hand	The direction of spindle revolution	M04		
Toolholder	Left-hand														
Insert	Left-hand														
The direction of spindle revolution	M03														
Toolholder	Right-hand														
Insert	Right-hand														
The direction of spindle revolution	M04														

* These tables are based on KTN / KTNS / KTT / KTTX toolholder.

Internal threading (Left-hand thread / Right-hand thread)

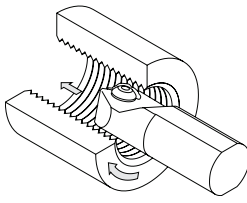
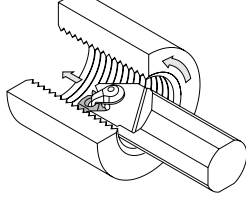
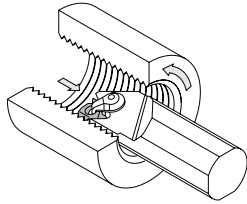
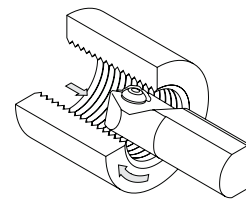
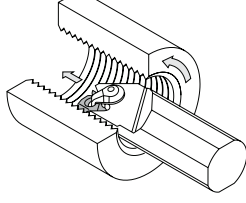
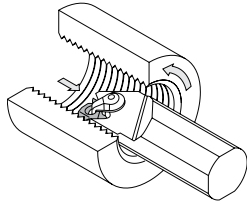
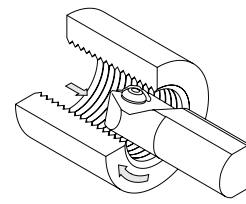
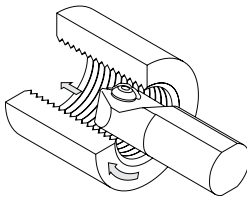
		Internal thread													
Left-hand thread	Left-hand thread	<table border="1"> <tr><th>Toolholder</th><td>Left-hand</td></tr> <tr><th>Insert</th><td>Left-hand</td></tr> <tr><th>The direction of spindle revolution</th><td>M04</td></tr> </table> 	Toolholder	Left-hand	Insert	Left-hand	The direction of spindle revolution	M04	<table border="1"> <tr><th>Toolholder</th><td>Right-hand</td></tr> <tr><th>Insert</th><td>Right-hand</td></tr> <tr><th>The direction of spindle revolution</th><td>M03</td></tr> </table> 	Toolholder	Right-hand	Insert	Right-hand	The direction of spindle revolution	M03
		Toolholder	Left-hand												
	Insert	Left-hand													
	The direction of spindle revolution	M04													
Toolholder	Right-hand														
Insert	Right-hand														
The direction of spindle revolution	M03														
<table border="1"> <tr><th>Toolholder</th><td>Right-hand</td></tr> <tr><th>Insert</th><td>Right-hand</td></tr> <tr><th>The direction of spindle revolution</th><td>M03</td></tr> </table> 	Toolholder	Right-hand	Insert	Right-hand	The direction of spindle revolution	M03	<table border="1"> <tr><th>Toolholder</th><td>Left-hand</td></tr> <tr><th>Insert</th><td>Left-hand</td></tr> <tr><th>The direction of spindle revolution</th><td>M04</td></tr> </table> 	Toolholder	Left-hand	Insert	Left-hand	The direction of spindle revolution	M04		
Toolholder	Right-hand														
Insert	Right-hand														
The direction of spindle revolution	M03														
Toolholder	Left-hand														
Insert	Left-hand														
The direction of spindle revolution	M04														
Right-hand thread	<table border="1"> <tr><th>Toolholder</th><td>Right-hand</td></tr> <tr><th>Insert</th><td>Right-hand</td></tr> <tr><th>The direction of spindle revolution</th><td>M04</td></tr> </table> 	Toolholder	Right-hand	Insert	Right-hand	The direction of spindle revolution	M04	<table border="1"> <tr><th>Toolholder</th><td>Left-hand</td></tr> <tr><th>Insert</th><td>Left-hand</td></tr> <tr><th>The direction of spindle revolution</th><td>M03</td></tr> </table> 	Toolholder	Left-hand	Insert	Left-hand	The direction of spindle revolution	M03	
	Toolholder	Right-hand													
Insert	Right-hand														
The direction of spindle revolution	M04														
Toolholder	Left-hand														
Insert	Left-hand														
The direction of spindle revolution	M03														
<table border="1"> <tr><th>Toolholder</th><td>Left-hand</td></tr> <tr><th>Insert</th><td>Left-hand</td></tr> <tr><th>The direction of spindle revolution</th><td>M03</td></tr> </table> 	Toolholder	Left-hand	Insert	Left-hand	The direction of spindle revolution	M03	<table border="1"> <tr><th>Toolholder</th><td>Right-hand</td></tr> <tr><th>Insert</th><td>Right-hand</td></tr> <tr><th>The direction of spindle revolution</th><td>M04</td></tr> </table> 	Toolholder	Right-hand	Insert	Right-hand	The direction of spindle revolution	M04		
Toolholder	Left-hand														
Insert	Left-hand														
The direction of spindle revolution	M03														
Toolholder	Right-hand														
Insert	Right-hand														
The direction of spindle revolution	M04														

* These tables are based on SIN / CIN toolholder.

For KITG (for large Internal threading), left-hand insert for right-hand toolholder, right-hand insert for left-hand toolholder.

Infeed methods

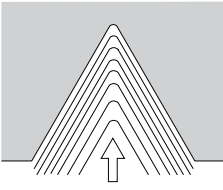
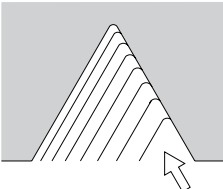
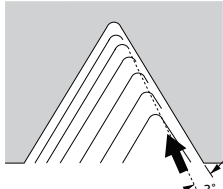
Infeed methods	Features
 <p>Radial infeed</p>	<ul style="list-style-type: none"> • The most common threading method. The cutting edge moves toward the center of the workpiece every pass. • Suitable for relatively small pitch size threading. • V-shape chips are generated and chip control may be difficult depending on workpiece material.
 <p>Flank infeed</p>	<ul style="list-style-type: none"> • Suitable for large pitch size threading. • The wear on the right side edge of the figure (no ap) tends to become greater. • Chips flow to one side.
 <p>Flank compound infeed</p>	<ul style="list-style-type: none"> • Revised compound methods of the above flank infeed method. • No "no ap." condition. • Chips flow to one side.

Lead angle of thread

Thread's lead angle β as shown in Fig. 1 decides from the workpiece diameter "D" (Pitch dia.) And the lead "L" (In case of single-start thread, it is the same as pitch "TP"). By rolling a right-angled triangle around a cylinder and the angle ACB in Fig. 2 becomes the lead angle β . The calculation formula is shown as follows.

$$\tan\beta = \frac{L}{\pi D} = \frac{nTP}{\pi D}$$

β : Lead angle D: Pitch dia. n: Number of thread TP: Pitch
L: Lead (In case of single-start thread, it is equal to TP. In case of n-start thread, it is equal to n x TP.)

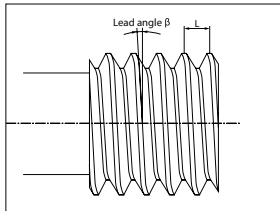

Fig. 1

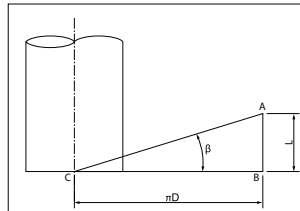

Fig. 2

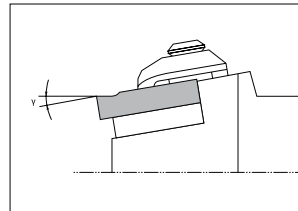

Fig. 3

Relief angle of thread

Against this lead angle, the threading insert requires side relief angle α . Negative type threading insert has no relief angle. When installing the negative type insert in the toolholder, the edge inclination angle γ (Fig. 3) is set, and at the same time front relief angle as well as side relief angle are generated to the insert. Side relief angle is described by the following formula. (Fig. 4)

$$\tan\alpha = \tan\gamma \times \tan\left(\frac{\theta}{2}\right)$$

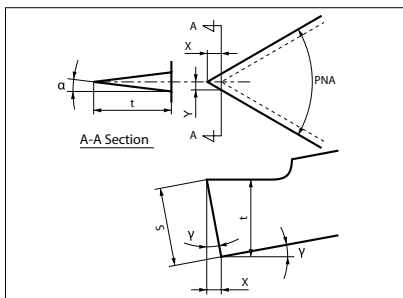

Fig. 4

Symbol	e.g.)
α : Side relief angle	
γ : Inclination angle after installing insert	External insert: 10° Internal insert: 15°
PNA: Insert's thread angle	Metric: 60° Tapered pipe: 55° 30° trapezoidal: 30°
S: Insert thickness	

$$\begin{cases} X = S \cdot \sin\gamma \\ Y = X \cdot \tan(\theta/2) = t \cdot \tan\alpha \\ t = S \cdot \cos\gamma \end{cases}$$

Table 1

Inserts	Side relief angle α	
	External	Internal
60° thread (M, UN, NPT)	5° 49'	8° 47'
55° thread (W, G, PT)	5° 14'	7° 56'
30° trapezoidal (Tr)	2° 43'	5° 7'

Ref. to Table 1 for the side relief angle depending on the insert type.

However, the side relief angle is set for 1° in the traveling direction by the toolholder itself, so that the actual side relief angle becomes $\alpha+1^\circ$.

Thread types & basic profile / Applicable toolholders & inserts

	Basic profile	Symbol (Previous symbol)	Type	Applicable inserts	Applicable toolholders
Metric		M e.g.) M30	External	○○E%○○○ISO(-TF/TQ) ○○ER□□60(-TF/TQ) 16ER60○○	KTN%○○○○□-○○ KTNSR○○○○□-16 S○○□-KTNL16
			Internal	TT43E%○○○M TT○○%60○○	KTT%○○○○□-○○ KTTXR○○○○□-16F, S○○□-KTTXL16
			External	○○%○○○ISO(-TF/TQ) ○○IR□□60 ○○IR60○○(○)	SIN%○○○○S-○○(E) CIN%○○○○S-○○
			Internal	TT○○%r60○○ TPGB11○○○○(○)	KITG%○○○○T-○○ S○○□-STWP%11-○○(E)
Unified		UN UNC UNF UNEF e.g.) ¾ -16 UNF	External	○○ER○○UN(-TF/TQ) ○○ER□□60(-TF/TQ) 16ER60○○	KTNR○○○○□-○○ KTNSR○○○○□-16 S○○□-KTNL16
			Internal	TT○○%r60○○ TPGB11○○○○(○)	KTT%○○○○□-○○ KTTXR○○○○□-16F, S○○□-KTTXL16
			External	○○IR○○UN(-TF/TQ) ○○IR□□60 ○○IR60○○(○)	SINR○○○○S-○○(E) CINR○○○○S-○○
			Internal	TT○○%r60○○ TPGB11○○○○(○)	KITG%○○○○T-○○ S○○□-STWP%11-○○(E)
Parallel pipe		External: G(PF) Internal: G(PF) Rp(PS) e.g.) G ¾ (PF ¾)	External	○○ER○○W(-TF/TQ) ○○ER□□55 16ER55○○	KTNR○○○○□-○○ KTNSR○○○○□-16 S○○□-KTNL16
			Internal	TT○○%r55○○ TPGB11○○○○(○)	KTT%○○○○□-○○ KTTXR○○○○□-16F, S○○□-KTTXL16
			External	○○IR○○W(-TF/TQ) ○○IR□□55 ○○IR55○○(○)	SINR○○○○S-○○(E) CINR○○○○S-○○
			Internal	TT○○%r55○○ TPGB11○○○○(○)	KITG%○○○○T-○○ S○○□-STWP%11-○○(E)
Whitworth		W e.g.) W ¾	External	○○ER○○W(-TF/TQ) ○○ER□□55 16ER55○○	KTNR○○○○□-○○ KTNSR○○○○□-16 S○○□-KTNL16
			Internal	TT○○%r55○○ TPGB11○○○○(○)	KTT%○○○○□-○○ KTTXR○○○○□-16F, S○○□-KTTXL16
			External	○○IR○○W(-TF/TQ) ○○IR□□55 ○○IR55○○(○)	SINR○○○○S-○○(E) CINR○○○○S-○○
			Internal	TT○○%r55○○ TPGB11○○○○(○)	KITG%○○○○T-○○ S○○□-STWP%11-○○(E)
Tapered pipe		External: R(PT) (BSPT) Internal: Rc(PT) (BSPT) e.g.) R ½ (PT ½)	External	16ER○○BSPT(-TF/TQ)	KTNR○○○○□-○○ KTNSR○○○○□-16 S○○□-KTNL16
			Internal	TT○○%r55○○* TPGB11○○○○(○)	KTT%○○○○□-○○ KTTXR○○○○□-16F, S○○□-KTTXL16
			External	○○IR○○BSPT(-TF/TQ)	SINR○○○○S-○○(E) CINR○○○○S-○○
			Internal	TT○○%r55○○* TPGB11○○○○(○)	KITG%○○○○T-○○ S○○□-STWP%11-○○(E)
American national tapered pipe		NPT e.g.) ¾ -18 NPT	External	16ER○○(○)NPT	KTNR○○○○□-○○ KTNSR○○○○□-16 S○○□-KTNL16
			Internal	16IR○○(○)NPT	SINR○○○○S-○○ CINR○○○○S-○○
30° Trapezoidal		Tr e.g.) Tr 26x3	External	○○ER○○TR	KTNR○○○○□-○○ KTNSR○○○○□-16 S○○□-KTNL16
			Internal	○○IR○○TR	SINR○○○○S-○○ CINR○○○○S-○○

Above shows the usage example of applicable Toolholder / Insert.





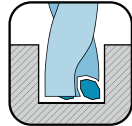



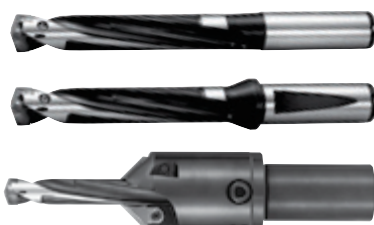

* For the case when the thread root's corner-R(RE) can be smaller than the standard.

K

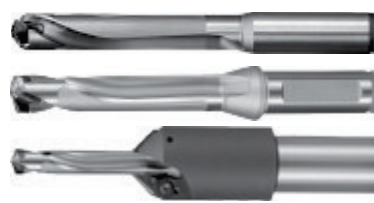

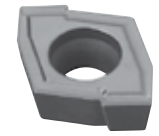
Introduction		K2
MagicDrill DRA		K4
Applicable inserts	DRA insert (GM - General purpose)	K6
	DRA insert (KM - Cast iron)	K10
	DRA insert (FTP - Counterboring)	K12
	DRA insert (HQP - Precision / for Carbon steel)	K14
	DRA insert (HQS - For difficult-to-cut materials/stainless steel)	K17
Straight shank SS	SS-DRA 1.5 DC	K18
	SS-DRA 3 DC	K19
	SS-DRA 5 DC	K20
	SS-DRA 8 DC	K21
Chamfering attachment for SS-DRA	CHV-DRA	K23
Flanged shank SF	SF-DRA 1.5 DC	K24
	SF-DRA 3 DC	K25
	SF-DRA 5 DC	K26
	SF-DRA 8 DC	K27
	SF-DRA 12 DC	K28
MagicDrill DRC		K34
MagicDrill DRV		K50
Applicable inserts	LCMT (outer edge)	K52
	SCMT (outer edge)	K53
	LCMT (inner edge)	K54
	SCMT (inner edge)	K55
Toolholder DRV	DRV 2 DC	K56
	DRV 3 DC	K58
	DRV 4 DC	K60
	DRV 5 DC	K62
	DRV 6 DC	K64
Chamfering attachment for DRV	CHV-DRV	K68
Adjustable sleeve (DRV/DRZ/DRXR)		K72
SHE type	SHE	K72
Lathe installation	(DRZ / DRXR)	K88
MagicDrill DRXR		K90
Applicable inserts	ZXMT	K90
Toolholder DRXR	DRXR 2 DC	K92
	DRXR 3 DC	K93
	DRXR 4 DC	K95
	DRXR 5 DC	K97
MagicDrill DRW for bigger diameter (ø60 ~ø100 mm and more)		K100

Product lineup

Type	Shape	Drill dia. Drilling depth)	Cutting edge	Remarks				
DRA K4	 Screw clamp	$\phi 7.94 \sim \phi 25.50$ (1.5D) $\phi 7.94 \sim \phi 33.0$ (3D/5D/8D) $\phi 12 \sim \phi 25.5$ (12D)	Module type with double edges 	Lineup  SS-DRA SF-DRA Chamfering attachment				
				DRC K34	 Self-clamping	$\phi 7.94 \sim \phi 25.99$ (3D/5D/8D)	Module type with double edges 	Lineup  SS-DRC SF-DRC Chamfering attachment
								DRV K50
DRZ K76	 DRZ	$\phi 13 \sim \phi 59$ (2D/3D) $\phi 13 \sim \phi 50$ (4D) $\phi 27 \sim \phi 50$ (5D)	Inner & outer edges on one insert 	Chip shape (Workpiece material: C50) drill dia. $\phi 23$ Chip from outer edge  Chip from inner edge 				
				DRZ-CR [Cartridge type] (Made to order) K85	 DRZ-CR	$\phi 60 \sim$ (2D/3D/4D)		

K

 Drilling

Caution

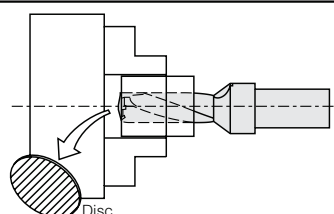

When drilling through the workpiece, a disk may be ejected.
 Proper machine guarding is necessary to prevent injury.
 The safety cover is necessary for the conventional lathe machines
 to prevent any accidents.

Type	Shape	Drill dia. Drilling depth)	Cutting edge	Remarks
DRXR		$\phi 12$ $\phi 12.5$ $\phi 13$ (2D/3D/4D)	2 Cutting edges per insert Outer edge Inner edge ZXMT03	Chip shape (Workpiece material: C50) drill dia. $\phi 12$ Chip from outer edge Chip from inner edge
		$\phi 12, \phi 13$ (5D)	Inner & outer edges on one insert ZXMT	Chip shape (Workpiece material: C50) drill dia. $\phi 24$ Chip from outer edge Chip from inner edge
K90 Silver coating				
DRW (Made to order for some products)		$\phi 60 \sim$ (1D/2D/3D)	Inner & outer edges on one insert 	Custom-order item BT integral arbor type is also available Maximum drilling diameter is $\phi 200$.
K100				



MagicDrill series application map

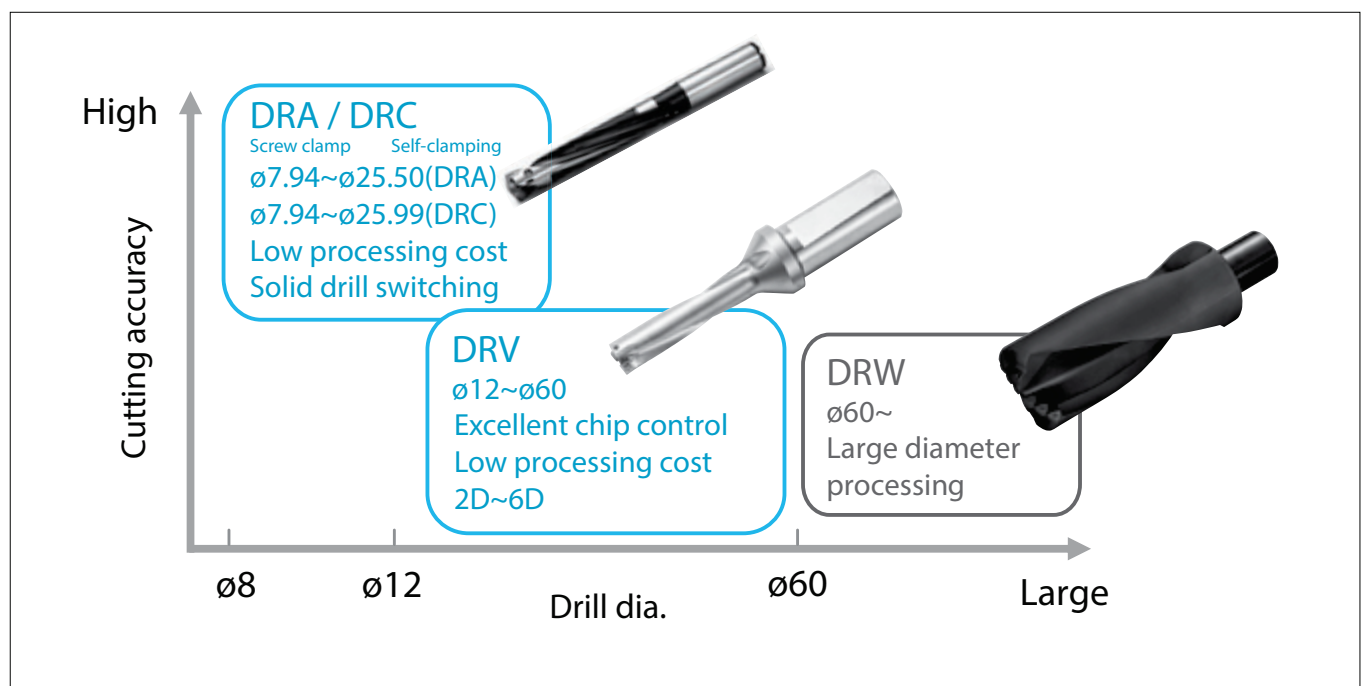

High efficiency modular drill

MagicDrill DRA

Excellent hole accuracy with a low cutting force design

5 advantages to solve common drilling difficulties

1 Low cutting force design improves hole accuracy

Special chisel edge with S-curve reduces thrust force and reduces vibration.

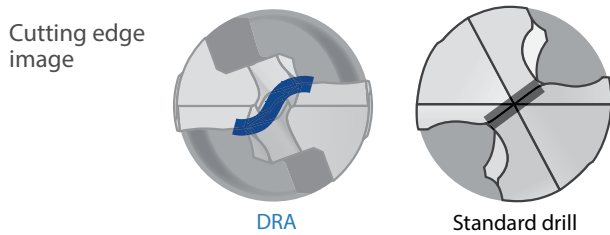

2 Optimal web thickness reduces deflection

Improved hole accuracy by controlling drill deflection with a 20% thicker web compared with Competitor A.

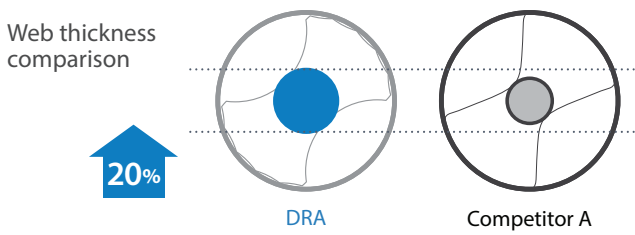

Cutting force comparison (Internal evaluation)

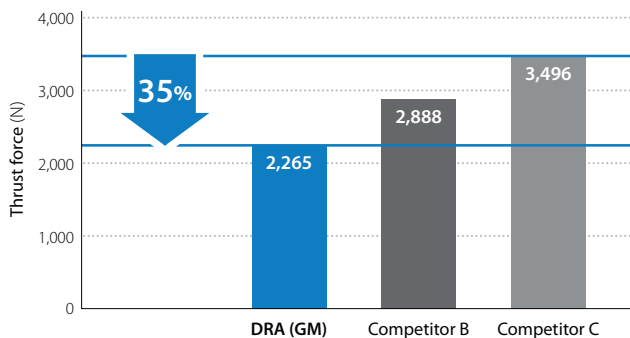

Cutting conditions: $V_c = 120$ m/min, $f = 0.25$ mm/rev
Drilling diameter $\phi 14$, $L/D = 5$, drilling depth 45 mm, wet, workpiece material: C50

Roundness · Cylindricity comparison (Internal evaluation)

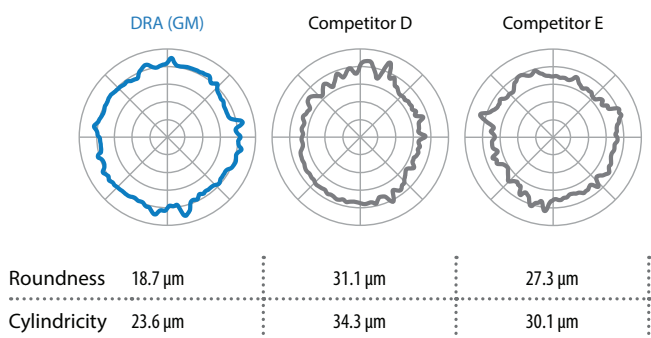

Cutting conditions: $V_c = 120$ m/min, $f = 0.3$ mm/rev
Drilling diameter $\phi 14$, $L/D = 5$, measurement position 55 mm, wet, workpiece material: C50

3 Fine chip breaking even in deep hole drilling applications

Optimized chip thinning for stable chip evacuation.
Support groove with wider flute (5D, 8D) enables smooth chip evacuation.

Chip comparison (Internal evaluation)

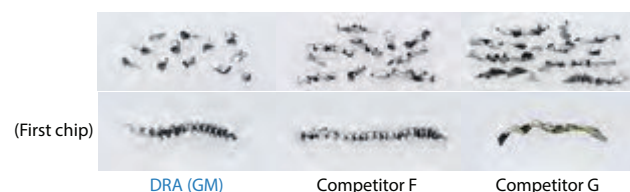

Cutting conditions: $V_c = 60$ m/min, $f = 0.2$ mm/rev, drilling diameter $\phi 14$, $L/D = 5$
Drilling depth 70 mm, wet, workpiece material: X5CrNi1810

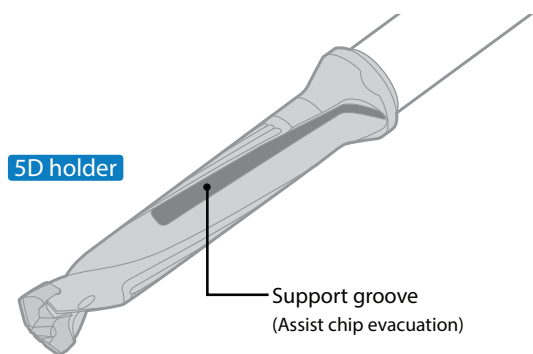

- K
- Drilling
- DRA
- DRC
- DRV
- DRZ
- DRXR
- DRW

4 Easy insert replacement

Replace insert without removing screw.

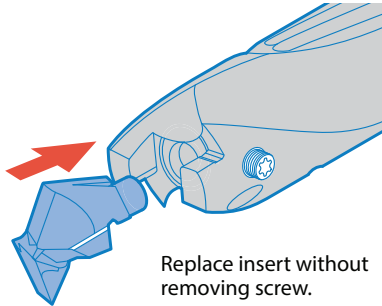

Replace insert without removing screw.

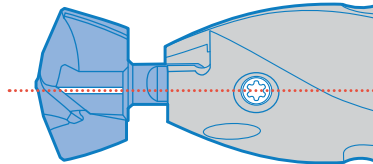

Install the insert onto toolholder (Align insert guide line with screw position).

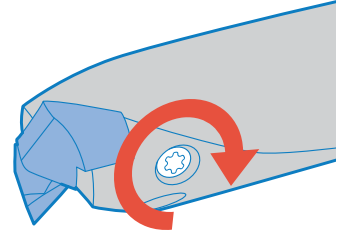

Fix the insert by tightening the screw.

5 Long tool life and stable machining of various workpieces

MEGACOAT NANO grade PR1535 is used to machine various materials from steel to stainless steel, with the combination of a tough substrate and a special nano layer coating.

1st recommendation

Steel / Stainless steel PR1535	Cast iron PR1525
-----------------------------------	---------------------

Coating properties

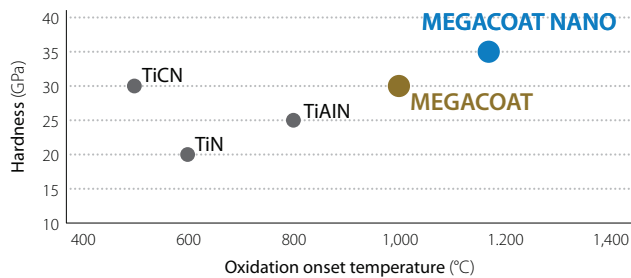

Wear resistance comparison (Internal evaluation)

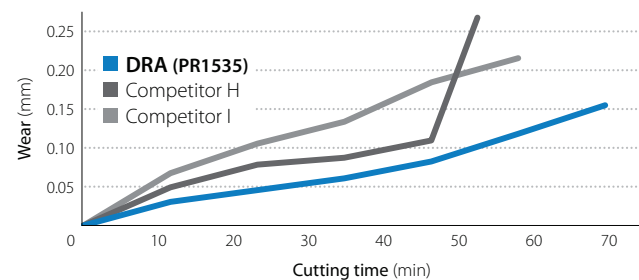

Cutting conditions: $V_c = 100$ m/min, $f = 0.25$ mm/rev
Drilling dia. $\phi 14$, L/D = 5, drilling depth 45 mm, wet, workpiece material: 42CrMo4

K
Drilling

Case studies

Attachment ST44-2

$V_c = 70$ m/min ($n = 1,240$ min⁻¹)
 $f = 0.23$ mm/rev ($V_f = 285$ mm/min)
Drilling depth 100 mm
Wet (Internal coolant)
With center hole drilling
SF25-DRA180M-8
DA1800M-GM PR1535

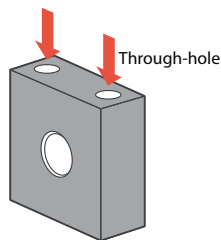

Cutting time

DRA $\phi 18-8D$

45 sec

30%

Competitor J
 $\phi 18-7D$
(Modular drill)

65 sec

Competitor J applied a peck cycle to avoid chip clogging.
DRA controlled chip evacuation without pecking.

(User evaluation)

Plate X5CrNi1810

$V_c = 60$ m/min ($n = 2,120$ min⁻¹)
 $f = 0.12$ mm/rev ($V_f = 254$ mm/min)
Drilling depth 15 mm
Wet (Internal coolant)
SS10-DRA090M-3
DA0900M-GM PR1535

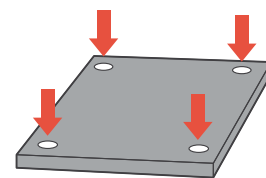

Number of holes

DRA $\phi 9-3D$

500

5 times

Competitor K
 $\phi 9-3D$
(Modular drill)

100

DRA extended the tool life by 5 times compared to Competitor K.
DRA maintained stable machining and excellent surface finish with less cutting noise.

(User evaluation)

DRA insert (GM - General purpose)

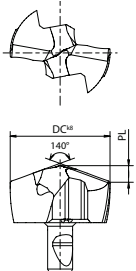
		Carbon steel / Alloy steel		●		P	
		Mold and die steel		●		M	
		Stainless steel		●		K	
		Cast iron		●		N	
		Non-ferrous metals		●		N	
Insert	Description	Dimension (mm)		Tolerance		Carbide	Applicable toolholder K18~K21 K24~K28
		DC	PL	k8 (min.)	k8 (max.)		
  <p>General purpose</p>	DA 0794M-GM	7.94	1.34	0	+0.022	●	SF12-DRA080M-○ SS10-DRA080M-○
	0800M-GM	8	1.35			●	
	0810M-GM	8.1	1.37			●	
	0820M-GM	8.2	1.38			●	
	0830M-GM	8.3	1.4			●	
	0840M-GM	8.4	1.42			●	
	DA 0850M-GM	8.5	1.44	0	+0.022	●	SF12-DRA085M-○ SS10-DRA085M-○
	0860M-GM	8.6	1.46			●	
	0870M-GM	8.7	1.48			●	
	0880M-GM	8.8	1.49			●	
	0890M-GM	8.9	1.51			●	
	DA 0900M-GM	9	1.52	0	+0.022	●	SF12-DRA090M-○ SS10-DRA090M-○
	0910M-GM	9.1	1.54			●	
	0920M-GM	9.2	1.56			●	
	0930M-GM	9.3	1.58			●	
	0940M-GM	9.4	1.59			●	
	DA 0950M-GM	9.5	1.61	0	+0.022	●	SF12-DRA095M-○ SS10-DRA095M-○
	0960M-GM	9.6	1.63			●	
	0970M-GM	9.7	1.65			●	
	0980M-GM	9.8	1.67			●	
	0990M-GM	9.9	1.68			●	
	DA 1000M-GM	10	1.7	0	+0.027	●	SF16-DRA100M-○ SS12-DRA100M-○
	1010M-GM	10.1	1.72			●	
	1020M-GM	10.2	1.74			●	
	1030M-GM	10.3	1.75			●	
	1040M-GM	10.4	1.77			●	
	DA 1050M-GM	10.5	1.79	0	+0.027	●	SF16-DRA105M-○ SS12-DRA105M-○
	1060M-GM	10.6	1.81			●	
1070M-GM	10.7	1.83	●				
1080M-GM	10.8	1.85	●				
1090M-GM	10.9	1.86	●				
DA 1100M-GM	11	1.87	0	+0.027	●	SF16-DRA110M-○ SS12-DRA110M-○	
1110M-GM	11.1	1.89			●		
1120M-GM	11.2	1.91			●		
1130M-GM	11.3	1.92			●		
1140M-GM	11.4	1.94			●		
DA 1150M-GM	11.5	1.96	0	+0.027	●	SF16-DRA115M-○ SS12-DRA115M-○	
1160M-GM	11.6	1.98			●		
1170M-GM	11.7	2			●		
1180M-GM	11.8	2.01			●		
1190M-GM	11.9	2.03			●		
DA 1200M-GM	12	2.03	0	+0.027	●	SF16-DRA120M-○ SS14-DRA120M-○	
1210M-GM	12.1	2.05			●		
1220M-GM	12.2	2.07			●		
1230M-GM	12.3	2.08			●		
1240M-GM	12.4	2.1			●		

k8 is the dimension tolerance of the insert. It is not the dimension tolerance of the hole diameter.

Recommended cutting conditions  K30

● : Standard item R : Right-hand only L : Left-hand only □ : Check availability

DA inserts are sold in 1 piece boxes

DRA insert (GM - General purpose)

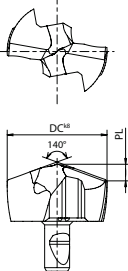
Insert		Description		Dimension (mm)		Tolerance		Carbide		Applicable toolholder K18~K21 K24~K28
				DC	PL	k8 (min.)	k8 (max.)	PVD	PR1525 PR1535	
				Carbon steel / Alloy steel		○	●			P
				Mold and die steel						
				Stainless steel		○	●			M
				Cast iron		●	○			K
				Non-ferrous metals						N
  General purpose	DA	1250M-GM 1260M-GM 1270M-GM 1280M-GM 1290M-GM	12.5 12.6 12.7 12.8 12.9	2.12 2.14 2.16 2.17 2.19	0	+0.027	●	●	SF16-DRA125M-○ SS14-DRA125M-○	
	DA	1300M-GM 1310M-GM 1320M-GM 1330M-GM 1340M-GM	13 13.1 13.2 13.3 13.4	2.2 2.22 2.24 2.25 2.27	0	+0.027	●	●	SF16-DRA130M-○ SS14-DRA130M-○	
	DA	1350M-GM 1360M-GM 1370M-GM 1380M-GM 1390M-GM	13.5 13.6 13.7 13.8 13.9	2.29 2.31 2.33 2.35 2.36	0	+0.027	●	●	SF16-DRA135M-○ SS14-DRA135M-○	
	DA	1400M-GM 1410M-GM 1420M-GM 1430M-GM 1440M-GM	14 14.1 14.2 14.3 14.4	2.33 2.34 2.36 2.38 2.4	0	+0.027	●	●	SF16-DRA140M-○ SS16-DRA140M-○	
	DA	1450M-GM 1460M-GM 1470M-GM 1480M-GM 1490M-GM	14.5 14.6 14.7 14.8 14.9	2.42 2.43 2.45 2.47 2.49	0	+0.027	●	●	SF16-DRA145M-○ SS16-DRA145M-○	
	DA	1500M-GM 1510M-GM 1520M-GM 1530M-GM 1540M-GM 1550M-GM 1560M-GM 1570M-GM 1580M-GM 1590M-GM	15 15.1 15.2 15.3 15.4 15.5 15.6 15.7 15.8 15.9	2.52 2.54 2.55 2.57 2.59 2.61 2.63 2.65 2.66 2.68	0	+0.027	●	●	SF20-DRA150M-○ SS16-DRA150M-○	
	DA	1600M-GM 1610M-GM 1620M-GM 1630M-GM 1640M-GM 1650M-GM 1660M-GM 1670M-GM 1680M-GM 1690M-GM	16 16.1 16.2 16.3 16.4 16.5 16.6 16.7 16.8 16.9	2.69 2.71 2.73 2.75 2.76 2.78 2.8 2.82 2.84 2.86	0	+0.027	●	●	SF20-DRA160M-○ SS18-DRA160M-○	

k8 is the dimension tolerance of the insert. It is not the dimension tolerance of the hole diameter.



Recommended cutting conditions  K30

● : Standard item R : Right-hand only L : Left-hand only □ : Check availability

DA inserts are sold in 1 piece boxes

K
Drilling

DRA insert (GM - General purpose)

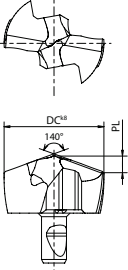
		Carbon steel / Alloy steel		Mold and die steel		Stainless steel		Cast iron		Non-ferrous metals		P		M		K		N	
Insert	Description	Dimension (mm)		Tolerance		Carbide		PVD		Applicable toolholder		K18~K21		K24~K28					
		DC	PL	k8 (min.)	k8 (max.)	PR1525	PR1535	Applicable toolholder		K18~K21		K24~K28							
 Drilling   General purpose	DA	1700M-GM	17	2.86	0	+0.027	●	●	SF20-DRA170M-○	SS18-DRA170M-○									
		1710M-GM	17.1	2.88			●	●											
		1720M-GM	17.2	2.9			●	●											
		1730M-GM	17.3	2.92			●	●											
		1740M-GM	17.4	2.93			●	●											
		1750M-GM	17.5	2.95			●	●											
		1760M-GM	17.6	2.97			●	●											
		1770M-GM	17.7	2.99			●	●											
		1780M-GM	17.8	3.01			●	●											
		1790M-GM	17.9	3.03	●	●													
	DA	1800M-GM	18	3.04	0	+0.027	●	●	SF25-DRA180M-○	SS20-DRA180M-○									
		1810M-GM	18.1	3.06			●	●											
		1820M-GM	18.2	3.07			●	●											
		1830M-GM	18.3	3.09			●	●											
		1840M-GM	18.4	3.11			●	●											
		1850M-GM	18.5	3.13			●	●											
		1860M-GM	18.6	3.15			●	●											
		1870M-GM	18.7	3.17			●	●											
		1880M-GM	18.8	3.18			●	●											
		1890M-GM	18.9	3.2	●	●													
	DA	1900M-GM	19	3.21	0	+0.033	●	●	SF25-DRA190M-○	SS20-DRA190M-○									
		1910M-GM	19.1	3.23			●	●											
		1920M-GM	19.2	3.25			●	●											
		1930M-GM	19.3	3.27			●	●											
		1940M-GM	19.4	3.29			●	●											
		1950M-GM	19.5	3.3			●	●											
		1960M-GM	19.6	3.32			●	●											
		1970M-GM	19.7	3.34			●	●											
		1980M-GM	19.8	3.36			●	●											
		1990M-GM	19.9	3.38	●	●													
	DA	2000M-GM	20	3.37	0	+0.033	●	●	SF25-DRA200M-○	SS25-DRA200M-○									
		2010M-GM	20.1	3.39			●	●											
		2020M-GM	20.2	3.41			●	●											
		2030M-GM	20.3	3.43			●	●											
		2040M-GM	20.4	3.45			●	●											
		2050M-GM	20.5	3.46			●	●											
		2060M-GM	20.6	3.48			●	●											
		2070M-GM	20.7	3.5			●	●											
		2080M-GM	20.8	3.52			●	●											
		2090M-GM	20.9	3.54	●	●													
	DA	2100M-GM	21	3.54	0	+0.033	●	●	SF25-DRA210M-○	SS25-DRA210M-○									
		2150M-GM	21.5	3.63			●	●											
	DA	2200M-GM	22	3.71	0	+0.033	●	●	SF25-DRA220M-○	SS25-DRA220M-○									
		2250M-GM	22.5	3.8			●	●											
	DA	2300M-GM	23	3.87	0	+0.033	●	●	SF25-DRA230M-○	SS25-DRA230M-○									
		2350M-GM	23.5	3.96			●	●											
	DA	2400M-GM	24	4.04	0	+0.033	●	●	SF25-DRA240M-○	SS25-DRA240M-○									
		2450M-GM	24.5	4.13			●	●											
DA	2500M-GM	25	4.2	0	+0.033	●	●	SF25-DRA250M-○	SS32-DRA250M-○										
	2550M-GM	25.5	4.29			●	●												
DA	2600M-GM	26	4.8	0	+0.033	●	●	SF32-DRA260M-○											
	2650M-GM	26.5	4.9			●	●												

k8 is the dimension tolerance of the insert. It is not the dimension tolerance of the hole diameter.

Recommended cutting conditions  K30

● : Standard item R : Right-hand only L : Left-hand only □ : Check availability

DA inserts are sold in 1 piece boxes

DRA insert (GM - General purpose)

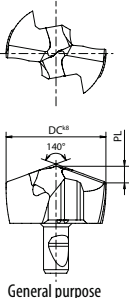
		Carbon steel / Alloy steel				P	
		Mold and die steel					
		Stainless steel				M	
		Cast iron				K	
		Non-ferrous metals				N	
Insert	Description	Dimension (mm)		Tolerance		Carbide PVD PR1525 PR1535	Applicable toolholder K25~K27
		DC	PL	k8 (min.)	k8 (max.)		
  <p>General purpose</p>	DA 2700M-GM	27	4.99	0	+0.033	●●●●	SF32-DRA270M-○
	2750M-GM	27.5	5.09	0	+0.033	●●●●	SF32-DRA270M-○
	DA 2800M-GM	28	4.73	0	+0.033	●●●●	SF32-DRA280M-○
	2850M-GM	28.5	4.83	0	+0.033	●●●●	SF32-DRA280M-○
	DA 2900M-GM	29	4.9	0	+0.033	●●●●	SF32-DRA290M-○
	2950M-GM	29.5	5.01	0	+0.033	●●●●	SF32-DRA290M-○
	DA 3000M-GM	30	5.07	0	+0.033	●●●●	SF32-DRA300M-○
	3050M-GM	30.5	5.17	0	+0.039	●●●●	SF32-DRA300M-○
	DA 3100M-GM	31	5.26	0	+0.039	●●●●	SF32-DRA310M-○
	3150M-GM	31.5	5.37	0	+0.039	●●●●	SF32-DRA310M-○
	DA 3200M-GM	32	5.41	0	+0.039	●●●●	SF32-DRA320M-○
	3250M-GM	32.5	5.51	0	+0.039	●●●●	SF32-DRA320M-○
3300M-GM	33	5.62	0	+0.039	●●●●	SF32-DRA320M-○	

k8 is the dimension tolerance of the insert. It is not the dimension tolerance of the hole diameter.

Recommended cutting conditions ☞ K30

Description Identification System (Insert)

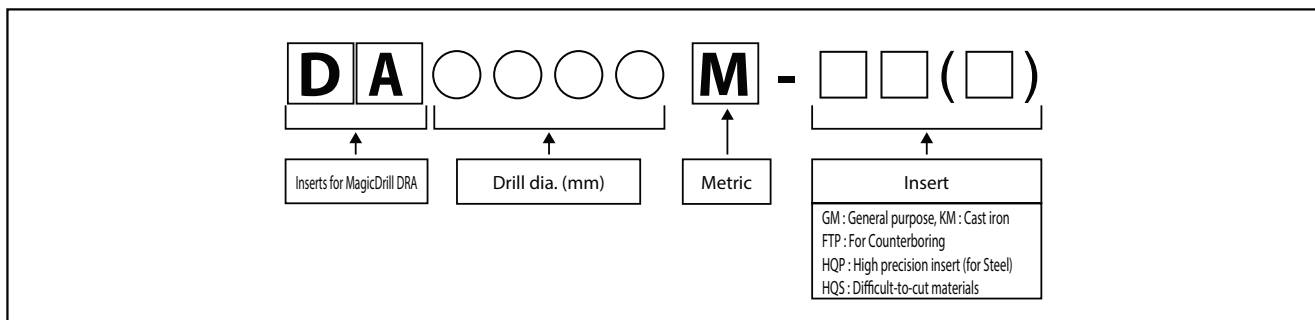

DA inserts are sold in 1 piece boxes

DRA insert (KM - Cast iron)

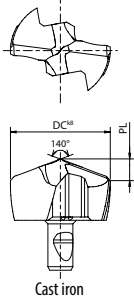
Insert		Description		Dimension (mm)		Tolerance		Carbide	Applicable toolholder K18~K21 K24~K28	
				DC	PL	k8 (min.)	k8 (max.)			
				Carbon steel / Alloy steel					P	
				Mold and die steel						
				Stainless steel					M	
				Cast iron				●	K	
				Non-ferrous metals					N	
	 <p>Cast iron</p>	DA	0794M-KM	7.94	1.82	0	+0.022	PVD	SF12-DRA080M-○ SS10-DRA080M-○	
			0800M-KM	8	1.85					
			0810M-KM	8.1	1.89					
			0820M-KM	8.2	1.93					
			0830M-KM	8.3	1.98					
			0840M-KM	8.4	2.02					
			DA	0850M-KM	8.5	2.06	0	+0.022	PRT525	SF12-DRA085M-○ SS10-DRA085M-○
				0860M-KM	8.6	2.1				
				0870M-KM	8.7	2.14				
				0880M-KM	8.8	2.19				
				0890M-KM	8.9	2.23				
			DA	0900M-KM	9	2.02	0	+0.022	PVD	SF12-DRA090M-○ SS10-DRA090M-○
				0910M-KM	9.1	2.06				
				0920M-KM	9.2	2.11				
				0930M-KM	9.3	2.15				
				0940M-KM	9.4	2.19				
			DA	0950M-KM	9.5	2.23	0	+0.022	PVD	SF12-DRA095M-○ SS10-DRA095M-○
				0960M-KM	9.6	2.27				
				0970M-KM	9.7	2.32				
				0980M-KM	9.8	2.36				
				0990M-KM	9.9	2.4				
			DA	1000M-KM	10	2.2	0	+0.027	PVD	SF16-DRA100M-○ SS12-DRA100M-○
				1010M-KM	10.1	2.24				
				1020M-KM	10.2	2.28				
		1030M-KM	10.3	2.32						
		1040M-KM	10.4	2.37						
	DA	1050M-KM	10.5	2.41	0	+0.027	PVD	SF16-DRA105M-○ SS12-DRA105M-○		
		1060M-KM	10.6	2.45						
		1070M-KM	10.7	2.49						
		1080M-KM	10.8	2.53						
		1090M-KM	10.9	2.57						
	DA	1100M-KM	11	2.5	0	+0.027	PVD	SF16-DRA110M-○ SS12-DRA110M-○		
		1110M-KM	11.1	2.54						
		1120M-KM	11.2	2.59						
		1130M-KM	11.3	2.63						
		1140M-KM	11.4	2.67						
	DA	1150M-KM	11.5	2.71	0	+0.027	PVD	SF16-DRA115M-○ SS12-DRA115M-○		
		1160M-KM	11.6	2.75						
		1170M-KM	11.7	2.8						
		1180M-KM	11.8	2.84						
		1190M-KM	11.9	2.88						
	DA	1200M-KM	12	2.68	0	+0.027	PVD	SF16-DRA120M-○ SS14-DRA120M-○		
		1210M-KM	12.1	2.72						
		1220M-KM	12.2	2.76						
		1230M-KM	12.3	2.8						
		1240M-KM	12.4	2.85						
	DA	1250M-KM	12.5	2.89	0	+0.027	PVD	SF16-DRA125M-○ SS14-DRA125M-○		
		1260M-KM	12.6	2.93						
		1270M-KM	12.7	2.97						
		1280M-KM	12.8	3.01						
		1290M-KM	12.9	3.06						

k8 is the dimension tolerance of the insert. It is not the dimension tolerance of the hole diameter.

Recommended cutting conditions ➔ K30

● : Standard item R : Right-hand only L : Left-hand only □ : Check availability

DA inserts are sold in 1 piece boxes

DRA insert (KM - Cast iron)

		Carbon steel / Alloy steel				P	
		Mold and die steel				M	
		Stainless steel				K	
		Cast iron				●	
		Non-ferrous metals				N	
Description	Dimension (mm)		Tolerance		Carbide	Applicable toolholder K18~K21 K24~K28	
	DC	PL	k8 (min.)	k8 (max.)			PVD
DA 1300M-KM	13	2.83	0	+0.027	<input type="checkbox"/>	SF16-DRA130M-○ SS14-DRA130M-○	
1310M-KM	13.1	2.87			<input type="checkbox"/>		
1320M-KM	13.2	2.92			<input type="checkbox"/>		
1330M-KM	13.3	2.96			<input type="checkbox"/>		
1340M-KM	13.4	3			<input type="checkbox"/>		
DA 1350M-KM	13.5	3.04	0	+0.027	<input type="checkbox"/>	SF16-DRA135M-○ SS14-DRA135M-○	
1360M-KM	13.6	3.08			<input type="checkbox"/>		
1370M-KM	13.7	3.13			<input type="checkbox"/>		
1380M-KM	13.8	3.17			<input type="checkbox"/>		
1390M-KM	13.9	3.21			<input type="checkbox"/>		
DA 1400M-KM	14	3.04	0	+0.027	<input type="checkbox"/>	SF16-DRA140M-○ SS16-DRA140M-○	
1410M-KM	14.1	3.09			<input type="checkbox"/>		
1420M-KM	14.2	3.13			<input type="checkbox"/>		
1430M-KM	14.3	3.17			<input type="checkbox"/>		
1440M-KM	14.4	3.21			<input type="checkbox"/>		
DA 1450M-KM	14.5	3.25	0	+0.027	<input type="checkbox"/>	SF16-DRA145M-○ SS16-DRA145M-○	
1460M-KM	14.6	3.3			<input type="checkbox"/>		
1470M-KM	14.7	3.34			<input type="checkbox"/>		
1480M-KM	14.8	3.38			<input type="checkbox"/>		
1490M-KM	14.9	3.42			<input type="checkbox"/>		
DA 1500M-KM	15	3.24	0	+0.027	<input type="checkbox"/>	SF20-DRA150M-○ SS16-DRA150M-○	
1510M-KM	15.1	3.28			<input type="checkbox"/>		
1520M-KM	15.2	3.33			<input type="checkbox"/>		
1530M-KM	15.3	3.37			<input type="checkbox"/>		
1540M-KM	15.4	3.41			<input type="checkbox"/>		
1550M-KM	15.5	3.45			<input type="checkbox"/>		
1560M-KM	15.6	3.49			<input type="checkbox"/>		
1570M-KM	15.7	3.54			<input type="checkbox"/>		
1580M-KM	15.8	3.58			<input type="checkbox"/>		
1590M-KM	15.9	3.62			<input type="checkbox"/>		
DA 1600M-KM	16	3.43	0	+0.027	<input type="checkbox"/>	SF20-DRA160M-○ SS18-DRA160M-○	
1610M-KM	16.1	3.47			<input type="checkbox"/>		
1620M-KM	16.2	3.51			<input type="checkbox"/>		
1630M-KM	16.3	3.55			<input type="checkbox"/>		
1640M-KM	16.4	3.6			<input type="checkbox"/>		
1650M-KM	16.5	3.64			<input type="checkbox"/>		
1660M-KM	16.6	3.68			<input type="checkbox"/>		
1670M-KM	16.7	3.72			<input type="checkbox"/>		
1680M-KM	16.8	3.76			<input type="checkbox"/>		
1690M-KM	16.9	3.81			<input type="checkbox"/>		
DA 1700M-KM	17	3.61	0	+0.027	<input type="checkbox"/>	SF20-DRA170M-○ SS18-DRA170M-○	
1710M-KM	17.1	3.65			<input type="checkbox"/>		
1720M-KM	17.2	3.69			<input type="checkbox"/>		
1730M-KM	17.3	3.74			<input type="checkbox"/>		
1740M-KM	17.4	3.78			<input type="checkbox"/>		
1750M-KM	17.5	3.82			<input type="checkbox"/>		
1760M-KM	17.6	3.86			<input type="checkbox"/>		
1770M-KM	17.7	3.9			<input type="checkbox"/>		
1780M-KM	17.8	3.95			<input type="checkbox"/>		
1790M-KM	17.9	3.99			<input type="checkbox"/>		

k8 is the dimension tolerance of the insert. It is not the dimension tolerance of the hole diameter.

		Carbon steel / Alloy steel				P	
		Mold and die steel				M	
		Stainless steel				K	
		Cast iron				●	
		Non-ferrous metals				N	
Description	Dimension (mm)		Tolerance		Carbide	Applicable toolholder K18~K21 K24~K28	
	DC	PL	k8 (min.)	k8 (max.)			PVD
DA 1800M-KM	18	3.79	0	+0.027	<input type="checkbox"/>	SF25-DRA180M-○ SS20-DRA180M-○	
1810M-KM	18.1	3.83			<input type="checkbox"/>		
1820M-KM	18.2	3.88			<input type="checkbox"/>		
1830M-KM	18.3	3.92			<input type="checkbox"/>		
1840M-KM	18.4	3.96			<input type="checkbox"/>		
1850M-KM	18.5	4			<input type="checkbox"/>		
1860M-KM	18.6	4.04			<input type="checkbox"/>		
1870M-KM	18.7	4.08			<input type="checkbox"/>		
1880M-KM	18.8	4.13			<input type="checkbox"/>		
1890M-KM	18.9	4.17			<input type="checkbox"/>		
DA 1900M-KM	19	3.97	0	+0.033	<input type="checkbox"/>	SF25-DRA190M-○ SS20-DRA190M-○	
1910M-KM	19.1	4.01			<input type="checkbox"/>		
1920M-KM	19.2	4.05			<input type="checkbox"/>		
1930M-KM	19.3	4.09			<input type="checkbox"/>		
1940M-KM	19.4	4.14			<input type="checkbox"/>		
1950M-KM	19.5	4.18			<input type="checkbox"/>		
1960M-KM	19.6	4.22			<input type="checkbox"/>		
1970M-KM	19.7	4.26			<input type="checkbox"/>		
1980M-KM	19.8	4.3			<input type="checkbox"/>		
1990M-KM	19.9	4.35			<input type="checkbox"/>		
DA 2000M-KM	20	4.2	0	+0.033	<input type="checkbox"/>	SF25-DRA200M-○ SS25-DRA200M-○	
2010M-KM	20.1	4.24			<input type="checkbox"/>		
2020M-KM	20.2	4.28			<input type="checkbox"/>		
2030M-KM	20.3	4.33			<input type="checkbox"/>		
2040M-KM	20.4	4.37			<input type="checkbox"/>		
2050M-KM	20.5	4.41			<input type="checkbox"/>		
2060M-KM	20.6	4.45			<input type="checkbox"/>		
2070M-KM	20.7	4.49			<input type="checkbox"/>		
2080M-KM	20.8	4.54			<input type="checkbox"/>		
2090M-KM	20.9	4.58			<input type="checkbox"/>		
DA 2100M-KM	21	4.38	0	+0.033	<input type="checkbox"/>	SF25-DRA210M-○ SS25-DRA210M-○	
2150M-KM	21.5	4.59			<input type="checkbox"/>		
DA 2200M-KM	22	4.55	0	+0.033	<input type="checkbox"/>	SF25-DRA220M-○ SS25-DRA220M-○	
2250M-KM	22.5	4.76			<input type="checkbox"/>		
DA 2300M-KM	23	4.74	0	+0.033	<input type="checkbox"/>	SF25-DRA230M-○ SS25-DRA230M-○	
2350M-KM	23.5	4.94			<input type="checkbox"/>		
DA 2400M-KM	24	4.91	0	+0.033	<input type="checkbox"/>	SF25-DRA240M-○ SS25-DRA240M-○	
2450M-KM	24.5	5.12			<input type="checkbox"/>		
DA 2500M-KM	25	5.08	0	+0.033	<input type="checkbox"/>	SF25-DRA250M-○ SS32-DRA250M-○	
2550M-KM	25.5	5.29			<input type="checkbox"/>		

Recommended cutting conditions K30

● : Standard item R : Right-hand only L : Left-hand only □ : Check availability

DA inserts are sold in 1 piece boxes

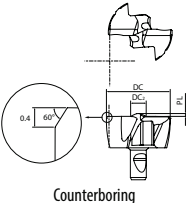

DRA insert (FTP - Counterboring)

Insert		Description		Dimension (mm)			Tolerance		Carbide		Applicable toolholder K18~K21 K24~K28
				DC	DC2	PL	k8 (min.)	k8 (max.)	PVD		
				Carbon steel / Alloy steel					●	●	P
				Mold and die steel							
				Stainless steel					○	●	M
				Cast iron					●	○	K
				Non-ferrous metals							N
  <p>Counterboring</p>	DA	0800M-FTP 0830M-FTP	8 8.3	2.9	0.4	0	+0.022	●	●	SF12-DRA080M-○ SS10-DRA080M-○	
	DA	0850M-FTP 0880M-FTP	8.5 8.8	2.9	0.4	0	+0.022	●	●	SF12-DRA085M-○ SS10-DRA085M-○	
	DA	0900M-FTP 0930M-FTP	9 9.3	3	0.43	0	+0.022	●	●	SF12-DRA090M-○ SS10-DRA090M-○	
	DA	0950M-FTP	9.5	3	0.43	0	+0.022	●	●	SF12-DRA095M-○ SS10-DRA095M-○	
	DA	1000M-FTP 1030M-FTP	10 10.3	3.3	0.46	0	+0.022 +0.027	●	●	SF16-DRA100M-○ SS12-DRA100M-○	
	DA	1050M-FTP 1080M-FTP	10.5 10.8	3.3	0.46	0	+0.027	●	●	SF16-DRA105M-○ SS12-DRA105M-○	
	DA	1100M-FTP	11	3.4	0.5	0	+0.027	●	●	SF16-DRA110M-○ SS12-DRA110M-○	
	DA	1150M-FTP	11.5	3.4	0.5	0	+0.027	●	●	SF16-DRA115M-○ SS12-DRA115M-○	
	DA	1200M-FTP	12	3.7	0.53	0	+0.027	●	●	SF16-DRA120M-○ SS14-DRA120M-○	
	DA	1250M-FTP 1270M-FTP	12.5 12.7	3.7	0.53	0	+0.027	●	●	SF16-DRA125M-○ SS14-DRA125M-○	
	DA	1300M-FTP	13	3.9	0.56	0	+0.027	●	●	SF16-DRA130M-○ SS14-DRA130M-○	
	DA	1350M-FTP	13.5	3.9	0.56	0	+0.027	●	●	SF16-DRA135M-○ SS14-DRA135M-○	
	DA	1400M-FTP	14	4.2	0.6	0	+0.027	●	●	SF16-DRA140M-○ SS16-DRA140M-○	
	DA	1450M-FTP	14.5	4.2	0.6	0	+0.027	●	●	SF16-DRA145M-○ SS16-DRA145M-○	
	DA	1500M-FTP 1550M-FTP	15 15.5	4.4	0.65	0	+0.027	●	●	SF20-DRA150M-○ SS16-DRA150M-○	
	DA	1600M-FTP 1650M-FTP	16 16.5	4.6	0.7	0	+0.027	●	●	SF20-DRA160M-○ SS18-DRA160M-○	
	DA	1700M-FTP 1750M-FTP	17 17.5	5	0.75	0	+0.027	●	●	SF20-DRA170M-○ SS18-DRA170M-○	
	DA	1800M-FTP 1850M-FTP	18 18.5	5	0.8	0	+0.027 +0.033	●	●	SF25-DRA180M-○ SS20-DRA180M-○	
	DA	1900M-FTP 1950M-FTP	19 19.5	5.3	0.85	0	+0.033	●	●	SF25-DRA190M-○ SS20-DRA190M-○	
	DA	2000M-FTP 2050M-FTP	20 20.5	5.7	0.9	0	+0.033	●	●	SF25-DRA200M-○ SS25-DRA200M-○	
	DA	2100M-FTP 2150M-FTP	21 21.5	6	0.95	0	+0.033	●	●	SF25-DRA210M-○ SS25-DRA210M-○	
	DA	2200M-FTP 2250M-FTP	22 22.5	6.4	1	0	+0.033	●	●	SF25-DRA220M-○ SS25-DRA220M-○	
	DA	2300M-FTP 2350M-FTP	23 23.5	6.6	1.05	0	+0.033	●	●	SF25-DRA230M-○ SS25-DRA230M-○	
	DA	2400M-FTP 2450M-FTP	24 24.5	6.8	1.1	0	+0.033	●	●	SF25-DRA240M-○ SS25-DRA240M-○	
	DA	2500M-FTP 2540M-FTP	25 25.4	7	1.2	0	+0.033	●	●	SF25-DRA250M-○ SS32-DRA250M-○	

k8 is the dimension tolerance of the insert. It is not the dimension tolerance of the hole diameter.

Recommended cutting conditions  K30

● : Standard item R : Right-hand only L : Left-hand only □ : Check availability

DA inserts are sold in 1 piece boxes

Double Margin Type

High-precision Insert for Steel Machining

HQP

Special two-step bottom and double margin
Reduces shock for higher-precision machining of steel



PR1525

Drilling Diameter $\phi 7.94 \sim \phi 19.9$

For Difficult-to-cut Materials/
Stainless Steel Machining

HQS

Special two-step bottom and double margin
Improving stability of difficult-to-cut materials and stainless steel during machining operations



PR1535

Drilling Diameter $\phi 8.00 \sim \phi 19.5$

Special Two-step Bottom



Suppress sudden fracture when entering the workpiece
Improvement of cutting edge strength

Double Margin

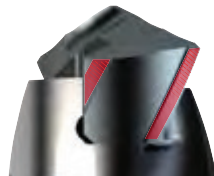

Optimized for difficult-to-cut materials machining
Improvement of heat resistance

Unique Flute Shape



Superior chip control
Prevents damage to hole walls.
Excellent finished surface

High-precision Insert for Steel Machining

HQP

Cutting force comparison when entering the workpiece
(Internal evaluation)

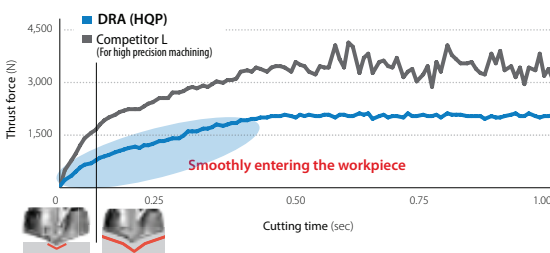

Cutting Conditions: $V_c = 100 \text{ m/min}$, $f = 0.25 \text{ mm/rev}$, $H = 30 \text{ mm}$, Wet Workpiece: S50C $\phi 16$ (3D)

Hole wall surface finish comparison
(Internal evaluation)

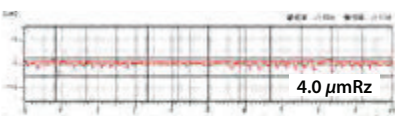

Cutting Conditions: $V_c = 100 \text{ m/min}$, $f = 0.25 \text{ mm/rev}$, $H = 80 \text{ mm}$, Wet Workpiece: S50C $\phi 16$ (5D)

For Difficult-to-cut Materials/
Stainless Steel Machining

HQS

Inconel

Wear Resistance Comparison (Internal evaluation)

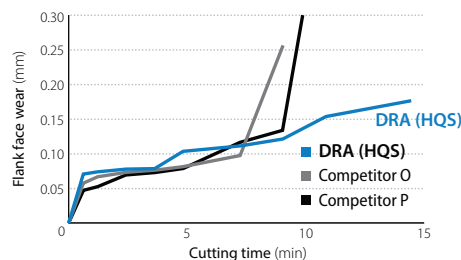

Shoulder part

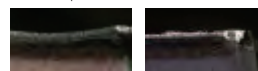

Normal wear condition

Fracture on the shoulder of insert

Chisel part



Good without fracture

Fracture on the chisel

DRA (HQS)

Competitor O



DRA (HQS)

Competitor P

Cutting Conditions: $V_c = 20 \text{ m/min}$, $f = 0.15 \text{ mm/rev}$, Drilling Diameter $\phi 14.5$ (3D)
Drilling Depth 40 mm, Wet (internal/external), Workpiece: Inconel 718, BT50 M/C

K
Drilling

DRA insert (HQP - Precision / for Carbon steel)

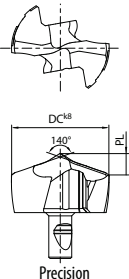
Insert		Description		Dimension (mm)		Tolerance		Carbide	Applicable toolholder K18~K21 K24~K28
				DC	PL	k8 (min.)	k8 (max.)		
				Carbon steel / Alloy steel				●	P
				Mold and die steel					
				Stainless steel				●	M
				Cast iron				●	K
				Non-ferrous metals				●	N
 Drilling	  Precision	DA	0794M-HQP 0800M-HQP 0810M-HQP 0820M-HQP 0830M-HQP 0840M-HQP	7.94 8 8.1 8.2 8.3 8.4	1.9 1.91 1.93 1.94 1.96 1.98	0	+0.022	●	SF12-DRA080M-○ SS10-DRA080M-○
		DA	0850M-HQP 0860M-HQP 0870M-HQP 0880M-HQP 0890M-HQP	8.5 8.6 8.7 8.8 8.9	1.99 2.01 2.03 2.05 2.06	0	+0.022	●	SF12-DRA085M-○ SS10-DRA085M-○
		DA	0900M-HQP 0910M-HQP 0920M-HQP 0930M-HQP 0940M-HQP	9 9.1 9.2 9.3 9.4	2.19 2.21 2.22 2.24 2.26	0	+0.022	●	SF12-DRA090M-○ SS10-DRA090M-○
		DA	0950M-HQP 0960M-HQP 0970M-HQP 0980M-HQP 0990M-HQP	9.5 9.6 9.7 9.8 9.9	2.27 2.29 2.31 2.32 2.34	0	+0.022	●	SF12-DRA095M-○ SS10-DRA095M-○
		DA	1000M-HQP 1010M-HQP 1020M-HQP 1030M-HQP 1040M-HQP	10 10.1 10.2 10.3 10.4	2.35 2.36 2.38 2.4 2.41	0	+0.022 +0.027 +0.027 +0.027 +0.027	●	SF16-DRA100M-○ SS12-DRA100M-○
		DA	1050M-HQP 1060M-HQP 1070M-HQP 1080M-HQP 1090M-HQP	10.5 10.6 10.7 10.8 10.9	2.43 2.44 2.46 2.47 2.49	0	+0.027	●	SF16-DRA105M-○ SS12-DRA105M-○
		DA	1100M-HQP 1110M-HQP 1120M-HQP 1130M-HQP 1140M-HQP	11 11.1 11.2 11.3 11.4	2.65 2.67 2.68 2.7 2.72	0	+0.027	●	SF16-DRA110M-○ SS12-DRA110M-○
		DA	1150M-HQP 1160M-HQP 1170M-HQP 1180M-HQP 1190M-HQP	11.5 11.6 11.7 11.8 11.9	2.73 2.75 2.76 2.78 2.8	0	+0.027	●	SF16-DRA115M-○ SS12-DRA115M-○
		DA	1200M-HQP 1210M-HQP 1220M-HQP 1230M-HQP 1240M-HQP	12 12.1 12.2 12.3 12.4	2.79 2.81 2.82 2.84 2.86	0	+0.027	●	SF16-DRA120M-○ SS14-DRA120M-○
		DA	1250M-HQP 1260M-HQP 1270M-HQP 1280M-HQP 1290M-HQP	12.5 12.6 12.7 12.8 12.9	2.87 2.89 2.91 2.92 2.94	0	+0.027	●	SF16-DRA125M-○ SS14-DRA125M-○

k8 is the dimension tolerance of the insert. It is not the dimension tolerance of the hole diameter.

Recommended cutting conditions ➔ K31

● : Standard item R : Right-hand only L : Left-hand only □ : Check availability

DA inserts are sold in 1 piece boxes

DRA insert (HQP - Precision / for Carbon steel)

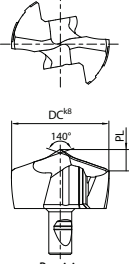
Insert		Description		Dimension (mm)		Tolerance		Carbide	Applicable toolholder K18~K21 K24~K28
				DC	PL	k8 (min.)	k8 (max.)		
				Carbon steel / Alloy steel				●	P
				Mold and die steel					
				Stainless steel				●	M
				Cast iron				●	K
				Non-ferrous metals				●	N
  Precision	DA	1300M-HQP	13	2.98	0	+0.027	●	SF16-DRA130M-○ SS14-DRA130M-○	
		1310M-HQP	13.1	2.99					
		1320M-HQP	13.2	3.01					
		1330M-HQP	13.3	3.02					
		1340M-HQP	13.4	3.04					
		1350M-HQP	13.5	3.06	0	+0.027	●	SF16-DRA135M-○ SS14-DRA135M-○	
		1360M-HQP	13.6	3.07					
		1370M-HQP	13.7	3.09					
		1380M-HQP	13.8	3.1					
		1390M-HQP	13.9	3.12					
		1400M-HQP	14	3.11	0	+0.027	●	SF16-DRA140M-○ SS16-DRA140M-○	
		1410M-HQP	14.1	3.12					
		1420M-HQP	14.2	3.14					
		1430M-HQP	14.3	3.16					
		1440M-HQP	14.4	3.17					
		1450M-HQP	14.5	3.19	0	+0.027	●	SF16-DRA145M-○ SS16-DRA145M-○	
		1460M-HQP	14.6	3.21					
		1470M-HQP	14.7	3.22					
		1480M-HQP	14.8	3.24					
		1490M-HQP	14.9	3.25					
		1500M-HQP	15	3.33	0	+0.027	●	SF20-DRA150M-○ SS16-DRA150M-○	
		1510M-HQP	15.1	3.35					
		1520M-HQP	15.2	3.36					
		1530M-HQP	15.3	3.38					
		1540M-HQP	15.4	3.39					
		1550M-HQP	15.5	3.41					
		1560M-HQP	15.6	3.42					
		1570M-HQP	15.7	3.44					
1580M-HQP	15.8	3.46							
1590M-HQP	15.9	3.47							
1600M-HQP	16	3.55	0	+0.027	●	SF20-DRA160M-○ SS18-DRA160M-○			
1610M-HQP	16.1	3.57							
1620M-HQP	16.2	3.58							
1630M-HQP	16.3	3.6							
1640M-HQP	16.4	3.62							
1650M-HQP	16.5	3.63							
1660M-HQP	16.6	3.65							
1670M-HQP	16.7	3.66							
1680M-HQP	16.8	3.68							
1690M-HQP	16.9	3.69							
1700M-HQP	17	3.73	0	+0.027	●	SF20-DRA170M-○ SS18-DRA170M-○			
1710M-HQP	17.1	3.75							
1720M-HQP	17.2	3.77							
1730M-HQP	17.3	3.78							
1740M-HQP	17.4	3.8							
1750M-HQP	17.5	3.81							
1760M-HQP	17.6	3.83							
1770M-HQP	17.7	3.84							
1780M-HQP	17.8	3.86							
1790M-HQP	17.9	3.88							

k8 is the dimension tolerance of the insert. It is not the dimension tolerance of the hole diameter.

Recommended cutting conditions  K31

● : Standard item R : Right-hand only L : Left-hand only □ : Check availability

DA inserts are sold in 1 piece boxes

K
Drilling

DRA insert (HQP - Precision / for Carbon steel)

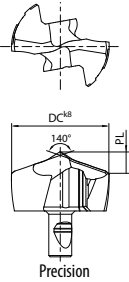
Insert		Description		Dimension (mm)		Tolerance		Carbide	Applicable toolholder K18~K21 K24~K28
				DC	PL	k8 (min.)	k8 (max.)		
								●	P
								●	M
								●	K
								●	N
		DA	1800M-HQP	18	3.97	0	+0.027	●	SF25-DRA180M-○ SS20-DRA180M-○
			1810M-HQP	18.1	3.98			●	
			1820M-HQP	18.2	4			●	
			1830M-HQP	18.3	4.02			●	
			1840M-HQP	18.4	4.03			●	
			1850M-HQP	18.5	4.05			●	
			1860M-HQP	18.6	4.06			●	
			1870M-HQP	18.7	4.08			●	
			1880M-HQP	18.8	4.09			●	
			1890M-HQP	18.9	4.11			●	
		DA	1900M-HQP	19	4.2	0	+0.033	●	SF25-DRA190M-○ SS20-DRA190M-○
			1910M-HQP	19.1	4.22			●	
			1920M-HQP	19.2	4.23			●	
			1930M-HQP	19.3	4.25			●	
			1940M-HQP	19.4	4.26			●	
			1950M-HQP	19.5	4.28			●	
			1960M-HQP	19.6	4.29			●	
			1970M-HQP	19.7	4.31			●	
			1980M-HQP	19.8	4.33			●	
			1990M-HQP	19.9	4.34			●	

k8 is the dimension tolerance of the insert. It is not the dimension tolerance of the hole diameter.

Recommended cutting conditions  K31

K



Drilling

- DRA
- DRC
- DRV
- DRZ
- DRXR
- DRW

● : Standard item R : Right-hand only L : Left-hand only □ : Check availability

DA inserts are sold in 1 piece boxes

DRA insert (HQS - For difficult-to-cut materials / stainless steel)

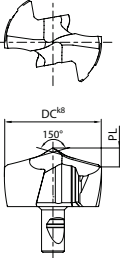
Insert		Description		Dimension (mm)		Tolerance		Carbide	Applicable toolholder K18~K21 K24~K28
				DC	PL	k8 (min.)	k8 (max.)		
				Carbon steel / Alloy steel					P
				Mold and die steel					
				Stainless steel				●	M
				Cast iron					K
				Non-ferrous metals					N
 	DA	0800M-HQS 0820M-HQS	8 8.2	1.76 1.78	0	+0.022	●	SF12-DRA080M-○ SS10-DRA080M-○	
	DA	0850M-HQS 0870M-HQS 0880M-HQS	8.5 8.7 8.8	1.82 1.85 1.86	0	+0.022	●	SF12-DRA085M-○ SS10-DRA085M-○	
	DA	0900M-HQS 0930M-HQS 0940M-HQS	9 9.3 9.4	1.97 2.01 2.02	0	+0.022	●	SF12-DRA090M-○ SS10-DRA090M-○	
	DA	0950M-HQS 0970M-HQS 0980M-HQS	9.5 9.7 9.8	2.03 2.05 2.06	0	+0.022	●	SF12-DRA095M-○ SS10-DRA095M-○	
	DA	1000M-HQS 1030M-HQS 1040M-HQS	10 10.3 10.4	2.17 2.21 2.22	0	+0.022 +0.027 +0.027	●	SF16-DRA100M-○ SS12-DRA100M-○	
	DA	1050M-HQS 1080M-HQS	10.5 10.8	2.23 2.27	0	+0.027	●	SF16-DRA105M-○ SS12-DRA105M-○	
	DA	1100M-HQS	11	2.38	0	+0.027	●	SF16-DRA110M-○ SS12-DRA110M-○	
	DA	1150M-HQS	11.5	2.44	0	+0.027	●	SF16-DRA115M-○ SS12-DRA115M-○	
	DA	1200M-HQS	12	2.5	0	+0.027	●	SF16-DRA120M-○ SS14-DRA120M-○	
	DA	1250M-HQS 1260M-HQS	12.5 12.6	2.57 2.58	0	+0.027	●	SF16-DRA125M-○ SS14-DRA125M-○	
	DA	1300M-HQS	13	2.68	0	+0.027	●	SF16-DRA130M-○ SS14-DRA130M-○	
	DA	1350M-HQS 1390M-HQS	13.5 13.9	2.74 2.78	0	+0.027	●	SF16-DRA135M-○ SS14-DRA135M-○	
	DA	1400M-HQS 1420M-HQS	14 14.2	2.79 2.81	0	+0.027	●	SF16-DRA140M-○ SS16-DRA140M-○	
	DA	1450M-HQS	14.5	2.85	0	+0.027	●	SF16-DRA145M-○ SS16-DRA145M-○	
	DA	1500M-HQS 1520M-HQS 1530M-HQS 1550M-HQS 1570M-HQS	15 15.2 15.3 15.5 15.7	2.96 2.99 3 3.02 3.04	0	+0.027	●	SF20-DRA150M-○ SS16-DRA150M-○	
	DA	1600M-HQS 1610M-HQS 1620M-HQS 1630M-HQS 1650M-HQS	16 16.1 16.2 16.3 16.5	3.18 3.2 3.21 3.22 3.25	0	+0.027	●	SF20-DRA160M-○ SS18-DRA160M-○	
	DA	1700M-HQS 1750M-HQS 1770M-HQS	17 17.5 17.7	3.38 3.44 3.46	0	+0.027	●	SF20-DRA170M-○ SS18-DRA170M-○	
	DA	1800M-HQS 1810M-HQS 1850M-HQS	18 18.1 18.5	3.59 3.6 3.65	0	+0.027 +0.033 +0.033	●	SF25-DRA180M-○ SS20-DRA180M-○	
	DA	1900M-HQS 1930M-HQS 1950M-HQS	19 19.3 19.5	3.79 3.82 3.84	0	+0.033	●	SF25-DRA190M-○ SS20-DRA190M-○	

k8 is the dimension tolerance of the insert. It is not the dimension tolerance of the hole diameter.

Recommended cutting conditions ➔ **K31**

● : Standard item R : Right-hand only L : Left-hand only □ : Check availability

DA inserts are sold in 1 piece boxes



SS-DRA (Drilling depth : 1.5 x DC)

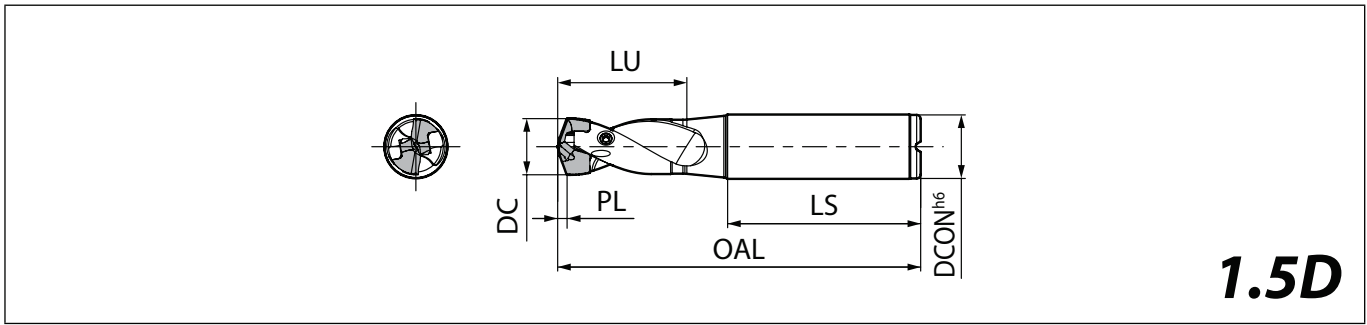

For PL indicates distance from drill point to corner edge K6~K17

Toolholder dimensions

Description	Availability	Dimension (mm)						Coolant hole	Spare parts			Applicable inserts K6~K17	Applicable chamfering attachment K22
		DC min.	DC max.	DCON	OAL	LU	LS		Screw	Wrench	Wrench		
SS10- DRA080M-1.5 DRA085M-1.5 DRA090M-1.5 DRA095M-1.5	●	7.94	8.49	10	66.2	12.8	40	Yes	HS-2524TRP	-	FTP-5	DA0794M-...~DA0840M-...	S20-CH10-DRA
	●	8.5	8.99		67.5	13.5						DA0850M-...~DA0890M-...	
	●	9	9.49		68.7	14.3						DA0900M-...~DA0940M-...	
	●	9.5	9.99		70	15						DA0950M-...~DA0990M-...	
SS12- DRA100M-1.5 DRA105M-1.5 DRA110M-1.5 DRA115M-1.5	●	10	10.49	12	76.2	15.8	45	Yes	HS-2534TRP	-	FTP-5	DA1000M-...~DA1040M-...	S32-CH12-DRA
	●	10.5	10.99		77.5	16.5						DA1050M-...~DA1090M-...	
	●	11	11.49		79.7	17.3						DA1100M-...~DA1140M-...	
	●	11.5	11.99		81	18						DA1150M-...~DA1190M-...	
SS14- DRA120M-1.5 DRA125M-1.5 DRA130M-1.5 DRA135M-1.5	●	12	12.49	14	82.2	18.8	45	Yes	HS-2534TRP	-	FTP-5	DA1200M-...~DA1240M-...	S32-CH14-DRA
	●	12.5	12.99		83.5	19.5						DA1250M-...~DA1290M-...	
	●	13	13.49		84.7	20.3						DA1300M-...~DA1340M-...	
	●	13.5	13.99		86	21						DA1350M-...~DA1390M-...	
SS16- DRA140M-1.5 DRA145M-1.5 DRA150M-1.5	●	14	14.49	16	90.2	21.8	48	Yes	HS-3048TRP	DTP-6	-	DA1400M-...~DA1440M-...	S32-CH16-DRA
	●	14.5	14.99		91.5	22.5						DA1450M-...~DA1490M-...	
	●	15	15.99		95	24						DA1500M-...~DA1590M-...	
SS18- DRA160M-1.5 DRA170M-1.5	●	16	16.99	18	98.5	25.5	48	Yes	HS-3048TRP	DTP-6	-	DA1600M-...~DA1690M-...	S32-CH18-DRA
	●	17	17.99		101	27						DA1700M-...~DA1790M-...	
SS20- DRA180M-1.5 DRA190M-1.5	●	18	18.99	20	106.5	28.5	50	Yes	HS-4067TRP	DTP-7	-	DA1800M-...~DA1890M-...	S32-CH20-DRA
	●	19	19.99		109	30						DA1900M-...~DA1990M-...	
SS25- DRA200M-1.5 DRA210M-1.5 DRA220M-1.5 DRA230M-1.5 DRA240M-1.5	●	20	20.99	25	117.5	31.5	56	Yes	HS-4067TRP	DTP-7	-	DA2000M-...~DA2090M-...	-
	●	21	21.99		120	33						DA2100M-...~DA2150M-...	
	●	22	22.99		123.5	34.5						DA2200M-...~DA2250M-...	
	●	23	23.99		126	36						DA2300M-...~DA2350M-...	
	●	24	24.99		128.5	37.5						DA2400M-...~DA2450M-...	
SS32- DRA250M-1.5	●	25	25.5	32	135	39	60	Yes	HS-4067TRP	DTP-7	-	DA2500M-...~DA2550M-...	-

Description Identification System (Toolholder)

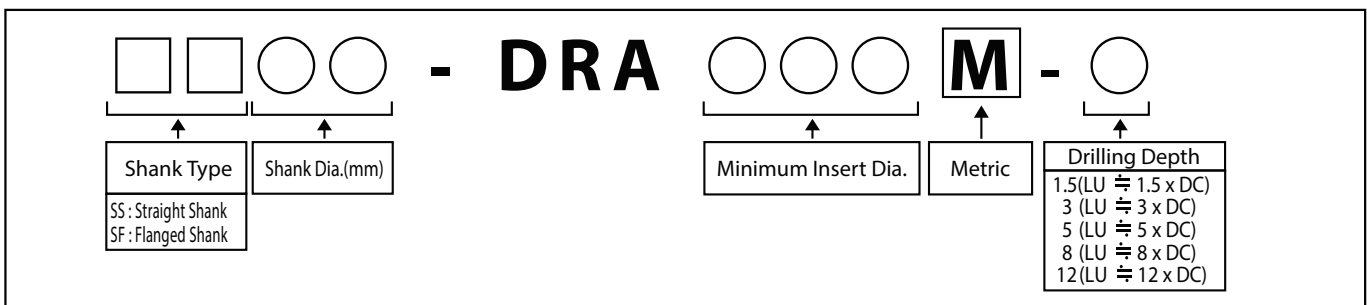

● : Standard item R : Right-hand only L : Left-hand only □ : Check availability

SS-DRA (Drilling depth : 3 x DC)

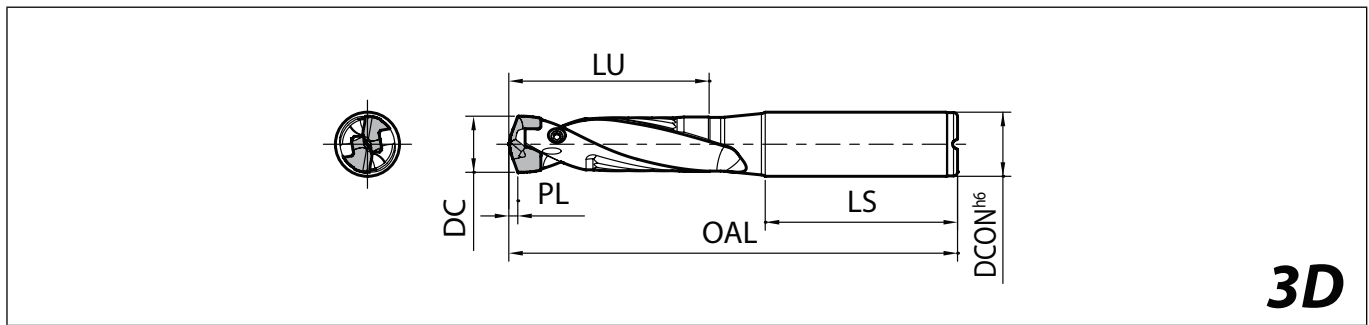

For PL indicates distance from drill point to corner edge K6~K17

Toolholder dimensions

Description	Availability	Dimension (mm)						Coolant hole	Spare parts			Applicable inserts K6~K17	Applicable chamfering attachment K22
		DC min.	DC max.	DCON	OAL	LU	LS		Screw	Wrench	Wrench		
SS10- DRA080M-3	●	7.94	8.49	10	79	25.5	40	Yes	HS-2524TRP	-	FTP-5	DA0794M-...~DA0840M-...	S20-CH10-DRA
DRA085M-3	●	8.5	8.99		81	27						DA0850M-...~DA0890M-...	
DRA090M-3	●	9	9.49		83	28.5						DA0900M-...~DA0940M-...	
DRA095M-3	●	9.5	9.99		85	30						DA0950M-...~DA0990M-...	
SS12- DRA100M-3	●	10	10.49	12	92	31.5	45	Yes	HS-2534TRP	-	FTP-5	DA1000M-...~DA1040M-...	S32-CH12-DRA
DRA105M-3	●	10.5	10.99		94	33						DA1050M-...~DA1090M-...	
DRA110M-3	●	11	11.49		97	34.5						DA1100M-...~DA1140M-...	
DRA115M-3	●	11.5	11.99		99	36						DA1150M-...~DA1190M-...	
SS14- DRA120M-3	●	12	12.49	14	101	37.5	45	Yes	HS-2534TRP	-	FTP-5	DA1200M-...~DA1240M-...	S32-CH14-DRA
DRA125M-3	●	12.5	12.99		103	39						DA1250M-...~DA1290M-...	
DRA130M-3	●	13	13.49		105	40.5						DA1300M-...~DA1340M-...	
DRA135M-3	●	13.5	13.99		107	42						DA1350M-...~DA1390M-...	
SS16- DRA140M-3	●	14	14.49	16	112	43.5	48	Yes	HS-3048TRP	DTP-6	-	DA1400M-...~DA1440M-...	S32-CH16-DRA
DRA145M-3	●	14.5	14.99		114	45						DA1450M-...~DA1490M-...	
DRA150M-3	●	15	15.99		119	48						DA1500M-...~DA1590M-...	
SS18- DRA160M-3	●	16	16.99	18	124	51	48	Yes	HS-3048TRP	DTP-6	-	DA1600M-...~DA1690M-...	S32-CH18-DRA
DRA170M-3	●	17	17.99		128	54						DA1700M-...~DA1790M-...	
SS20- DRA180M-3	●	18	18.99	20	135	57	50	Yes	HS-4067TRP	DTP-7	-	DA1800M-...~DA1890M-...	S32-CH20-DRA
DRA190M-3	●	19	19.99		139	60						DA1900M-...~DA1990M-...	
SS25- DRA200M-3	●	20	20.99	25	149	63	56	Yes	HS-4067TRP	DTP-7	-	DA2000M-...~DA2090M-...	-
DRA210M-3	●	21	21.99		153	66						DA2100M-...~DA2150M-...	
DRA220M-3	●	22	22.99		158	69						DA2200M-...~DA2250M-...	
DRA230M-3	●	23	23.99		162	72						DA2300M-...~DA2350M-...	
DRA240M-3	●	24	24.99		166	75						DA2400M-...~DA2450M-...	
SS32- DRA250M-3	●	25	25.5	32	174	78	60	Yes	HS-4067TRP	DTP-7	-	DA2500M-...~DA2550M-...	-



● : Standard item R : Right-hand only L : Left-hand only □ : Check availability

SS-DRA (Drilling depth : 5 x DC)

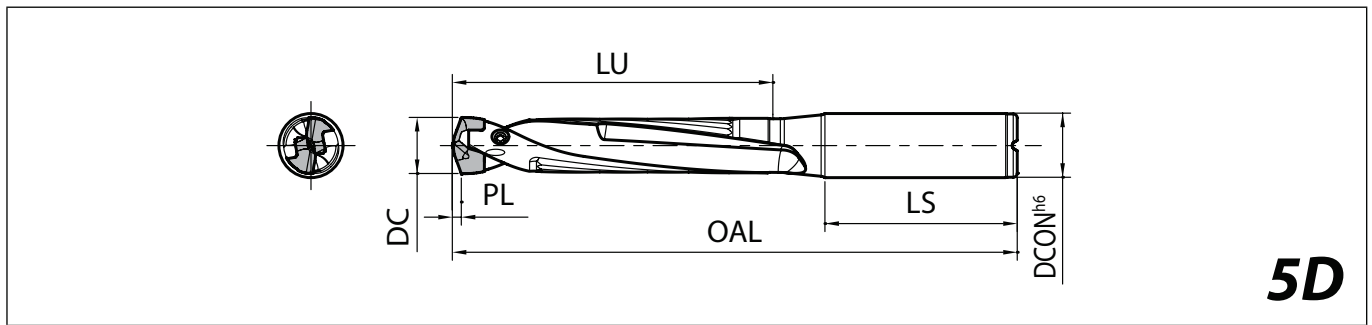

For PL indicates distance from drill point to corner edge K6~K17

Toolholder dimensions

Description	Availability	Dimension (mm)						Coolant hole	Spare parts			Applicable inserts K6~K17	Applicable chamfering attachment K22
		DC min.	DC max.	DCON	OAL	LU	LS		Screw	Wrench	Wrench		
SS10- DRA080M-5 DRA085M-5 DRA090M-5 DRA095M-5	●	7.94	8.49	10	96	42.5	40	Yes	HS-2524TRP	-	FTP-5	DA0794M-...~DA0840M-...	S20-CH10-DRA
	●	8.5	8.99		99	45						DA0850M-...~DA0890M-...	
	●	9	9.49		102	47.5						DA0900M-...~DA0940M-...	
	●	9.5	9.99		105	50						DA0950M-...~DA0990M-...	
SS12- DRA100M-5 DRA105M-5 DRA110M-5 DRA115M-5	●	10	10.49	12	113	52.5	45	Yes	HS-2534TRP	-	FTP-5	DA1000M-...~DA1040M-...	S32-CH12-DRA
	●	10.5	10.99		116	55						DA1050M-...~DA1090M-...	
	●	11	11.49		120	57.5						DA1100M-...~DA1140M-...	
	●	11.5	11.99		123	60						DA1150M-...~DA1190M-...	
SS14- DRA120M-5 DRA125M-5 DRA130M-5 DRA135M-5	●	12	12.49	14	126	62.5	45	Yes	HS-2534TRP	-	FTP-5	DA1200M-...~DA1240M-...	S32-CH14-DRA
	●	12.5	12.99		129	65						DA1250M-...~DA1290M-...	
	●	13	13.49		132	67.5						DA1300M-...~DA1340M-...	
	●	13.5	13.99		135	70						DA1350M-...~DA1390M-...	
SS16- DRA140M-5 DRA145M-5 DRA150M-5	●	14	14.49	16	141	72.5	48	Yes	HS-3048TRP	DTP-6	-	DA1400M-...~DA1440M-...	S32-CH16-DRA
	●	14.5	14.99		144	75						DA1450M-...~DA1490M-...	
	●	15	15.99		151	80						DA1500M-...~DA1590M-...	
SS18- DRA160M-5 DRA170M-5	●	16	16.99	18	158	85	48	Yes	HS-3048TRP	DTP-6	-	DA1600M-...~DA1690M-...	S32-CH18-DRA
	●	17	17.99		164	90						DA1700M-...~DA1790M-...	
SS20- DRA180M-5 DRA190M-5	●	18	18.99	20	173	95	50	Yes	HS-4067TRP	DTP-7	-	DA1800M-...~DA1890M-...	S32-CH20-DRA
	●	19	19.99		179	100						DA1900M-...~DA1990M-...	
SS25- DRA200M-5 DRA210M-5 DRA220M-5 DRA230M-5 DRA240M-5	●	20	20.99	25	191	105	56	Yes	HS-4067TRP	DTP-7	-	DA2000M-...~DA2090M-...	-
	●	21	21.99		197	110						DA2100M-...~DA2150M-...	
	●	22	22.99		204	115						DA2200M-...~DA2250M-...	
	●	23	23.99		210	120						DA2300M-...~DA2350M-...	
	●	24	24.99		216	125						DA2400M-...~DA2450M-...	
SS32- DRA250M-5	●	25	25.5	32	226	130	60	Yes	HS-4067TRP	DTP-7	-	DA2500M-...~DA2550M-...	-

● : Standard item R : Right-hand only L : Left-hand only □ : Check availability

SS-DRA (Drilling depth : 8 x DC)

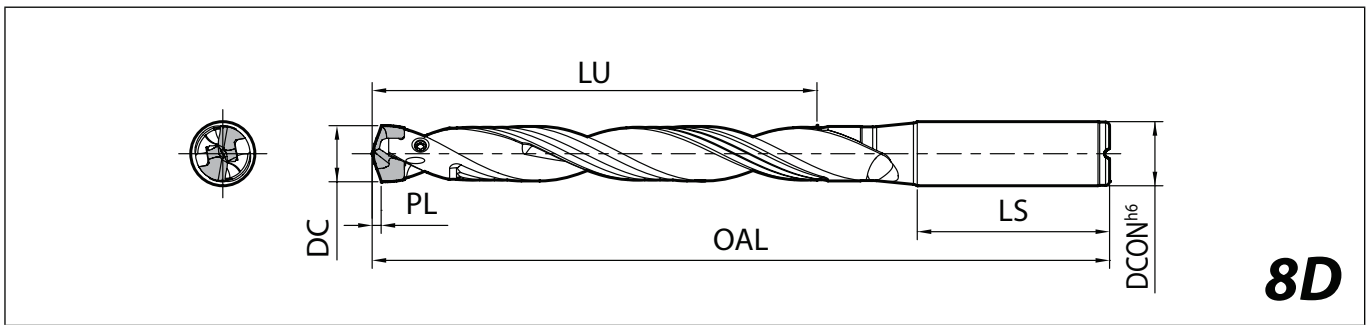

For PL indicates distance from drill point to corner edge K6~K17

Toolholder dimensions

Description	Availability	Dimension (mm)						Coolant hole	Spare parts			Applicable inserts K6~K17	Applicable chamfering attachment K22
		DC min.	DC max.	DCON	OAL	LU	LS		Screw	Wrench	Wrench		
SS10- DRA080M-8 DRA085M-8 DRA090M-8 DRA095M-8	●	7.94	8.49	10	121	68	40	Yes	HS-2524TRP	-	FTP-5	DA0794M-...~DA0840M-...	S20-CH10-DRA
	●	8.5	8.99		126	72						DA0850M-...~DA0890M-...	
	●	9	9.49		130	76						DA0900M-...~DA0940M-...	
	●	9.5	9.99		135	80						DA0950M-...~DA0990M-...	
SS12- DRA100M-8 DRA105M-8 DRA110M-8 DRA115M-8	●	10	10.49	12	144	84	45	Yes	HS-2534TRP	-	FTP-5	DA1000M-...~DA1040M-...	S32-CH12-DRA
	●	10.5	10.99		149	88						DA1050M-...~DA1090M-...	
	●	11	11.49		154	92						DA1100M-...~DA1140M-...	
	●	11.5	11.99		159	96						DA1150M-...~DA1190M-...	
SS14- DRA120M-8 DRA125M-8 DRA130M-8 DRA135M-8	●	12	12.49	14	163	100	45	Yes	HS-2534TRP	-	FTP-5	DA1200M-...~DA1240M-...	S32-CH14-DRA
	●	12.5	12.99		168	104						DA1250M-...~DA1290M-...	
	●	13	13.49		172	108						DA1300M-...~DA1340M-...	
	●	13.5	13.99		177	112						DA1350M-...~DA1390M-...	
SS16- DRA140M-8 DRA145M-8 DRA150M-8	●	14	14.49	16	184	116	48	Yes	HS-3048TRP	DTP-6	-	DA1400M-...~DA1440M-...	S32-CH16-DRA
	●	14.5	14.99		189	120						DA1450M-...~DA1490M-...	
	●	15	15.99		199	128						DA1500M-...~DA1590M-...	
SS18- DRA160M-8 DRA170M-8	●	16	16.99	18	209	136	48	Yes	HS-3048TRP	DTP-6	-	DA1600M-...~DA1690M-...	S32-CH18-DRA
	●	17	17.99		218	144						DA1700M-...~DA1790M-...	
SS20- DRA180M-8 DRA190M-8	●	18	18.99	20	230	152	50	Yes	HS-4067TRP	DTP-7	-	DA1800M-...~DA1890M-...	S32-CH20-DRA
	●	19	19.99		239	160						DA1900M-...~DA1990M-...	
SS25- DRA200M-8 DRA210M-8 DRA220M-8 DRA230M-8 DRA240M-8	●	20	20.99	25	254	168	56	Yes	HS-4067TRP	DTP-7	-	DA2000M-...~DA2090M-...	-
	●	21	21.99		263	176						DA2100M-...~DA2150M-...	
	●	22	22.99		273	184						DA2200M-...~DA2250M-...	
	●	23	23.99		282	192						DA2300M-...~DA2350M-...	
	●	24	24.99		291	200						DA2400M-...~DA2450M-...	
SS32- DRA250M-8	●	25	25.5	32	304	208	60	Yes	HS-4067TRP	DTP-7	-	DA2500M-...~DA2550M-...	-



● : Standard item R : Right-hand only L : Left-hand only □ : Check availability

Chamfering attachment

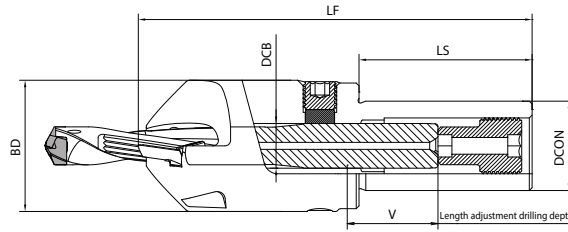

Dimensions

Description	Availability	Applicable drill shank dia. DCB	Dimension (mm)					Applicable inserts
			DCON	BD	LF	LS	V(Max.)	
S20-CH10-DRA	●	10	20	39	110	52	18	CT12T3-45DA
S32-CH12-DRA	●	12	32	43	130	62	24	
S32-CH14-DRA	●	14	32	45	130	62	24	
S32-CH16-DRA	●	16	32	47	141	62	24	
S32-CH18-DRA	●	18	32	49	145	62	24	
S32-CH20-DRA	●	20	32	53	150	62	24.5	

Applicable inserts

Insert	Description	MEGACOAT NANO	Dimension (mm)	
		PR1535	W1	S
	CT12T3-45DA	●	13.54	3.97

K

Drilling depth and chamfering dimension

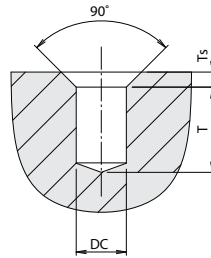







Drilling

Drill dia. (mm) DC		Drilling depth (mm)						Chamfering dimension (mm)		Applicable chamfering holder
		T (3D Drill)		T (5D Drill)		T (8D Drill)		Ts	Ts max.	
min.	max.	min.	max.	min.	max.	min.	max.			
7.94	8.49	12.5	20	18	36	43	60	2.5	8	S20-CH10-DRA
8.50	8.99	12.5	21.5	21.5	38.5	48	64			
9.00	9.49	12.5	23	24	41	52	68			
9.50	9.99	12.5	24.5	27.5	43.5	57.5	72.5			
10.00	10.49	15.5	26	22	46	52	76	4	8	S32-CH12-DRA
10.50	10.99	16	27.5	24.5	48.5	56	80			
11.00	11.49	16.5	29	27	51	60	84			
11.50	11.99	17.5	30.5	29.5	53.5	64	88			
12.00	12.49	18	32	32	56	68	92	4	8	S32-CH14-DRA
12.50	12.99	19	34	35	59	72.5	96.5			
13.00	13.49	19.5	35.5	37.5	61.5	76	100			
13.50	13.99	20	36.5	39.5	63.5	80	104			
14.00	14.49	21	38.5	42.5	66.5	84.5	108.5	4	8	S32-CH16-DRA
14.50	14.99	21.5	40	45	69	88.5	112.5			
15.00	15.99	22.5	41.5	47.5	71.5	92.5	116.5			
16.00	16.99	24	44.5	52.5	76.5	100.5	124.5			
17.00	17.99	25.5	47.5	57.5	81.5	108.5	132.5	4	8	S32-CH18-DRA
18.00	18.99	27.5	51	64	87	121	141			
19.00	19.99	29.5	54	69	92	129	149	4	8	S32-CH20-DRA

Ts: Maximum chamfer depth with recommended cutting conditions for DRA
 Ts max.: Adjusting cutting conditions, such as reducing feed to 50% and/or lower cutting speed, is required.

● : Standard item R : Right-hand only L : Left-hand only □ : Check availability

Spare parts

Chamfering holder	Adjustment screw		For fixing drills				For mounting inserts			
			Clamp	Clamp screw		Plunge screw	Clamp	Clamp screw	Wrench	
Description		Hexagon hole two side widths			Hexagon hole two side widths	Tightening torque (N·m)				
S20-CH10-DRA	AJ-12X22	6	CP-CH10	HS8X8	4	12	BNP6	C09N	W6X18N	DTM-15
S32-CH12-DRA	AJ-16X30		CP-CH12			15				
S32-CH14-DRA	AJ-20X30		CP-CH14	HS10X10	5	20				
S32-CH16-DRA		CP-CH16	30							
S32-CH18-DRA	AJ-22X35	10	CP-CH18	HS12X10	6	30				
S32-CH20-DRA			CP-CH20			HS16X10				

Method to use DRA chamfering attachment

1. Mount DRA drill into the chamfering attachment.



Fig. 1 Install the DRA

2. Install an insert and tighten temporarily with clearance between the cutting edge and DRA body.

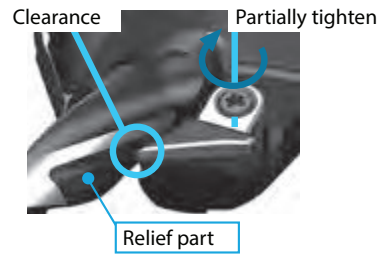

Fig. 2 Install inserts

3. Adjust drilling depth by turning adjustment screw with hexagon wrench

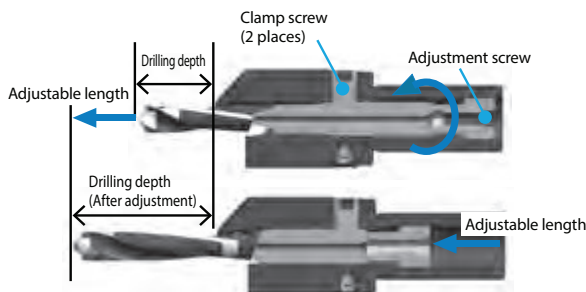

Fig. 3 Adjustment of drilling depth

4. Align the flute edge and black relief part of the drill to the position shown in Fig.4 by rotating the DRA drill.

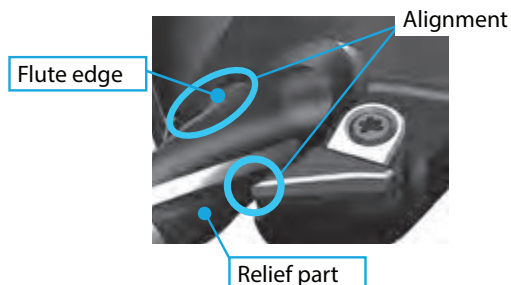

Fig. 4 DRA alignment

5. Fasten the two clamp screws for DRA (See Table 1. for recommended torque)

Table 1 Recommended torque

Chamfering attachment	Clamp screw	
	Recommended torque (N·m)	Hexagon hole two side widths
S20-CH10-DRA	12	4
S32-CH12-DRA	15	
S32-CH14-DRA	20	5
S32-CH16-DRA	30	6
S32-CH18-DRA	30	
S32-CH20-DRA	45	8

6. Tighten the inserts while lightly pressing the edge of insert against the relief part. (Recommended torque 3.5N·m)

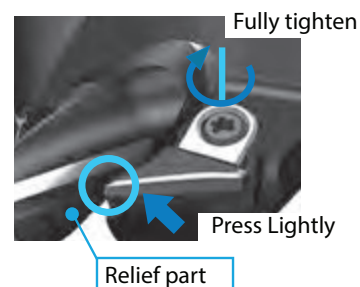

Fig. 5 Fully tighten

Cautions

- Chamfering attachment is dedicated for straight shank SS-DRA.
- It cannot be used for flanged shank SF-DRA.
- Chamfering requires two chamfering inserts. Using one insert is not recommended.
- Only fully remove clamp screws when replacing them.

- Clamps and clamp screws for mounting inserts need to be replaced regularly
- Screw locking adhesive is applied to adjustment screw. The effect will eventually wear off if the screws are used for a long time. Regular replacement is recommended.
- Please do not operate the plunge screws.

K
Drilling

SF-DRA (Drilling depth : 1.5 x DC)

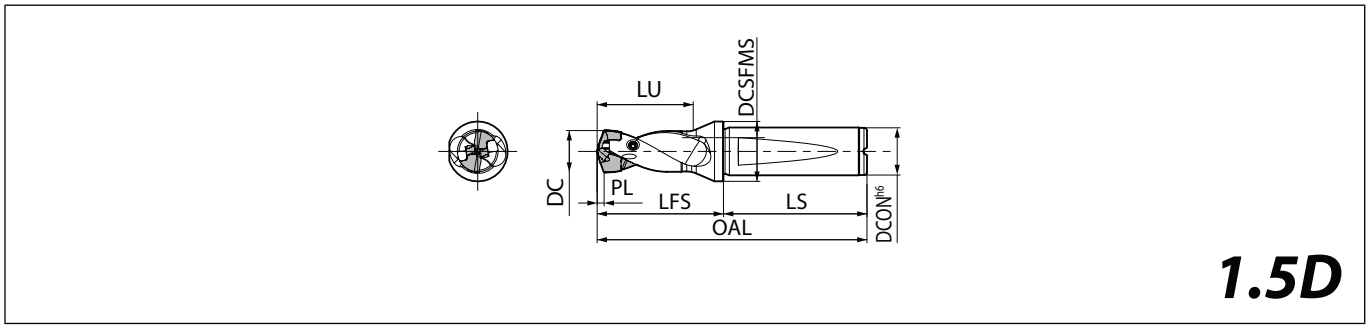

For PL indicates distance from drill point to corner edge K6~K17

Toolholder dimensions

Description	Availability	Dimension (mm)								Coolant hole	Spare parts			Applicable inserts K6~K17									
		DC min.	DC max.	DCON	OAL	LFS	LU	LS	DCSFMS		Screw	Wrench	Wrench										
		K									Drilling				DRA			DRC			DRV		
SF12- DRA080M-1.5	●	7.94	8.49	12	71.2	26.2	12.8	45	16	Yes	HS-2524TRP	-	FTP-5	DA0794M-...~DA0840M-...									
DRA085M-1.5	●	8.5	8.99		72.5	27.5	13.5							DA0850M-...~DA0890M-...									
DRA090M-1.5	●	9	9.49		73.7	28.7	14.3							DA0900M-...~DA0940M-...									
DRA095M-1.5	●	9.5	9.99		75	30	15							DA0950M-...~DA0990M-...									
SF16- DRA100M-1.5	●	10	10.49	16	79.2	31.2	15.8	48	20	Yes	HS-2534TRP	-	FTP-5	DA1000M-...~DA1040M-...									
DRA105M-1.5	●	10.5	10.99		80.5	32.5	16.5							DA1050M-...~DA1090M-...									
DRA110M-1.5	●	11	11.49		82.7	34.7	17.3							DA1100M-...~DA1140M-...									
DRA115M-1.5	●	11.5	11.99		84	36	18							DA1150M-...~DA1190M-...									
DRA120M-1.5	●	12	12.49		85.2	37.2	18.8							DA1200M-...~DA1240M-...									
DRA125M-1.5	●	12.5	12.99		86.5	38.5	19.5							DA1250M-...~DA1290M-...									
DRA130M-1.5	●	13	13.49		87.7	39.7	20.3							DA1300M-...~DA1340M-...									
DRA135M-1.5	●	13.5	13.99		89	41	21							DA1350M-...~DA1390M-...									
DRA140M-1.5	●	14	14.49		90.2	42.2	21.8							DA1400M-...~DA1440M-...									
DRA145M-1.5	●	14.5	14.99		91.5	43.5	22.5							DA1450M-...~DA1490M-...									
SF20- DRA150M-1.5	●	15	15.99	20	97	47	24	50	25	Yes	HS-3048TRP	DTP-6	-	DA1500M-...~DA1590M-...									
DRA160M-1.5	●	16	16.99		100.5	50.5	25.5							DA1600M-...~DA1690M-...									
DRA170M-1.5	●	17	17.99		103	53	27							DA1700M-...~DA1790M-...									
SF25- DRA180M-1.5	●	18	18.99	25	112.5	56.5	28.5	56	32	Yes	HS-4067TRP	DTP-7	-	DA1800M-...~DA1890M-...									
DRA190M-1.5	●	19	19.99		115	59	30							DA1900M-...~DA1990M-...									
DRA200M-1.5	●	20	20.99		117.5	61.5	31.5							DA2000M-...~DA2090M-...									
DRA210M-1.5	●	21	21.99		120	64	33							DA2100M-...~DA2150M-...									
DRA220M-1.5	●	22	22.99		123.5	67.5	34.5							DA2200M-...~DA2250M-...									
DRA230M-1.5	●	23	23.99		126	70	36							DA2300M-...~DA2350M-...									
DRA240M-1.5	●	24	24.99		128.5	72.5	37.5							DA2400M-...~DA2450M-...									
DRA250M-1.5	●	25	25.5		131	75	39							DA2500M-...~DA2550M-...									

Description Identification System (Toolholder)

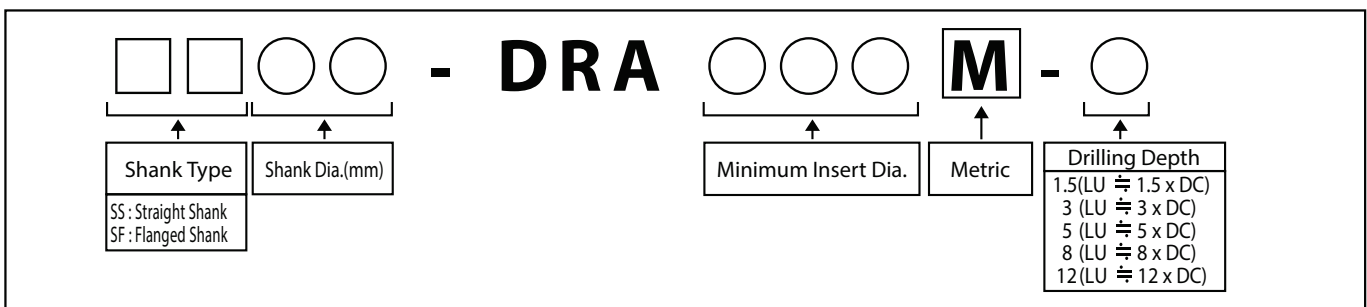

● : Standard item R : Right-hand only L : Left-hand only □ : Check availability

SF-DRA (Drilling depth : 3 x DC)

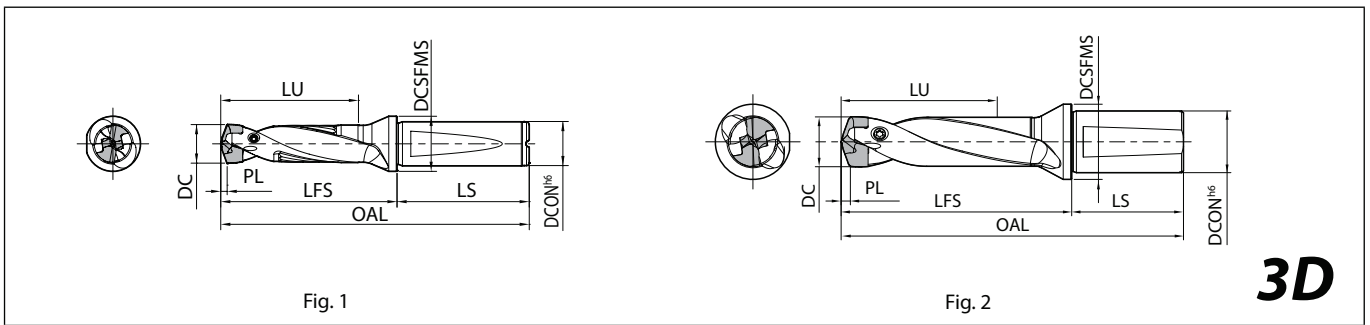

For PL indicates distance from drill point to corner edge K6~K17

Toolholder dimensions

Description	Availability	Dimension (mm)								Coolant hole	Fig.	Spare parts			Applicable inserts K6~K17									
		DC min.	DC max.	DCON	OAL	LFS	LU	LS	DCSFMS			Screw	Wrench	Wrench										
SF12- DRA080M-3 DRA085M-3 DRA090M-3 DRA095M-3	● ● ● ●	7.94 8.5 9 9.5	8.49 8.99 9.49 9.99	12	84 86 88 90	39 41 43 45	25.5 27	45	16	Yes	1	HS-2524TRP	-	FTP-5	DA0794M-...~DA0840M-...									
																							DA0850M-...~DA0890M-...	
																								DA0900M-...~DA0940M-...
																								DA0950M-...~DA0990M-...
SF16- DRA100M-3 DRA105M-3 DRA110M-3 DRA115M-3 DRA120M-3 DRA125M-3 DRA130M-3 DRA135M-3 DRA140M-3 DRA145M-3	● ● ● ● ● ● ● ● ● ● ●	10 10.5 11 11.5 12 12.5 13 13.5 14 14.5	10.49 10.99 11.49 11.99 12.49 12.99 13.49 13.99 14.49 14.99	16	95 97 100 102 104 106 108 110 112 114	47 49 52 54 56 58 60 62 64 66	31.5 33 34.5 36 37.5 39 40.5 42 43.5 45	48	20	Yes	1	HS-2534TRP	-	FTP-5	DA1000M-...~DA1040M-...									
																								DA1050M-...~DA1090M-...
																								DA1100M-...~DA1140M-...
																								DA1150M-...~DA1190M-...
																								DA1200M-...~DA1240M-...
																								DA1250M-...~DA1290M-...
																								DA1300M-...~DA1340M-...
																								DA1350M-...~DA1390M-...
																								DA1400M-...~DA1440M-...
																								DA1450M-...~DA1490M-...
SF20- DRA150M-3 DRA160M-3 DRA170M-3	● ● ●	15 16 17	15.99 16.99 17.99	20	121 126 130	71 76 80	48 51 54	50	25	Yes	1	HS-3048TRP	DTP-6	-	DA1500M-...~DA1590M-...									
																								DA1600M-...~DA1690M-...
																								DA1700M-...~DA1790M-...
SF25- DRA180M-3 DRA190M-3 DRA200M-3 DRA210M-3 DRA220M-3 DRA230M-3 DRA240M-3 DRA250M-3	● ● ● ● ● ● ● ● ●	18 19 20 21 22 23 24 25	18.99 19.99 20.99 21.99 22.99 23.99 24.99 25.99	25	141 145 149 153 158 162 166 170	85 89 93 97 102 106 110 114	57 60 63 66 69 72 75 78	56	32	Yes	1	HS-4067TRP	DTP-7	-	DA1800M-...~DA1890M-...									
																								DA1900M-...~DA1990M-...
																								DA2000M-...~DA2090M-...
																								DA2100M-...~DA2150M-...
																								DA2200M-...~DA2250M-...
																								DA2300M-...~DA2350M-...
																								DA2400M-...~DA2450M-...
																								DA2500M-...~DA2550M-...
SF32- DRA260M-3 DRA270M-3 DRA280M-3 DRA290M-3 DRA300M-3 DRA310M-3 DRA320M-3	● ● ● ● ● ● ●	26 27 28 29 30 31 32	26.99 27.99 28.99 29.99 30.99 31.99 33	32	178 181 185 189 193 196 200	120 123 127 131 135 138 142	81 84 87 90 93 96 99	58	39	Yes	2	HS-50100TRP	DTPM-15	-	DA2600M-...~DA2650M-...									
																								DA2700M-...~DA2750M-...
																								DA2800M-...~DA2850M-...
																								DA2900M-...~DA2950M-...
																								DA3000M-...~DA3050M-...
																								DA3100M-...~DA3150M-...
																								DA3200M-...~DA3300M-...

● : Standard item R : Right-hand only L : Left-hand only □ : Check availability



SF-DRA (Drilling depth : 5 x DC)

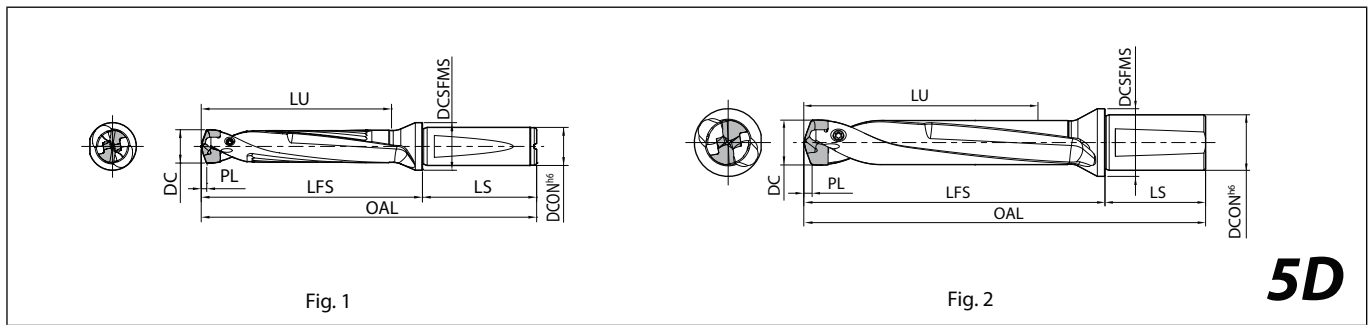

For PL indicates distance from drill point to corner edge K6~K17

Toolholder dimensions

Description	Availability	Dimension (mm)								Coolant hole	Fig.	Spare parts			Applicable inserts K6~K17									
		DC min.	DC max.	DCON	OAL	LFS	LU	LS	DCSFMS			Screw	Wrench	Wrench										
		[Icons: Screw, Wrench, Wrench]																						
SF12- DRA080M-5 DRA085M-5 DRA090M-5 DRA095M-5	●	7.94	8.49	12	101	56	42.5	45	16	Yes	1	HS-2524TRP	-	FTP-5	DA0794M-...~DA0840M-...									
	●	8.5	8.99		104	59	45								DA0850M-...~DA0890M-...									
	●	9	9.49		107	62	47.5								DA0900M-...~DA0940M-...									
	●	9.5	9.99		110	65	50								DA0950M-...~DA0990M-...									
SF16- DRA100M-5 DRA105M-5 DRA110M-5 DRA115M-5 DRA120M-5 DRA125M-5 DRA130M-5 DRA135M-5 DRA140M-5 DRA145M-5	●	10	10.49	16	116	68	52.5	48	20	Yes	1	HS-2534TRP	-	FTP-5	DA1000M-...~DA1040M-...									
	●	10.5	10.99		119	71	55								DA1050M-...~DA1090M-...									
	●	11	11.49		123	75	57.5								DA1100M-...~DA1140M-...									
	●	11.5	11.99		126	78	60								DA1150M-...~DA1190M-...									
	●	12	12.49		129	81	62.5								DA1200M-...~DA1240M-...									
	●	12.5	12.99		132	84	65								DA1250M-...~DA1290M-...									
	●	13	13.49		135	87	67.5								DA1300M-...~DA1340M-...									
	●	13.5	13.99		138	90	70								DA1350M-...~DA1390M-...									
	●	14	14.49		141	93	72.5								DA1400M-...~DA1440M-...									
	●	14.5	14.99		144	96	75								DA1450M-...~DA1490M-...									
	SF20- DRA150M-5 DRA160M-5 DRA170M-5	●	15		15.99	20	153								103	80	50	25	Yes	1	HS-3048TRP	DTP-6	-	DA1500M-...~DA1590M-...
		●	16		16.99		160								110	85								DA1600M-...~DA1690M-...
●		17	17.99	166	116		90	DA1700M-...~DA1790M-...																
SF25- DRA180M-5 DRA190M-5 DRA200M-5 DRA210M-5 DRA220M-5 DRA230M-5 DRA240M-5 DRA250M-5	●	18	18.99	25	179	123	95	56	32	Yes	1	HS-4067TRP	DTP-7	-	DA1800M-...~DA1890M-...									
	●	19	19.99		185	129	100								DA1900M-...~DA1990M-...									
	●	20	20.99		191	135	105								DA2000M-...~DA2090M-...									
	●	21	21.99		197	141	110								DA2100M-...~DA2150M-...									
	●	22	22.99		204	148	115								DA2200M-...~DA2250M-...									
	●	23	23.99		210	154	120								DA2300M-...~DA2350M-...									
	●	24	24.99		216	160	125								DA2400M-...~DA2450M-...									
	●	25	25.99		222	166	130								DA2500M-...~DA2550M-...									
SF32- DRA260M-5 DRA270M-5 DRA280M-5 DRA290M-5 DRA300M-5 DRA310M-5 DRA320M-5	●	26	26.99	32	232	174	135	58	39	Yes	2	HS-50100TRP	DTPM-15	-	DA2600M-...~DA2650M-...									
	●	27	27.99		237	179	140								DA2700M-...~DA2750M-...									
	●	28	28.99		243	185	145								DA2800M-...~DA2850M-...									
	●	29	29.99		249	191	150								DA2900M-...~DA2950M-...									
	●	30	30.99		255	197	155								DA3000M-...~DA3050M-...									
	●	31	31.99		260	202	160								DA3100M-...~DA3150M-...									
	●	32	33		266	208	165								DA3200M-...~DA3300M-...									

● : Standard item R : Right-hand only L : Left-hand only □ : Check availability

SF-DRA (Drilling depth : 8 x DC)

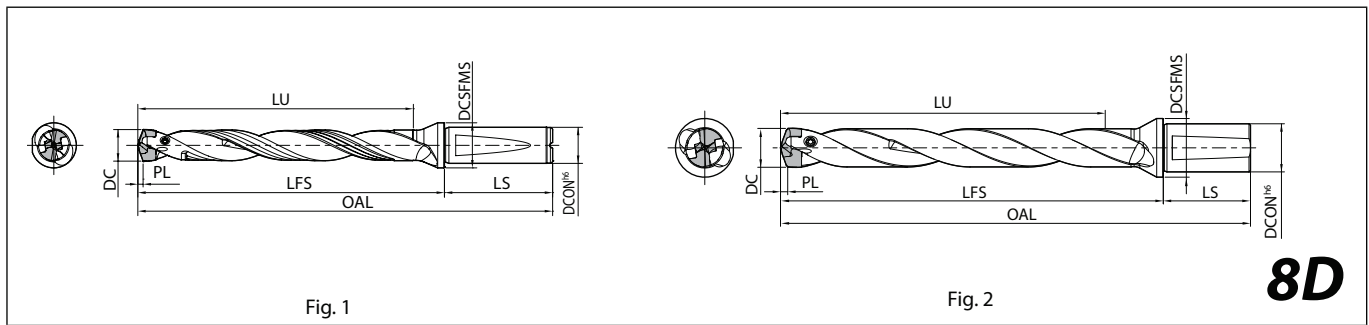

For PL indicates distance from drill point to corner edge K6~K17

Toolholder dimensions

Description	Availability	Dimension (mm)								Coolant hole	Fig.	Spare parts			Applicable inserts K6~K17
		DC min.	DC max.	DCON	OAL	LFS	LU	LS	DCSFMS			Screw	Wrench	Wrench	
		[Icons: Screw, Wrench, Wrench]													
SF12- DRA080M-8 DRA085M-8 DRA090M-8 DRA095M-8	●	7.94	8.49	12	126	81	68	45	16	Yes	1	HS-2524TRP	-	FTP-5	DA0794M-...~DA0840M-...
	●	8.5	8.99		131	86	72								DA0850M-...~DA0890M-...
	●	9	9.49		135	90	76								DA0900M-...~DA0940M-...
	●	9.5	9.99		140	95	80								DA0950M-...~DA0990M-...
SF16- DRA100M-8 DRA105M-8 DRA110M-8 DRA115M-8 DRA120M-8 DRA125M-8 DRA130M-8 DRA135M-8 DRA140M-8 DRA145M-8	●	10	10.49	16	147	99	84	48	20	Yes	1	HS-2534TRP	-	FTP-5	DA1000M-...~DA1040M-...
	●	10.5	10.99		152	104	88								DA1050M-...~DA1090M-...
	●	11	11.49		157	109	92								DA1100M-...~DA1140M-...
	●	11.5	11.99		162	114	96								DA1150M-...~DA1190M-...
	●	12	12.49		166	118	100								DA1200M-...~DA1240M-...
	●	12.5	12.99		171	123	104								DA1250M-...~DA1290M-...
	●	13	13.49		175	127	108								DA1300M-...~DA1340M-...
	●	13.5	13.99		180	132	112								DA1350M-...~DA1390M-...
	●	14	14.49		184	136	116								DA1400M-...~DA1440M-...
	●	14.5	14.99		189	141	120								DA1450M-...~DA1490M-...
SF20- DRA150M-8 DRA160M-8 DRA170M-8	●	15	15.99	20	201	151	128	50	25	Yes	1	HS-3048TRP	DTP-6	-	DA1500M-...~DA1590M-...
	●	16	16.99		211	161	136								DA1600M-...~DA1690M-...
	●	17	17.99		220	170	144								DA1700M-...~DA1790M-...
SF25- DRA180M-8 DRA190M-8 DRA200M-8 DRA210M-8 DRA220M-8 DRA230M-8 DRA240M-8 DRA250M-8	●	18	18.99	25	236	180	152	56	32	Yes	1	HS-4067TRP	DTP-7	-	DA1800M-...~DA1890M-...
	●	19	19.99		245	189	160								DA1900M-...~DA1990M-...
	●	20	20.99		254	198	168								DA2000M-...~DA2090M-...
	●	21	21.99		263	207	176								DA2100M-...~DA2150M-...
	●	22	22.99		273	217	184								DA2200M-...~DA2250M-...
	●	23	23.99		282	226	192								DA2300M-...~DA2350M-...
	●	24	24.99		291	235	200								DA2400M-...~DA2450M-...
	●	25	25.99		300	244	208								DA2500M-...~DA2550M-...
SF32- DRA260M-8 DRA270M-8 DRA280M-8 DRA290M-8 DRA300M-8 DRA310M-8 DRA320M-8	●	26	26.99	32	313	255	216	58	39	Yes	2	HS-50100TRP	DTPM-15	-	DA2600M-...~DA2650M-...
	●	27	27.99		321	263	224								DA2700M-...~DA2750M-...
	●	28	28.99		330	272	232								DA2800M-...~DA2850M-...
	●	29	29.99		339	281	240								DA2900M-...~DA2950M-...
	●	30	30.99		348	290	248								DA3000M-...~DA3050M-...
	●	31	31.99		356	298	256								DA3100M-...~DA3150M-...
	●	32	33		365	307	264								DA3200M-...~DA3300M-...

● : Standard item R : Right-hand only L : Left-hand only □ : Check availability



SF-DRA (Drilling depth : 12 x DC)

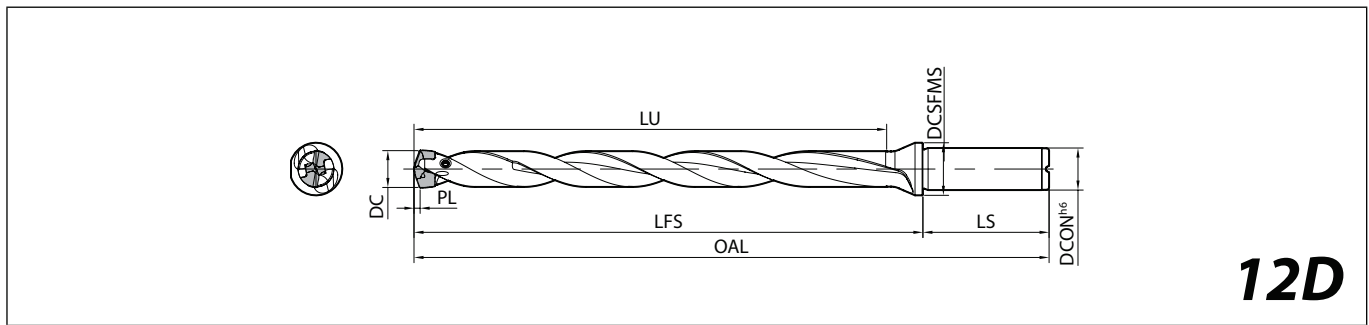

12D

For PL indicates distance from drill point to corner edge K6~K17

Toolholder dimensions

Description	Availability	Dimension (mm)								Coolant hole	Spare parts			Applicable inserts K6~K17
		DC min.	DC max.	DCON	OAL	LFS	LU	LS	DCSFMS		Screw	Wrench	Wrench	
		K												
SF16- DRA120M-12 DRA125M-12 DRA130M-12 DRA135M-12 DRA140M-12 DRA145M-12	●	12	12.49	16	216	168	150	48	20	Yes	HS-2534TRP	-	FTP-5	DA1200M-...~DA1240M-...
●	12.5	12.99	223		175	156	DA1250M-...~DA1290M-...							
●	13	13.49	229		181	162	DA1300M-...~DA1340M-...							
●	13.5	13.99	236		188	168	DA1350M-...~DA1390M-...							
●	14	14.49	242		194	174	DA1400M-...~DA1440M-...							
●	14.5	14.99	249		201	180	DA1450M-...~DA1490M-...							
SF20- DRA150M-12 DRA160M-12 DRA170M-12	●	15	15.99	20	265	215	192	50	25	Yes	HS-3048TRP	DTP-6	-	DA1500M-...~DA1590M-...
●	16	16.99	279		229	204	DA1600M-...~DA1690M-...							
●	17	17.99	292		242	216	DA1700M-...~DA1790M-...							
SF25- DRA180M-12 DRA190M-12 DRA200M-12 DRA210M-12 DRA220M-12 DRA230M-12 DRA240M-12 DRA250M-12	●	18	18.99	25	312	256	228	56	32	Yes	HS-4067TRP	DTP-7	-	DA1800M-...~DA1890M-...
●	19	19.99	325		269	240	DA1900M-...~DA1990M-...							
●	20	20.99	338		282	252	DA2000M-...~DA2090M-...							
●	21	21.99	351		295	264	DA2100M-...~DA2150M-...							
●	22	22.99	365		309	276	DA2200M-...~DA2250M-...							
●	23	23.99	378		322	288	DA2300M-...~DA2350M-...							
●	24	24.99	391		335	300	DA2400M-...~DA2450M-...							
●	25	25.5	404		348	312	DA2500M-...~DA2550M-...							

● : Standard item R : Right-hand only L : Left-hand only □ : Check availability

Spare parts

Clamp screw	Description
	HS-2524TRP
	HS-2534TRP
	HS-3048TRP
	HS-4067TRP

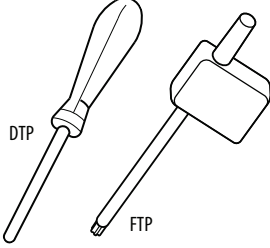
Wrench	Description	Tightening torque (N-m)
	FTP-5	0.5
	DTP-6	0.8
	DTP-7	1.2

Recommended cutting conditions

General purpose GM / Cast iron KM

	Workpiece material	Recommended insert grades / Vc (m/min)		n (min ⁻¹)	Drill dia. DC (mm)								
		PR1535	PR1525		f (mm/rev)	ø8	ø11	ø14	ø18	ø22	ø25	ø29	ø33
General purpose GM	Low carbon steel	★ 100 - 180	☆ 100 - 180	n (min ⁻¹)	3,980 - 7,160	2,890 - 5,210	2,270 - 4,090	1,770 - 3,180	1,450 - 2,600	1,270 - 2,290	1,100 - 1,980	970 - 1,740	
				f (mm/rev)	0.12 - 0.24	0.12 - 0.31	0.16 - 0.36	0.16 - 0.4	0.2 - 0.45	0.2 - 0.45	0.2 - 0.45	0.2 - 0.45	
	Carbon steel	★ 100 - 150	☆ 100 - 150	n (min ⁻¹)	3,980 - 5,970	2,890 - 4,340	2,270 - 3,410	1,770 - 2,650	1,450 - 2,170	1,270 - 1,910	1,100 - 1,650	970 - 1,450	
				f (mm/rev)	0.12 - 0.24	0.12 - 0.31	0.16 - 0.36	0.16 - 0.4	0.2 - 0.45	0.2 - 0.45	0.2 - 0.45	0.2 - 0.45	
	Alloy steel	★ 70 - 120	☆ 70 - 120	n (min ⁻¹)	2,790 - 4,780	2,030 - 3,470	1,590 - 2,730	1,240 - 2,120	1,010 - 1,740	890 - 1,530	770 - 1,320	680 - 1,160	
				f (mm/rev)	0.12 - 0.24	0.12 - 0.31	0.16 - 0.36	0.16 - 0.4	0.2 - 0.45	0.2 - 0.45	0.2 - 0.45	0.2 - 0.45	
	Mold steel	★ 50 - 90	☆ 50 - 90	n (min ⁻¹)	1,990 - 3,580	1,450 - 2,600	1,140 - 2,050	880 - 1,590	720 - 1,300	640 - 1,150	550 - 990	490 - 870	
				f (mm/rev)	0.08 - 0.17	0.08 - 0.22	0.11 - 0.25	0.11 - 0.28	0.14 - 0.32	0.14 - 0.32	0.14 - 0.32	0.14 - 0.32	
	Stainless steel	★ 40 - 70	☆ 40 - 70	n (min ⁻¹)	1,590 - 2,790	1,160 - 2,030	910 - 1,590	710 - 1,240	580 - 1,010	510 - 890	440 - 770	390 - 680	
				f (mm/rev)	0.1 - 0.24	0.1 - 0.24	0.12 - 0.3	0.15 - 0.3	0.15 - 0.3	0.15 - 0.35	0.15 - 0.35	0.15 - 0.35	
	*Feed rate 0.15 mm/rev or less is recommended until drilling depth reaches 0.5 x DC.												
	Gray cast iron	☆ 90 - 170	★ 90 - 170	n (min ⁻¹)	3,580 - 6,760	2,600 - 4,920	2,050 - 3,870	1,590 - 3,010	1,300 - 2,460	1,150 - 2,170	990 - 1,870	870 - 1,640	
f (mm/rev)				0.14 - 0.29	0.14 - 0.37	0.19 - 0.43	0.19 - 0.45	0.24 - 0.45	0.24 - 0.45	0.24 - 0.45	0.24 - 0.45		
Nodular cast iron	☆ 40 - 120	★ 40 - 120	n (min ⁻¹)	1,590 - 4,780	1,160 - 3,470	910 - 2,730	710 - 2,120	580 - 1,740	510 - 1,530	440 - 1,320	390 - 1,160		
			f (mm/rev)	0.12 - 0.24	0.12 - 0.31	0.16 - 0.36	0.16 - 0.4	0.2 - 0.45	0.2 - 0.45	0.2 - 0.45	0.2 - 0.45		
Cast iron KM	Gray cast iron	-	90 - 170	n (min ⁻¹)	3,580 - 6,760	2,600 - 4,920	2,050 - 3,870	1,590 - 3,010	1,300 - 2,460	1,150 - 2,170	-	-	
				f (mm/rev)	0.17 - 0.35	0.19 - 0.42	0.23 - 0.53	0.25 - 0.60	0.32 - 0.60	0.32 - 0.60	-	-	
	Nodular cast iron	-	40 - 120	n (min ⁻¹)	1,590 - 4,780	1,160 - 3,470	910 - 2,730	710 - 2,120	580 - 1,740	510 - 1,530	-	-	
				f (mm/rev)	0.12 - 0.24	0.17 - 0.36	0.21 - 0.48	0.24 - 0.60	0.27 - 0.60	0.27 - 0.60	-	-	

Recommended cutting conditions above is for 1.5D/3D type.

As drilling depth increases (1.5D/3D → 5D → 8D → 12D), cutting speed and feed rates need to be set lower than the recommended values.

Recommended feed rate : 1.5/3D type=100%, 5D type=80% or less

Recommended cutting speed and feed rate: 8D type=80% or less, 12D type=70% or less

★:1st recommendation ☆:2nd recommendation

K

Counterboring FTP

	Workpiece material	Recommended insert grades / Vc (m/min)		n (min ⁻¹)	Drill dia. DC (mm)						
		PR1535	PR1525		f (mm/rev)	ø8	ø11	ø14	ø18	ø22	ø25
Counterboring FTP	Low carbon steel	★ 80 - 150	☆ 80 - 150	n (min ⁻¹)	3,150 - 6,000	2,300 - 4,350	1,800 - 3,400	1,400 - 2,650	1,150 - 2,200	1,000 - 1,900	
				f (mm/rev)	0.12 - 0.24	0.12 - 0.31	0.16 - 0.36	0.16 - 0.40	0.20 - 0.45	0.20 - 0.45	
	Carbon steel	★ 80 - 120	☆ 80 - 120	n (min ⁻¹)	3,150 - 4,750	2,300 - 3,450	1,800 - 2,700	1,400 - 2,100	1,150 - 1,750	1,000 - 1,500	
				f (mm/rev)	0.12 - 0.24	0.12 - 0.31	0.16 - 0.36	0.16 - 0.40	0.20 - 0.45	0.20 - 0.45	
	Alloy steel	★ 70 - 120	☆ 70 - 120	n (min ⁻¹)	2,800 - 4,750	2,000 - 3,450	1,600 - 2,700	1,250 - 2,100	1,000 - 1,750	900 - 1,500	
				f (mm/rev)	0.12 - 0.24	0.12 - 0.31	0.16 - 0.36	0.16 - 0.40	0.20 - 0.40	0.20 - 0.45	
	Mold steel	★ 40 - 70	☆ 40 - 70	n (min ⁻¹)	1,600 - 2,800	1,150 - 2,000	900 - 1,600	700 - 1,250	600 - 1,000	500 - 900	
				f (mm/rev)	0.08 - 0.17	0.08 - 0.22	0.11 - 0.25	0.11 - 0.28	0.14 - 0.30	0.14 - 0.32	
	Stainless steel	★ 40 - 70	☆ 40 - 70	n (min ⁻¹)	1,600 - 2,800	1,150 - 2,000	900 - 1,600	700 - 1,250	600 - 1,000	500 - 900	
				f (mm/rev)	0.10 - 0.20	0.10 - 0.20	0.10 - 0.24	0.15 - 0.24	0.15 - 0.24	0.15 - 0.28	
	*Feed rate 0.15 mm/rev or less is recommended until drilling depth reaches 0.5 x DC.										
	Gray cast iron	☆ 70 - 140	★ 70 - 140	n (min ⁻¹)	2,800 - 5,600	2,000 - 4,050	1,600 - 3,200	1,250 - 2,500	1,000 - 2,000	900 - 1,800	
f (mm/rev)				0.14 - 0.29	0.14 - 0.37	0.19 - 0.43	0.19 - 0.45	0.24 - 0.45	0.24 - 0.45		
Nodular cast iron	☆ 40 - 100	★ 40 - 100	n (min ⁻¹)	1,600 - 4,000	1,150 - 2,900	900 - 2,750	700 - 1,750	600 - 1,450	500 - 1,250		
			f (mm/rev)	0.12 - 0.24	0.12 - 0.31	0.16 - 0.36	0.16 - 0.40	0.2 - 0.45	0.2 - 0.45		

* The recommended cutting conditions are for drilling on plain surface

The conditions for drilling on slant hole shows the depth from the top of workpiece

Set the feed rate 50% or under when inclination angle is 30 or under. Set the feed rate 30% or under when inclination angle is over 30°

Traversing is not recommended. Applicable to 1.5D,3D,5D,8D and 12D holders. Prepared hole (0.5xDC) is needed when using 8D/12D holder

Recommended feed rate : 1.5/3D type=100%, 5D type=80% or less

Recommended cutting speed and feed rate: 8D type=80% or less, 12D type=70% or less

★:1st recommendation ☆:2nd recommendation



Drilling

DRA

DRC

DRV

DRZ

DRXR

DRW

High precision insert for steel HQP

High Precision Insert for Steel HQP	Workpiece material	Recommended Insert Grades / Vc(m/min)	n (min ⁻¹)	Drill dia. DC (mm)			
				f (mm/rev)	ø8	ø11	ø14
Low carbon steel	80 - 180	PR1525	n (min ⁻¹)	3,180 - 7,160	2,310 - 5,210	1,810 - 4,090	1,410 - 3,180
			f (mm/rev)	0.12 - 0.24	0.12 - 0.28	0.16 - 0.32	0.16 - 0.36
Carbon steel	80 - 150	PR1525	n (min ⁻¹)	3,180 - 7,160	2,310 - 5,210	1,810 - 4,090	1,410 - 3,180
			f (mm/rev)	0.12 - 0.24	0.12 - 0.28	0.16 - 0.32	0.16 - 0.36
Alloy steel	70 - 120	PR1525	n (min ⁻¹)	2,790 - 4,780	2,030 - 3,470	1,590 - 2,730	1,240 - 2,120
			f (mm/rev)	0.12 - 0.24	0.12 - 0.28	0.16 - 0.32	0.16 - 0.36
Mold steel	50 - 90	PR1525	n (min ⁻¹)	1,990 - 3,580	1,450 - 2,600	1,140 - 2,050	880 - 1,590
			f (mm/rev)	0.08 - 0.17	0.08 - 0.2	0.11 - 0.23	0.11 - 0.26

Caution : Recommended cutting conditions above is for 1.5D/3D type. As drilling depth increases (1.5D/3D→5D→8D→12D), feed rates need to be set lower than the recommended values.
 Recommended feed rate : 1.5D/3D type=100%, 5D type=80% or less, 8D/12D type=70% or less

Difficult-to-cut materials / Stainless steel HQS

Difficult-to-cut materials HQS	Workpiece material	Recommended Insert Grades / Vc(m/min)	n (min ⁻¹)	Drill dia. DC (mm)			
				f (mm/rev)	ø8	ø11	ø14
Stainless steel	40 - 50	PR1535	n (min ⁻¹)	1,590 - 1,990	1,160 - 1,450	910 - 1,140	710 - 880
			f (mm/rev)	0.08 - 0.12	0.10 - 0.15	0.10 - 0.15	0.12 - 0.18
Heat-resistant alloy	15 - 20	PR1535	n (min ⁻¹)	600 - 800	430 - 580	340 - 450	270 - 350
			f (mm/rev)	0.08 - 0.12	0.08 - 0.15	0.10 - 0.15	0.12 - 0.18
Titanium alloy	30 - 40	PR1535	n (min ⁻¹)	1,190 - 1,590	870 - 1,160	680 - 910	530 - 710
			f (mm/rev)	0.08 - 0.12	0.08 - 0.15	0.10 - 0.15	0.12 - 0.18

Caution : Recommended cutting conditions above is for 1.5D/3D type. As drilling depth increases (1.5D/3D→5D→8D→12D), feed rates need to be set lower than the recommended values.
 Recommended feed rate : 1.5D/3D type=100%, 5D type=80% or less, 8D/12D type=70% or less



Coolant * Dry machining is not recommended.

1st recommendation

Internal coolant

Internal and external coolant is recommended

Drilling depth less than 1DC

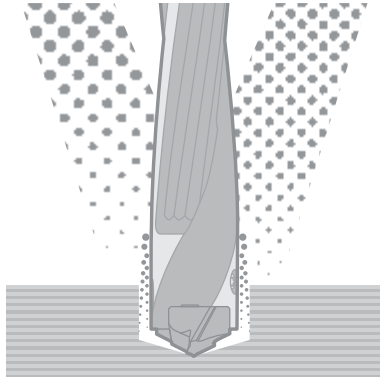

Stainless steel, high feed rate

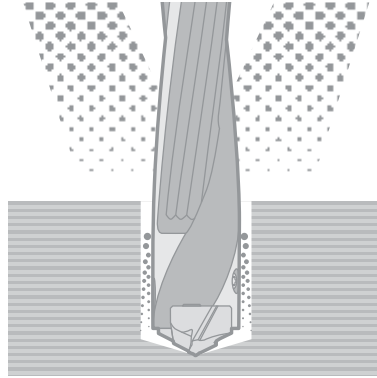

In case of external coolant

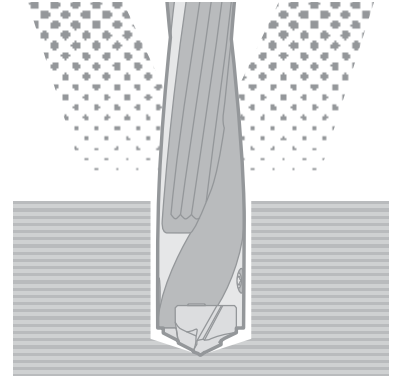

Lathe: 3DC or less
Vertical M/C: 1.5DC or less

K

How to attach inserts

- 1 Install insert onto the toolholder in the right direction
- 2 Tighten clamp screw to fix the insert
K29

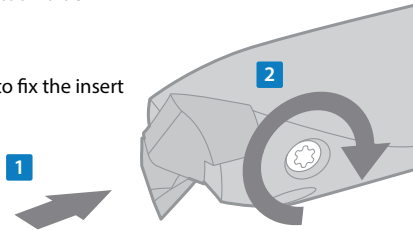

Be careful of the insert direction

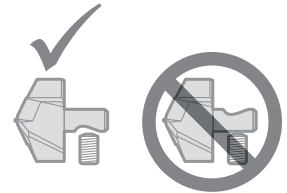

- * 1 Remove dust on insert pocket using air blow for every replacement.
- * 2 Make sure that the locating surfaces of the insert closely contacts the toolholder.

Core deviation

If drill is stationary

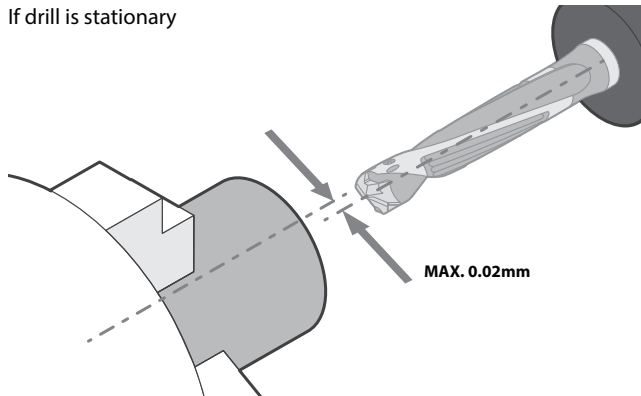

If drill is rotating

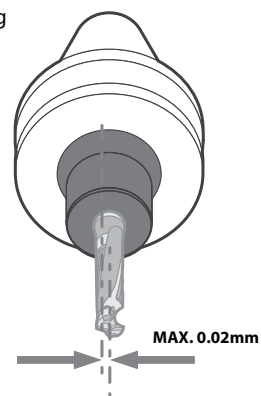

This can be used with a boring sleeve and collet chuck, please be sure to set deviation amount 0.02mm or under between workpiece and drill.

Make sure to use arbor that is not deformed. Center of arbor deviation must be within 0.02mm.

Drilling

DRA
DRC
DRV
DRZ
DRXR
DRW

Cautions for installation on machining center

For installation of MagicDrill DRA

1st choice

Hydro chuck, power chuck, collet chuck, etc.

Hydro chuck

Power chuck

Collet chuck

Install MagicDrill DRA to the chucks

2nd choice

Side lock arbor

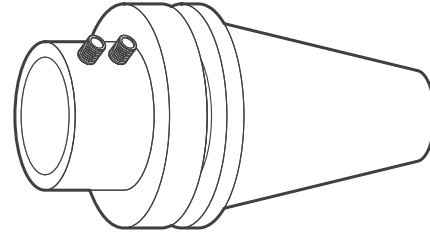

Example of side lock arbor

Cautions for machining with 8D/12D holder

Recommended machining

- 1 Make a center spot using DRA 1.5D/3D/5D type.
(Center spot should be at least half of cutting diameter)
- 2 Then drill the hole using DRA (8D/12D type).

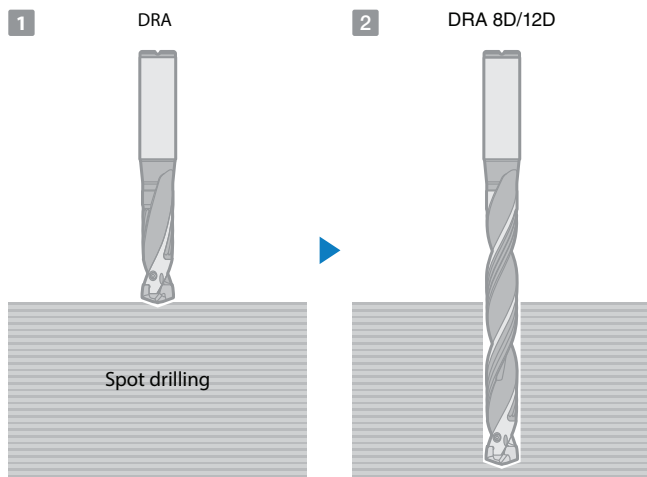

Precautions for KM chipbreaker

Machining on casting surface

Decrease feed to 0.15 mm/rev until full drill diameter has entered the workpiece



Applicable workpieces

Applications	Shape of workpiece	Caution for machining
Plain surface		<ol style="list-style-type: none"> 1. When machining stainless steel, for hole depths of up to 0.5DC, keep feed rate at 0.15mm/rev or less. 2. Internal coolant is recommended for smooth chip removal. For stainless steel, the combination of internal and external coolant is recommended.
Stacked plates		<ol style="list-style-type: none"> 1. Fix stacked plates securely to ensure they do not slip while machining.
Concave surface		<ol style="list-style-type: none"> 1. When machining concave holes, set the feed rate at half of recommended feed or less for continuous hole machining. 2. Utilize a step feeding if chips are not broken short at the inlet.
Pipe material		<ol style="list-style-type: none"> 1. Hole machining above the centerline of the pipe is possible. 2. Do not machine on curved surface areas. <div style="display: flex; justify-content: space-around; align-items: center;"> <div style="text-align: center;"> Center portion machining </div> <div style="text-align: center;"> *Curved surface portion machining </div> </div>













* Machining possible with FTP and 1.5D toolholder

Not recommended workpieces

Applications	Shape of workpiece	Applications	Shape of workpiece
*Hole expansion		*Slant surface	
Applications	Shape of workpiece	Applications	Shape of workpiece
Half cylindrical		*Cored hole	

* Machining possible with FTP and 1.5D toolholder

DRC insert (SC - Carbon steel, alloy steel and cast iron)

Insert	Description	Dimension (mm)		Tolerance		Carbide		Applicable toolholder K37~K39 K42~K44
		DC	PL	k8 (min.)	k8 (max.)	PVD	PR03T5	
            	DC	0794M-SC 0800M-SC 0810M-SC 0820M-SC 0830M-SC 0840M-SC	7.94 8 8.1 8.2 8.3 8.4	1.37 1.38 1.4 1.42 1.43 1.45	0	+0.022	● ● ● ● ● ●	SF12-DRC080M-○ SS10-DRC080M-○
	DC	0850M-SC 0860M-SC 0870M-SC 0880M-SC 0890M-SC	8.5 8.6 8.7 8.8 8.9	1.47 1.48 1.5 1.52 1.54	0	+0.022	● ● ● ● ●	SF12-DRC085M-○ SS10-DRC085M-○
	DC	0900M-SC 0910M-SC 0920M-SC 0930M-SC 0940M-SC	9 9.1 9.2 9.3 9.4	1.55 1.57 1.59 1.61 1.62	0	+0.022	● ● ● ● ●	SF12-DRC090M-○ SS10-DRC090M-○
	DC	0950M-SC 0960M-SC 0970M-SC 0980M-SC 0990M-SC	9.5 9.6 9.7 9.8 9.9	1.64 1.66 1.67 1.69 1.71	0	+0.022	● ● ● ● ●	SF12-DRC095M-○ SS10-DRC095M-○
	DC	1000M-SC 1010M-SC 1020M-SC 1030M-SC 1040M-SC	10 10.1 10.2 10.3 10.4	1.72 1.74 1.76 1.78 1.8	0	+0.022 +0.027 +0.027 +0.027 +0.027	● ● ● ● ●	SF16-DRC100M-○ SS12-DRC100M-○
	DC	1050M-SC 1060M-SC 1070M-SC 1080M-SC 1090M-SC	10.5 10.6 10.7 10.8 10.9	1.81 1.83 1.85 1.86 1.88	0	+0.027	● ● ● ● ●	SF16-DRC105M-○ SS12-DRC105M-○
	DC	1100M-SC 1110M-SC 1120M-SC 1130M-SC 1140M-SC	11 11.1 11.2 11.3 11.4	1.9 1.91 1.93 1.95 1.97	0	+0.027	● ● ● ● ●	SF16-DRC110M-○ SS12-DRC110M-○
	DC	1150M-SC 1160M-SC 1170M-SC 1180M-SC 1190M-SC	11.5 11.6 11.7 11.8 11.9	1.98 2 2.02 2.04 2.06	0	+0.027	● ● ● ● ●	SF16-DRC115M-○ SS12-DRC115M-○
	DC	1200M-SC 1210M-SC 1220M-SC 1230M-SC 1240M-SC	12 12.1 12.2 12.3 12.4	2.07 2.09 2.11 2.12 2.14	0	+0.027	● ● ● ● ●	SF16-DRC120M-○ SS14-DRC120M-○
	DC	1250M-SC 1260M-SC 1270M-SC 1280M-SC 1290M-SC	12.5 12.6 12.7 12.8 12.9	2.16 2.17 2.19 2.21 2.23	0	+0.027	● ● ● ● ●	SF16-DRC125M-○ SS14-DRC125M-○
	DC	1300M-SC 1310M-SC 1320M-SC 1330M-SC 1340M-SC	13 13.1 13.2 13.3 13.4	2.24 2.26 2.28 2.3 2.31	0	+0.027	● ● ● ● ●	SF16-DRC130M-○ SS14-DRC130M-○

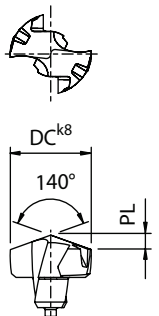

k8 is the dimension tolerance of the insert. It is not the dimension tolerance of the hole diameter.

Recommended cutting conditions ➔ K46

● : Standard item R : Right-hand only L : Left-hand only □ : Check availability

DC inserts are sold in 1 piece boxes

DRC insert (SC - Carbon steel, alloy steel and cast iron)

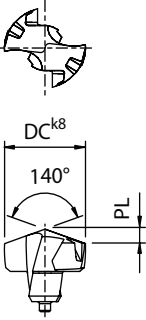
Insert	Description	Dimension (mm)		Tolerance		Carbide	Applicable toolholder ● K37~K39 ● K42~K44
		DC	PL	k8 (min.)	k8 (max.)		
 	DC 1350M-SC 1360M-SC 1370M-SC 1380M-SC 1390M-SC	13.5 13.6 13.7 13.8 13.9	2.33 2.35 2.36 2.38 2.4	0	+0.027	● ● ● ● ●	SF16-DRC135M-○ SS14-DRC135M-○
	DC 1400M-SC 1410M-SC 1420M-SC 1430M-SC 1440M-SC	14 14.1 14.2 14.3 14.4	2.41 2.43 2.45 2.47 2.49	0	+0.027	● ● ● ● ●	SF16-DRC140M-○ SS16-DRC140M-○
	DC 1450M-SC 1460M-SC 1470M-SC 1480M-SC 1490M-SC	14.5 14.6 14.7 14.8 14.9	2.5 2.52 2.54 2.55 2.57	0	+0.027	● ● ● ● ●	SF16-DRC145M-○ SS16-DRC145M-○
	DC 1500M-SC 1510M-SC 1520M-SC 1530M-SC 1540M-SC 1550M-SC 1560M-SC 1570M-SC 1580M-SC	15 15.1 15.2 15.3 15.4 15.5 15.6 15.7 15.8	2.59 2.6 2.62 2.64 2.66 2.68 2.7 2.71 2.73	0	+0.027	● ● ● ● ● ● ● ● ●	SF20-DRC150M-○ SS16-DRC150M-○
	DC 1600M-SC 1610M-SC 1620M-SC 1630M-SC 1640M-SC 1650M-SC 1660M-SC 1670M-SC 1680M-SC 1690M-SC	16 16.1 16.2 16.3 16.4 16.5 16.6 16.7 16.8 16.9	2.76 2.78 2.8 2.81 2.83 2.85 2.87 2.89 2.9 2.92	0	+0.027	● ● ● ● ● ● ● ● ● ●	SF20-DRC160M-○ SS18-DRC160M-○
	DC 1700M-SC 1710M-SC 1720M-SC 1730M-SC 1740M-SC 1750M-SC 1760M-SC 1770M-SC 1780M-SC 1790M-SC	17 17.1 17.2 17.3 17.4 17.5 17.6 17.7 17.8 17.9	2.93 2.95 2.97 2.99 3 3.02 3.04 3.06 3.08 3.09	0	+0.027	● ● ● ● ● ● ● ● ● ●	SF20-DRC170M-○ SS18-DRC170M-○
	DC 1800M-SC 1810M-SC 1820M-SC 1830M-SC 1840M-SC 1850M-SC 1860M-SC 1870M-SC 1880M-SC 1890M-SC	18 18.1 18.2 18.3 18.4 18.5 18.6 18.7 18.8 18.9	3.1 3.12 3.14 3.16 3.18 3.19 3.21 3.23 3.25 3.27	0	+0.027 +0.033 +0.033 +0.033 +0.033 +0.033 +0.033 +0.033 +0.033	● ● ● ● ● ● ● ● ● ●	SF25-DRC180M-○ SS20-DRC180M-○

k8 is the dimension tolerance of the insert. It is not the dimension tolerance of the hole diameter.

Recommended cutting conditions ● K46

● : Standard item R : Right-hand only L : Left-hand only □ : Check availability

DC inserts are sold in 1 piece boxes

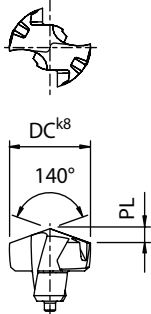

DRC insert (SC - Carbon steel, alloy steel and cast iron)

Insert	Description	Dimension (mm)		Tolerance		Carbide	Applicable toolholder ➡ K37~K39 K42~K44
		DC	PL	k8 (min.)	k8 (max.)		
 	DC 1900M-SC	19	3.28	0	+0.033	●	SF25-DRC190M-○ SS20-DRC190M-○
	1910M-SC	19.1	3.29				
	1920M-SC	19.2	3.31				
	1930M-SC	19.3	3.33				
	1940M-SC	19.4	3.35				
	1950M-SC	19.5	3.37				
	1960M-SC	19.6	3.39				
	1970M-SC	19.7	3.4				
	1980M-SC	19.8	3.42				
	1990M-SC	19.9	3.44				
	DC 2000M-SC	20	3.45	0	+0.033	●	SF25-DRC200M-○ SS25-DRC200M-○
	2010M-SC	20.1	3.47				
	2020M-SC	20.2	3.48				
	2030M-SC	20.3	3.5				
	2040M-SC	20.4	3.52				
	2050M-SC	20.5	3.54				
	2060M-SC	20.6	3.56				
	2070M-SC	20.7	3.58				
	2080M-SC	20.8	3.59				
	2090M-SC	20.9	3.61				
2099M-SC	20.99	3.63					
DC 2100M-SC	21	3.62	0	+0.033	●	SF25-DRC210M-○ SS25-DRC210M-○	
2150M-SC	21.5	3.71					
DC 2200M-SC	22	3.79	0	+0.033	●	SF25-DRC220M-○ SS25-DRC220M-○	
2250M-SC	22.5	3.88					
DC 2300M-SC	23	3.97	0	+0.033	●	SF25-DRC230M-○ SS25-DRC230M-○	
2350M-SC	23.5	4.06					
DC 2400M-SC	24	4.14	0	+0.033	●	SF25-DRC240M-○ SS25-DRC240M-○	
2450M-SC	24.5	4.23					
DC 2500M-SC	25	4.31	0	+0.033	●	SF25-DRC250M-○ SS32-DRC250M-○	
2550M-SC	25.5	4.4					
2599M-SC	25.99	4.49					

k8 is the dimension tolerance of the insert. It is not the dimension tolerance of the hole diameter.

Recommended cutting conditions ➡ K46

Description Identification System (Insert)

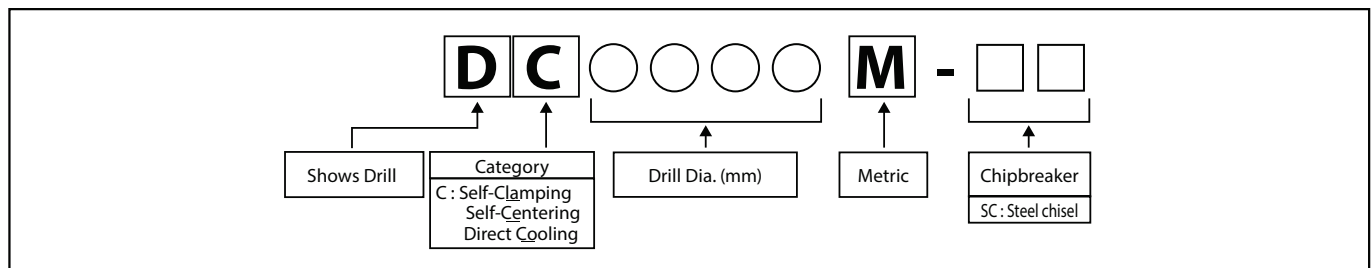

● : Standard item R : Right-hand only L : Left-hand only □ : Check availability

DC inserts are sold in 1 piece boxes

SS-DRC (Drilling depth : 3 x DC)

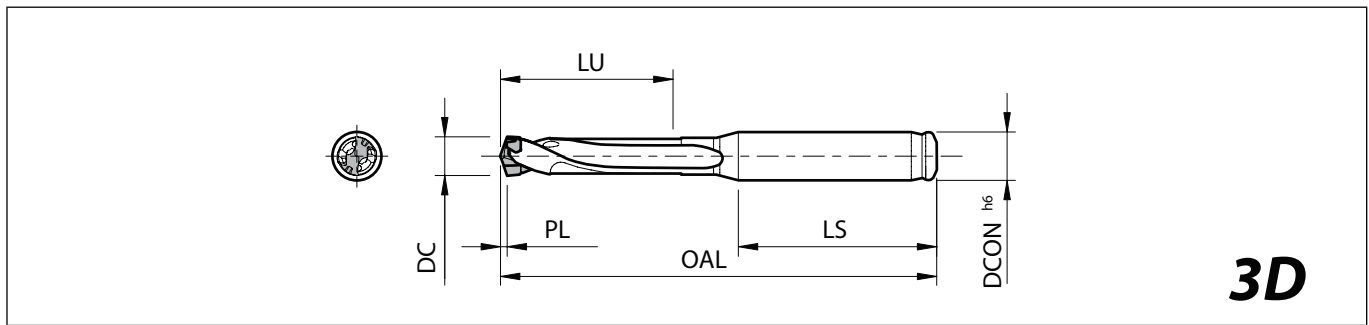

For PL indicates distance from drill point to corner edge K34~K36

Toolholder dimensions

Description	Availability	Dimension (mm)						Coolant hole	Spare parts		Applicable inserts K34~K36	Applicable chamfering attachment K40
		DC min.	DC max.	DCON	OAL	LU	LS		Wrench			
SS10- DRC080M-3 DRC085M-3 DRC090M-3 DRC095M-3	●	7.94	8.49	10	79	25.5	40	Yes	WDRC17 *(Included wrench : WDRC8)	DC0794M-SC~DC0840M-SC DC0850M-SC~DC0890M-SC DC0900M-SC~DC0940M-SC DC0950M-SC~DC0990M-SC	S20-CH10	
	●	8.5	8.99		81	27						
	●	9	9.49		83	28.5						
	●	9.5	9.99		85	30						
SS12- DRC100M-3 DRC105M-3 DRC110M-3 DRC115M-3	●	10	10.49	12	92	31.5	45	Yes	WDRC17 *(Included wrench : WDRC10)	DC1000M-SC~DC1040M-SC DC1050M-SC~DC1090M-SC DC1100M-SC~DC1140M-SC DC1150M-SC~DC1190M-SC	S32-CH12	
	●	10.5	10.99		94	33						
	●	11	11.49		96	34.5						
	●	11.5	11.99		98	36						
SS14- DRC120M-3 DRC125M-3 DRC130M-3 DRC135M-3	●	12	12.49	14	101	37.5	45	Yes	WDRC17 *(Included wrench : WDRC12)	DC1200M-SC~DC1240M-SC DC1250M-SC~DC1290M-SC DC1300M-SC~DC1340M-SC DC1350M-SC~DC1390M-SC	S32-CH14	
	●	12.5	12.99		103	39						
	●	13	13.49		105	40.5						
	●	13.5	13.99		107	42						
SS16- DRC140M-3 DRC145M-3 DRC150M-3	●	14	14.49	16	112	43.5	48	Yes	WDRC17 *(Included wrench : WDRC14)	DC1400M-SC~DC1440M-SC DC1450M-SC~DC1490M-SC DC1500M-SC~DC1580M-SC	S32-CH16	
	●	14.5	14.99		114	45						
	●	15	15.99		118	48						
SS18- DRC160M-3 DRC170M-3	●	16	16.99	18	122	51	48	Yes	WDRC17	DC1600M-SC~DC1690M-SC DC1700M-SC~DC1790M-SC	S32-CH18	
	●	17	17.99		127	54						
SS20- DRC180M-3 DRC190M-3	●	18	18.99	20	133	57	50	Yes	WDRC17	DC1800M-SC~DC1890M-SC DC1900M-SC~DC1990M-SC		
	●	19	19.99		137	60						
SS25- DRC200M-3 DRC210M-3 DRC220M-3 DRC230M-3 DRC240M-3	●	20	20.99	25	147	63	56	Yes	WDRC17	DC2000M-SC~DC2099M-SC DC2100M-SC~DC2150M-SC DC2200M-SC~DC2250M-SC DC2300M-SC~DC2350M-SC DC2400M-SC~DC2450M-SC		
	●	21	21.99		151	66						
	●	22	22.99		156	69						
	●	23	23.99		160	72						
	●	24	24.99		164	75						
SS32- DRC250M-3	●	25	25.99	32	172	78	60	Yes	WDRC17	DC2500M-SC~DC2599M-SC		

* Choose „WDRC17“, when purchasing wrench only.



Description Identification System (Toolholder)

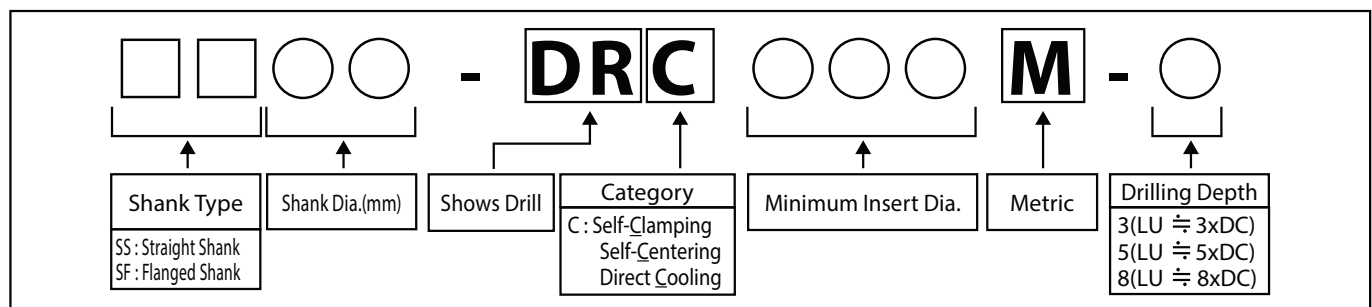

● : Standard item R : Right-hand only L : Left-hand only □ : Check availability

SS-DRC (Drilling depth : 5 x DC)

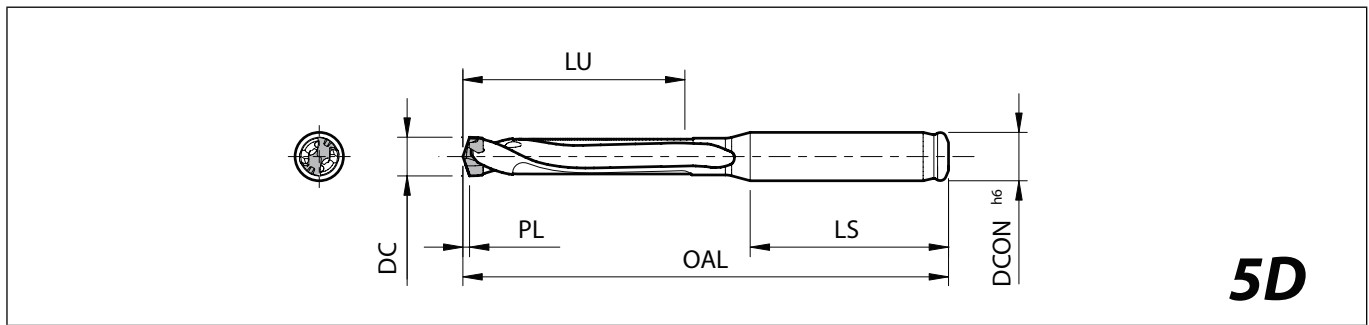

For PL indicates distance from drill point to corner edge K34~K36

Toolholder dimensions

Description	Availability	Dimension (mm)						Coolant hole	Spare parts Wrench	Applicable inserts K34~K36	Applicable chamfering attachment K40
		DC min.	DC max.	DCON	OAL	LU	LS				
SS10- DRC080M-5 DRC085M-5 DRC090M-5 DRC095M-5	●	7.94	8.49	10	97	42.5	40	Yes	WDRC17 *(Included wrench : WDRC8)	DC0794M-SC~DC0840M-SC	S20-CH10
	●	8.5	8.99		100	45				DC0850M-SC~DC0890M-SC	
	●	9	9.49		103	47.5				DC0900M-SC~DC0940M-SC	
	●	9.5	9.99		107	50				DC0950M-SC~DC0990M-SC	
SS12- DRC100M-5 DRC105M-5 DRC110M-5 DRC115M-5	●	10	10.49	12	115	52.5	45	Yes	WDRC17 *(Included wrench : WDRC10)	DC1000M-SC~DC1040M-SC	S32-CH12
	●	10.5	10.99		118	55				DC1050M-SC~DC1090M-SC	
	●	11	11.49		121	57.5				DC1100M-SC~DC1140M-SC	
	●	11.5	11.99		124	60				DC1150M-SC~DC1190M-SC	
SS14- DRC120M-5 DRC125M-5 DRC130M-5 DRC135M-5	●	12	12.49	14	127	62.5	45	Yes	WDRC17 *(Included wrench : WDRC12)	DC1200M-SC~DC1240M-SC	S32-CH14
	●	12.5	12.99		130	65				DC1250M-SC~DC1290M-SC	
	●	13	13.49		133	67.5				DC1300M-SC~DC1340M-SC	
	●	13.5	13.99		137	70				DC1350M-SC~DC1390M-SC	
SS16- DRC140M-5 DRC145M-5 DRC150M-5	●	14	14.49	16	143	72.5	48	Yes	WDRC17 *(Included wrench : WDRC14)	DC1400M-SC~DC1440M-SC	S32-CH16
	●	14.5	14.99		146	75				DC1450M-SC~DC1490M-SC	
	●	15	15.99		152	80				DC1500M-SC~DC1580M-SC	
SS18- DRC160M-5 DRC170M-5	●	16	16.99	18	158	85	48	Yes	WDRC17	DC1600M-SC~DC1690M-SC	S32-CH18
	●	17	17.99		165	90				DC1700M-SC~DC1790M-SC	
SS20- DRC180M-5 DRC190M-5	●	18	18.99	20	173	95	50	Yes	WDRC17	DC1800M-SC~DC1890M-SC	
	●	19	19.99		179	100				DC1900M-SC~DC1990M-SC	
SS25- DRC200M-5 DRC210M-5 DRC220M-5 DRC230M-5 DRC240M-5	●	20	20.99	25	191	105	56	Yes	WDRC17	DC2000M-SC~DC2099M-SC	
	●	21	21.99		198	110				DC2100M-SC~DC2150M-SC	
	●	22	22.99		204	115				DC2200M-SC~DC2250M-SC	
	●	23	23.99		210	120				DC2300M-SC~DC2350M-SC	
	●	24	24.99		216	125				DC2400M-SC~DC2450M-SC	
SS32- DRC250M-5	●	25	25.99	32	227	130	60	Yes	WDRC17	DC2500M-SC~DC2599M-SC	

* Choose „WDRC17“, when purchasing wrench only.

K

Drilling

DRA

DRC

DRV

DRZ

DRXR

DRW

● : Standard item R : Right-hand only L : Left-hand only □ : Check availability

SS-DRC (Drilling depth : 8 x DC)

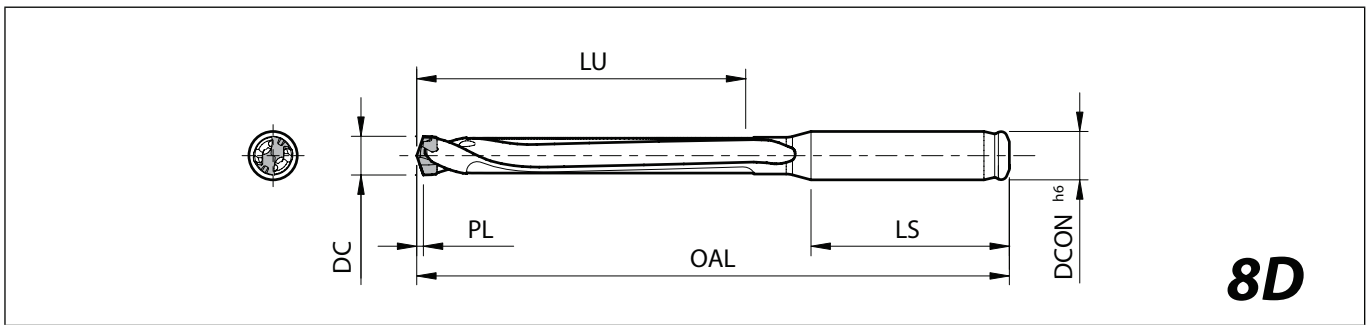

For PL indicates distance from drill point to corner edge K34~K36

Toolholder dimensions

Description	Availability	Dimension (mm)						Coolant hole	Spare parts		Applicable inserts K34~K36	Applicable chamfering attachment K40
		DC min.	DC max.	DCON	OAL	LU	LS		Wrench			
SS10- DRC080M-8 DRC085M-8 DRC090M-8 DRC095M-8	●	7.94	8.49	10	122.5	68	40	Yes	WDRC17 *(Included wrench : WDRC8)	DC0794M-SC~DC0840M-SC DC0850M-SC~DC0890M-SC DC0900M-SC~DC0940M-SC DC0950M-SC~DC0990M-SC	S20-CH10	
	●	8.5	8.99		127	72						
	●	9	9.49		131.5	76						
	●	9.5	9.99		137	80						
SS12- DRC100M-8 DRC105M-8 DRC110M-8 DRC115M-8	●	10	10.49	12	146.5	84	45	Yes	WDRC17 *(Included wrench : WDRC10)	DC1000M-SC~DC1040M-SC DC1050M-SC~DC1090M-SC DC1100M-SC~DC1140M-SC DC1150M-SC~DC1190M-SC	S32-CH12	
	●	10.5	10.99		151	88						
	●	11	11.49		155.5	92						
	●	11.5	11.99		160	96						
SS14- DRC120M-8 DRC125M-8 DRC130M-8 DRC135M-8	●	12	12.49	14	164.5	100	45	Yes	WDRC17 *(Included wrench : WDRC12)	DC1200M-SC~DC1240M-SC DC1250M-SC~DC1290M-SC DC1300M-SC~DC1340M-SC DC1350M-SC~DC1390M-SC	S32-CH14	
	●	12.5	12.99		169	104						
	●	13	13.49		173.5	108						
	●	13.5	13.99		179	112						
SS16- DRC140M-8 DRC145M-8 DRC150M-8	●	14	14.49	16	186.5	116	48	Yes	WDRC17 *(Included wrench : WDRC14)	DC1400M-SC~DC1440M-SC DC1450M-SC~DC1490M-SC DC1500M-SC~DC1580M-SC	S32-CH16	
	●	14.5	14.99		191	120						
	●	15	15.99		200	128						
SS18- DRC160M-8 DRC170M-8	●	16	16.99	18	209	136	48	Yes	WDRC17	DC1600M-SC~DC1690M-SC DC1700M-SC~DC1790M-SC	S32-CH18	
	●	17	17.99		219	144						
SS20- DRC180M-8 DRC190M-8	●	18	18.99	20	230	152	50	Yes	WDRC17	DC1800M-SC~DC1890M-SC DC1900M-SC~DC1990M-SC		
	●	19	19.99		239	160						
SS25- DRC200M-8 DRC210M-8 DRC220M-8 DRC230M-8 DRC240M-8	●	20	20.99	25	254	168	56	Yes	WDRC17	DC2000M-SC~DC2099M-SC DC2100M-SC~DC2150M-SC DC2200M-SC~DC2250M-SC DC2300M-SC~DC2350M-SC DC2400M-SC~DC2450M-SC		
	●	21	21.99		264	176						
	●	22	22.99		273	184						
	●	23	23.99		282	192						
	●	24	24.99		291	200						
SS32- DRC250M-8	●	25	25.99	32	305	208	60	Yes	WDRC17	DC2500M-SC~DC2599M-SC		

* Choose „WDRC17“, when purchasing wrench only.



Chamfering attachment

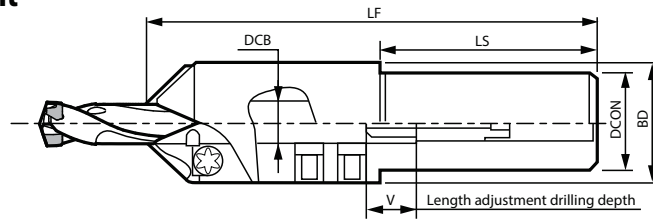

Dimensions

Description	Availability	Applicable Drill Shank Dia.	Dimension (mm)					Applicable Inserts
			DCON	BD	LF	LS	V	
S20-CH10	●	10	20	29	122	52	17	CT08T2-45A
S32-CH12	●	12	32	38	133	62	21	CT12T3-45A
S32-CH14	●	14		40	137		16	
S32-CH16	●	16		42	141		19	
S32-CH18	●	18		47	144		15	

Chamfering attachment is dedicated for Straight Shank SS-DRC. It cannot be used for Flanged Shank SF-DRC.

● : Available

Drilling depth and chamfering dimension

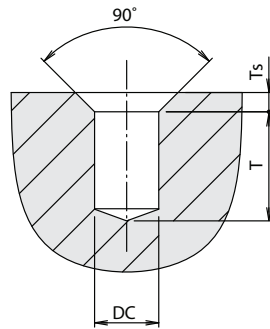

K

Drilling

Drill dia. (mm) DC		Drilling depth (mm)						Chamfering dimension (mm) Ts		Applicable chamfering holder
		T(3D drill)		T(5D drill)		T(8D drill)		Ts 100	Ts max.	
min.	max.	min.	max.	min.	max.	min.	max.			
7.94	8.49	11	19	21	37	47	63	2.5	5.0	S20-CH10
8.50	8.99	12	21	24	40	51	67			
9.00	9.49	12	23	27	43	56	72			
9.50	9.99	13	25	31	47	61	77	3.5	7.0	S32-CH12
10.00	10.49	13	26	28	49	60	81			
10.50	10.99	14	28	31	52	64	85			
11.00	11.49	14	30	34	55	69	90	4.0	8.0	S32-CH14
11.50	11.99	15	32	37	58	73	94			
12.00	12.49	15	30	41	56	79	94			
12.50	12.99	17	32	44	59	83	96	4.0	8.0	S32-CH16
13.00	13.49	19	34	47	62	88	103			
13.50	13.99	21	36	51	66	93	108			
14.00	14.49	19	37	50	68	94	112	4.0	8.0	S32-CH18
14.50	14.99	21	39	53	71	98	116			
15.00	15.99	25	43	59	77	107	125			
16.00	16.99	30	44	66	80	117	131	4.0	8.0	
17.00	17.99	35	49	73	87	127	141			

Ts 100: Max. chamfering dimension at the full feed.
 Ts max.: Max. chamfering dimension at a 50% feed reduction.
 (Max. chamfering dimension of machining possible without step feeding)

● : Standard item R : Right-hand only L : Left-hand only □ : Check availability

K40

Applicable inserts

Insert		Description	Dimension (mm)		PVD coated carbide	Applicable chamfering holder ➔ K40
			W1	S	PR0315	
		CT08T2-45A	8	2.83	●	S20-CH10
		CT12T3-45A	12	3.98	●	S32-CH12 ? S32-CH18

Method to use DRC chamfering attachment

I. Drilling depth adjustment

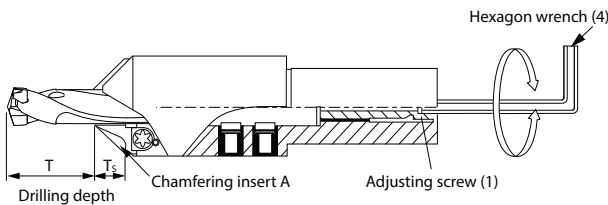

Insert drill into chamfering holder.
Next, temporarily attach the chamfering insert A.
Turn the adjusting screw (1) with the hexagon wrench (4) to set the drilling depth T.

II. Drill location check

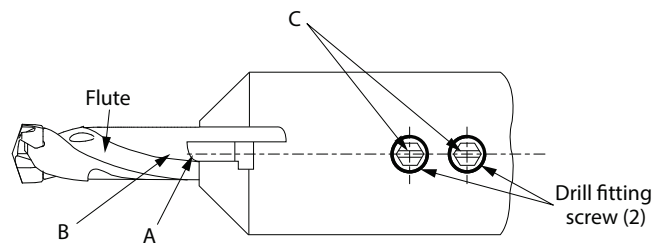

Rotate the drill so that the lower end of the chamfering insert A is aligned with the body clearance B of the drill.
Set it so that slot C and the drill fitting screws (2) are lined up as shown in the figure above.

III. Fix the drill

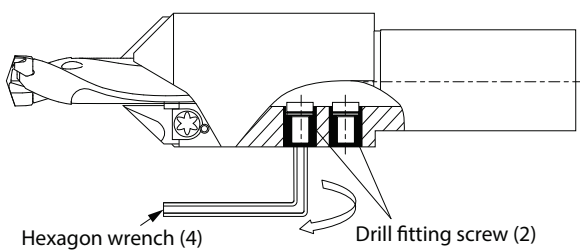

Tighten the drill fitting screws (2) with the hexagon wrench (4) (When using a torque wrench, please refer to the table below)

IV. Installation of the chamfering insert

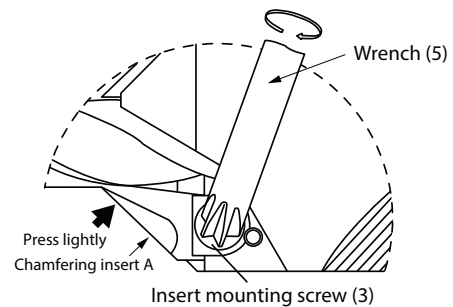

Press the chamfering insert A lightly into the drill and tighten the insert mounting screw (3) with wrench (5).

Spare parts

Chamfering holder	Tightening torque [N·m]	Adjusting screw (1)	Drill fitting screw (2)	Insert mounting screw (3)	Hexagon wrench (4)	Wrench (5)
S20-CH10	10	AJ-6X38	FS-10	MT-3	LW-3	DT-9
S32-CH12	15	AJ-8X44-9.5	FS-12	MT-4	LW-4	DT-15
S32-CH14	20	AJ-10X46	FS-14		LW-5	
S32-CH16	30		FS-16			
S32-CH18	45		FS-18			

● : Standard item R : Right-hand only L : Left-hand only □ : Check availability



SF-DRC (Drilling depth : 3 x DC)

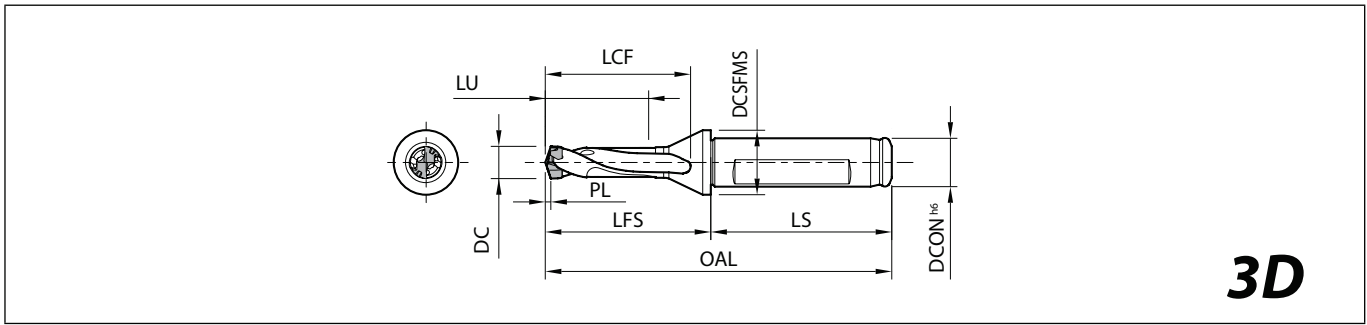

For PL indicates distance from drill point to corner edge K34~K36

Toolholder dimensions

Description	Availability	Dimension (mm)										Coolant hole	Spare parts	Applicable inserts K34~K36
		DC min.	DC max.	DCON	OAL	LFS	LCF	LU	LS	DCSFMS	Wrench			
SF12- DRC080M-3 DRC085M-3 DRC090M-3 DRC095M-3	●	7.94	8.49	12	86	41	35	26	45	16	Yes	* (Included wrench : WDRC8)	WDRC17	DC0794M-SC~DC0840M-SC
	●	8.5	8.99		88	43	37	27						DC0850M-SC~DC0890M-SC
	●	9	9.49		90	45	39	29						DC0900M-SC~DC0940M-SC
	●	9.5	9.99		92	47	41	30						DC0950M-SC~DC0990M-SC
SF16- DRC100M-3 DRC105M-3 DRC110M-3 DRC115M-3 DRC120M-3 DRC125M-3 DRC130M-3 DRC135M-3 DRC140M-3 DRC145M-3	●	10	10.49	16	97	49	43	32	48	20	Yes	* (Included wrench : WDRC10)	WDRC17	DC1000M-SC~DC1040M-SC
	●	10.5	10.99		99	51	45	33						DC1050M-SC~DC1090M-SC
	●	11	11.49		101	53	47	35						DC1100M-SC~DC1140M-SC
	●	11.5	11.99		103	55	49	36						DC1150M-SC~DC1190M-SC
	●	12	12.49		106	58	52	38						DC1200M-SC~DC1240M-SC
	●	12.5	12.99		108	60	54	39						DC1250M-SC~DC1290M-SC
	●	13	13.49		110	62	56	41						DC1300M-SC~DC1340M-SC
	●	13.5	13.99		112	64	58	42						DC1350M-SC~DC1390M-SC
	●	14	14.49		114	66	60	44						DC1400M-SC~DC1440M-SC
	●	14.5	14.99		116	68	62	45						DC1450M-SC~DC1490M-SC
SF20- DRC150M-3 DRC160M-3 DRC170M-3	●	15	15.99	20	122	72	66	48	50	25	Yes	* (Included wrench : WDRC14)	WDRC17	DC1500M-SC~DC1580M-SC
	●	16	16.99		126	76	70	51						DC1600M-SC~DC1690M-SC
	●	17	17.99		131	81	75	54						DC1700M-SC~DC1790M-SC
SF25- DRC180M-3 DRC190M-3 DRC200M-3 DRC210M-3 DRC220M-3 DRC230M-3 DRC240M-3 DRC250M-3	●	18	18.99	25	141	85	79	57	56	32	Yes	* (Included wrench : WDRC17)	WDRC17	DC1800M-SC~DC1890M-SC
	●	19	19.99		145	89	83	60						DC1900M-SC~DC1990M-SC
	●	20	20.99		149	93	87	63						DC2000M-SC~DC2099M-SC
	●	21	21.99		153	97	91	66						DC2100M-SC~DC2150M-SC
	●	22	22.99		158	102	96	69						DC2200M-SC~DC2250M-SC
	●	23	23.99		162	106	100	72						DC2300M-SC~DC2350M-SC
	●	24	24.99		166	110	104	75						DC2400M-SC~DC2450M-SC
	●	25	25.99		170	114	108	78						DC2500M-SC~DC2599M-SC

* Choose „WDRC17“, when purchasing wrench only.

- K
- Drilling
- DRA
- DRC
- DRV
- DRZ
- DRXR
- DRW

Description Identification System (Toolholder)

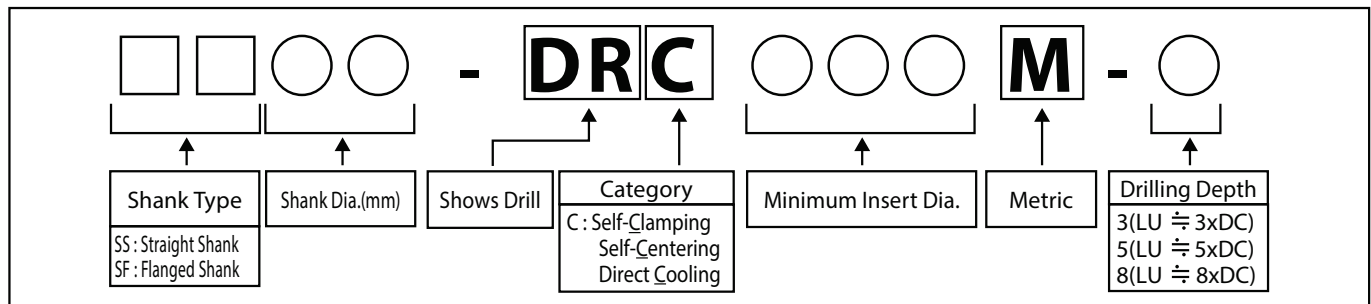

● : Standard item R : Right-hand only L : Left-hand only □ : Check availability

SF-DRC (Drilling depth : 5 x DC)

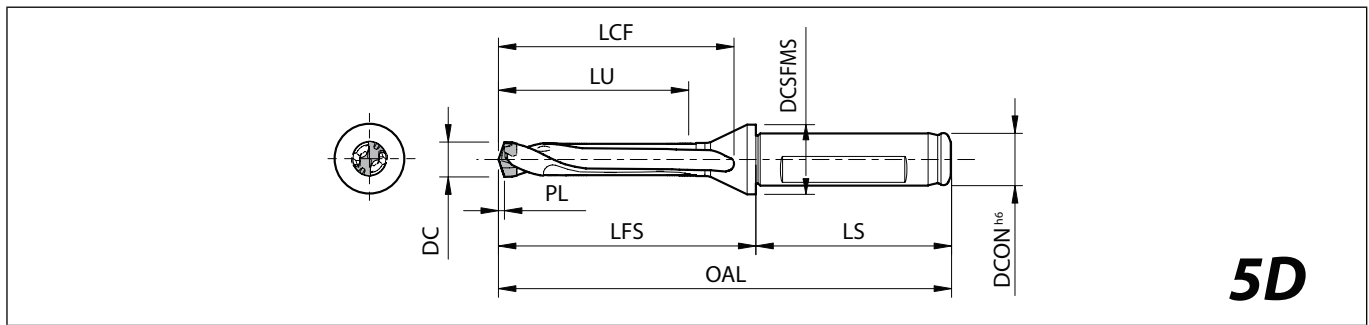

For PL indicates distance from drill point to corner edge K34~K36

Toolholder dimensions

Description	Availability	Dimension (mm)										Coolant hole	Spare parts	
		DC min.	DC max.	DCON	OAL	LFS	LCF	LU	LS	DCSFMS	Wrench		Applicable inserts K34~K36	
SF12- DRC080M-5 DRC085M-5 DRC090M-5 DRC095M-5	●	7.94	8.49	12	104	59	53	43	45	16	Yes	WDR17 *(Included wrench : WDR8)	DC0794M-SC~DC0840M-SC	
	●	8.5	8.99		107	62	56	45					DC0850M-SC~DC0890M-SC	
	●	9	9.49		110	65	59	48					DC0900M-SC~DC0940M-SC	
	●	9.5	9.99		114	69	63	50					DC0950M-SC~DC0990M-SC	
SF16- DRC100M-5 DRC105M-5 DRC110M-5 DRC115M-5 DRC120M-5 DRC125M-5 DRC130M-5 DRC135M-5 DRC140M-5 DRC145M-5	●	10	10.49	16	120	72	66	53	48	20	Yes	WDR17 *(Included wrench : WDR10)	DC1000M-SC~DC1040M-SC	
	●	10.5	10.99		123	75	69	55					DC1050M-SC~DC1090M-SC	
	●	11	11.49		126	78	72	58					DC1100M-SC~DC1140M-SC	
	●	11.5	11.99		129	81	75	60					DC1150M-SC~DC1190M-SC	
	●	12	12.49		132	84	78	63				WDR17 *(Included wrench : WDR12)	DC1200M-SC~DC1240M-SC	
	●	12.5	12.99		135	87	81	65					DC1250M-SC~DC1290M-SC	
	●	13	13.49		138	90	84	68					DC1300M-SC~DC1340M-SC	
	●	13.5	13.99		142	94	88	70				WDR17 *(Included wrench : WDR14)	DC1350M-SC~DC1390M-SC	
	●	14	14.49		145	97	91	73					DC1400M-SC~DC1440M-SC	
	●	14.5	14.99		148	100	94	75					DC1450M-SC~DC1490M-SC	
SF20- DRC150M-5 DRC160M-5 DRC170M-5	●	15	15.99	20	156	106	100	80	50	25	Yes	WDR17 *(Included wrench : WDR14)	DC1500M-SC~DC1580M-SC	
	●	16	16.99		162	112	106	85					DC1600M-SC~DC1690M-SC	
	●	17	17.99		169	119	113	90					DC1700M-SC~DC1790M-SC	
SF25- DRC180M-5 DRC190M-5 DRC200M-5 DRC210M-5 DRC220M-5 DRC230M-5 DRC240M-5 DRC250M-5	●	18	18.99	25	181	125	119	95	56	32	Yes	WDR17	DC1800M-SC~DC1890M-SC	
	●	19	19.99		187	131	125	100					DC1900M-SC~DC1990M-SC	
	●	20	20.99		193	137	131	105					DC2000M-SC~DC2099M-SC	
	●	21	21.99		200	144	138	110					DC2100M-SC~DC2150M-SC	
	●	22	22.99		206	150	144	115					DC2200M-SC~DC2250M-SC	
	●	23	23.99		212	156	150	120					DC2300M-SC~DC2350M-SC	
	●	24	24.99		218	162	156	125					DC2400M-SC~DC2450M-SC	
	●	25	25.99		225	169	163	130					DC2500M-SC~DC2599M-SC	

* Choose „WDR17“, when purchasing wrench only.

● : Standard item R : Right-hand only L : Left-hand only □ : Check availability



SF-DRC (Drilling depth : 8 x DC)

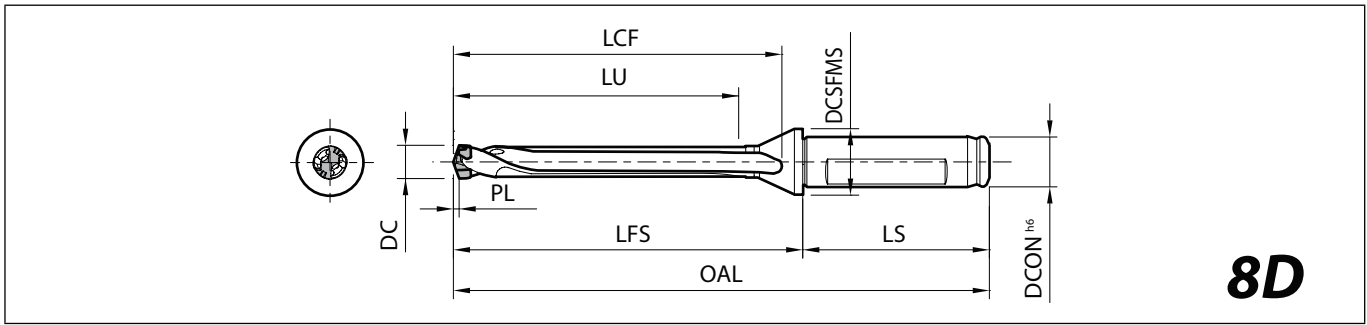

For PL indicates distance from drill point to corner edge K34~K36

Toolholder dimensions

Description	Availability	Dimension (mm)										Coolant hole	Spare parts	
		DC min.	DC max.	DCON	OAL	LFS	LCF	LU	LS	DCSFMS	Wrench		Applicable inserts K34~K36	
SF12- DRC080M-8 DRC085M-8 DRC090M-8 DRC095M-8	●	7.94	8.49	12	129	84	79	68	45	16	Yes	*	WDR17 (Included wrench : WDR8)	DC0794M-SC~DC0840M-SC
	●	8.5	8.99		134	89	83	72						DC0850M-SC~DC0890M-SC
	●	9	9.49		138	93	88	76						DC0900M-SC~DC0940M-SC
	●	9.5	9.99		144	99	93	80						DC0950M-SC~DC0990M-SC
SF16- DRC100M-8 DRC105M-8 DRC110M-8 DRC115M-8 DRC120M-8 DRC125M-8 DRC130M-8 DRC135M-8 DRC140M-8 DRC145M-8	●	10	10.49	16	151	103	97	84	48	20	Yes	*	WDR17 (Included wrench : WDR10)	DC1000M-SC~DC1040M-SC
	●	10.5	10.99		156	108	102	88						DC1050M-SC~DC1090M-SC
	●	11	11.49		160	112	107	92						DC1100M-SC~DC1140M-SC
	●	11.5	11.99		165	117	111	96						DC1150M-SC~DC1190M-SC
	●	12	12.49		169	121	116	100					WDR17 (Included wrench : WDR12)	DC1200M-SC~DC1240M-SC
	●	12.5	12.99		174	126	120	104						DC1250M-SC~DC1290M-SC
	●	13	13.49		178	130	124	108						DC1300M-SC~DC1340M-SC
	●	13.5	13.99		184	136	130	112						DC1350M-SC~DC1390M-SC
	●	14	14.49		188	140	134	116						DC1400M-SC~DC1440M-SC
	●	14.5	14.99		193	145	139	120						DC1450M-SC~DC1490M-SC
SF20- DRC150M-8 DRC160M-8 DRC170M-8	●	15	15.99	20	204	154	148	128	50	25	Yes	*	WDR17 (Included wrench : WDR14)	DC1500M-SC~DC1580M-SC
	●	16	16.99		213	163	157	136						DC1600M-SC~DC1690M-SC
	●	17	17.99		223	173	167	144						DC1700M-SC~DC1790M-SC
SF25- DRC180M-8 DRC190M-8 DRC200M-8 DRC210M-8 DRC220M-8 DRC230M-8 DRC240M-8 DRC250M-8	●	18	18.99	25	238	182	176	152	56	32	Yes	*	WDR17	DC1800M-SC~DC1890M-SC
	●	19	19.99		247	191	185	160						DC1900M-SC~DC1990M-SC
	●	20	20.99		256	200	194	168						DC2000M-SC~DC2099M-SC
	●	21	21.99		266	210	204	176						DC2100M-SC~DC2150M-SC
	●	22	22.99		275	219	213	184						DC2200M-SC~DC2250M-SC
	●	23	23.99		284	228	222	192						DC2300M-SC~DC2350M-SC
	●	24	24.99		293	237	231	200						DC2400M-SC~DC2450M-SC
	●	25	25.99		303	247	241	208						DC2500M-SC~DC2599M-SC

* Choose „WDR17“, when purchasing wrench only.

K

Drilling

DRA

DRC

DRV





DRZ

DRXR

DRW

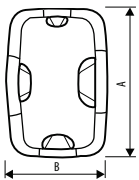
● : Standard item R : Right-hand only L : Left-hand only □ : Check availability

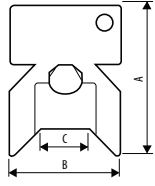
Wrench

Shape		Description	Dimension (mm)			Remarks
			A	B	C	
		WDR17	77	52	-	<ul style="list-style-type: none"> WDR17(Multiple type wrench) has four insert entry points. If using an insert ranging from DC1700M-SC to DC2099M-SC, use the entry point printed as "ø17.00~ø20.99". WDR17 can be used instead of WDR8~14 wrench.
		WDR8	43	33	ø10.2	 <p>Description is printed in this area.</p>
		WDR10			ø12.2	
		WDR12			ø14.2	
		WDR14			ø17.2	

Method to change MagicDrill DRC inserts

How to attach inserts



1. Fix drill holder on arbor. For insert exchange, fix arbor on the machine or set on toolpresetter.
2. Use compressed air to remove dust.



3. Install insert onto holder.
(Use gloves to protect your hand from any danger.)



4. Turn lightly in a clockwise direction.
(Use gloves to protect your hand from any danger.)



5. Align the wrench properly with the insert.



6. Make sure the wrench is aligned with the wrench slots on the insert.



(Improper alignment shown)



7. Turn the wrench in a slow counterclockwise direction.
8. Completed.

How to detach inserts

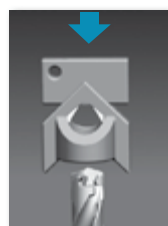

1. Use compressed air to remove dust.
2. Align the wrench properly with the insert.



3. Make sure the wrench is aligned with the wrench slots on the insert.



4. Turn the wrench in a counterclockwise direction.



5. Once lock is released, insert can be turned by fingers.
(Use gloves to protect your hand from any danger.)



6. Remove insert.
(Use gloves to protect your hand from any danger.)

Recommended cutting conditions

Workpiece material		Hardness (HB)	Cutting conditions		Drill dia. DC (mm)							Remarks	
			Vc (m/min)	n (min ⁻¹)	ø8	ø10	ø12	ø14	ø16	ø18	ø20		ø25
				f (mm/rev)									
Low carbon steel	C10E~C25	125	120 - 180	n (min ⁻¹)	4,780 - 7,170	3,820 - 5,730	3,180 - 4,780	2,730 - 4,090	2,390 - 3,580	2,120 - 3,180	1,910 - 2,870	1,530 - 2,290	
				f (mm/rev)	0.11 - 0.20	0.13 - 0.24	0.14 - 0.28	0.17 - 0.32	0.19 - 0.35	0.23 - 0.38	0.25 - 0.41	0.30 - 0.50	
Carbon steel	C30~C60 (Annealed)	190	100 - 150	n (min ⁻¹)	3,980 - 5,970	3,180 - 4,780	2,650 - 3,980	2,270 - 3,410	1,990 - 2,990	1,770 - 2,650	1,590 - 2,390	1,270 - 1,910	Coolant
				f (mm/rev)	0.13 - 0.24	0.15 - 0.29	0.17 - 0.33	0.19 - 0.36	0.22 - 0.41	0.25 - 0.46	0.28 - 0.48	0.32 - 0.60	
	C30~C60 (Heat treated)	250	80 - 120	n (min ⁻¹)	3,180 - 4,780	2,550 - 3,820	2,120 - 3,180	1,820 - 2,730	1,590 - 2,390	1,420 - 2,120	1,270 - 1,910	1,020 - 1,530	
				f (mm/rev)	0.13 - 0.21	0.15 - 0.25	0.18 - 0.31	0.21 - 0.39	0.23 - 0.45	0.25 - 0.53	0.28 - 0.61	0.38 - 0.64	
		300	50 - 75	n (min ⁻¹)	1,990 - 2,990	1,590 - 2,390	1,330 - 1,990	1,140 - 1,710	1,000 - 1,490	880 - 1,330	800 - 1,190	640 - 960	
				f (mm/rev)	0.11 - 0.19	0.12 - 0.23	0.16 - 0.28	0.21 - 0.32	0.23 - 0.35	0.25 - 0.41	0.28 - 0.41	0.32 - 0.45	
Alloy steel	(Annealed)	180	70 - 95	n (min ⁻¹)	2,790 - 3,780	2,230 - 3,030	1,860 - 2,520	1,590 - 2,160	1,390 - 1,890	1,240 - 1,680	1,110 - 1,510	890 - 1,210	
				f (mm/rev)	0.15 - 0.28	0.16 - 0.35	0.21 - 0.37	0.23 - 0.46	0.25 - 0.46	0.25 - 0.51	0.30 - 0.51	0.35 - 0.60	
	(Heat treated)	275	70 - 95	n (min ⁻¹)	2,790 - 3,780	2,230 - 3,030	1,860 - 2,520	1,590 - 2,160	1,390 - 1,890	1,240 - 1,680	1,110 - 1,510	890 - 1,210	
				f (mm/rev)	0.11 - 0.21	0.14 - 0.25	0.19 - 0.30	0.21 - 0.33	0.23 - 0.37	0.28 - 0.43	0.28 - 0.46	0.32 - 0.58	
		300	60 - 90	n (min ⁻¹)	2,390 - 3,580	1,910 - 2,870	1,590 - 2,390	1,360 - 2,050	1,190 - 1,790	1,060 - 1,590	960 - 1,430	760 - 1,150	
				f (mm/rev)	0.11 - 0.19	0.12 - 0.23	0.16 - 0.26	0.18 - 0.31	0.21 - 0.33	0.23 - 0.36	0.25 - 0.38	0.30 - 0.50	
		350	50 - 70	n (min ⁻¹)	1,990 - 2,990	1,590 - 2,390	1,330 - 1,990	1,140 - 1,710	1,000 - 1,490	880 - 1,330	800 - 1,190	640 - 960	
				f (mm/rev)	0.11 - 0.20	0.12 - 0.23	0.16 - 0.25	0.17 - 0.29	0.18 - 0.32	0.20 - 0.36	0.23 - 0.38	0.28 - 0.50	
Stainless steel	X5CrNi18 9 X5CrNiMo17 122	220	60 - 80	n (min ⁻¹)	2,390 - 3,180	1,910 - 2,550	1,590 - 2,120	1,360 - 1,820	1,190 - 1,590	1,060 - 1,420	960 - 1,270	760 - 1,020	
				f (mm/rev)	0.11 - 0.19	0.12 - 0.23	0.16 - 0.26	0.18 - 0.31	0.21 - 0.33	0.23 - 0.36	0.25 - 0.38	0.28 - 0.42	
	X5CrNiCuNb 16-4	300	50 - 70	n (min ⁻¹)	1,990 - 2,790	1,590 - 2,230	1,330 - 1,860	1,140 - 1,590	1,000 - 1,390	880 - 1,240	800 - 1,110	640 - 890	
				f (mm/rev)	0.11 - 0.20	0.12 - 0.23	0.16 - 0.25	0.17 - 0.29	0.18 - 0.32	0.20 - 0.36	0.23 - 0.38	0.25 - 0.40	
Gray cast iron	GG15~GG20	180	120 - 170	n (min ⁻¹)	4,780 - 6,770	3,820 - 5,410	3,180 - 4,510	2,730 - 3,870	2,390 - 3,380	2,120 - 3,010	1,910 - 2,710	1,530 - 2,170	
				f (mm/rev)	0.17 - 0.32	0.20 - 0.37	0.23 - 0.43	0.27 - 0.48	0.30 - 0.55	0.33 - 0.61	0.33 - 0.61	0.40 - 0.74	
	GG25~GG35	260	90 - 120	n (min ⁻¹)	3,580 - 4,780	2,870 - 3,820	2,390 - 3,180	2,050 - 2,730	1,790 - 2,390	1,590 - 2,120	1,430 - 1,910	1,150 - 1,530	
				f (mm/rev)	0.14 - 0.25	0.16 - 0.31	0.19 - 0.35	0.23 - 0.42	0.26 - 0.47	0.28 - 0.53	0.30 - 0.58	0.36 - 0.70	
Nodular cast iron	GGG40~GGG50	160	60 - 90	n (min ⁻¹)	2,390 - 3,580	1,910 - 2,870	1,590 - 2,390	1,360 - 2,050	1,190 - 1,790	1,060 - 1,590	960 - 1,430	760 - 1,150	
				f (mm/rev)	0.14 - 0.25	0.16 - 0.30	0.19 - 0.35	0.22 - 0.40	0.24 - 0.45	0.28 - 0.51	0.28 - 0.56	0.34 - 0.67	
	GGG60~GGG80	250	40 - 65	n (min ⁻¹)	1,590 - 2,590	1,270 - 2,070	1,060 - 1,730	910 - 1,480	800 - 1,290	710 - 1,150	640 - 1,040	510 - 830	
				f (mm/rev)	0.10 - 0.19	0.12 - 0.22	0.14 - 0.25	0.16 - 0.31	0.19 - 0.35	0.23 - 0.51	0.25 - 0.53	0.30 - 0.60	

As drilling depth increases (3D → 5D → 8D), feed rates should be reduced.

K



Drilling

DRA

DRC

DRV

DRZ

DRXR

DRW

Reference charts

Cutting conditions: Workpiece material heat treated steel (Hardness 240HB) Vc = 80 m/min, wet

Required power

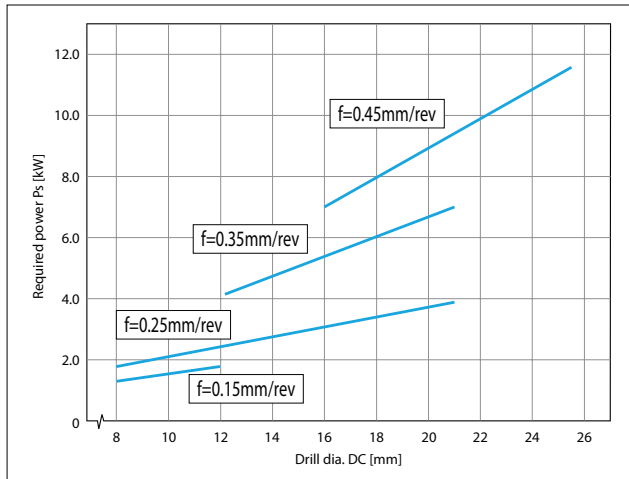

Torque

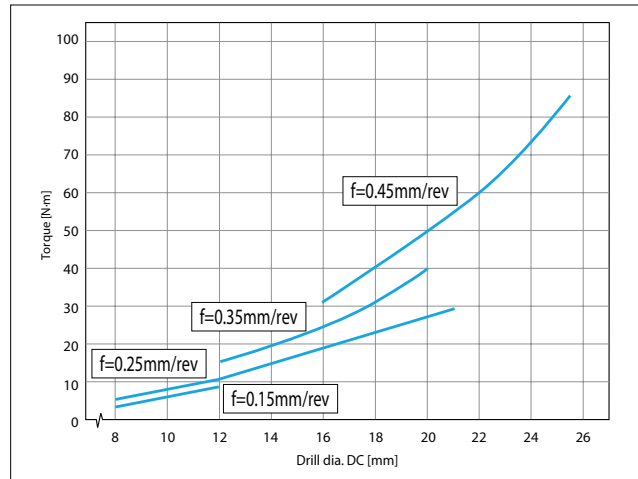

Coolant

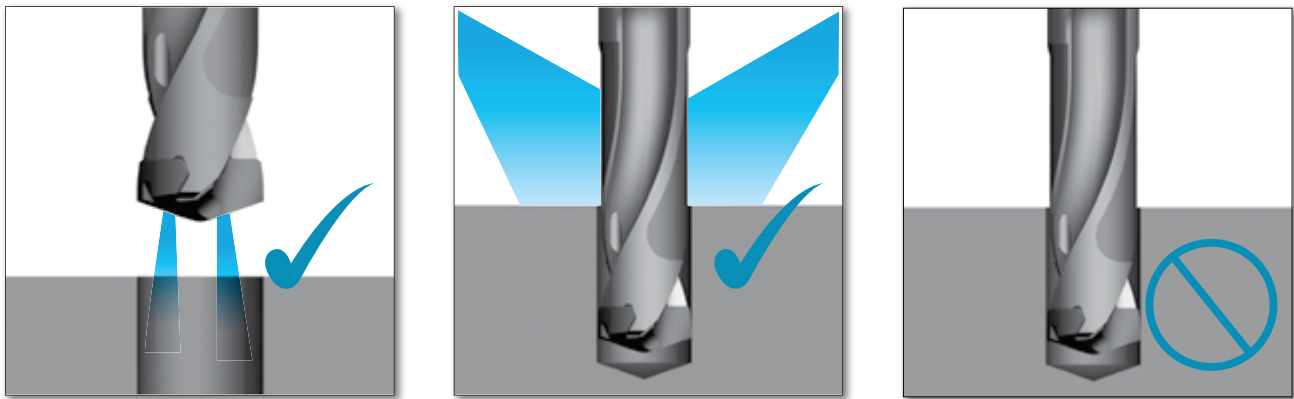

1. Internal coolant is recommended.

2. In case of using external coolant system

3. Dry machining is not recommended.

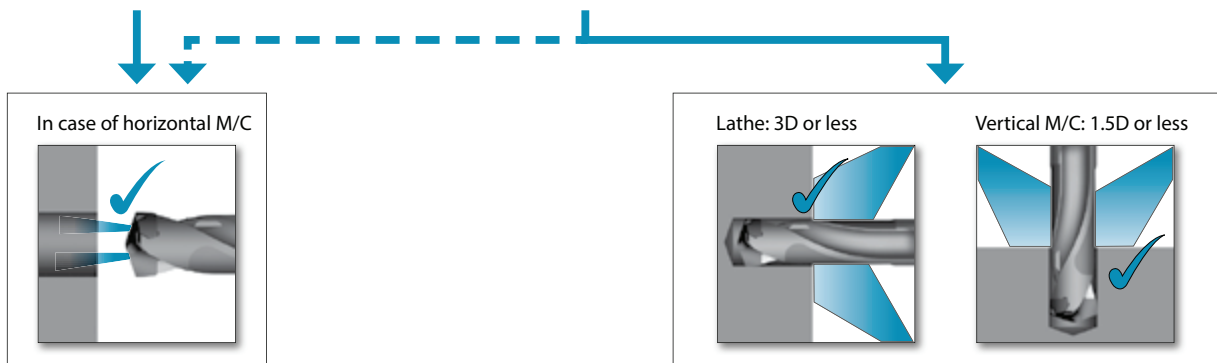

Internal coolant is recommended for horizontal machining center because external coolant may not sufficiently be applied to inside because the tool is revolving.

Precautions for use

Core deviation

1. If drill is stationary

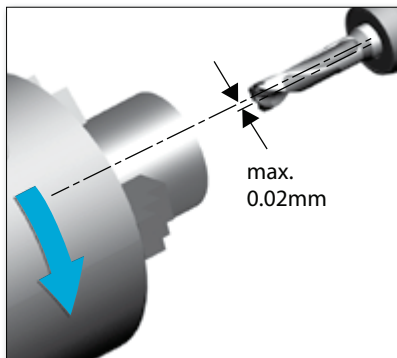

This can be used with a boring sleeve (Screw clamp) and collet chuck, please be sure to set deviation amount within 0.02mm between workpiece and drill.

2. If drill is rotating

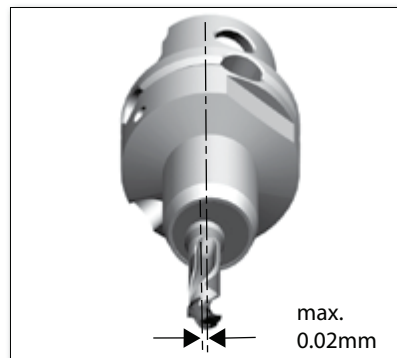

Make sure to use arbor that is not deformed. Center of arbor deviation must be within 0.02mm.

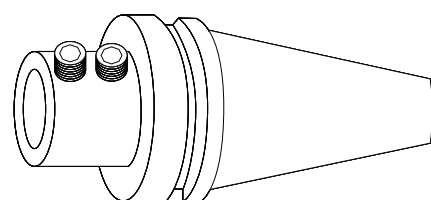
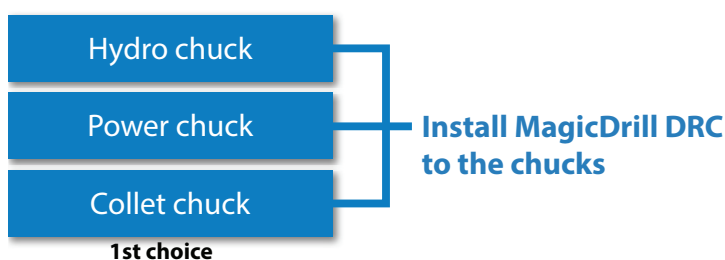

Cautions for installation on machining center

For installation of MagicDrill DRC,
1st choice hydro chuck, power chuck, collet chuck, etc.
2nd choice side lock arbor

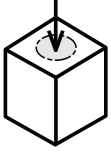
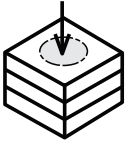
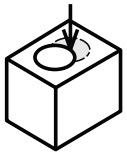
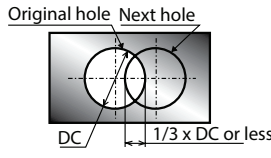

Example of side lock arbor
 2nd choice

Applicable workpieces

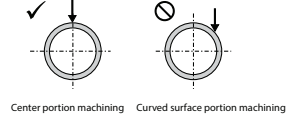
Applications	Shape of workpiece	Caution for machining	
Plain surface		<ol style="list-style-type: none"> 1. Due to good chip control, step machining is not necessary for low carbon steel. 2. When machining SUS304, for hole depths of more than 2.5D, utilize the step machining process. 3. In order to have smooth chip removal, we recommend internal coolant. 	
Stacked plates		<ol style="list-style-type: none"> 1. Fix stacked plates securely to ensure so that they do not slip while machining. 	
Hole expansion		<ol style="list-style-type: none"> 1. If the overlap amount is $1/3 \times DC$ or less, machining is possible. 	 <p>Original hole Next hole DC $1/3 \times DC$ or less</p>
Concave surface		<ol style="list-style-type: none"> 1. When machining concave holes, set the feed rates at half or less than continuous hole machining. 	
Pipe material		<ol style="list-style-type: none"> 1. Hole machining above the centerline of the pipe is possible. 2. Do not machine on curved surface areas. 	 <p>Center portion machining Curved surface portion machining</p>

K

Drilling

Not recommended workpieces

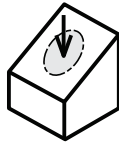
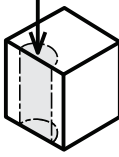
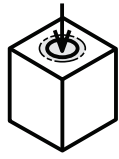
Applications	Shape of workpiece
Slant surface	
Half cylindrical	
Cored hole	

Comparison of Machining Precision

Cutting Condition and Measurement Point

<Cutting Conditions>

Workpiece Material	C45
Vc	100m/min
f	0.2mm/rev, 0.3mm/rev
Drilling Depth H	Through hole (40mm)
Coolant	Wet (Internal coolant)
Tool	φ14-3D type
Machine	M/C

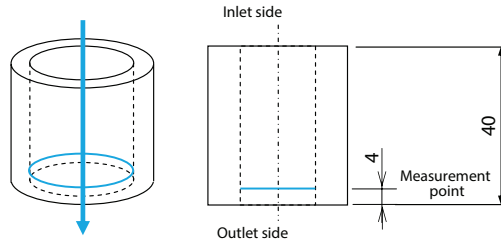

Roundness

1) Roundness (f=0.2mm/rev)

Indexable drill		Carbide solid drill		
Kyocera	Competitor F	Competitor B	Competitor C	Competitor N
Roundness : 5.5μm	Roundness : 22.5μm	Roundness : 6.4μm	Roundness : 9.8μm	Roundness : 5.2μm

(Internal evaluation)

2) Roundness (f=0.3mm/rev)

Indexable drill		Carbide solid drill		
Kyocera	Competitor F	Competitor B	Competitor C	Competitor N
Roundness : 10.7μm	Roundness : 15.2μm	Roundness : 12.0μm	Roundness : 11.8μm	Roundness : 12.3μm

(Internal evaluation)

Comparison of Hole Dia. (f=0.3mm/rev)

1) Comparison with indexable drill

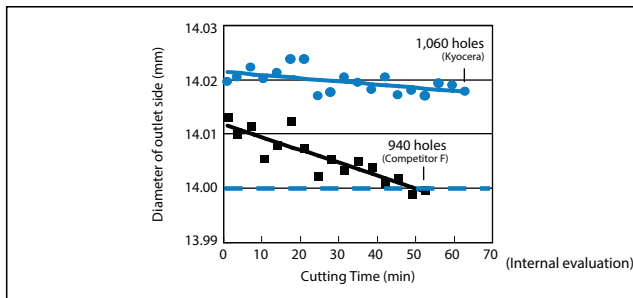

2) Comparison with carbide solid drill

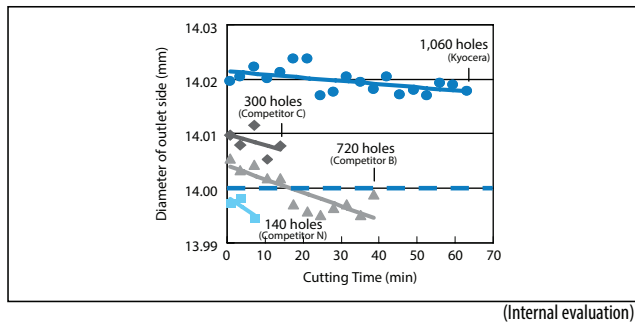

High efficiency indexable insert drill

MagicDrill DRV

Economical inserts with 4 cutting edges.

Excellent chip evacuation with 6D maximum deep-hole drilling.

1 Excellent drilling precision with less variation in cutting diameter Up to 6D drilling capabilities with a low cutting force design

Optimal web thickness reduces chattering with a low cutting force design

Web thickness comparison (Internal evaluation)

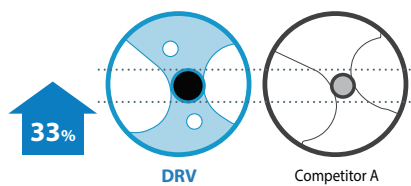

Comparison of cutting diameter variation (Internal evaluation)

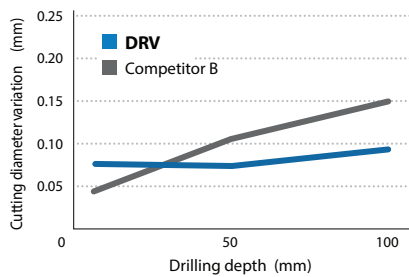

Cutting conditions: $V_c = 150$ m/min, $f = 0.06$ mm/rev
Drill dia. $\varnothing 20(5D)$, wet Workpiece material: C50

Cutting force comparison (Internal evaluation)

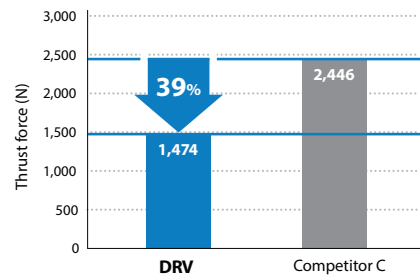

Cutting conditions: $V_c = 200$ m/min, $f = 0.12$ mm/rev
Drill dia. $\varnothing 20(3D)$, wet Workpiece material: C50

2 Unique insert design to control chip flow

Outer edge Smooth chip evacuation with compact chips

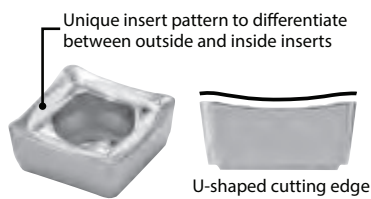

Chipshape comparison of outer insert cutting edge (Internal evaluation)

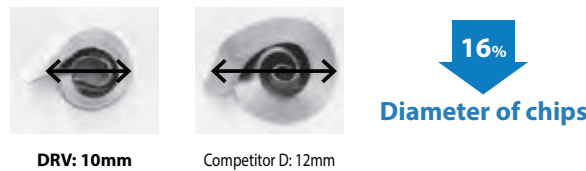

Cutting conditions: $V_c = 150$ m/min, $f = 0.06$ mm/rev, Drill dia. $\varnothing 20(3D)$, wet workpiece material: C50

Inner edge Excellent chip evacuation as well as less wear resistance with reduced chips weight

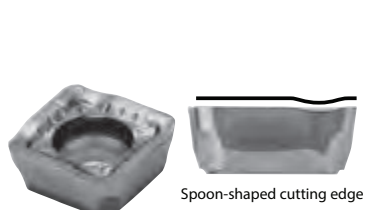

Weight per unit of length for chips generated by the inner edge (Internal evaluation)



Pitch comparison of chips generated by the inner edge (Internal evaluation)

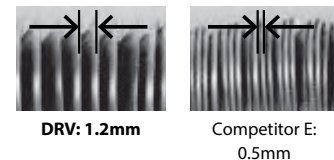

47% reduction in chip weight for DRV

Cutting conditions: $V_c = 250$ m/min, $f = 0.08$ mm/rev, Drill dia. $\varnothing 20(5D)$, wet workpiece material: X5CrNi18 10

3 CVD insert on the outer edge for highly efficient drilling

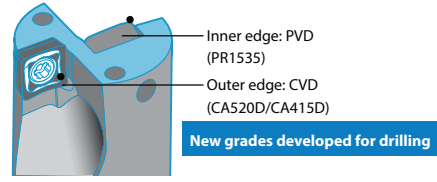

High speed and highly efficient machining available with the combination Of CVD (Outer edge) and PVD (Inner edge) inserts.

Recommended cutting speed (Maximum value)

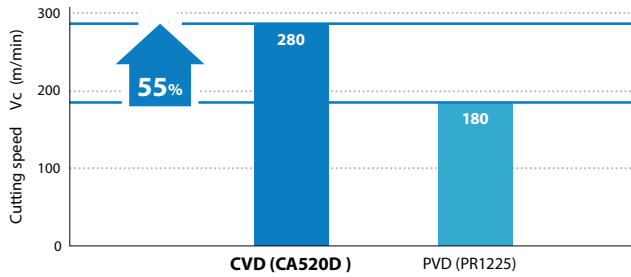

Drill dia. ø20(3D) workpiece material: C50

Wear resistance comparison (Internal evaluation)

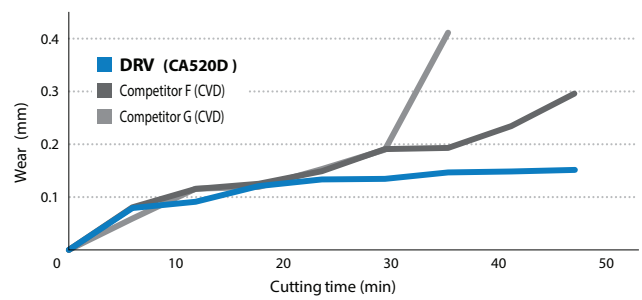

Cutting conditions: Vc = 200 m/min, f = 0.12 mm/rev, Drill dia. ø20(3D), wet workpiece material: 41Cr4

4 Economical inserts with 4 cutting edges 4 types of chipbreakers for various machining applications

General purpose GM chipbreaker

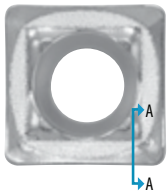

Chipbreaker for steel machining
Stable deep-hole machining with low cutting force

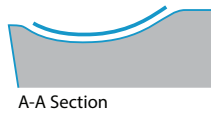

Edge shape optimized for various machining applications

Tough edge GH chipbreaker

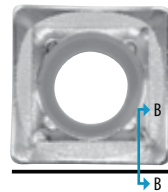

1st recommendation for machining cast iron
Good for continuous steel machining
Reduced breakages common in through-hole machining

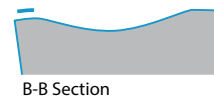

For stainless steel machining SM chipbreaker

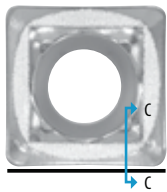

Stable chip control when machining gummy stainless steel.
Reduces chip clogging in the holder body

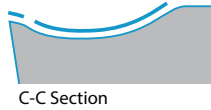

Sharp cutting and large rake angle

Chip control comparison (Internal evaluation)

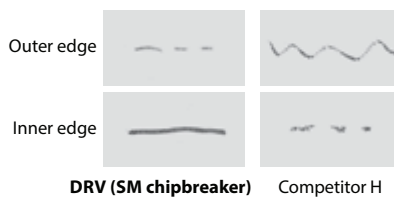

Cutting conditions: Vc = 100 m/min, f = 0.1 Mm/rev
drill dia. Ø20(3d), drilling depth 60mm
wet, workpiece material: X5CrNi18 10

Comparison of remaining chips (Internal evaluation)

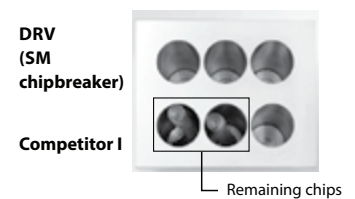

Cutting conditions: Vc = 150 m/min, f = 0.08 Mm/rev
drill dia. Ø25(5d),
drilling depth 98mm, wet,
workpiece material: X5CrNi18 10

For machining soft steel XM chipbreaker

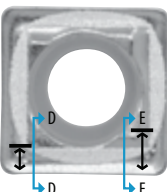

Stable chip control of outer cutting edge

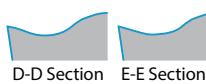





Excellent chip control
With the changing
Width of the chipbreaker

Chip control comparison (Internal evaluation)

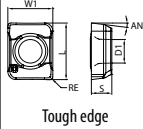

Cutting conditions: Vc = 200 m/min, f = 0.12 mm/rev
Drill dia. ø16(3D), Drilling depth 48 mm
Wet Workpiece material: S5400

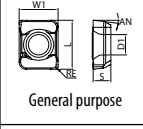
LCMT (outer edge)

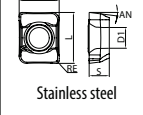
Classification of usage ★ : High speed and highly efficient drilling ☆ : Stable machining oriented		Carbon steel / Alloy steel		★☆☆		P						
		Mold and die steel		★☆☆								
		Stainless steel		★☆☆		M						
		Cast iron		★☆☆		K						
		Non-ferrous metals				N						
Insert	Description	No. of edges	Dimension (mm)					Angle (°)	Carbide			Applicable toolholder K56, K58 K60, K62 K64
			S	D1	RE	L	W1		AN	CVD	PVD	
									CM15D	CAS20D	PR1225	
	 Tough edge LCMT 030203-GH-E	2	2	2.3	0.3	5.54	4.4	7	●	●	●	
	 General purpose LCMT 030203-GM-E	2	2	2.3	0.3	5.54	4.4	7	●	●	●	S20-DRV...M-□-03
	 Stainless steel LCMT 030203-SM-E	2	2	2.3	0.3	5.54	4.4	7	●	●	●	

Recommended cutting conditions ☉ K70~K71



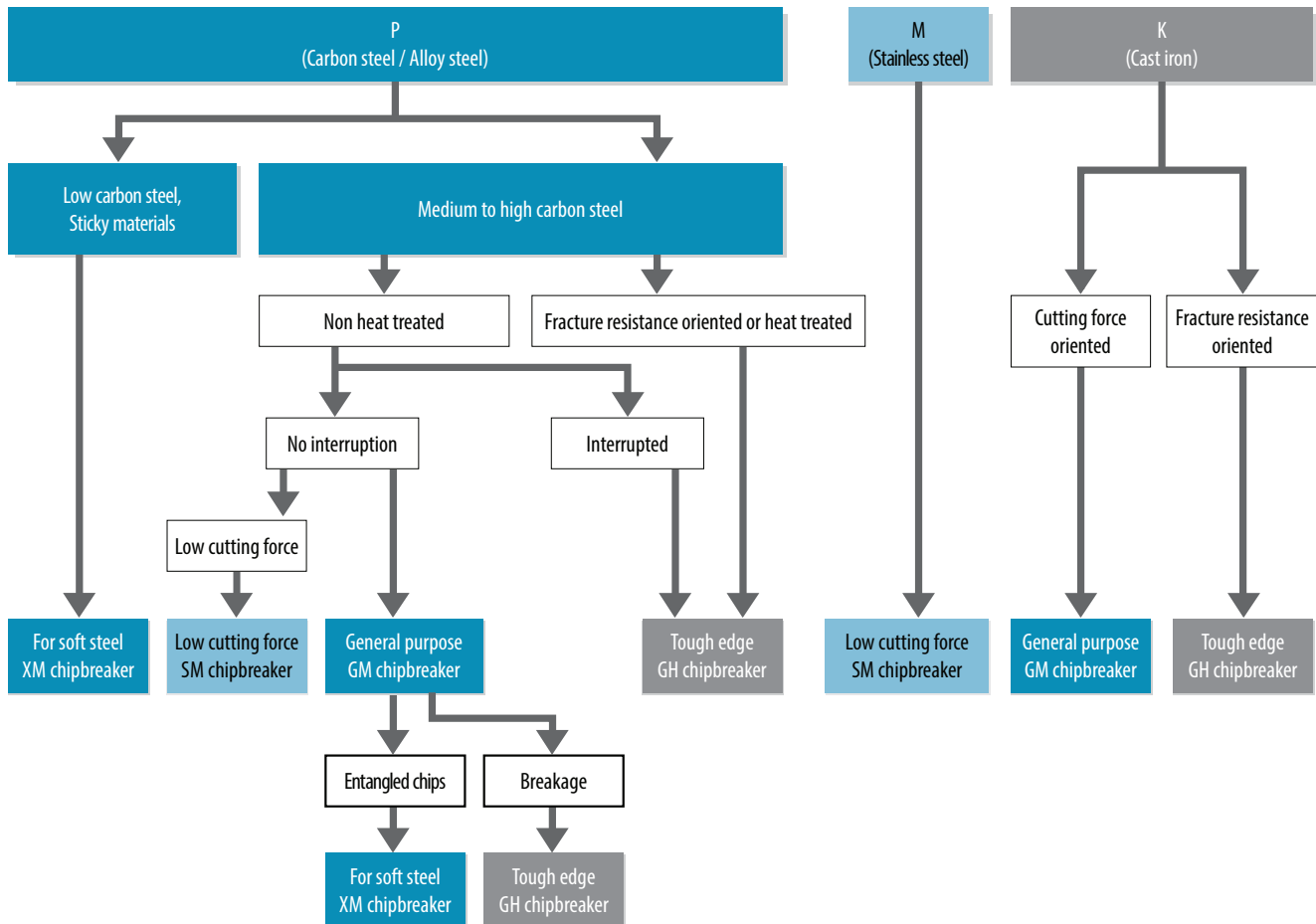

K

Chipbreaker selection chart



● : Standard item R : Right-hand only L : Left-hand only □ : Check availability

SCMT (outer edge)





Classification of usage ★ : High speed and highly efficient drilling ☆ : Stable machining oriented		Carbon steel / Alloy steel		★☆☆		P						
		Mold and die steel		★☆☆								
		Stainless steel		★☆☆		M						
		Cast iron		★☆☆		K						
		Non-ferrous metals				N						
Insert	Description	No. of edges	Dimension (mm)					Angle (°)	Carbide			Applicable toolholder ☉ K56~K64
			IC	S	D1	RE	AN		CVD	PVD		
								CA415D	CAS200	PR1225		
 Tough edge	SCMT 040205-GH-E	4	4.8	2.2	2.4	0.5	7	●	●	●	S...DRV...M-□-04	
	SCMT 050205-GH-E	4	5.25	2.6	2.4	0.5	7	●	●	●	S...DRV...M-□-05	
	SCMT 060205-GH-E	4	6.4	2.8	2.9	0.5	7	●	●	●	S...DRV...M-□-06	
	SCMT 070305-GH-E	4	7.65	3.2	3.5	0.5	7	●	●	●	S...DRV...M-□-07	
	SCMT 090405-GH-E	4	9.1	4.1	4	0.5	7	●	●	●	S...DRV...M-□-09	
	SCMT 110406-GH-E	4	11	4.5	4.6	0.6	7	●	●	●	S...DRV...M-□-11	
	SCMT 140508-GH-E	4	13.8	5	5.7	0.8	7	●	●	●	S...DRV...M-□-14	
	SCMT 170608-GH-E	4	16.8	6.58	6.9	0.8	7	●	●	●	S...DRV...M-□-17	
 General purpose	SCMT 040205-GM-E	4	4.8	2.2	2.4	0.5	7	●	●	●	S...DRV...M-□-04	
	SCMT 050205-GM-E	4	5.25	2.6	2.4	0.5	7	●	●	●	S...DRV...M-□-05	
	SCMT 060205-GM-E	4	6.4	2.8	2.9	0.5	7	●	●	●	S...DRV...M-□-06	
	SCMT 070305-GM-E	4	7.65	3.2	3.5	0.5	7	●	●	●	S...DRV...M-□-07	
	SCMT 090405-GM-E	4	9.1	4.1	4	0.5	7	●	●	●	S...DRV...M-□-09	
	SCMT 110406-GM-E	4	11	4.5	4.6	0.6	7	●	●	●	S...DRV...M-□-11	
	SCMT 140508-GM-E	4	13.8	5	5.7	0.8	7	●	●	●	S...DRV...M-□-14	
	SCMT 170608-GM-E	4	16.8	6.58	6.9	0.8	7	●	●	●	S...DRV...M-□-17	
 Stainless steel	SCMT 040205-SM-E	4	4.8	2.2	2.4	0.5	7	●	●	●	S...DRV...M-□-04	
	SCMT 050205-SM-E	4	5.25	2.6	2.4	0.5	7	●	●	●	S...DRV...M-□-05	
	SCMT 060205-SM-E	4	6.4	2.8	2.9	0.5	7	●	●	●	S...DRV...M-□-06	
	SCMT 070305-SM-E	4	7.65	3.2	3.5	0.5	7	●	●	●	S...DRV...M-□-07	
	SCMT 090405-SM-E	4	9.1	4.1	4	0.5	7	●	●	●	S...DRV...M-□-09	
	SCMT 110406-SM-E	4	11	4.5	4.6	0.6	7	●	●	●	S...DRV...M-□-11	
	SCMT 140508-SM-E	4	13.8	5	5.7	0.8	7	●	●	●	S...DRV...M-□-14	
	SCMT 170608-SM-E	4	16.8	6.58	6.9	0.8	7	●	●	●	S...DRV...M-□-17	
 Low carbon steel	SCMT 040205-XM-E	4	4.8	2.2	2.4	0.5	7	●	●	●	S...DRV...M-□-04	
	SCMT 050205-XM-E	4	5.25	2.6	2.4	0.5	7	●	●	●	S...DRV...M-□-05	
	SCMT 060205-XM-E	4	6.4	2.8	2.9	0.5	7	●	●	●	S...DRV...M-□-06	
	SCMT 070305-XM-E	4	7.65	3.2	3.5	0.5	7	●	●	●	S...DRV...M-□-07	
	SCMT 090405-XM-E	4	9.1	4.1	4	0.5	7	●	●	●	S...DRV...M-□-09	
	SCMT 110406-XM-E	4	11	4.5	4.6	0.6	7	●	●	●	S...DRV...M-□-11	
	SCMT 140508-XM-E	4	13.8	5	5.7	0.8	7	●	●	●	S...DRV...M-□-14	
	SCMT 170608-XM-E	4	16.8	6.58	6.9	0.8	7	●	●	●	S...DRV...M-□-17	

Recommended cutting conditions ☉ K70~K71

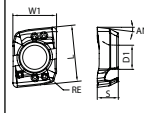

● : Standard item R : Right-hand only L : Left-hand only □ : Check availability

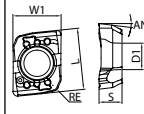
LCMT (inner edge)

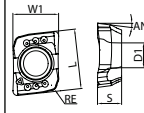
Classification of usage ★ : High speed and highly efficient drilling		Carbon steel / Alloy steel		★		P						
		Mold and die steel		★		M						
Insert		Description		Stainless steel		★		K				
				Cast iron		★		N				
No. of edges		Dimension (mm)					Angle (°)	Carbide	PVD	Applicable toolholder K56, K58 K60, K62 K64		
		S	D1	RE	L	W1					AN	
	 Tough edge	LCMT	030205-GH-I	2	2	2.3	0.5	5.37	4.16	7	●	
	 General purpose	LCMT	030205-GM-I	2	2	2.3	0.5	5.37	4.16	7	●	S20-DRV...M-□-03
	 Stainless steel	LCMT	030205-SM-I	2	2	2.3	0.5	5.37	4.16	7	●	

Recommended cutting conditions → K70~K71

K



Drilling

DRA

DRC

DRV

DRZ





DRXR

DRW

● : Standard item R : Right-hand only L : Left-hand only □ : Check availability

K54

SCMT (inner edge)

Classification of usage ★ : High speed and highly efficient drilling		Carbon steel / Alloy steel							★	P	
		Mold and die steel							★		
Insert		Description		Dimension (mm)					Angle (°)	Carbide PVD PR1535	Applicable toolholder ● K56~K64
				No. of edges	IC	S	D1	RE	AN		
 Tough edge	SCMT 040209-GH-I	4	5	2.2	2.4	0.9	7	●	S...DRV...M-□-04		
	SCMT 050210-GH-I	4	5.7	2.6	2.4	1	7	●	S...DRV...M-□-05		
	SCMT 060210-GH-I	4	6.9	2.8	2.9	1	7	●	S...DRV...M-□-06		
	SCMT 070310-GH-I	4	8.2	3.2	3.5	1	7	●	S...DRV...M-□-07		
	SCMT 090410-GH-I	4	9.8	4.1	4	1	7	●	S...DRV...M-□-09		
	SCMT 110410-GH-I	4	11.9	4.5	4.6	1	7	●	S...DRV...M-□-11		
	SCMT 140510-GH-I	4	14.9	5	5.7	1	7	●	S...DRV...M-□-14		
	SCMT 170610-GH-I	4	17.9	6.58	6.9	1	7	●	S...DRV...M-□-17		
 General purpose	SCMT 040209-GM-I	4	5	2.2	2.4	0.9	7	●	S...DRV...M-□-04		
	SCMT 050210-GM-I	4	5.7	2.6	2.4	1	7	●	S...DRV...M-□-05		
	SCMT 060210-GM-I	4	6.9	2.8	2.9	1	7	●	S...DRV...M-□-06		
	SCMT 070310-GM-I	4	8.2	3.2	3.5	1	7	●	S...DRV...M-□-07		
	SCMT 090410-GM-I	4	9.8	4.1	4	1	7	●	S...DRV...M-□-09		
	SCMT 110410-GM-I	4	11.9	4.5	4.6	1	7	●	S...DRV...M-□-11		
	SCMT 140510-GM-I	4	14.9	5	5.7	1	7	●	S...DRV...M-□-14		
	SCMT 170610-GM-I	4	17.9	6.58	6.9	1	7	●	S...DRV...M-□-17		
 Stainless steel	SCMT 040209-SM-I	4	5	2.2	2.4	0.9	7	●	S...DRV...M-□-04		
	SCMT 050210-SM-I	4	5.7	2.6	2.4	1	7	●	S...DRV...M-□-05		
	SCMT 060210-SM-I	4	6.9	2.8	2.9	1	7	●	S...DRV...M-□-06		
	SCMT 070310-SM-I	4	8.2	3.2	3.5	1	7	●	S...DRV...M-□-07		
	SCMT 090410-SM-I	4	9.8	4.1	4	1	7	●	S...DRV...M-□-09		
	SCMT 110410-SM-I	4	11.9	4.5	4.6	1	7	●	S...DRV...M-□-11		
	SCMT 140510-SM-I	4	14.9	5	5.7	1	7	●	S...DRV...M-□-14		
	SCMT 170610-SM-I	4	17.9	6.58	6.9	1	7	●	S...DRV...M-□-17		
 Low carbon steel	SCMT 040209-XM-I	4	5	2.2	2.4	0.9	7	●	S...DRV...M-□-04		
	SCMT 050210-XM-I	4	5.7	2.6	2.4	1	7	●	S...DRV...M-□-05		
	SCMT 060210-XM-I	4	6.9	2.8	2.9	1	7	●	S...DRV...M-□-06		
	SCMT 070310-XM-I	4	8.2	3.2	3.5	1	7	●	S...DRV...M-□-07		
	SCMT 090410-XM-I	4	9.8	4.1	4	1	7	●	S...DRV...M-□-09		
	SCMT 110410-XM-I	4	11.9	4.5	4.6	1	7	●	S...DRV...M-□-11		
	SCMT 140510-XM-I	4	14.9	5	5.7	1	7	●	S...DRV...M-□-14		
	SCMT 170610-XM-I	4	17.9	6.58	6.9	1	7	●	S...DRV...M-□-17		

Recommended cutting conditions ● K70~K71

● : Standard item R : Right-hand only L : Left-hand only □ : Check availability



DRV (Drilling depth : 2 x DC)

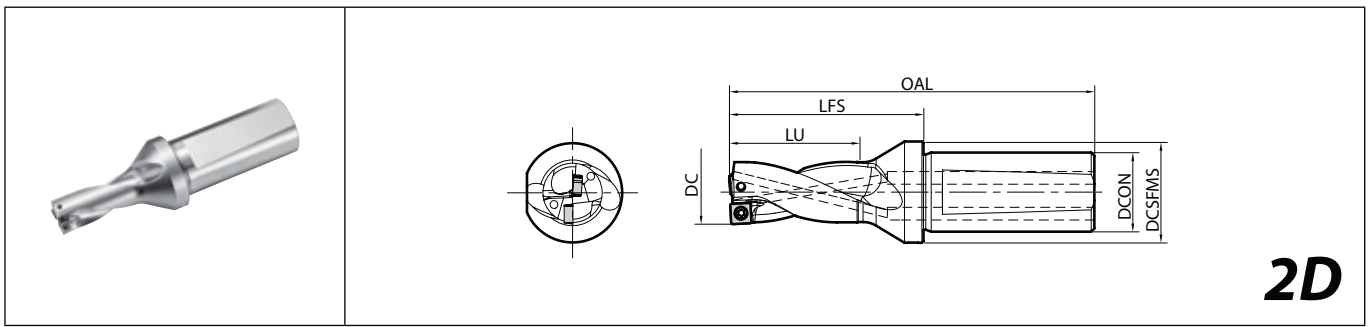

Toolholder dimensions

Description	Availability	No. of inserts	Dimension (mm)					Coolant hole	Radial offset max.	Spare parts				Applicable inserts K52~K55	
			DC	DCON	OAL	LFS	LU			DCSFMS	Screw	Wrench	Wrench		Wrench
S20- DRV120M-2-03 DRV125M-2-03 DRV130M-2-03 DRV135M-2-03	●	2	12	20	82	39	24	27	Yes	+0.25	SB-2037TRP	-	FTP-6	-	LCMT030203-□-E (Outer) LCMT030205-□-I (Inner)
	●		12.5		83	40	25			+0.2					
	●		13		84	41	26			+0.15					
	●		13.5		85	42	27			+0.1					
S20- DRV140M-2-04 DRV145M-2-04 DRV150M-2-04 DRV155M-2-04	●	2	14	20	92	49	28	27	Yes	+0.4	SB-2037TRP	-	FTP-6	-	SCMT040205-□-E (Outer) SCMT040209-□-I (Inner)
	●		14.5		93	50	29			+0.35					
	●		15		94	51	30			+0.3					
	●		15.5		95	52	31			+0.25					
S25- DRV160M-2-05 DRV165M-2-05 DRV170M-2-05 DRV175M-2-05 DRV180M-2-05 DRV185M-2-05	●	2	16	25	110	56	32	32	Yes	+0.4	SB-2041TRP	-	FTP-6	-	SCMT050205-□-E (Outer) SCMT050210-□-I (Inner)
	●		16.5		111	57	33			+0.35					
	●		17		112	58	34			+0.3					
	●		17.5		113	59	35			+0.25					
	●		18		114	60	36			+0.2					
	●		18.5		115	61	37			+0.15					
S25- DRV190M-2-06 DRV195M-2-06 DRV200M-2-06 DRV205M-2-06 DRV210M-2-06 DRV215M-2-06 DRV220M-2-06	●	2	19	25	113	59	38	32	Yes	+0.65	SB-2555TRP	DTPM-8	-	-	SCMT060205-□-E (Outer) SCMT060210-□-I (Inner)
	●		19.5		114	60	39			+0.6					
	●		20		115	61	40			+0.55					
	●		20.5		116	62	41			0.5					
	●		21		117	63	42			+0.45					
	●		21.5		118	64	43			+0.35					
	●		22		119	65	44			+0.3					
	●		22.5		120	66	45			+0.9					
S25- DRV225M-2-07 DRV230M-2-07 DRV235M-2-07 DRV240M-2-07 DRV245M-2-07 DRV250M-2-07 DRV255M-2-07 DRV260M-2-07	●	2	22.5	25	120	66	45	32	Yes	+0.9	SB-3060TRP	DTPM-10	-	-	SCMT070305-□-E (Outer) SCMT070310-□-I (Inner)
	●		23		121	67	46			+0.8					
	●		23.5		122	68	47			+0.75					
	●		24		123	69	48			+0.7					
	●		24.5		124	70	49			+0.65					
	●		25		125	71	50			+0.6					
	●		25.5		126	72	51			+0.5					
	●		26		127	73	52			+0.45					
S32- DRV270M-2-09 DRV280M-2-09 DRV290M-2-09 DRV300M-2-09 DRV310M-2-09 DRV320M-2-09	●	2	27	32	136	77	54	41	Yes	+1.05	SB-3573TRP	DTPM-10	-	-	SCMT090405-□-E (Outer) SCMT090410-□-I (Inner)
	●		28		138	79	56			+0.95					
	●		29		140	81	58			+0.85					
	●		30		142	83	60			+0.75					
	●		31		144	85	62			+0.6					
	●		32		146	87	64			+0.5					

When offset drilling, reduce feed rate to 0.08 mm/rev or less.
See page K72 for Adjustable Sleeve (SHE).

Recommended cutting conditions **K70**
Trouble shooting **K67**

● : Standard item R : Right-hand only L : Left-hand only □ : Check availability

K

Drilling

DRA

DRC

DRV





DRZ

DRXR

DRW

Toolholder dimensions

2xDC

Description	Availability	No. of inserts	Dimension (mm)						Coolant hole	Radial offset max.	Spare parts				Applicable inserts K53, K55									
			DC	DCON	OAL	LFS	LU	DCSFMS			Screw	Wrench	Wrench	Wrench										
																								
S40- DRV330M-2-11 DRV340M-2-11 DRV350M-2-11 DRV360M-2-11 DRV370M-2-11 DRV380M-2-11 DRV390M-2-11	●	2	33	40	161	92	66	49	Yes	+1.25	SB-4086TRP	DTPM-15	-	-	SCMT110406-□-E (Outer) SCMT110410-□-I (Inner)									
	●		34		163	94	68		+1.15															
	●		35		165	96	70		+1															
	●		36		167	98	72		+0.9															
	●		37		169	100	74		+0.8															
	●		38		171	102	76		+0.65															
	●		39		173	104	78		+0.55															
S40- DRV400M-2-14 DRV410M-2-14 DRV420M-2-14 DRV430M-2-14 DRV440M-2-14 DRV450M-2-14 DRV460M-2-14 DRV470M-2-14 DRV480M-2-14 DRV490M-2-14	●	2	40	40	181	112	80	49	Yes	+1.75	SB-50120TRPH	-	-	TTP-20	SCMT140508-□-E (Outer) SCMT140510-□-I (Inner)									
	●		41		183	114	82			+1.6														
	●		42		185	116	84			+1.5														
	●		43		187	118	86			+1.4														
	●		44		189	120	88			+1.3														
	●		45		191	122	90			+1.15														
	●		46		193	124	92			+1.05														
	●		47		195	126	94			+0.95														
	●		48		197	128	96			+0.8														
	●		49		199	130	98			+0.7														
	S40- DRV500M-2-17 DRV510M-2-17 DRV520M-2-17 DRV530M-2-17 DRV540M-2-17 DRV550M-2-17 DRV560M-2-17 DRV570M-2-17 DRV580M-2-17 DRV590M-2-17 DRV600M-2-17		●		2	50	40			198						129	100	59	Yes	+2.1	SB-60130TRP	-	-	TTP-20
●		51	200	131		102		+1.95																
●		52	202	133		104		+1.85																
●		53	204	135		106		+1.75																
●		54	206	137		108		+1.65																
●		55	208	139		110		+1.5																
●		56	210	141		112		+1.4																
●		57	212	143		114		+1.3																
●		58	214	145		116		+1.15																
●		59	216	147		118		+1.05																
●		60	218	149		120		+0.95																
									64															

When offset drilling, reduce feed rate to 0.08 mm/rev or less.
See page K72 for Adjustable Sleeve (SHE).

Recommended cutting conditions K70
Trouble shooting K67

Hole Dia. Tolerance (2D type)

DC	Hole Dia. Tolerance (mm)
ø12 - ø60	+0.30 0

* Above is numeric guideline.
It may vary depending on machines / workpieces / clamping status / cutting conditions.



DRV (Drilling depth : 3 x DC)

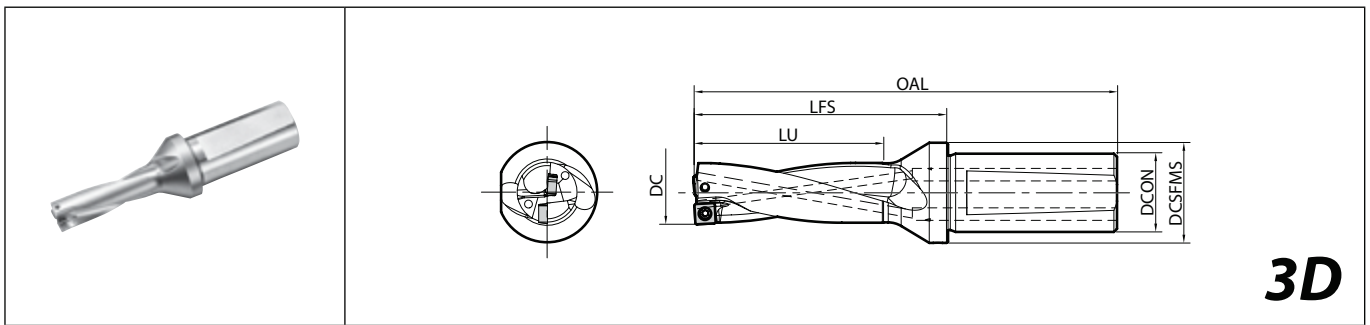

Toolholder dimensions

Description	Availability	No. of inserts	Dimension (mm)					Coolant hole	Radial offset max.	Spare parts				Applicable inserts K52~K55	
			DC	DCON	OAL	LFS	LU			DCSFMS	Screw	Wrench	Wrench		Wrench
S20- DRV120M-3-03 DRV125M-3-03 DRV130M-3-03 DRV135M-3-03	●	2	12	20	94	51	36	27	Yes	+0.25	SB-2037TRP	-	FTP-6	-	LCMT030203-□-E (Outer) LCMT030205-□-I (Inner)
	●		12.5		96	53	37.5			+0.2					
	●		13		97	54	39			+0.15					
	●		13.5		99	56	40.5			+0.1					
S20- DRV140M-3-04 DRV145M-3-04 DRV150M-3-04 DRV155M-3-04	●	2	14	20	106	63	42	27	Yes	+0.4	SB-2037TRP	-	FTP-6	-	SCMT040205-□-E (Outer) SCMT040209-□-I (Inner)
	●		14.5		108	65	43.5			+0.35					
	●		15		109	66	45			+0.3					
	●		15.5		111	68	46.5			+0.25					
S25- DRV160M-3-05 DRV165M-3-05 DRV170M-3-05 DRV175M-3-05 DRV180M-3-05 DRV185M-3-05	●	2	16	25	126	72	48	32	Yes	+0.4	SB-2041TRP	-	FTP-6	-	SCMT050205-□-E (Outer) SCMT050210-□-I (Inner)
	●		16.5		127	73	49.5			+0.35					
	●		17		129	75	51			+0.3					
	●		17.5		130	76	52.5			+0.25					
	●		18		132	78	54			+0.2					
	●		18.5		133	79	55.5			+0.15					
S25- DRV190M-3-06 DRV195M-3-06 DRV200M-3-06 DRV205M-3-06 DRV210M-3-06 DRV215M-3-06 DRV220M-3-06	●	2	19	25	132	78	57	32	Yes	+0.65	SB-2555TRP	DTPM-8	-	-	SCMT060205-□-E (Outer) SCMT060210-□-I (Inner)
	●		19.5		134	80	58.5			+0.6					
	●		20		135	81	60			+0.55					
	●		20.5		137	83	61.5			+0.5					
	●		21		138	84	63			+0.45					
	●		21.5		140	86	64.5			+0.35					
	●		22		141	87	66			+0.3					
S25- DRV225M-3-07 DRV230M-3-07 DRV235M-3-07 DRV240M-3-07 DRV245M-3-07 DRV250M-3-07 DRV255M-3-07 DRV260M-3-07	●	2	22.5	25	142	88	67.5	32	Yes	+0.9	SB-3060TRP	DTPM-10	-	-	SCMT070305-□-E (Outer) SCMT070310-□-I (Inner)
	●		23		144	90	69			+0.8					
	●		23.5		145	91	70.5			+0.75					
	●		24		147	93	72			+0.7					
	●		24.5		148	94	73.5			+0.65					
	●		25		150	96	75			+0.6					
	●		25.5		151	97	76.5			+0.5					
	●		26		153	99	78			+0.45					





When offset drilling, reduce feed rate to 0.08 mm/rev or less.
See page K72 for Adjustable Sleeve (SHE).

Recommended cutting conditions **K70**
Trouble shooting **K67**

● : Standard item R : Right-hand only L : Left-hand only □ : Check availability

Toolholder dimensions

3xDC

Description	Availability	No. of inserts	Dimension (mm)						Coolant hole	Radial offset max.	Spare parts				Applicable inserts K53, K55
			DC	DCON	OAL	LFS	LU	DCSFMS			Screw	Wrench	Wrench	Wrench	
															
S32- DRV265M-3-09 DRV270M-3-09 DRV275M-3-09 DRV280M-3-09 DRV285M-3-09 DRV290M-3-09 DRV295M-3-09 DRV300M-3-09 DRV305M-3-09 DRV310M-3-09 DRV315M-3-09 DRV320M-3-09	●	2	26.5	32	161	102	79.5	41	Yes	+1.15	SB-3573TRP	DTPM-10	-	-	SCMT090405-□-E (Outer) SCMT090410-□-I (Inner)
	●		27		163	104	81			+1.05					
	●		27.5		164	105	82.5			+1					
	●		28		166	107	84			+0.95					
	●		28.5		167	108	85.5			+0.9					
	●		29		169	110	87			+0.85					
	●		29.5		170	111	88.5			+0.8					
	●		30		172	113	90			+0.75					
	●		30.5		173	114	91.5			+0.65					
	●		31		175	116	93			+0.6					
	●		31.5		176	117	94.5			+0.55					
	●		32		178	119	96			+0.5					
S40- DRV330M-3-11 DRV340M-3-11 DRV350M-3-11 DRV360M-3-11 DRV370M-3-11 DRV380M-3-11 DRV390M-3-11	●	2	33	40	194	125	99	49	Yes	+1.25	SB-4086TRP	DTPM-15	-	-	SCMT110406-□-E (Outer) SCMT110410-□-I (Inner)
	●		34		197	128	102			+1.15					
	●		35		200	131	105			+1					
	●		36		203	134	108			+0.9					
	●		37		206	137	111			+0.8					
	●		38		209	140	114			+0.65					
	●		39		212	143	117			+0.55					
S40- DRV400M-3-14 DRV410M-3-14 DRV420M-3-14 DRV430M-3-14 DRV440M-3-14 DRV450M-3-14 DRV460M-3-14 DRV470M-3-14 DRV480M-3-14 DRV490M-3-14	●	2	40	40	221	152	120	49	Yes	+1.75	SB-50120TRPH	-	-	TTP-20	SCMT140508-□-E (Outer) SCMT140510-□-I (Inner)
	●		41		224	155	123			+1.6					
	●		42		227	158	126			+1.5					
	●		43		230	161	129			+1.4					
	●		44		233	164	132			+1.3					
	●		45		236	167	135			+1.15					
	●		46		239	170	138	+1.05							
	●		47		242	173	141	+0.95							
	●		48		245	176	144	+0.8							
	●		49		248	179	147	+0.7							
	●									54					
S40- DRV500M-3-17 DRV510M-3-17 DRV520M-3-17 DRV530M-3-17 DRV540M-3-17 DRV550M-3-17 DRV560M-3-17 DRV570M-3-17 DRV580M-3-17 DRV590M-3-17 DRV600M-3-17	●	2	50	40	248	179	150	59	Yes	+2.1	SB-60130TRP	-	-	TTP-20	SCMT170608-□-E (Outer) SCMT170610-□-I (Inner)
	●		51		251	182	153			+1.95					
	●		52		254	185	156			+1.85					
	●		53		257	188	159			+1.75					
	●		54		260	191	162			+1.65					
	●		55		263	194	165			+1.5					
	●		56		266	197	168	+1.4							
	●		57		269	200	171	+1.3							
	●		58		272	203	174	+1.15							
	●		59		275	206	177	+1.05							
	●		60		278	209	180	+0.95							
	●									64					

When offset drilling, reduce feed rate to 0.08 mm/rev or less.
See page K72 for Adjustable Sleeve (SHE).

Recommended cutting conditions K70
Trouble shooting K67

Hole Dia. Tolerance (3D type)

DC	Hole Dia. Tolerance (mm)
ø12 - ø60	+0.30 0

* Above is numeric guideline.
It may vary depending on machines / workpieces / clamping status / cutting conditions.

● : Standard item R : Right-hand only L : Left-hand only □ : Check availability



DRV (Drilling depth : 4 x DC)

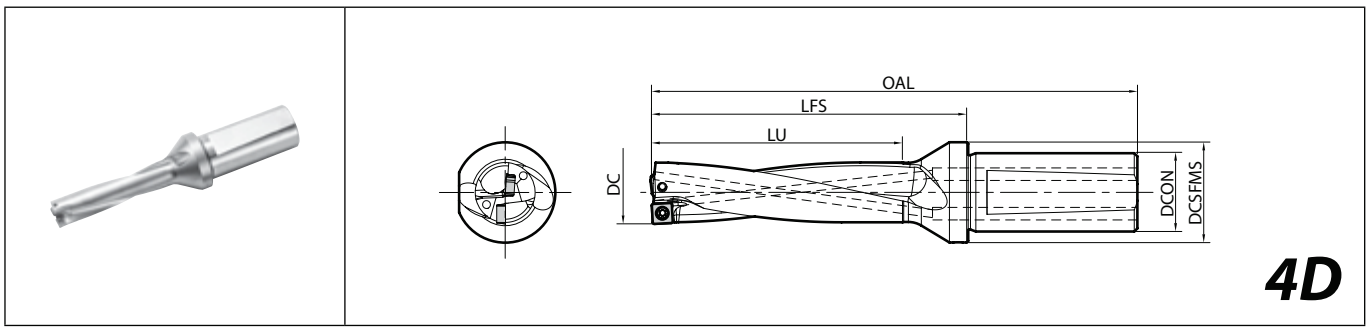

Toolholder dimensions

Description	Availability	No. of inserts	Dimension (mm)					Coolant hole	Radial offset max.	Spare parts				Applicable inserts K52~K55	
			DC	DCON	OAL	LFS	LU			DCSFMS	Screw	Wrench	Wrench		Wrench
S20- DRV120M-4-03 DRV125M-4-03 DRV130M-4-03 DRV135M-4-03	●	2	12	20	106	63	48	27	Yes	+0.25	SB-2037TRP	-	FTP-6	-	LCMT030203-□-E (Outer) LCMT030205-□-I (Inner)
	●		12.5		108	65	50			+0.2					
	●		13		110	67	52			+0.15					
	●		13.5		112	69	54			+0.1					
S20- DRV140M-4-04 DRV145M-4-04 DRV150M-4-04 DRV155M-4-04	●	2	14	20	120	77	56	27	Yes	+0.4	SB-2037TRP	-	FTP-6	-	SCMT040205-□-E (Outer) SCMT040209-□-I (Inner)
	●		14.5		122	79	58			+0.35					
	●		15		124	81	60			+0.3					
	●		15.5		126	83	62			+0.25					
S25- DRV160M-4-05 DRV165M-4-05 DRV170M-4-05 DRV175M-4-05 DRV180M-4-05 DRV185M-4-05	●	2	16	25	142	88	64	32	Yes	+0.4	SB-2041TRP	-	FTP-6	-	SCMT050205-□-E (Outer) SCMT050210-□-I (Inner)
	●		16.5		144	90	66			+0.35					
	●		17		146	92	68			+0.3					
	●		17.5		148	94	70			+0.25					
	●		18		150	96	72			+0.2					
	●		18.5		152	98	74			+0.15					
S25- DRV190M-4-06 DRV195M-4-06 DRV200M-4-06 DRV205M-4-06 DRV210M-4-06 DRV215M-4-06 DRV220M-4-06	●	2	19	25	151	97	76	32	Yes	+0.65	SB-2555TRP	DTPM-8	-	-	SCMT060205-□-E (Outer) SCMT060210-□-I (Inner)
	●		19.5		153	99	78			+0.6					
	●		20		155	101	80			+0.55					
	●		20.5		157	103	82			+0.5					
	●		21		159	105	84			+0.45					
	●		21.5		161	107	86			+0.35					
	●		22		163	109	88			+0.3					
	●		22.5		165	111	90			+0.9					
S25- DRV225M-4-07 DRV230M-4-07 DRV235M-4-07 DRV240M-4-07 DRV245M-4-07 DRV250M-4-07 DRV255M-4-07 DRV260M-4-07	●	2	22.5	25	165	111	90	32	Yes	+0.9	SB-3060TRP	DTPM-10	-	-	SCMT070305-□-E (Outer) SCMT070310-□-I (Inner)
	●		23		167	113	92			+0.8					
	●		23.5		169	115	94			+0.75					
	●		24		171	117	96			+0.7					
	●		24.5		173	119	98			+0.65					
	●		25		175	121	100			+0.6					
	●		25.5		177	123	102			+0.5					
	●		26		179	125	104			+0.45					
S32- DRV270M-4-09 DRV280M-4-09 DRV290M-4-09 DRV300M-4-09 DRV310M-4-09 DRV320M-4-09	●	2	27	32	190	131	108	41	Yes	+1.05	SB-3573TRP	DTPM-10	-	-	SCMT090405-□-E (Outer) SCMT090410-□-I (Inner)
	●		28		194	135	112			+0.95					
	●		29		198	139	116			+0.85					
	●		30		202	143	120			+0.75					
	●		31		206	147	124			+0.6					
	●		32		210	151	128			+0.5					

When offset drilling, reduce feed rate to 0.06 mm/rev or less.
See page K72 for Adjustable Sleeve (SHE).

Recommended cutting conditions K70
Trouble shooting K67





● : Standard item R : Right-hand only L : Left-hand only □ : Check availability



- DRA
- DRC
- DRV
- DRZ
- DRXR
- DRW

Toolholder dimensions

4xDC

Description	Availability	No. of inserts	Dimension (mm)						Coolant hole	Radial offset max.	Spare parts				Applicable inserts K53, K55
			DC	DCON	OAL	LFS	LU	DCSFMS			Screw	Wrench	Wrench	Wrench	
															
S40- DRV330M-4-11	●	2	33	40	227	158	132	49	Yes	+1.25	SB-4086TRP	DTPM-15	-	-	SCMT110406-□-E (Outer) SCMT110410-□-I (Inner)
DRV340M-4-11	●		34		231	162	136		+1.15						
DRV350M-4-11	●		35		235	166	140		+1						
DRV360M-4-11	●		36		239	170	144		+0.9						
DRV370M-4-11	●		37		243	174	148		+0.8						
DRV380M-4-11	●		38		247	178	152		+0.65						
DRV390M-4-11	●		39		251	182	156		+0.55						
S40- DRV400M-4-14	●	2	40	40	261	192	160	49	Yes	+1.75	SB-50120TRPH	-	-	TTP-20	SCMT140508-□-E (Outer) SCMT140510-□-I (Inner)
DRV410M-4-14	●		41		265	196	164			+1.6					
DRV420M-4-14	●		42		269	200	168			+1.5					
DRV430M-4-14	●		43		273	204	172			+1.4					
DRV440M-4-14	●		44		277	208	176			+1.3					
DRV450M-4-14	●		45		281	212	180			+1.15					
DRV460M-4-14	●		46		285	216	184			+1.05					
S50- DRV480M-4-14	●	2	48	50	293	224	192	59	Yes	+0.8	SB-60130TRP	-	-	TTP-20	SCMT170608-□-E (Outer) SCMT170610-□-I (Inner)
DRV490M-4-14	●		49		297	228	196			+0.7					
S50- DRV500M-4-17	●	2	50	50	298	229	200	59	Yes	+2.1	SB-60130TRP	-	-	TTP-20	SCMT170608-□-E (Outer) SCMT170610-□-I (Inner)
DRV510M-4-17	●		51		302	233	204			+1.95					
DRV520M-4-17	●		52		306	237	208			+1.85					
DRV530M-4-17	●		53		310	241	212			+1.75					
DRV540M-4-17	●		54		314	245	216			+1.65					
DRV550M-4-17	●		55		318	249	220	+1.5							
DRV560M-4-17	●		56		322	253	224	+1.4							
DRV570M-4-17	●		57		326	257	228	+1.3							
DRV580M-4-17	●		58		330	261	232	+1.15							
DRV590M-4-17	●		59		334	265	236	+1.05							
DRV600M-4-17	●	60	338	269	240	+0.95									

When offset drilling, reduce feed rate to 0.06 mm/rev or less.
See page K72 for Adjustable Sleeve (SHE).

Recommended cutting conditions K70
Trouble shooting K67

Hole Dia. Tolerance (4D type)

DC	Hole Dia. Tolerance (mm)
ø12 - ø39	+0.35 0
ø40 - ø60	+0.40 0

* Above is numeric guideline.
It may vary depending on machines / workpieces / clamping status / cutting conditions.

● : Standard item R : Right-hand only L : Left-hand only □ : Check availability



DRV (Drilling depth : 5 x DC)

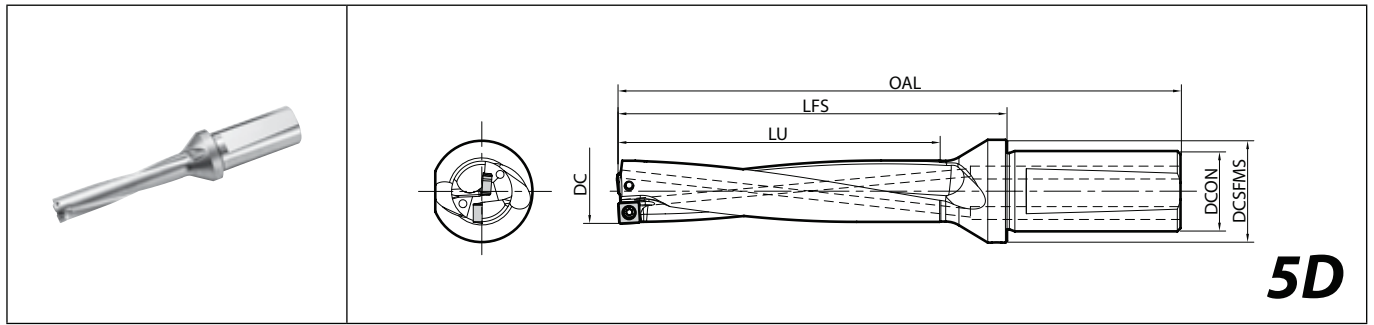

Toolholder dimensions

Description	Availability	No. of inserts	Dimension (mm)						Coolant hole	Radial offset max.	Spare parts				Applicable inserts K52~K55
			DC	DCON	OAL	LFS	LU	DCSFMS			Screw	Wrench	Wrench	Wrench	
S20- DRV120M-5-03 DRV130M-5-03	●	2	12	20	118	75	60	27	Yes	+0.25	SB-2037TRP	-	FTP-6	-	LCMT030203-□-E (Outer) LCMT030205-□-I (Inner)
	●		13		123	80	65			+0.15					
S20- DRV140M-5-04 DRV150M-5-04	●	2	14	20	134	91	70	27	Yes	+0.4	SB-2037TRP	-	FTP-6	-	SCMT040205-□-E (Outer) SCMT040209-□-I (Inner)
	●		15		139	96	75			+0.3					
S25- DRV160M-5-05 DRV170M-5-05 DRV180M-5-05	●	2	16	25	158	104	80	32	Yes	+0.4	SB-2041TRP	-	FTP-6	-	SCMT050205-□-E (Outer) SCMT050210-□-I (Inner)
	●		17		163	109	85			+0.3					
	●		18		168	114	90			+0.2					
S25- DRV190M-5-06 DRV200M-5-06 DRV210M-5-06 DRV220M-5-06	●	2	19	25	170	116	95	32	Yes	+0.65	SB-2555TRP	DTPM-8	-	-	SCMT060205-□-E (Outer) SCMT060210-□-I (Inner)
	●		20		175	121	100			+0.55					
	●		21		180	126	105			+0.45					
	●		22		185	131	110			+0.3					
S25- DRV230M-5-07 DRV240M-5-07 DRV250M-5-07 DRV260M-5-07	●	2	23	25	190	136	115	32	Yes	+0.8	SB-3060TRP	DTPM-10	-	-	SCMT070305-□-E (Outer) SCMT070310-□-I (Inner)
	●		24		195	141	120			+0.7					
	●		25		200	146	125			+0.6					
	●		26		205	151	130			+0.45					
S32- DRV270M-5-09 DRV280M-5-09 DRV290M-5-09 DRV300M-5-09 DRV310M-5-09 DRV320M-5-09	●	2	27	32	217	158	135	41	Yes	+1.05	SB-3573TRP	DTPM-10	-	-	SCMT090405-□-E (Outer) SCMT090410-□-I (Inner)
	●		28		222	163	140			+0.95					
	●		29		227	168	145			+0.85					
	●		30		232	173	150			+0.75					
	●		31		237	178	155			+0.6					
S40- DRV330M-5-11 DRV340M-5-11 DRV350M-5-11 DRV360M-5-11 DRV370M-5-11 DRV380M-5-11 DRV390M-5-11	●	2	33	40	260	191	165	49	Yes	+1.25	SB-4086TRP	DTPM-15	-	-	SCMT110406-□-E (Outer) SCMT110410-□-I (Inner)
	●		34		265	196	170			+1.15					
	●		35		270	201	175			+1					
	●		36		275	206	180			+0.9					
	●		37		280	211	185			+0.8					
	●		38		285	216	190			+0.65					
●	39	290	221	195	+0.55										





When offset drilling, reduce feed rate to 0.05 mm/rev or less.
See page K72 for Adjustable Sleeve (SHE).

Recommended cutting conditions ● K71
Trouble shooting ● K67

● : Standard item R : Right-hand only L : Left-hand only □ : Check availability

Toolholder dimensions

5xDC

Description	Availability	No. of inserts	Dimension (mm)						Coolant hole	Radial offset max.	Spare parts				Applicable inserts K53, K55
			DC	DCON	OAL	LFS	LU	DCSFMS			Screw	Wrench	Wrench	Wrench	
															
S40- DRV400M-5-14	●	2	40	40	301	232	200	Yes	+1.75	SB-50120TRPH	-	-	TTP-20	SCMT140508-□-E (Outer) SCMT140510-□-I (Inner)	
DRV410M-5-14	●		41		306	237	205		+1.6						
DRV420M-5-14	●		42		311	242	210		+1.5						
DRV430M-5-14	●		43		316	247	215		+1.4						
DRV440M-5-14	●		44		321	252	220		+1.3						
DRV450M-5-14	●		45		326	257	225		+1.15						
DRV460M-5-14	●		46		331	262	230		+1.05						
DRV470M-5-14	●		47		336	267	235		+0.95						
S50- DRV480M-5-14	●	2	48	50	341	272	240	Yes	+0.8	SB-60130TRPH	-	-	TTP-20	SCMT170608-□-E (Outer) SCMT170610-□-I (Inner)	
DRV490M-5-14	●		49		346	277	245		+0.7						
S50- DRV500M-5-17	●	2	50	50	348	279	250	Yes	+2.1	SB-60130TRPH	-	-	TTP-20	SCMT170608-□-E (Outer) SCMT170610-□-I (Inner)	
DRV510M-5-17	●		51		353	284	255		+1.95						
DRV520M-5-17	●		52		358	289	260		+1.85						
DRV530M-5-17	●		53		363	294	265		+1.75						
DRV540M-5-17	●		54		368	299	270		+1.65						
DRV550M-5-17	●		55		373	304	275		+1.5						
DRV560M-5-17	●		56		378	309	280		+1.4						
DRV570M-5-17	●		57		383	314	285		+1.3						
DRV580M-5-17	●		58		388	319	290		+1.15						
DRV590M-5-17	●		59		393	324	295		+1.05						
DRV600M-5-17	●		60		398	329	300		+0.95						

When offset drilling, reduce feed rate to 0.05 mm/rev or less.
See page K72 for Adjustable Sleeve (SHE).

Recommended cutting conditions K71
Trouble shooting K67

Hole Dia. Tolerance (5D type)

DC	Hole Dia. Tolerance (mm)
ø12 - ø39	+0.35 0
ø40 - ø60	+0.40 0

* Above is numeric guideline.
It may vary depending on machines / workpieces / damping status / cutting conditions.

● : Standard item R : Right-hand only L : Left-hand only □ : Check availability



DRV (Drilling depth : 6 x DC)

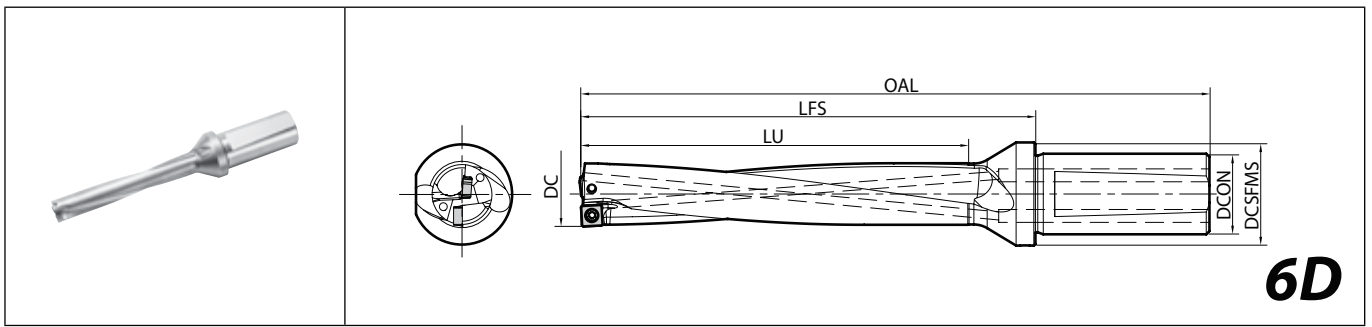

Toolholder dimensions

Description	Availability	No. of inserts	Dimension (mm)						Coolant hole	Radial offset max.	Spare parts				Applicable inserts K52~K55
			DC	DCON	OAL	LFS	LU	DCSFMS			Screw	Wrench	Wrench	Wrench	
S20- DRV120M-6-03 DRV130M-6-03	●	2	12	20	130	87	72	27	Yes	+0.25	SB-2037TRP	-	FTP-6	-	LCMT030203-□-E (Outer) LCMT030205-□-I (Inner)
	●		13		136	93	78			+0.15					
S20- DRV140M-6-04 DRV150M-6-04	●	2	14	20	148	105	84	27	Yes	+0.4	SB-2037TRP	-	FTP-6	-	SCMT040205-□-E (Outer) SCMT040209-□-I (Inner)
	●		15		154	111	90			+0.3					
S25- DRV160M-6-05 DRV170M-6-05 DRV180M-6-05	●	2	16	25	174	120	96	32	Yes	+0.4	SB-2041TRP	-	FTP-6	-	SCMT050205-□-E (Outer) SCMT050210-□-I (Inner)
	●		17		180	126	102			+0.3					
	●		18		186	132	108			+0.2					
S25- DRV190M-6-06 DRV200M-6-06 DRV210M-6-06 DRV220M-6-06	●	2	19	25	189	135	114	32	Yes	+0.65	SB-2555TRP	DTPM-8	-	-	SCMT060205-□-E (Outer) SCMT060210-□-I (Inner)
	●		20		195	141	120			+0.55					
	●		21		201	147	126			+0.45					
	●		22		207	153	132			+0.3					
S25- DRV230M-6-07 DRV240M-6-07 DRV250M-6-07 DRV260M-6-07	●	2	23	25	213	159	138	32	Yes	+0.8	SB-3060TRP	DTPM-10	-	-	SCMT070305-□-E (Outer) SCMT070310-□-I (Inner)
	●		24		219	165	144			+0.7					
	●		25		225	171	150			+0.6					
	●		26		231	177	156			+0.45					
S32- DRV270M-6-09 DRV280M-6-09 DRV290M-6-09 DRV300M-6-09 DRV310M-6-09 DRV320M-6-09	●	2	27	32	244	185	162	41	Yes	+1.05	SB-3573TRP	DTPM-10	-	-	SCMT090405-□-E (Outer) SCMT090410-□-I (Inner)
	●		28		250	191	168			+0.95					
	●		29		256	197	174			+0.85					
	●		30		262	203	180			+0.75					
	●		31		268	209	186			+0.6					
	●		32		274	215	192			+0.5					
S40- DRV330M-6-11 DRV340M-6-11 DRV350M-6-11 DRV360M-6-11 DRV370M-6-11 DRV380M-6-11 DRV390M-6-11	●	2	33	40	293	224	198	49	Yes	+1.25	SB-4086TRP	DTPM-15	-	-	SCMT110406-□-E (Outer) SCMT110410-□-I (Inner)
	●		34		299	230	204			+1.15					
	●		35		305	236	210			+1					
	●		36		311	242	216			+0.9					
	●		37		317	248	222			+0.8					
	●		38		323	254	228			+0.65					
	●		39		329	260	234			+0.55					
S40- DRV400M-6-14 DRV410M-6-14 DRV420M-6-14 DRV430M-6-14 DRV440M-6-14 DRV450M-6-14	●	2	40	40	341	272	240	49	Yes	+1.75	SB-50120TRPH	-	-	TTP-20	SCMT140508-□-E (Outer) SCMT140510-□-I (Inner)
	●		41		347	278	246			+1.6					
	●		42		353	284	252			+1.5					
	●		43		359	290	258			+1.4					
	●		44		365	296	264			+1.3					
	●		45		371	302	270			+1.15					
	●		45		371	302	270			+1.15					
S50- DRV500M-6-17 DRV550M-6-17 DRV600M-6-17	●	2	50	50	398	329	300	59	Yes	+2.1	SB-60130TRP	-	-	TTP-20	SCMT170608-□-E (Outer) SCMT170610-□-I (Inner)
	●		55		428	359	330			+1.5					
	●		60		458	389	360			+0.95					

When offset drilling, reduce feed rate to 0.04 mm/rev or less.
See page K72 for Adjustable Sleeve (SHE).

Recommended cutting conditions K71
Trouble shooting K67

● : Standard item R : Right-hand only L : Left-hand only □ : Check availability



- DRA
- DRC
- DRV
- DRZ
- DRXR
- DRW

Hole Dia. Tolerance (6D type)

DC	Hole Dia. Tolerance (mm)
ø12 - ø39	+0.45 0
ø40 - ø60	+0.50 0

* Above is numeric guideline.
It may vary depending on machines / workpieces / clamping status / cutting conditions.

K



Drilling

Insert grade selection guide

Select CVD for the outer edge when performing high speed and high efficiency drilling. Drilling for high efficiency, abrasion resistance and long tool life. Select PVD for the outer edge for stable drilling and a better surface finish. PVD is recommended for the outer edge when chattering occurs or drilling with lathe is not available, even if cutting conditions are increased.

High speed and high efficiency drilling

Outer edge: CVD (CA520D/CA415D)



Inner edge: PVD (PR1535).

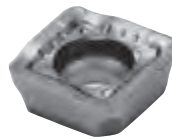

Stable machining oriented (1st recommendation for lathe machining)

Outer edge: PVD (PR1225).



Inner edge: PVD (PR1535).

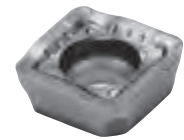

Caution

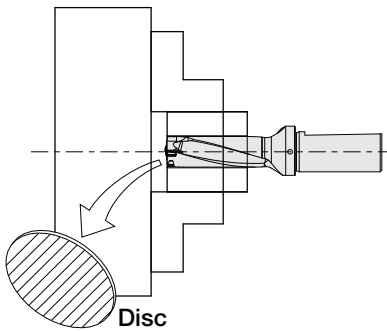

When drilling through the workpiece, a disk may be ejected. Proper machine guarding is necessary to prevent injury.

K



Drilling

DRV hole bottom shape (mm)

Insert size	DC	A	Insert size	DC	A	Insert size	DC	A	Insert size	DC	A		
03	12.0	0.70	06	19.0	1.2	09	26.5	1.2	14	40.0	1.9		
	12.5			19.5			27.0			41.0			
	13.0			20.0			27.5			42.0			
	04			13.5	1.0		20.5	1.3		28.0	1.3	43.0	2.0
14.0		21.0		28.5			45.0						
14.5		21.5		29.0			46.0			2.1			
15.0		22.0	29.5	47.0									
05	15.5	1.1	07	22.5	1.2	11	30.0	1.4		48.0	2.2		
	16.0			23.0			30.5			49.0			
	16.5			23.5			31.0			50.0	2.0		
	05			17.0	1.1		24.0	1.2		31.5		1.5	51.0
				17.5			24.5			32.0	52.0		
				18.0			25.0		33.0	53.0	2.1		
18.5		25.5	34.0	54.0									
05	1.2	07	26.0	1.3	35.0	1.5	55.0	2.2					
			05		36.0		36.0		56.0				
					37.0		37.0	57.0	2.3				
					38.0		38.0	58.0					
					39.0		39.0	59.0	2.4				
			60.0		60.0		60.0						

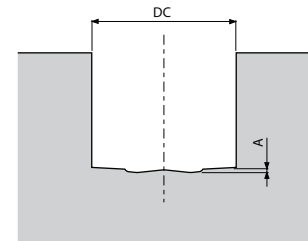

Common for 2D, 3D, 4D, 5D, 6D type

* Above is numeric guideline. (Varies within ±0.1mm depending on workpiece materials and cutting conditions)

Trouble shooting (DRV / DRZ / DRX)

Trouble condition	Condition	Cause	Countermeasures
Hole diameter becomes smaller (At hole bottom)	<p>A (Inlet side) B (Bottom side)</p> <p>There is no problem for inlet, however gradually hole diameter is getting smaller at the bottom.</p> <p>$A > B$</p>	Chip jam (External or internal edge chip stuck)	Change the cutting conditions <ul style="list-style-type: none"> · Increase the cutting speed · Lower the feed rate Ⓛ K70, K71, K87, K99
Hole diameter becomes larger (At hole bottom)	<p>A (Inlet side) B' (Bottom side)</p> <p>There is no problem for inlet, however gradually hole diameter is getting larger at the bottom.</p> <p>$A < B'$</p>	Internal edge chip jam.	Change the cutting conditions <ul style="list-style-type: none"> · Increase the cutting speed · Lower the feed rate Ⓛ K70, K71, K87, K99 Check the core height <ul style="list-style-type: none"> Ⓛ K74, K75 Ⓛ K88, K89
Hole diameter is small (From the hole inlet)		Hole diameter is small from inlet. (At turning moment)	Inappropriate adjustment of hole diameter. <ul style="list-style-type: none"> Ⓛ K74 Ⓛ K88
		No core at internal edge. (No core remains)	Adjust the center height. <ul style="list-style-type: none"> Ⓛ K74, K75 Ⓛ K88, K89



Indication of tool life of MagicDrill (DRV/ DRZ/ DRX)

How to judge tool life	Indication of judging tool life
Judgement of tool condition and insert wear	<ul style="list-style-type: none"> · When an insert is new, the toolholder is slightly bent to the side during drilling (therefore, the drill diameter is slightly bigger during drilling). Once drilling is finished, the toolholder will return back to normal size. No tool marks will appear on the finished surface (This depends on workpiece and cutting condition. Slight tool mark might appear if cutting force on external dia. is too low.) · When an insert is at the end of its tool life, gradually the external corner part gets worn out. Also the toolholder does not bend slightly outwards, and it starts to bend inwards. After the drilling is finished, the toolholder returns to the normal position. When taking off a toolholder under this condition, the cutting edge of the insert creates external tool marks on the finished surface of the workpiece.
Checking hole diameter	When hole diameter is measured, suddenly it shows small diameter. In this case, a worn out insert can be the cause and it must be exchange.
Checking the surface on the outlet side	If insert wear progresses, the burrs of penetrated hole entrance becomes bigger. This is a clear indication that the tool must be exchanged.
Variation of drilling noise	Light drilling noise at the beginning turns to brady noise which contains vibration noise.
Variation of vibration	As the end of tool life is getting closer, there is more vibration and the drilling noise changes. However, when drilling smaller diameters these factors are difficult to detect.

Chamfering attachment

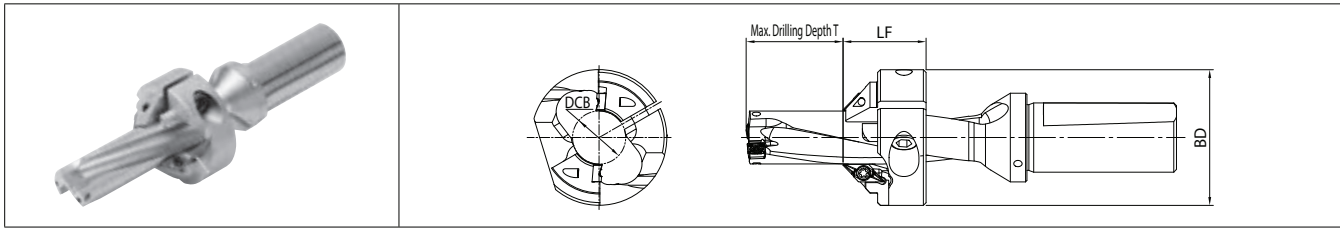

Dimensions

Description	Availability	Applicable drills	Dimension (mm)			Applicable inserts	Spare parts								
			BD	DCB	LF		Clamp Screw	Wrench	Clamp bolt	Wrench					
DRV-CH17	●	S25-DRV165M-○-05 S25-DRV170M-○-05	47	16.2	30	CH0503-45	SB-3080TR	FT-10	HH6X18	LW-5					
DRV-CH18	●	S25-DRV175M-○-05 S25-DRV180M-○-05	47	17.2	30										
DRV-CH19	●	S25-DRV185M-○-05 S25-DRV190M-○-06	49	18.2	30										
DRV-CH20	●	S25-DRV195M-○-06 S25-DRV200M-○-06	49	19.2	30										
DRV-CH21	●	S25-DRV205M-○-06 S25-DRV210M-○-06	49	20.2	30										
DRV-CH22	●	S25-DRV215M-○-06 S25-DRV220M-○-06	49	21.2	30										
DRV-CH23	●	S25-DRV225M-○-07 S25-DRV230M-○-07	51	22.2	30										
DRV-CH24	●	S25-DRV235M-○-07 S25-DRV240M-○-07	51	23.2	30										
DRV-CH25	●	S25-DRV245M-○-07 S25-DRV250M-○-07	53	24.2	30										
DRV-CH26	●	S25-DRV255M-○-07 S25-DRV260M-○-07	53	25.2	30										
DRV-CH27	●	S32-DRV265M-○-09 S32-DRV270M-○-09	64	26	35									HH8X20	LW-6

K



Drilling

Max. drilling depth and chamfering dimension

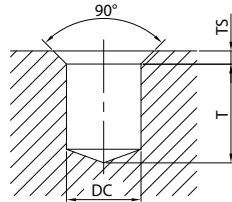

Drill dia. (mm)	Max. drilling depth T (mm)						Max. chamfering dimension (mm)	Applicable chamfering attachment
	DC	2D drill	3D drill	4D drill	5D drill	6D drill		
ø16.5		0.5	17	33.5	-	-	2.5	DRV-CH17
ø17		1.5	18.5	35.5	52.5	69.5		DRV-CH18
ø17.5		2.5	20	37.5	-	-		DRV-CH19
ø18		3.5	21.5	39.5	57.5	75.5		DRV-CH20
ø18.5		4.5	23	41.5	-	-		DRV-CH21
ø19		5.5	24.5	43.5	62.5	81.5		DRV-CH22
ø19.5		6.5	26	45.5	-	-		DRV-CH23
ø20		7.5	27.5	47.5	67.5	87.5		DRV-CH24
ø20.5		8.5	29	49.5	-	-		DRV-CH25
ø21		9.5	30.5	51.5	72.5	93.5		DRV-CH26
ø21.5		10.5	32	53.5	-	-		DRV-CH27
ø22		11.5	33.5	55.5	77.5	99.5		
ø22.5		12.5	35	57.5	-	-		
ø23		13.5	36.5	59.5	82.5	105.5		
ø23.5		14.5	38	61.5	-	-		
ø24		15.5	39.5	63.5	87.5	111.5		
ø24.5		16.5	41	65.5	-	-		
ø25		17.5	42.5	67.5	92.5	117.5		
ø25.5		18.5	44	69.5	-	-		
ø26		19.5	45.5	71.5	97.5	123.5		
ø26.5		-	47	-	-	-		
ø27		16.5	43.5	75.5	97.5	124.5		

● : Standard item R : Right-hand only L : Left-hand only □ : Check availability

Applicable insert

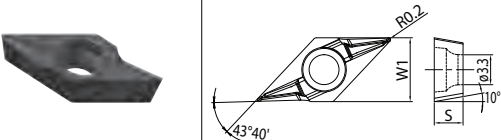
Insert	Description	Dimension (mm)		MEGACOAT NANO	Applicable chamfering attachment
		W1	S	PR1535	
	CH0503-45	7.05	3.18	●	DRV-CH○○

How to install chamfering attachment

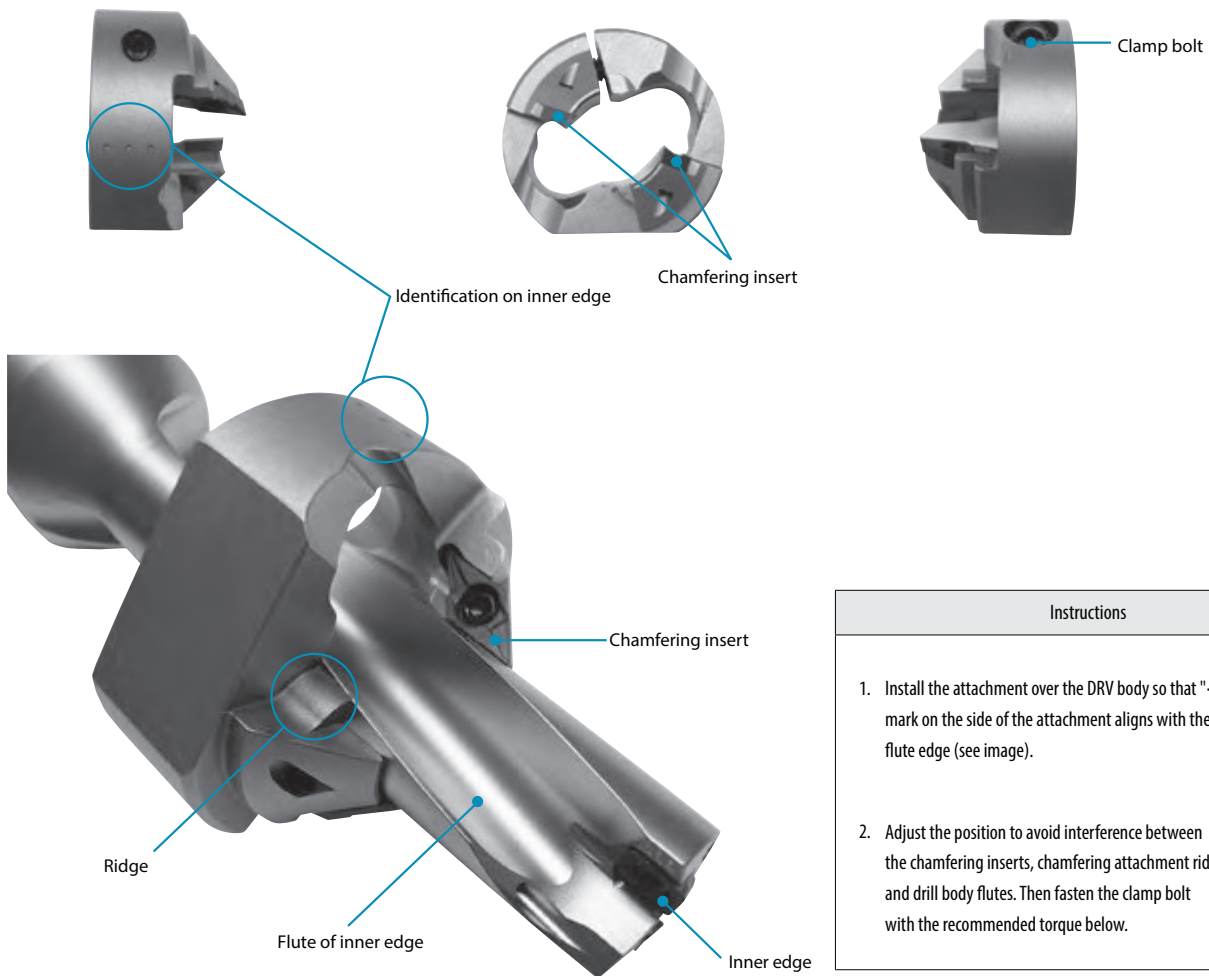

Instructions

1. Install the attachment over the DRV body so that "K" mark on the side of the attachment aligns with the inside flute edge (see image).
2. Adjust the position to avoid interference between the chamfering inserts, chamfering attachment ridges, and drill body flutes. Then fasten the clamp bolt with the recommended torque below.

Recommended tightening torque

Description	Tightening torque (N m)	Clamp bolt	Wrench
DRV-CH17~CH26	10	HH6X18	LW-5
DRV-CH27	14	HH8X20	LW-6

● : Standard item R : Right-hand only L : Left-hand only □ : Check availability

Recommended cutting conditions DRV 2D-4D (Coolant)

Workpiece material	Recommended insert grades (Vc: m/min)										Drill dia. DC (mm)	Drill type											
	PVD coated carbide					CVD coated carbide						2D~3D				4D							
	PR1225					CA520D						CA415D				f (mm/rev)							
	GM	GH	XM	SM		GM	GH	XM	SM			GM	GH			GM	GH	XM	SM				
Low carbon steel	-	-	★	☆	-	-	-	★	☆	-	-	-	-	-	-	-	-	-					
			120-200	120-200				150-280	150-280														
Carbon steel	★	☆	☆	☆	★	☆	☆	☆	☆	-	-	-	-	-	-	-	-	-					
	100-180	100-180	100-180	100-180	150-280	150-280	150-280	150-280	150-280														
Alloy steel	★	☆	☆	-	★	☆	☆	☆	-	-	-	-	-	-	-	-	-	-					
	100-160	100-160	100-160		140-220	140-220	140-220	140-220															
Mold steel	☆	★	-	-	☆	★	-	-	-	-	-	-	-	-	-	-	-	-					
	80-150	80-150			130-210	130-210																	
Stainless steel (Austenitic related)	-	-	-	★	-	-	-	-	★	-	-	-	-	-	-	-	-	-					
				70-140					140-200														
Gray cast iron	☆	★	-	-	-	-	-	-	-	☆	★	-	-	-	-	-	-	-					
	100-150	100-150								150-220	150-220												
Nodular cast iron	☆	★	-	-	-	-	-	-	-	☆	★	-	-	-	-	-	-	-					
	80-120	80-120								120-180	120-180												

· Internal coolant is recommended

★: 1st recommendation ☆: 2nd recommendation

K



Drilling

- DRA
- DRC
- DRV
- DRZ
- DRXR
- DRW

Recommended cutting conditions DRV 5D-6D (Coolant)

Workpiece material	Recommended insert grades (Vc: m/min)										Drill dia. DC (mm)	Drill type												
	PVD coated carbide					CVD coated carbide						5D				6D								
	PR1225					CA520D						CA415D					f (mm/rev)							
	GM	GH	XM	SM		GM	GH	XM	SM			GM	GH			GM	GH	XM	SM					
Low carbon steel	-	-	★	☆	-	-	-	★	☆	-	-	-	-	-	-	-	-	-						
			120-200	120-200				150-280	150-280															
Carbon steel	★	☆	☆	☆	★	☆	☆	☆	☆	-	-	-	-	-	-	-	-	-						
	100-180	100-180	100-180	100-180	150-280	150-280	150-280	150-280	150-280															
Alloy steel	★	☆	☆	-	★	☆	☆	☆	-	-	-	-	-	-	-	-	-	-						
	100-160	100-160	100-160		140-220	140-220	140-220	140-220																
Mold steel	☆	★	-	-	☆	★	-	-	-	-	-	-	-	-	-	-	-	-						
	80-150	80-150			130-210	130-210																		
Stainless steel (Austenitic related)	-	-	-	★	-	-	-	-	★	-	-	-	-	-	-	-	-	-						
				70-140					140-200															
Gray cast iron	☆	★	-	-	-	-	-	-	-	☆	★	-	-	-	-	-	-	-						
	100-150	100-150								150-220	150-220													
Nodular cast iron	☆	★	-	-	-	-	-	-	-	☆	★	-	-	-	-	-	-	-						
	80-120	80-120								120-180	120-180													

Internal coolant is recommended

★: 1st recommendation ☆: 2nd recommendation



Cutting conditions by application

Applications	Plain surface	Slant surface	Half cylindrical	Hole expansion	Cored hole	Concave surface	Stacked plates	
Shape of workpiece								
Vc (m/min)	See above	120 (PVD insert is recommended for outer edge)						Not available
f (mm/rev)	See above	Half of the above recommended conditions is recommended.				Concave surface: Use half of the above recommended conditions.	Not available	
					Continuous part: See above.			
Coolant (Internal coolant)	Yes							Not available

SHE

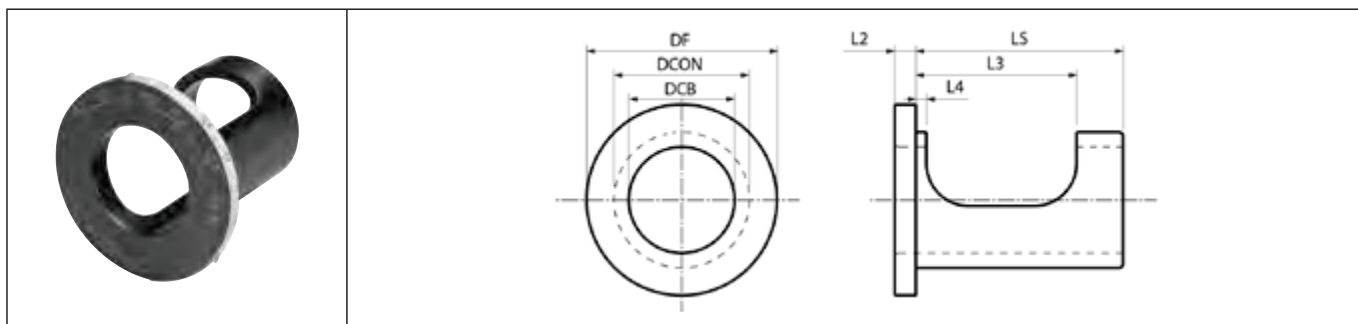

Toolholder dimensions

Description	Availability	Dimension (mm)								* Drill Dia. Adjustable Range	Center Height Adjustable Range
		DCB	DCON	DF	L2	L3	L4	LS			
SHE 2025-43	●	20	25	41	4	36	3	43	+0.4~-0.2	+0.2~-0.15	
2532-48	●	25	32	49	6	38	2.5	48	+0.4~-0.2	+0.2~-0.15	
3240-53	●	32	40	58		43		53	+0.4~-0.2	+0.2~-0.15	
4050-63	●	40	50	74	49	3	63	+0.6~-0.2	+0.3~-0.2		

Diameter Adjustment Range adjusts the drill diameter.

K



Drilling

DRA

DRC

DRV

DRZ

DRXR

DRW

● : Standard item R : Right-hand only L : Left-hand only □ : Check availability

1. Diameter adjustment ~For machining center~

● Diameter adjustment range (mm)

Shank dia.	Adjustment range
φ20	+0.4~-0.2
φ25	
φ32	
φ40	+0.6~-0.2

2. Center height adjustment ~Fewer problems owing to height adjustment for lathes~

● Center height adjustment Range (mm)

Shank dia.	Adjustment range
φ20	+0.2~-0.15
φ25	
φ32	
φ40	+0.3~-0.2

How to use the adjustable sleeve

1. Hole diameter adjustment when drilling

1. Adjust the scale at the flange periphery of the sleeve to the reference mark (DRV/DRX) or the center of coolant plug (DRZ). (Fig. 1)
2. When making the hole diameter larger, rotate the sleeve in (+) direction and to make it smaller, rotate the sleeve in (-) direction.
3. When rotating the sleeve, insert the wrench supplied with the drill into the hole on the flange periphery to rotate the sleeve.
4. Using the bottom screw of the side-lock arbor, firmly tighten on the drill directly through the sleeve's window.

The upper screw should be tightened slightly so that the sleeve will not be damaged.

Caution:

- Not applicable for collet chuck type arbor.
 - Scale on the sleeve is the reference value.
- Check the actual hole diameter after adjusting.

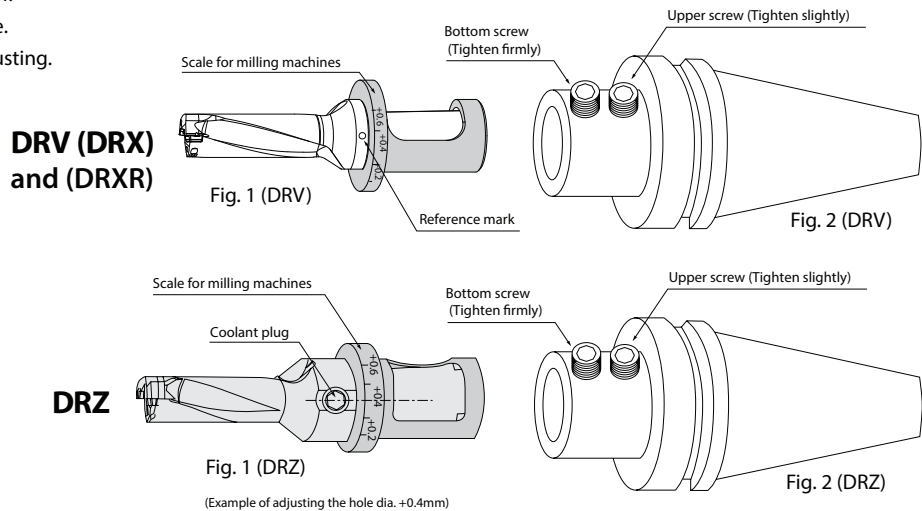

2. Center-height adjustment for lathes

Most lathe problem occur due to center height deviation. The center height is appropriate if a core approximately 0.5mm diameter remains at the center of the end face. (Fig. 3) Center-height adjustment is necessary for the case as follows:

- ◆ No core remains or ◆ core diameter is more than 1mm

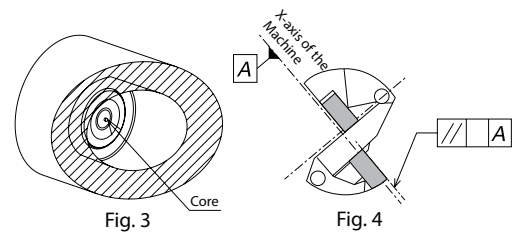

1. Align the drill with the outer insert face parallel to the x-axis of the tool turret. (Fig. 4)
2. Adjust the scale at the flange periphery of the sleeve to the reference mark (DRV/DRX) or the center of coolant plug (DRZ).
3. When no core remains, rotate the sleeve to (+) direction to make the core larger, and when the core diameter is 1mm or more, rotate the sleeve to (-) direction to make the core smaller.
4. When rotating the sleeve, insert the wrench supplied with the drill into the hole on the flange periphery to rotate the sleeve.
5. After completing the adjustment, firmly tighten on the drill directly through the sleeve's window.

Note: depending on amount of the center height adjustment, the hole diameter may change. It is recommended that the hole diameter is checked after the center height adjustment.

Lathe installation

1. The top face of the outer insert should be parallel to the X-axis to allow for offset cutting. (Drill diameter can be changed by moving X-axis.)
2. It is recommended to set the outer insert as shown in Fig. 1 with the outer insert facing the operator. (Fig. 1)
(It is also possible to use it by setting it in 180° reverse position)
If the lathe has two turrets, when installing the drill into the lower turret, the outer insert should be set to face the operator.
(It is also possible to use it by setting at 180° reverse position)

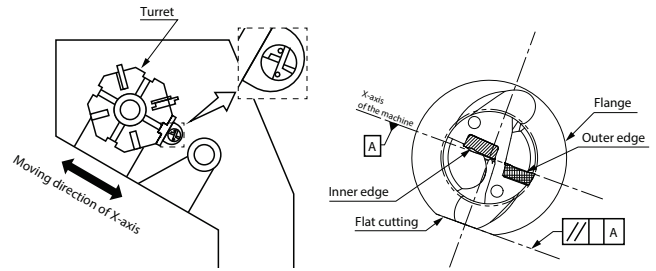

Fig. 1 Installed into the lathe

Drill diameter adjustment

1. Drill diameter adjustment

1. Drill diameter is adjusted by moving X-axis.
The moving direction of the X-axis depends on the position of the toolholder.
2. In case of making the hole diameter larger, slide the tool along the X-axis toward the outer insert side. (Fig. 2, Fig. 3)
For making the hole diameter smaller, slide the tool along the X-axis in the opposite direction.
(This movement of the axis is called "Offset")
However, be sure not to make the hole diameter smaller than the drill diameter by 0.2mm or more. Otherwise, the toolholder will interfere with the drilled hole. (Fig. 4)
e.g.) In case of using $\varnothing 20$ drill, the hole diameter must not be smaller than 19.8mm.

2. Offset Limit of the Drill Diameter

For the maximum limit of the drill diameter, refer to "Max. Offset (Radial)" in the toolholder dimensions table.
(The figure in the table shows how much it is possible the offset the drill in the radial direction.)
When using $\varnothing 20$ drill, for example, it is possible to make a hole up to $\varnothing 21.1$ since "Max. offset (Radial)" is +0.55mm.

K

Drilling

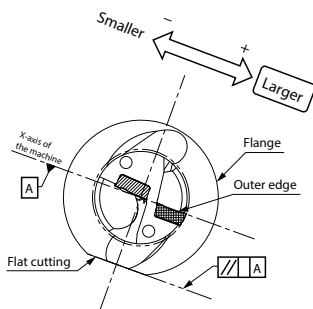

Fig. 2 Outer insert facing up

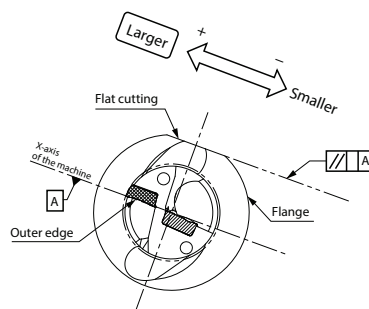

Fig. 3 Outer insert facing down

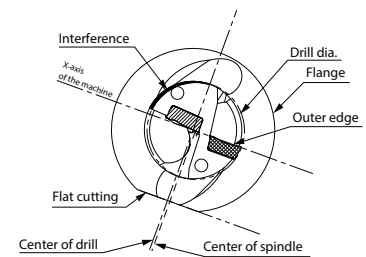

Fig. 4 Excessive offset (For smaller hole diameter)

Center height adjustment

1. Center Height of the Inner Insert

When installing inner insert as shown in Fig. 1, it will be set around 0.05mm below the center of spindle. (Fig. 5)
This is the normal position of the center height and the drill is designed to be handled in this condition.
However, in case that the turret of the lathe is out of the center of spindle, sometimes the inner insert may be set above the center, or excessively below the center.
For stable drilling, it is essential to check the center height carefully.

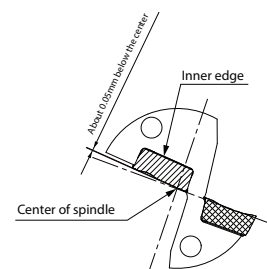

Fig. 5 Front view of the drill

2. How to Check the Center Height

For checking the center height of the inner insert, see the core which remains at the center of the end face of the drilled hole. (Fig. 6)
If the center height is in the normal position, a core about 0.5mm in diameter, will remain after machining.
Adjustment of center height is required if a large core diameter of 1mm or more remains.
* The drilled hole for verification purposes needs to be machined at approximately 10mm in depth and at a feed rate of 0.1mm/rev or lower.

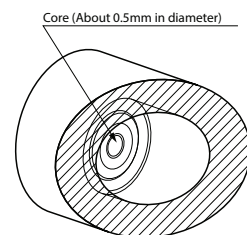

Fig. 6 Center core

3. Center height adjustment

a) When there are no remaining cores and insert breakage near the center of the drill.
This happens when the inner insert is set above the center height. (Fig. 7)

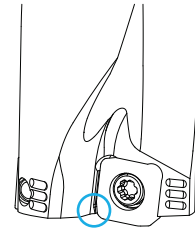

Fig. 7 Insert breakage near the center of the drill

[How to adjust]

1. Install the drill rotated 180°.
Most problems will be solved by this method. (Fig. 8)

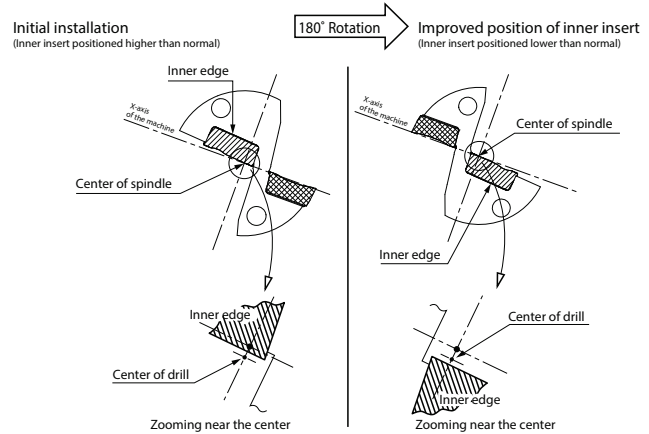

Fig. 8

[How to adjust]

2. If the core diameter becomes too large after the above adjustment, install the drill by rotating 90° counter-clockwise as shown in Fig. 9 (outer insert is positioned lower) and adjust the center height by moving the tool in the X-axis direction. (However, this will make it impossible to adjust the cutting diameter.)
Caution: In case of installing the drill in the reverse direction (outer insert is positioned above), the hole diameter will become smaller, which may cause the drill body to interfere with the drilled hole.
The best solution is to readjust the center position of the turret itself.

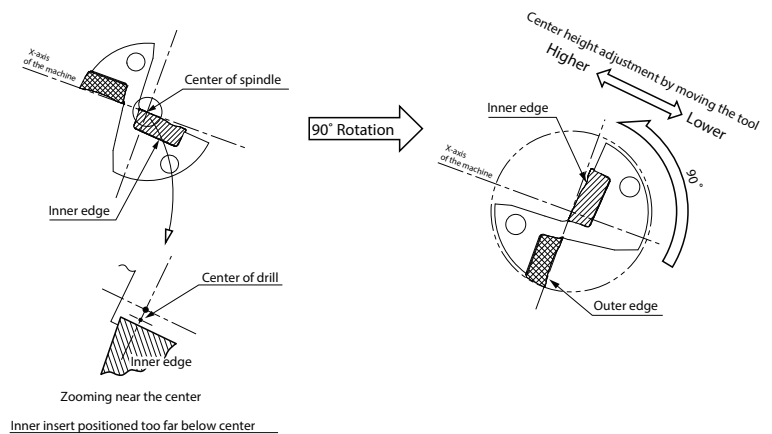

Fig. 9

b) Core with excessively large diameter (More than 1mm)
This occurs when the inner insert is excessively below the center.
This condition causes poor chip evacuation and an adjustment is required.

[How to adjust]

- Install the drill rotating 90° as shown in Fig. 10 (outer insert is positioned on the upper side) and adjust the center height by moving tool in the X-axis direction. (However, this will make it impossible to adjust the cutting diameter.)
Caution: In case of installing the drill in the opposite direction (outer insert is positioned lower), the hole diameter will become smaller, which may cause the drill body to interfere with the drilled hole.
The best solution is to readjust the center position of the turret itself.

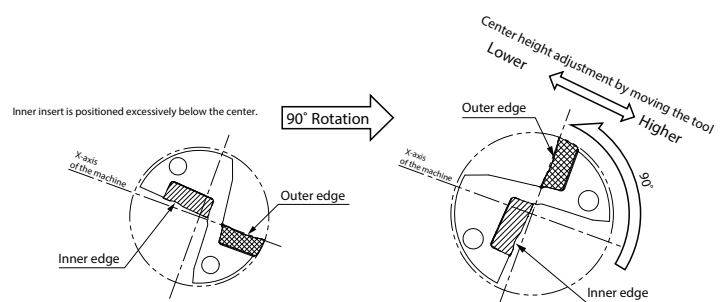





Fig. 10

ZCMT

Insert		Description	Dimension (mm)						Angle (°)	Carbide			Applicable toolholder K78~K85	
			S	D1	RE	INSL	W1	AN		PVD	-			
														PR1210
			Carbon steel / Alloy steel							●	●		P	
			Mold and die steel								●		P	
			Stainless steel							●	○		M	
			Cast iron							●			K	
			Non-ferrous metals									●	N	
 RE INSL WT S D1 AN General purpose	ZCMT 050203	2.38	2.3	0.3	5.9	5	7	●	●	●	●	S..-DRZ....-05		
	ZCMT 06T204	2.8	2.5	0.4	7	6	7	●	●	●	●	S..-DRZ....-06		
	ZCMT 080304	3.18	2.9	0.4	9.7	8.2	7	●	●	●	●	S..-DRZ....-08		
	ZCMT 10T304	3.97	4.4	0.4	12	10.4	7	●	●	●	●	S..-DRZ....-10		
	ZCMT 12T306	3.97	5.6	0.6	14.3	12.8	7	●	●	●	●	S..-DRZ....-12		
	ZCMT 150408	4.76	5.6	0.8	17.8	15.8	7	●	●	●	●	S..-DRZ....-15		
	ZCMT 200608	6.35	6.5	0.8	22.8	20.3	7		●	●	●	S..-DRZ....-20		
 RE INSL WT S D1 AN Deep drilling / Low cutting force	ZCMT 050203SP	2.38	2.3	0.3	5.9	5	7		●	●	●	S..-DRZ....-05		
	ZCMT 06T204SP	2.8	2.5	0.4	7	6	7		●	●	●	S..-DRZ....-06		
	ZCMT 080304SP	3.18	2.9	0.4	9.7	8.2	7		●	●	●	S..-DRZ....-08		
	ZCMT 10T304SP	3.97	4.4	0.4	12	10.4	7		●	●	●	S..-DRZ....-10		
	ZCMT 12T304SP	3.97	5.6	0.4	14.3	12.8	7		●	●	●	S..-DRZ....-12		
	ZCMT 150406SP	4.76	5.6	0.6	17.8	15.8	7		●	●	●	S..-DRZ....-15		
	ZCMT 200608SP	6.35	6.5	0.8	22.8	20.3	7			●	●	S..-DRZ....-20		
 RE INSL WT S D1 AN Stainless steel	ZCMT 050203SU	2.38	2.3	0.3	5.9	5	7		●	●		S..-DRZ....-05		
	ZCMT 06T204SU	2.8	2.5	0.4	7	6	7		●	●		S..-DRZ....-06		

Features of SP Chipbreaker

1. Less cutting force with large rake angle
2. Suitable for chip control of sticky materials such as stainless steel or soft steel.
3. Larger size inserts have smaller corner-R(RE) than standard chipbreaker type and can reduce burrs.

Recommended cutting conditions K87

K



Drilling

- DRA
- DRC
- DRV
- DRZ
- DRXR
- DRW

● : Standard item R : Right-hand only L : Left-hand only □ : Check availability

Suitable chipbreaker (ZCMT)

Workpiece material	Insert size		ZCMT05									ZCMT06									ZCMT08					
	Chipbreaker	Drilling depth	Standard			SP			SU			Standard			SP			SU			Standard			SP		
	2D	3D	4D	2D	3D	4D	2D	3D	4D	2D	3D	4D	2D	3D	4D	2D	3D	4D	2D	3D	4D	2D	3D	4D		
Low carbon steel	☆	☆	-	★	★	★	-	-	-	☆	☆	-	★	★	★	☆	☆	☆	☆	☆	-	★	★	★		
Carbon steel	★	★	☆	☆	☆	★	-	-	-	★	★	☆	☆	☆	★	-	-	-	★	★	☆	☆	☆	★		
Alloy steel	★	★	☆	☆	☆	★	-	-	-	★	★	☆	☆	☆	★	-	-	-	★	★	☆	☆	☆	★		
Mold steel	★	★	☆	☆	☆	★	-	-	-	★	★	☆	☆	☆	★	-	-	-	★	★	☆	☆	☆	★		
Stainless steel	☆	☆	-	★	★	★	☆	☆	-	-	-	-	☆	☆	☆	★	★	★	☆	☆	-	★	★	★		
Cast iron	★	★	★	☆	☆	☆	-	-	-	★	★	★	☆	☆	☆	-	-	-	★	★	★	☆	☆	☆		
Aluminum alloys	☆	☆	☆	★	★	★	-	-	-	☆	☆	☆	★	★	★	-	-	-	☆	☆	☆	★	★	★		
Brass	★	★	★	☆	☆	☆	-	-	-	★	★	★	☆	☆	☆	-	-	-	★	★	★	☆	☆	☆		
Titanium alloys	☆	☆	☆	★	★	★	-	-	-	☆	☆	☆	★	★	★	-	-	-	☆	☆	☆	★	★	★		

Workpiece material	Insert size		ZCMT10							ZCMT12							ZCMT15							ZCMT20			
	Chipbreaker	Drilling depth	Standard				SP			Standard				SP			Standard				SP			Standard			
	2D	3D	4D	5D	2D	3D	4D	5D	2D	3D	4D	5D	2D	3D	4D	5D	2D	3D	4D	5D	2D	3D	4D	5D	2D	3D	4D
Low carbon steel	☆	☆	-	-	★	★	★	★	☆	☆	-	-	★	★	★	★	☆	☆	-	-	★	★	★	★	★	★	★
Carbon steel	★	★	☆	☆	☆	☆	★	★	★	★	☆	☆	☆	☆	★	★	★	★	☆	☆	☆	☆	★	★	★	★	★
Alloy steel	★	★	☆	☆	☆	☆	★	★	★	★	☆	☆	☆	☆	★	★	★	★	☆	☆	☆	☆	★	★	★	★	★
Mold steel	★	★	☆	☆	☆	☆	★	★	★	★	☆	☆	☆	☆	★	★	★	★	☆	☆	☆	☆	★	★	★	★	★
Stainless steel	☆	☆	-	-	★	★	★	★	☆	☆	-	-	★	★	★	★	☆	☆	-	-	★	★	★	★	★	★	★
Cast iron	★	★	★	★	☆	☆	☆	☆	★	★	★	★	☆	☆	☆	☆	★	★	★	★	☆	☆	☆	☆	★	★	★
Aluminum alloys	☆	☆	☆	☆	★	★	★	★	☆	☆	☆	☆	★	★	★	★	☆	☆	☆	☆	★	★	★	★	★	★	★
Brass	★	★	★	★	☆	☆	☆	☆	★	★	★	★	☆	☆	☆	☆	★	★	★	★	☆	☆	☆	☆	★	★	★
Titanium alloys	☆	☆	☆	☆	★	★	★	★	☆	☆	☆	☆	★	★	★	★	☆	☆	☆	☆	★	★	★	★	★	★	★

Standard chipbreakers (Without symbol) may function better when interrupted drilling.
 When drilling aluminum alloys, chips become long and difficult to be discharged at the depth over 2D.
 5D type is the same as 4D type.

★: 1st choice ☆: 2nd choice



DRZ (Drilling depth : 2 x DC)

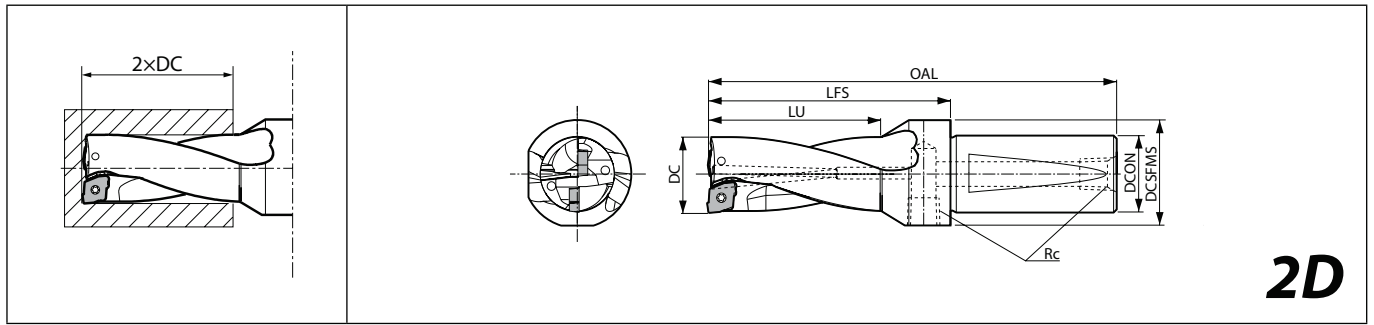

Toolholder dimensions

Description	Availability	No. of inserts	Dimension (mm)							Coolant hole	Radial offset max.	Spare parts				Applicable inserts ● K76		
			DC	DCON	OAL	LFS	LU	DCSFMS	Rc			Plug	Screw	Wrench	Wrench			
																	Plug	Screw
S20- DRZ1326-05 DRZ135270-05 DRZ1428-05 DRZ145290-05 DRZ1530-05 DRZ155310-05	●	2	13	20	95	52	26	27	Rc1/8	Yes	+0.5	GP-1	SB-2045TR	-	FT-6	ZCMT050203 ZCMT050203SP ZCMT050203SU		
	●		13.5														55	27
	●		14		57	28												
	●		14.5				30										29	
	●		15		31	30												
●	15.5	100	57	31														
S25- DRZ1632-06 DRZ165330-06 DRZ1734-06 DRZ175350-06 DRZ1836-06 DRZ185370-06 DRZ1938-06 DRZ195390-06 DRZ2040-06 DRZ205410-06 DRZ2142-06	●	2	16	25	115	61	32	32	Rc1/8	Yes	+1.1	GP-1	SB-2260TR	DT-7	-	ZCMT06T204 ZCMT06T204SP ZCMT06T204SU		
	●		16.5														62	33
	●		17		64	34												
	●		17.5				66										35	
	●		18		69	36												
	●		18.5				71										37	
	●		19		74	38												
	●		19.5				76										39	
	●		20		77	40												
	●		20.5				79										41	
	●		21		125	71												42
	S25- DRZ215430-08 DRZ2244-08 DRZ225450-08 DRZ2346-08 DRZ235470-08 DRZ2448-08 DRZ245490-08 DRZ2550-08 DRZ25510-08 DRZ2652-08 DRZ265530-08		●		2	21.5	25										128	74
●		22	76	44														
●		22.5				77		45										
●		23	79	46														
●		23.5				81		47										
●		24	81	48														
●		24.5				81		49										
●		25	81	50														
●		25.5				81		51										
●		26	81	52														
●		26.5				135		81	53									

When offset drilling, reduce feed rate to 0.08 mm/rev or less.
See page K72 for Adjustable Sleeve (SHE).

Recommended cutting conditions ● K87
Trouble shooting ● K67

● : Standard item R : Right-hand only L : Left-hand only □ : Check availability

Toolholder dimensions

2xDC

Description	Availability	No. of inserts	Dimension (mm)							Coolant hole	Radial offset max.	Spare parts				Applicable inserts K76				
			DC	DCON	OAL	LFS	LU	DCSFMS	Rc			Plug	Screw	Wrench	Wrench					
S32- DRZ2754-10 DRZ275550-10 DRZ2856-10 DRZ285570-10 DRZ2958-10 DRZ295590-10 DRZ3060-10 DRZ305610-10 DRZ3162-10 DRZ315630-10 DRZ3264-10 DRZ325650-10	●	2	27	32	149	90	54	42	Rc1/4	Yes	+2.5	GP-2	SB-4085TR	DT-15	-	ZCMT10T304 ZCMT10T304SP				
	●		27.5								151						92	56	55	+2.3
	●		28																	153
	●		28.5		154	95	60				45						+2.1			
	●		29														155	96	62	+2
	●		29.5		158	99	64				+1.8									
	●		30	155				96	63	+1.7										
	●		30.5		158	99	65			+1.5										
	●		31	158				99	65	+1.5										
	●		31.5		158	99	65			+1.3										
	●		32	158				99	65	+1.2										
	●		32.5		158	99	65			+1										
S40- DRZ3366-12 DRZ3468-12 DRZ3570-12 DRZ3672-12 DRZ3774-12 DRZ3876-12 DRZ3978-12 DRZ4080-12	●	2	33	40				173	104	66	55	Rc1/4	Yes	+2.9	GP-2	SB-5085TR	DT-20	-	ZCMT12T304SP ZCMT12T306	
	●		34		176	107	68	+2.7												
	●		35		177	108	70	+2.4												
	●		36		180	111	72	+2.2												
	●		37		181	112	74	+1.9												
	●		38		183	114	76	+1.7												
	●		39		185	116	78	+1.4												
	●		40		185	116	80	+1.2												
S40- DRZ4182-15 DRZ4284-15 DRZ4386-15 DRZ4488-15 DRZ4590-15 DRZ4692-15 DRZ4794-15 DRZ4896-15 DRZ4998-15 DRZ50100-15 DRZ51102-15 DRZ52104-15 DRZ53106-15	●	2	41	40	186	117	82	55	Rc1/4	Yes	+4	GP-2	SB-5085TR	DT-20	-	ZCMT150406SP ZCMT150408				
	●		42		188	119	84				+3.7									
	●		43		190	121	86				+3.5									
	●		44		192	123	88				+3.2									
	●		45		198	129	92				+3									
	●		46		198	129	92				+2.7									
	●		47	201	132	94	+2.5													
	●		48	203	134	96	+2.2													
	●		49	204	135	98	+2													
	●		50	204	135	100	+1.7													
	●		51	205	136	102	+1.2													
	●		52	205	136	104	+1													
●	53	208	139	106	+0.7															
S40- DRZ54108-20 DRZ55110-20 DRZ56112-20 DRZ57114-20 DRZ58116-20 DRZ59118-20	●	2	54	40	214	145	108	65	Rc1/4	Yes	+5	GP-2	SB-60120TR	DT-25	-	ZCMT200608				
	●		55		215	146	110				+4.7									
	●		56		217	148	112				+4.4									
	●		57		219	150	114				+4.1									
	●		58		221	152	116				+3.8									
	●		59		223	154	118				+3.5									

When offset drilling, reduce feed rate to 0.08 mm/rev or less.
See page K72 for Adjustable Sleeve (SHE).

Recommended cutting conditions K87
Trouble shooting K67

Hole Dia. Tolerance (2D type)

DC	Hole Dia. Tolerance (mm)
ø13~ø26.5	+0.20 -0.10
ø27~ø40	+0.25 -0.15
ø41~ø59	+0.30 -0.20

* Above is numeric guideline.
It may vary depending on machines / workpieces / clamping status / cutting conditions.

● : Standard item R : Right-hand only L : Left-hand only □ : Check availability



DRZ (Drilling depth : 3 x DC)

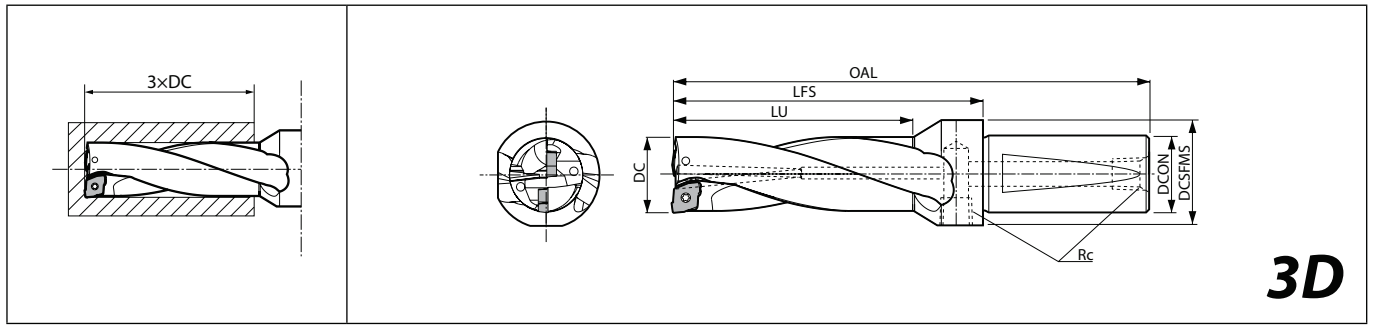

Toolholder dimensions

Description	Availability	No. of inserts	Dimension (mm)							Coolant hole	Radial offset max.	Spare parts				Applicable inserts K76
			DC	DCON	OAL	LFS	LU	DCSFMS	Rc			Plug	Screw	Wrench	Wrench	
S20- DRZ1339-05 DRZ135405-05 DRZ1442-05 DRZ145435-05 DRZ1545-05 DRZ155465-05	●	2	13 13.5 14 14.5 15 15.5	20	108 112 115	65 69 72	39 40.5 42 43.5 45 46.5	27	Rc1/8	Yes	+0.5	GP-1	SB-2045TR	-	FT-6	ZCMT050203 ZCMT050203SP ZCMT050203SU
S25- DRZ1648-06 DRZ165495-06 DRZ1751-06 DRZ175525-06 DRZ1854-06 DRZ185555-06 DRZ1957-06 DRZ195585-06 DRZ2060-06 DRZ205615-06 DRZ2163-06	●	2	16 16.5 17 17.5 18 18.5 19 19.5 20 20.5 21	25	131 133 136 139 143 146 146	77 79 82 85 89 92 92	48 49.5 51 52.5 54 55.5 57 58.5 60 61.5 63	32	Rc1/8	Yes	+1.1 +0.9 +0.8 +0.7 +0.6 +0.5 +0.5 +0.3 +0.2	GP-1	SB-2260TR	DT-7	-	ZCMT06T204 ZCMT06T204SP ZCMT06T204SU
S25- DRZ215645-08 DRZ2266-08 DRZ225675-08 DRZ2369-08 DRZ235705-08 DRZ2472-08 DRZ245735-08 DRZ2575-08 DRZ255765-08 DRZ2678-08 DRZ265795-08	●	2	21.5 22 22.5 23 23.5 24 24.5 25 25.5 26 26.5	25	147 150 152 155 158	93 96 98 101 104	64.5 66 67.5 69 70.5 72 73.5 75 76.5 78 79.5	33	Rc1/8	Yes	+1.8 +1.6 +1.4 +1.3 +1.2 +1.1 +0.9 +0.8 +0.7 +0.6 +0.5	GP-1	SB-2570TR	DT-8	-	ZCMT080304 ZCMT080304SP

When offset drilling, reduce feed rate to 0.08 mm/rev or less.
See page K72 for Adjustable Sleeve (SHE).

Recommended cutting conditions **K87**
Trouble shooting **K67**

Hole Dia. Tolerance (3D type)

DC	Hole Dia. Tolerance (mm)
ø13~ø26.5	+0.20 -0.10
ø27~ø40	+0.25 -0.15
ø41~ø59	+0.30 -0.20

* Above is numeric guideline.
It may vary depending on machines / workpieces / clamping status / cutting conditions.

● : Standard item R : Right-hand only L : Left-hand only □ : Check availability

K

Drilling

DRA

DRC

DRV





DRZ

DRXR

DRW

Toolholder dimensions

3xDC

Description	Availability	No. of inserts	Dimension (mm)							Coolant hole	Radial offset max.	Spare parts				Applicable inserts K76	
			DC	DCON	OAL	LFS	LU	DCSFMS	Rc			Plug	Screw	Wrench	Wrench		
																	
S32- DRZ2781-10	●	2	27	32	173	114	81	42	Rc1/4	Yes	+2.5	GP-2	SB-4085TR	DT-15	-	ZCMT10T304 ZCMT10T304SP	
DRZ275825-10	●		27.5								82.5						+2.3
DRZ2884-10	●		28								176						117
DRZ285855-10	●		28.5		85.5	+2.1											
DRZ2987-10	●		29		179	120	87				+2						
DRZ295885-10	●		29.5								88.5						+1.8
DRZ3090-10	●		30	45	181	122	90	55	Rc1/4	Yes	+1.7						
DRZ305915-10	●		30.5								91.5						+1.5
DRZ3193-10	●		31								183						124
DRZ315945-10	●		31.5		94.5	+1.3											
DRZ3296-10	●		32		187	128	96				+1.2						
DRZ325975-10	●		32.5								97.5						+1
S32- DRZ3399-12	●		2		33	32	193				134						99
DRZ34102-12	●	34		102	+2.7												
DRZ35105-12	●	35		105	+2.4												
DRZ36108-12	●	36		108	+2.2												
DRZ37111-12	●	37		111	+1.9												
DRZ38114-12	●	38		114	+1.7												
DRZ39117-12	●	39		117	+1.4												
DRZ40120-12	●	40		120	+1.2												
S40- DRZ3399-12	●	2	33	40	203	134	99	55	Rc1/4	Yes	+2.9	GP-2	SB-5085TR	DT-20	-	ZCMT12T304SP ZCMT12T306	
DRZ34102-12	●		34								102						+2.7
DRZ35105-12	●		35								105						+2.4
DRZ36108-12	●		36								108						+2.2
DRZ37111-12	●		37								111						+1.9
DRZ38114-12	●		38								114						+1.7
DRZ39117-12	●		39								117						+1.4
DRZ40120-12	●		40								120						+1.2
S40- DRZ41123-15	●	2	41	40	224	155	123	55	Rc1/4	Yes	+4	GP-2	SB-5085TR	DT-20	-	ZCMT150406SP ZCMT150408	
DRZ42126-15	●		42								126						+3.7
DRZ43129-15	●		43								129						+3.5
DRZ44132-15	●		44								132						+3.2
DRZ45135-15	●		45								135						+3
DRZ46138-15	●		46								138						+2.7
DRZ47141-15	●		47	60	245	176	141	60	Rc1/4	Yes	+2.5						
DRZ48144-15	●		48								144						+2.2
DRZ49147-15	●		49								147						+2
DRZ50150-15	●		50		150	+1.7											
DRZ51153-15	●		51		153	+1.2											
DRZ52156-15	●		52		156	+1											
DRZ53159-15	●		53		159	+0.7											
S40- DRZ54162-20	●	2	54	40	266	197	162	65	Rc1/4	Yes	+5	GP-2	SB-60120TR	DT-25	-	ZCMT200608	
DRZ55165-20	●		55								165						+4.7
DRZ56168-20	●		56								168						+4.4
DRZ57171-20	●		57								171						+4.1
DRZ58174-20	●		58								174						+3.8
DRZ59177-20	●		59								177						+3.5

When offset drilling, reduce feed rate to 0.08 mm/rev or less.
See page K72 for Adjustable Sleeve (SHE).

Recommended cutting conditions K87
Trouble shooting K67



● : Standard item R : Right-hand only L : Left-hand only □ : Check availability

DRZ (Drilling depth : 4 x DC)

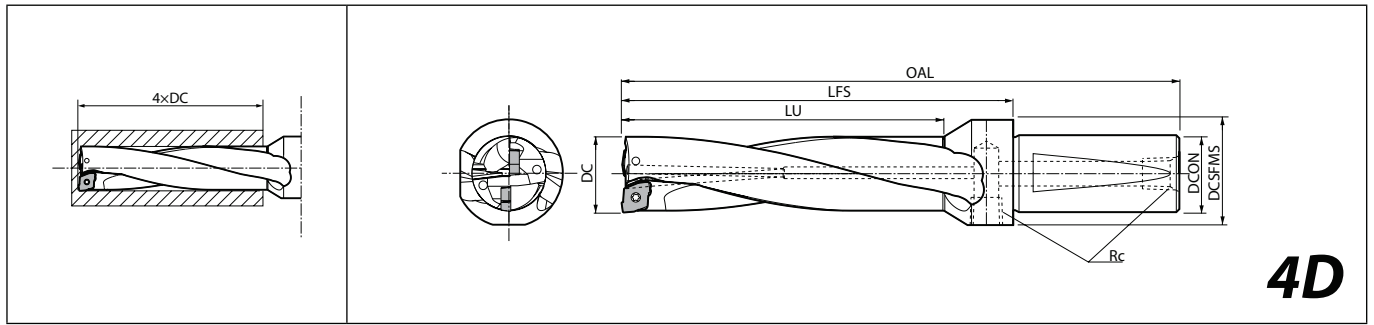

Toolholder dimensions

Description	Availability	No. of inserts	Dimension (mm)							Coolant hole	Radial offset max.	Spare parts				Applicable inserts K76				
			DC	DCON	OAL	LFS	LU	DCSFMS	Rc			Plug	Screw	Wrench	Wrench					
																	Plug	Screw	Wrench	Wrench
S20- DRZ1352-05	●	2	13	20	121	78	52	27	Rc1/8	Yes	+0.5	GP-1	SB-2045TR	-	FT-6	ZCMT050203 ZCMT050203SP ZCMT050203SU				
DRZ135540-05	●		13.5														126	83	56	
DRZ1456-05	●		14																	
DRZ145580-05	●		14.5		130	87	60													
DRZ1560-05	●		15																	
DRZ155620-05	●	15.5			62															
S25- DRZ1664-06	●	2	16	25	147	93	64	32	Rc1/8	Yes	+1.1	GP-1	SB-2260TR	DT-7	-		ZCMT06T204 ZCMT06T204SP ZCMT06T204SU			
DRZ165660-06	●		16.5															149	95	68
DRZ1768-06	●		17																	
DRZ175700-06	●		17.5		153	99	70													
DRZ1872-06	●		18																	
DRZ185740-06	●		18.5		157	103	74													
DRZ1976-06	●		19																	
DRZ195780-06	●		19.5		156	102	78													
DRZ2080-06	●		20																	
DRZ205820-06	●		20.5		161	107	80													
DRZ2184-06	●		21																	
S25- DRZ215860-08	●		2		21.5	25	169									115		86	33	Rc1/8
DRZ2288-08	●	22		173	119			88												
DRZ225900-08	●	22.5																		
DRZ2392-08	●	23		176	122			92												
DRZ235940-08	●	23.5																		
DRZ2496-08	●	24		180	126		96													
DRZ245980-08	●	24.5																		
DRZ25100-08	●	25		184	130		98													
DRZ2551020-08	●	25.5																		
DRZ26104-08	●	26																		
DRZ2651060-08	●	26.5					102													
							104													
							106													
								+0.7												
								+0.6												
						+0.5														





When offset drilling, reduce feed rate to 0.06 mm/rev or less.
See page K72 for Adjustable Sleeve (SHE).

Recommended cutting conditions K87
Trouble shooting K67

● : Standard item R : Right-hand only L : Left-hand only □ : Check availability

Toolholder dimensions

4xDC

Description	Availability	No. of inserts	Dimension (mm)							Coolant hole	Radial offset max.	Spare parts				Applicable inserts K76
			DC	DCON	OAL	LFS	LU	DCSFMS	Rc			Plug	Screw	Wrench	Wrench	
																
S32- DRZ27108-10 DRZ2751100-10 DRZ28112-10 DRZ2851140-10 DRZ29116-10 DRZ2951180-10 DRZ30120-10 DRZ3051220-10 DRZ31124-10 DRZ3151260-10 DRZ32128-10 DRZ3251300-10	●	2	27	32	200	141	108	42	Rc1/4	Yes	+2.5	GP-2	SB-4085TR	DT-15	-	ZCMT10T304 ZCMT10T304SP
	●		27.5								+2.3					
	●		28								+2.2					
	●		28.5		204	145	114				+2.1					
	●		29		208	149	116				+2					
	●		29.5		211	152	120				+1.8					
	●		30								+1.7					
	●		30.5								+1.5					
	●		31		214	155	124				+1.3					
	●		31.5								+1.2					
	●		32								+1					
	●		32.5								219					
	S32- DRZ33132-12 DRZ34136-12 DRZ35140-12 DRZ36144-12 DRZ37148-12 DRZ38152-12 DRZ39156-12 DRZ40160-12		●		2	33	32				226					
●		34	231	172		136		+2.7								
●		35	234	175		140		+2.4								
●		36	239	180		144		+2.2								
●		37	242	183		148		+1.9								
●		38	246	187		152		+1.7								
●		39	250	191		156		+1.4								
●		40	252	193		160		+1.2								
S40- DRZ33132-12 DRZ34136-12 DRZ35140-12 DRZ36144-12 DRZ37148-12 DRZ38152-12 DRZ39156-12 DRZ40160-12		●	2	33		40		236	167	132	55	Rc1/4	Yes	+2.9	GP-2	SB-5085TR
	●	34		241	172		136	+2.7								
	●	35		244	175		140	+2.4								
	●	36		249	180		144	+2.2								
	●	37		252	183		148	+1.9								
	●	38		256	187		152	+1.7								
	●	39		260	191		156	+1.4								
	●	40		262	193		160	+1.2								
	S40- DRZ41164-15 DRZ42168-15 DRZ43172-15 DRZ44176-15 DRZ45180-15 DRZ46184-15 DRZ47188-15 DRZ48192-15 DRZ49196-15 DRZ50200-15	●		2	41		40	265	196	164				55		
●		42	269		200	168		+3.7								
●		43	273		204	172		+3.5								
●		44	277		208	176		+3.2								
●		45	279		210	180		+3								
●		46	287		218	184		+2.7								
●		47	292		223	188	+2.5									
●		48	296		227	192	+2.2									
●		49	300		231	196	+2									
●		50	301		232	200	+1.7									

When offset drilling, reduce feed rate to 0.06 mm/rev or less.
See page K72 for Adjustable Sleeve (SHE).

Recommended cutting conditions K87
Trouble shooting K67

Hole Dia. Tolerance (4D type)

DC	Hole Dia. Tolerance (mm)
φ13~φ26.5	+0.25 -0.10
φ27~φ40	+0.30 -0.15
φ41~φ50	+0.35 -0.20

* Above is numeric guideline.
It may vary depending on machines / workpieces / clamping status / cutting conditions.

● : Standard item R : Right-hand only L : Left-hand only □ : Check availability



DRZ (Drilling depth : 5 x DC)

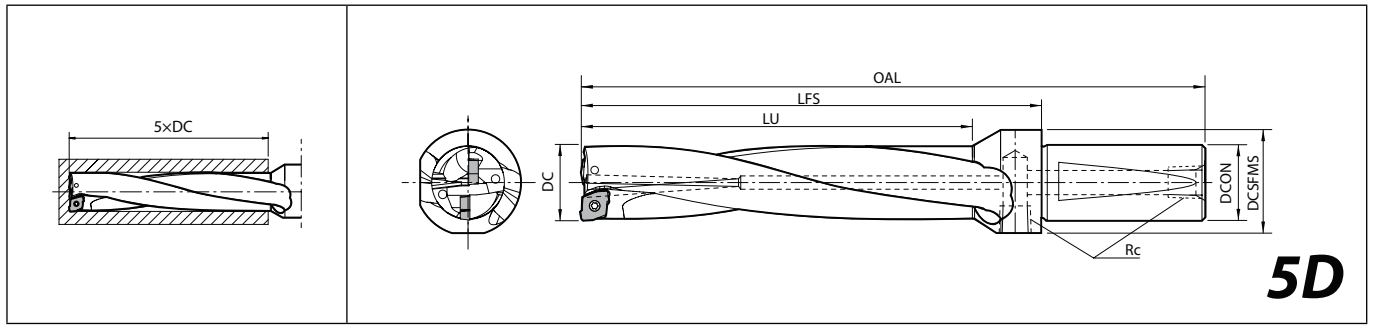

Toolholder dimensions

Description	Availability	No. of inserts	Dimension (mm)							Coolant hole	Radial offset max.	Spare parts			Applicable inserts K76
			DC	DCON	OAL	LFS	LU	DCSFMS	Rc			Plug	Screw	Wrench	
S32- DRZ27135-10 DRZ28140-10 DRZ29145-10 DRZ30150-10 DRZ31155-10 DRZ32160-10	●	2	27	32	277	168	135	42	Rc1/4	Yes	+2.5	GP-2	SB-4085TR	DT-15	ZCMT10T304 ZCMT10T304SP
	●		28		232	173	140				+2.2				
	●		29		237	178	145				+2				
	●		30		241	182	150				+1.7				
	●		31		245	186	155				+1.5				
	●		32		251	192	160				+1.2				
S40- DRZ33165-12 DRZ34170-12 DRZ35175-12 DRZ36180-12 DRZ37185-12 DRZ38190-12 DRZ39195-12 DRZ40200-12	●	2	33	40	269	200	165	55	Rc1/4	Yes	+2.9	GP-2	SB-5085TR	DT-20	ZCMT12T304SP ZCMT12T306
	●		34		275	206	170				+2.7				
	●		35		279	210	175				+2.4				
	●		36		285	216	180				+2.2				
	●		37		289	220	185				+1.9				
	●		38		294	225	190				+1.7				
	●		39		299	230	195				+1.4				
	●		40		302	233	200				+1.2				
S40- DRZ41205-15 DRZ42210-15 DRZ43215-15 DRZ44220-15 DRZ45225-15 DRZ46230-15 DRZ47235-15 DRZ48240-15 DRZ49245-15 DRZ50250-15	●	2	41	40	306	237	205	55	Rc1/4	Yes	+4	GP-2	SB-5085TR	DT-20	ZCMT150406SP ZCMT150408
	●		42		311	242	210				+3.7				
	●		43		316	247	215				+3.5				
	●		44		321	252	220				+3.2				
	●		45		324	255	225				+3				
	●		46		333	264	230				+2.7				
	●		47		339	270	235				+2.5				
	●		48		344	275	240				+2.2				
	●		49		349	280	245				+2				
	●		50		351	282	250				+1.7				

When offset drilling, reduce feed rate to 0.05 mm/rev or less.
See page K72 for Adjustable Sleeve (SHE).

Recommended cutting conditions K87
Trouble shooting K67

Hole Dia. Tolerance (5D type)

DC	Hole Dia. Tolerance (mm)
ø27~ø40	+0.35 -0.15
ø41~ø50	+0.40 -0.20

* Above is numeric guideline.
It may vary depending on machines / workpieces / clamping status / cutting conditions.

● : Standard item R : Right-hand only L : Left-hand only □ : Check availability

DRZ-CR

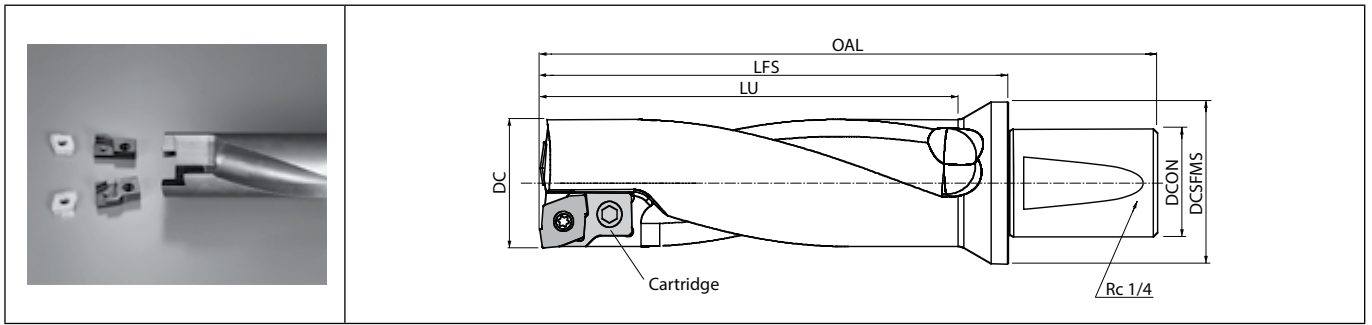

Toolholder dimensions

Description	Availability	No. of inserts	Dimension (mm)						Coolant hole	Radial offset max.	Spare parts				Applicable inserts ➔ K76
			DC	DCON	OAL	LFS	LU	DCSFMS			Cartridge (inner edge)	Cartridge (outer edge)	Screw	Wrench	
S50- DRZ60180-20CR DRZ65195-20CR DRZ70210-20CR	MTO	2	60	286	217	195	75	Yes	+3	DR20CR-IN (1pc)	DR20CR-OUT (1pc)	SB-60120TR	DT-25	ZCMT200608	
	MTO		65	50	296	227			206						+1.5
	MTO		70		308	239			220						+0.2
S50- DRZ75225-12CR DRZ80240-12CR	MTO	4	75	50	330	261	225	80	Yes	Offset	DR12CR-IN (2pcs)	DR12CR-OUT (2pcs)	SB-5085TR	DT-20	ZCMT12T304SP ZCMT12T306
	MTO		80		340	271	240			N.A.					

Clamp screws for cartridges are included in toolholders : HH6X12 for DR20CR and HH4X12 for DR12CR.

Recommended cutting conditions ➔ K87



DRZ hole bottom shape (Common for 2D, 3D, 4D, 5D) (mm)

DC	A	B	C	DC	A	B	C	DC	A	B	C	DC	A	B	C	DC	A	B	C
13.0		4.4		21.5		7.7		33.0		10.8		41.0		14.0		54.0		18.5	
13.5		4.7	0.4	22.0		7.9		34.0		11.3		42.0		14.5		55.0		19.0	
14.0	2.1	4.9		22.5		8.2	0.6	35.0		11.8	0.8	43.0		15.0		56.0		19.5	
14.5		5.2		23.0		8.4		36.0	5.7	12.3		44.0		15.5		57.0		20.0	
15.0		5.4	0.5	23.5	3.1	8.7		37.0		12.8		45.0		16.0		58.0		20.5	
15.5		5.7		24.0		8.9		38.0		13.3		46.0		16.5		59.0		21.0	
16.0		5.3		24.5		9.2		39.0		13.8	0.9	47.0	6.5	17.0					
16.5		5.6	0.6	25.0		9.4	0.7	40.0		14.3		48.0		17.5					
17.0		5.8		25.5		9.7		41.0		14.0		49.0		18.0					
17.5		6.1		26.0		9.9		42.0		14.5		50.0		18.5	1.1				
18.0		6.3		26.5		10.2		43.0		15.0		51.0		19.0					
18.5	2.7	6.6		27.0		9.5		44.0		15.5		52.0		19.5					
19.0		6.8	0.7	27.5		9.8		45.0		16.0		53.0		20.0					
19.5		7.1		28.0		10.0		46.0		16.5		54.0		18.5					
20.0		7.3		28.5		10.3	0.7	47.0		17.0		55.0		19.0					
20.5		7.6		29.0		10.5		48.0		17.5		56.0		19.5					
21.0		7.8	0.8	29.5	4.0	10.8		49.0		18.0		57.0	8.5	20.0	1.2				
				30.0		11.0		50.0		18.5		58.0		20.5					
				30.5		11.3		51.0		19.0		59.0		21.0					
				31.0		11.5		52.0		19.5									
				31.5		11.8	0.8	53.0		20.0									
				32.0		12.0		54.0		18.5									
				32.5		12.3		55.0		19.0									

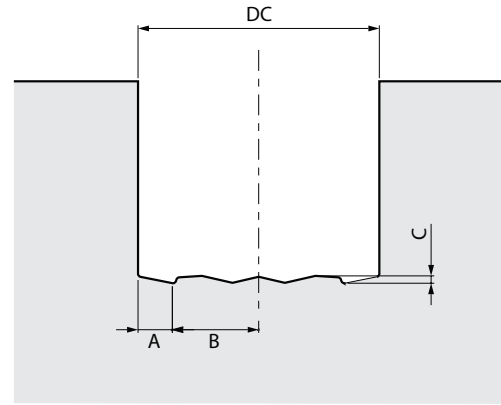

* Above is numeric guideline.
(Varies within ±0.1mm depending on workpiece materials and cutting conditions)

K



Drilling

Cutting power

ø20 cutting power comparison

- Magic Drill DRZ
- Competitor A

Vc=100m/min, (n=1,600min⁻¹)
ø20 indexable drill
15CrMo4 wet (Internal coolant)

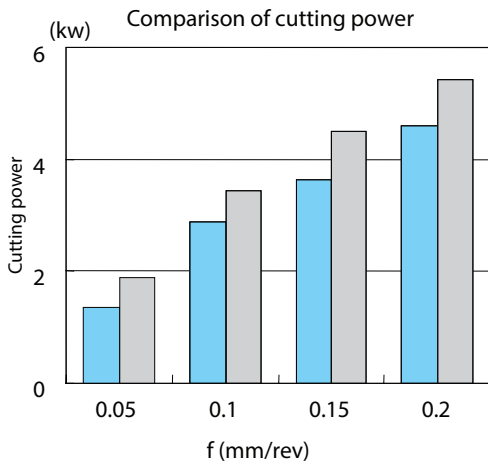

Case studies

MagicDrill dia.	ø16	ø27	ø50				
Machine	Competitor A	Competitor B	Competitor C	Competitor D			
Machine power	AC 5.5/7.5 kW	AC 5.5/7.5 kW	AC 5.5/7.5 kW	AC 7.5/11 kW			
Cutting conditions	Vc (mm/min)	150	130	150	120	110	157
	f (mm/rev)	0.06	0.13		0.1	0.08	0.12
Workpiece material	SS400	34CrMo4		15CrMo4	SS400		
Required power (Load meter values)	60%	80%	95%	100%	60%	100%	
Remarks	-	-		With conventional drill, limited up to ø40	-		

Formula for calculating required power (Approximate value)

Recommended cutting conditions (Coolant)

Workpiece material	Recommended insert grades (Vc: m/min)				DC (mm)	Drill type (Drilling depth)			
	MEGACOAT			Carbide		2D	3D	4D	5D
	PR1230	PR1225	PR1210	KW10					
	Standard SP SU	Standard SP SU	Standard	Standard SP		f (mm/rev)			
Low carbon steel	★ 120~220	☆ 120~220	-	-	ø13~ø15.5	0.06~0.10	0.06~0.10	0.04~0.08	-
					ø16~ø26.5	0.08~0.15	0.08~0.15	0.06~0.12	-
					ø27~ø50	0.08~0.18	0.08~0.15	0.06~0.12	0.05~0.09
					ø50~	0.08~0.18	0.08~0.15	0.06~0.12	-
Carbon steel	★ 100~160	☆ 100~160	-	-	ø13~ø15.5	0.06~0.10	0.06~0.10	0.04~0.08	-
					ø16~ø26.5	0.08~0.15	0.08~0.15	0.06~0.12	-
					ø27~ø50	0.08~0.18	0.08~0.15	0.06~0.12	0.05~0.09
					ø50~	0.08~0.18	0.08~0.15	0.06~0.12	-
Alloy steel	★ 80~140	☆ 80~140	-	-	ø13~ø15.5	0.06~0.10	0.06~0.10	0.04~0.08	-
					ø16~ø26.5	0.08~0.15	0.08~0.15	0.06~0.12	-
					ø27~ø50	0.08~0.18	0.08~0.15	0.06~0.12	0.05~0.09
					ø50~	0.08~0.18	0.08~0.15	0.06~0.12	-
Mold steel	★ 70~130	☆ 70~130	-	-	ø13~ø15.5	0.04~0.08	0.04~0.08	0.03~0.07	-
					ø16~ø26.5	0.08~0.12	0.06~0.10	0.06~0.08	-
					ø27~ø50	0.08~0.15	0.06~0.12	0.06~0.10	0.04~0.07
					ø50~	0.08~0.15	0.06~0.12	0.06~0.10	-
Stainless steel (Austenitic related)	☆ 60~120	★ 60~120	-	-	ø13~ø15.5	0.04~0.08	0.04~0.08	0.03~0.06	-
					ø16~ø26.5	0.06~0.10	0.06~0.10	0.04~0.08	-
					ø27~ø50	0.06~0.10	0.06~0.12	0.04~0.10	0.04~0.07
					ø50~	0.06~0.12	0.06~0.12	0.04~0.10	-
Gray cast iron	-	-	★ 100~150	☆ 100~120	ø13~ø15.5	0.08~0.12	0.08~0.10	0.06~0.08	-
					ø16~ø26.5	0.10~0.18	0.10~0.15	0.08~0.12	-
					ø27~ø50	0.10~0.20	0.10~0.18	0.08~0.15	0.06~0.10
					ø50~	0.10~0.20	0.10~0.18	0.08~0.15	-
Nodular cast iron	-	-	★ 80~120	☆ 80~100	ø13~ø15.5	0.08~0.12	0.08~0.10	0.06~0.08	-
					ø16~ø26.5	0.10~0.18	0.10~0.15	0.08~0.12	-
					ø27~ø50	0.10~0.20	0.10~0.18	0.08~0.15	0.06~0.10
					ø50~	0.10~0.20	0.10~0.18	0.08~0.15	-
Non-ferrous metals	-	-	-	★ 200~600	ø13~ø15.5	0.06~0.12	0.06~0.10	0.04~0.08	-
					ø16~ø26.5	0.08~0.18	0.08~0.15	0.06~0.15	-
					ø27~ø50	0.08~0.20	0.08~0.18	0.06~0.15	0.05~0.10
					ø50~	0.08~0.20	0.08~0.18	0.06~0.15	-
Titanium alloys	-	-	-	★ 40~70	ø13~ø15.5	0.05~0.06	0.05~0.06	0.05~0.06	-
					ø16~ø26.5	0.05~0.07	0.05~0.07	0.05~0.07	-
					ø27~ø50	0.06~0.08	0.06~0.08	0.06~0.08	0.04~0.05
					ø50~	0.06~0.08	0.06~0.08	0.06~0.08	-

• Apply a sufficient amount of coolant.

★: 1st recommendation ☆: 2nd recommendation

Cutting conditions by application

[Workpiece material: C50]

Applications	Plain surface	Slant surface	Half cylindrical	Hole expansion	Concave surface	Cored hole	Stacked plates
Shape of workpiece							
DRZ	Cutting speed Vc (m/min)	120	120	120	120	120	Not available
	f (mm/rev)	0.1	0.05	0.05	0.05	Concave surface 0.05 Continuous part 0.1	*0.05 Not available
Coolant (Internal)	Yes	Yes	Yes	Yes	Yes	Yes	Not available

* Cutting width (Torus-shaped part) when drilling cored hole. (Same as when using a boring bar).

Drill type	2D ~ 3D	4D ~ 5D
Cutting width (Torus-shaped part)	0.1 x DC or less	Not recommended

e.g.) In case of drilling using DRZ3090-10 (3 x DC)
 1. For milling, pre-drilled hole should be cut ø24 (ø30 - 0.1 x 30 x 2) or bigger
 2. For turning, ap should be set ap = 3mm (0.1 x 30) or under

Max. depth of drilling with external coolant

In case of using external coolant system, chip evacuation will be bad. Therefore ap should be measured within 1.5 times (1.5 x DC) of drill diameter (DC).



Lathe installation (DRZ and DRXR)

1. The top face of the outer insert should be parallel to the X-axis to allow for offset machining. Drill diameter can be changed by moving X-axis.
2. It is recommended to set the outer insert as shown in Fig. 1 with the outer insert facing the operator. (It is also possible to use it by setting it in 180° reverse position) If the lathe has two turrets, when installing the drill into the lower turret, the outer insert should be set to face the operator. (It is also possible to use it by setting at 180° reverse position)

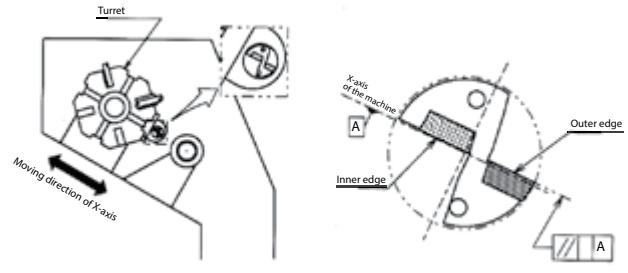

(Fig. 1) Installed to the lathe

Drill diameter adjustment

1. Drill diameter adjustment

1. Drill diameter is adjusted by moving X-axis. The moving direction of the X-axis depends on the position of the toolholder.
2. In case of making the hole diameter larger, slide the tool along the X-axis toward the outer insert side. (Fig. 2, Fig. 3) For making the hole diameter smaller, slide the tool along the X-axis in the opposite direction. (This movement of the axis is called "Offset") However, be sure not to make the hole diameter smaller than the drill diameter by 0.2mm or more. Otherwise, the toolholder will interfere with the drilled hole. (Fig. 4) e.g.) In case of using $\phi 20$ drill, the hole diameter must not be smaller than 19.8mm.

2. Offset limit of the drill diameter

For the maximum limit of the drill diameter, refer to "Max. Offset (Radial)" in the Toolholder Dimensions table. (The figure in the table shows how much it is possible the offset the drill in the radial direction.) e.g.) In case of using $\phi 20$ drill, it is possible to make a hole up to $\phi 21$ since "Max. Offset (Radial)" is +0.5mm.

K

Drilling

- DRA
- DRC
- DRV
- DRZ
- DRXR
- DRW

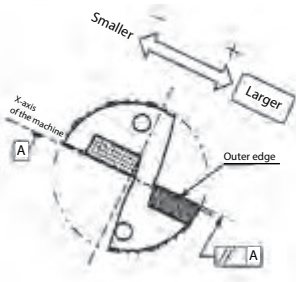

(Fig. 2) Outer insert facing up

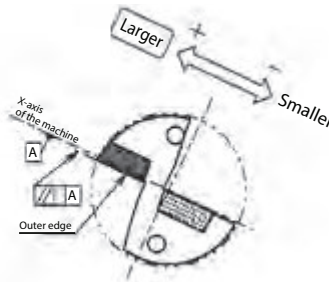

(Fig. 3) Outer insert facing down

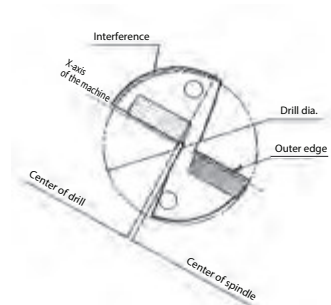

(Fig. 4) Excessive offset (For smaller hole diameter)

Center height adjustment

1. Center height of the inner insert

When installing inner insert as shown in Fig. 1, it will be set around 0.2mm below the Center of Spindle. (Fig. 5) This is the normal position of the center height and the drill is designed to be handled in this condition. However, in case that the turret of the lathe is out of the center of Spindle, sometimes the inner insert may be set above the center, or excessively below the center. For stable drilling, it is essential to check the Center Height carefully.

2. How to check the center height

For checking the center height of the inner insert, see the core which remains at the center of the end face of the drilled hole. (Fig. 6) If the center height is in the normal position, a core about 0.5mm in diameter, will remain after machining. In the following cases, it is necessary to adjust the center height.

- No core remains
- Core diameter is more than 1mm

* The drilled hole for verification purposes needs to be machined at approximately 10mm in depth and at a feed rate of 0.1mm/rev or lower.

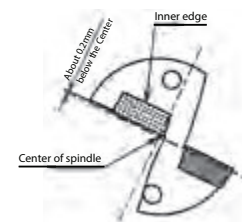

(Fig. 5) Front view of the drill

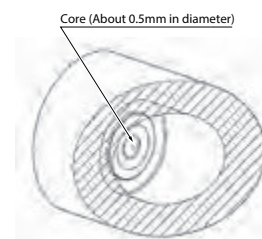

(Fig. 6) Center core

3. Center height adjustment

a) No core remains / Core with Excessively Small Diameter

This happens when the inner insert is set above the center height. In this case, adjustment is necessary since insert breakage will be probable at the center of the drill. (Fig. 7)

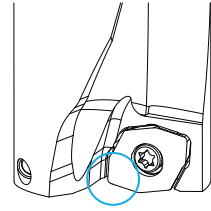

(Fig. 7) Insert breakage near the center of the drill

[How to adjust]

1. Install the drill rotated 180°. Most problems will be solved by this method. (Fig. 8)

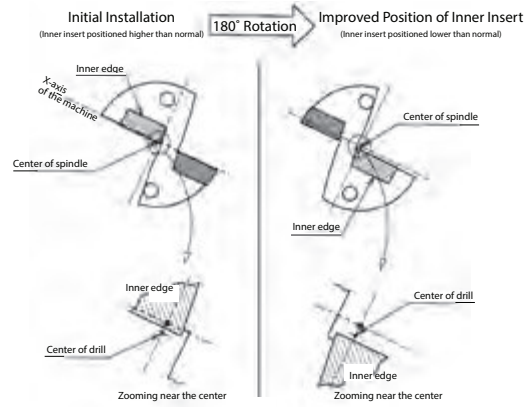

(Fig. 8)

[How to adjust]

2. If the core diameter becomes too large after the above adjustment, install the drill by rotating 90° counter-clockwise as shown in Fig. 9 (outer insert is positioned lower) and adjust the center height by moving the tool in the X-axis direction. (However, this makes it impossible to adjust the drill diameter)
 Caution: In case of installing the drill in the reverse direction (outer insert is positioned above), the hole diameter will become smaller, which may cause the drill body to interfere with the drilled hole.
 The best solution is to readjust the center position of the turret itself.

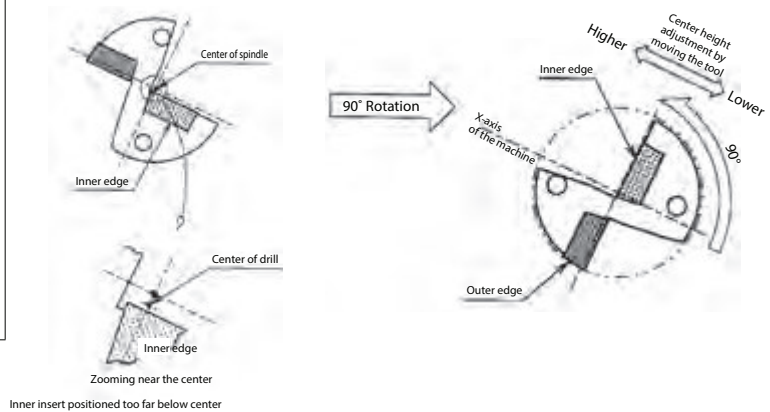

(Fig. 9)

b) Core with excessively large diameter (More than 1mm)

This occurs when the inner insert is excessively below the center. This condition causes poor chip evacuation and an adjustment is required.

[How to adjust]

- Install the drill rotating 90° as shown in Fig. 10 (outer insert is positioned on the upper side) and adjust the center height by moving tool in the X-axis direction. (However, this makes it impossible to adjust the drill diameter)
 Caution: In case of installing the drill in the opposite direction (outer insert is positioned lower), the hole diameter will become smaller, which may cause the drill body to interfere with the drilled hole.
 The best solution is to readjust the center position of the turret itself.

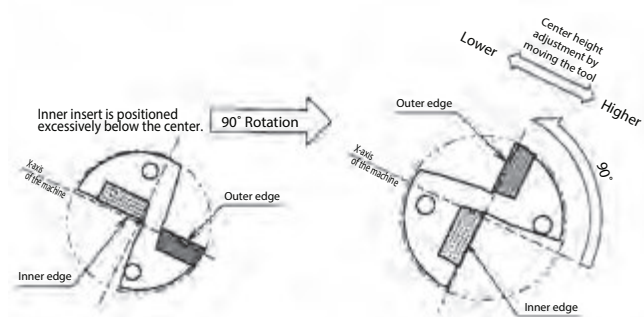

(Fig. 10)



ZXMT

		Carbon steel / Alloy steel		Mold and die steel		Stainless steel		Cast iron		Non-ferrous metals		P		M		K		N			
Insert	Description	Dimension (mm)					Angle (°)		Carbide				Applicable toolholder K92~K97								
		S	D1	RE	INSL	W1	AN	ANN	PVD												
									PR1210	PR1225	PR1230	GW15									
	General purpose / Outer edge	ZXMT 030203GM-E	2.3	2.4	0.3	6.4	4.8	7	10	●	●										
	Outer edge / Tough edge	ZXMT 030203GH-E	2.3	2.4	0.3	6.4	4.8	7	10		●									S...DRXR...M-□-03	
	Low Cutting Force / Outer edge	ZXMT 030203SM-E	2.3	2.4	0.3	6.4	4.8	7	10	●	●										
	General purpose / Inner edge	ZXMT 030203GM-I	2.3	2.4	0.3	5.9	4.8	7	10	●	●	●									
	General purpose	ZXMT 040203GM	2.6	2.4	0.3	6.2	5.1	13	10	●	●									S...DRXR...M-□-04	
		ZXMT 05T203GM	2.76	2.5	0.3	7.3	5.5	13	7	●	●									S...DRXR...M-□-05	
		ZXMT 06T204GM	2.89	2.8	0.4	8.6	6.4	13	7	●	●									S...DRXR...M-□-06	
		ZXMT 070305GM	3.24	3	0.5	10.2	8	13	7	●	●										S...DRXR...M-□-07
		ZXMT 09T306GM	4.03	3.6	0.6	12.2	9.6	13	7	●	●										S...DRXR...M-□-09
		ZXMT 11T306GM	4.06	4.6	0.6	14.5	11.6	13	7	●	●										S...DRXR...M-□-11
		ZXMT 140408GM	4.88	5.7	0.8	18	14.4	13	7	●	●										S...DRXR...M-□-14
ZXMT 170608GM	6.58	6.8	0.8	22.1	17.7	13	7	●	●										S...DRXR...M-□-17		
	Tough edge	ZXMT 040203GH	2.6	2.4	0.3	6.2	5.1	13	10		●									S...DRXR...M-□-04	
		ZXMT 05T203GH	2.76	2.5	0.3	7.3	5.5	13	7		●									S...DRXR...M-□-05	
		ZXMT 06T204GH	2.89	2.8	0.4	8.6	6.4	13	7		●									S...DRXR...M-□-06	
		ZXMT 070305GH	3.24	3	0.5	10.2	8	13	7		●										S...DRXR...M-□-07
		ZXMT 09T306GH	4.03	3.6	0.6	12.2	9.6	13	7		●										S...DRXR...M-□-09
		ZXMT 11T306GH	4.06	4.6	0.6	14.5	11.6	13	7		●										S...DRXR...M-□-11
		ZXMT 140408GH	4.88	5.7	0.8	18	14.4	13	7		●										S...DRXR...M-□-14
ZXMT 170608GH	6.58	6.8	0.8	22.1	17.7	13	7		●										S...DRXR...M-□-17		
	Low Cutting Force / for Deeper Drilling	ZXMT 040203SM	2.6	2.4	0.3	6.2	5.1	13	10	●	●									S...DRXR...M-□-04	
		ZXMT 05T203SM	2.76	2.5	0.3	7.3	5.5	13	7	●	●									S...DRXR...M-□-05	
		ZXMT 06T204SM	2.89	2.8	0.4	8.6	6.4	13	7	●	●									S...DRXR...M-□-06	
		ZXMT 070305SM	3.24	3	0.5	10.2	8	13	7	●	●										S...DRXR...M-□-07
		ZXMT 09T306SM	4.03	3.6	0.6	12.2	9.6	13	7	●	●										S...DRXR...M-□-09
		ZXMT 11T306SM	4.06	4.6	0.6	14.5	11.6	13	7	●	●										S...DRXR...M-□-11
		ZXMT 140408SM	4.88	5.7	0.8	18	14.4	13	7	●	●										S...DRXR...M-□-14
ZXMT 170608SM	6.58	6.8	0.8	22.1	17.7	13	7	●	●										S...DRXR...M-□-17		

Recommended cutting conditions K99

● : Standard item R : Right-hand only L : Left-hand only □ : Check availability

K90

K

Drilling

DRA

DRC

DRV

DRZ

DRXR

DRW

Suitable chipbreaker (ZXMT)

Workpiece material	Insert type	ZXMT											
		GM				GH				SM			
	Drilling depth	2D	3D	4D	5D	2D	3D	4D	5D	2D	3D	4D	5D
Low carbon steel		☆	☆	☆	☆					★	★	★	★
Carbon steel		★	★	★	☆	☆	☆	☆	☆	☆	☆	☆	★
Alloy steel		★	★	★	☆	☆	☆	☆	☆	☆	☆	☆	★
Mold steel		☆	☆	☆	☆	★	★	★	★				
Stainless steel										★	★	★	★
Cast iron		★	★	★	★								
Aluminum alloys										★	★	★	★
Brass										★	★	★	★
Titanium alloys										★	★	★	★

★: 1st choice ☆: 2nd choice

How to select ZXMT03

ZXMT03 (Drill dia.: $\phi 12 \sim \phi 13$.)

- For outer edge, please select "-E" insert from three different chipbreakers for each application.
- For inner edge, please select "-I" insert (GM chipbreaker only).

Outer edge

ZXMT030203 □ □ -E
GM-E GH-E SM-E

Inner edge

ZXMT030203GM-I
GM-I

Features of the chipbreaker

Chipbreaker		GM (General purpose)	GH (Tough edge)	SM (Low cutting force / For deeper drilling)
Insert				
Features		1st. recommendation for carbon steel and alloy steel, 1st. recommendation for cast iron. Good balance of sharp cutting and cutting edge strength	1st. recommendation for interrupted drilling and hard materials. Cutting edge strength oriented design. Middle to high feed rates of steel drilling, GM chipbreaker alternative.	Suitable for sticky materials such as stainless steel and low carbon steel. Low cutting force, prevents chattering. For low to medium feed rates of steel.
Outer edge side	 Wide chipbreaker	Chipbreaker cross-section 	Chipbreaker cross-section 	Chipbreaker cross-section
	Chips from outer edge			
Inner edge side	 Flat chipbreaker	Chipbreaker cross-section 	Chipbreaker cross-section 	Chipbreaker cross-section
	Chips from inner edge			
Workpiece material		C50	C50	X5CrNi18 10

DRXR (Drilling depth : 2 x DC)

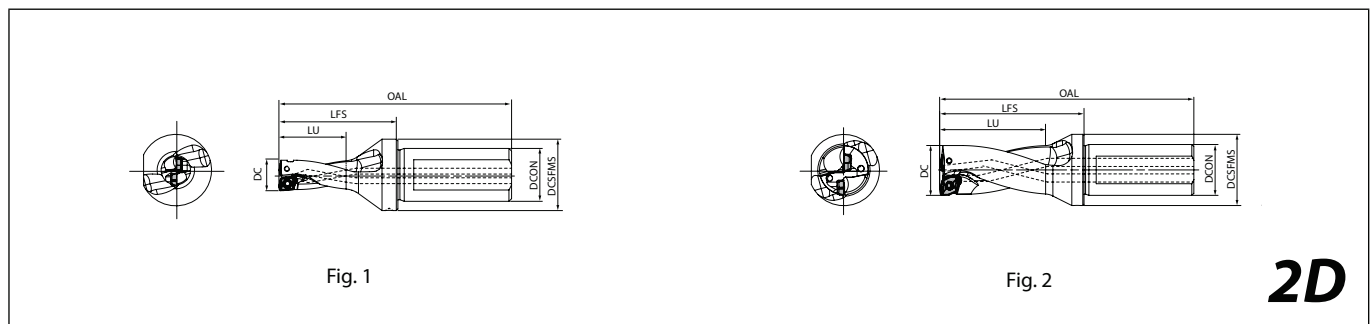

Toolholder dimensions

Description	Availability	No. of inserts	Dimension (mm)						Coolant hole	Radial offset max.	Fig.	Spare parts		Applicable inserts K90		
			DC	DCON	OAL	LFS	LU	DCSFMS				Screw	Wrench			
S20- DRXR120M-2-03 DRXR130M-2-03	●	2	12	20	88	45	24	27	Yes	+0.5	1	SB-2042TRG	FT-06-U	ZXMT030203□□-E ZXMT030203GM-I		
	●		13		90	47	26								+0.3	1
S20- DRXR140M-2-04 DRXR150M-2-04	●	2	14	20	92	49	28	27	Yes	+0.4	2	SB-2042TRG	FT-06-U	ZXMT040203□□		
	●		15		94	51	30								+0.2	2
S25- DRXR160M-2-05 DRXR170M-2-05 DRXR180M-2-05	●	2	16	25	110	56	32	32	Yes	+0.7	2	SB-2045TR	FT-06-U	ZXMT05T203□□		
	●		17		112	58	34								+0.4	2
	●		18		114	60	36								+0.2	2
S25- DRXR190M-2-06 DRXR200M-2-06 DRXR210M-2-06	●	2	19	25	113	59	38	32	Yes	+0.8	2	SB-2250TR	FT-07-U	ZXMT06T204□□		
	●		20		115	61	40								+0.5	2
	●		21		117	63	42								+0.3	2
S25- DRXR220M-2-07 DRXR230M-2-07 DRXR240M-2-07 DRXR250M-2-07 DRXR260M-2-07	●	2	22	25	119	65	44	35	Yes	+1.2	2	SB-2570TR	FT-08-U	ZXMT070305□□		
	●		23		121	67	46								+0.9	2
	●		24		123	69	48								+0.7	2
	●		25		125	71	50								+0.4	2
	●		26		127	73	52								+0.2	2
S32- DRXR270M-2-09 DRXR280M-2-09 DRXR290M-2-09 DRXR300M-2-09 DRXR310M-2-09	●	2	27	32	136	77	54	42	Yes	+1.6	2	SB-3080TR	FT-10-U	ZXMT09T306□□		
	●		28		138	79	56								+1.3	2
	●		29		140	81	58								+0.8	2
	●		30		142	83	60								+0.6	2
	●		31		144	85	62								+0.6	2
S40- DRXR320M-2-11 DRXR330M-2-11 DRXR340M-2-11 DRXR350M-2-11 DRXR360M-2-11 DRXR370M-2-11 DRXR380M-2-11	●	2	32	40	169	100	64	50	Yes	+2.2	2	SB-4085TR	FT-15-U	ZXMT11T306□□		
	●		33		171	102	66								+1.9	2
	●		34		173	104	68								+1.7	2
	●		35		175	106	70								+1.4	2
	●		36		177	108	72								+1.2	2
	●		37		179	110	74								+0.9	2
	●		38		181	112	76								+0.7	2
S40- DRXR390M-2-14 DRXR400M-2-14	●	2	39	40	179	110	78	55	Yes	+2.8	2	SB-5090TR	FT-20-U	ZXMT140408□□		
	●		40		181	112	80								+2.5	2

When offset drilling, reduce feed rate to 0.05 mm/rev or less.
See page K72 for Adjustable Sleeve (SHE).

Recommended cutting conditions **K99**
Trouble shooting **K67**

Hole diameter tolerance (2D type)

DC	Tolerance (mm)
ø12~ø26	+0.20 -0.10
ø27~ø38	+0.25 -0.15
ø39~ø40	+0.30 -0.20



* Above is numeric guideline.
It may vary depending on machines / workpieces / clamping status / cutting conditions.

● : Standard item R : Right-hand only L : Left-hand only □ : Check availability

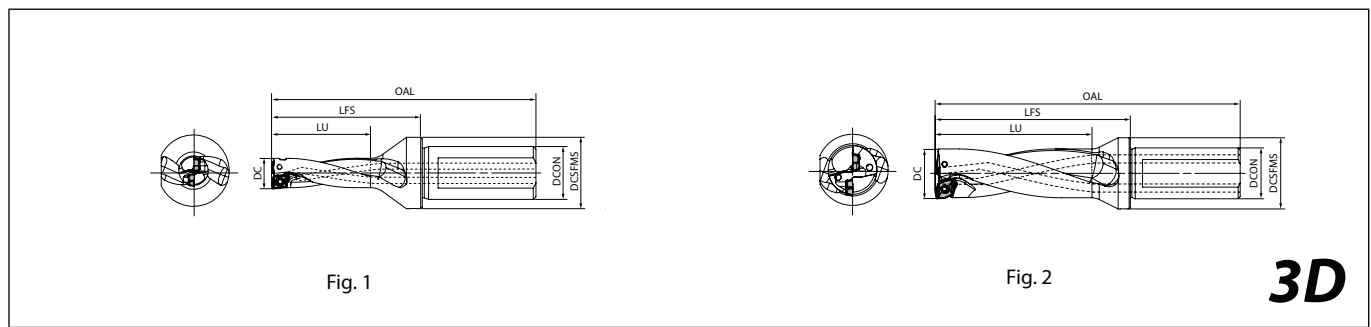
DRXR (Drilling depth : 3 x DC)



Toolholder dimensions

Description	Availability	No. of inserts	Dimension (mm)					Coolant hole	Radial offset max.	Fig.	Spare parts		Applicable inserts ● K90			
			DC	DCON	OAL	LFS	LU				DCSEMS	Screw		Wrench		
																
S20- DRXR120M-3-03 DRXR125M-3-03 DRXR130M-3-03	●	2	12	20	100	57	36	27	Yes	+0.5	1	SB-2042TRG	FT-06-U	ZXMT030203□□-E ZXMT030203GM-I		
	●		12.5		102	59	37.5								+0.4	1
	●		13		103	60	39								+0.3	1
S20- DRXR135M-3-04 DRXR140M-3-04 DRXR145M-3-04 DRXR150M-3-04	●	2	13.5	20	105	62	40.5	27	Yes	+0.5	2	SB-2042TRG	FT-06-U	ZXMT040203□□		
	●		14		106	63	42								+0.4	2
	●		14.5		108	65	43.5								+0.3	2
	●		15		109	66	45								+0.2	2
S25- DRXR155M-3-05 DRXR160M-3-05 DRXR165M-3-05 DRXR170M-3-05 DRXR175M-3-05 DRXR180M-3-05	●	2	15.5	25	124	70	46.5	32	Yes	+0.8	2	SB-2045TR	FT-06-U	ZXMT05T203□□		
	●		16		126	72	48								+0.7	2
	●		16.5		127	73	49.5								+0.5	2
	●		17		129	75	51								+0.4	2
	●		17.5		130	76	52.5								+0.3	2
	●		18		132	78	54								+0.2	2
S25- DRXR185M-3-06 DRXR190M-3-06 DRXR195M-3-06 DRXR200M-3-06 DRXR205M-3-06 DRXR210M-3-06 DRXR215M-3-06	●	2	18.5	25	131	77	55.5	32	Yes	+0.9	2	SB-2250TR	FT-07-U	ZXMT06T204□□		
	●		19		132	78	57								+0.8	2
	●		19.5		134	80	58.5								+0.7	2
	●		20		135	81	60								+0.5	2
	●		20.5		137	83	61.5								+0.4	2
	●		21		138	84	63								+0.3	2
	●		21.5		140	86	64.5								+0.2	2
S25- DRXR220M-3-07 DRXR225M-3-07 DRXR230M-3-07 DRXR235M-3-07 DRXR240M-3-07 DRXR245M-3-07 DRXR250M-3-07 DRXR255M-3-07 DRXR260M-3-07	●	2	22	25	141	87	66	35	Yes	+1.2	2	SB-2570TR	FT-08-U	ZXMT070305□□		
	●		22.5		142	88	67.5								+1	2
	●		23		144	90	69								+0.9	2
	●		23.5		145	91	70.5								+0.8	2
	●		24		147	93	72								+0.7	2
	●		24.5		148	94	73.5								+0.5	2
	●		25		150	96	75								+0.4	2
	●		25.5		151	97	76.5								+0.3	2
	●		26		153	99	78								+0.2	2

When offset drilling, reduce feed rate to 0.05 mm/rev or less.
See page K72 for Adjustable Sleeve (SHE).

Recommended cutting conditions ● K99
Trouble shooting ● K67

Hole diameter tolerance (3D type)

DC	Tolerance (mm)
ø12~ø26	+0.20 -0.10
ø26.5~ø38	+0.25 -0.15
ø39~ø60	+0.30 -0.20



* Above is numeric guideline.
It may vary depending on machines / workpieces / clamping status / cutting conditions.

● : Standard item R : Right-hand only L : Left-hand only □ : Check availability



Toolholder dimensions

3xDC

Description	Availability	No. of inserts	Dimension (mm)						Coolant hole	Radial offset max.	Fig.	Spare parts		Applicable inserts ● K90			
			DC	DCON	OAL	LFS	LU	DCSFMS				Screw	Wrench				
																	
S32- DRXR265M-3-09 DRXR270M-3-09 DRXR275M-3-09 DRXR280M-3-09 DRXR285M-3-09 DRXR290M-3-09 DRXR295M-3-09 DRXR300M-3-09 DRXR305M-3-09 DRXR310M-3-09 DRXR315M-3-09	●	2	26.5	32	161	102	79.5	42	Yes	2	+1.7	2	SB-3080TR	FT-10-U	ZXMT09T306□		
	●		27		163	104	81									+1.6	2
	●		27.5		164	105	82.5									+1.5	2
	●		28		166	107	84									+1.3	2
	●		28.5		167	108	85.5									+1.2	2
	●		29		169	110	87									+1.1	2
	●		29.5		170	111	88.5									+0.8	2
	●		30		172	113	90									+0.7	2
	●		30.5		173	114	91.5									+0.6	2
	●		31		175	116	93									+0.5	2
	●		31.5		176	117	94.5										
	S40- DRXR320M-3-11 DRXR330M-3-11 DRXR340M-3-11 DRXR350M-3-11 DRXR360M-3-11 DRXR370M-3-11 DRXR380M-3-11		●		2	32	40									201	132
●		33	204	135		99		+1.9	2								
●		34	207	138		102		+1.7	2								
●		35	210	141		105		+1.4	2								
●		36	213	144		108		+1.2	2								
●		37	216	147		111		+0.9	2								
●		38	219	150		114		+0.7	2								
S40- DRXR390M-3-14 DRXR400M-3-14 DRXR450M-3-14	●	2	39	40	218	149	117	55	Yes	2	+2.8	2	SB-5090TR	FT-20-U	ZXMT140408□		
	●		40		221	152	120									+2.5	2
	●		45		236	167	135									+1.3	2
S40- DRXR500M-3-17 DRXR550M-3-17 DRXR600M-3-17	●	2	50	60	248	179	150	64	Yes	2	+3.3	2	SB-60120TR	FT-25-U	ZXMT170608□		
	●		55		263	194	165									+2	2
	●		60		278	209	180									+0.6	2

When offset drilling, reduce feed rate to 0.05 mm/rev or less.
See page K72 for Adjustable Sleeve (SHE).

Recommended cutting conditions ● K99
Trouble shooting ● K67

Hole diameter tolerance (3D type)

DC	Tolerance (mm)
ø12~ø26	+0.20 -0.10
ø26.5~ø38	+0.25 -0.15
ø39~ø60	+0.30 -0.20

* Above is numeric guideline.
It may vary depending on machines / workpieces / clamping status / cutting conditions.



Drilling



DRA
DRC
DRV
DRZ
DRXR
DRW

● : Standard item R : Right-hand only L : Left-hand only □ : Check availability

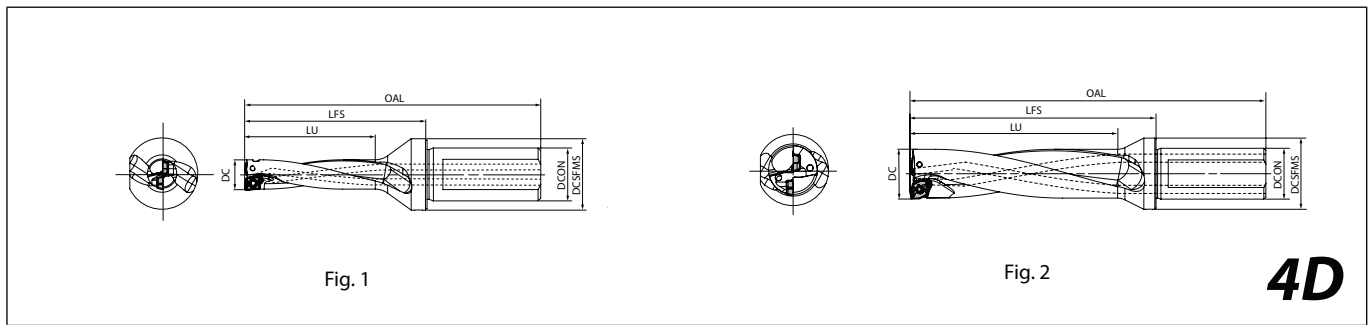
DRXR (Drilling depth : 4 x DC)



Toolholder dimensions

Description	Availability	No. of inserts	Dimension (mm)					Coolant hole	Radial offset max.	Fig.	Spare parts		Applicable inserts ● K90			
			DC	DCON	OAL	LFS	LU				DC5FMS	Screw		Wrench		
																
S20- DRXR120M-4-03 DRXR125M-4-03 DRXR130M-4-03	●	2	12	20	112	69	48	27	Yes	+0.5	1	SB-2042TRG	FT-06-U	ZXMT030203□□-E ZXMT030203GM-I		
	●		12.5		114	71	50								+0.4	1
	●		13		116	73	52								+0.3	1
S20- DRXR135M-4-04 DRXR140M-4-04 DRXR145M-4-04 DRXR150M-4-04	●	2	13.5	20	118	75	54	27	Yes	+0.5	2	SB-2042TRG	FT-06-U	ZXMT040203□□		
	●		14		120	77	56								+0.4	2
	●		14.5		122	79	58								+0.3	2
	●		15		124	81	60								+0.2	2
S25- DRXR155M-4-05 DRXR160M-4-05 DRXR165M-4-05 DRXR170M-4-05 DRXR175M-4-05 DRXR180M-4-05	●	2	15.5	25	140	86	62	32	Yes	+0.8	2	SB-2045TR	FT-06-U	ZXMT05T203□□		
	●		16		142	88	64								+0.7	2
	●		16.5		144	90	66								+0.5	2
	●		17		146	92	68								+0.4	2
	●		17.5		148	94	70								+0.3	2
	●		18		150	96	72								+0.2	2
S25- DRXR185M-4-06 DRXR190M-4-06 DRXR195M-4-06 DRXR200M-4-06 DRXR205M-4-06 DRXR210M-4-06 DRXR215M-4-06	●	2	18.5	25	149	95	74	32	Yes	+0.9	2	SB-2250TR	FT-07-U	ZXMT06T204□□		
	●		19		151	97	76								+0.8	2
	●		19.5		153	99	78								+0.7	2
	●		20		155	101	80								+0.5	2
	●		20.5		157	103	82								+0.4	2
	●		21		159	105	84								+0.3	2
	●		21.5		161	107	86								+0.2	2

When offset drilling, reduce feed rate to 0.05 mm/rev or less.
See page K72 for Adjustable Sleeve (SHE).

Recommended cutting conditions ● K99
Trouble shooting ● K67

Hole diameter tolerance (4D type)

DC	Tolerance (mm)
ø12~ø26	+0.25 -0.10
ø27~ø38	+0.30 -0.15
ø39~ø60	+0.35 -0.20

* Above is numeric guideline.
It may vary depending on machines / workpieces / clamping status / cutting conditions.

● : Standard item R : Right-hand only L : Left-hand only □ : Check availability



Toolholder dimensions

4xDC

Description	Availability	No. of inserts	Dimension (mm)					DCSFMS	Coolant hole	Radial offset max.	Fig.	Spare parts		Applicable inserts K90
			DC	DCON	OAL	LFS	LU					Screw	Wrench	
S25- DRXR220M-4-07 DRXR225M-4-07 DRXR230M-4-07 DRXR235M-4-07 DRXR240M-4-07 DRXR245M-4-07 DRXR250M-4-07 DRXR255M-4-07 DRXR260M-4-07	●	2	22	25	163	109	88	35	Yes	+1.2	2	SB-2570TR	FT-08-U	ZXMT070305□
	●		22.5		165	111	90			+1	2			
	●		23		167	113	92			+0.9	2			
	●		23.5		169	115	94			+0.8	2			
	●		24		171	117	96			+0.7	2			
	●		24.5		173	119	98			+0.5	2			
	●		25		175	121	100			+0.4	2			
	●		25.5		177	123	102			+0.3	2			
	●		26		179	125	104			+0.2	2			
S32- DRXR270M-4-09 DRXR280M-4-09 DRXR290M-4-09 DRXR300M-4-09 DRXR310M-4-09	●	2	27	32	190	131	108	42	Yes	+1.6	2	SB-3080TR	FT-10-U	ZXMT09T306□
	●		28		194	135	112			+1.3	2			
	●		29		198	139	116			+1.1	2			
	●		30		202	143	120			+0.8	2			
	●		31		206	147	124			+0.6	2			
S40- DRXR320M-4-11 DRXR330M-4-11 DRXR340M-4-11 DRXR350M-4-11 DRXR360M-4-11 DRXR370M-4-11 DRXR380M-4-11	●	2	32	40	223	154	128	50	Yes	+2.2	2	SB-4085TR	FT-15-U	ZXMT11T306□
	●		33		227	158	132			+1.9	2			
	●		34		231	162	136			+1.7	2			
	●		35		235	166	140			+1.4	2			
	●		36		239	170	144			+1.2	2			
	●		37		243	174	148			+0.9	2			
	●		38		247	178	152			+0.7	2			
	●		39		251	182	156			+0.5	2			
S40- DRXR390M-4-14 DRXR400M-4-14	●	2	39	40	257	188	156	55	Yes	+2.8	2	SB-5090TR	FT-20-U	ZXMT140408□
	●		40		261	192	160			+2.5	2			

When offset drilling, reduce feed rate to 0.05 mm/rev or less.

See page K72 for Adjustable Sleeve (SHE).

Recommended cutting conditions K99

Trouble shooting K67

Hole diameter tolerance (4D type)

DC	Tolerance (mm)
ø12~ø26	+0.25 -0.10
ø27~ø38	+0.30 -0.15
ø39~ø60	+0.35 -0.20

* Above is numeric guideline.

It may vary depending on machines / workpieces / clamping status / cutting conditions.

● : Standard item R : Right-hand only L : Left-hand only □ : Check availability



- DRA
- DRC
- DRV
- DRZ
- DRXR
- DRW

DRXR (Drilling depth : 5 x DC)

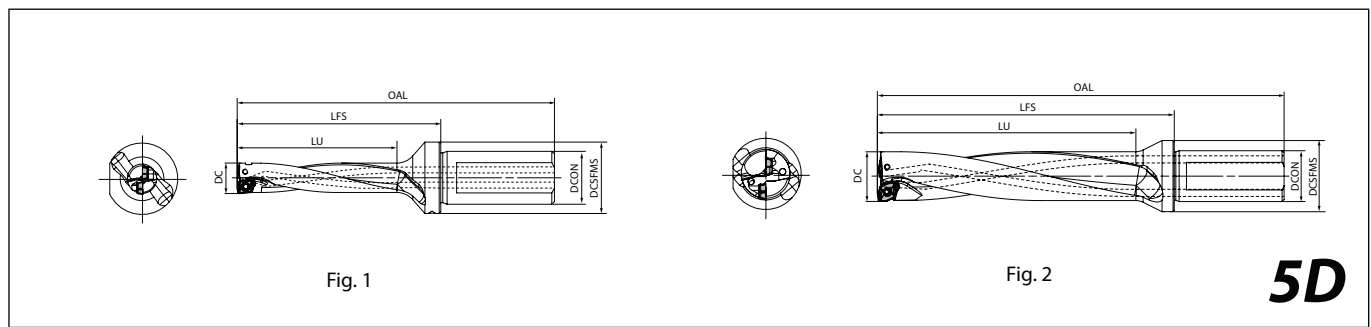

Toolholder dimensions

Description	Availability	No. of inserts	Dimension (mm)						Coolant hole	Radial offset max.	Fig.	Spare parts		Applicable inserts ● K90		
			DC	DCON	OAL	LFS	LU	DCSFMS				Screw	Wrench			
															Fig.	Applicable inserts
S20- DRXR120M-5-03 DRXR130M-5-03	●	2	12	20	120	77	60	27	Yes	+0.5	1	SB-2042TRG	FT-06-U	ZXMT030203□□-E ZXMT030203GM-I		
	●															
S20- DRXR140M-5-04 DRXR150M-5-04	●	2	14	20	134	91	70	27	Yes	+0.4	2	SB-2042TRG	FT-06-U	ZXMT040203□□		
	●		15		139	96	75								+0.2	2
S25- DRXR160M-5-05 DRXR170M-5-05 DRXR180M-5-05	●	2	16	25	158	104	80	32	Yes	+0.7	2	SB-2045TR	FT-06-U	ZXMT05T203□□		
	●		17		163	109	85								+0.4	2
	●		18		168	114	90								+0.2	2
S25- DRXR190M-5-06 DRXR200M-5-06 DRXR210M-5-06	●	2	19	25	170	116	95	32	Yes	+0.8	2	SB-2250TR	FT-07-U	ZXMT06T204□□		
	●		20		175	121	100								+0.5	2
	●		21		180	126	105								+0.3	2
S25- DRXR220M-5-07 DRXR230M-5-07 DRXR240M-5-07 DRXR250M-5-07 DRXR260M-5-07	●	2	22	25	185	131	110	35	Yes	+1.2	2	SB-2570TR	FT-08-U	ZXMT070305□□		
	●		23		190	136	115								+0.9	2
	●		24		195	141	120								+0.7	2
	●		25		200	146	125								+0.4	2
	●		26		205	151	130								+0.2	2
S32- DRXR270M-5-09 DRXR280M-5-09 DRXR290M-5-09 DRXR300M-5-09 DRXR310M-5-09	●	2	27	32	217	158	135	42	Yes	+1.6	2	SB-3080TR	FT-10-U	ZXMT09T306□□		
	●		28		222	163	140								+1.3	2
	●		29		227	168	145								+1.1	2
	●		30		232	173	150								+0.8	2
	●		31		237	178	155								+0.6	2
S40- DRXR320M-5-11 DRXR330M-5-11 DRXR340M-5-11 DRXR350M-5-11 DRXR360M-5-11 DRXR370M-5-11 DRXR380M-5-11	●	2	32	40	255	186	160	50	Yes	+2.2	2	SB-4085TR	FT-15-U	ZXMT11T306□□		
	●		33		260	191	165								+1.9	2
	●		34		265	196	170								+1.7	2
	●		35		270	201	175								+1.4	2
	●		36		275	206	180								+1.2	2
	●		37		280	211	185								+0.9	2
	●		38		285	216	190								+0.7	2
S40- DRXR390M-5-14 DRXR400M-5-14	●	2	39	40	296	227	195	55	Yes	+2.8	2	SB-5090TR	FT-20-U	ZXMT140408□□		
	●		40		301	232	200								+2.5	2

When offset drilling, reduce feed rate to 0.05 mm/rev or less.
See page K72 for Adjustable Sleeve (SHE).

Recommended cutting conditions ● K99
Trouble shooting ● K67

Hole diameter tolerance (5D type)

DC	Tolerance (mm)
ø12~ø26	+0.30 -0.10
ø27~ø38	+0.35 -0.15
ø39~ø60	+0.40 -0.20

● : Standard item R : Right-hand only L : Left-hand only □ : Check availability



MagicDrill DRXR hole bottom shape (mm)

DC	A	B	C	DC	A	B	C	DC	A	B	C
12.0	1.8	4.2	0.5	24.5	3.2	9.1	0.8	39.0	5.8	13.7	1.5
12.5		4.5		25.0		9.3		40.0		14.2	
13.0		4.7		25.5		9.6		41.0		14.7	
13.5	2	4.8	0.5	26.0	3.9	9.8	1.0	42.0	7.1	15.2	1.6
14.0		5.0		26.5		9.4		43.0		15.7	
14.5		5.3		27.0		9.6		44.0		16.2	
15.0		5.5		27.5		9.9		45.0		16.7	
15.5		5.8	0.6	28.0	10.1	46.0	17.2				
16.0		6.0		28.5	10.4	47.0	17.7				
16.5		6.3		29.0	10.6	48.0	16.9				
17.0	2.4	6.5	0.7	29.5	4.7	10.9	1.1	49.0	7.1	17.4	1.7
17.5		6.8		30.0		11.1		50.0		17.9	
18.0		7.0		30.5		11.4		51.0		18.4	
18.5		6.9	0.7	31.0	11.6	52.0	18.9				
19.0		7.1		31.5	11.9	53.0	19.4				
19.5		7.4		32.0	11.3	54.0	19.9				
20.0		7.6		33.0	11.8	55.0	20.4				
20.5		7.9	0.8	34.0	12.3	56.0	20.9				
21.0		8.1		35.0	12.8	57.0	21.4				
21.5		8.4		36.0	13.3	58.0	21.9				
22.0	3.2	7.8	0.8	37.0	4.7	13.8	1.2	59.0	7.1	22.4	1.8
22.5		8.1		38.0		14.3		60.0		22.9	
23.0		8.3		37.0		13.8		59.0		22.4	
23.5		8.6		36.0		13.3		58.0		21.9	
24.0		8.8									

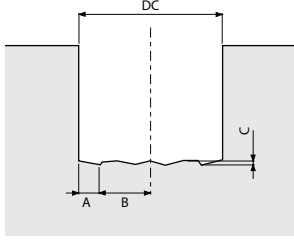

Common for 2D, 3D, 4D, 5D
 * Above is numeric guideline. (Varies within ±0.1mm depending on workpiece materials and cutting conditions)



Drilling

- DRA
- DRC
- DRV
- DRZ
- DRXR**
- DRW

Recommended cutting conditions (Coolant)

Workpiece material	Recommended insert grades (Cutting speed Vc: m/min)				Drill dia. DC (mm)	Toolholder type									
	MEGACOAT			Carbide		2D~3D			4D			5D			
	PR1230	PR1225	PR1210	GW15		f (mm/rev)									
	GM GH	SM	GM	SM		GM	GH	SM	GM	GH	SM	GM	GH	SM	
Low carbon steel	☆ 120-240	★ 120-240			ø12~ø15	0.06~0.10	0.06~0.10	0.04~0.10	0.05~0.08	0.05~0.08	0.04~0.08	0.04~0.07	0.04~0.07	0.04~0.08	
					ø15.5~ø18	0.06~0.12	0.06~0.12	0.06~0.12	0.05~0.10	0.05~0.10	0.05~0.10	0.05~0.08	0.05~0.08	0.05~0.08	0.04~0.09
					ø18.5~ø26	0.08~0.14	0.08~0.14	0.06~0.14	0.06~0.12	0.08~0.12	0.05~0.12	0.06~0.10	0.06~0.10	0.06~0.10	0.04~0.10
					ø26.5~ø60	0.08~0.14	0.08~0.14	0.06~0.14	0.06~0.12	0.08~0.12	0.05~0.12	0.06~0.10	0.06~0.10	0.06~0.10	0.04~0.10
Carbon steel	★ 100-180	☆ 100-180			ø12~ø15	0.04~0.14	0.04~0.14	0.04~0.10	0.04~0.10	0.04~0.10	0.04~0.08	0.04~0.08	0.04~0.08	0.04~0.07	
					ø15.5~ø18	0.06~0.16	0.06~0.16	0.06~0.12	0.05~0.12	0.05~0.12	0.05~0.10	0.05~0.10	0.05~0.10	0.05~0.08	
					ø18.5~ø26	0.08~0.20	0.08~0.20	0.06~0.14	0.07~0.16	0.07~0.16	0.05~0.12	0.06~0.12	0.06~0.12	0.06~0.12	0.05~0.10
					ø26.5~ø60	0.08~0.20	0.08~0.20	0.06~0.14	0.07~0.16	0.07~0.16	0.05~0.12	0.06~0.12	0.06~0.12	0.06~0.12	0.05~0.10
Alloy steel	★ 100-160	☆ 100-160			ø12~ø15	0.04~0.14	0.04~0.14	0.04~0.10	0.04~0.10	0.04~0.10	0.04~0.08	0.04~0.08	0.04~0.08	0.04~0.07	
					ø15.5~ø18	0.06~0.16	0.06~0.16	0.06~0.12	0.05~0.12	0.05~0.12	0.05~0.10	0.05~0.10	0.05~0.10	0.05~0.08	
					ø18.5~ø26	0.08~0.20	0.08~0.20	0.06~0.14	0.07~0.16	0.07~0.16	0.05~0.12	0.06~0.12	0.06~0.12	0.06~0.12	0.05~0.10
					ø26.5~ø60	0.08~0.20	0.08~0.20	0.06~0.14	0.07~0.16	0.07~0.16	0.05~0.12	0.06~0.12	0.06~0.12	0.06~0.12	0.05~0.10
Mold steel	★ 80-150	☆ 80-150			ø12~ø15	0.04~0.08	0.04~0.08	0.04~0.08	0.04~0.07	0.04~0.07	0.04~0.07	0.04~0.06	0.04~0.06	0.04~0.06	
					ø15.5~ø18	0.06~0.12	0.06~0.12	0.06~0.10	0.05~0.10	0.05~0.10	0.05~0.08	0.04~0.08	0.04~0.08	0.04~0.07	
					ø18.5~ø26	0.08~0.15	0.08~0.15	0.06~0.12	0.06~0.12	0.06~0.12	0.06~0.10	0.05~0.10	0.05~0.10	0.05~0.08	
					ø26.5~ø60	0.08~0.15	0.08~0.15	0.06~0.12	0.06~0.12	0.06~0.12	0.06~0.10	0.05~0.10	0.05~0.10	0.05~0.08	
Stainless steel (Austenitic related)	☆ 70-140	★ 70-140			ø12~ø15	0.06~0.10	0.06~0.10	0.04~0.10	0.05~0.08	0.05~0.08	0.04~0.08	0.04~0.07	0.04~0.08	0.04~0.08	
					ø15.5~ø18	0.06~0.10	0.06~0.10	0.06~0.12	0.05~0.08	0.05~0.08	0.05~0.11	0.04~0.07	0.04~0.07	0.04~0.10	
					ø18.5~ø26	0.08~0.12	0.08~0.12	0.06~0.14	0.07~0.10	0.07~0.10	0.06~0.12	0.07~0.10	0.07~0.10	0.06~0.12	
					ø26.5~ø60	0.08~0.12	0.08~0.12	0.06~0.14	0.07~0.10	0.07~0.10	0.06~0.12	0.07~0.10	0.07~0.10	0.06~0.12	
Gray cast iron			★ 100-150		ø12~ø15	0.08~0.14	-	-	0.06~0.12	-	-	0.04~0.10	-	-	
					ø15.5~ø18	0.08~0.18	-	-	0.08~0.16	-	-	0.06~0.12	-	-	
					ø18.5~ø26	0.08~0.20	-	-	0.08~0.18	-	-	0.06~0.14	-	-	
					ø26.5~ø60	0.08~0.20	-	-	0.08~0.18	-	-	0.06~0.14	-	-	
Nodular cast iron			★ 80-120		ø12~ø15	0.08~0.12	-	-	0.06~0.10	-	-	0.04~0.08	-	-	
					ø15.5~ø18	0.08~0.16	-	-	0.08~0.14	-	-	0.06~0.10	-	-	
					ø18.5~ø26	0.08~0.18	-	-	0.08~0.16	-	-	0.06~0.12	-	-	
					ø26.5~ø60	0.08~0.18	-	-	0.08~0.16	-	-	0.06~0.12	-	-	
Non-ferrous metals			★ 200-600		ø12~ø15	-	-	0.06~0.12	-	-	0.05~0.10	-	-	0.04~0.08	
					ø15.5~ø18	-	-	0.08~0.14	-	-	0.06~0.12	-	-	0.05~0.10	
					ø18.5~ø26	-	-	0.08~0.16	-	-	0.06~0.14	-	-	0.05~0.12	
					ø26.5~ø60	-	-	0.08~0.20	-	-	0.08~0.16	-	-	0.07~0.14	
Titanium alloys			★ 40-70		ø12~ø15	-	-	0.05~0.08	-	-	0.04~0.07	-	-	0.04~0.06	
					ø15.5~ø18	-	-	0.05~0.08	-	-	0.04~0.07	-	-	0.04~0.06	
					ø18.5~ø26	-	-	0.06~0.10	-	-	0.06~0.08	-	-	0.05~0.07	
					ø26.5~ø60	-	-	0.06~0.10	-	-	0.06~0.08	-	-	0.05~0.07	

Apply a sufficient amount of coolant.

★: 1st recommendation ☆: 2nd recommendation

Cutting conditions by application

Applications		Plain surface	Slant surface	Half cylindrical	Hole expansion	Concave surface	Cored hole*	Stacked plates
Shape of workpiece								
DRX	Cutting speed Vc (m/min)	120	120	120	120	120	120	Not available
	f (mm/rev)	0.1	0.05	0.05	0.05	Concave surface 0.05 Continuous Part 0.1	0.05	Not available
Coolant (Internal)		Yes	Yes	Yes	Yes	Yes	Yes	Not available

* Cutting width (Torus-shaped part) when drilling cored hole.

Drill type	2D~3D	4D	5D
Cutting width (Torus-shaped part)	0.1 x DC or less	Corner radius or less	Not recommended

Max. depth for drilling with external coolant

In case of using external coolant system, chip evacuation will be bad.
Therefore ap should be measured within 1.5 times (1.5 x DC) of drill diameter (DC).



Large diameter indexable drill

MagicDrill DRW

Sharp cutting and enhanced chip evacuation.
Superior fracture resistance and long tool life with
MEGACOAT NANO PR1535 grade.



Applicable diameter: $\phi 60 \sim \phi 100$ mm

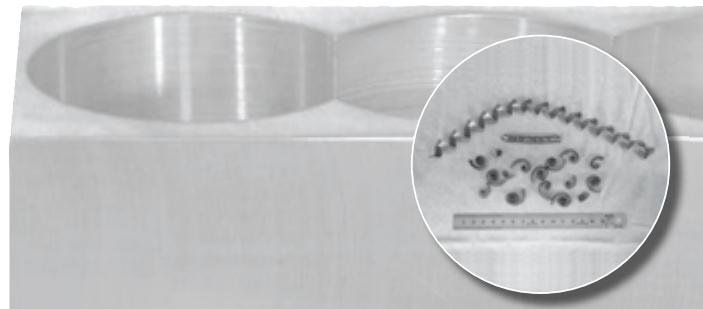

Drilling depth: 1D, 2D, 3D

Use single type of insert.

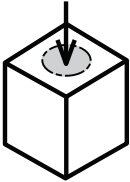
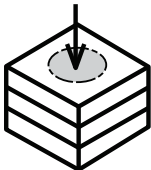
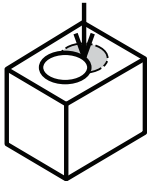

K

Applicable workpiece



Plain surface	Stacked plates	Hole expansion	Slant surface
			

* Hole expansion: Overlap amount of through hole must be 0.2 x DC or less.
Expansion of blind holes is not possible because chips are built up in the next hole and will cause chip biting.

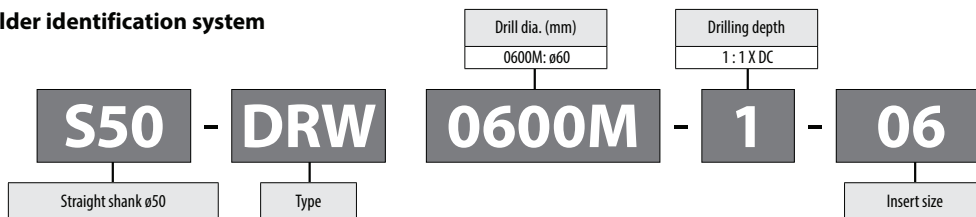
Toolholder identification system

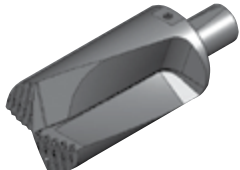

DRW custom-order item (Applicable drill diameter: $\phi 22 \sim \phi 200$ mm)

 BT integral arbor type is also available.	 Max. $\phi 200$ is applicable	 Standard item Straight shank (1D~3D)
--	--	--

WCMT

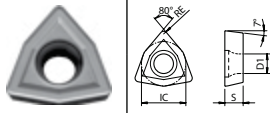
		Carbon steel / Alloy steel		●		P					
		Mold and die steel		●							
		Stainless steel		● ○		M					
		Cast iron		●		K					
		Non-ferrous metals				N					
Insert	Description	No. of edges	Dimension (mm)				Carbide			Applicable toolholder ● K102~K105	
			IC	S	D1	RE	CVD	PVD			
								CA6535	PR1230	PR1535	
	WCMT 050308	3	7.94	3.18	3.2	0.8	●				-
	WCMT 06T308	3	9.525	3.97	3.7	0.8	●	●	●		K102S50-DRW...06



● : Standard item R : Right-hand only L : Left-hand only □ : Check availability

DRW

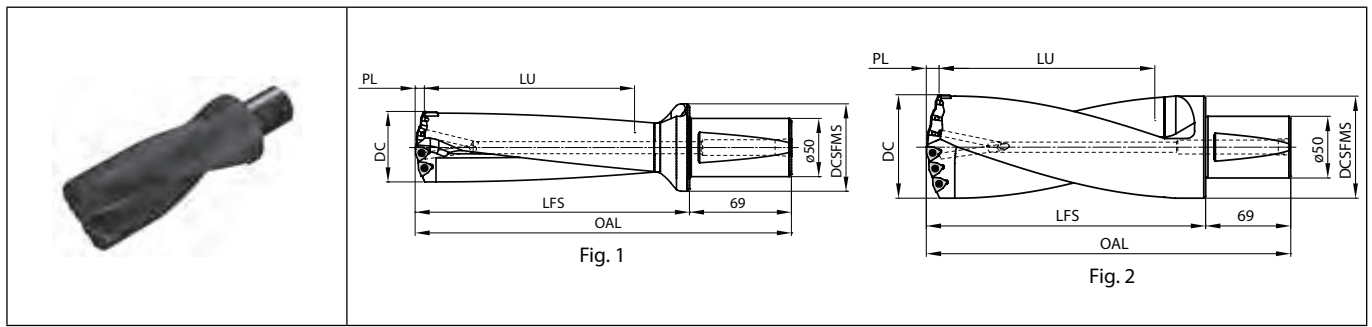

Toolholder dimensions (Drilling depth : 1 x DC)

Description	Availability	No. of inserts	Dimension (mm)						Coolant hole	Fig.	Spare parts		Applicable inserts K101	
			DC	OAL	LFS	LU	DCSFMS	PL			Screw	Wrench		
S50- DRW0600M-1-06	MTO	4	60	175	106	60	63	7.6	Yes	2	SB-3592TR	DT-10	WCMT06T308	
DRW0610M-1-06	MTO		61	176	107	61		7.7						
DRW0620M-1-06	MTO		62	178	109	62		7.8						
DRW0630M-1-06	MTO		63	179	110	63		7.9						
DRW0640M-1-06	MTO		64	182	113	64		8						
DRW0650M-1-06	MTO		65	184	115	65		8.2						
DRW0660M-1-06	MTO		66	185	116	66	64	8.3						2
DRW0670M-1-06	MTO		67	187	118	67	65	8.4						2
DRW0680M-1-06	MTO		68	189	120	68	66	8.5						2
DRW0690M-1-06	MTO		69	190	121	69	67	8.6						2
DRW0700M-1-06	MTO		70	192	123	70	68	8.7						2
DRW0710M-1-06	MTO		71	193	124	71	69	8.8						2
DRW0720M-1-06	MTO		72	195	126	72	70	9						2
DRW0730M-1-06	MTO		73	198	129	73	71	9.1						2
DRW0740M-1-06	MTO		74	199	130	74	72	9.2						2
S50- DRW0750M-1-06	MTO		6	75	201	132	75	73						9.3
DRW0760M-1-06	MTO	76		203	134	76	74	9.4						
DRW0770M-1-06	MTO	77		204	135	77	75	9.5						
DRW0780M-1-06	MTO	78		206	137	78	76	9.7						
DRW0790M-1-06	MTO	79		207	138	79	77	9.8						
DRW0800M-1-06	MTO	80				80	78							
DRW0810M-1-06	MTO	81		208	139	81	79	9.9	2					
DRW0820M-1-06	MTO	82		210	141	82	80							
DRW0830M-1-06	MTO	83				83	81							
DRW0840M-1-06	MTO	84				84	82							



Offset Drilling

Offset for DRW should be 0 ~ +0.15 mm in radius (0 ~ +0.3 mm in diameter).

Do not set it to a negative value to make the diameter smaller.

● : Standard item R : Right-hand only L : Left-hand only □ : Check availability MTO : Made to order

Toolholder dimensions (Drilling depth : 1 x DC)

Description	Availability	No. of inserts	Dimension (mm)						Coolant hole	Fig.	Spare parts		Applicable inserts ➔ K101
			DC	OAL	LFS	LU	DCSFMS	PL			Screw	Wrench	
													
S50- DRW0850M-1-06	MTO	6	85	211	142	85	83	Yes	2	SB-3592TR	DT-10	WCMT06T308	
DRW0860M-1-06	MTO		86	213	144	86	84						
DRW0870M-1-06	MTO		87	215	146	87	85						
DRW0880M-1-06	MTO		88	216	147	88	86						
DRW0890M-1-06	MTO		89	218	149	89	87						
DRW0900M-1-06	MTO		90	219	150	90	88						
DRW0910M-1-06	MTO		91	220	151	91	89						
DRW0920M-1-06	MTO		92	222	153	92	90						
DRW0930M-1-06	MTO		93	223	154	93	91						
DRW0940M-1-06	MTO		94	225	156	94	92						
DRW0950M-1-06	MTO		95	226	157	95	93						
DRW0960M-1-06	MTO		96	228	159	96	94						
DRW0970M-1-06	MTO		97			97	95						
DRW0980M-1-06	MTO		98	230	161	98	96						
DRW0990M-1-06	MTO		99	231	162	99	97						
DRW1000M-1-06	MTO		100	232	163	100	98						



Offset Drilling

Offset for DRW should be 0 ~ +0.15 mm in radius (0 ~ +0.3 mm in diameter).

Do not set it to a negative value to make the diameter smaller.



Toolholder dimensions (Drilling depth : 2 x DC)

Description	Availability	No. of inserts	Dimension (mm)						Coolant hole	Fig.	Spare parts		Applicable inserts K101
			DC	OAL	LFS	LU	DCSFMS	PL			Screw	Wrench	
													
S50- DRW0600M-2-06	●	4	60	235	166	120	63	7.6	Yes	SB-3592TR	DT-10	WCMT06T308	
DRW0610M-2-06	MTO		61	237	168	122		7.7					
DRW0620M-2-06	MTO		62	240	171	124		7.8					
DRW0630M-2-06	MTO		63	242	173	126		7.9					
DRW0640M-2-06	MTO		64	246	177	128		8					
DRW0650M-2-06	●		65	249	180	130		8.2					
DRW0660M-2-06	MTO		66	251	182	132	64	8.3					
DRW0670M-2-06	MTO		67	254	185	134	65	8.4					
DRW0680M-2-06	MTO		68	257	188	136	66	8.5					
DRW0690M-2-06	MTO		69	259	190	138	67	8.6					
DRW0700M-2-06	●		70	262	193	140	68	8.7					
DRW0710M-2-06	MTO		71	264	195	142	69	8.8					
DRW0720M-2-06	MTO		72	267	198	144	70	9					
DRW0730M-2-06	MTO		73	271	202	146	71	9.1					
DRW0740M-2-06	●		74	273	204	148	72	9.2					
S50- DRW0750M-2-06	●		6	75	276	207	150	73					9.3
DRW0760M-2-06	MTO	76		279	210	152	74	9.4					
DRW0770M-2-06	MTO	77		281	212	154	75	9.5					
DRW0780M-2-06	MTO	78		284	215	156	76	9.7					
DRW0790M-2-06	MTO	79		286	217	158	77	9.8					
DRW0800M-2-06	●	80		287	218	160	78	9.9	2				
DRW0810M-2-06	MTO	81		289	220	162	79		2				
DRW0820M-2-06	MTO	82		292	223	164	80		2				
DRW0830M-2-06	MTO	83		293	224	166	81		2				
DRW0840M-2-06	MTO	84		294	225	168	82		2				
DRW0850M-2-06	●	85		296	227	170	83		2				
DRW0860M-2-06	MTO	86		299	230	172	84	2					
DRW0870M-2-06	MTO	87		302	233	174	85	10.5	2				
DRW0880M-2-06	MTO	88		304	235	176	86	2					
DRW0890M-2-06	MTO	89		307	238	178	87	2					
DRW0900M-2-06	●	90		309	240	180	88	11	2				
DRW0910M-2-06	MTO	91		311	242	182	89		2				
DRW0920M-2-06	MTO	92		314	245	184	90		2				
DRW0930M-2-06	MTO	93		316	247	186	91		2				
DRW0940M-2-06	●	94		319	250	188	92	11.6	2				
DRW0950M-2-06	●	95	321	252	190	93	2						
DRW0960M-2-06	MTO	96	324	255	192	94	2						
DRW0970M-2-06	MTO	97	325	256	194	95	2						
DRW0980M-2-06	MTO	98	328	259	196	96	2						
DRW0990M-2-06	MTO	99	330	261	198	97	2						
DRW1000M-2-06	●	100	332	263	200	98	12.2	2					

Offset Drilling
 Offset for DRW should be 0 ~ +0.15 mm in radius (0 ~ +0.3 mm in diameter).
 Do not set it to a negative value to make the diameter smaller.

● : Standard item R : Right-hand only L : Left-hand only □ : Check availability MTO : Made to order



- DRA
- DRC
- DRV
- DRZ
- DRXR
- DRW

Toolholder dimensions (Drilling depth : 3 x DC)

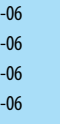
Description	Availability	No. of inserts	Dimension (mm)						Coolant hole	Fig.	Spare parts		Applicable inserts K101
			DC	OAL	LFS	LU	DCSFMS	PL			Screw	Wrench	
													
S50- DRW0600M-3-06	●	4	60	295	226	180	63	7.6	Yes	SB-3592TR	DT-10	WCMT06T308	
DRW0610M-3-06	MTO		61	298	229	183		7.7					
DRW0620M-3-06	MTO		62	302	233	186		7.8					
DRW0630M-3-06	MTO		63	305	236	189		7.9					
DRW0640M-3-06	MTO		64	310	241	192		8					
DRW0650M-3-06	●		65	314	245	195	8.2						
DRW0660M-3-06	MTO		66	317	248	198	64	8.3					
DRW0670M-3-06	MTO		67	321	252	201	65	8.4					
DRW0680M-3-06	MTO		68	325	256	204	66	8.5					
DRW0690M-3-06	MTO		69	328	259	207	67	8.6					
DRW0700M-3-06	●		70	332	263	210	68	8.7					
DRW0710M-3-06	MTO		71	335	266	213	69	8.9					
DRW0720M-3-06	MTO		72	339	270	216	70	9					
DRW0730M-3-06	MTO		73	344	275	219	71	9.1					
DRW0740M-3-06	●		74	347	278	222	72	9.2					
S50- DRW0750M-3-06	●		6	75	351	282	225	73					9.3
DRW0760M-3-06	MTO	76		355	286	228	74	9.4					
DRW0770M-3-06	MTO	77		358	289	231	75	9.5					
DRW0780M-3-06	MTO	78		362	293	234	76	9.7					
DRW0790M-3-06	MTO	79		365	296	237	77	9.8					
DRW0800M-3-06	●	80		367	298	240	78	9.9	2				
DRW0810M-3-06	MTO	81		370	301	243	79		2				
DRW0820M-3-06	MTO	82		374	305	246	80		2				
DRW0830M-3-06	MTO	83		376	307	249	81		2				
DRW0840M-3-06	MTO	84		378	309	252	82	10.5	2				
DRW0850M-3-06	●	85		381	312	255	83		2				
DRW0860M-3-06	MTO	86		385	316	258	84		2				
DRW0870M-3-06	MTO	87		389	320	261	85		2				
DRW0880M-3-06	MTO	88		392	323	264	86	11	2				
DRW0890M-3-06	MTO	89		396	327	267	87		2				
DRW0900M-3-06	●	90		399	330	270	88		2				
DRW0910M-3-06	MTO	91		402	333	273	89		2				
DRW0920M-3-06	MTO	92		406	337	276	90	11.6	2				
DRW0930M-3-06	MTO	93		409	340	279	91		2				
DRW0940M-3-06	●	94		413	344	282	92		2				
DRW0950M-3-06	●	95		416	347	285	93		2				
DRW0960M-3-06	MTO	96		420	351	288	94	11.6	2				
DRW0970M-3-06	MTO	97		422	353	291	95		2				
DRW0980M-3-06	MTO	98		426	357	294	96		2				
DRW0990M-3-06	MTO	99	429	360	297	97	2						
DRW1000M-3-06	●	100	432	363	300	98	12.2	2					

Offset Drilling
 Offset for DRW should be 0 ~ +0.15 mm in radius (0 ~ +0.3 mm in diameter).
 Do not set it to a negative value to make the diameter smaller.

● : Standard item R : Right-hand only L : Left-hand only □ : Check availability MTO : Made to order



Recommended cutting conditions

Workpiece material	Vc (m/min)	f (mm/rev)
Carbon steel	80~200	0.07~0.25
Alloy steel	80~160	0.07~0.25
Mold steel	70~150	0.06~0.20
Gray cast iron	100~240	0.07~0.30
Nodular cast iron	80~150	0.07~0.25

- Apply enough amount of coolant (Internal supply).
- Feed rate should be calculated as single insert.

Application map (Carbon steel / Alloy steel)

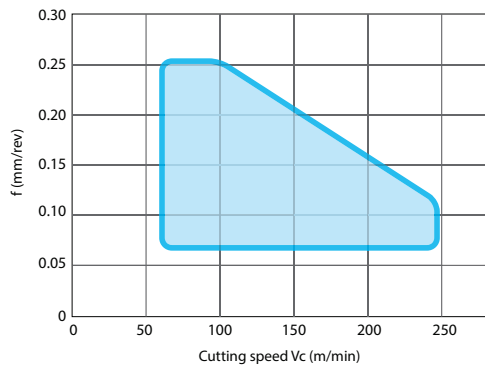

K



Drilling

Spare parts

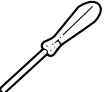
Description	Clamp screw	Wrench
		
S50-DRW...-06	SB-3592TR	DT-10

Hole dia. tolerance

DC	Hole diameter tolerance (mm)
ø60~ø100	0~+0.4

* Above is numeric guideline.
It may vary depending on machines / workpieces / clamping status / cutting conditions.

Offset drilling

Offset for DRW should be 0~+0.15 mm in radius
(0~+0.3mm in diameter).

Do not set it to a negative value to make the diameter smaller.

External coolant is not recommended because the amount of chips will be enormous.
Use internal coolant.
See the graph of "Drill diameter and coolant amount".

Higher output is preferable.
What is important is enough torque rather than high spindle rate.
See the examples of required power as below.

Drill diameter and coolant amount

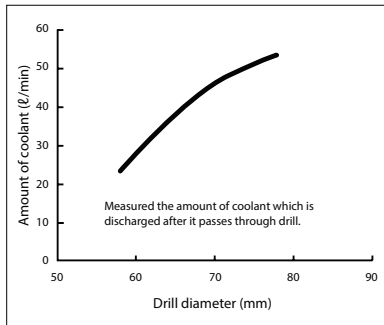

Drill dia.	Workpiece material	Machine	Cutting conditions	Spindle power	*Required power
ø75 (2D)	15CrMo4	M/C	Vc=130m/min (n=550min ⁻¹) f=0.12mm/rev (Vf=66mm/min)	22kW	60%
ø85 (2D)	Alloy steel	M/C	Vc=150m/min (n=560min ⁻¹) f=0.1mm/rev (Vf=56mm/min)	30kW	85%
ø94 (2D)	C45	NC lathe	Vc=120m/min (n=410min ⁻¹) f=0.1mm/rev (Vf=41mm/min)	20kW	100%
ø94 (2D)	X5CrNi18 10	NC lathe	Vc=80m/min (n=270min ⁻¹) f=0.2mm/rev (Vf=54mm/min)	20kW	40%

* The required power was read on the load meter.

During processing, force of deflection is applied to the center of the drill.
If the drill is just pulled out from the position where processing is finished, tool markings will be made.
To prevent tool markings, perform offset before pulling out the drill.

How to prevent tool markings

1. Drilling the hole (The spindle revolves)

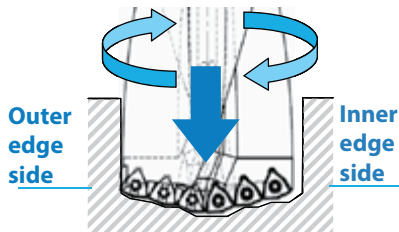

2. Turn back approximately 0.5 mm (The spindle revolves)

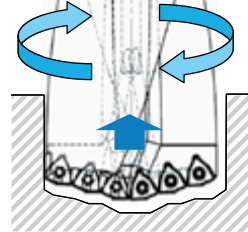

Chips are adhering to the bottom when drilling stops.

- Without turning back, chips remains adhering to the bottom.
- If offset (3) is performed without turning back, the bottom of drill contacts with the inner surface of hole.
- Turning back is necessary for blind holes but not for through holes.

3. Stop revolution and perform offset (The spindle stops)

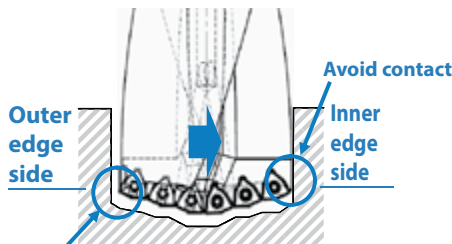

Make a clearance to prevent the tool from contacting when pulling out. (Approximately 0.1~0.2 mm)

4. Pull out the drill

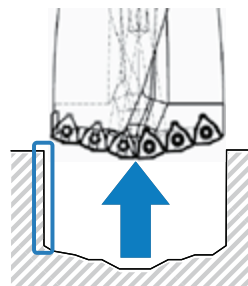

Tool markings are not made (or are only slight even if made).

Example of drilling program

```
G90G54G0G43X0Y0Z100.0H10
S477M03
Z2.5M8
G01Z -80.0F48
Z-79.5M19 ← The spindle stops at the specified position
X0.2Y0.2
Z100.0M9
```

* The M code and X and Y moving directions are unique to the equipment.

M









Introduction		M2
Cutting edge angle 45°/66°/70°		M12
MFPN45		M12
MFPN66		M21
MFSE45		M28
MFLN	MFLN45 / MFLN70	M34
MFK	MFK / MFK-SF	M40
Cutting edge angle 75°		M48
MSRS15		M49
Cutting edge angle 88°/90°		M52
MEW		M54
MEC	MEC / MECX	M64
MEV		M84
MEWH		M90
MECH		M94
MECHT		M105
MFWN		M109
MFWN-Mini		M116
MFSN88		M123
MFLN		M130
MSRS90		M136
MSR	MSR / MSR-BT50	M142
DMC	DMC-SX / DMC-H	M148
MFAH		M154
MEAS		M164
Cutter for finishing		M168
MFF		M171
High feed cutter		M174
MFH Series	MFH Harrier	M176
	MFH Boost	M186
	MFH Mini	M196
	MFH Micro	M204
Multi-Function end mill		M208
MEY		M208
Slott mill		M214
MST	MSTA	M216
	MSTB	M220
	MSTC	M226
Ball-nose / radius type cutters		M242
MRF	MRF / MRFW	M242
MRW		M248
MRX		M255
Other applications		M263
MCSE	Chamfering end mill	M263
MEF	Bolt countersink end mill	M266
METS	T-Slot mill	M269
MGI	Grooving end mill for M/C	M272
MVG	Ring grooving end mill for M/C	M274
Other inserts (Inserts without hole)		M276

Cutting edge angle 45°/66°/70°/75°

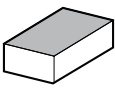
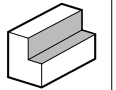
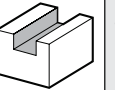
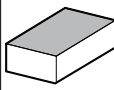
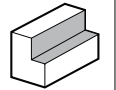
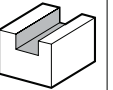
Cutting edge angle	Applications	Facing	Chamfering	Cutting edge angle	Applications	Facing	Chamfering
							
Shape				Shape			
45°	 <p>M12~M15</p>	<ul style="list-style-type: none"> • 10-edge pentagonal inserts (double-sided) • Low cutting force with helical cutting-edge design • Dual cutting edge design (High toughness) • End mills have $\varnothing 32$ cylindrical shank 		45°	 <p>M34</p>	<ul style="list-style-type: none"> • For heavy milling • Tough 4-edge vertical inserts • For large depths of cut and high feed rates • Max. ap 12 mm 	
	 <p>With Wiper Insert M28</p>	<ul style="list-style-type: none"> • Roughing Condition ($f_z = 0.25$ mm/t) Provides Excellent Surface Finish ($0.8 \mu\text{mRa}$ or Less) * (*Based on internal evaluation with wiper insert installed.) • Maintains Long Tool Life with High-Precision Inserts • Newly Developed Chipbreakers for Steel, Stainless Steel, and Aluminum • Improved Productivity with Excellent Chip Control 					
Cutting edge angle	Applications	Facing		Cutting edge angle	Applications	Facing	
							
Shape				Shape			
66°	 <p>M21~M23</p>	<ul style="list-style-type: none"> • Double-sided 10-edge insert • Cutting edge angle 66° • Reduces chattering with low cutting force design • End mills have $\varnothing 32$, $\varnothing 40$ cylindrical shank 		70°	 <p>M35</p>	<ul style="list-style-type: none"> • For heavy milling • Tough 4-edge vertical inserts • For large depths of cut and high feed rates • Max. ap 17 mm 	
	 <p>M49</p>	<ul style="list-style-type: none"> • For heavy milling • Max. ap 12 mm • High chip evacuation rate per unit 			 <p>M40</p>	<ul style="list-style-type: none"> • High efficiency multi-edge cutter for cast iron • 10-edge pentagonal inserts (double-sided) • Low cutting force with helical cutting-edge design • Improved surface finish, minimizing chattering and prevented burr formation • Dual cutting edge design (High toughness) 	
75°				 <p>M42</p>	<ul style="list-style-type: none"> • For cast iron • Adjustable cutting edge height • High speed and high precision machining of cast iron by combining ceramic insert and CBN wiper insert 		















Cutting edge angle 88°/90° (Double-sided insert)

Cutting edge angle	Applications	Facing	Shouldering	Slotting	Cutting edge angle	Applications	Facing	Shouldering	Slotting
									
90°	MEW  M54~M56	<ul style="list-style-type: none"> Economical double-sided 4-edge insert Obtuse edge increases cutting edge toughness Smooth surface wall with low cutting force and reduced chattering 	MFWN  M109, M110, M112	<ul style="list-style-type: none"> Economical double-sided 6-edge insert Superior fracture resistance with thick edge design "Large slant edge" design reduces shock when cutting edge enters the workpiece Low cutting force and reduce chattering End mills have ø32 cylindrical shank 					
	MEW head (Modular type)  M57		MFWN Mini  M117, M118		<ul style="list-style-type: none"> Can be used up to 5 mm D.O.C. Good cost performance Economical double-sided 6-edge insert Superior fracture resistance with thick edge design "Large slant edge" design reduces shock when cutting edge enters the workpiece Low cutting force and reduce chattering End mills have ø25, ø32 cylindrical shank 				
	MFSN88  M123, M125		<ul style="list-style-type: none"> Economical double-sided 8-edge insert Reduces chattering with low cutting force design Contribute to cost-cutting for Shoulder Roughing End mills have ø32, ø40 cylindrical shank 						



Cutting edge angle 90°

Cutting edge angle	Applications	Facing	Shouldering	Slotting	Cutting edge angle	Applications	Facing	Shouldering	Slotting
									
90°	MEC  M64~M66, M67	<ul style="list-style-type: none"> • Good squareness • Low cutting force • The silver coating prevents chip wear on the tool body • With coolant hole (Over shank size $\varnothing 16$) • The twisted cutting edge improves cutting performance • Smooth surface of shoulder wall 	MEV  M84, M85	<ul style="list-style-type: none"> • Newly developed vertical triangle inserts • Economical 3-edge insert • The MEV can perform a wide variety of machining processes 					
	MEC head (Modular type)  M68				MEV head (Modular)  M86				
	MECX  M76, M77				DMC-H  M149				
					DMC-SX  M148				







Milling

Cutting edge angle 90° (Heavy milling)

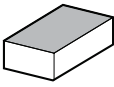

Cutting edge angle	Applications				Cutting edge angle	Applications			
	Facing	Shouldering	Slotting	Shape		Facing	Shouldering	Slotting	Shape
90° (Long cutting edge)	MEWH	<ul style="list-style-type: none"> Low cutting force and sharp cutting performance Excellent surface finish quality Economical double-sided 4-edge insert High quality and stable machining with heavy milling 	MECH	<ul style="list-style-type: none"> Notched insert improves higher productivity 					
	MEWH shell mill	<ul style="list-style-type: none"> MEWH shell mill 	MECH shell mill	<ul style="list-style-type: none"> MECH shell mill 					
	MSRS90	<ul style="list-style-type: none"> High efficiency, low cutting force and stable machining without chatter Various expansive possibilities with combining neutral insert and custom-ordered cutter 	MECH-BT50 MECH-BT50SA	<ul style="list-style-type: none"> Highly rigid BT50 Arbor integrated for MECH Head exchangeable type is available (MECH-BT50SA) 					
	MSR	<ul style="list-style-type: none"> Low cutting force and restrain chattering with notched insert Chipbreaker design with specialized notches improves chip evacuation Chipbreaker achieves stabilized machining for heavy milling 	MECHT	<ul style="list-style-type: none"> Excellent chattering resistance and good chip control with special design for titanium alloys End mills have ø32, cylindrical shank 					
	MSR-BT50	<ul style="list-style-type: none"> Highly rigid BT50 Arbor integrated for MSR 							
	MFLN90	<ul style="list-style-type: none"> For heavy milling Tough 4-edge vertical inserts For large depths of cut and high feed rates Max. ap 20 mm Chamfered corner type available Prevents chattering and insert fracturing 							

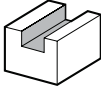

Cutting edge angle 90° (For aluminum alloys)

Cutting edge angle	Applications	Facing	Shouldering	Slotting
				
Shape				
90°	<p>MFAH</p>  <p>➔ M154~M156</p> <ul style="list-style-type: none"> • High efficiency milling cutter for finishing aluminum alloys • Light-weight hybrid body with internal coolant available/Steel body • Adjustable cutting edge height • 3 different cutting edge design 			
	<p>MEAS</p>  <p>➔ M164</p> <ul style="list-style-type: none"> • High efficiency milling cutter for finishing aluminum alloys • Excellent scatter prevention to ensure stable 			

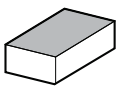









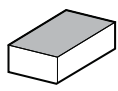
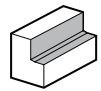
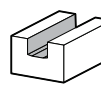
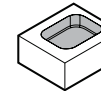





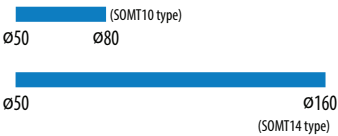

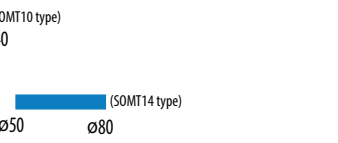











For finishing operations

Applications	Facing
	
Shape	
<p>MFF</p>  <p>➔ M171</p> <ul style="list-style-type: none"> • High-Quality surface finish • Molded wiper insert • Cutter body design provides excellent reliability • Easy-to-adjust cutting edge 	



Milling







High feed cutter

Applications Shape	Facing	Shouldering	Slotting	Pocketing	Cutting diameter DC ø8 ø16 ø25 ø32 ø40 ø50 ø80 ø160
					
MFH Harrier (Face mill)  M176, M177	• Various applications with 4 types of inserts  GM type (General purpose)  GH type (Tough edge)  LD type (Large D.O.C.) MAX. ap = 5mm  FL type (With wiper edge) Roughing and finishing				 (SOMT10 type) ø50 ø80 (SOMT14 type) ø50 ø160
MFH Harrier (End mill)  M178, M179					 (SOMT10 type) ø25 ø40 (SOMT14 type) ø50 ø80
MFH Harrier (Modular type)  M180	• 3D convex cutting edge reduces shock of biting workpiece • Multi-functional cutter for ramping, helical milling vertical milling (plunging) etc. (GM/GH type)				 (SOMT10 type) ø25 ø40
MFH Boost (Face mill)  M190	• Economical double-sided 4-edge insert • High feed milling with large depth of cut capabilities  GM type (General purpose)				 ø40 ø80
MFH Boost (End mill)  M189	• Achieves high efficiency machining in various shouldering, slotting, helical milling, and ramping applications				 ø22 ø40
MFH Boost (Modular type)  M191					 ø22 ø42
MFH mini (Face mill)  M197	• Economical double-sided 4-edge insert  GM type (General purpose)  GH type (Tough edge)				 ø40 ø50
MFH mini (End mill)  M196	• High efficiency and high feed machining at small dia. machining and small machining center				 ø16 ø32
MFH mini (Modular type)  M198					 ø16 ø32
MFH micro (end mill)  M204	• Micro diameter cutter for high feed machining • High efficiency machining with low cutting force and reduced chattering 				 ø8 ø16
MFH micro (modular type)  M205					 ø8 ø16

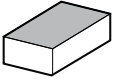

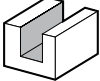
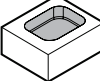
Milling

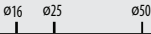
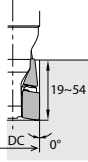





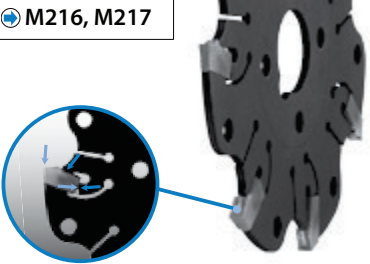
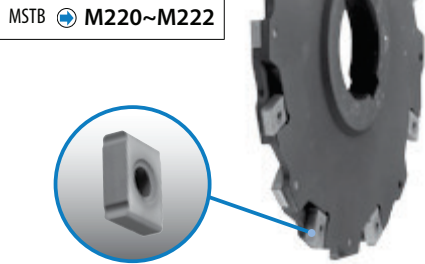
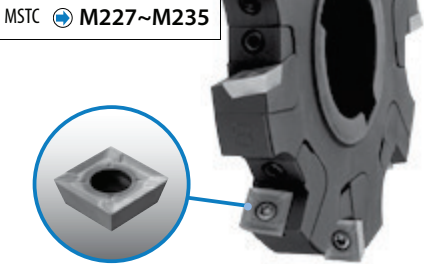

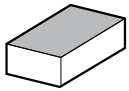
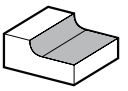
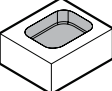

Multi-function machining end mill

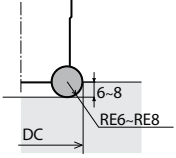
Applications	Facing	Shouldering	Slotting	Deep slotting	Pocketing	Drilling	Lead angle and max. ap	Cutting dia. DC
								
Shape								
MEY	<ul style="list-style-type: none"> Multi-function machining (Drilling/Ramping/Shouldering/Grooving) High efficiency mold machining Low cutting force, Good chip evacuation 		<ul style="list-style-type: none"> Full 2-insert structure and high stability Good chip control when Ramping 		<ul style="list-style-type: none"> Cutting diameters that are larger than the shank diameters enables wall shouldering The silver coating prevents chip wear on the tool body 			
	<ul style="list-style-type: none"> M208, M209 							

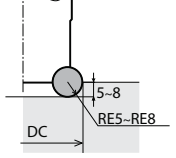

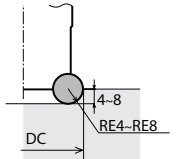

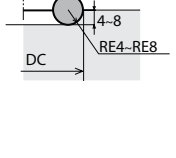

Slot mill MST

MSTA → M216, M217	MSTB → M220~M222	MSTC → M227~M235
		
<ul style="list-style-type: none"> Self-clamping type Remove insert with appropriate wrench 	<ul style="list-style-type: none"> Easy screw on tangential clamped insert 	<ul style="list-style-type: none"> Adjustable slotting width due to unique cam adjustment structure

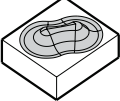
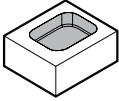
Radius

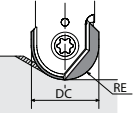
Applications Shape	Facing	Shouldering	Pocketing	Lead angle and max. ap	Cutting dia. DC
					
MRW face mill/end mill  M248 M250	<ul style="list-style-type: none"> High efficiency radius cutter with double-sided insert Combine sharpness and cutting edge strength (A.R. Max. +12°) Prevent insert rotation during machining with flat lock structure Wide application range from steel to heat-resistant alloys 				
MRX face mill  M255	<ul style="list-style-type: none"> Low cutting force and high performance radius cutter Low cutting force with helical cutting-edge design (A.R. Max. +10°) Prevent insert rotation during machining with flat lock structure Wide application from facing, grooving, pocketing to plunging Wide application range from steel to heat-resistant alloys 				
MRX end mill  M258					
MRX head (Modular type)  M259					

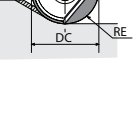
Ball-nose end mill

Applications Shape	Contouring/Profiling	Pocketing	Lead angle and max. ap	Cutting dia. DC
				
MRF  M242	<ul style="list-style-type: none"> For high quality mold finishing High R-accuracy (Insert's R-accuracy: ±0.01mm or under) The bushing ensures insert installation accuracy 			
MRFW  M243	<ul style="list-style-type: none"> Carbide shank For high quality mold finishing High R-accuracy (Insert's R-accuracy: ±0.01mm or under) The bushing ensures insert installation accuracy Superior to anti vibration, and stable machining is possible with long overhang length without chattering 			



Milling

Chamfering

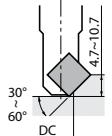
Applications	Chamfering	Back chamfering	V shape slotting	Countersinking	Lead angle and max. ap
	Shape				
 <p>M264</p>	<ul style="list-style-type: none"> • For 30°, 45°, 60° chamfering • Economical 4-edge insert • Available back chamfering 				

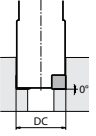

Bolt countersinking

Applications	Bolt countersinking	Facing	Shouldering	Lead angle and max. ap
	Shape			
 <p>M266</p>	<ul style="list-style-type: none"> • Countersink for hexagon socket bolt (M6 ~ M30) • Economical 4-edge insert 			

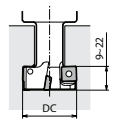
T-Slotting

Applications	T-Slotting	Back side milling	Lead angle and max. ap
	Shape		
 <p>M269</p>	<ul style="list-style-type: none"> • T-Slotting • Recommended for high feed machining with 2 flute design • Economical 4-edge insert 		

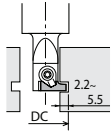
Grooving

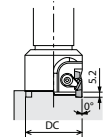
Applications	Internal grooving	Ring grooving	Lead angle and max. ap
	Shape		
 <p>M272</p>	<ul style="list-style-type: none"> • Edge Width 1.0 ~ 4.0mm • Grooving for M/C 		
 <p>M274</p>		<ul style="list-style-type: none"> • Cutting dia. $\varnothing 30 \sim \varnothing 75$ • Edge width 4.0 ~ 4.9mm • O-Ring grooving (G Series) 	

M

Milling

Symbol	Shape
H	Hexagon
O	Octagon
P	Pentagon
S	Square
T	Triangle
C	80° Rhombic
D	55° Rhombic
E	75° Rhombic
F	50° Rhombic
M	86° Rhombic
V	35° Rhombic
W	Trigon
L	Rectangle
A	85° Parallelogram
B	82° Parallelogram
K	55° Parallelogram
R	Round

Shown angle stands for acute angle for rhombic and parallelogram inserts.

Symbol	Relief angle
A	3°
B	5°
C	7°
D	15°
E	20°
F	25°
G	30°
N	0°
P	11°
O	Other angles

Symbol (Class)	Tolerance (mm)		
	Corner Height	Thickness	I.C. Size
A	±0.005	±0.025	±0.025
F	±0.013		±0.013
C			±0.025
H			±0.013
E	±0.025	±0.13	±0.025
G	±0.025	±0.13	±0.025
J			
K*	±0.013	±0.025	±0.05~±0.15
L*	±0.025		
M*	±0.08~±0.18	±0.13	±0.08~±0.25
N*		±0.025	
U*	±0.13~±0.38	±0.13	

Insert's periphery is as fired.
*Tolerance difference is depending on insert size.

Symbol	Shape
W	No chipbreaker, with hole
T	Single-sided chipbreaker, with hole
F	Double-sided chipbreakers, without hole
N	No chipbreaker, without hole
R	Single-sided chipbreaker, without hole
M	Single-sided chipbreaker, with hole
A	No chipbreaker, with hole

Symbol	Shape
F	Sharp edge
E	R-honed
T	Chamfered
S	Chamfered + R-honed



Edge length	
S	
T	
R	
A, N	
O	
P	
W	

Thickness	
Symbol	Thickness (mm)
02	2.38
03	3.18
T3	3.97
04	4.76
05	5.56
06	6.35

Cutting edge angle	
Symbol	Cutting edge angle
A	45°
D	60°
E	75°
F	85°
H	87°
P	90°
X	65°

Relief angle	
Symbol	Relief angle
A	3°
B	5°
C	7°
D	15°
E	20°
F	25°
G	30°
N	0°
P	11°
R	10°
S	14°
T	22°
U	23°

Hand of tool	
Symbol	Hand of tool
R	Right-hand
L	Left-hand
N	Neutral

Manufacturer's option
Chipbreaker, etc.

In case of indicating corner-R(RE)

Corner-R (RE) (mm)	
04	0.4
08	0.8
12	1.2
16	1.6
20	2.0

M



Milling

MFPN45 (Face mill)

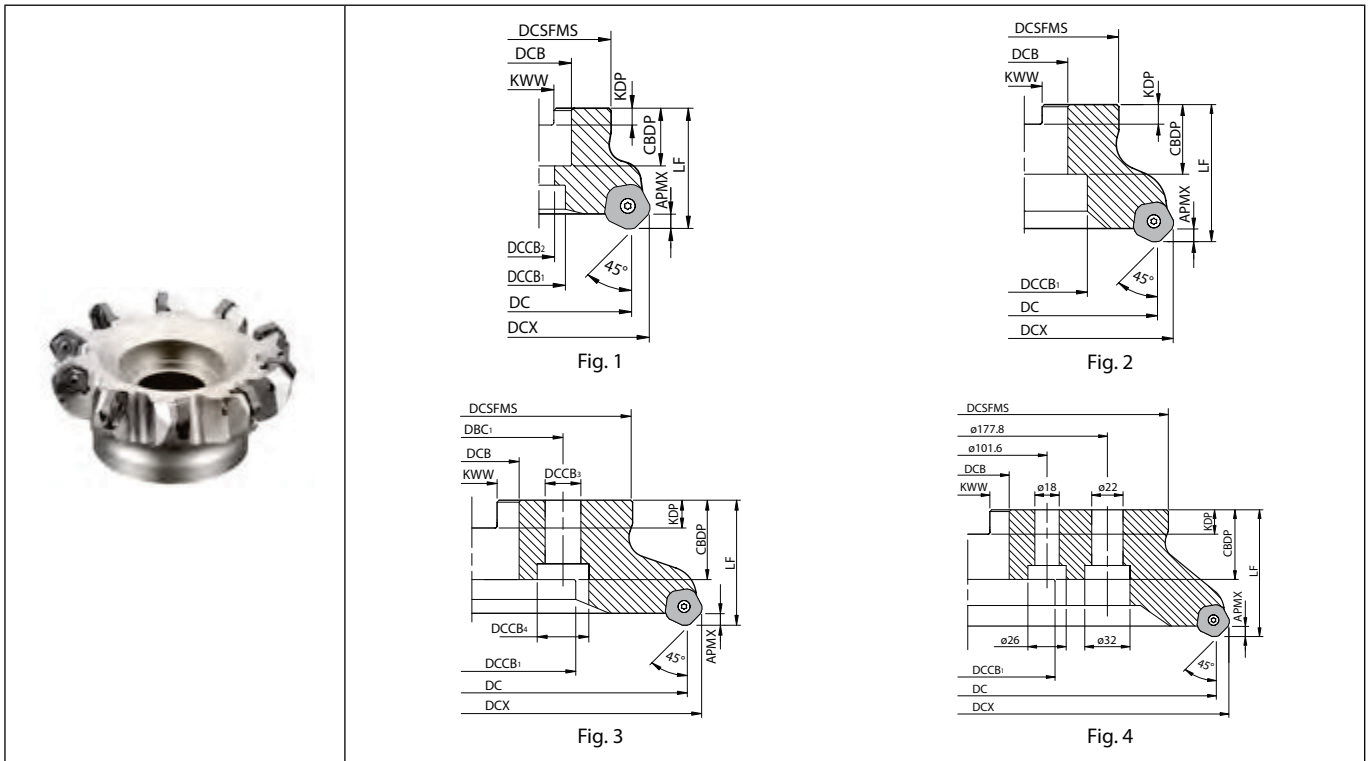

Toolholder dimensions

Description	Availability	Inserts	Dimension (mm)															A.R. max (°)	R.R. (°)	Coolant hole	Weight (kg)	Fig.	Applicable inserts M16							
			R	L	DC	DCX	DCSFMS	DCB	DCCB1	DCCB2	DCCB3	DCCB4	DBC1	LF	CBDP	KDP	KWW							APMX						
Metric Coarse pitch	MFPN	45063R-4T-M	●	4	63	76	47	22	19	11						40	21	6.3	10.4	6	+10	-10	No	0.5	1	PN□U1205...				
		45080R-5T-M	●	5	80	93	60	27	22	13						50	24	7	12.4			-8		1.1	1					
		45100R-6T-M	●	6	100	113	70	32	48							30	8	8	14.4					1.4	2					
		45125R-7T-M	●	7	125	138	87	40	58							32	9	16.4						2.6	2					
		45160R-8T-M	●	8	160	173	102	60	68			14	20	66.7		63									3.8		3			
		45200R-10T-M	●	10	200	213	142																				6.4	3		
		45250R-12T-M	●	12	250	263		60	110			18	26	101.6		40	14	25.7									9.1	3		
		45315R-14T-M	MTO	14	315	328	220									80												21.3	4	
		Metric Fine pitch	MFPN	45063R-5T-M	●	5	63	76	47	22	19	11						40	21	6.3	10.4	6	+10	-10	No		0.5	1	PN□U1205...	
45080R-6T-M	●			6	80	93	60	27	22	13						50	24	7	12.4						1	1				
45100R-8T-M	●			8	100	113	70	32	48							30	8	14.4							1.4	2				
45125R-10T-M	●			10	125	138	87	40	58							32	9	16.4								2.5	2			
45160R-12T-M	●			12	160	173	102	60	68			14	20	66.7		63										3.8	3			
45200R-14T-M	●			14	200	213	142																				6.5	3		
45250R-16T-M	●			16	250	263		60	110			18	26	101.6		40	14	25.7									9.1	3		
45315R-18T-M	MTO			18	315	328	220									80												21.7		4
Metric Extra fine pitch	MFPN			45063R-6T-M	●	6	63	76	47	22	19	11						40	21	6.3	10.4	6	+10	-10	No	0.5	1	PN□U1205...		
		45080R-8T-M	●	8	80	93	60	27	22	13						50	24	7	12.4							1.1	1			
		45100R-10T-M	●	10	100	113	70	32	48							30	8	14.4								1.3	2			
		45125R-13T-M	●	13	125	138	87	40	58							63	32	9	16.4							2.6	2			

APMX : 6 mm (GM, SM, GH Chipbreakers), 5 mm (GL Chipbreaker), 3 mm (W Chipbreaker)

● : Standard item R : Right-hand only L : Left-hand only □ : Check availability MTO : Made to order

M

Milling

Cutting edge angle 45°~70°

Cutting edge angle 75°

Cutting edge angle 88°/90°

Cutter for Finishing

High Feed Cutter

Multi-Function

Slot Mill

Ball-nose Radius

Others

Toolholder dimensions

Description		Availability		Dimension (mm)																	A.R. max.(°)	R.R.(°)	Coolant hole	Weight (kg)	Fig.	Applicable inserts M16						
		R	L	Inserts		DC	DCX	DCSPMS	DCB	DCCB ₁	DCCB ₂	DCCB ₃	DCCB ₄	DBC ₁	LF	CBDP	KDP	KWW	APMX													
Bore dia. inch spec	Coarse pitch	MFPN 45080°L-5T	<input type="checkbox"/>	<input type="checkbox"/>	5	80	93	60	25.4	22	13									6	+10	-8	No	1.1	1	PN□U1205...						
		MFPN 45100°L-6T	<input type="checkbox"/>	<input type="checkbox"/>	6	100	113	70	31.75	48					50	27	6	9.5					-8	No	1.4		2					
		MFPN 45125°L-7T	<input type="checkbox"/>	<input type="checkbox"/>	7	125	138	87	38.1	58						36	10	15.9										2.6	2			
		MFPN 45160°L-8T	<input type="checkbox"/>	<input type="checkbox"/>	8	160	173	102	50.8	72						63	38	11	19.1										4	2		
		MFPN 45200R-10T	<input type="checkbox"/>	<input type="checkbox"/>	10	200	213	142																					6.7	3		
		MFPN 45250R-12T	<input type="checkbox"/>	<input type="checkbox"/>	12	250	263	142	47.625	110							40	14	25.4											9.4	3	
		MFPN 45315R-14T	<input type="checkbox"/>	<input type="checkbox"/>	14	315	328	220									80													21.2	4	
	Fine pitch	MFPN 45080R-6T	<input type="checkbox"/>	<input type="checkbox"/>	6	80	93	60	25.4	22	13										6	+10	-8	No	1.1	1	PN□U1205...					
		MFPN 45100R-8T	<input type="checkbox"/>	<input type="checkbox"/>	8	100	113	70	31.75	48					50	27	6	9.5											1.4	2		
		MFPN 45125R-10T	<input type="checkbox"/>	<input type="checkbox"/>	10	125	138	87	38.1	58						36	10	15.9												2.7	2	
		MFPN 45160R-12T	<input type="checkbox"/>	<input type="checkbox"/>	12	160	173	102	50.8	72						63	38	11	19.1											4	2	
		MFPN 45200R-14T	<input type="checkbox"/>	<input type="checkbox"/>	14	200	213	142																						6.9	3	
		MFPN 45250R-16T	<input type="checkbox"/>	<input type="checkbox"/>	16	250	263	142	47.625	110							40	14	25.4												9.6	3
		MFPN 45315R-18T	<input type="checkbox"/>	<input type="checkbox"/>	18	315	328	220									80														21.5	4
	Extra fine pitch	MFPN 45080R-8T	<input type="checkbox"/>	<input type="checkbox"/>	8	80	93	60	25.4	22	13										6	+10	-8	No	1.1	1	PN□U1205...					
		MFPN 45100R-10T	<input type="checkbox"/>	<input type="checkbox"/>	10	100	113	70	31.75	48					50	27	6	9.5											1.3	2		
		MFPN 45125R-13T	<input type="checkbox"/>	<input type="checkbox"/>	13	125	138	87	38.1	58						36	10	15.9												2.7	2	
		MFPN 45160R-16T	<input type="checkbox"/>	<input type="checkbox"/>	16	160	173	102	50.8	72						63	38	11	19.1											4	2	
		MFPN 45200R-18T	<input type="checkbox"/>	<input type="checkbox"/>	18	200	213	142	47.625	110																				6.9	3	
		MFPN 45250R-20T	<input type="checkbox"/>	<input type="checkbox"/>	20	250	263	142	47.625	110							40	14	25.4												9.6	3

APMX : 6 mm (GM, SM, GH Chipbreakers), 5 mm (GL Chipbreaker), 3 mm (W Chipbreaker)

M



Milling

● : Standard item R : Right-hand only L : Left-hand only □ : Check availability MTO : Made to order

Spare parts (common to Metric / Inch spec)





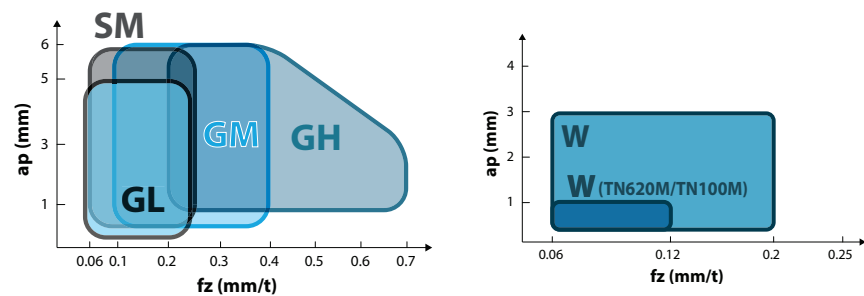

Description		Spare parts							
		Clamp screw	Wrench		Shim	Shim screw	Wrench	Anti-seize compound	Mounting bolt
			TTW	DTM					
Coarse pitch	MFPN 45063R-4T-M	SB-50140TR	TTW-15	-	MFPN-45	SPW-7050	LW-5	P-37	HH10X30
	MFPN 45080 ³ L-5T(-M)								HH12X35
	MFPN 45100 ³ L-6T(-M)								-
	45315R-14T(-M)								-
Fine pitch	MFPN 45063R-5T-M	SB-50140TR	TTW-15	-	-	-	-	P-37	HH10X30
	MFPN 45080R-6T(-M)								HH12X35
	MFPN 45100R-8T(-M)								-
	45315R-18T(-M)								-
Extra fine pitch	MFPN 45063R-6T-M	SB-40140TRN	-	DTM-15	-	-	-	P-37	HH10X30
	MFPN 45080R-8T(-M)								HH12X35
	MFPN 45100R-10T(-M)								-
	45250R-20T								-

 Coat anti-seize compound thinly on portion of taper and thread when insert is fixed.

M

Applicable chipbreaker range



-  Milling
-  Cutter for Finishing
-  High Feed Cutter
-  Multi-Function
-  Slot Mill
-  Ball-nose Radius
-  Others

MFPN45

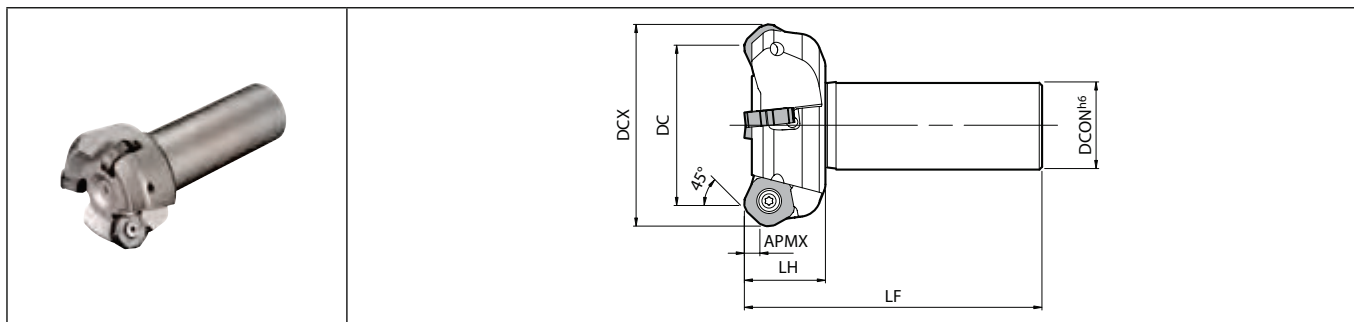

Toolholder dimensions

Description	Availability	Inserts	Dimension (mm)						A.R. max.(°)	R.R.(°)	Coolant hole	Spare parts			Applicable inserts M16
			R	DC	DCX	DCON	LF	LH				Anti-seize compound	Screw	Wrench	
MFPN 45050R-S32-3T	●	3	50	63				-12	No	P-37	SB-50140TR	TTW-15	PN□U1205...		
45063R-S32-4T	●	4	63	76	32	110	30	+10						-10	Tightening torque 4.2N·m
45080R-S32-5T	●	5	80	93				-8							

APMX : 6 mm (GM, SM, GH Chipbreakers), 5 mm (GL Chipbreaker), 3 mm (W Chipbreaker)
 Coat Anti-seize Compound thinly on portion of taper and thread when insert is fixed.



Milling

PNMU/PNEU

Classification of usage

- ★ : Roughing / 1st Choice
- ☆ : Roughing / 2nd Choice
- : Finishing / 1st Choice
- : Finishing / 2nd Choice
- (In case hardness is 45HRC or under)

Carbon steel / Alloy steel			☆	★	☆	■	P
Mold and die steel			☆	★	☆	■	
Austenitic stainless steel			☆	☆	★		M
Martensitic stainless steel	★				☆		
Precipitation hardening stainless steel					★		
Gray cast iron			☆	★			K
Nodular cast iron			☆	★			
Non-ferrous metals							N
Heat-resistant alloy	★		☆		☆		S
Titanium alloy			☆		★		
Hard materials		★					H

Insert	Description	No. of edges	Dimension (mm)					Carbide						Cermet	Applicable toolholder M12 M13 M15	
			S	D1	INSL	BCH	BS	CVD			PVD					
								CA6535	PR1155	PR1210	PR1225	PR1510	PR1525			TN100M
	PNMU 1205ANER-GM General purpose	10	5.56	6.2	17.88	2	2	●	●	●	●	●	●	●	●	MFPN45...
	PNMU 1205ANEL-GM General purpose	10	5.56	6.2	17.88	2	2	●			●	●			●	MFPN45...
	PNMU 1205ANER-SM Low cutting force	10	5.56	6.2	17.88	2	2	●	●	●	●	●	●	●	●	MFPN45...
	PNMU 1205ANER-GH Tough edge	10	6.17	6.2	17.98	2	2	●	●	●	●	●	●	●	●	MFPN45...
	PNEU 1205ANER-GL Surface finish oriented	10	5.56	6.2	17.51	2.7	2.7	●	●	●	●	●	●	●	●	MFPN45...
	PNEU 1205ANEL-GL Surface finish oriented	10	5.56	6.2	17.51	2.7	2.7	●			●	●			●	MFPN45...
	PNEU 1205ANER-W 2-edge / With wiper edge	2	5.56	6.2	17.85	2.3	8.1	●			●	●	●	●	●	MFPN45...

Recommended cutting conditions M17

● : Standard item R : Right-hand only L : Left-hand only □ : Check availability

PNEU1205ANER-W inserts are sold in 5 piece boxes

M16

M

Milling

Cutting edge angle 45°~70°

Cutting edge angle 75°

Cutting edge angle 88°/90°

Cutter for Finishing

High Feed Cutter

Multi-Function

Slot Mill

Ball-nose Radius

Others

Recommended cutting conditions

Chipbreaker	Workpiece material	fz (mm/t) (): TN620M	Recommended insert grades (Vc: m/min)					
			Cermet	MEGACOAT(PVD coated carbide)			CVD coated carbide	
			TN620M	PR1535	PR1525 (PR1225)	PR1510 (PR1210)	PR015S	CA6535
GM	Carbon steel	0.1~ 0.2 ~0.4 (0.06~ 0.12 ~0.20)	200~ ★250 ~300	120~ ☆180 ~250	120~ ★180 ~250	-	-	-
	Alloy steel	0.1~ 0.2 ~0.4 (0.06~ 0.12 ~0.20)	180~ ★220 ~250	100~ ☆160 ~220	100~ ★160 ~220	-	-	-
	Mold steel	0.1~ 0.2 ~0.35 (0.06~ 0.08 ~0.15)	150~ ★180 ~220	80~ ☆140 ~180	80~ ★140 ~180	-	-	-
	Stainless steel (Austenitic related)	0.1~ 0.2 ~0.4	-	100~ ☆160 ~200	100~ ☆160 ~200	-	-	-
	Stainless steel (Martensitic related)	0.1~ 0.2 ~0.4	-	150~ ☆200 ~250	-	-	-	180~ ☆240 ~300
	Stainless steel (Precipitation hardening)	0.1~ 0.2 ~0.3	-	90~ ★120 ~150	-	-	-	-
	Gray cast iron	0.1~ 0.2 ~0.4	-	-	-	120~ ★180 ~250	-	-
	Nodular cast iron	0.1~ 0.2 ~0.35	-	-	-	100~ ★150 ~200	-	-
Ni-base heat-resistant alloys	0.1~ 0.12 ~0.2	-	20~ ☆30 ~50	-	-	-	20~ ★30 ~50	
SM *1GL	Carbon steel	0.06~ 0.12 ~0.25 (0.06~ 0.10 ~0.15)	200~ ★250 ~300	120~ ☆180 ~250	120~ ☆180 ~250	-	-	-
	Alloy steel	0.06~ 0.12 ~0.25 (0.06~ 0.10 ~0.15)	180~ ★220 ~250	100~ ☆160 ~220	100~ ☆160 ~220	-	-	-
	Mold steel	0.06~ 0.1 ~0.2 (0.06~ 0.08 ~0.12)	150~ ★180 ~220	80~ ☆140 ~180	80~ ★140 ~180	-	-	-
	Stainless steel (Austenitic related)	0.06~ 0.12 ~0.25	-	100~ ★160 ~200	100~ ☆160 ~200	-	-	-
	Stainless steel (Martensitic related)	0.06~ 0.12 ~0.25	-	150~ ☆200 ~250	-	-	-	180~ ★240 ~300
	Stainless steel (Precipitation hardening)	0.06~ 0.12 ~0.25	-	90~ ☆120 ~150	-	-	-	-
	Gray cast iron	0.06~ 0.12 ~0.25	-	-	-	120~ ☆180 ~250	-	-
	Nodular cast iron	0.06~ 0.1 ~0.2	-	-	-	100~ ☆150 ~200	-	-
	Ni-base heat-resistant alloys	0.06~ 0.1 ~0.15	-	20~ ☆30 ~50	-	-	-	20~ ☆30 ~50
Titanium alloys	0.06~ 0.08 ~0.15	-	40~ ★60 ~80	-	-	-	-	
*2GH	Carbon steel	0.2~ 0.4 ~0.7	-	120~ ☆180 ~250	120~ ☆180 ~250	-	-	-
	Alloy steel	0.2~ 0.4 ~0.6	-	100~ ☆160 ~220	100~ ☆160 ~220	-	-	-
	Mold steel	0.2~ 0.35 ~0.5	-	80~ ☆140 ~180	80~ ★140 ~180	-	-	-
	Stainless steel (Austenitic related)	0.2~ 0.3 ~0.4	-	100~ ☆160 ~200	100~ ☆160 ~200	-	-	-
	Stainless steel (Martensitic related)	0.2~ 0.3 ~0.4	-	150~ ☆200 ~250	-	-	-	180~ ☆240 ~300
	Stainless steel (Precipitation hardening)	0.2~ 0.3 ~0.4	-	90~ ☆120 ~150	-	-	-	-
	Gray cast iron	0.2~ 0.4 ~0.7	-	-	-	120~ ☆180 ~250	-	-
	Nodular cast iron	0.2~ 0.35 ~0.5	-	-	-	100~ ☆150 ~200	-	-
	Ni-base heat-resistant alloys	0.2~ 0.3 ~0.4	-	20~ ☆30 ~50	-	-	-	20~ ☆30 ~50
	Hard materials (60HRC or less)	0.05~ 0.1 ~0.2	-	-	-	-	50~ ★80 ~100	-

★: 1st Recommendation ☆: 2nd Recommendation

The bold-faced number indicates a center value of recommended cutting condition. Adjust the cutting speed and the feed rate within the above conditions according to the actual machining situation. Machining with coolant is recommended for Ni-base heat-resistant alloys and titanium alloys.

*1. GL Chipbreaker: Recommended for surface finish oriented milling.

*2. GH Chipbreaker: Fine pitch → fz ≤ 0.4 (mm/t)
Extra fine pitch → Not recommended



Milling

Cutter type and chipbreaker selection

Milling purpose	Cutter type			Chipbreaker				
	Coarse pitch	Fine pitch	Extra fine pitch	GM	SM	GH	GL	W
General milling for steel and alloy steel		●		●				
Steel and alloy steel (At chattering due to low rigidity machine or poor clamping power)	●				●			
Productivity oriented (Running cost decrease) (ap=4mm or over, fz=0.35mm/t or over)	●					●		
Surface finish oriented	●	●					●	
General milling of stainless steel		●			●			
Stainless steel (To prevent chattering due to low rigidity machine or poor clamping power)	●				●			
Cast iron (For processing efficiency improvement)			●	●				
Cast iron (ap=4mm or over, fz=0.35mm/t or over)	●					●		
Improved surface finish in high efficiency milling		●	●					●

How to use wiper insert

1. Please use one wiper insert on one cutter.
(If you use 2 inserts or more on one cutter, the workpiece surface may be muddy white.)

2. Combination of wiper insert with other chipbreakers

Combination	Chipbreaker		
	GM	SM	W
Recommended combination	●		●
Recommended combination		●	●

The combinations of GH+W and GL+W are not recommended.

3. For checking the protrusion amount of the wiper insert, use tool presetter. (Appropriate protrusion: 0.1mm)

How to attach wiper inserts on MFPN cutter

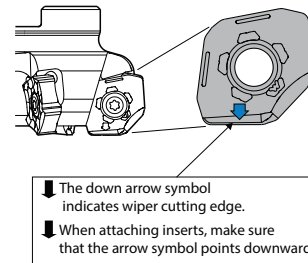

Applicable chipbreaker

Cutter type	Chipbreaker		
	GM	SM (GL)	GH
Coarse pitch (With shim)	✓	✓	✓
Fine pitch (Without shim)	✓	✓	△ (Feed rate is recommended fz=0.4mm/t or under)
Extra fine pitch (Without shim)	✓	✓	Not recommended

M

Milling

Cutting edge angle 45°~70°

Cutting edge angle 75°

Cutting edge angle 88°/90°

Cutter for Finishing

High Feed Cutter

Multi-Function

Slot Mill

Ball-nose Radius

Others

Precautions for use (How to mount an insert)

1. Be sure to remove dust and chips from the insert mounting pocket.
2. After applying anti-seize compound on portion of taper and thread, while pressing the insert against the constraint surfaces, put the screw into the hole of the insert and tighten the screw with appropriate torque. (Ref. to Fig. 1 and Fig. 2)
Recommended tightening torque: The torque for coarse pitch (using M5 screw) is 4.2 N·m
The torque for extra fine pitch (using M4 screw) is 3.5 N·m.
3. After tightening the screw, make sure that there is no clearance between the insert seat surface and the bearing surface of the toolholder and between the insert side surfaces and the constraint surface of the toolholder.
4. To change the cutting edge of the insert, turn the insert counterclockwise. (Fig. 3)
Insert corner identification number is stamped on the top surface of insert. (Fig. 4) To protect the wiper edge, use the corners of insert in the sequence of corner numbers.

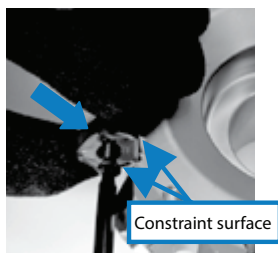

Fig. 1



Fig. 2



Fig. 3

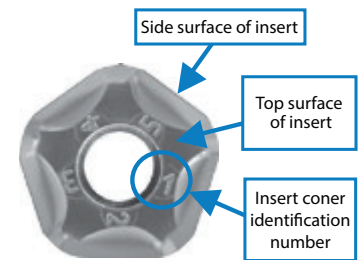

Fig. 4 (Right-hand insert)

How to replace a shim (for coarse pitch)

1. Be sure to remove dust and chips from the insert mounting pocket.
2. The shim must be mounted in the proper direction. While aligning the surface of the shim with the mark on it to the corresponding constraint surface (ref. to Fig. 5) and lightly pressing the shim toward the constraint surface, insert the screw into the hole of the shim and tighten it (ref. to Fig. 6).
When tightening the screw, make sure that the screw is vertical to the bearing surface. Recommended tightening torque is 6.0 N·m.
3. After tightening the screw, make sure that there is no clearance between the shim seat surface and the bearing surface. If there is any clearance, remove the insert and mount it again according to the above steps.

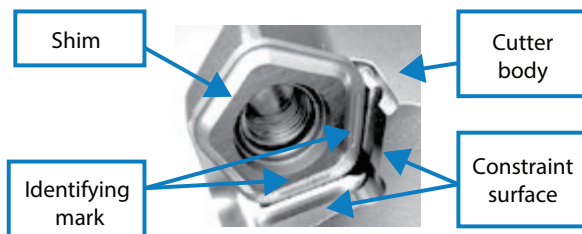

Fig. 5

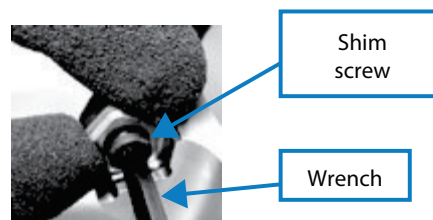

Fig. 6

Cutting edge angle 66°

MFPN66

Economical double-sided 10-edge insert reduces chattering with low cutting force design
Reduces cutting costs when machining auto parts and other general purpose machining applications

- 1 Economical double-sided 10-edge insert**
Applicable to various machining applications with wide size range from ø32

Cost reduction in various applications from general parts to automotive parts machining

- 2 Reduces chattering with low cutting force design**
Available for application from small ap to medium ap

Suppresses vibration for excellent surface finish with 66° cutting edge angle

M

Cutting force comparison (Internal evaluation)

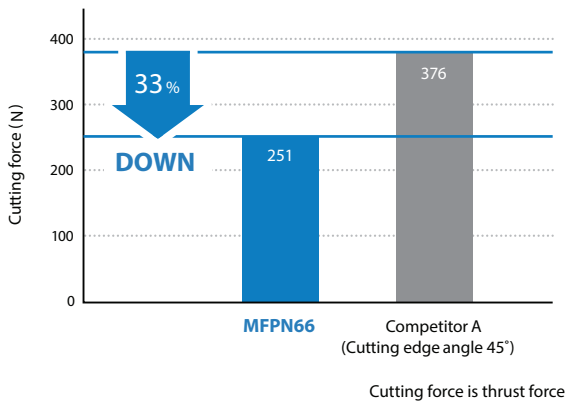

Surface finish (Machining with workpiece overhang length of 80mm)



Excellent surface finish with low workpiece clamping rigidity

Cutting conditions: Vc=200 m/min, ap=3 mm, fz=0.15 mm/t
 Cutter dia. ø63 Workpiece material: C50

Cutting conditions: Vc=200 m/min, ap=0.5 mm, fz=0.2 mm/t
 Cutter dia. ø63 Workpiece material: C50

- 3 Extended tool life by MEGACOAT NANO technology**
Insert lineup also contains cermet grade for better surface finish



General purpose
GM chipbreaker



Tough edge
GH chipbreaker



For stainless steel
SM chipbreaker



Milling

- Cutting edge angle 45°~70°
- Cutting edge angle 75°
- Cutting edge angle 88°/90°
- Cutter for Finishing
- High Feed Cutter
- Multi-Function
- Slot Mill
- Ball-nose Radius
- Others

MFPN66

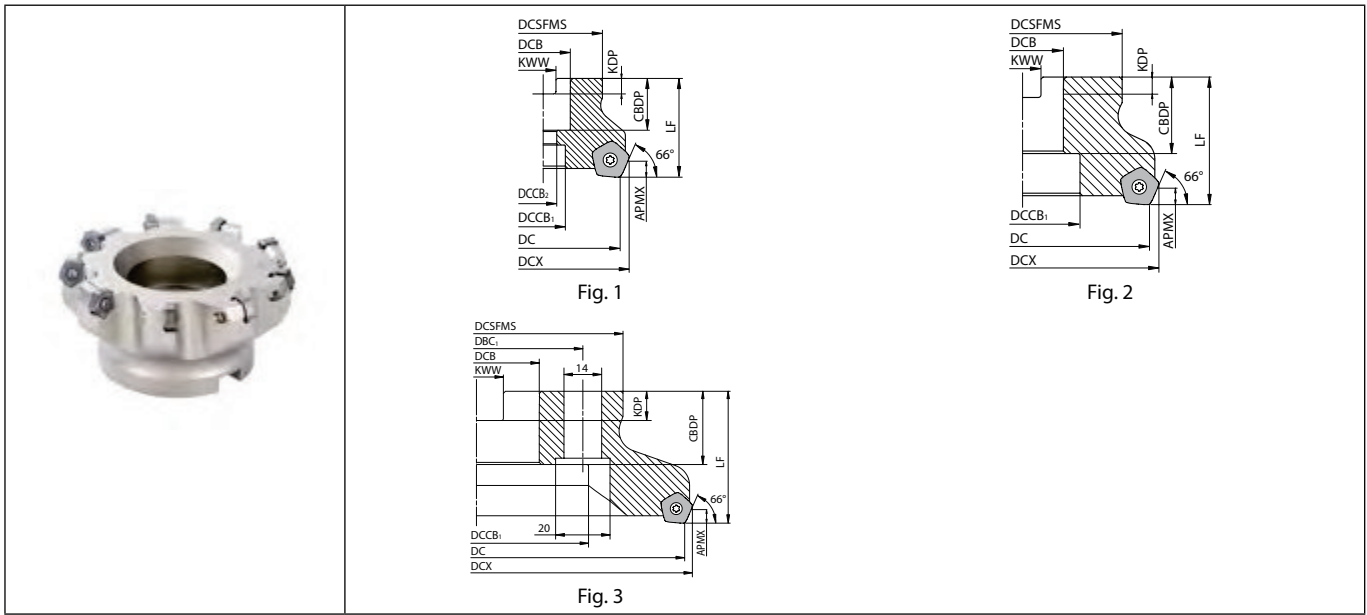

Toolholder dimensions

Description		Availability	Dimension (mm)											A.R. max.(°)	R.R.(°)	Coolant hole	Weight (kg)	Fig.	Applicable inserts M24	
			Inserts	DC	DCX	DCSFMS	DCB	DCCB1	DCCB2	DBG	LF	CBDP	KDP							KWW
Metric	Fine pitch	MFPN 66050R-4T-M-G	●	4	50	58	48	22	18	11	-	40	21	6.3	10.4	+12	-9	No	0.3	PNMU0905...
		MFPN 66063R-5T-M-G	●	5	63	71														
		MFPN 66080R-6T-M-G	●	6	80	88	78	32	45	-	30	8	14.4	-7	1.2					
		MFPN 66100R-7T-M-G	●	7	100	107										89	40	55	-	
		MFPN 66125R-9T-M-G	●	9	125	132	66.7	-	-	-	-	-	-	-	2.8					
		MFPN 66160R-11T-M-G	●	11	160	167										66.7	-	-	-	
Metric	Extra fine pitch	MFPN 66050R-5T-M-G	●	5	50	58	48	22	18	11	-	40	21	6.3	10.4					+12
		MFPN 66063R-7T-M-G	●	7	63	71										70	27	20	13	
		MFPN 66080R-9T-M-G	●	9	80	88	78	32	45	-	30	8	14.4	-7	1.2					
		MFPN 66100R-11T-M-G	●	11	100	107										89	40	55	-	63
		MFPN 66125R-13T-M-G	●	13	125	132	66.7	-	-	-	-	-	-	-	3					
		MFPN 66160R-15T-M-G	●	15	160	167										66.7	-	-	-	-
Bore dia. inch spec	Fine pitch	MFPN 66080R-6T-G	□	6	80	88	70	25.4	20	13	-	50	27	6	9.5					
		MFPN 66100R-7T-G	□	7	100	107	78	31.75	45	-	34	8	12.7	10	15.9	-6	No	1.7		
		MFPN 66125R-9T-G	□	9	125	132	89	38.1	55	-	38	11	19.1						11	19.1
		MFPN 66160R-11T-G	□	11	160	167	110	50.8	72	-	63	11	19.1	11	19.1	-6	No	4.5		
	Extra fine pitch	MFPN 66080R-9T-G	□	9	80	88	70	25.4	20	13	-	50	27						6	9.5
		MFPN 66100R-11T-G	□	11	100	107	78	31.75	45	-	34	8	12.7	10	15.9	-6	No	1.7		
MFPN 66125R-13T-G	□	13	125	132	89	38.1	55	-	63	38	11	19.1	11						19.1	-6
MFPN 66160R-15T-G	□	15	160	167	110	50.8	72	-	63	38	11	19.1		11	19.1	-6	No	4.8		





APMX : 5 mm (GM, SM, GH Chipbreakers, Coated cabide), 3 mm (GM Chipbreaker, Cermet)

● : Standard item R : Right-hand only L : Left-hand only □ : Check availability



Milling

Spare parts (common to Metric / Inch spec)

Description		Clamp screw	Wrench	Anti-seize compound	Mounting bolt
					
Fine pitch	MFPN 66050R-4T-M-G	SB-4090TRP	DTPM-15	P-37	HH10X30
	66063R-5T-M-G				HH10X30
	66080R-6T(-M)-G				HH12X35
	66100R-7T(-M)-G				-
	66125R-9T(-M)-G				-
	66160R-11T(-M)-G				-
<div style="border: 1px solid black; padding: 5px; width: fit-content; margin: 0 auto;"> Recommended tightening torque for insert clamp 3.5N·m </div>					
Extra fine pitch	MFPN 66050R-5T-M-G	SB-4090TRP	DTPM-15	P-37	HH10X30
	66063R-7T-M-G				HH10X30
	66080R-9T(-M)-G				HH12X35
	66100R-11T(-M)-G				-
	66125R-13T(-M)-G				-
	66160R-15T(-M)-G				-
<div style="border: 1px solid black; padding: 5px; width: fit-content; margin: 0 auto;"> Recommended tightening torque for insert clamp 3.5N·m </div>					

 Coat anti-seize compound thinly on portion of taper and thread when insert is fixed.



Milling

Cutting edge angle 45°~70°
Cutting edge angle 75°
Cutting edge angle 88°/90°
Cutter for Finishing
High Feed Cutter
Multi- Function
Slot Mill
Ball-nose Radius
Others

MFPN66

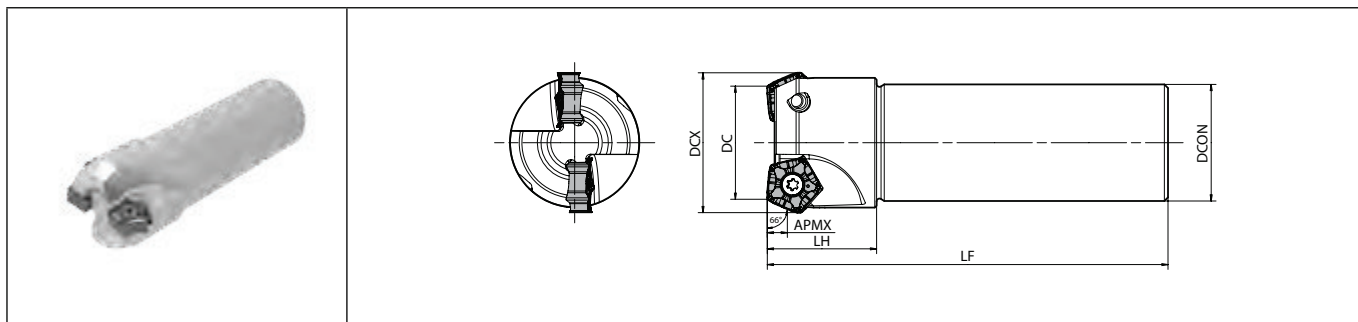

Toolholder dimensions

Description	Availability	Inserts	Dimension (mm)							A.R. max. (°)	R.R. (°)	Coolant hole	Spare parts			Applicable inserts M24
			R	DC	DCX	DCON	LF	LH	Anti-seize compound				Screw	Wrench		
MFPN 66032R-S32-2T-G	●	2	32	39.5	32	110	30	+12	-14	No	P-37	SB-4090TRP	DTPM-15	PNMU0905...		
66040R-S32-3T-G	●	3	40	47.5	32	110	30	+12	-12	No	P-37	SB-4090TRP	DTPM-15			

APMX : 5 mm (GM, SM, GH Chipbreakers, Coated cabide), 3 mm (GM Chipbreaker, Cermet)

Coat Anti-seize Compound thinly on portion of taper and thread when insert is fixed.

Recommended tightening torque for insert clamp : 3.5N-m



Milling

PNMU

Insert		Description	No. of edges	Dimension (mm)					Carbide				Cermet	Applicable toolholder M21 M23
				S	D1	INSL	BCH	BS	PVD					
									PR0155	PR1510	PR1525	PR1535		
		PNMU 0905XNER-GM	10	5.56	4.7	14.6	2	2	●	●	●	●		MFPN66...
		PNMU 0905XNER-SM	10	5.56	4.7	14.6	2	2	●	●	●	●		MFPN66...
		PNMU 0905XNER-GH	10	5.56	4.7	14.6	2	2	●	●	●	●		MFPN66...

Recommended cutting conditions M25

Classification of usage

- ★ : Roughing / 1st Choice
- ☆ : Roughing / 2nd Choice
- : Finishing / 1st Choice
- : Finishing / 2nd Choice
- (In case hardness is 45HRC or under)

Carbon steel / Alloy steel	★	☆	■	P
Mold and die steel	★	☆	■	P
Austenitic stainless steel	☆	★		M
Martensitic stainless steel		★		M
Precipitation hardening stainless steel		★		M
Gray cast iron	★			K
Nodular cast iron	★			K
Non-ferrous metals				N
Heat-resistant alloy			★	S
Titanium alloy			★	S
Hard materials	★			H

M



Milling

Cutting edge angle 45°~70°
Cutting edge angle 75°
Cutting edge angle 88°/90°
Cutter for Finishing
High Feed Cutter
Multi-Function
Slot Mill
Ball-nose Radius
Others

● : Standard item R : Right-hand only L : Left-hand only □ : Check availability

M24

Recommended cutting conditions

Coated carbide

Chipbreaker	Workpiece material	Feed (fz: mm/t)	Recommended insert grades (Vc: m/min)			
			MEGACOAT (PVD coated carbide)			
			PR1535	PR1525	PR1510	PR015S
GM	Carbon steel	0.1~ 0.2 ~0.3	120~ [☆] 180 ~250	120~ [★] 180 ~250	-	-
	Alloy steel	0.1~ 0.2 ~0.3	100~ [☆] 160 ~220	100~ [★] 160 ~220	-	-
	Mold steel	0.1~ 0.18 ~0.25	80~ [★] 140 ~180	80~ [★] 140 ~180	-	-
	Stainless steel (Austenitic related)	0.1~ 0.18 ~0.25	100~ [☆] 150 ~200	100~ [☆] 150 ~200	-	-
	Stainless steel (Martensitic related)	0.1~ 0.18 ~0.25	100~ [☆] 150 ~200	-	-	-
	Stainless steel (Precipitation hardening)	0.1~ 0.18 ~0.25	90~ [★] 120 ~150	-	-	-
	Gray cast iron	0.1~ 0.2 ~0.3	-	-	120~ [★] 180 ~250	-
	Nodular cast iron	0.1~ 0.18 ~0.25	-	-	100~ [★] 150 ~200	-
	Ni-base heat-resistant alloys	0.1~ 0.12 ~0.2	20~ [☆] 30 ~50	-	-	-
	SM	Carbon steel	0.06~ 0.12 ~0.2	-	120~ [☆] 180 ~250	-
Alloy steel		0.06~ 0.12 ~0.2	-	100~ [☆] 160 ~220	-	-
Mold steel		0.06~ 0.1 ~0.15	-	80~ [☆] 140 ~180	-	-
Stainless steel (Austenitic related)		0.06~ 0.12 ~0.2	100~ [★] 150 ~200	100~ [☆] 150 ~200	-	-
Stainless steel (Martensitic related)		0.06~ 0.12 ~0.2	100~ [★] 150 ~200	-	-	-
Stainless steel (Precipitation hardening)		0.06~ 0.12 ~0.2	90~ [☆] 120 ~150	-	-	-
Gray cast iron		0.06~ 0.12 ~0.2	-	-	120~ [☆] 180 ~250	-
Nodular cast iron		0.06~ 0.1 ~0.15	-	-	100~ [☆] 150 ~200	-
Ni-base heat-resistant alloys		0.06~ 0.08 ~0.15	20~ [★] 30 ~50	-	-	-
Titanium alloys		0.06~ 0.08 ~0.15	40~ [★] 60 ~80	-	-	-
GH	Carbon steel	0.15~ 0.25 ~0.35	-	120~ [☆] 180 ~250	-	-
	Alloy steel	0.15~ 0.25 ~0.35	-	100~ [☆] 160 ~220	-	-
	Mold steel	0.1~ 0.2 ~0.3	-	80~ [☆] 140 ~180	-	-
	Gray cast iron	0.15~ 0.25 ~0.35	-	-	120~ [☆] 180 ~250	-
	Nodular cast iron	0.1~ 0.2 ~0.3	-	-	100~ [☆] 150 ~200	-
	Hard materials (60HRC or less)	0.05~ 0.08 ~0.16	-	-	-	50~ [★] 80 ~100

★: 1st Recommendation ☆: 2nd Recommendation



Milling

Cermet

Chipbreaker	Workpiece material	Feed (fz: mm/t)	Recommended insert grades
			Vc: m/min
GM	Carbon steel	0.06~ 0.12 ~0.15	Cermet TN620M ★ 200~ 250 ~300
	Alloy steel	0.06~ 0.12 ~0.15	★ 180~ 220 ~250
	Mold steel	0.06~ 0.1 ~0.13	★ 150~ 180 ~220

★: 1st Recommendation

Applicable chipbreaker range

Coated carbide

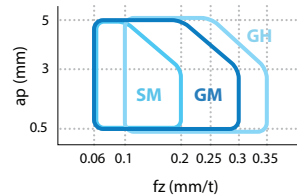

Cermet

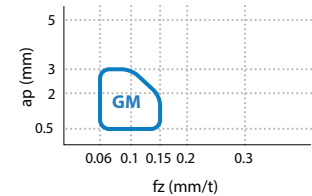

Applicable chipbreaker

Cutter type	Chipbreaker		
	GM	SM	GH
Fine pitch	✓	✓	✓
Extra fine pitch	✓	✓	△ (Feed rate is recommended fz=0.2mm/t or under)

High precision and high efficiency high rake cutter

MFSE45

Rough and finish in 1 pass with excellent surface finish

Roughing condition (fz = 0.25 mm/t) provides excellent surface finish (0.8 μmRa or less)

1 The MFSE45 milling solution

Delivers high-quality surfaces by roughing and finishing simultaneously

Kyocera's newly developed unique molded chipbreaker



Large A.R. design
(A.R. + 22°)

with wiper insert
(MFF technology)

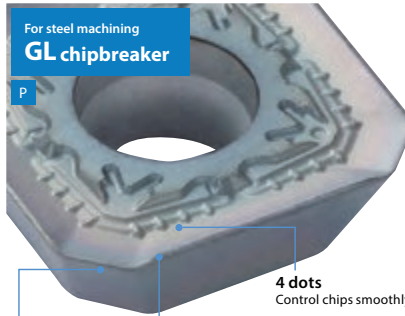

For steel machining
GL chipbreaker

P

Wiper edge
Excellent sharpness

Two-step land
Has both sharpness and cutting edge strength

4 dots
Control chips smoothly

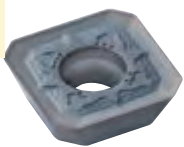

For stainless steel machining
SL chipbreaker

M
Micro-horning

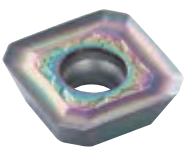

For aluminum machining
AL chipbreaker

N
Sharp edge

Machining comparison simulation (example)

MFSE45 1 Pass and cutting time was cut by 1/3, with a good surface finish (0.8 μmRa or less)

fz = 0.25 mm/t (ap = 1.0 mm)

Cutting conditions: Vc = 300 m/min, Dry C50 (Internal evaluation)



0.24μmRa

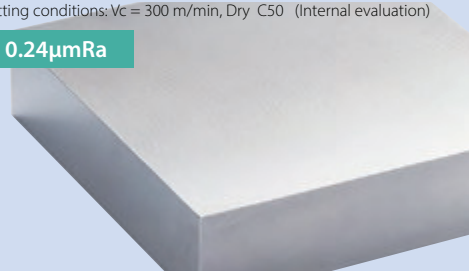

SOLUTION

1 Pass

Time = 1/3

Surface finish ✓

Conventional machining

Two separate passes for roughing and finishing. Cutting time is longer due to low feed rates during finishing

fz = 0.15 mm/t (ap = 0.8 mm)

fz = 0.125 mm/t (ap = 0.2 mm)



Cutting time

Roughing

Finishing

CG image

M
Milling

Cutting edge angle 45°~70°
Cutting edge angle 75°
Cutting edge angle 88°/90°
Cutter for Finishing
High Feed Cutter
Multi-Function
Slot Mill
Ball-nose Radius
Others

2 Beautiful surface finish and long tool life

Strict control of insert inscribed circle tolerance

Improved surface finish quality and longer tool life with reducing front edge runout



Excellent front edge runout accuracy

Advantage 1 Theoretical reduction of roughness on finished surface, excellent surface roughness

Front edge runout: Small ⇒
Surface roughness: Good

Advantage 2 Insert wear progresses evenly and tool life can be improved

Effect on wear (User evaluation)

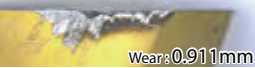
	Average corner examples	Heavily damaged corner examples	
MFSE45	 Wear: 0.145mm	 Wear: 0.172mm	Variation : Small
Competitor A	 Wear: 0.105mm	 Wear: 0.911mm	Variation : Large



Cutting conditions : Vc = 270 m/min, ap = ~ 1.5 mm, fz = 0.2 mm/t, Wet SS400 ø 250 (15 inserts) SL chipbreaker (PR1535)

Due to the high wear rate of the insert, all inserts need to be replaced, which may result in shorter tool life.

3 Various holders available for multiple applications

In addition to styles with a wiper insert, the standard type with only the standard inserts are also available

Toolholder Specifications

Type	With wiper insert 	Standard 
Surface roughness	Approx. 0.8µmRa	Approx. 1.6µmRa
Recommended feed	fz = 0.25 mm/t	fz = 0.12 mm/t (Finish machining time)
Application	High efficiency finishing 	General purpose (Uses 1 insert style)

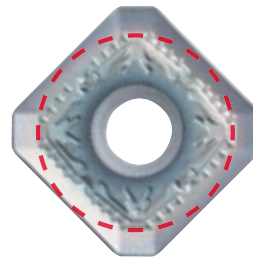

Inscribed circle tolerance
± 0.015 mm or less

(Class E standard ± 0.025 mm or less)

Surface roughness in stainless steel machining (Internal evaluation)

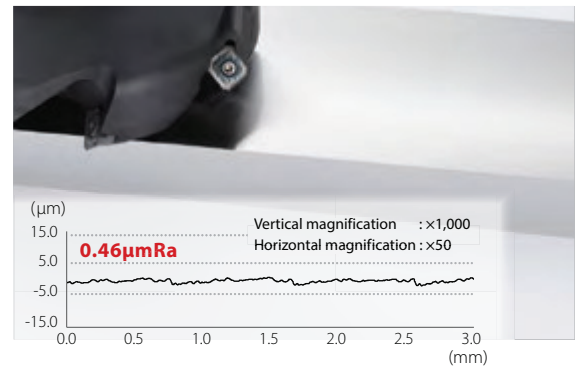

Cutting conditions : Vc = 250 m/min, ap x ae = 1.0 x 100 mm, fz = 0.15 mm/t, Wet X5CrNi18 10 ø125 (Standard 6 inserts) SL chipbreaker



MFSE45

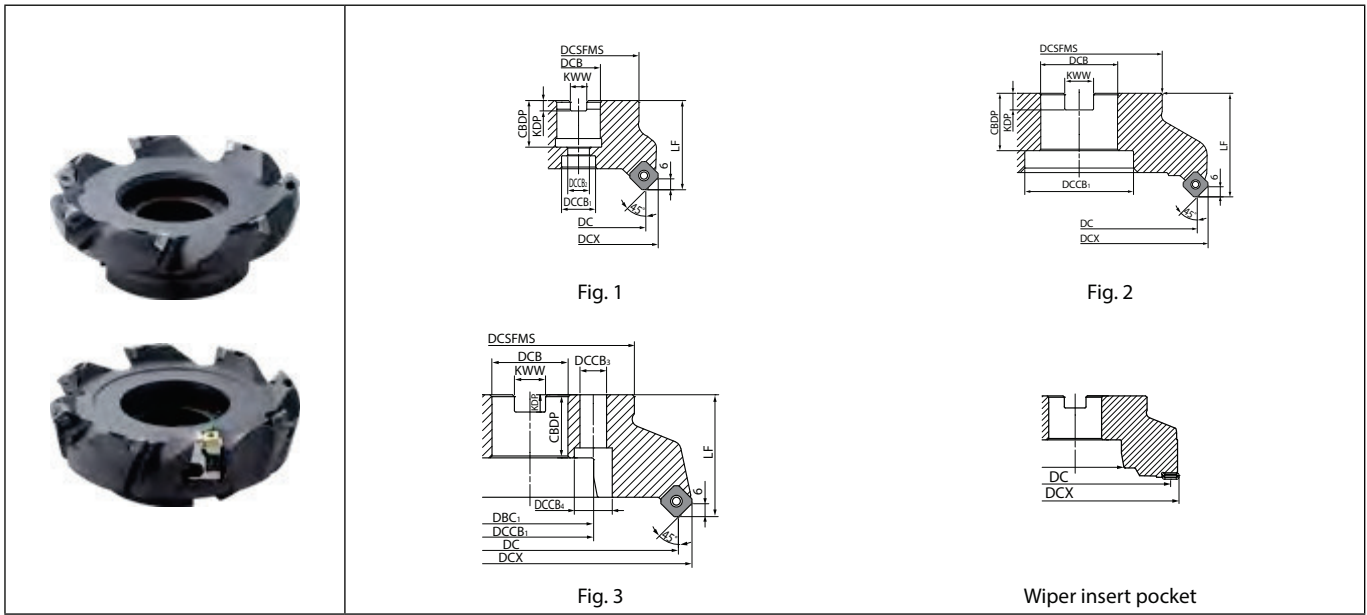

Toolholder dimensions

Description	Availability		Inserts	Dimension (mm)											Coolant hole	Max. revolution (min ⁻¹)	Weight (kg)	Fig.	Applicable inserts M30 M172			
	R	L		DC	DCX	DCB	DCCB ₁	DCCB ₂	DCCB ₃	DCCB ₄	DBC ₁	LF	CBDP	KDP						KWW		
Standard Metric	●		5	63	71.7	22	5					50	21	6.3	10.4	No	14400	0.6	1	SEET13T3...		
				80	88.7	27							24	7	12.4		12800	1.4	1			
				100	108.7	32							30	8	14.4		11500	1.8	2			
			6	125	133.7	40	6	63	33	9	16.4	10200	3.2	2								
				160	168.7	7	14		20			66.7	9000	5.4	3							
				200	208.7	8	18		26			101.6	8100	7	3							
				250	258.7	10							40	14	25.7	7200	15.5	3				
Standard Bore dia. inch spec	□		5	80	88.7	25.4	20	13				50	27	6	9.5	No	12800	1.4	1	SEET13T3...		
				100	108.7	31.75	48	32					8	12.7	11500		1.9	2				
				125	133.7	38.1	55	63					10	15.9	10200		3.3	2				
			160	168.7	50.8	72	11		19.1	9000	5.3	2										
			200	208.7	47.625	100	40		14	25.4	8100	7.3			3							
			250	258.7	110	18					26	101.6			7200	15.8	3					
			Wiper insert Metric	●		8	160	168.7	40	8	-	-	-	63	33	9	16.4	No	1000		5.5	2
200	212.8	60					1	9	18	26	101.6	40	14		25.7	800	7.3		3			
250	262.7	11					11	63	38	11	19.1	1000	12		3							
Wiper insert Bore dia. inch spec	□	8	160	168.7	50.8	72	-					-	-	63	38	11	19.1	No	1000	5.5	3	SEET13T3... LNGX1209...
			200	208.7	47.625	133	-					18	26		101.6	40	14		25.4	800	7.6	
			250	258.7	11	250	258.7	11	250	258.7	38	14	25.4		800	12.3	3					

● : Standard item R : Right-hand only L : Left-hand only □ : Check availability

M

Milling

Cutting edge angle 45°~70°

Cutting edge angle 75°

Cutting edge angle 88°/90°

Cutter for Finishing

High Feed Cutter

Multi-Function







Slot Mill

Ball-nose Radius







Others

Spare parts

Common

Clamp Screw	Wrench	Shim	Shim screw	Wrench	Anti-seize compound
					
SB-35120TRP	DTPM-15	MFSE-105	SPW-5035	LW-3.5	P-37
Recommended tightening torque for insert clamp 4N·m		Recommended tightening torque for shim clamp 5N·m			

For Wiper insert

Clamp screw	Wrench	Wedge	Cartridge	Cartridge clamp screw	Wrench	Adjustment Screw
						
SB-3592TR	DTM-10	AD-MFF	CR-MFF	HHSX15L	TTW-15	W6X18N
Recommended tightening torque for wiper insert clamp 1.2N·m						



Milling

SEET

Insert		Description	No. of edges	Dimension (mm)					Angle (°)		Carbide				Applicable toolholder ➔ M28
				IC	S	D1	RE	BS	AN	AS	CVD	DLC	PVD		
		Classification of usage													
		★ : Roughing / 1st Choice													
		☆ : Roughing / 2nd Choice													
		■ : Finishing / 1st Choice													
		□ : Finishing / 2nd Choice													
		(In case hardness is 45HRC or under)													
		Carbon steel / Alloy steel		☆☆★											
		Mold and die steel		☆☆★											
		Austenitic stainless steel		☆☆★											
		Martensitic stainless steel		★☆☆											
		Precipitation hardening stainless steel													
		Gray cast iron		★☆☆											
		Nodular cast iron		★☆☆											
		Non-ferrous metals		★											
		Heat-resistant alloy		★☆☆											
		Titanium alloy		★											
		Hard materials													
		SEET 13T3AGSN-GL	4	13.4	3.97	4.2	1.5	2.1	20	29	●	●	●	MFSE45...	
		General purpose													
		SEET 13T3AGSN-SL	4	13.4	3.97	4.2	1.5	2.1	20	29	●	●	●	MFSE45...	
		Stainless steel													
		SEET 13T3AGFN-AL	4	13.4	3.97	4.2	1.5	2.1	20	29	●			MFSE45...	
		Non-Ferrous Metals													

M



Milling

LNGX

Insert		Description	No. of edges	Dimension (mm)					Carbide	Cermet	Applicable toolholder ➔ M28 M171
				IC	S	D1	RE	INSL	PVD	PVD	
		LNGX 120916R-TT	4	9.525	4.76	4.2	1.6	12.7	MT0	MT0	MFSE45...-W MFSE45...-W-M MFE...-SF
		Low cutting force									
		LNGX 120916	4	9.525	4.76	4.2	1.6	12.7	MT0	MT0	MFSE45...-W MFSE45...-W-M MFE...-SF

Recommended cutting conditions ➔ M31

● : Standard item R : Right-hand only L : Left-hand only □ : Check availability MT0 : Made to order

M30

- Cutting edge angle 45°~70°
- Cutting edge angle 75°
- Cutting edge angle 88°/90°
- Cutter for Finishing
- High Feed Cutter
- Multi-Function
- Slot Mill
- Ball-nose Radius
- Others

Recommended cutting conditions

Chipbreaker	Workpiece	Feed (fz: mm/t)	Recommended insert grade (Vc: m/min)			
			MEGACOAT NANO		CVD coating	DLC coated carbide
			PR1535	PR1525	CA6535	PDL025
GL	Carbon steel	0.1 – 0.15 – 0.3	150 – 200 – 300	150 – 200 – 300	150 – 200 – 300	–
	Alloy steel	0.1 – 0.15 – 0.3	150 – 200 – 300	150 – 200 – 300	150 – 200 – 300	–
	Mold steel	0.1 – 0.15 – 0.25	100 – 150 – 250	100 – 150 – 250	100 – 150 – 250	–
	Stainless steel (Austenitic related)	0.1 – 0.15 – 0.25	100 – 200 – 250	100 – 200 – 250	100 – 200 – 250	–
	Stainless steel (Martensitic related)	0.1 – 0.15 – 0.25	100 – 200 – 250	100 – 200 – 250	100 – 200 – 250	–
	Gray cast iron	0.1 – 0.15 – 0.25	100 – 200 – 250	100 – 200 – 250	100 – 200 – 250	–
	Nodular cast iron	0.1 – 0.15 – 0.25	100 – 200 – 250	100 – 200 – 250	100 – 200 – 250	–
SL	Carbon steel	0.1 – 0.12 – 0.15	150 – 200 – 300	150 – 200 – 300	150 – 200 – 300	–
	Alloy steel	0.1 – 0.12 – 0.15	150 – 200 – 300	150 – 200 – 300	150 – 200 – 300	–
	Mold steel	–	–	–	–	–
	Stainless steel (Austenitic related)	0.1 – 0.15 – 0.2	100 – 200 – 250	100 – 200 – 250	100 – 200 – 250	–
	Stainless steel (Martensitic related)	0.1 – 0.15 – 0.2	100 – 200 – 250	100 – 200 – 250	100 – 200 – 250	–
AL	Aluminum alloys (Si Ratio 13% or less)	0.1 – 0.15 – 0.3	–	–	–	200 – 400 – 500

★ : 1st recommendation ☆ : 2nd recommendation

The number in **bold font** is recommended starting conditions. Adjust the cutting speed and the feed rate within the above conditions according to the actual machining situation.

M



Milling

Face mills for heavy milling

MFLN

Tough 4-edge tangential inserts provide high reliability on heavy milling at large depths of cut and high feed rates.

Three cutting edge angles (incl. MFLN90) optimized for various machining applications.

1 Tough and reliable inserts for stable heavy milling

22 mm long inserts offer increased rigidity

Tangentially mounted inserts provide
2 cutting edges on both sides

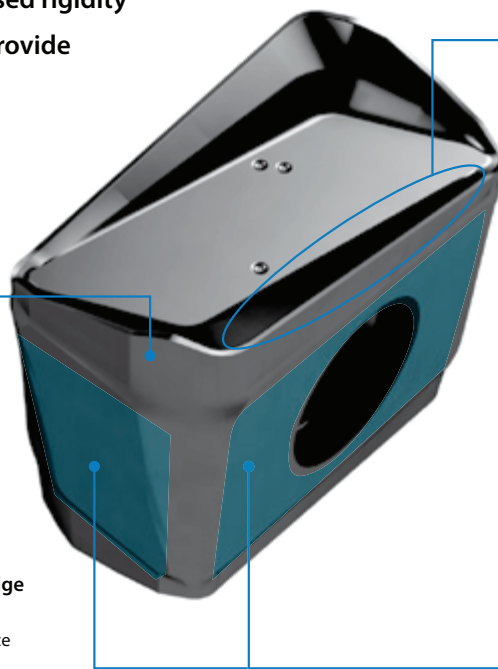

Obtuse edge design

Increases the cutting edge angle only at the tip to maintain both strength and sharpness

Cross-section view of cutting edge

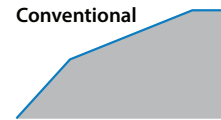
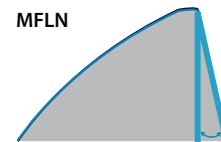

Corner chamfer

only available on MFLN90

Both general corner-R type and chamfered corner type available
Prevents chattering and insert fracturing

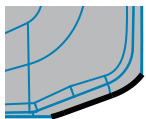

Convex cutting edge ridge
Reduced impact forces when entering the workpiece



Wide flat mounting surface

Hold an insert firmly in heavy milling

Tangentially mounted inserts increase rigidity

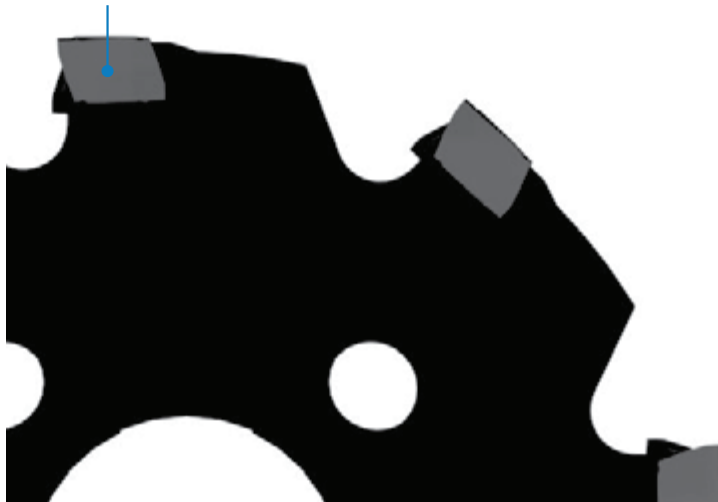

M



Milling

Cutting edge angle 45°~70°

Cutting edge angle 75°

Cutting edge angle 88°/90°

Cutter for Finishing

High Feed Cutter

Multi-Function

Slot Mill

Ball-nose Radius

Others

2 Large D.O.C. and high feed rates

MFLN45

Cutting edge angle 45°

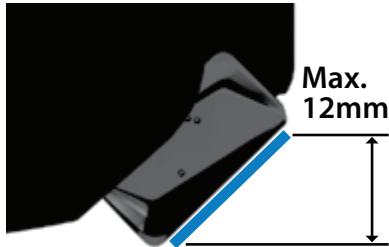

MFLN70

Cutting edge angle 70°

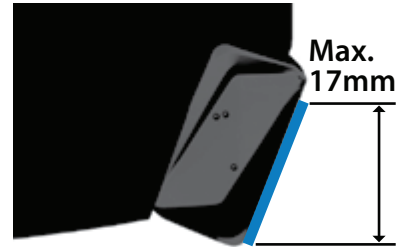

Applicable range

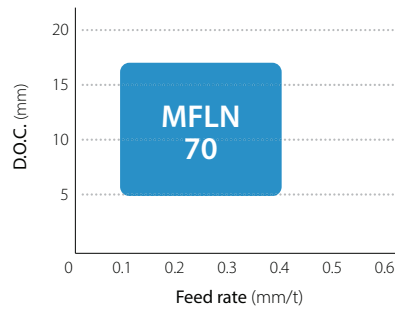
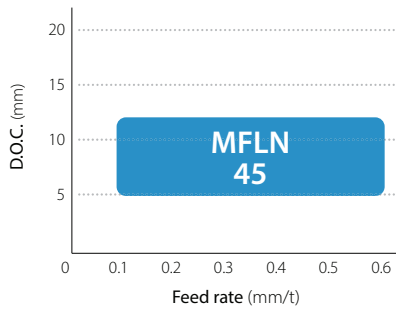

Case Studies

Forging Die for Automotive Parts

Vc = 90 m/min
 ap × ae = ~10 × ~80 mm
 fz = 0.36 mm/t Dry
 MFLN45080R-4T-M (ø80-4 flutes)
 LOGU221616ER-GM PR1535

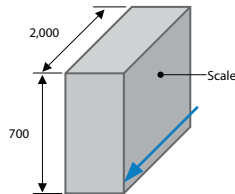

Chip Evacuation Rate

MFLN45
 (ø80-4 flutes)

Q=416 cc/min

Machining efficiency
x1.2

Competitor H
 (ø100-5 flutes)

Q=336 cc/min

MFLN achieved 1.2 times machining efficiency.
 Quieter machining and good chip shapes.

(User Evaluation)

Machining base GGG60

Vc = 120 m/min
 ap = 11×165 mm
 fz = 0.65 mm/t Dry
 XMFLN70250R-13T-OH-M (ø250-13 flutes)
 Fine pitch, internal coolant, custom holder
 LOGU221616ER-GM PR1525

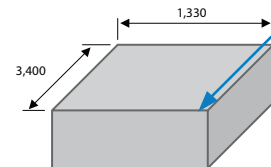

Chip Evacuation Rate

MFLN70

Roughing

Q=2,340 cc/min

Finishing

Q=2,340 cc/min

Machining efficiency
x1.1

Competitor

Roughing (Competitor F)
Q=2,100 cc/min

Finishing (Competitor G)

Q=1,970 cc/min

MFLN improved machining efficiency with lower cutting force.
 Also it can be used both for roughing and finishing.

(User Evaluation)



MFLN45

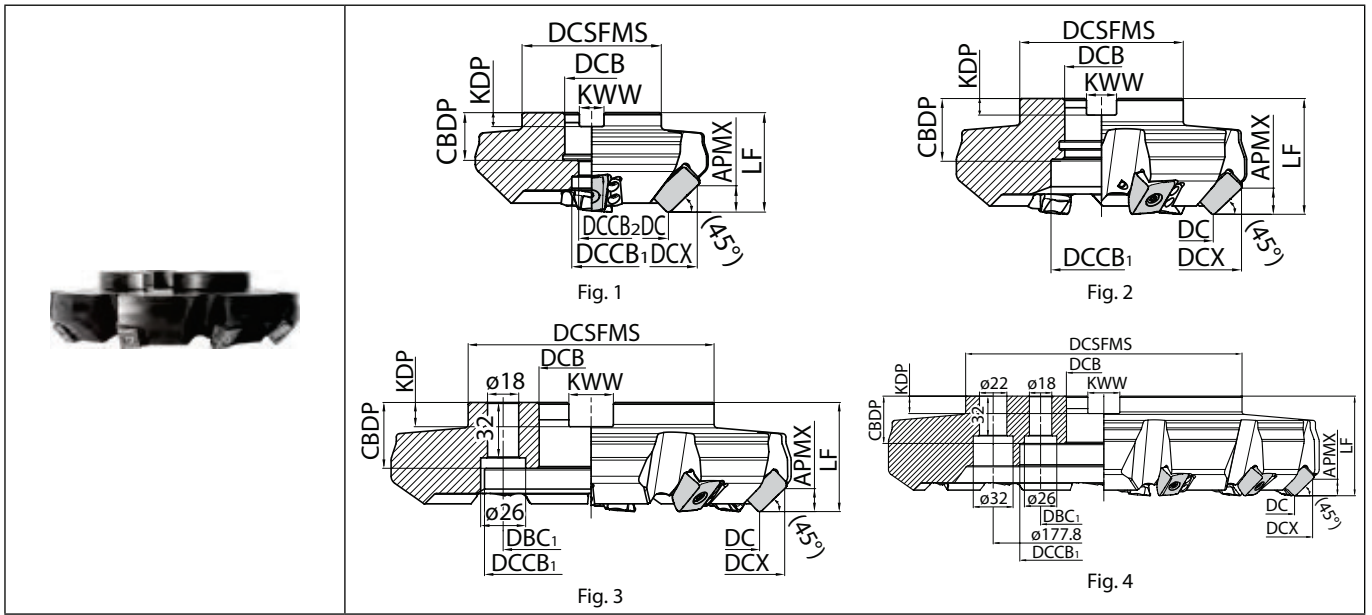

Toolholder dimensions

Description	Availability	Inserts	Dimension (mm)													A.R. max.(°)	R.R.(°)	Coolant hole	Max. revolution (min ⁻¹)	Weight (kg)	Fig.	Applicable inserts M36						
			R	DC	DCX	DCSFMS	DCB	DCCB ₁	DCCB ₂	DBC ₁	LF	CBDP	KDP	KWW	APMX								A.R. max.(°)	R.R.(°)	Coolant hole	Max. revolution (min ⁻¹)	Weight (kg)	Fig.
Metric	MFLN	45080R-4T-M	●	4	80	104	70	27	20	13	-	50	24	7	12.4	12	+2	-15.5	Yes	5970	2	1	LOGU221616ER-GM					
		45100R-4T-M	●	4	100	124	78	32	45	-	50	30	8	14.4	-14.5					4780	2.7	2						
		45125R-6T-M	●	6	125	149	89	40	55	-	63	33	9	16.4	-13.5					3820	4.6	2						
		45160R-7T-M	●	7	160	184	110	90	66.7	63	38	14	25.7	-13.5	2990					6.7	3							
		45200R-8T-M	●	8	200	224	142	124	101.6	80	38	14	25.7	-13.5	2390					9.7	3							
		45250R-10T-M	●	10	250	274	222	60	160	101.6	80	14	25.4	-13.5	1910					16.9	3							
		45315R-12T-M	●	12	315	339	222	215	101.6	80	14	25.4	-13.5	1520	25.1					4								
Bore dia. inch spec	MFLN	45080R-4T	□	4	80	104	70	25.4	20	13	-	50	27	6	9.5	12	+2	-15.5	Yes	5970	2	1	LOGU221616ER-GM					
		45100R-4T	□	4	100	124	78	31.75	45	-	50	34	8	12.7	-14.5					4780	2.7	2						
		45125R-6T	□	6	125	149	89	38.1	55	-	63	10	15.9	-13.5	3820					4.6	2							
		45160R-7T	□	7	160	184	110	50.8	90	-	63	11	19.1	-13.5	2990					6.8	2							
		45200R-8T	□	8	200	224	142	124	101.6	80	38	14	25.4	-13.5	2390					10	3							
		45250R-10T	□	10	250	274	222	47.625	160	101.6	80	14	25.4	-13.5	1910					17.1	3							
		45315R-12T	□	12	315	339	222	215	101.6	80	14	25.4	-13.5	1520	25.3					4								

● : Standard item R : Right-hand only L : Left-hand only □ : Check availability

M34

M

Milling

Cutting edge angle 45°~70°

Cutting edge angle 75°

Cutting edge angle 88°/90°

Cutter for Finishing

High Feed Cutter

Multi-Function

Slot Mill

Ball-nose Radius

Others

MFLN70

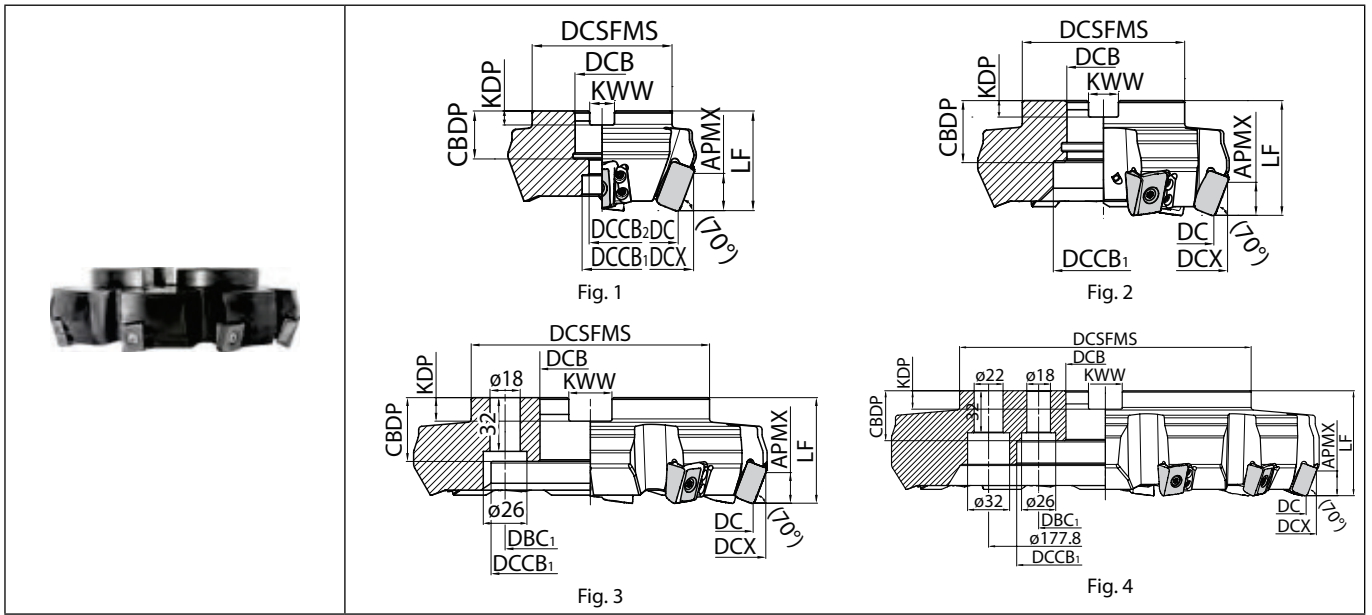

Toolholder dimensions

Description	Availability	Inserts	Dimension (mm)														A.R. max. (°)	R.R. (°)	Coolant hole	Max. revolution (min ⁻¹)	Weight (kg)	Fig.	Applicable inserts M36	
			R	DC	DCX	DCSFMS	DCB	DCB _h	DCB ₂	DBC ₁	LF	CBDP	KDP	KWW	APMX	Max. rev.								Weight
Metric	●	4	80	93	70	27	20	13	-	50	24	7	12.4	17	+1	-16.5	Yes	5970	1.4	1	LOGU221616ER-GM			
		6	100	113	78	32	45	-	-	30	8	14.4	4780					1.9	2					
		6	125	138	89	40	55	-	-	33	9	16.4	3820					3.4	2					
		7	160	173	110	40	90	-	66.7	63	38	14	25.7					2990	5.3	3				
		8	200	213	142	60	120	-	101.6	80	38	14	25.4					2390	8.2	3				
		10	250	263	222	60	160	-	101.6	80	38	14	25.4					1910	14.8	3				
		12	315	328	222	60	215	-	101.6	80	38	14	25.4					1520	21.9	4				
Bore dia. inch spec	□	4	80	93	70	25.4	20	13	-	50	27	6	9.5	17	+1	-16.5	Yes	5970	1.4	1	LOGU221616ER-GM			
		6	100	113	78	31.75	45	-	-	34	8	12.7	4780					2	2					
		6	125	138	89	38.1	55	-	-	10	15.9	3820	3.5					2						
		7	160	173	110	50.8	70	-	-	11	19.1	2990	5.8					2						
		8	200	213	142	60	120	-	101.6	80	38	14	25.4					2390	8.5	3				
		10	250	263	222	60	160	-	101.6	80	38	14	25.4					1910	15.1	3				
		12	315	328	222	60	215	-	101.6	80	38	14	25.4					1520	22.2	4				



Spare parts

Description	Parts						
	Clamp screw	Wrench	Shim	Clamp screw	Wrench	Coat anti-seize compound	Arbor bolt
MFLN ○○080R-4T(-M)							HH12X35
MFLN ○○100R-4T(-M)	SB-60200TRP	TTP-20	MAP-2216	SB-40140TR	DTM-15	P-37	-
MFLN ○○315R-12T(-M)	Tightening torque for clamping insert 6.0 N·m		Tightening torque for clamping shim 3.5 N·m				

Coat Anti-seize Compound thinly on portion of taper and thread when insert is fixed.

● : Standard item R : Right-hand only L : Left-hand only □ : Check availability

LOGU

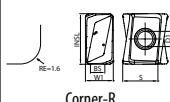
<p>Classification of usage</p> <p>★ : Roughing / 1st Choice ☆ : Roughing / 2nd Choice ■ : Finishing / 1st Choice □ : Finishing / 2nd Choice (In case hardness is 45HRC or under)</p>		Carbon steel / Alloy steel		★	☆	P						
		Mold and die steel		★	☆							
		Austenitic stainless steel				M						
		Martensitic stainless steel										
		Precipitation hardening stainless steel										
		Gray cast iron		★	☆	K						
		Nodular cast iron		★	☆							
		Non-ferrous metals				N						
		Heat-resistant alloy				S						
		Titanium alloy										
Hard materials				H								
Insert	Description	No. of edges	Dimension (mm)						Carbide		Applicable toolholder M34 M35 M130	
			S	D1	RE	W1	INSL	BS	PVD	PR1525 PR1535		
	 Corner-R	LOGU 221616ER-GM	4	16.6	6.8	1.6	12.5	22.8	6.3	●	●	MFLN45... MFLN70... MFLN90...

Recommended cutting conditions  M37

About applicable insert

	LOGU221616ER-GM (Corner-R)	LOGU2216PWER-GM (Corner Chamfer)
MFLN 45	✓	not applicable
MFLN 70	✓	not applicable

M



Milling

- Cutting edge angle 45°~70°
- Cutting edge angle 75°
- Cutting edge angle 88°/90°
- Cutter for Finishing
- High Feed Cutter
- Multi-Function
- Slot Mill
- Ball-nose Radius
- Others

● : Standard item R : Right-hand only L : Left-hand only □ : Check availability

M36

Recommended cutting conditions

	Workpiece	D.O.C. (mm)		fz: mm/t	Recommended insert grades (Vc: m/min)	
		Width of cut $\leq 0.5 \times DC$	Width of cut $> 0.5 \times DC$		MEGACOAT NANO	
					PR1535	PR1525
MFLN 70	Carbon steel	~15	~12	0.1 – 0.2 – 0.4	☆ 80 – 120 – 150	★ 100 – 150 – 180
	Alloy steel				☆ 80 – 120 – 150	★ 100 – 150 – 180
	Mold steel				☆ 70 – 100 – 120	★ 80 – 120 – 150
	Gray cast iron	~17	~15		☆ 80 – 120 – 150	★ 100 – 150 – 180
	Nodular cast iron				☆ 80 – 120 – 150	★ 100 – 150 – 180
MFLN 45	Carbon steel	~10	~8	0.1 – 0.3 – 0.6	☆ 80 – 120 – 150	★ 100 – 150 – 180
	Alloy steel				☆ 80 – 120 – 150	★ 100 – 150 – 180
	Mold steel				☆ 70 – 100 – 120	★ 80 – 120 – 150
	Gray cast iron	~12	~10		☆ 80 – 120 – 150	★ 100 – 150 – 180
	Nodular cast iron				☆ 80 – 120 – 150	★ 100 – 150 – 180

The table above provides recommendations based on product specifications.

Before using the product, check the machine's specifications such as power.

The number in bold font is recommended starting conditions. Adjust the cutting speed and the feed rate within the above conditions according to the actual machining situation. Dry machining is recommended.

★ : 1st recommendation ☆ : 2nd recommendation

How to mount an insert

1. Completely eliminate chips and dust from the insert mounting side.
2. After mounting a clamp screw on the top edge of wrench, tighten the screw while keeping the insert pushed against the shim seat surface and holder surface (Fig.1,2)
3. Make sure that the identification on the top of the insert is the same in each pocket.(Fig.3)
4. Tighten the wrench (TTP-20) in while holding parallel to the clamp screw.
5. Tighten the insert clamp screw at an appropriate torque. (Recommended torque: 6.0 N-m)
6. After tightening, check that there is no gap between the insert and the surface of the shim, or between the side surface of insert and the holder surface. If there is a gap, remount the insert using the directions above.

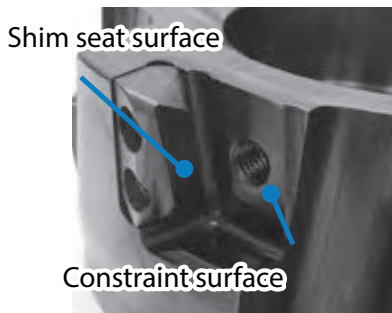

Fig.1

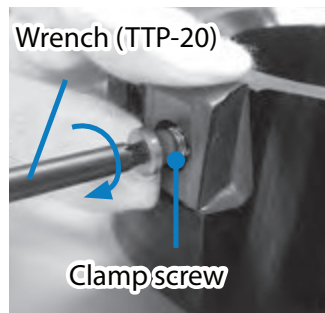

Fig.2



Fig.3

How to replace a shim

1. Completely eliminate chips and dust from the shim mounting side.
2. Coat medium strength screw locking adhesive on the screws.
3. Tighten the screw keeping the shim pushed against the pocket surface of toolholder.
4. After tightening both screws temporarily, tighten them with appropriate torque. (Recommended torque:3.5 N-m)
5. Please check that there is no gap between the shim and the pocket surfaces of toolholder.



Fig.1

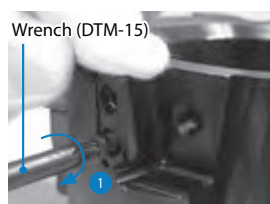

Fig.2

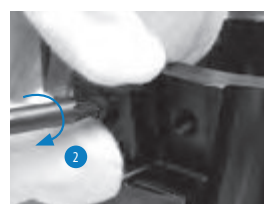

Fig.3



Fig.4



High efficiency cast iron machining

MFK

10-edge pentagonal inserts for stable and economical machining



MFK reduces cutting force by good balanced design
Excellent surface finish by controlling chattering

Surface finish comparison (Internal evaluation)

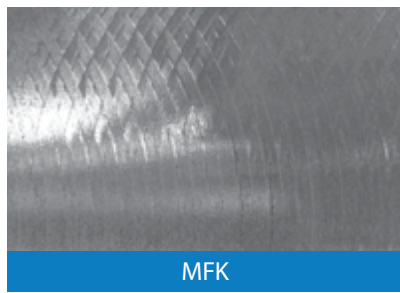

MFK

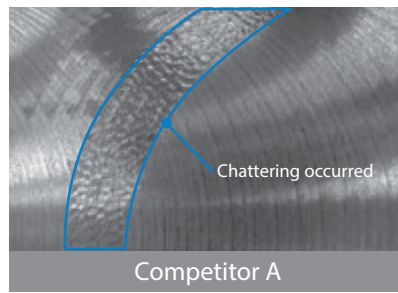

Competitor A

Cutting conditions:
Workpiece material: GGG60, Dry, $V_c=180\text{m/min}$, $a_{pxae}=3\times 78\text{mm}$, $f_z=0.3\text{mm/t}$

Burr comparison (Internal evaluation)

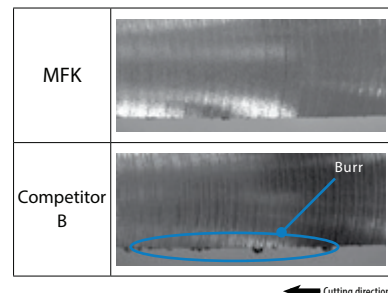

MFK

Competitor B

← Cutting direction

Sharp cutting prevents burr formation

Two special insert structures reduce cutting force and improve edge strength

1 Low cutting force with helical cutting-edge design



A.R. max. +15°

Cutting force comparison (Internal evaluation)

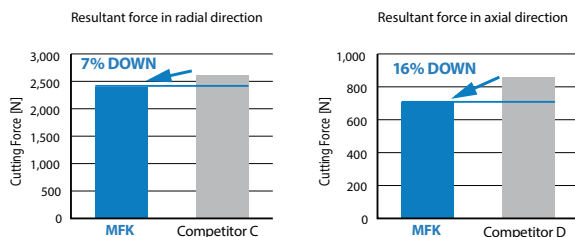

Cutting conditions:
Workpiece material: GGG60, dry, $\phi 125$
 $V_c=180\text{ m/min}$, $a_{pxae}=3.0\times 62\text{ mm}$, $f_z=0.3\text{ mm/t}$

2 Dual cutting edge design (High toughness)



Second main cutting edge

First main cutting edge

Fracture resistance comparison (Internal evaluation)

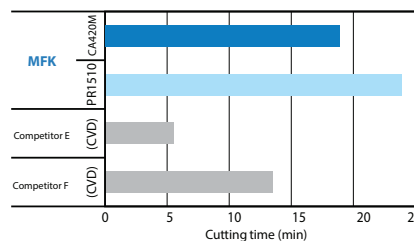

Cutting conditions:
Workpiece material: GGG45 with 4 bores
 $V_c=300\text{ m/min}$
 $a_p=2.0\text{ mm}$
 $f_z=0.5\text{ mm/t}$
Wet

Reducing impact load when biting into the workpiece

M



Milling

- Cutting edge angle 45°~70°
- Cutting edge angle 75°
- Cutting edge angle 88°/90°
- Cutter for Finishing
- High Feed Cutter
- Multi-Function
- Slot Mill
- Ball-nose Radius
- Others

Toolholder lineup to meet various applications

Fine pitch type and extra fine pitch type are available
Choose most suitable cutter for your application

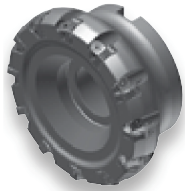

Fine pitch (Example: ϕ 125 12 flutes)

- Recommended for low rigid workpiece
- For wide application range



Extra fine pitch (Example: ϕ 125 18 flutes)

- Recommended for high rigid workpiece
- For high efficiency machining

Applicable to various applications with wide range lineup of chipbreakers

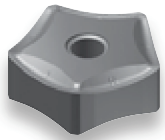

General purpose:
GM chipbreaker

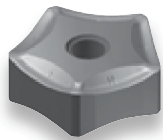

Tough edge:
GH chipbreaker

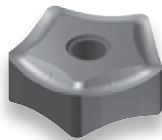

Finishing:
GL ground chipbreaker

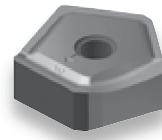

With wiper edge:
W ground chipbreaker

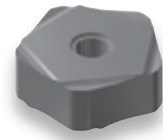

High speed machining:
Ceramic with chipbreaker

Insert grade lineup

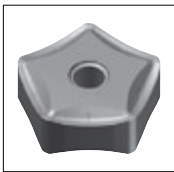

Long tool life
(1st Recommendation)
CA420M
(CVD)

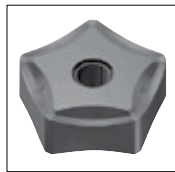

Stable machining
PR1510
(PVD)

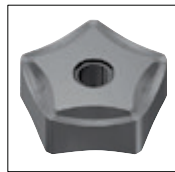

Fracture resistance
oriented
PR1525
(PVD)

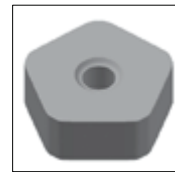

High speed machining
KS6050/CS7050
(Ceramic)

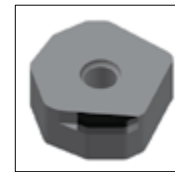

High speed and high
precision machining
KBN475
(CBN wiper insert)

Use CBN wiper inserts together with ceramic (KS6050/CS7050) inserts.



Wear resistance comparison (Internal evaluation)

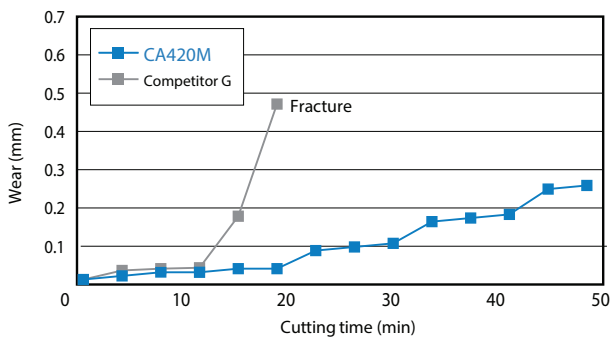

Cutting conditions:
Workpiece material: GGG45, dry
 $V_c=200$ m/min, $a_{pxae}=2.0 \times 80$ mm, $f_z=0.3$ mm/t

MFK

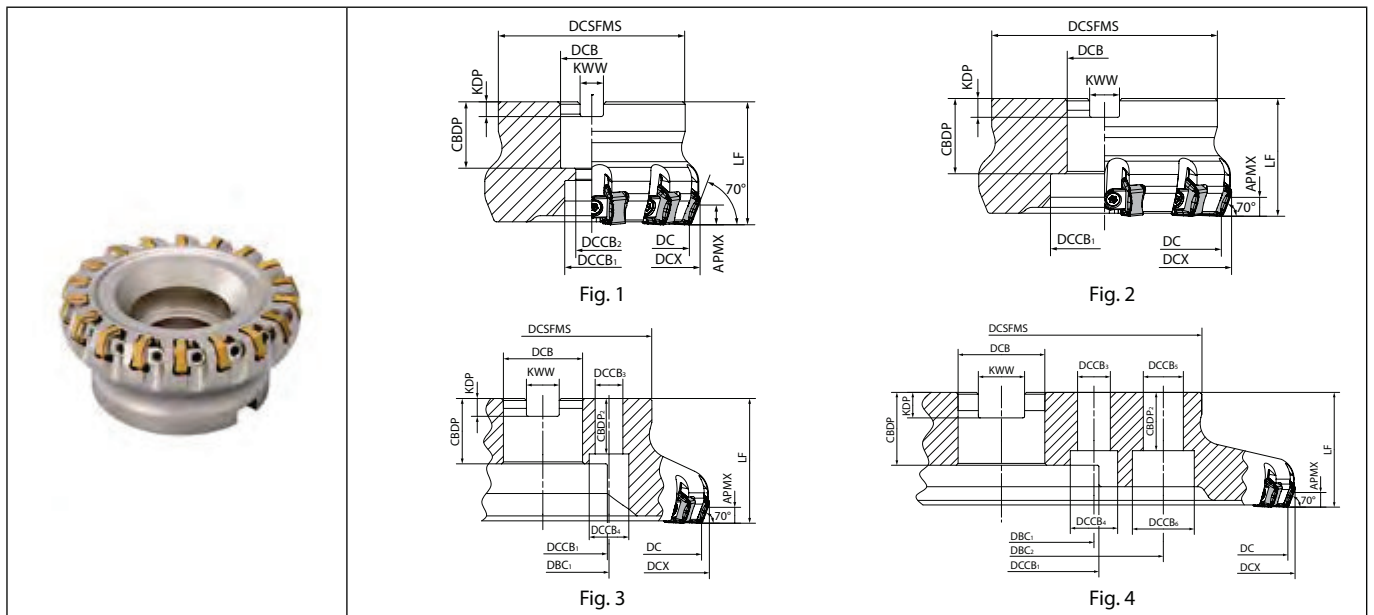

Toolholder dimensions









Description	Availability	Dimension (mm)																		A.R. max. (°)	R.R. (°)	Coolant hole	Max. revolution (min ⁻¹)	Weight (kg)	Fig.
		Inserts																							
		R	DC	DCX	DCSFMS	DCB	DCCB ₁	DCCB ₂	DCCB ₃	DCCB ₄	DCCB ₅	DCCB ₆	DBC ₁	DBC ₂	LF	CBDP	KDP	KWW	APMX						
Metric Fine pitch	MFK	●	8	80	89	76	27	20	13							24	7	12.4			-7	8000	1.87	1	
	MFK	●	10	100	109	96	32	26	17							28	8	14.4			-6	7000	2.99	1	
	MFK	●	12	125	134			55								33	9	16.4			No	6100	3.56	2	
	MFK	●	16	160	169			70			14	20			66.7				6	28	+15	5300	4.51	3	
	MFK	●	20	200	209											40	14	25.7			-5	4700	7.35	3	
	MFK	●	24	250	259	142	60	110			18	26			101.6				32			4200	10.43	3	
MFK	MTO	28	315	324	220									22	32			177.8			3700	19.41	4		
Metric Extra fine pitch	MFK	●	10	80	89	76	27	20	13							24	7	12.4			-7	8000	1.81	1	
	MFK	●	14	100	109	96	32	26	17							28	8	14.4			-6	7000	2.86	1	
	MFK	●	18	125	134			55								33	9	16.4			No	6100	3.38	2	
	MFK	●	22	160	169			70			14	20			66.7				6	28	+15	5300	4.32	3	
	MFK	●	28	200	209											40	14	25.7			-5	4700	7.1	3	
	MFK	●	36	250	259	142	60	110			18	26			101.6				32			4200	10.07	3	
MFK	MTO	44	315	324	220									22	32			177.8			3700	18.92	4		
Bole dia. inch spec Fine pitch	MFK	□	8	80	89	76	31.75	26	17							32	8	12.7			-7	8000	1.76	1	
	MFK	□	10	100	109	96															-6	7000	2.98	1	
	MFK	□	12	125	134			38.1	55							38	10	15.9			No	6100	3.65	2	
	MFK	□	16	160	169			50.8	70							11	19.1		6	+15	5300	4.62	2		
	MFK	□	20	200	209											40	14	25.4			-5	4700	7.65	3	
	MFK	□	24	250	259	142	47.625	110			18	26			101.6				32			4200	10.73	3	
MFK	□	28	315	324	220									22	32			177.8			3700	19.71	4		
Bole dia. inch spec Extra fine pitch	MFK	□	10	80	89	76	31.75	26	17							32	8	12.7			-7	8000	1.7	1	
	MFK	□	14	100	109	96															-6	7000	2.85	1	
	MFK	□	18	125	134			38.1	55							38	10	15.9			No	6100	3.44	2	
	MFK	□	22	160	169			50.8	70							11	19.1		6	+15	5300	4.44	2		
	MFK	□	28	200	209											40	14	25.4			-5	4700	7.4	3	
	MFK	□	36	250	259	142	47.625	110			18	26			101.6				32			4200	10.36	3	
MFK	□	44	315	324	220									22	32			177.8			3700	19.21	4		

Max. revolution : Do not use the cutter at the maximum revolution or higher since the centrifugal force may cause inserts and parts to scatter even under no load.

● : Standard item R : Right-hand only L : Left-hand only □ : Check availability MTO : Made to order

M40

Spare parts and applicable inserts (MFK)

Description	Spare parts				Applicable inserts ➔ M44	Description	Spare parts				Applicable inserts ➔ M44
	Wedge	Wedge screw	Wrench	Mounting bolt			Wedge	Wedge screw	Wrench	Mounting bolt	
											
MFK 080R-11-8T-M 100R-11-10T-M 125R-11-12T-M 160R-11-16T-M 200R-11-20T-M 250R-11-24T-M 315R-11-28T-M	C09N	W6X18N	TT-15	HH12X35	PNMG1106XNEN-GM PNMG1106XNEN-GH PNEG1106XNEN-GL PNEG1106XNER-W PNEA1106XNTN-T01020 PNEG1106XNTR-T00515 PNEG1106XNTR-T01015W	MFK 080R-11-8T 100R-11-10T 125R-11-12T 160R-11-16T 200R-11-20T 250R-11-24T 315R-11-28T	C09N	W6X18N	TT-15	HH16X40	PNMG1106XNEN-GM PNMG1106XNEN-GH PNEG1106XNEN-GL PNEG1106XNER-W PNEA1106XNTN-T01020 PNEG1106XNTR-T00515 PNEG1106XNTR-T01015W
				HH16X40							
MFK 080R-11-10T-M 100R-11-14T-M 125R-11-18T-M 160R-11-22T-M 200R-11-28T-M 250R-11-36T-M 315R-11-44T-M	C09N	W6X18N	TT-15	HH12X35	PNMG1106XNEN-GM PNMG1106XNEN-GH PNEG1106XNEN-GL PNEG1106XNER-W PNEA1106XNTN-T01020 PNEG1106XNTR-T00515 PNEG1106XNTR-T01015W	MFK 080R-11-10T 100R-11-14T 125R-11-18T 160R-11-22T 200R-11-28T 250R-11-36T 315R-11-44T	C09N	W6X18N	TT-15	HH16X40	PNMG1106XNEN-GM PNMG1106XNEN-GH PNEG1106XNEN-GL PNEG1106XNER-W PNEA1106XNTN-T01020 PNEG1106XNTR-T00515 PNEG1106XNTR-T01015W
				HH16X40							

M



Milling

MFK-SF

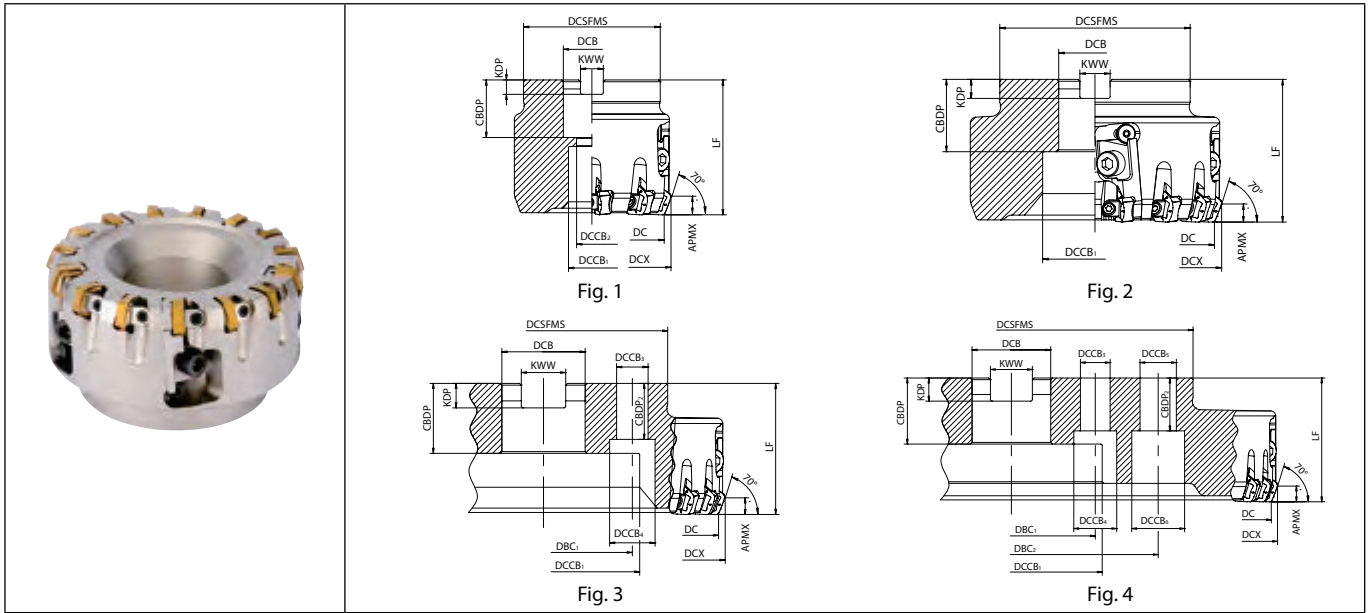

Toolholder dimensions

Description	Availability	Inserts	Dimension (mm)																A.R. max. (°)	R.R. (°)	Coolant hole	Max. revolution (min ⁻¹)	Weight (kg)	Fig.			
			R	DC	DCX	DCSFMS	DCB	DCCB ₁	DCCB ₂	DCCB ₃	DCCB ₄	DCCB ₅	DCCB ₆	DBC ₁	DBC ₂	LF	CBDP	KOP							KWW	APMX	CBDP ₂
Metric	MFK	080R-11-9T-M-SF	●	9 (3)	80	89	76	27	20	13							24	7	12.4			-7	8000	2.21	1		
		100R-11-12T-M-SF	●	12 (4)	100	109	96	32	26	17							28	8	14.4			-6	7000	3.49	1		
		125R-11-15T-M-SF	●	15 (5)	125	134	100	40	55								33	9	16.4				6100	4.47	2		
		160R-11-18T-M-SF	●	18 (6)	160	169	100	40	55								33	9	16.4				5300	6.99	3		
		200R-11-24T-M-SF	●	24 (8)	200	209	142	60	110								35	14	25.7			-5	4700	9.89	3		
		250R-11-30T-M-SF	MT0	30 (10)	250	259	142	60	110								35	14	25.7				4200	16.35	3		
		315R-11-39T-M-SF	MT0	39 (13)	315	324	220	60	110								35	14	25.7				3700	28.14	4		
Bore dia. inch spec	MFK	080R-11-9T-SF	□	9 (3)	80	89	76	31.75	26	17							32	8	12.7			-7	8000	2.08	1		
		100R-11-12T-SF	□	12 (4)	100	109	96	31.75	26	17							32	8	12.7			-6	7000	3.49	1		
		125R-11-15T-SF	□	15 (5)	125	134	100	38.1	55								38	10	15.9				6100	4.54	2		
		160R-11-18T-SF	□	18 (6)	160	169	100	38.1	55								38	10	15.9				6100	4.54	2		
		200R-11-24T-SF	□	24 (8)	200	209	142	50.8	70								40	14	25.4			+15	5300	6.82	2		
		250R-11-30T-SF	□	30 (10)	250	259	142	47.625	110								40	14	25.4			-5	4700	10.39	3		
		315R-11-39T-SF	□	39 (13)	315	324	220	47.625	110								40	14	25.4				4200	16.85	3		
																						3700	28.65	4			

Max. revolution : Do not use the cutter at the maximum revolution or higher since the centrifugal force may cause inserts and parts to scatter even under no load.

Numbers in parentheses () are the number of adjustable cutting edge pockets.

Please install wiper inserts in the adjustable cutting edge pockets.

● : Standard item R : Right-hand only L : Left-hand only □ : Check availability MT0 : Made to order

M

Milling

Cutting edge angle 45°~70°

Cutting edge angle 75°

Cutting edge angle 88°/90°

Cutter for Finishing

High Feed Cutter









Multi-Function

Slot Mill

Ball-nose Radius

Others

Spare parts and applicable inserts (MFK-SF)

Description	Spare parts								Applicable inserts M44
	Wedge 	Wedge screw 	Wrench 	Cartridge 	Cartridge clamp screw 	Wrench 	Adjustment screw 	Mounting bolt 	
MFK 080R-11-9T-M-SF	C09N	W6X18N	TT-15	CR-MFK70R	HH8X25	LW-6	AJ-519TR	HH12X35	PNMG1106XNEN-GM PNMG1106XNEN-GH PNEG1106XNEN-GL PNEG1106XNER-W PNEA1106XNTN-T01020 PNEG1106XNTR-T00515 PNEG1106XNTR-T01015W
100R-11-12T-M-SF								HH16X40	
125R-11-15T-M-SF								-	
160R-11-18T-M-SF								-	
200R-11-24T-M-SF								-	
250R-11-30T-M-SF								-	
315R-11-39T-M-SF								-	
MFK 080R-11-9T-SF	C09N	W6X18N	TT-15	CR-MFK70R	HH8X25	LW-6	AJ-519TR	HH16X40	PNMG1106XNEN-GM PNMG1106XNEN-GH PNEG1106XNEN-GL PNEG1106XNER-W PNEA1106XNTN-T01020 PNEG1106XNTR-T00515 PNEG1106XNTR-T01015W
100R-11-12T-SF								-	
125R-11-15T-SF								-	
160R-11-18T-SF								-	
200R-11-24T-SF								-	
250R-11-30T-SF								-	
315R-11-39T-SF								-	

PNMG/PNEG/PNEA

Classification of usage			Material				Dimension (mm)				Coating		Applicable toolholder
			Carbon steel / Alloy steel	Mold and die steel	Austenitic stainless steel	Martensitic stainless steel	Precipitation hardening stainless steel	Gray cast iron	Nodular cast iron	Non-ferrous metals	Heat-resistant alloy	Titanium alloy	
Insert	Description	No. of edges	Dimension (mm)				Carbide		Ceramic		CBN	Applicable toolholder	
			S	INSL	BCH	BS	CVD	PVD	CVD	-			
	PNMG 1106XNEN-GM General purpose	10	6.35	17.23	2	2	●	●	●				MFK... MFK...-M MFK...-SF
	PNMG 1106XNEN-GH Tough edge	10	6.35	17.23	2	2	●	●	●				MFK... MFK...-M MFK...-SF
	PNEG 1106XNEN-GL Surface finish oriented	10	6.35	17.18	2.6	2.6	●	●	●				MFK... MFK...-M MFK...-SF
	PNEG 1106XNER-W 2-edge / With wiper edge	2	6.35	18.02	2	10	●	●	●				MFK... MFK...-M MFK...-SF
	PNEA 1106XNTN-T01020 High speed machining	10	6.5	16.94	1.5	1.5			●	●			MFK... MFK...-M MFK...-SF
	PNEG 1106XNTR-T00515 High speed machining (With Chipbreaker)	10	6.35	17.07	-	-			●	●			MFK... MFK...-M MFK...-SF
	PNEG 1106XNTR-T01015W 2-edge / Wiper insert	2	6.5	18.06	1.7	4.8					●		MFK... MFK...-M MFK...-SF

★ : Roughing / 1st Choice
 ☆ : Roughing / 2nd Choice
 ■ : Finishing / 1st Choice
 □ : Finishing / 2nd Choice
 (In case hardness is 45HRC or under)

M
Milling

- Cutting edge angle 45°~70°
- Cutting edge angle 75°
- Cutting edge angle 88°/90°
- Cutter for Finishing
- High Feed Cutter
- Multi-Function
- Slot Mill
- Ball-nose Radius
- Others

Handed insert shows Right-hand

Recommended cutting conditions **M45, M46**

PNEG1106XNER-W inserts are sold in 5 piece boxes

PNEG1106XNTR-T01015W inserts are sold in 1 piece boxes

● : Standard item R : Right-hand only L : Left-hand only □ : Check availability

M44

Recommended cutting conditions (Ceramic/CBN)

Without chipbreaker

Workpiece material	Insert grades	Vc (m/min)	Edge preparation	fz(mm/t)				
				0.05	0.1	0.2	0.3	0.4
Gray cast iron	KS6050 ★ CS7050 ☆	600~900~1,200	0.10x20°					
Nodular cast iron	KS6050 ☆ CS7050 ★	400~600~900						

With chipbreaker

Workpiece material	Insert grades	Vc (m/min)	Edge preparation	fz(mm/t)				
				0.05	0.1	0.2	0.3	0.4
Gray cast iron	KS6050 ★ CS7050 ☆	600~900~1,200	0.05x15°					
Nodular cast iron	KS6050 ☆ CS7050 ★	400~600~900						

CBN wiper insert

Workpiece material	Insert grades	Vc (m/min)	Edge preparation	fz(mm/t)				
				0.05	0.1	0.2	0.3	0.4
Gray cast iron	KBN475	600~900~1,200	0.10x15°					
Nodular cast iron		400~600~900						

★ : 1st Recommendation ☆ : 2nd Recommendation

Recommended application range (Ceramic/CBN)

Workpiece material: Cast iron
(Ceramic)

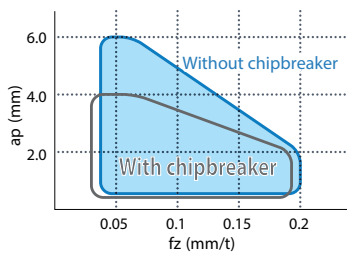

Workpiece material: Cast iron
(CBN)

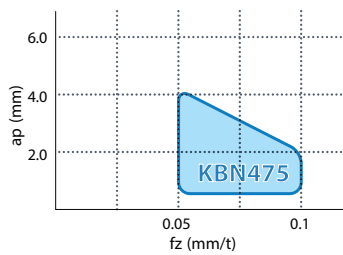

When using CBN wiper inserts

1. Please use CBN wiper inserts together with ceramic inserts. Feed rate should be fz=0.1mm/t or under.
2. The main cutting edge of CBN wiper insert is slightly higher than that of ceramic inserts. Therefore, the feed rate for the inserts next to CBN wiper inserts is double that of other inserts.

M



Milling

Recommended cutting conditions (Coated carbide)

Workpiece material	Insert grades	Vc (m/min)	Chipbreaker	fz (mm/t)				
				0.06	0.1	0.2	0.3	0.4
Gray cast iron	CA420M	170~230~300	GM ★			0.25		
	PR1510	120~180~250	GH ☆				0.3	
	PR1525		GL		0.12			
Nodular cast iron	CA420M	150~200~250	GM ★			0.2		
	PR1510	100~150~200	GH ☆				0.25	
	PR1525		GL		0.1			

★ : 1st Recommendation ☆ : 2nd Recommendation

Recommended application range

Workpiece material: Gray cast iron

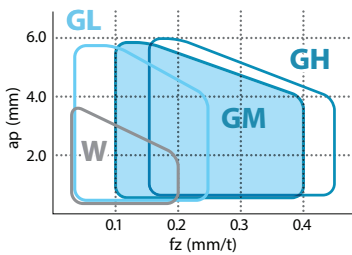

Workpiece material: Nodular cast iron

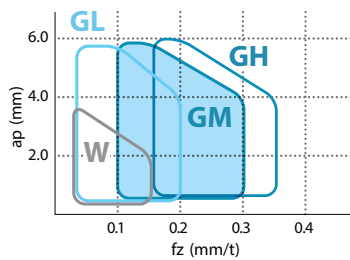

Notes:

1. When using W, please use together with GM or GH.
2. If machining fz=0.2 or over, insert corner will be damaged. The main cutting edge of W insert is receding from that of GM and GH. Therefore, the feed rate for the insert next to W type is double of the other inserts.

How to adjust cutting edge height

1. Assemble all related parts into the cutter.
2. Make sure the back end of cartridge makes contact with adjustment screw (Fig. 1), and pull them lightly inwards (Fig. 2). Tighten the cartridge clamp screw temporary.
3. Install the insert (Fig. 3), and tighten the wedge screw temporary. Temporarily tighten the screw with a 40 to 45 degree rotation after the wedge contacts the insert.
4. Loosen the cartridge clamp screw. (Fig. 4)
5. Adjust the extruding amount with adjustment screw. (Fig. 5)
6. Tighten the wedge screw and firmly fix the insert. (Recommended tightening torque: 6N·m)
7. Tighten the cartridge clamp screw firmly. (Recommended tightening torque: 10N·m)

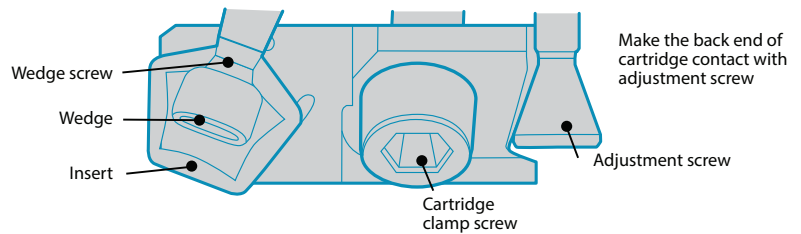

Fig. 1



Fig. 2



Fig. 3

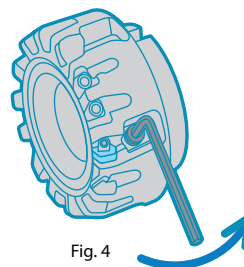

Fig. 4

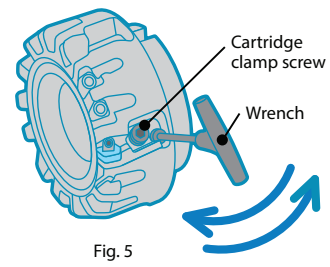

Fig. 5

Notes:

1. Follow steps 1 ~ 7 above for adjustment.
2. To adjust the edge height adjust the wedge screw and loosen the cartridge clamp screw. Tightening the adjustment screw with the clamp screw fixed firmly may damage the adjustment screw.
3. The adjusted edge height difference must be within 5µm.

M



Milling

Cutting edge angle 45°~70°

Cutting edge angle 75°

Cutting edge angle 88°/90°

Cutter for Finishing

High Feed Cutter





Multi-Function

Slot Mill

Ball-nose Radius

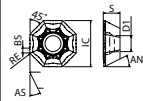
Others

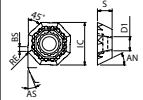
OFMT (Inserts for MOF45)

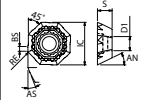
Insert		Description	No. of edges	Dimension (mm)					Angle (°)		Carbide	Applicable toolholder
				IC	S	D1	RE	BS	AN	AS	PVD	
											PR1210	
<p>Classification of usage</p> <p>★ : Roughing / 1st Choice ☆ : Roughing / 2nd Choice ■ : Finishing / 1st Choice □ : Finishing / 2nd Choice (In case hardness is 45HRC or under)</p>										★	P	
										★	M	
										★	K	
										★	N	
										★	S	
										□	H	
		OFMT 050405EN-GT	8	13.35	4.83	4.6	0.5	1.4	26	26	□ □	MOF45...-05-...
		OFMT 070408EN-GT	8	17.85	5.12	5.9	0.8	1.2	26	26	□ □	MOF45...-07-...
		OFMT 050405ER-SH	8	13.47	4.76	4.4	0.5	1.7	26	22	□ □	MOF45...-05-...
		OFMT 070405EN-SH	8	17.98	4.87	5.8	0.5	-	26	26	□ □	MOF45...-07-...

Handed insert shows Right-hand



● : Standard item R : Right-hand only L : Left-hand only □ : Check availability

MSRS15 face mill for heavy milling

Large depth of cut and high feed rate achieves high efficiency machining

Recommended ap: 5 ~ 10mm

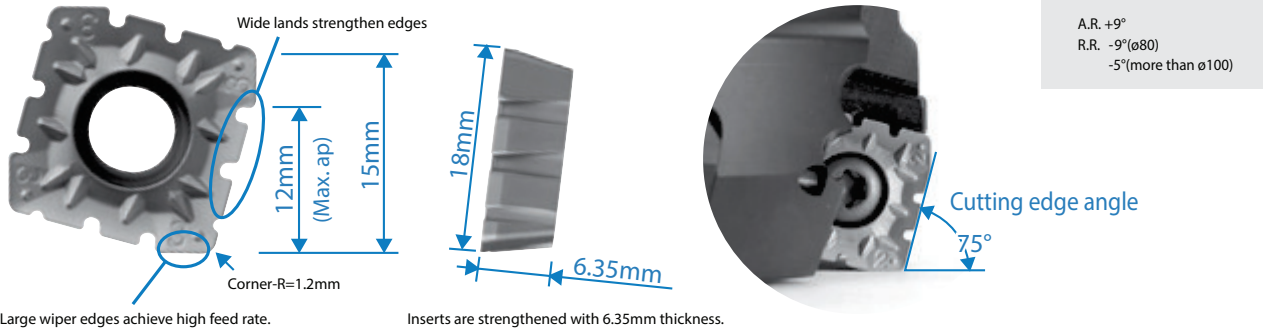

Selection of chipbreaker

	Low cutting force	General purpose	Edge strength oriented
Insert type	NB2P(4-Notched) + NB3P(5-Notched)	NB2(2-Notched) + NB3(3-Notched)	NB2T(2-Notched) + NB3T(3-Notched)
Applications	When using long arbor or for machining of thin-plate workpieces	General purpose type with good balance of strength and cutting force	For interrupted machining and high load machining When feed rate is increased or workpiece material is cast iron
Edge preparation	As many as four (or five) notches help to alleviate the shock when biting into the workpiece 	Strength, edge and chip control are all well balance 	Strength is increased by the edge shape and moderate rake angle of the chamfer edge

A supplemental chipbreaker is used when it is necessary to increase strength and bite while focusing on resistance, as when machining welded areas.



• About insert no. of NB2P (4-notched) and NB3P (5-notched)
In order to adjust applicable inserts on marked numbers on toolholders, "2+" is marked for NB2P (4-notched) and "3+" is marked on NB3P (5-notched).

Features of toolholder

Coarse pitch

Fine pitch

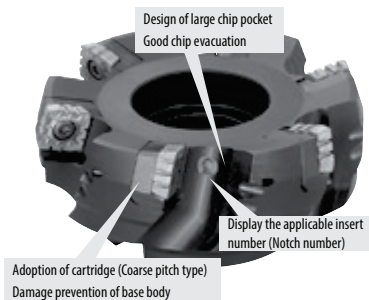

Higher productivity with fine pitch design



Insert replacement identification



Insert number is transcribed as a result of the cutting tool load.



* Depending on the cutting conditions, marks are not transcribed.

MSRS15

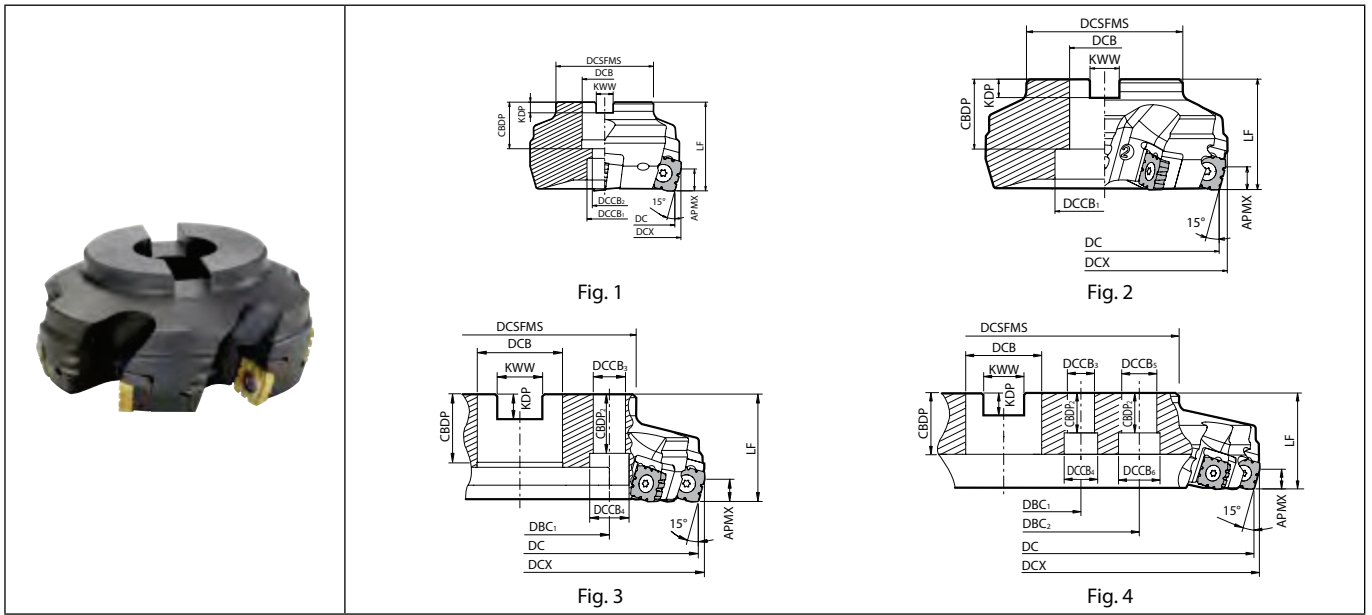

Toolholder dimensions

Description		Availability	Dimension (mm)																			A.R. (°)	R.R. (°)	Coolant hole	Weight (kg)	Fig.	Applicable inserts M50	
			Inserts	DC	DCX	DCSFMS	DCB	DCCB ₁	DCCB ₂	DCCB ₃	DCCB ₄	DCCB ₅	DCCB ₆	DBG	DBC ₂	LF	CBDP	KDP	KWW	APMX	CBDP ₂							
Metric	Coarse pitch	MSRS	●	4	80	87	70	27	20	13						50	24	7	12.4					-9		1.3	1	SPMT1806EDER... SPMT1806EDSR...
			●	4	100	107	85	32	45							29	8	14.4						-9		2	2	
			●	6	125	132		40	55							33	9	16.4						+9	No	3.6	2	
			●	8	160	167	110	40	68		14	20			66.7									-5	No	5	3	
			●	10	200	207		60	-		18	26			101.6									-5	No	7.7	3	
			●	12	250	257	140	60	-		18	26			101.6									-5	No	12	3	
	Fine pitch	MSRS	●	6	80	87	70	27	20	13						50	24	7	12.4					-9		1.3	1	
			●	6	100	107	85	32	45							29	8	14.4						-9		1.9	2	
			●	8	125	132		40	55							33	9	16.4						+9	No	3.5	2	
			●	10	160	167	110	40	68		14	20			66.7									-5	No	4.9	3	
			●	12	200	207		60	-		18	26			101.6									-5	No	7.6	3	
			●	14	250	257	140	60	-		18	26			101.6									-5	No	11.9	3	
Bore dia. inch spec	Coarse pitch	MSRS	□	4	80	87	55	25.4	20	13						50	26	6	9.5					-9		1.3	1	SPMT1806EDER... SPMT1806EDSR...
			□	4	100	107	70	31.75	42							32	8	12.7						-9		2	2	
			□	6	125	132	85	38.1	54							10	15.9							+9	No	3.6	2	
			□	8	160	167	100	50.8	68							11	19							-5	No	5	2	
			□	10	200	207		47.625	-		18	26			101.6									-5	No	7.7	3	
			□	12	250	257	130	47.625	-		18	26			101.6									-5	No	12	3	
	Fine pitch	MSRS	□	6	80	87	55	25.4	20	13						50	26	6	9.5					-9		1.3	1	
			□	6	100	107	70	31.75	42							32	8	12.7						-9		1.9	2	
			□	8	125	132	85	38.1	54							10	15.9							+9	No	3.5	2	
			□	10	160	167	100	50.8	68							11	19							-5	No	4.9	2	
			□	12	200	207		47.625	-		18	26			101.6									-5	No	7.6	3	
			□	14	250	257	130	47.625	-		18	26			101.6									-5	No	11.9	3	

Mounting bolt (HH12X35) is included for MSRS15080R-○(T)-(M).
Cartridge is included in the coarse pitch type, but no cartridge in the fine pitch type.

● : Standard item R : Right-hand only L : Left-hand only □ : Check availability MT0 : Made to order



Milling

SPMT

Insert		Description	No. of edges	Dimension (mm)					Angle (°)		Carbide			Applicable toolholder M49
				IC	S	D1	RE	BS	AN	AS	PVD			
											PR1210	PR1225	PR1230	
Classification of usage ★: Roughing / 1st Choice ☆: Roughing / 2nd Choice ■: Finishing / 1st Choice □: Finishing / 2nd Choice (In case hardness is 45HRC or under)										★	★		P	
										★	★		M	
										★			K	
													N	
										★	★		S	
										★			H	
		SPMT 1806EDER-NB2	4	18	6.35	6.8	1.2	3.1	11	15	●	●	●	MSRS15...
		SPMT 1806EDER-NB3	4	18	6.35	6.8	1.2	3.1	11	15	●	●	●	MSRS15...
		SPMT 1806EDER-NB2P	4	18	6.35	6.8	1.2	3.1	11	15	●	●	●	MSRS15...
		SPMT 1806EDER-NB3P	4	18	6.35	6.8	1.2	3.1	11	15	●	●	●	MSRS15...
		SPMT 1806EDSR-NB2T	4	18	6.35	6.8	1.2	3.1	11	15	●	●	●	MSRS15...
		SPMT 1806EDSR-NB3T	4	18	6.35	6.8	1.2	3.1	11	15	●	●	●	MSRS15...
		SPMT 1806EDER-V	4	18	6.35	6.8	1.2	3.1	11	15	●	●	●	MSRS15...

Handed insert shows Right-hand

Recommended cutting conditions M51

●: Standard item R: Right-hand only L: Left-hand only □: Check availability

M50

M

Milling

Cutting edge angle 45°~70°

Cutting edge angle 75°

Cutting edge angle 88°/90°

Cutter for Finishing

High Feed Cutter





Multi-Function

Slot Mill

Ball-nose Radius

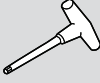
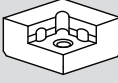
Others

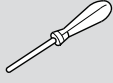
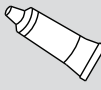
Spare parts (common to Metric / Inch spec)

Description		Spare parts								
		Clamp screw	Wrench	Cartridge	Clamp screw	Wrench	Anti-seize compound	Mounting bolt		
										
Coarse pitch	MSRS 15080R-○○(M)	SB-60120TR	TT-25L	MAP-1806	SB-40140TR	DT-15	P-37	HH12X35		
	MSRS 15100R-○○(M)							Recommended tightening torque for insert clamp 7.5N·m	Recommended tightening torque for cartridge clamp 3.5N·m	-
	15315R-○○(M)									
Fine pitch	MSRS 15080R-○○(M)	SB-60120TR	TT-25L	-	-	-	P-37	HH12X35		
	MSRS 15100R-○○(M)							Recommended tightening torque for insert clamp 7.5N·m	-	
	15315R-○○(M)									

 Coat anti-seize compound thinly on portion of taper and thread when insert is fixed.

Recommended cutting conditions

Workpiece material	fz (mm/t)			Recommended insert grades (Vc: m/min)		
	NB2P + NB3P	NB2 + NB3	NB2T + NB3T	MEGACOAT		
				PR1225	PR1230	PR1210
Carbon steel	0.15	0.2	0.3	☆ 120~180~250	★ 120~180~220	-
Alloy steel	0.15	0.2	0.3	☆ 120~180~250	★ 120~180~220	-
Mold steel	0.1	0.15	0.2	☆ 100~160~220	★ 100~160~200	-
Gray cast iron	0.2	0.25	0.35	-	-	★ 120~180~250
Nodular cast iron	0.15	0.2	0.3	-	-	★ 100~160~220
Stainless steel	Not recommended					
Aluminum/Copper	Not recommended					

★: 1st Recommendation ☆: 2nd Recommendation



Milling

Double-sided 4-edge insert

MEW

Kyocera's unique mold technology reduces cutting force equivalent to positive inserts

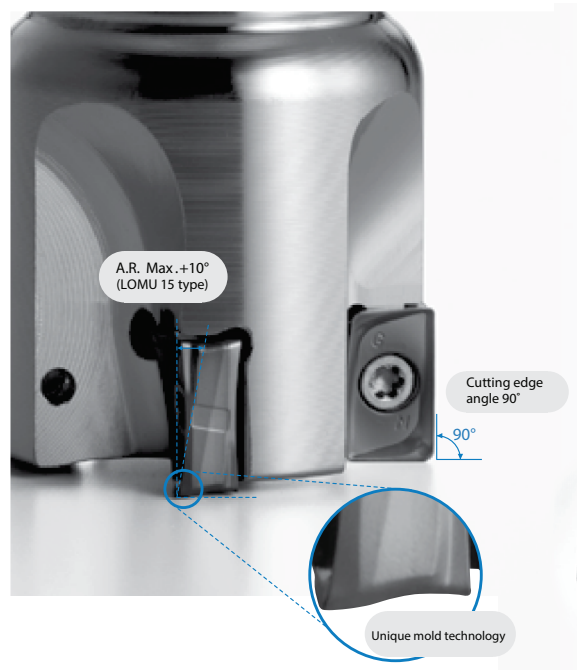
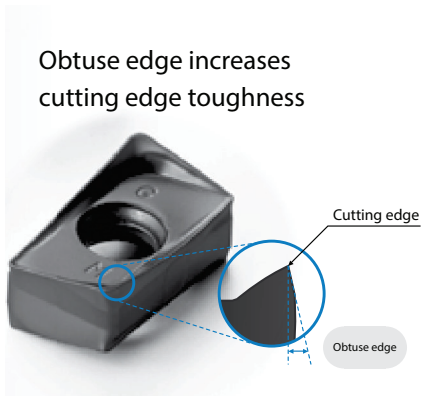

Low cutting force equivalent to positive inserts

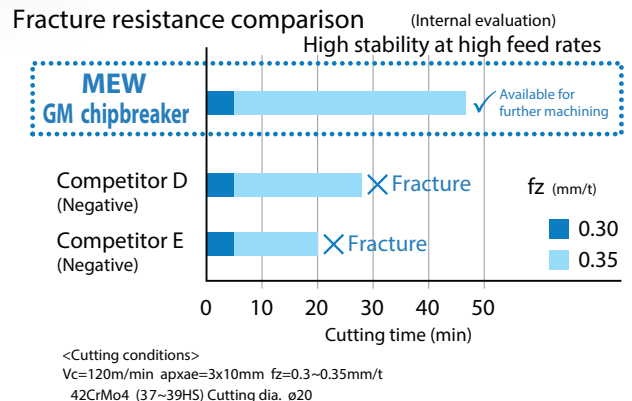
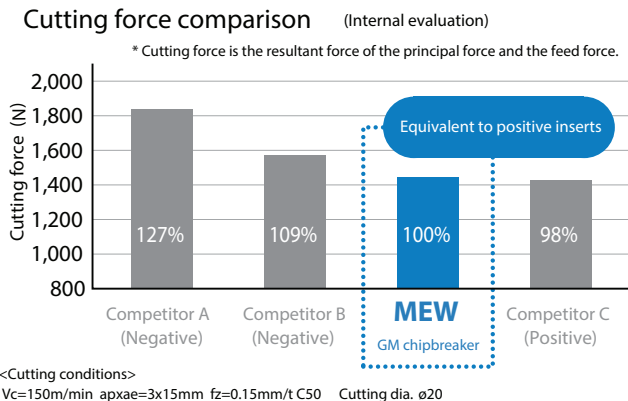

Improved surface finish, minimizing chattering

Sharp cutting and superior resistance to chattering and burrs with helical cutting edge and optimum axial rake design

Surface of shoulder wall (Internal evaluation)

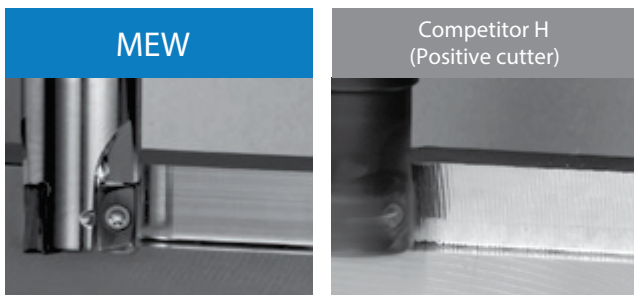

Smooth surface of MEW without chattering

<Cutting conditions>
Vc=240m/min apxae= 4 (3passes) x5mm fz=0.12mm/t Dry SS400 Cutting dia. ø20

Burr comparison with positive cutters (Internal evaluation)

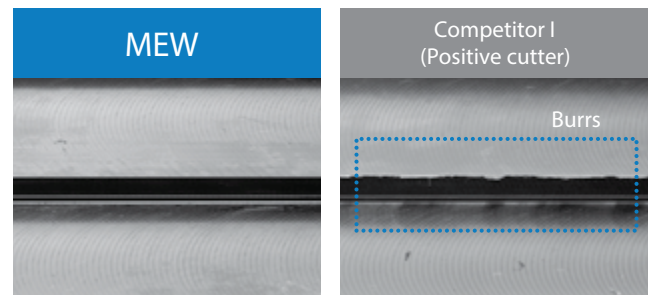

Sharp cutting enables less burrs than positive cutters

<Cutting conditions>
Vc=250m/min apxae=4x5mm fz=0.1mm/t Dry C50 Cutting dia. ø20

MEW GM chipbreaker	Competitor F (Negative)	Competitor G (Positive)
+20°	+17°	+17°

Large actual rake angle lowers cutting force

M

Milling

- Cutting edge angle 45°~70°
- Cutting edge angle 75°
- Cutting edge angle 88°/90°
- Cutter for Finishing
- High Feed Cutter
- Multi-Function
- Slot Mill
- Ball-nose Radius
- Others

Long tool life by MEGACOAT NANO technology

Stable and longer tool life by special nano coating layer "MEGACOAT NANO"

PR1525

For steel and stainless steel (austenitic related)

PR1510

For cast iron

PR1535

For heat-resistant alloys, titanium and stainless steel (precipitation hardening)

CA6535

CVD coated carbide for heat-resistant alloys and stainless steel (martensitic)

PDL025

DLC coated carbide for non-ferrous metals

GW25

Carbide for non-ferrous metals

Properties of coating

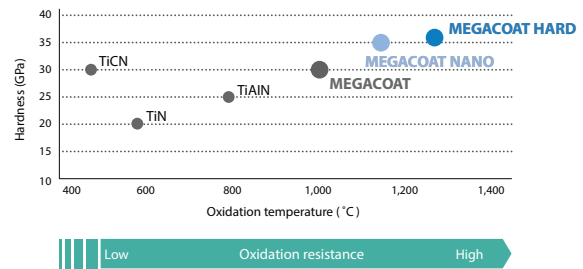

Prevents wear and fracture with high hardness (35GPa) and superior oxidation resistance (Oxidation temperature: 1,150°C)

PR015S

MEGACOAT HARD for hard materials

Various chipbreaker lineup

Newly developed 4 chipbreakers for various applications
Applicable to a wide range of application

Chipbreaker	Applications	Insert
GM	General purpose	
SM	Low cutting force	
GH	For heavy milling	
AM	For non-ferrous metals	

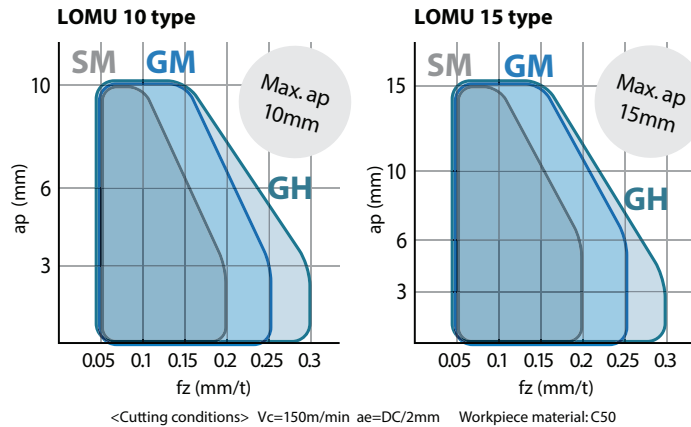

Lineup of corner-R(RE)

Corner-R(RE) 0.4, 1.0, 1.2, 1.6 and 2.0 added to GM chipbreaker lineup

LOMU100404ER-GM LOMU150504ER-GM	LOMU100408ER-GM LOMU150508ER-GM	LOMU150510ER-GM	LOMU100412ER-GM LOMU150512ER-GM	LOMU100416ER-GM LOMU150516ER-GM	LOMU100420ER-GM LOMU150520ER-GM

MEW

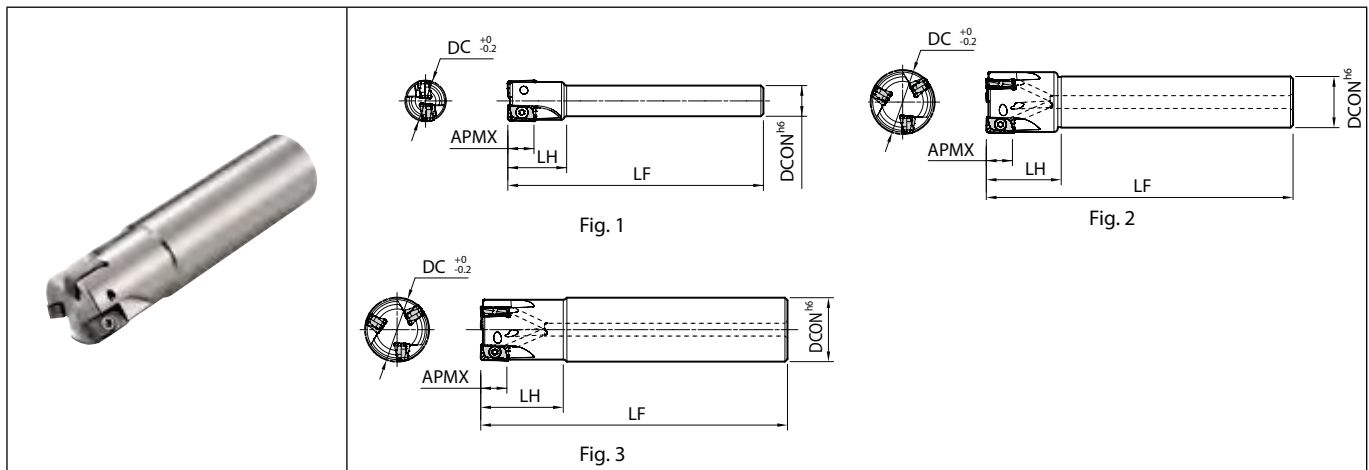

Toolholder dimensions

Description	Availability	Inserts	Dimension (mm)					A.R. max. (°)	R.R. (°)	Coolant hole	Max. revolution (min ⁻¹)	Fig.	Spare parts			Applicable inserts M59
			DC	DCON	LF	LH	APMX						Anti-seize compound	Screw	Wrench	
Standard shank	MEW	●	16	12	23	10	+7	-22	No	43750	1	P-37	SB-3065TRP	DTPM-8	LOGT1004... LOMU1004...	
			2	18	100				25	-21	43000					2
			●	20	16				110	26	41000					2
			●	22	20				110	26	39600					2
			●	3	25				120	29	37500					2
			●	28	120				29	35800	2					
			●	4	30				130	32	34800					2
			●	32	130				32	33900	2					
			●	5	40				150	50	30000					2
			●	50	32				120	40	22500					2
Cylindrical	MEW	●	16	16	100	26	10	+7	-22	43750	3	P-37	SB-3065TRP	DTPM-8	LOGT1004... LOMU1004...	
			2	20	110	30				41000	3					
			●	3	25	120				32	37500					3
			●	2	25	120				32	37500					3
			●	3	32	130				40	33900					3
			●	4	32	130				40	33900					3
Long shank	MEW	●	20	20	150	40	10	+7	-20	Yes	41000	3	P-37	SB-3065TRP	DTPM-8	LOGT1004... LOMU1004...
			2	25	170	50				37500	3					
Standard shank	MEW	●	25	20	120	29	15	+10	-22	35000	2	P-37	SB-4090TRP	DTPM-15	LOGT1505... LOMU1505...	
			●	32	25	130				32	30000					2
			●	3	40	150				50	25000					2
			●	4	32	120				40	17000					2
			●	50	120	40				17000	2					
Same shank	MEW	●	25	25	120	32	15	+10	-22	Yes	35000	3	P-37	SB-4090TRP	DTPM-15	LOGT1505... LOMU1505...
			●	32	32	130				40	30000	3				
			●	3	32	130				40	30000	3				

Max. revolution : Do not use the cutter at the maximum revolution or higher since the centrifugal force may cause inserts and parts to scatter even under no load.

● : Standard item R : Right-hand only L : Left-hand only □ : Check availability

M

Milling

Cutting edge angle 45°~70°

Cutting edge angle 75°

Cutting edge angle 88°/90°

Cutter for Finishing

High Feed Cutter

Multi-Function

Slot Mill

Ball-nose Radius

Others

MEW

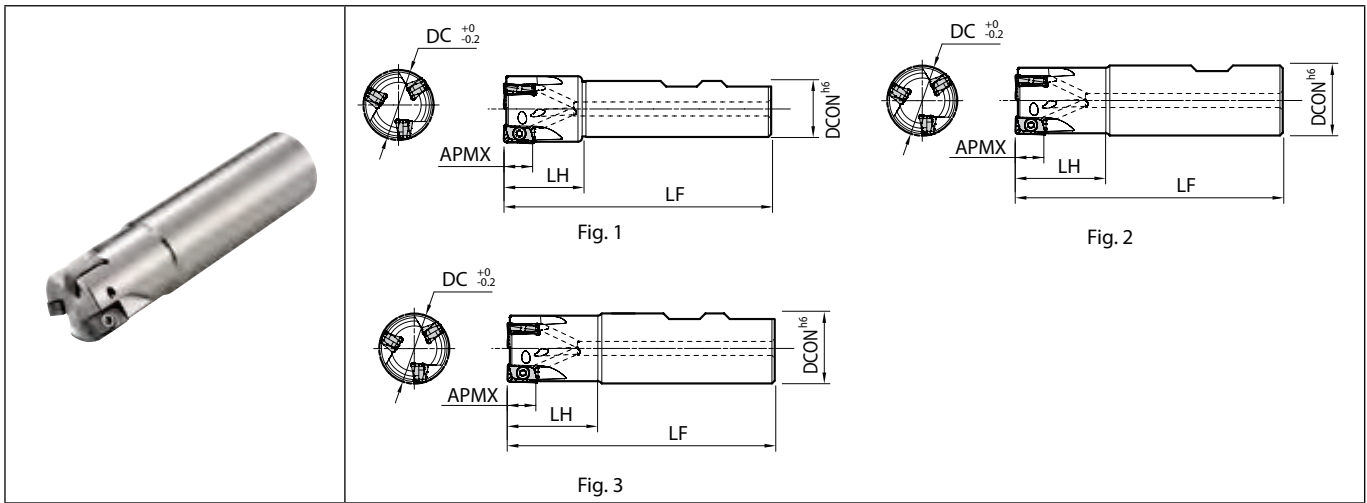

Toolholder dimensions

Description	Availability	Inserts	Dimension (mm)					A.R. max. (°)	R.R. (°)	Coolant hole	Max. revolution (min ⁻¹)	Fig.	Spare parts			Applicable inserts M59			
			DC	DCON	LF	LH	APMX						Anti-seize compound	Screw	Wrench				
Weldon	Standard shank	MEW	40-W32-10-5T	●	5	40	32	111	50	10	+7	-19	Yes	30000	1	P-37	SB-3065TRP	DTPM-8	LOGT1004..., LOMU1004...
		MEW	40-W32-15-4T	●	4	40	32	111	50	15	+10	-21	Yes	25000	1	P-37	SB-4090TRP	DTPM-15	LOGT1505..., LOMU1505...
	Same Shank	MEW	16-W16-10-2T	●	2	16	16	75	25	10	+7	-20	Yes	43750	2	P-37	SB-3065TRP	DTPM-8	LOGT1004... LOMU1004...
			20-W20-10-2T	●		20	20	77						41000	2				
		20-W20-10-3T	●	3	25	25	90	32	37500	3									
		32-W32-10-4T	●						4	32	32	102	40	33900	3				
		MEW	25-W25-15-2T	●	2	25	25	90	32	15	+10	-22	Yes	35000	3	P-37	SB-4090TRP	DTPM-15	LOGT1505... LOMU1505...
			32-W32-15-3T	●	3	32	32	102	40	30000	3								

Max. revolution : Do not use the cutter at the maximum revolution or higher since the centrifugal force may cause inserts and parts to scatter even under no load.



Milling

MEW

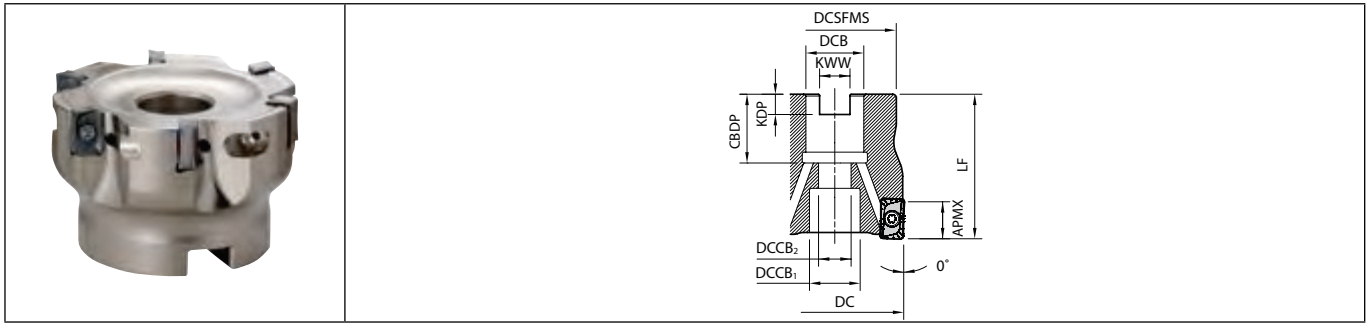

Toolholder dimensions

Description	Availability	Inserts	Dimension (mm)										A.R. max. (°)	R.R. (°)	Coolant hole	Max. revolution (min ⁻¹)	Weight (kg)	Applicable inserts ➔ M59
			R	DC	DCSFMS	DCB	DCCB ₁	DCCB ₂	LF	CBDP	KDP	KWW						
MEW 032R-10-4T-M 040R-10-5T-M 050R-10-5T-M 063R-10-6T-M	●	4	32	30	16	14	9	35	19	5.6	8.4	10	+7	-20	Yes	33900	0.1	LOGT1004... LOMU1004...
	●	5	40	34														
	●	5	50	45	22	18	11	40	21	6.3	10.4							
	●	6	63	47														
MEW 040R-15-4T-M 050R-15-4T-M 063R-15-5T-M 080R-15-6T-M 080R-15-6T	●	4	40	34	16	14	9	19	5.6	8.4	15	+10	-21	Yes	25000	0.2	LOGT1505... LOMU1505...	
	●		50	45														
	●	5	63	47	22	18	11	40	21	6.3								10.4
	●		6	80														
	●	6	80	60	27	20	13	50	25	7								12.4
	●				25.4													

Max. revolution : Do not use the cutter at the maximum revolution or higher since the centrifugal force may cause inserts and parts to scatter even under no load.

Spare parts and applicable inserts (End mill/face mill)

Description	Spare parts				Applicable inserts ➔ M59			
	Clamp screw	Wrench	Anti-seize compound	Mounting bolt				
MEW ...-10-_T					General purpose	Low cutting force	Tough edge (For heavy milling)	Non-ferrous metals
MEW 032R-10-_M 040R-10-_M 050R-10-_M 063R-10-_M	SB-3065TRP	DTPM-8	P-37	HH8X25 HH10X30	LOMU10...-GM	LOMU10...-SM	LOMU10...-GH	LOGT10...-AM
MEW ...-15-_T								
MEW 040R-15-_M 050R-15-_M 063R-15-_M 080R-15_(-M)	SB-4090TRP	DTPM-15	P-37	HH8X25 HH10X30 HH12X35	LOMU15...-GM	LOMU15...-SM	LOMU15...-GH	LOGT15...-AM

Coat anti-seize compound thinly on portion of taper and thread when insert is fixed.

About wrench specifications

- Wrenches and clamp screws are "Torx Plus".
- 1. Ref. to Fig. 1 for "Torx Plus" Wrench. (Purple grip)
- 2. Ref. to Fig. 2 for "Torx" Wrench. (Black grip)

A "Torx Plus" Wrench and a "Torx" Wrench have different top shapes. Please use a "Torx Plus" Wrench.
* If a "Torx" Wrench is used to tighten, the screw head might become damaged and then the screw cannot be removed.

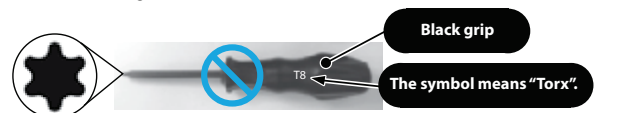
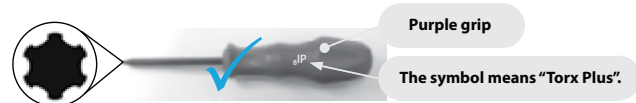

● : Standard item R : Right-hand only L : Left-hand only □ : Check availability

M56

MEW

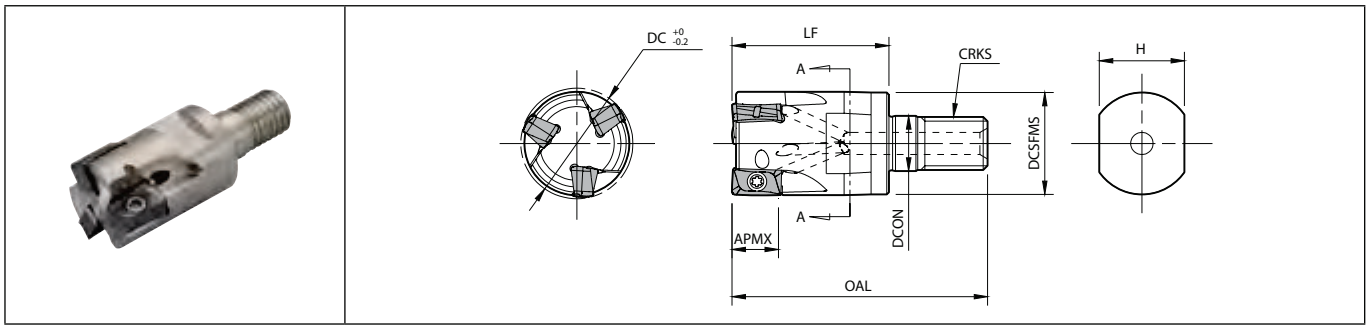

Toolholder dimensions

Description	Availability	Inserts	Dimension (mm)								A.R. max. (°)	R.R. (°)	Coolant hole	Max. revolution (min ⁻¹)	Applicable inserts ● M59
			DC	DCON	DCSFMS	OAL	LF	APMX	CRKS	H					
MEW 16-M08-10-2T 20-M10-10-2T 20-M10-10-3T 25-M12-10-3T 32-M16-10-4T	●	2	16	8.5	14.7	42	25	10	M8x1.25	12	+7	-22	Yes	43750	LOGT1004... LOMU1004...
	●		20	10.5	18.7	48	30		M10x1.5	15					
	●	3	25	12.5	23	56	35	M12x1.75	19	37500					
	●		32	17	30	62	40	M16x2.0	24	33900					
	●		4	32	17	30	62	40	M16x2.0	24	33900				
MEW 25-M12-15-2T 32-M16-15-3T	●	2	25	12.5	23	56	35	15	M12x1.75	19	+10	-22	Yes	35000	LOGT1505... LOMU1505...
	●	3	32	17	30	62	40		M16x2.0	24					

Max. revolution : Do not use the cutter at the maximum revolution or higher since the centrifugal force may cause inserts and parts to scatter even under no load.
See page M60 for applicable arbor (BT arbor for exchangeable head / double-face clamping spindle)

Spare parts and applicable inserts (MEW modular type)

Description	Spare parts			Applicable inserts ● M59			
	Clamp screw	Wrench	Anti-seize compound				
MEW 16-M08-10-2T 20-M10-10-2T 20-M10-10-3T 25-M12-10-3T 32-M16-10-4T		DTPM-8		General purpose	Low cutting force	Tough edge (For heavy milling)	Non-ferrous metals
	SB-3065TRP			LOMU10...-GM	LOMU10...-SM	LOMU10...-GH	LOGT10...-AM
	Recommended tightening torque for insert clamp 1.2N·m			LOMU10...-GM	LOMU10...-SM	LOMU10...-GH	LOGT10...-AM
	SB-3065TRP	LOMU10...-GM		LOMU10...-SM	LOMU10...-GH	LOGT10...-AM	
	SB-3065TRP	LOMU10...-GM		LOMU10...-SM	LOMU10...-GH	LOGT10...-AM	
MEW 25-M12-15-2T 32-M16-15-3T		DTPM-15		General purpose	Low cutting force	Tough edge (For heavy milling)	Non-ferrous metals
	SB-4090TRP			LOMU15...-GM	LOMU15...-SM	LOMU15...-GH	LOGT15...-AM
	Recommended tightening torque for insert clamp 3.5N·m			LOMU15...-GM	LOMU15...-SM	LOMU15...-GH	LOGT15...-AM

Coat anti-seize compound thinly on portion of taper and thread when insert is fixed.

Modular end mill head identification system

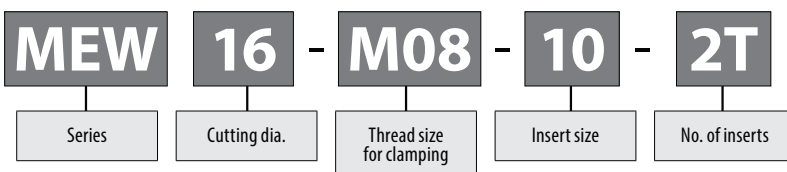

● : Standard item R : Right-hand only L : Left-hand only □ : Check availability



Feature of modular type

Applicable to a wide range of applications

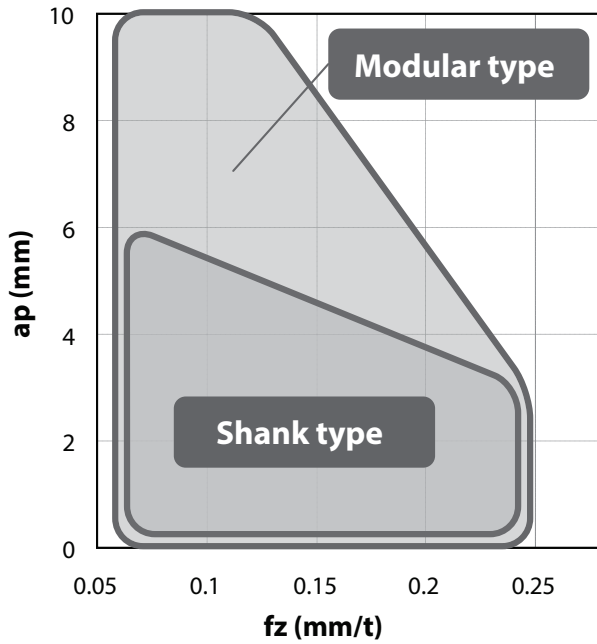

<Cutting conditions>

- Cutting speed: $V_c=150\text{m/min}$ ($n=2,390\text{min}^{-1}$)
- Width of cut: $a_e=10\text{mm}$ (Shouldering)
- Workpiece material: C55,Dry
- **Machine: BT30 M/C**
- <Cutting tool>
- Modular type
 - Head: MEW20-M10-10-3T
 - Arbor: BT30K-M10-45
 - Insert: LOMU100408ER-GM (PR1525)
- Shank type
 - Toolholder: MEW20-S20-10-3T
 - Arbor: BT30 Milling Chuck (Double-face clamping)
 - Insert: LOMU100408ER-GM (PR1525)

A wide range of applications even in BT30 M/C with the superior anti-chattering performance

How to select multi-edge or less edge toolholder

Shouldering ($a_e=10\text{mm}$)

Slotting

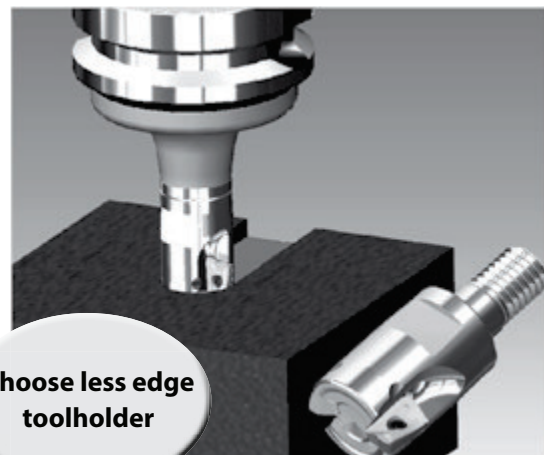
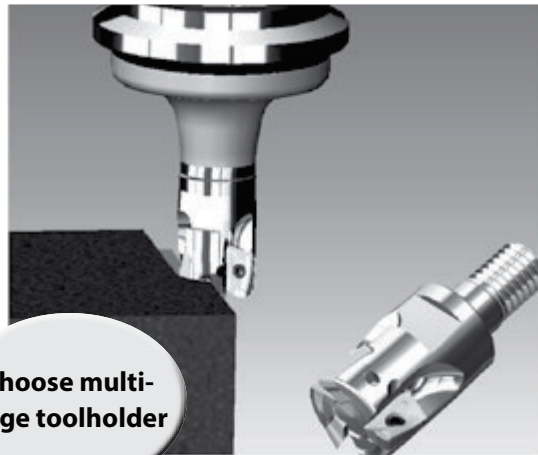

Available cutting condition of modular type

Shouldering

Slotting

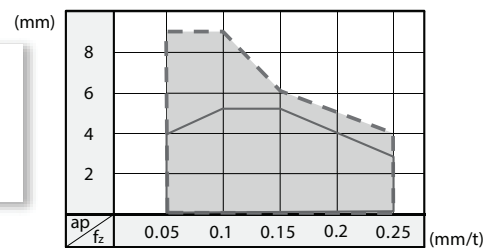
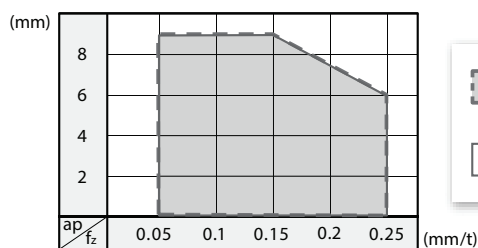

Available cutting condition for 2 flutes
 Available cutting condition for 3 flutes

M

Milling

Cutting edge angle 45°~70°

Cutting edge angle 75°

Cutting edge angle 88°/90°

Cutter for Finishing

High Feed Cutter



Multi-Function

Slot Mill

Ball-nose Radius

Others

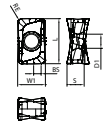
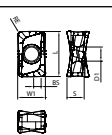
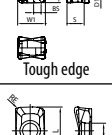
LOMU/LOGT

Insert		Description	No. of edges	Dimension (mm)						Carbide						Applicable toolholder M54~M57 M90, M91
				S	D1	RE	L	W1	BS	CVD		DLC		PVD		
Classification of usage		★ : Roughing / 1st Choice ☆ : Roughing / 2nd Choice ■ : Finishing / 1st Choice □ : Finishing / 2nd Choice (In case hardness is 45HRC or under)														
		Carbon steel / Alloy steel Mold and die steel Austenitic stainless steel Martensitic stainless steel Precipitation hardening stainless steel Gray cast iron Nodular cast iron Non-ferrous metals Heat-resistant alloy Titanium alloy Hard materials														
 General purpose		LOMU 100404ER-GM 100408ER-GM 100412ER-GM 100416ER-GM 100420ER-GM LOMU 150504ER-GM 150508ER-GM 150510ER-GM 150512ER-GM 150516ER-GM 150520ER-GM	4	4	3.4	0.4 0.8 1.2 1.6 2	10.9	6.6	2.1 1.7 1.3 1 1	● ● ● ● ●	● ● ● ● ●	● ● ● ● ●	● ● ● ● ●	● ● ● ● ●	MEW...-10-... MEWH...-10-...	
 Low cutting force		LOMU 100408ER-SM LOMU 150508ER-SM	4	4	3.4	0.8	10.9	6.6	1.7	●	●	●	●	MEW...-10-... MEWH...-10-...		
 Tough edge		LOMU 100408ER-GH LOMU 150508ER-GH	4	4	3.4	0.8	10.9	6.6	1.7	●	●	●	●	MEW...-10-... MEWH...-10-...		
 2-edge / Non-Ferrous Metals		LOGT 100408FR-AM LOGT 150508FR-AM	2	4	3.6	0.8	11.2	6.8	2.8	●			●	MEW...-10-...		
		LOGT 150508FR-AM	2	5.6	4.9	0.8	15.9	8.9	2.9	●			●	MEW...-15-...		

Handed insert shows Right-hand

Recommended cutting conditions M62



Milling

● : Standard item R : Right-hand only L : Left-hand only □ : Check availability

BT Arbor (for exchangeable head / double-face clamping spindle)

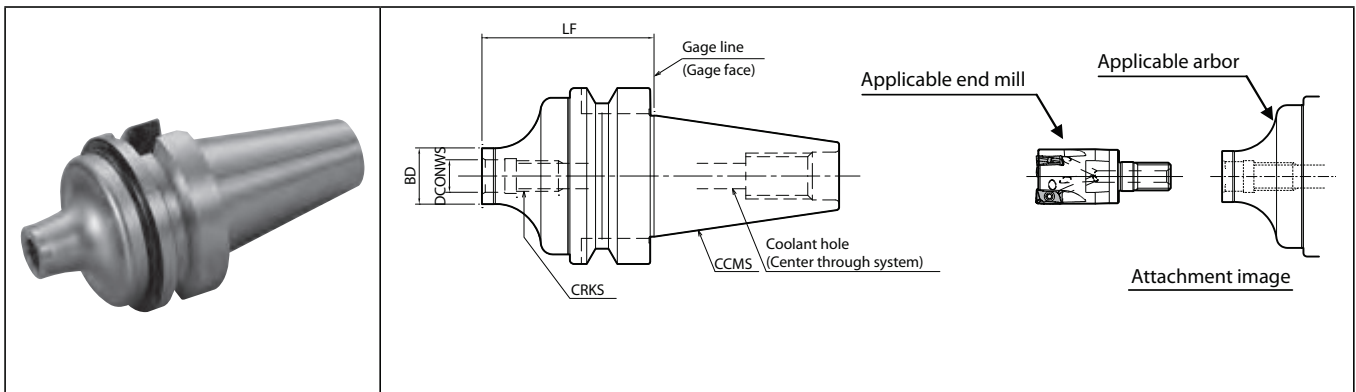

Dimensions

Description	Availability	Dimension (mm)				Coolant hole	Arbor (Double-face clamping)	Applicable end mill (Head) MEW, MEC, MEV, MFH Harrier, MFH Boost, MFH Mini, MFH Micro, MRX ➡ M57(MEW), M68(MEC) M86(MEV), M180(MFH Harrier) M191(MFH Boost), M198(MFH Mini) M205(MFH Micro), M259(MRX)
		LF	BD	DCONWS	CRKS			
BT30K- M08-45 M10-45 M12-45	●	45	14.7	8.5	M8×1.25	Yes	BT30	(MEW/MEC/MFH/MRX)...-M08-...
	●		18.7	10.5	M10×1.5			(MEW/MEC/MEV/MFH/MRX)...-M10-...
	●		23	12.5	M12×1.75			(MEW/MEC/MEV/MFH/MRX)...-M12-...
BT40K- M08-55 M10-60 M12-55 M16-65	●	55	14.7	8.5	M8×1.25	Yes	BT40	(MEW/MEC/MFH/MRX)...-M08-...
	●	60	18.7	10.5	M10×1.5			(MEW/MEC/MEV/MFH/MRX)...-M10-...
	●	55	23	12.5	M12×1.75			(MEW/MEC/MEV/MFH/MRX)...-M12-...
	●	65	30	17	M16×2.0			(MEW/MEC/MEV/MFH/MRX)...-M16-...



Actual end mill depth

Arbor description	Applicable end mill (Head)			Actual end mill depth (mm)
	Description	Cutting dia. (mm)	Dimension (mm)	LUX
			DC	
BT30K- M08-45 M10-45 M12-45	...16-M08-...	16	25	31.8
		17		33.2
		18		34.2
	...20-M10-...	20	30	36.8
		22		39.2
		25		42.8
...28-M12-...	28	35	45.5	
	25		25	42.8
	28			45.5
BT40K- M08-55 M10-60 M12-55 M16-65	...16-M08-...	16		25
		17	33.2	
		18	34.3	
	...20-M10-...	20	30	38.7
		22		44.5
		25		44.6
...28-M12-...	28	35	47.6	
	32		40	51.2
	35			60.2
40	64			

● : Available

- Cutting edge angle 45°~70°
- Cutting edge angle 75°
- Cutting edge angle 88°/90°
- Cutter for Finishing
- High Feed Cutter
- Multi-Function
- Slot Mill
- Ball-nose Radius
- Others

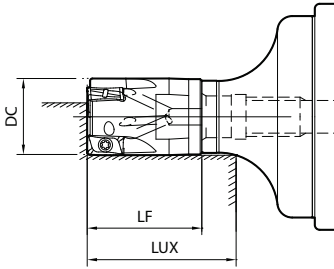

Arbor identification system

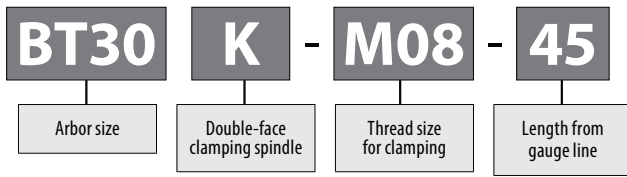

How to attach head

1. When clamping the head on the arbor, make sure there is no dust or chips inside (Fig. 1).
Do NOT put lubricant on the clamping portion.

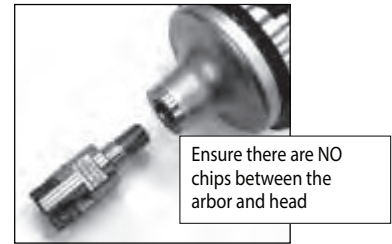

Fig. 1

2. Attach the head on the arbor and fix it using the wrench (Fig. 2).
Ref. to the Table 1 for Recommended tightening torque.
Note: The wrench is NOT included in the products.



Fig. 2

Table 1 recommended head tightening torque

Thread size for clamping	Wrench double width [mm]	Recommended tightening torque [N·m]
M8	12	23
M10	15	46
M12	19	80
M16	24	90

3. Confirm that the head is fixed firmly on the arbor. (Fig. 3)



Fig. 3

Frequently asked question

Q: Can the double-face clamping arbor be mounted on a general BT spindle?
A: Yes. It can be used as a general BT arbor with a general BT spindle.

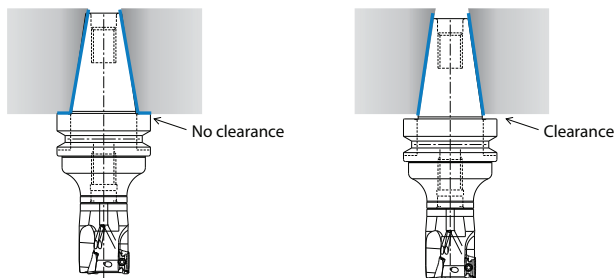

Double-face clamping arbor mounted on double-face clamping spindle

Double-face clamping arbor mounted on general spindle

It can be used as a general BT arbor, though the advantage of the double-face clamping will not be shown.



How to mount an insert

1. Be sure to remove dust and chips from the insert mounting pocket.
2. Clamp screw
 1. Apply anti-seize compound on portion of taper and thread of clamp screw.
 2. Attach the screw (magnetic head) to the front end of the wrench. While lightly pressing the insert against the constraint surfaces, put the screw into the hole of the insert and tighten. (Ref. to Fig. 1)
Tighten M3 screws (SB-3065TRP) slightly inclined from the insert surface.(Ref. to Fig. 2)
3. When tightening the screw, make sure that the wrench is parallel to the screw.
4. After tightening the screw, make sure that there is no clearance between the insert seat surface and the bearing surface of the toolholder or between the insert side surfaces and the constraint surface of the toolholder. If there is any clearance, remove the insert and mount it again according to the above steps.

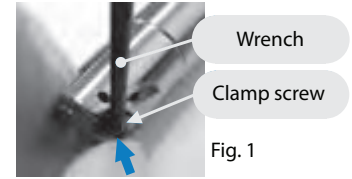

Fig. 1

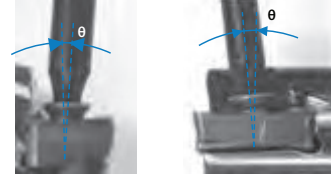

Fig. 2

Recommended cutting conditions

Chipbreaker	Workpiece material	fz (mm/t)		Recommended insert grades (Vc: m/min)				CVD coated carbide
		Toolholder description		MEGACOAT (PVD coated carbide)				
		MEW16~MEW18	MEW20~MEW40 MEW040R~MEW080R	PR1535	PR1525	PR1510	PR015S	
GM	Carbon steel	0.06~0.1~0.2	0.08~0.15~0.25	☆ 120~180~250	★ 120~180~250	-	-	-
	Alloy steel	0.06~0.1~0.14	0.08~0.15~0.2	☆ 100~160~220	★ 100~160~220	-	-	-
	Mold steel	0.06~0.08~0.12	0.08~0.12~0.2	☆ 80~140~180	★ 80~140~180	-	-	-
	Stainless steel (Austenitic related)	0.06~0.08~0.12	0.08~0.12~0.15	☆ 100~160~200	★ 100~160~200	-	-	-
	Stainless steel (Martensitic related)	0.06~0.08~0.12	0.08~0.12~0.2	☆ 150~200~250	-	-	-	★ 180~240~300
	Stainless steel (Precipitation hardening)	0.06~0.08~0.12	0.08~0.12~0.2	★ 90~120~150	-	-	-	-
	Gray cast iron	0.06~0.1~0.17	0.08~0.18~0.25	-	-	★ 120~180~250	-	-
	Nodular cast iron	0.06~0.08~0.12	0.08~0.15~0.2	-	-	★ 100~150~200	-	-
	Ni-base heat-resistant alloys	0.06~0.08~0.12	0.08~0.12~0.15	☆ 20~30~50	-	-	-	★ 20~30~50
Titanium alloys	0.06~0.08~0.12	0.08~0.15~0.2	☆ 40~60~80	-	☆ 30~50~70	-	-	
SM	Carbon steel	0.06~0.1~0.17	0.08~0.15~0.2	☆ 120~180~250	★ 120~180~250	-	-	-
	Alloy steel	0.06~0.08~0.12	0.08~0.12~0.18	☆ 100~160~220	★ 100~160~220	-	-	-
	Mold steel	0.06~0.08~0.12	0.08~0.1~0.15	☆ 80~140~180	★ 80~140~180	-	-	-
	Stainless steel (Austenitic related)	0.06~0.08~0.12	0.08~0.1~0.15	☆ 100~160~200	★ 100~160~200	-	-	-
	Stainless steel (Martensitic related)	0.06~0.08~0.12	0.08~0.1~0.15	☆ 150~200~250	-	-	-	★ 180~240~300
	Stainless steel (Precipitation hardening)	0.06~0.08~0.12	0.08~0.1~0.15	☆ 90~120~150	-	-	-	-
	Ni-base heat-resistant alloys	0.06~0.08~0.1	0.08~0.1~0.12	☆ 20~30~50	-	-	-	★ 20~30~50
Titanium alloys	0.06~0.08~0.12	0.08~0.12~0.15	★ 40~60~80	-	☆ 30~50~70	-	-	
GH	Carbon steel	0.06~0.1~0.2	0.08~0.2~0.3	☆ 120~180~250	★ 120~180~250	-	-	-
	Alloy steel	0.06~0.1~0.14	0.08~0.2~0.25	☆ 100~160~220	★ 100~160~220	-	-	-
	Mold steel	0.06~0.08~0.12	0.08~0.15~0.22	☆ 80~140~180	★ 80~140~180	-	-	-
	Stainless steel (Austenitic related)	0.06~0.08~0.12	0.08~0.12~0.15	☆ 100~160~200	☆ 100~160~200	-	-	-
	Stainless steel (Martensitic related)	0.06~0.08~0.12	0.08~0.12~0.2	☆ 150~200~250	-	-	-	☆ 180~240~300
	Stainless steel (Precipitation hardening)	0.06~0.08~0.12	0.08~0.12~0.2	☆ 90~120~150	-	-	-	-
	Gray cast iron	0.06~0.1~0.2	0.08~0.22~0.3	-	-	☆ 120~180~250	-	-
	Nodular cast iron	0.06~0.08~0.15	0.08~0.18~0.25	-	-	☆ 100~150~200	-	-
	Ni-base heat-resistant alloys	0.06~0.08~0.12	0.08~0.12~0.15	☆ 20~30~50	-	-	-	☆ 20~30~50
	Titanium alloys	0.06~0.08~0.12	0.08~0.15~0.2	☆ 40~60~80	-	☆ 30~50~70	-	-
	Hard materials (60HRC or less)	0.06~0.08~0.12	0.08~0.15~0.22	-	-	-	★ 60~80~100	-
Chipbreaker	Workpiece material	fz (mm/t)		Recommended insert grades (Vc: m/min)				
		Toolholder description		DLC coated carbide		Carbide		
		MEW16~MEW18	MEW20~MEW40 MEW040R~MEW080R	PDL025	GW25			
AM	Aluminum alloys	0.06~0.1~0.2	0.08~0.15~0.25	★ 200~600~900	☆ 200~500~800			

★: 1st Recommendation

☆: 2nd Recommendation

* The bold-faced number indicates a center value of recommended cutting condition. Adjust the cutting speed and the feed rate within the above conditions according to the actual machining situation.
* Machining with coolant is recommended for Ni-base heat-resistant alloys and titanium alloys.

Ramping, helical milling and vertical milling (Plunging)

1. Available for vertical milling (plunging).
2. NOT available for ramping and helical milling, because interference between workpiece and insert may occur.

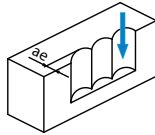
Vertical milling (Plunging)							
	<table border="1"> <thead> <tr> <th>Insert description</th> <th>Max. width of cut</th> </tr> </thead> <tbody> <tr> <td>LOMU10 type</td> <td>5mm</td> </tr> <tr> <td>LOMU15 type</td> <td>7mm</td> </tr> </tbody> </table>	Insert description	Max. width of cut	LOMU10 type	5mm	LOMU15 type	7mm
Insert description	Max. width of cut						
LOMU10 type	5mm						
LOMU15 type	7mm						

Cutting performance

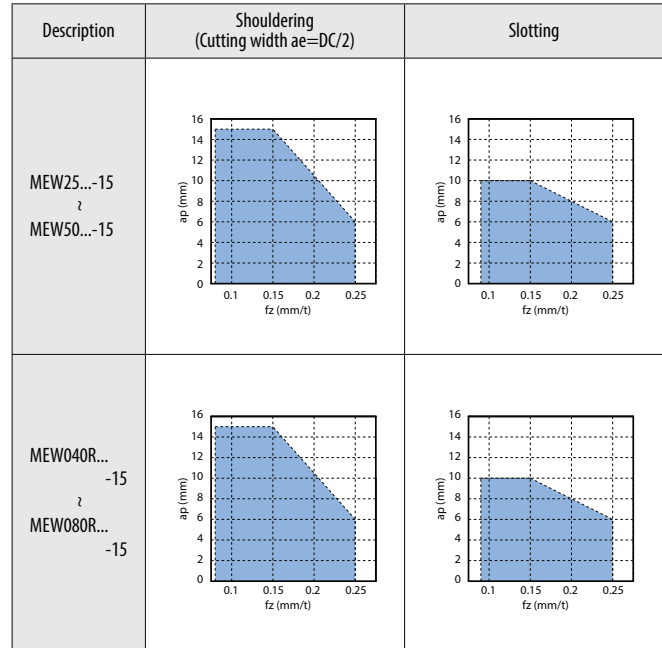
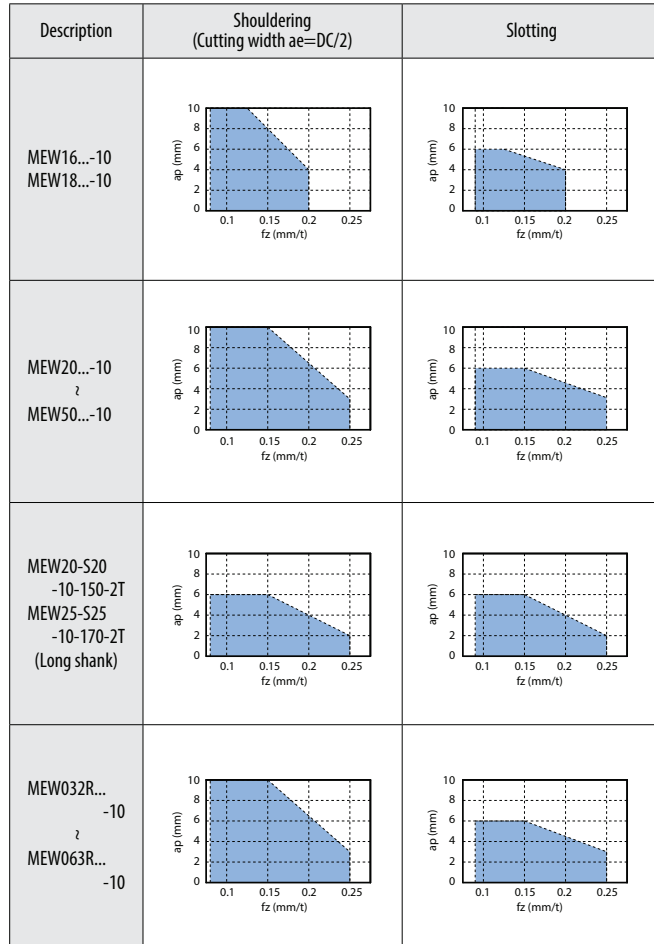

- <Cutting conditions>
- $V_c=180\text{m/min}$
 - GM chipbreaker
 - Workpiece material: C50
 - Overhang length
 - 1. End mill: Same length as LH of the dimension
 - 2. Face mill: LF of the dimension + minimum overhang length of the arbor



Milling

Case studies

SS400	
<ul style="list-style-type: none"> · Construction machine part · $V_c=250\text{m/min}$ · $ap_{xae}=4 \times 20\text{mm}$ · $fz=0.14\text{mm/t}$ ($V_f=1,350\text{mm/min}$) · Wet · MEW32-S32-10-4T(4 flutes) · LOMU100408ER-GM (PR1525) 	
PR1525	Chip evacuation rate = 108cc/min
Competitor A (Positive cutter)	Chip evacuation rate = 72cc/min
MEW showed stable milling without chattering at higher feed, improving the machining efficiency by 150%. Burrs are prevented and excellent surface finish is achieved.	
(User Evaluation)	

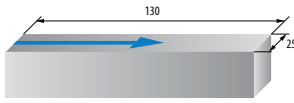
15-5PH (42HRC)	
<ul style="list-style-type: none"> · Aircraft part · $V_c=180\text{m/min}$ · $ap_{xae}=2 \times 25\text{mm}$ · $fz=0.1\text{mm/t}$ ($V_f=716\text{mm/min}$) · Wet · MEW32-S32-10-4T(4 flutes) · LOMU100408ER-GM (PR1525) 	
PR1525	Chip evacuation rate = 35.8cc/min (Further machining possible)
Competitor B (Positive cutter)	Chip evacuation rate = 26.8cc/min (Unable to continue machining)
No chattering and more stable milling is possible with MEW. Despite the milling difficulty because of the properties of the material (42HRC), PR1525 kept good cutting edge form, minimizing wear and adhesion.	
(User evaluation)	

MEC

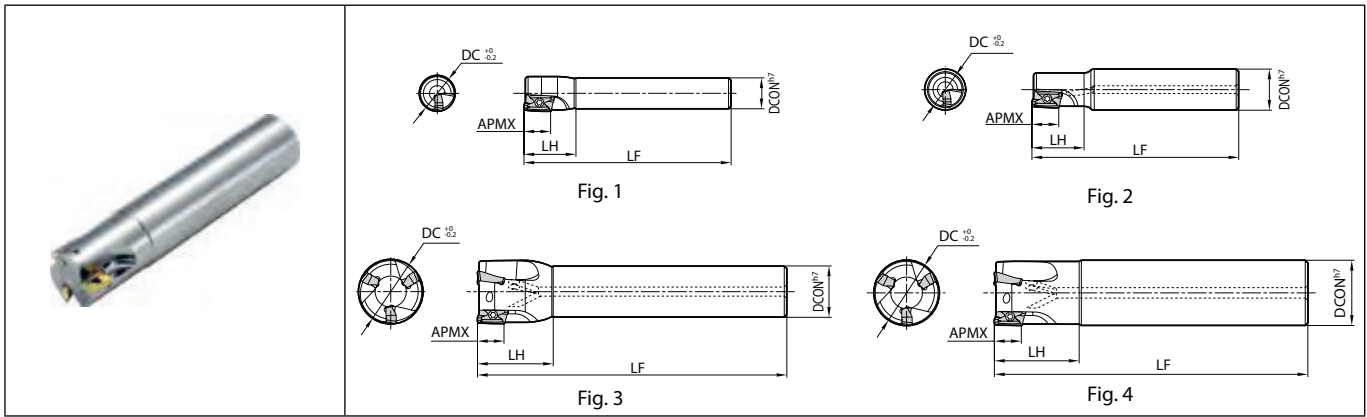

Toolholder dimensions

Description	Availability	Inserts	Dimension (mm)					A.R. max. (°)	R.R. (°)	Coolant hole	Max. revolution (min ⁻¹)	Fig.	Spare parts			Applicable inserts M69				
			DC	DCON	LF	LH	APMX						Anti-seize compound	Screw	Wrench					
Cylindrical Standard shank	●	1	10	10	17	10	+10	-24	No	54800	1	P-37	SB-2545TR	DTM-8	BDMT1103...					
				16							2									
			12	10	80						+12					-21	No	50800	1	
				12															2	
			13	12	20						+12					-19	No	49200	1	
				16															2	
			14	12	20						+12					-19	No	47700	1	
	16	2																		
	●	2	3	16	12	23	10	+18	-14	No	43750	1	P-37	SB-2555TRG	DTM-8	BDGT11T3... BDMT11T3...				
					17							3								
				18	16	110						+20					-10	No	43500	3
					19															3
				20	16	26						+20					-10	No	43000	3
					21															3
21				110	26	+20						-10					No	42000	3	
	22	3																		
22	110	26	+20	-10	No	41000	3													
	24						3													
24	20	29	+21	-10	Yes	38200	3													
	25						3													
25	120	29	+22	-9	Yes	37500	3													
	28						3													
28	120	29	+22	-9	Yes	35800	3													
	30						3													
30	25	32	+23	-9	Yes	34800	3													
	32						3													
32	130	32	+23	-9	Yes	33900	3													
	32						3													
40	150	50	+23	-8	Yes	30000	3													
	50						3													
50	150	50	+23	-7	Yes	22500	3													
	50						3													
Cylindrical Same shank	●	3	16	16	30	10	+18	-14	No	43750	4	P-37	SB-2555TRG	DTM-8	BDGT11T3... BDMT11T3...					
				20							4									
			25	20	110						+20					-10	No	41000	4	
				25															4	
			25	120	32						+21					-10	Yes	37500	4	
				32															4	
			32	130	40						+23					-9	Yes	33900	4	
32	4																			

Max. revolution : Do not use the cutter at the maximum revolution or higher since the centrifugal force may cause inserts and parts to scatter even under no load.

For more details, see „Warning“ on page M71.

Coat Anti-seize Compound(P-37) thinly on portion of taper and thread when insert is fixed.

● : Standard item R : Right-hand only L : Left-hand only □ : Check availability

M

Milling

Cutting edge angle 45°~70°

Cutting edge angle 75°

Cutting edge angle 88°/90°

Cutter for Finishing

High Feed Cutter

Multi-Function

Slot Mill

Ball-nose Radius

Others

Toolholder dimensions

Description	Availability	Inserts	Dimension (mm)					A.R. max. (°)	R.R. (°)	Coolant hole	Max. revolution (min ⁻¹)	Fig.	Spare parts			Applicable inserts M69					
			DC	DCON	LF	LH	APMX						Anti-seize compound	Screw	Wrench						
Cylindrical Long shank	MEC	●	2	20	18	170	30	10	+20	-10	Yes	41000	3	P-37	SB-2555TRG	DTM-8	BDGT11T3... BDMT11T3...				
					140	60	4														
					170	30	4														
					210	32	3														
					210	60	4														
					210	60	4														
					210	32	3														
					250	40	3														
					200	65	4														
					250	40	4														
					250	40	3														
					240	65	3														
					240	65	3														
					Cylindrical Same shank	MEC	●											3	20	20	150
25	170	60	4																		
25	170	60	4																		
30	180	32	3																		
30	180	32	4																		
32	200	65	4																		
32	200	65	4																		
32	200	65	4																		
Cylindrical Standard shank	MEC	●	2	25	20	120	36	15.7	+16	-11	Yes	35000	3	P-37	SB-4070TRN	DTM-15	BDGT1704... BDMT1704...				
																		32	130	40	3
																		40	150	50	3
																		40	150	50	3
																		50	17000	3	
Cylindrical Same shank	MEC	●	2	25	25	120	36	15.7	+16	-11	Yes	35000	4	P-37	SB-4070TRN	DTM-15	BDGT1704... BDMT1704...				
																		32	130	40	4
Cylindrical Long shank	MEC	●	2	25	160	60	15.7	+16	-11	Yes	35000	4	P-37	SB-4070TRN	DTM-15	BDGT1704... BDMT1704...					
																	210	36	4		
																	210	36	3		
																	200	65	4		
																	200	65	4		
																	250	40	3		
																	250	40	3		
																	240	65	3		
																	240	65	3		
																	240	65	3		
Cylindrical Same shank	MEC	●	3	32	250	65	15.7	+17	-7	Yes	30000	4	P-37	SB-4070TRN	DTM-15	BDGT1704... BDMT1704...					
																	40	250	3		
																	40	250	3		
																	40	250	3		
																	50	42	64	3	

Max. revolution : Do not use the cutter at the maximum revolution or higher since the centrifugal force may cause inserts and parts to scatter even under no load.
For more details, see „Warning“ on page M71.



Milling

● : Standard item R : Right-hand only L : Left-hand only □ : Check availability

MEC

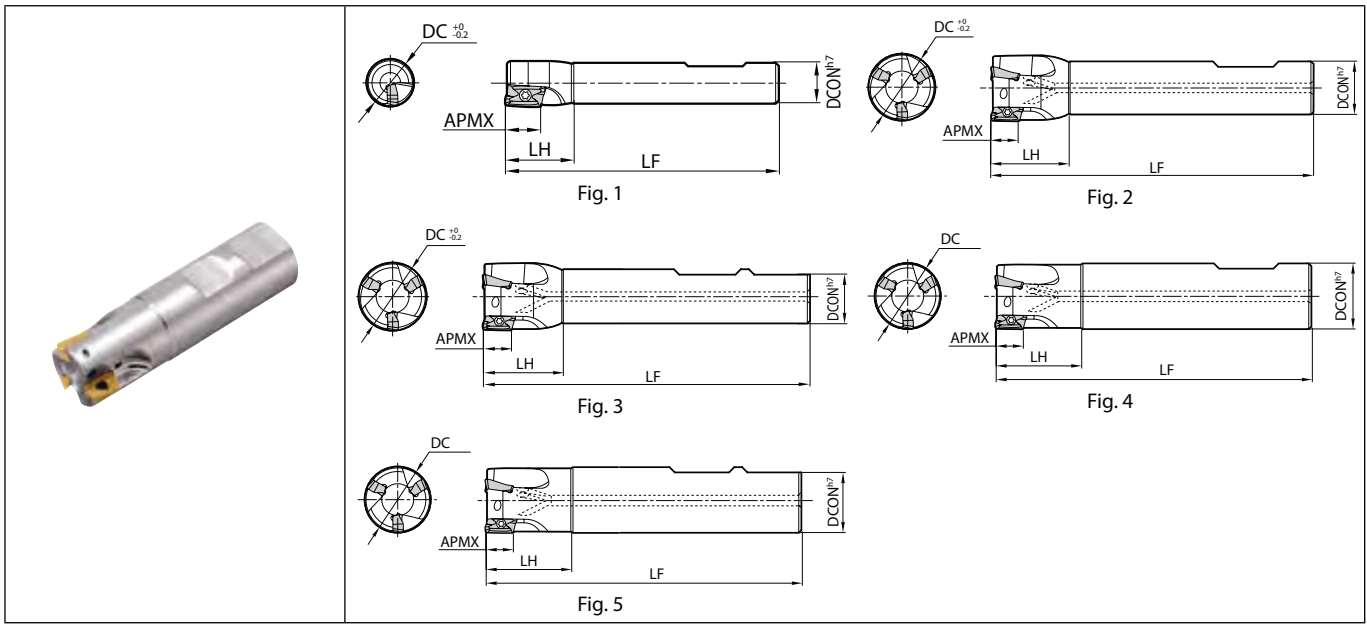

Toolholder dimensions

Description	Availability	Inserts	Dimension (mm)					A.R. max. (°)	R.R. (°)	Coolant hole	Max. revolution (min ⁻¹)	Fig.	Spare parts			Applicable inserts M69			
			DC	DCON	LF	LH	APMX						Anti-seize compound	Screw	Wrench				
Weldon	Standard shank	MEC	●	2	16	12	68	23	18	14	No	43750	1	P-37	SB-2555TRG	DTM-8	BDGT11T3... BDMT11T3...		
					18	16			19	13	43000	2							
		●	3	20	81	25	10	21	10	20	9	Yes	41000					2	
				22									26					22	39600
		●	4	25	88	32	23	23	9	22	9	Yes	37500					2	
				28									29					22	35800
	●	4	30	100	40	16	-11	35000	3	17	7	Yes	34800	3					
			32										32	17	33900	3			
	Same shank	MEC	●	2	16	16	68	25	18	14	10	10	Yes	43750	4	P-37	SB-2555TRG	DTM-8	BDGT11T3... BDMT11T3...
					18	20	81	30	20	20				41000	4				
			●	3	20	88	32	10	21	9	21	9	Yes	37500	5				
					25									25	23				
Standard shank	MEC	●	2	25	20	86	36	16	-11	15.7	17	7	Yes	35000	3	P-37	SB-4070TRN	DTM-15	BDGT1704... BDMT1704...
				32	25	92	36	17	7					30000	3				
				40	32	110	50	19	7					25000	3				
Same shank	MEC	●	2	25	25	92	36	16	11	15.7	17	7	Yes	35000	5	P-37	SB-4070TRN	DTM-15	BDGT1704... BDMT1704...
				32	32	100	40	17	7					30000	5				

Max. revolution : Do not use the cutter at the maximum revolution or higher since the centrifugal force may cause inserts and parts to scatter even under no load.

For more details, see „Warning“ on page M71.

Coat Anti-seize Compound(P-37) thinly on portion of taper and thread when insert is fixed.

● : Standard item R : Right-hand only L : Left-hand only □ : Check availability

M66

M

Milling

Cutting edge angle 45°~70°

Cutting edge angle 75°

Cutting edge angle 88°/90°

Cutter for Finishing

High Feed Cutter

Multi-Function

Slot Mill

Ball-nose Radius

Others

MEC

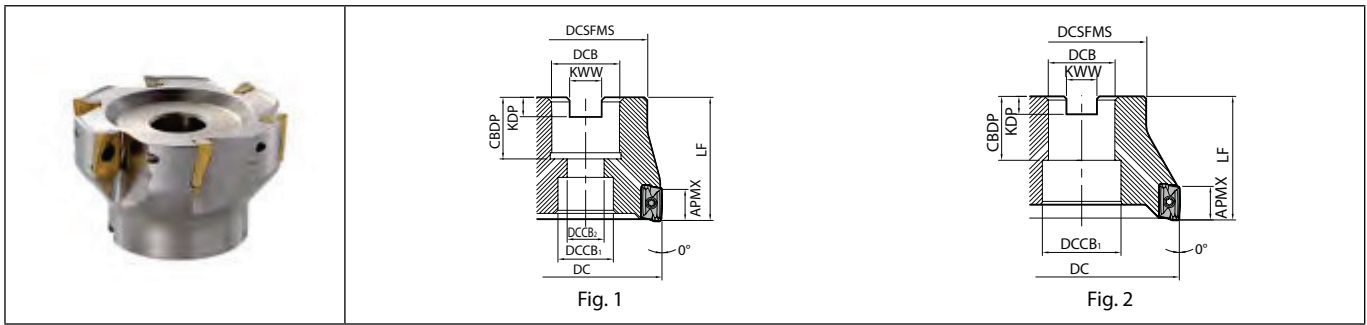

Toolholder dimensions

Description	Availability	Inserts	Dimension (mm)										A.R. max. (°)	R.R. (°)	Coolant hole	Max. revolution (min ⁻¹)	Weight (kg)	Fig.	Spare parts			Applicable inserts M69				
			R	DC	DCS ₁	DCB	DCC ₁	DCC ₂	LF	CBDP	KDP	KWB							APMX	Anti-seize compound	Screw		Wrench			
																								3	4	5
Metric Coarse pitch	MEC 040R-11-5T-M	●	5	40	34	16	14	8.5		20	5.6	8.5	10	+23	-7	Yes	30000	0.2	1	P-37	SB-2555TRG	DTM-8	BDGT11T3... BDMT11T3...			
	MEC 050R-11-5T-M	●	5	50																				22500	0.3	1
	MEC 063R-11-6T-M	●	6	63	40	22	18	12	40	22	6.3	10.4												20500	0.7	1
	MEC 080R-11-7T-M	●	7	80	52.5	27	20	14	50		7	12.4												18500	1	1
	MEC 100R-11-9T-MN	●	9	100	65	32	26	17.6	55	26	8	14.4												17000	1.6	1
	MEC 125R-11-11T-M	●	11	125	85	40	45	32	63	33	9.5	16.4												15000	3.1	1
Metric Fine pitch	MEC 032R-11-5T-M	●	5	32	30		11.5	35		20	5.6	8.4	10	+23	-7	Yes	33900	0.1	1	P-37	SB-2555TRG	DTM-8	BDGT11T3... BDMT11T3...			
	MEC 040R-11-6T-M	●	6	40	34	16	8.5	40																30000	0.2	1
	MEC 080R-11-10T-M	●	10	80	52.5	27	20	14	50	26.5	7	12.4												18500	0.9	1
	MEC 100R-11-11T-M	●	11	100	65	32	26	17.6	55	26	8	14.4												17000	1.7	1
Bores dia. inch spec Coarse pitch	MEC 040R-17-4T-M	●	4	40	34	16	14	8.5		20	5.6	8.5	15.7	+19	-7	Yes	25000	0.3	1	P-37	SB-4070TRN	DTM-15	BDGT1704... BDMT1704...			
	MEC 050R-17-4T-M	●	5	50																				17000	0.4	1
	MEC 063R-17-5T-M	●	5	63	40	22	18	12	40	22	6.3	10.4												14500	0.6	1
	MEC 080R-17-6T-M	●	6	80	52.5	27	20	14	50		7	12.4												12000	1	1
	MEC 100R-17-7T-MN	●	7	100	65	32	26	17.6	55	26	8	12.7												10500	1.8	1
	MEC 125R-17-9T-M	●	9	125	85	40	45	32	63	33	9.5	16.4												8900	3.1	1
	MEC 160R-17-12T-M	●	12	160	110		68	-																7400	4.5	2
Bores dia. inch spec Coarse pitch	MEC 063R-11-6T	□	6	63	50	25.4	20	14	50	26	6	9.5	10	+23	-7	Yes	20500	0.8	1	P-37	SB-2555TRG	DTM-8	BDGT11T3... BDMT11T3...			
	MEC 080R-11-7T	□	7	80	52.5																			18500	1	1
	MEC 100R-11-9TN	□	9	100	65	31.75	26	17.6	63	32	8	12.7												17000	1.8	1
	MEC 125R-11-11T	□	11	125	80	38.1	45	32		38	10	15.9												15000	3.4	1
Bores dia. inch spec Fine pitch	MEC 063R-11-8T	□	8	63	50	25.4	20	14	50	26	6	9.5	10	+23	-7	Yes	20500	0.8	1	P-37	SB-2555TRG	DTM-8	BDGT11T3... BDMT11T3...			
	MEC 080R-11-10T	□	10	80	52.5																			18500	1	1
	MEC 063R-17-5T	□	5	63	50	25.4	20	14	50	26	6	9.5												14500	0.8	1
	MEC 080R-17-6T	□	6	80	52.5																			12000	1	1
	MEC 100R-17-7TN	□	7	100	65	31.75	26	17.6	63	32	8	12.7												10500	1.8	1
Bores dia. inch spec Fine pitch	MEC 125R-17-9T	□	9	125	80	38.1	45	32		38	10	15.9	8900	3.4	1											
	MEC 063R-17-6T	□	6	63	50	25.4	20	14	50	26	6	9.5	14500	0.8	1											
	MEC 080R-17-8T	□	8	80	52.5								12000	1	1											
MEC 100R-17-9TN	□	9	100	65	31.75	26	17.6	63	32	8	12.7	10500	1.8	1												

Max. revolution : Do not use the cutter at the maximum revolution or higher since the centrifugal force may cause inserts and parts to scatter even under no load.

For more details, see „Warning“ on page M71.

Coat Anti-seize Compound(P-37) thinly on portion of taper and thread when insert is fixed.

When using center-through air/Coolant/Mist

If center through air (Coolant, Mist) is used, please use appropriate arbor and damp with mounting bolt (Table1)

For good shoulder finishes by MEC multistage ap.

In order to obtain smooth machining wall surface by multiple passes of MEC milling cutter, please keep ap 5.5 mm or less for 11T3 type and also keep ap 9 mm or less for 1704 type.

● : Standard item R : Right-hand only L : Left-hand only □ : Check availability

Table 1

Description	Mounting bolt (Attachment)	Wrench
MEC032R-...-M	SP8X35	LW-5 (Double width 5 mm)
MEC040R-...-M	HH8X25H	LW-5 (Double width 5 mm)
MEC050R-...-M	HH10X30H	LW-6 (Double width 6 mm)
MEC063R-...-M	HH12X35H	LW-8 (Double width 8 mm)
MEC100R-...-N/M	HH16X52H	LW-12 (Double width 12 mm)
MEC125R-...	HF20X53H	LW-14 (Double width 14 mm)
MEC160R-...	HF24X60H	LW-17 (Double width 17 mm)

Wrench is not attached. Please purchase it separately.



Milling

MEC

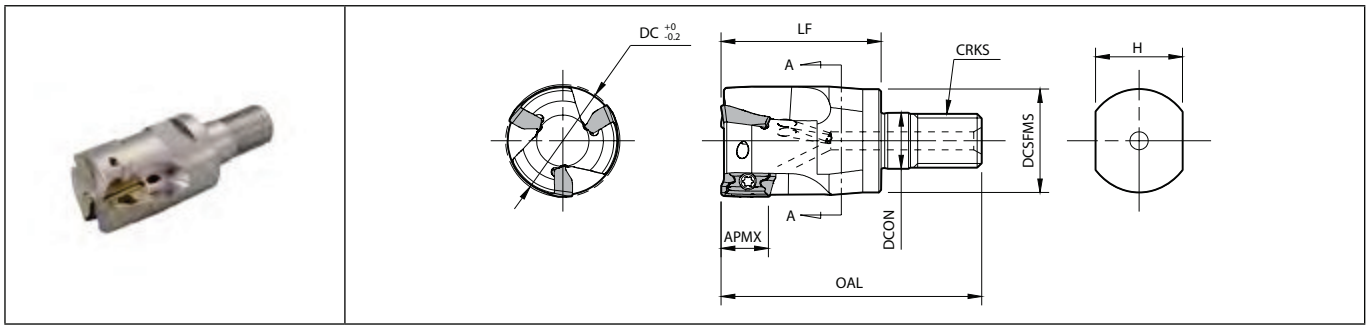

Toolholder dimensions

Description	Availability	Inserts	Dimension (mm)										Coolant hole	Max. revolution (min ⁻¹)	Applicable inserts ● M69
			DC	DCON	DCSFMS	OAL	LF	APMX	CRKS	H	A.R. max. (°)	R.R. (°)			
MEC 16-M08-11T-2T 20-M10-11T-2T 20-M10-11T-3T 25-M12-11T-3T 32-M16-11T-4T	●	2	16	8.5	14.7	42	25	10	M8x1.25	12	+18	-14	Yes	43750	BDGT11T3... BDMT11T3...
	●		20	10.5	18.7	48	30		M10x1.5	15	+20	-10		41000	
	●	3	25	12.5	23	56	35		M12x1.75	19	+21	-9		37500	
	●		32	17	30	62	40		M16x2.0	24	+23	-9		33900	
	●		4	32	17	30	62		40	M16x2.0	24	+23		-9	
MEC 25-M12-17-2T 32-M16-17-3T	●	2	25	12.5	23	56	35	15.7	M12x1.75	19	+16	-11	Yes	35000	BDGT1704... BDMT1704...
	●	3	32	17	30	62	40		M16x2.0	24	+17	-7		30000	

Max. revolution : Do not use the cutter at the maximum revolution or higher since the centrifugal force may cause inserts and parts to scatter even under no load.

For more details, see „Warning“ on page M71.

See page M60 for applicable arbor (BT arbor for exchangeable head / double-face clamping spindle)



Milling

Spare parts (MEC modular type)

Description	Spare parts		
	Clamp screw	Wrench	Anti-seize compound
MEC 16-M08-11T-2T 20-M10-11T-2T 20-M10-11T-3T 25-M12-11T-3T 32-M16-11T-4T	SB-2555TRG Recommended tightening torque for insert clamp 1.2N·m	DTM-8	P-37
MEC 25-M12-17-2T 32-M16-17-3T	SB-4070TRN Recommended tightening torque for insert clamp 3.5N·m	DTM-15	P-37



Coat anti-seize compound thinly on portion of taper and thread when insert is fixed.

● : Standard item R : Right-hand only L : Left-hand only □ : Check availability

- Cutting edge angle 45°~70°
- Cutting edge angle 75°
- Cutting edge angle 88°/90°
- Cutter for Finishing
- High Feed Cutter
- Multi-Function
- Slot Mill
- Ball-nose Radius
- Others

BDGT/BDMT

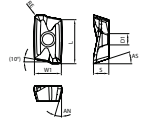
Insert		Description	No. of edges	Dimension (mm)							Angle (°)		Carbide							Cermat	PCD	Applicable toolholder M64~M68								
				S	D1	RE	L	INSL	LE	W1	AN	AS	CVD	DLC	PVD			-	-											
				CA635	PD025	PR170	PR125	PR130	PR155	GW25	TN100M	KPD001	KPD230	☆	☆	☆	☆	☆	☆											
<p>Classification of usage</p> <p>★: Roughing / 1st Choice ☆: Roughing / 2nd Choice ■: Finishing / 1st Choice □: Finishing / 2nd Choice (In case hardness is 45HRC or under)</p> 		BDMT	110302ER-JT 110304ER-JT 110308ER-JT	2	3	2.8	0.2 0.4 0.8	11	-	-	6.3	15	18	●	●	●	●	●	●	●	●	●	●	●	●	●	●	●	●	MEC...-11
		BDMT	11T302ER-JT 11T304ER-JT 11T308ER-JT 11T312ER-JT 11T316ER-JT 11T320ER-JT 11T324ER-JT 11T331ER-JT	2	3.8	2.8	0.2 0.4 0.8 1.2 1.6 2 2.4 3.1	11	-	-	6.7	13	18	●	●	●	●	●	●	●	●	●	●	●	●	●	●	●	●	MEC...-11T(...) MEC...-11-...
		BDMT	170404ER-JT 170408ER-JT 170412ER-JT 170416ER-JT 170420ER-JT 170424ER-JT 170431ER-JT 170440ER-JT	2	4.9	4.4	0.4 0.8 1.2 1.6 2 2.4 3.1 4	17	-	-	9.6	13	18	●	●	●	●	●	●	●	●	●	●	●	●	●	●	●	MEC...-17(...) MEC...-17-...	
		BDMT	110302ER-JS 110304ER-JS 110308ER-JS	2	3	2.8	0.2 0.4 0.8	11	-	-	6.3	15	18	●	●	●	●	●	●	●	●	●	●	●	●	●	●	●	MEC...-11	
		BDMT	11T302ER-JS 11T304ER-JS 11T308ER-JS	2	3.8	2.8	0.2 0.4 0.8	11	-	-	6.7	13	18	●	●	●	●	●	●	●	●	●	●	●	●	●	●	●	MEC...-11T(...) MEC...-11-...	
		BDMT	170404ER-JS 170408ER-JS	2	4.9	4.4	0.4 0.8	17	-	-	9.6	13	18	●	●	●	●	●	●	●	●	●	●	●	●	●	●	MEC...-17(...) MEC...-17-...		
		BDGT	11T302FR-JA 11T304FR-JA 11T308FR-JA	2	3.8	2.8	0.2 0.4 0.8	11	-	-	6.7	13	18	●	●	●	●	●	●	●	●	●	●	●	●	●	●	●	MEC...-11T(...) MEC...-11-...	
		BDGT	170404FR-JA 170408FR-JA 170420FR-JA 170431FR-JA	2	4.9	4.4	0.4 0.8 2 3.1	17	-	-	9.6	13	18	●	●	●	●	●	●	●	●	●	●	●	●	●	●	MEC...-17(...) MEC...-17-...		
		BDGT	11T302FR 11T304FR 11T308FR	1	3.8	2.8	0.2 0.4 0.8	-	11.5	3.8	6.7	13	18	●	●	●	●	●	●	●	●	●	●	●	●	●	●	MEC...-11T(...) MEC...-11-...		
		BDGT	11T302FR-LE 11T304FR-LE 11T308FR-LE	1	3.8	2.8	0.2 0.4 0.8	-	11.5	5.2	6.7	13	18	●	●	●	●	●	●	●	●	●	●	●	●	●	●	MEC...-11T(...) MEC...-11-...		
BDMT	11T302FR 11T304FR	1	3.8	2.8	0.2 0.4	-	11	3.6	6.7	13	18	●	●	●	●	●	●	●	●	●	●	●	●	●	●	MEC...-11T(...) MEC...-11-...				
BDMT	170402FR 170404FR	1	4.9	4.4	0.2 0.4	-	17	4.4	9.6	13	18	●	●	●	●	●	●	●	●	●	●	●	●	●	●	MEC...-17(...) MEC...-17-...				

Handed insert shows Right-hand

Recommended cutting conditions M70, M71

●: Standard item R: Right-hand only L: Left-hand only □: Check availability

CBN & PCD Inserts are sold in 1 piece boxes



Milling

When using inserts with corner-R(RE) 1.6 or larger, additional modifications of the cutter body will be necessary. Ref. to the chart below for the recommended modifications. (Additional grind off is not necessary when corner-R(RE) is 1.2 mm or less.)

* Round-shaped additional processing is recommended. When applying chamfer shaped additional processing, do not cut away too much.

Insert corner-R(RE) (mm)	Additional processing dimension to body corner (mm)
1.6	R1.0
2.0	
2.4	R1.2
3.1	R1.6
4.0	R2.5

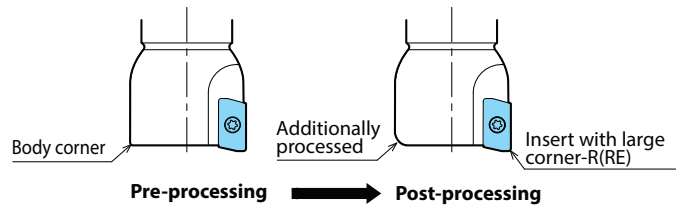

Recommended cutting conditions

JT chipbreaker

Workpiece material	fz (mm/t)		Recommended insert grades (Vc: m/min)				
	Toolholder description		Cermet	MEGACOAT NANO	MEGACOAT		CVD coated carbide
	MEC10~MEC19	MEC20~MEC40 MEC032R~MEC160R	TN100M	PR1535	PR1225	PR1210	CA6535
Carbon steel	0.06 ~ 0.1 ~ 0.15	0.08 ~ 0.15 ~ 0.25	☆ 120 ~ 160 ~ 200	☆ 120 ~ 180 ~ 250	★ 120 ~ 180 ~ 250	-	-
Alloy steel	0.06 ~ 0.1 ~ 0.12	0.08 ~ 0.15 ~ 0.2	☆ 100 ~ 140 ~ 180	☆ 100 ~ 160 ~ 220	★ 100 ~ 160 ~ 220	-	-
Mold steel	0.06 ~ 0.08 ~ 0.1	0.08 ~ 0.12 ~ 0.2	☆ 80 ~ 120 ~ 150	☆ 80 ~ 140 ~ 180	★ 80 ~ 140 ~ 180	-	-
Stainless steel (Austenitic related)	0.06 ~ 0.08 ~ 0.1	0.08 ~ 0.12 ~ 0.15	-	☆ 100 ~ 160 ~ 200	☆ 100 ~ 160 ~ 200	-	-
Stainless steel (Martensitic related)	0.06 ~ 0.08 ~ 0.1	0.08 ~ 0.12 ~ 0.2	-	☆ 150 ~ 200 ~ 250	-	-	★ 180 ~ 240 ~ 300
Stainless steel (Precipitation hardening)	0.06 ~ 0.08 ~ 0.1	0.08 ~ 0.12 ~ 0.2	-	★ 90 ~ 120 ~ 150	-	-	-
Gray cast iron	0.06 ~ 0.1 ~ 0.15	0.08 ~ 0.18 ~ 0.25	-	-	-	★ 120 ~ 180 ~ 250	-
Nodular cast iron	0.06 ~ 0.08 ~ 0.1	0.08 ~ 0.15 ~ 0.2	-	-	-	★ 100 ~ 150 ~ 200	-
Ni-base heat-resistant alloys	0.06 ~ 0.08 ~ 0.1	0.08 ~ 0.12 ~ 0.15	-	☆ 20 ~ 30 ~ 50	-	-	★ 20 ~ 30 ~ 50
Titanium alloys	0.06 ~ 0.08 ~ 0.1	0.08 ~ 0.15 ~ 0.2	-	☆ 40 ~ 60 ~ 80	-	☆ 30 ~ 50 ~ 70	-

* The bold-faced number indicates a center value of recommended cutting condition. Adjust the cutting speed and the feed rate within the above conditions according to the actual machining situation.

* Machining with coolant is recommended for Ni-base heat-resistant alloys and titanium alloys.

★ : 1st Recommendation ☆ : 2nd Recommendation

M

Milling

Cutting edge angle 45°~70°

Cutting edge angle 75°

Cutting edge angle 88°/90°

Cutter for Finishing

High Feed Cutter

Multi-Function

Slot Mill

Ball-nose Radius

Others

JS chipbreaker

Workpiece material	fz (mm/t)		Recommended insert grades (Vc: m/min)			
	Toolholder description		MEGACOAT NANO	MEGACOAT		CVD coated carbide
	MEC10~ MEC19	MEC20~MEC40 MEC032R~MEC160R	PR1535	PR1225	PR1210	CA6535
Carbon steel	0.06~ 0.1 ~0.12	0.08~ 0.15 ~0.18	☆ 120~ 180 ~250	★ 120~ 180 ~250	-	-
Alloy steel	0.06~ 0.08 ~0.1	0.08~ 0.12 ~0.15	☆ 100~ 160 ~220	★ 100~ 160 ~220	-	-
Mold steel	0.06~ 0.08 ~0.1	0.08~ 0.1 ~0.12	☆ 80~ 140 ~180	★ 80~ 140 ~180	-	-
Stainless steel (Austenitic related)	0.06~ 0.08 ~0.1	0.08~ 0.1 ~0.12	★ 100~ 160 ~200	☆ 100~ 160 ~200	-	-
Stainless steel (Martensitic related)	0.06~ 0.08 ~0.1	0.08~ 0.1 ~0.12	☆ 150~ 200 ~250	-	-	★ 180~ 240 ~300
Stainless steel (Precipitation hardening)	0.06~ 0.08 ~0.1	0.08~ 0.1 ~0.12	☆ 90~ 120 ~150	-	-	-
Ni-base heat-resistant alloys	0.06~ 0.08 ~0.1	0.08~ 0.1 ~0.12	☆ 20~ 30 ~50	-	-	★ 20~ 30 ~50
Titanium alloys	0.06~ 0.08 ~0.1	0.08~ 0.1 ~0.12	★ 40~ 60 ~80	-	-	-

* The bold-faced number indicates a center value of recommended cutting condition. Adjust the cutting speed and the feed rate within the above conditions according to the actual machining situation.

* Machining with coolant is recommended for Ni-base heat-resistant alloys and titanium alloys.

★ : 1st Recommendation ☆: 2nd Recommendation

JA chipbreaker

Workpiece material	fz (mm/t)	Recommended insert grades (Vc: m/min)	
		DLC coated carbide	Carbide
		PDL025	GW25
Aluminum alloys (Si 13% or less)	0.05~0.3	200~1,000	200~800
Aluminum alloys (Si 13% and over)	0.05~0.2	200~300	200~300

PCD

Workpiece material	fz (mm/t)	Recommended insert grades (Vc: m/min)	
		PCD	
		KPD230 (KPD001)	
Aluminum alloys (Si 13% or less)	0.05~0.2	500~1,500	
Aluminum alloys (Si 13% and over)	0.05~0.15	300~1,000	



Warning Please observe below precautions fully. Failure to observe the precautions may cause serious damage to human body.

Warning about Max. Revolution indicated on main body

1. Do not use the end mill or cutter at the maximum revolution or higher since the centrifugal force may cause inserts and parts to scatter or the body may be damaged even under no load.
2. For actual practical revolution, please set within recommended cutting condition.
3. When using at a higher revolution (over 10,000min⁻¹), refer to the table to adjust the balance of MEC and suitable arbor.

Revolution (min ⁻¹)	Balance quality grade G ISO 1940-1/8621 (JIS B0905)
~20,000	G16
~30,000	G6.3
30,000~	G2.5

Features of MEC

Good squareness

Cutting Surface Comparison

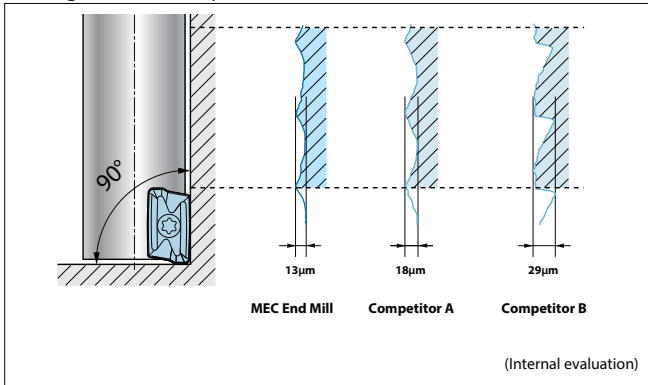

Cutting performance of mec end mill

1. Cutting edge length 10mm type (Standard/Same shank with JT chipbreaker)

Cutting dia.	Description	Overhang length LPR (mm)		Shape
		Standard	Max	
ø10	MEC10-S10-11	17	-	
ø12	MEC12-S16-11	20	30	
ø16	MEC16-S16-11T	30	45	
ø20	MEC20-S20-11T	30	45	
ø25	MEC25-S25-11T	32	48	
ø32	MEC32-S32-11T	40	60	

Low cutting force

Cutting force comparison

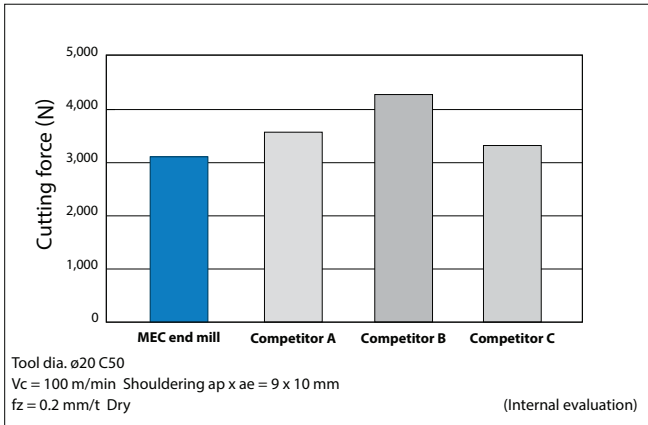

(Vc=120m/min Workpiece material: C50)

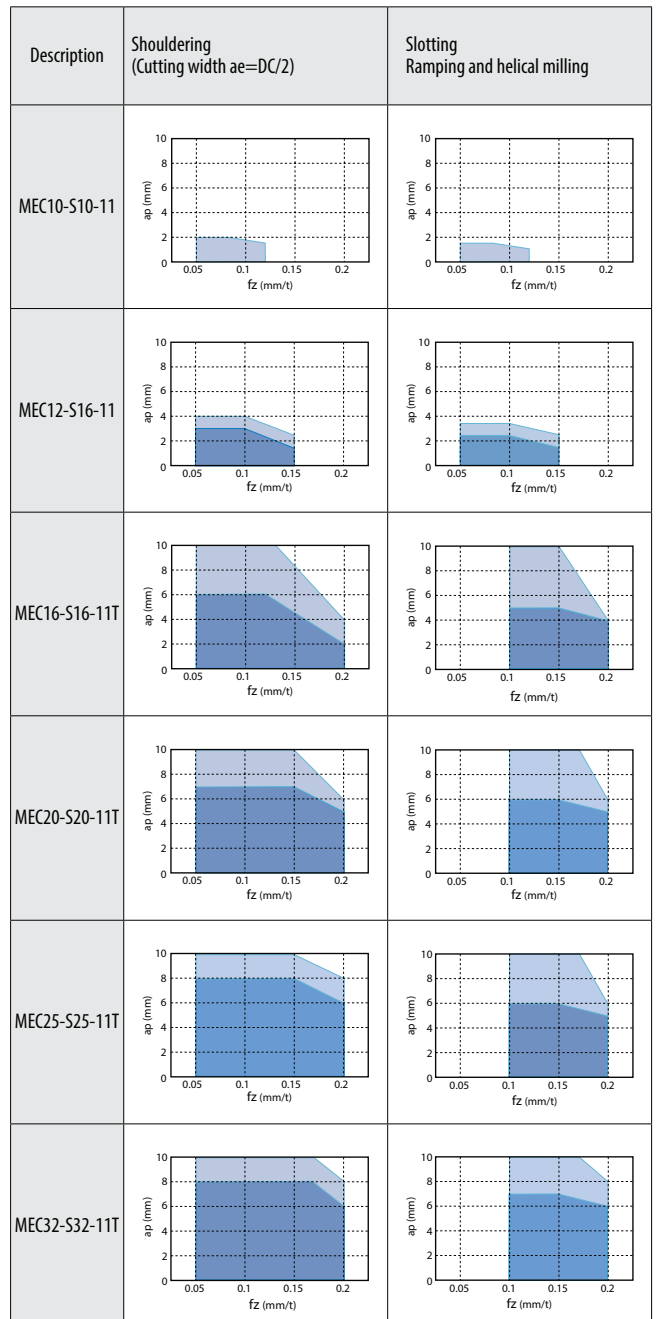

Chipbreaker

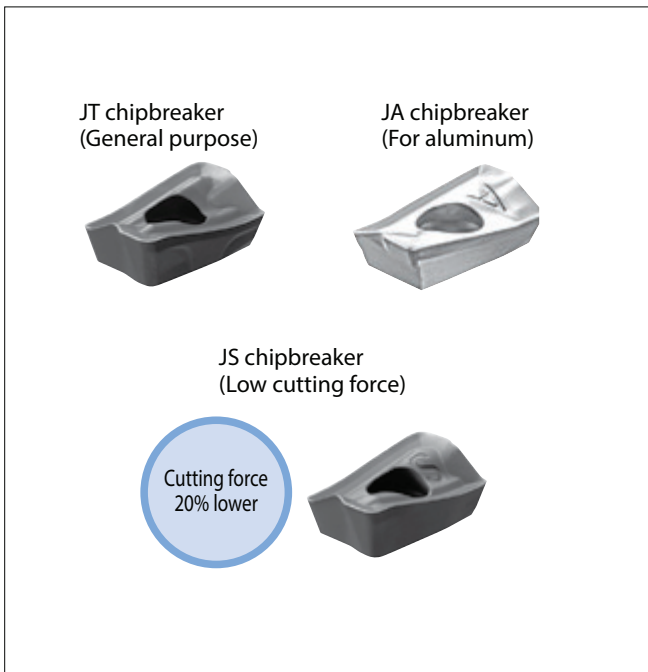

M
Milling

- Cutting edge angle 45°~70°
- Cutting edge angle 75°
- Cutting edge angle 88°/90°
- Cutter for Finishing
- High Feed Cutter
- Multi-Function
- Slot Mill
- Ball-nose Radius
- Others

2. Cutting edge length 10 mm type (Long shank with JT chipbreaker)

Cutting dia.	Description	Overhang length LPR (mm)		Shape
ø20 Long shank	MEC20-S20-140-11T	60	90	
ø25 Long shank	MEC25-S25-160-11T	60	100	
ø32 Long shank	MEC32-S32-200-11T	100	130	
ø40 Long shank	MEC40-S32-240-11T	100	130	

3. Cutting edge length 15.7 mm type (JT chipbreaker)

Cutting dia.	Description	Overhang length LPR (mm)		Shape
ø25	MEC25-S25-17	36	54	
ø32	MEC32-S32-17	40	60	
ø40	MEC40-S32-17	50	75	
ø25 Long shank	MEC25-S25-160-17	60	100	
ø32 Long shank	MEC32-S32-200-17	100	130	
ø40 Long shank	MEC40-S32-240-17	100	130	

(Vc = 120 m/min Workpiece material: C50)

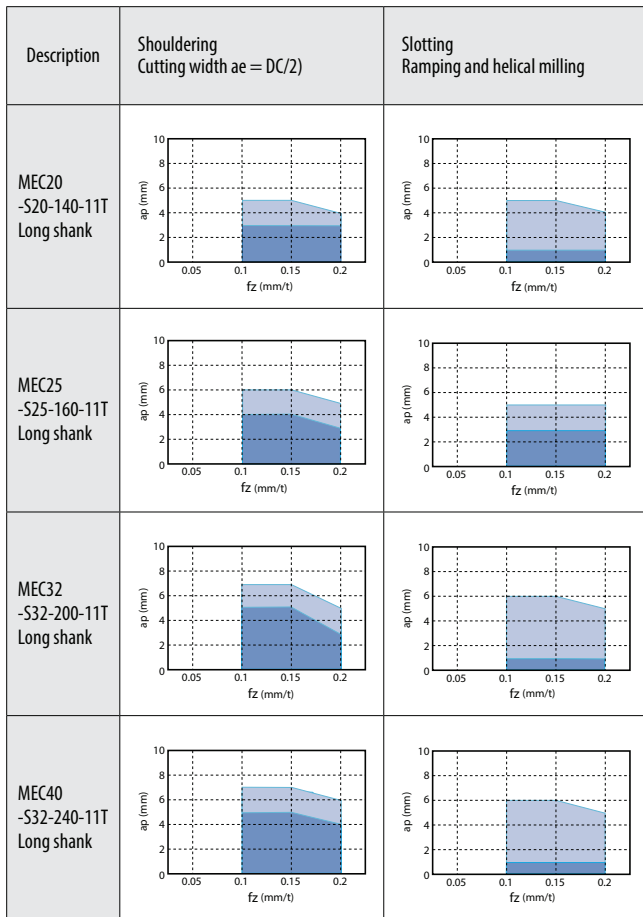

(Vc = 120 m/min Workpiece material: C50)

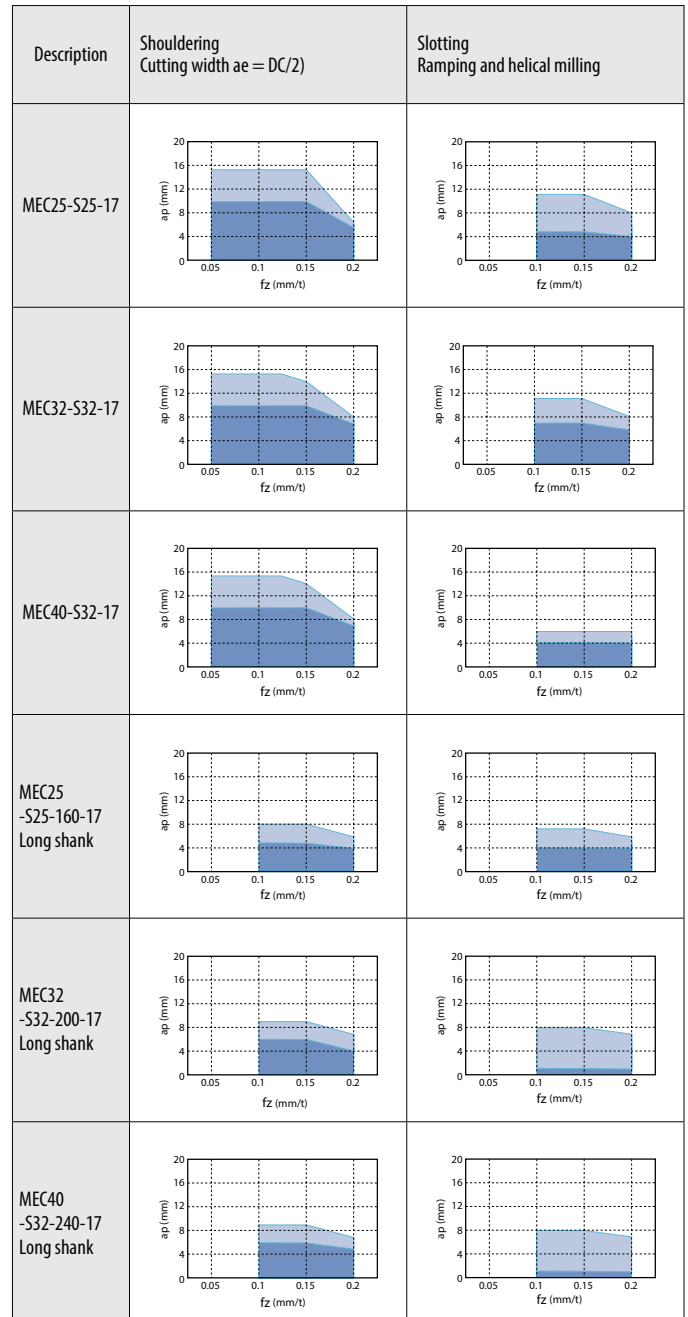

Milling

Cutting performance of MEC face mill

Cutting edge length 10 mm type (JT chipbreaker)

(Vc = 120 m/min Workpiece material: C50)

Cutting dia.	Description	Overhang length LPR (mm)
ø32	MEC032R-11-5T-M	110
ø40	MEC040R-11-T-OM	115
ø50	MEC050R-11-OT-M	100
ø63	MEC063R-11-OT	95
	MEC063R-11-OT-M	
ø80	MEC080R-11-OT	95
	MEC080R-11-OT-M	
ø100	MEC100R-11-9TN	108
	MEC100R-11-9T-MN	
ø125	MEC125R-11-11T	
	MEC125R-11-11T-M	

Shape

Description	Shouldering (Cutting width ae=DC/2)	Slotting
MEC040R-11-OT-M		
MEC050R-11-OT-M ? MEC100R-11-9TN(-MN)		
MEC125R-11-11T(-M)		

Cutting edge length 15.7 mm type (JT chipbreaker)

(Vc = 120 m/min Workpiece material: C50)

Cutting dia.	Description	Overhang length LPR (mm)
ø40	MEC040R-17-4T-M	115
ø50	MEC050R-17-OT-M	100
ø63	MEC063R-17-OT	95
	MEC063R-17-OT-M	
ø80	MEC080R-17-OT	95
	MEC080R-17-OT-M	
ø100	MEC100R-17-OTN	108
	MEC100R-17-OT-MN	
ø125	MEC125R-17-9T	
	MEC125R-17-9T-M	
ø160	MEC160R-17-12T	
	MEC160R-17-12T-M	

Shape

Description	Shouldering (Cutting width ae=DC/2)	Slotting
MEC040R-17-4T-M		
MEC050R-17-OT-M		
MEC063R-17-OT(-M) ? MEC100R-17-OTN(-MN)		
MEC125R-17-9T(-M) MEC160R-17-12T(-M)		

M

Milling

Cutting edge angle 45°~70°

Cutting edge angle 75°

Cutting edge angle 88°/90°

Cutter for Finishing

High Feed Cutter

Multi-Function

Slot Mill

Ball-nose Radius

Others

Ramping, helical milling and vertical milling (Plunging)

Ramping/Helical milling			
Ramping angle is recommended under RMPX. Refer to each tool's cutting performance list for sinking depth per revolution when helical milling. Use compressed air when during machining.			
	Cutting dia.	Applicable inserts	Max. ramping angle (RMPX)
	ø16~ø18	BDMT11T3 type BDGT11T3 type	3°
	ø19~ø21		5°
	ø22~ø25		2.5°
	ø28~ø32		1.5°
	ø40		0.7°
	ø50 and over	Not recommended	
	ø25	BDMT1704 type BDGT1704 type	8°
	ø32		5°
	ø40		2.5°
ø50 and over	Not recommended		
BDMT1103 type is not recommended for ramping and helical milling.			

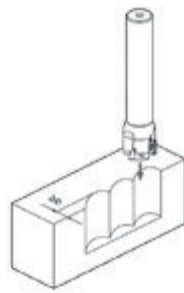
Vertical milling (Plunging)			
	Cutting dia.	Applicable inserts	Max. width of cut (ae)
	ø16 ~ ø19	BDMT11T3 type BDGT11T3 type	1.5 mm
	ø20 ~ ø160	BDMT11T3 type BDGT11T3 type	5 mm
ø25 ~ ø160	BDMT1704 type BDGT1704 type	8 mm	
BDMT1103 type is not recommended for vertical milling (plunging).			

Guidance of minimum cutting dia. by helical milling

MEC	Cutting dia.	ø16	ø18	ø20	ø22	ø25	ø28	ø30	ø32	ø40	ø50
BD_T11T3 type	Guidance of minimum cutting dia. by helical milling	ø21	ø25	ø29	ø33	ø39	ø45	ø49	ø53	ø69	Helical milling is not recommended.
	Guidance of minimum cutting dia. in case of flattening bottom after helical milling.	ø28	ø32	ø36	ø40	ø46	ø52	ø56	ø60	ø76	

MEC	Cutting dia.	ø25	ø32	ø40	ø50
BD_T1704 type	Guidance of minimum cutting dia. by helical milling	ø34	ø48	ø64	Helical milling is not recommended.
	Guidance of minimum cutting dia. in case of flattening bottom after helical milling.	ø46	ø60	ø76	

Case studies

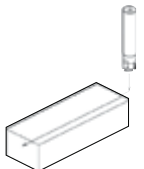
RC55 (Pre-hardened Tool Steel)	
<ul style="list-style-type: none"> • Test piece (S4~S6HRC) • Vc = 50 m/min (n = 800 min⁻¹) • ap x ae = 2 x 14 mm • fz = 0.125 mm/t (Vf = 300 mm/min) • Dry • MEC20-S20-11T • 3 flutes • BDMT11T308ER-JT 	
MEC	Chip removal amount = 71.3cm ³ (Further machining possible)
Competitor's end mill A	Chip removal amount = 2.9 cm ³ (Chipping occurred)
Competitor's end mill A (a25 (2 flutes) Vc = 40 m/min fz = 0.075 mm/t ap x ae = 2 x 3 mm) had chipping occurred in 10 minutes and had loud machining sound. MEC could increase the feed rate, and the cutting edge remained in extremely good condition and is still sustainable for further machining. (User evaluation)	

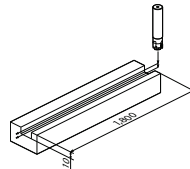
SS400	
<ul style="list-style-type: none"> • Plate • Vc = 88 m/min (n = 1,400min⁻¹) • ap = 5 mm x 2 passes • fz = 0.12 mm/t (Vf = 500 mm/min) • Dry • MEC20-S20-11T • 3 flutes • BDMT11T308ER-JT 	
MEC	23 pcs/edge
Competitor's end mill B	10~11pcs/edge
MEC extended the tool life for more than twice. (User evaluation)	

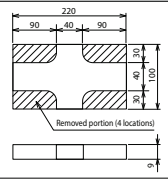
X5CrNi18 10	
<ul style="list-style-type: none"> • Plate • Vc = 125 m/min (n = 1,600 min⁻¹) • ap = 9.0 mm • fz = 0.1 mm/t (Vf = 320 mm/min) • Dry • MEC25-25-17 • 2 flutes • BDMT170408ER-JT 	
MEC	4pcs/edge or more
Competitor's end mill C	1pc/edge or less
Competitor's end mill C (indexable end mill) had high cutting force and had insert breakage, but MEC had no insert breakage and was still usable for further machining after machining 4 pieces (16 points). (User evaluation)	

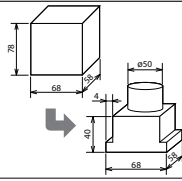
DAC10 (Hot work tool steel)	
<ul style="list-style-type: none"> • Mold • Vc = 130 m/min (n = 1,040 min⁻¹) • ap x ae = (~3) x (~5) (Varies depending on machining point) • fz = 0.18 mm/t (Vf = 936 mm/min) • Dry (Air blow) • MEC40-S32-11T + 5 flutes • BDMT11T308ER-JT 	
MEC	2 hours (Small wear: extendible)
Competitor's end mill D	2 hours (Halted due to insert breakage)
MEC had better cutting performance/insert life comparing to competitor's end mill D, and the insert had only small wear and was usable for further machining after used for machining of the same duration as competitor's end mill D. Competitor's end mill D (6 flutes type) was used with Vf = 936 mm/min (fz = 0.15 mm/t). (User evaluation)	

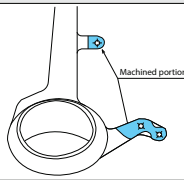
20CrMo5	
<ul style="list-style-type: none"> • Knuckle Steering • Vc = 150 m/min (n = 1,200 min⁻¹) • ap = 0.5~5 mm (Shouldering) • fz = 0.1 mm/t (Vf = 478 mm/min) • Dry • MEC40-S32-17 • 4 flutes • BDMT170408ER-JT 	
MEC	150 pcs/edge
Competitor's end mill E	40pcs/edge
MEC had a better finished surface comparing to competitor's end mill E and also improved the tool life by more than 3 times. (User evaluation)	

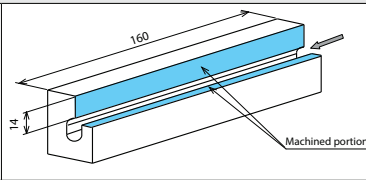
Ni-base heat-resistant alloys	
<ul style="list-style-type: none"> • Turbine parts • Vc = 15 m/min (n = 120 min⁻¹) • ap = 0.5 mm • fz = 0.08 mm/t (Vf = 38 mm/min) • Wet • MEC040R-17-4T-M • 4 flutes • BDMT170408ER-JS 	
MEC	9pcs/edge
Competitor's end mill F	1pc/edge or less
Competitor's end mill F (Coated carbide Insert) could not finish machining of 1 workpiece, but MEC could cut 9pcs/edge and the finished surface was good. (User evaluation)	



MECX

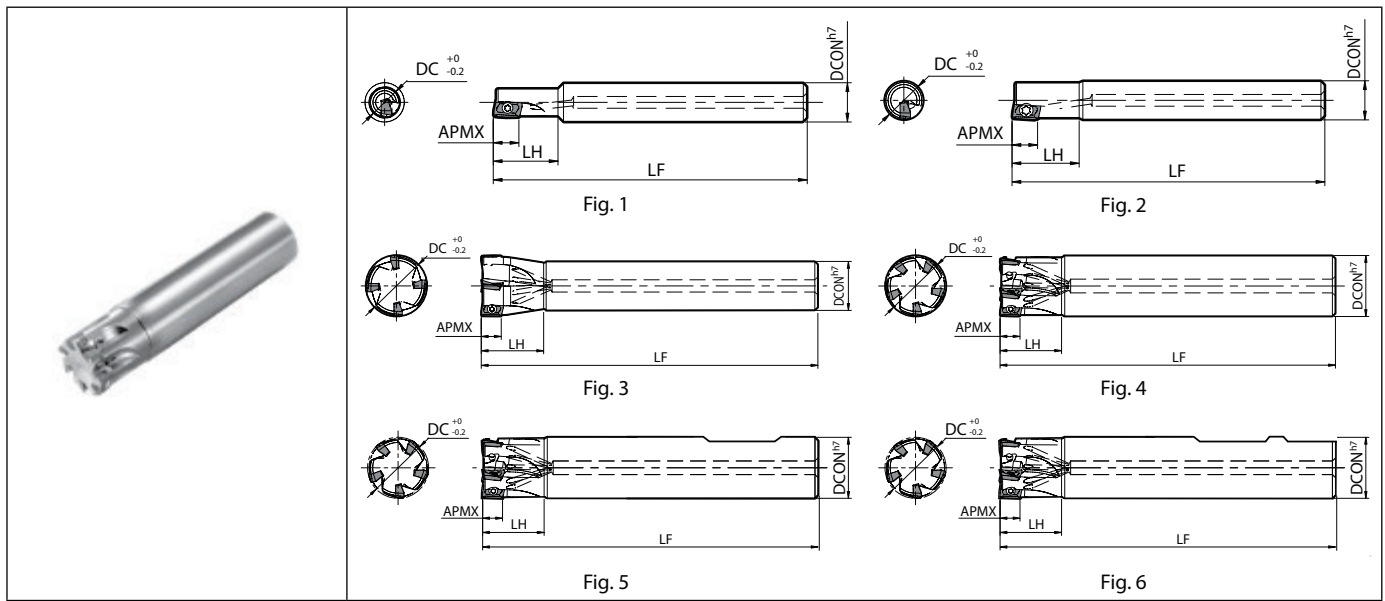

Toolholder dimensions

Description	Availability	Dimension (mm)					A.R. max. (°)	R.R. (°)	Coolant hole	Max. revolution (min ⁻¹)	Fig.	Spare parts			Applicable inserts M78			
		DC	DCON	LF	LH	APMX						Anti-seize compound	Screw	Wrench				
																Inserts		
Standard shank Standard	MECX	●	1	8	10	16	6	+11.7	-24	Yes	48100	1	P-37	SB-2035TRG	DTM-6	BDMT0703...-JT BDMT0703...-JS		
			2	14	12	18		-12.1	44800								3	
			3	17	16	100		-11	42400								3	
			4	18	16	20		-10.9	41600								3	
			5	20	20	110		-10.4	40200								3	
			6	21	20	120		-10.1	39500								3	
			7	25	25	120		-9.7	37000								3	
			8	26	25	120		-9.5	36500								3	
			9	33	32	130		-8.8	33100								3	
			10	33	32	130		-8.8	33100								3	
Standard shank Fine pitch	MECX	●	5	20	16	110	6	+16.3	-10.4	Yes	40200	3	P-37	SB-2042TRG	DTM-6	BDMT0703...-JT BDMT0703...-JS		
			7	25	20	120	25	-9.7	37000	3								
Same shank Standard	MECX	●	1	10	10	17	6	+12.8	-18.7	Yes	47100	2	P-37	SB-2035TRG	DTM-6	BDMT0703...-JT BDMT0703...-JS		
			2	12	12	18		+14.3	-13.7								46200	4
			3	16	16	100		-11.3	43200								4	
			4	20	20	110		-10.4	40200								4	
			5	25	25	120		-9.7	37000								4	
			6	25	25	120		-9.7	37000								4	
			7	25	25	120		-9.7	37000								4	
			8	32	32	130		-8.9	33600								4	
			9	32	32	130		-8.9	33600								4	
			10	32	32	130		-8.9	33600								4	
Same shank Fine pitch	MECX	●	4	16	16	100	6	+16.3	-11.3	Yes	43200	4	P-37	SB-2042TRG	DTM-6	BDMT0703...-JT BDMT0703...-JS		
			5	20	20	110	-10.4	40200	4									
			7	25	25	120	25	-9.7	37000	4								
Long shank Standard	MECX	●	3	17	16	130	6	+16.3	-11	Yes	42400	3	P-37	SB-2042TRG	DTM-6	BDMT0703...-JT BDMT0703...-JS		
			4	21	20	140	-10.1	39500	3									
			5	26	25	160	25	-9.5	36500	3								
			6	26	25	160	25	-9.5	36500	3								
Welded Standard	MECX	●	3	16	16	68.5	6	+16.3	-11.3	Yes	43200	5	P-37	SB-2042TRG	DTM-6	BDMT0703...-JT BDMT0703...-JS		
			4	20	20	81		-10.4	40200								5	
			5	25	25	88		-9.7	37000								6	
			6	25	25	88		-9.7	37000								6	
			7	25	25	88		-9.7	37000								6	
			8	25	25	88		-9.7	37000								6	
			9	25	25	88		-9.7	37000								6	
			10	25	25	88		-9.7	37000								6	
Welded Fine pitch	MECX	●	3	16	16	68.5	6	+16.3	-11.3	Yes	43200	5	P-37	SB-2042TRG	DTM-6	BDMT0703...-JT BDMT0703...-JS		
			4	20	20	81		-10.4	40200								5	
			5	25	25	88		-9.7	37000								6	
			7	25	25	88		-9.7	37000								6	

Max. revolution : Do not use the cutter at the maximum revolution or higher since the centrifugal force may cause inserts and parts to scatter even under no load. For more details, see "Warning" on page M79.
 For good shoulder finishes by MECX multistage ap. In order to obtain smooth machining wall surface by MECX multistage ap set ap within 5mm for each cut.
 Coat Anti-seize Compound(P-37) thinly on portion of taper and thread when insert is fixed.

● : Standard item R : Right-hand only L : Left-hand only □ : Check availability



- Cutting edge angle 45°~70°
- Cutting edge angle 75°
- Cutting edge angle 88°/90°
- Cutter for Finishing
- High Feed Cutter
- Multi-Function
- Slot Mill
- Ball-nose Radius
- Others

MECX

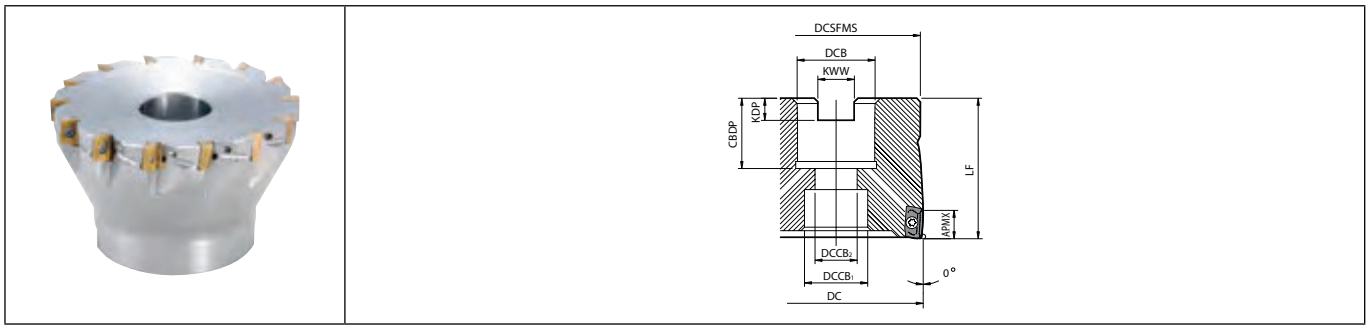

Toolholder dimensions

Description	Availability		Dimension (mm)										A.R. MAX. (°)	R.R. (°)	Coolant hole	Max. revolution (min ⁻¹)	Weight (kg)	Spare parts			Applicable inserts M78
	R	Inserts	DC	DCSFMS	DCB	DCCB ₁	DCCB ₂	LF	CBDP	KDP	KWW	APMX						Anti-seize compound	Screw	Wrench	
MECX 032R-07-8T-M	●	8	32	30	16	14	8.5	40	20	5.5	8.5	6	+7	-8.9	Yes	33600	0.15	P-37	SB-2042TRG	DTM-6	BDMT0703...-JT BDMT0703...-JS
MECX 040R-07-10T-M	●	10	40	38	22	18	12	40	22	6.3	10.4	6	+7	-8.4	Yes	30500	0.25	P-37	SB-2042TRG	DTM-6	BDMT0703...-JT BDMT0703...-JS

Max. revolution : Do not use the cutter at the maximum revolution or higher since the centrifugal force may cause inserts and parts to scatter even under no load.

For more details, see „Warning“ on page M79.

For good shoulder finishes by MECX multistage ap.



In order to obtain smooth machining wall surface by MECX multistage ap set ap within 5mm for each cut.

Coat Anti-seize Compound(P-37) thinly on portion of taper and thread when insert is fixed.

MECX032R comes with mounting bolt (HH8X25H) and MECX040R comes with mounting bolt (HH10X30H).

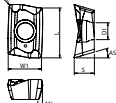

BDMT

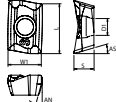
Insert		Description	No. of edges	Dimension (mm)					Angle (°)		Carbide				Applicable toolholder ➡ M76 M77
				S	D1	RE	L	W1	AN	AS	CVD		PVD		
											CA6535	PR1210	PR1225	PR1535	
 		BDMT 070302ER-JT 070304ER-JT 070308ER-JT	2	2.6	2.3	0.2 0.4 0.8	6.7	4.6	15	16	● ● ●	● ● ●	● ● ●	MECX...-07-...	
  <p>Low cutting force / Stainless steel</p>		BDMT 070302ER-JS 070304ER-JS 070308ER-JS	2	2.6	2.3	0.2 0.4 0.8	6.7	4.6	15	16	● ● ●	● ● ●	● ● ●	MECX...-07-...	

Handed insert shows Right-hand

Recommended cutting conditions ➡ M79

M



Milling

- Cutting edge angle 45°~70°
- Cutting edge angle 75°
- Cutting edge angle 88°/90°
- Cutter for Finishing
- High Feed Cutter
- Multi-Function
- Slot Mill
- Ball-nose Radius
- Others

● : Standard item R : Right-hand only L : Left-hand only □ : Check availability

M78

Chipbreaker selection

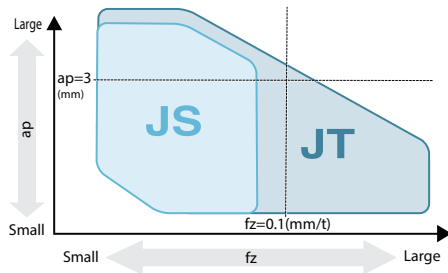

Cutting force comparison (Internal evaluation)

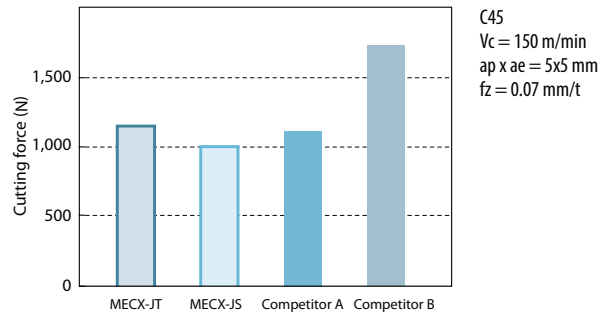

Warning Please observe below precautions fully. Failure to observe the precautions may cause serious damage to human body.

Warning about max. revolution indicated on main body

1. Do not use the end mill or cutter at the maximum revolution or higher since the centrifugal force may cause inserts and parts to scatter or the body may be damaged even under no load.
2. For actual practical revolution, please set within recommended cutting condition.
3. When using at a higher revolution (over 10,000min⁻¹), refer to the table to adjust the balance of MECX and suitable arbor.

Revolution (min ⁻¹)	Balance quality grade G ISO 1940-1/8821 (JIS B0905)
~20,000	G16
~30,000	G6.3
30,000~	G2.5

Recommended cutting conditions

Workpiece material	fz (mm/t)		Recommended insert grades (Vc: m/min)			
	JS chipbreaker	JT chipbreaker	MEGACOAT NANO	MEGACOAT		CVD coated carbide
			PR1535	PR1225	PR1210	CA6535
Carbon steel	0.04~ 0.08 ~0.1	0.06~ 0.1 ~0.12	☆ 120~ 180 ~250	★ 120~ 180 ~250	-	-
Alloy steel	0.04~ 0.06 ~0.08	0.06~ 0.08 ~0.1	☆ 100~ 160 ~220	★ 100~ 160 ~220	-	-
Mold steel	0.04~ 0.06 ~0.08	0.06~ 0.08 ~0.1	☆ 80~ 140 ~180	★ 80~ 140 ~180	-	-
Stainless steel (Austenitic related)	0.03~ 0.04 ~0.05	0.05~ 0.06 ~0.07	★ 100~ 160 ~200	☆ 100~ 160 ~200	-	-
Stainless steel (Martensitic related)	0.03~ 0.04 ~0.05	0.05~ 0.06 ~0.1	☆ 150~ 200 ~250	-	-	★ 180~ 240 ~300
Stainless steel (Precipitation hardening)	0.03~ 0.04 ~0.05	0.05~ 0.06 ~0.1	★ 90~ 120 ~150	-	-	-
Gray cast iron	0.04~ 0.08 ~0.1	0.08~ 0.1 ~0.15	-	-	★ 120~ 180 ~250	-
Nodular cast iron	0.04~ 0.06 ~0.08	0.08~ 0.1 ~0.12	-	-	★ 100~ 150 ~200	-
Ni-base heat-resistant alloys	0.03~ 0.04 ~0.05	0.05~ 0.06 ~0.07	☆ 20~ 30 ~50	-	-	★ 20~ 30 ~50
Titanium alloys	0.04~ 0.06 ~0.08	0.08~ 0.1 ~0.12	★ 40~ 60 ~80	-	☆ 30~ 50 ~70	-

* Machining with coolant is recommended for Ni-base heat-resistant alloys and titanium alloys.

★: 1st Recommendation ☆: 2nd Recommendation



Milling

Ramping/Helical milling

Ramping angle is recommended under RMPX.

Refer to each tool's cutting performance list for sinking depth per revolution when helical milling. Use compressed air during machining.

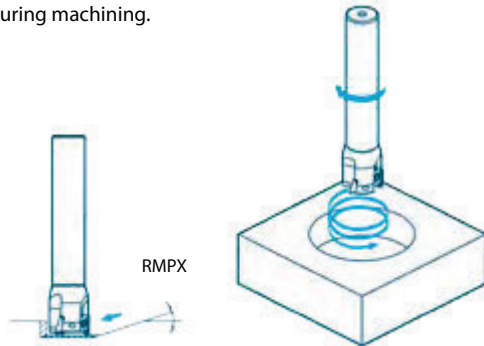

Cutting dia.	Applicable inserts	Max. ramping angle (RMPX)
ø8	BDMT0703 type	Not recommended
ø10		1.5°
ø12,ø14		2°
ø16		3°
ø17,ø18		1.5°
ø20		2°
ø21		1.8°
ø25		1.3°
ø26		1.2°
ø32		0.8°
ø33		0.5°

Guidance of minimum cutting dia. by helical milling

MECX	Cutting dia.	ø8	ø10	ø12	ø14	ø16	ø17	ø18	ø20
BDMT0703 type	Guidance of minimum cutting dia. by helical milling	Helical milling is not recommended	ø14	ø18	ø22	ø26	ø28	ø30	ø34
	Guidance of minimum cutting dia. in case of flattening bottom after helical milling		ø17	ø21	ø25	ø29	ø31	ø33	ø37

MECX	Cutting dia.	ø21	ø25	ø26	ø32	ø33
BDMT0703 type	Guidance of minimum cutting dia. by helical milling	ø36	ø44	ø46	ø58	ø60
	Guidance of minimum cutting dia. in case of flattening bottom after helical milling	ø39	ø47	ø49	ø61	ø63



Milling

Cutting edge angle 45°~70°
Cutting edge angle 75°
Cutting edge angle 88°/90°
Cutter for Finishing
High Feed Cutter
Multi-Function
Slot Mill
Ball-nose Radius
Others

Cutting performance of MECX end mill

(Vc = 150 m/min Workpiece material: C50)

Cutting dia.	Description	Overhang length LPR (mm)	
ø8	MECX08-S10-07-1T	16	-
ø10	MECX10-S10-07-1T	17	-
ø12	MECX12-S12-07-2T	18	30
ø16	MECX16-S16-07-3T	20	40
ø20	MECX20-S20-07-4T	20	40
ø25	MECX25-S25-07-5T	25	50
ø32	MECX32-S32-07-6T	30	50

Shape

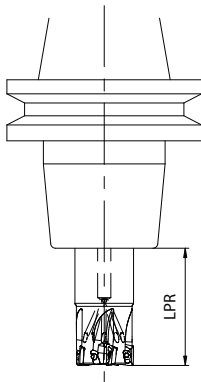

- * Machining with extended Overhang length is not recommended for ø8 and ø10.
 - * The cutting performance list shows applicable range of JT chipbreaker with Standard flute-number type.
- For multi-edge type, use with 70% or less of ap.
- * Cutting conditions of JS chipbreaker
1. For MECX08~MECX12
Decrease the feed rate by 25% according to cutting capability list.
 2. For MECX16 and over
Decrease the feed rate and ap by 30% according to cutting capability list.

Description	Shouldering (Cutting width ae = DC/2)	Slotting Ramping and helical milling
MECX08-S10-07-1T		
MECX10-S10-07-1T		
MECX12-S12-07-2T		
MECX16-S16-07-3T		
MECX20-S20-07-4T		
MECX25-S25-07-5T		
MECX32-S32-07-6T		

Cutting performance of MECX face mill

(Vc = 150 m/min Workpiece material: C50)

Cutting dia.	Description	Overhang length LPR (mm)
ø32	MECX032R-07-8T-M	100
ø40	MECX040R-07-10T-M	

Shape

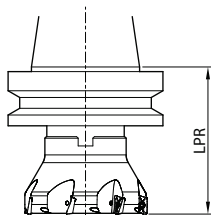

Description	Shouldering (Cutting width ae=DC/2)
MECX032R-07-8T-M MECX040R-07-10T-M	

- * Use JT chipbreaker.
- * Slotting is not recommended.



High performance milling

MEV

Newly developed triangular inserts providing low cutting force and increased toolholder rigidity. High performance, economical, and multi-functional milling solutions.

1 High performance: low cutting force and high rigidity

Newly developed vertical triangle inserts with 3 cutting edges achieve stable machining with reduced chattering.

MEV vs. competitor

	MEV Vertical triangle inserts	Conventional end mill Positive inserts	Conventional end mill Vertical inserts
Cutting force	A.R.: Large A.R. Max.+17° Low cutting force	A.R.: Large Low cutting force	A.R.: small Low cutting force
Toolholder's rigidity	Web thickness: large High rigidity <i>about 120% Web thickness</i>	Web thickness: small High rigidity	Web thickness: large High rigidity
	Cutting force: Low Toolholder's rigidity: High	Cutting force: Low Toolholder's rigidity: Low	Cutting force: High Toolholder's rigidity: High

Keeping A.R. max. at 17°, provides lower cutting force than the positive insert types of competitors

Cutting force comparison (internal evaluation)

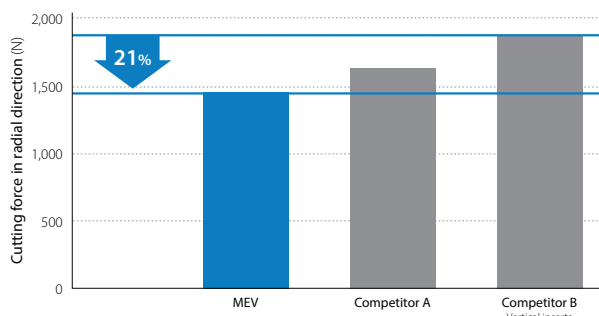

Cutting conditions: Vc = 200 m/min, ap x ae = 3 x 18 mm, fz = 0.10 mm/t, ø20 (3 inserts), Dry, workpiece: 42CrMo4

Low cutting force and large optimal web thickness provides excellent chattering resistance

Chattering resistance comparison (internal evaluation)

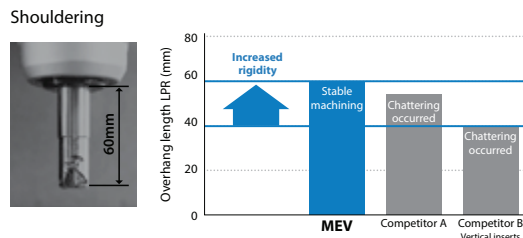

Cutting conditions: Vc = 200 m/min, ap x ae = 3 x 18 mm, fz = 0.10 mm/t, ø20 (3 inserts), dry, workpiece: 42CrMo4

Slotting



Cutting conditions: Vc = 220 m/min, ap = 3 mm (Slotting), fz = 0.10 mm/t, ø20 (3 inserts), dry, workpiece: 42CrMo4

M
Milling

- Cutting edge angle 45°~70°
- Cutting edge angle 75°
- Cutting edge angle 88°/90°
- Cutter for Finishing
- High Feed Cutter
- Multi-Function
- Slot Mill
- Ball-nose Radius
- Others

2 The economical choice: 3 cutting edge insert with long tool life

Insert

Unique triangle inserts with 3 cutting edges. PR15 series utilizes MEGACOAT NANO coating technology with excellent wear and adhesion resistance.

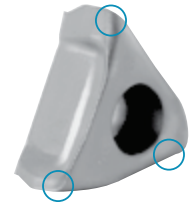

Long tool life with excellent wear resistance

Wear resistance comparison (internal evaluation)

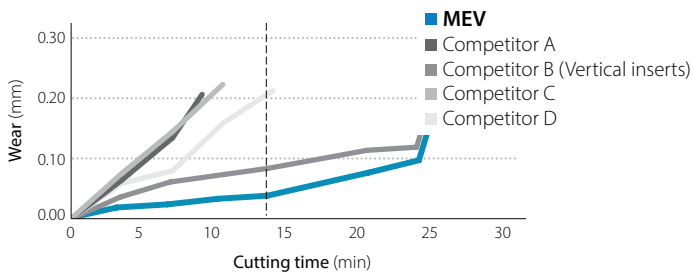

Cutting conditions: Vc = 180 m/min, ap x ae = 3 x 10 mm, fz = 0.1 mm/t, ø20, dry, workpiece: X153CrMoV12 (30~35HS)

Cutting edge (after machining 14 min)

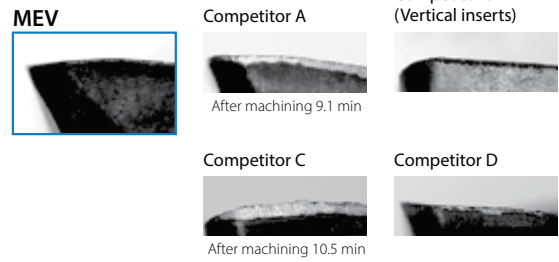

Improved stability with superior fracture resistance

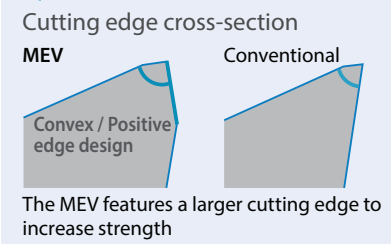

Wear resistance comparison (internal evaluation)

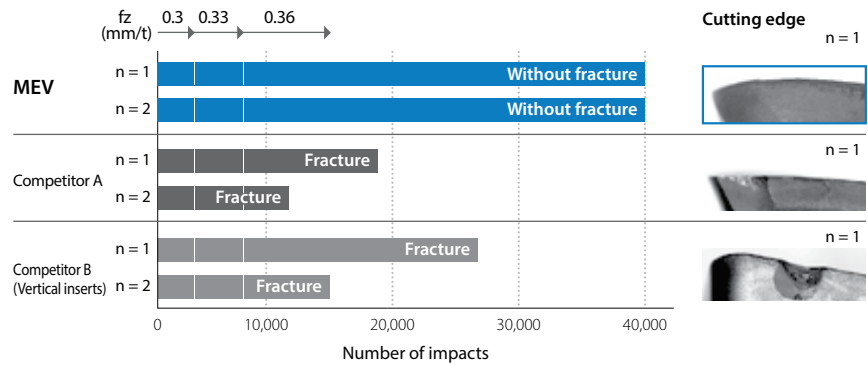

Cutting conditions: Vc = 120 m/min, ap x ae = 2 x 10 mm, fz = 0.3 - 0.36 mm/t, ø20 (1 insert), dry, workpiece: 42CrMo4 (37~39HS)



3 Multi-functional: The MEV can perform a wide variety of machining processes

Great performance in shouldering, slotting, and ramping applications (D.O.C. 6 mm or less)

Chip example (slotting)



Cutting conditions: Vc = 150 m/min, ap = 6 mm (Slotting), fz = 0.2 mm/t, ø20 (3 insert), dry, workpiece: ST44-2

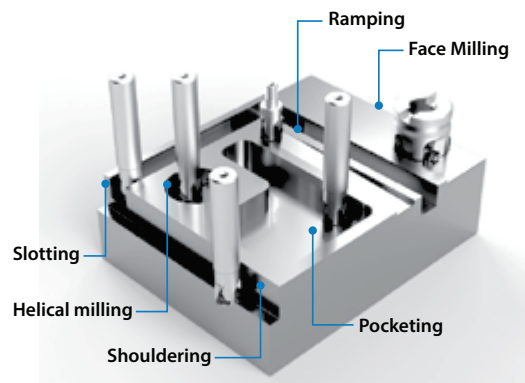

MEV

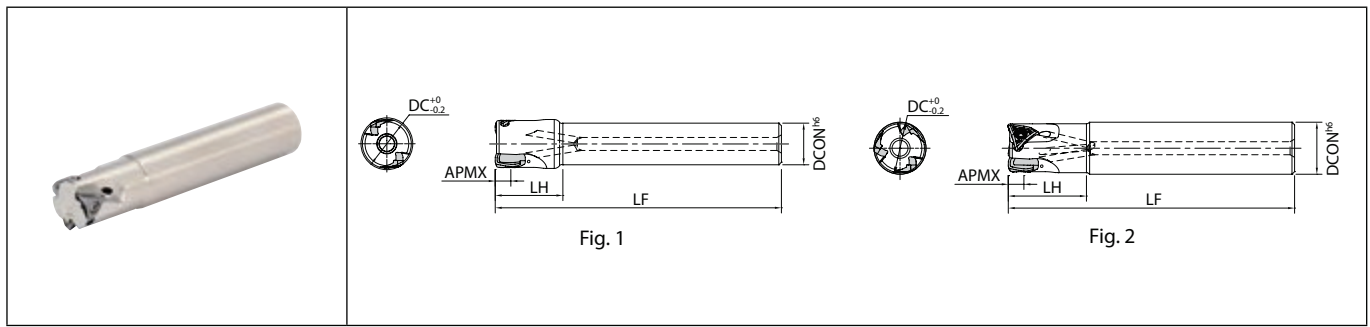

Toolholder dimensions

Description	Availability	Inserts	Dimension (mm)					A.R. max. (°)	R.R. (°)	Coolant hole	Max. revolution (min ⁻¹)	Weight (kg)	Fig.	Spare parts			Applicable inserts M87		
			DC	DCON	LF	LH	APMX							Anti-seize compound	Screw	Wrench			
			Icons			Icons													
Standard shank	MEV	20-S16-06-2T	●	2	20	16	110	26	6	+17	-38	32000	0.2	1	P-37	SB-3076TRP	DTPM-10	TOMT0605...-GM TOMT0605...-SM	
		22-S20-06-3T	●		22	20				-37	29000	0.2	1						
		25-S20-06-3T	●	3	25		120	29			25000	0.3	1						
		28-S25-06-3T	●		28						23000	0.4	1						
		30-S25-06-4T	●	4	30	25	130	32			21500	0.5	1						
		32-S25-06-4T	●		32					20000	0.5	1							
		40-S32-06-5T	●	5	40	150	50				16000	1	1						
		50-S32-06-5T	●		50	32	120	40			13000	0.9	1						
Cylindrical Same shank	MEV	20-S20-06-2T	●	2	20	20	110	30	6	+17	-38	32000	0.2	2	P-37	SB-3076TRP	DTPM-10	TOMT0605...-GM TOMT0605...-SM	
		20-S20-06-3T	●	3						-37	25000	0.4	2						
		25-S25-06-2T	●	2	25	25	120	32			-36	20000	0.7	2					
		25-S25-06-3T	●																
		32-S32-06-3T	●	3	32	32	130	40			2	2							
		32-S32-06-4T	●							4									
Long shank	MEV	20-S18-06-150-2T	●	2	20	18	30	6	+17	-38	32000	0.3	1	P-37	SB-3076TRP	DTPM-10	TOMT0605...-GM TOMT0605...-SM		
		20-S18-06-150-3T	●	3		150			2										
		20-S20-06-150-2T	●	2	20	40													
		20-S20-06-150-3T	●	3															
		25-S25-06-170-2T	●	2	25	25	170		50		-37	25000	0.6					2	
		25-S25-06-170-3T	●							3									
		32-S32-06-200-2T	●	2	32	32	200		65		-36	20000	1.1					2	
		32-S32-06-200-3T	●							3									
											-35								

Max. revolution : Do not use the cutter at the maximum revolution or higher since the centrifugal force may cause inserts and parts to scatter even under no load.
Coat Anti-seize Compound thinly on portion of taper and thread when insert is fixed.



Cutting edge angle 45°~70°
Cutting edge angle 75°
Cutting edge angle 88°/90°

- Cutter for Finishing
- High Feed Cutter
- Multi-Function
- Slot Mill
- Ball-nose Radius
- Others

● : Standard item R : Right-hand only L : Left-hand only □ : Check availability

MEV

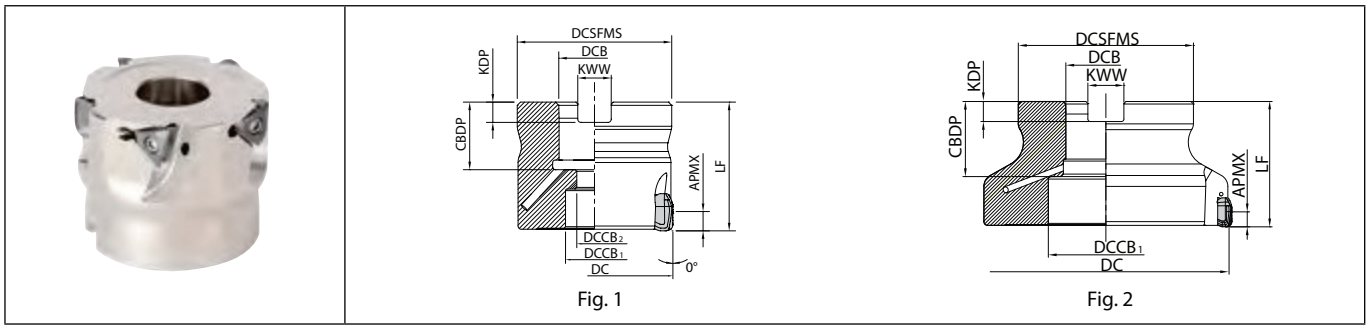

Toolholder dimensions

Description	Availability	Inserts	Dimension (mm)											A.R. max. (°)	R.R. (°)	Coolant hole	Max. revolution (min ⁻¹)	Weight (kg)	Fig.	Spare parts				Applicable inserts ➔ M87
			R	DC	DCSFMS	DCB	DCCB ₁	DCCB ₂	LF	CBDP	KDP	KWW	APMX							Anti-seize compound	Mounting bolt	Screw	Wrench	
MEV 032R-06-4T-M	●	4	32	30	16	13.5	9	35	19	5.6	8.4	6	+17	-36	Yes	20000	0.1	1	P-37	HH8X25	SB-3076TRP	DTPM-10	TOMT0605...-GM TOMT0605...-SM	
040R-06-5T-M	●	5	40	38	15	9	35	19	5.6	8.4	+16		16000			0.2	1							
050R-06-5T-M	●	5	50	48	22	18	11	40	21	6.3	10.4	6	+16	-36	Yes	13000	0.4	1	P-37	HH10X30	SB-3076TRP	DTPM-10	TOMT0605...-GM TOMT0605...-SM	
063R-06-6T-M	●	6	63	48	22	18	11	40	21	6.3	10.4	6	+16	-36	Yes	10000	0.6	1						
080R-06-7T-M	●	7	80	60	27	20	13	50	24	7	12.4	6	+15	-35	Yes	7900	1.1	1	P-37	HH12X35	SB-3076TRP	DTPM-10	TOMT0605...-GM TOMT0605...-SM	
080R-06-7T	●	7	80	60	25.4	20	13	50	27	6	9.5	6	+15	-35	Yes	7900	1.1	1						
100R-06-9T-M	●	9	100	70	32	46	-	50	30	8	14.4	6	+15	-35	Yes	6300	1.4	2	P-37	-	SB-3076TRP	DTPM-10	TOMT0605...-GM TOMT0605...-SM	
100R-06-9T	●	9	100	70	31.75	46	-	63	34	8	12.7	6	+15	-35	Yes	6300	1.4	2						

Max. revolution : Do not use the cutter at the maximum revolution or higher since the centrifugal force may cause inserts and parts to scatter even under no load.
Coat Anti-seize Compound thinly on portion of taper and thread when insert is fixed.



MEV

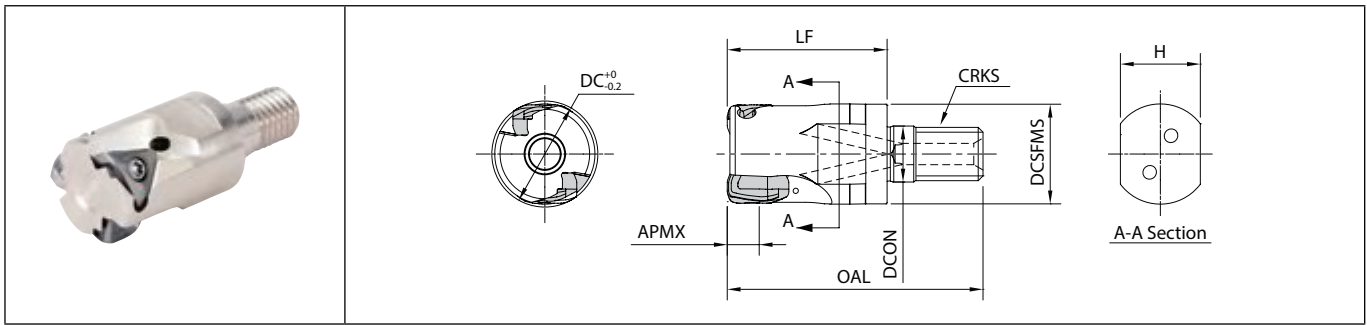

Toolholder dimensions

Description	Availability	Inserts	Dimension (mm)							A.R. max. (°)	R.R. (°)	Coolant hole	Max. revolution (min ⁻¹)	Spare parts			Applicable inserts ➔ M87		
			DC	DCON	DCSFMS	OAL	LF	APMX	CRKS					H	Anti-seize compound	Screw		Wrench	
MEV 20-M10-06-2T	●	2	20	10.5	18.7	48	30	6	M10x1.5	15	+17	Yes	32000	P-37	SB-3076TRP	DTPM-10	TOMT0605...-GM TOMT0605...-SM		
20-M10-06-3T	●	3	25	12.5	23	56	35		M12x1.75	19								-37	25000
25-M12-06-3T	●	3	25	12.5	23	56	35		M12x1.75	19								-37	25000
32-M16-06-4T	●	4	32	17	30	62	40	M16x2.0	24	-36		20000							

Max. revolution : Do not use the cutter at the maximum revolution or higher since the centrifugal force may cause inserts and parts to scatter even under no load.

Coat Anti-seize Compound thinly on portion of taper and thread when insert is fixed.

See page M60 for applicable arbor (BT arbor for exchangeable head / double-face clamping spindle)

M



Milling

Cutting edge angle
45°~70°

Cutting edge angle
75°

Cutting edge angle
88°/90°

Cutter for
Finishing

High Feed
Cutter

Multi-
Function

Slot Mill



Ball-nose
Radius

Others

● : Standard item R : Right-hand only L : Left-hand only □ : Check availability

M86

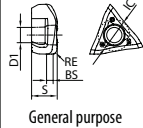
TOMT

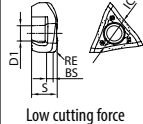
Insert		Description	No. of edges	Dimension (mm)					Carbide			Applicable toolholder M84~M86	
				IC	S	D1	RE	BS	CVD	PVD			
									CA6535	PR1510	PR1525	PR1535	
	 General purpose	TOMT 060504ER-GM 060508ER-GM	3	7.2	5.7	3.4	0.4 0.8	1.9 1.5	●	●	●	●	MEV...-06-...
	 Low cutting force	TOMT 060508ER-SM	3	7.2	5.7	3.4	0.8	1.5	●	●	●		MEV...-06-...

Handed insert shows Right-hand

Recommended cutting conditions M88

Classification of usage

- ★ : Roughing / 1st Choice
- ☆ : Roughing / 2nd Choice
- : Finishing / 1st Choice
- : Finishing / 2nd Choice
- (In case hardness is 45HRC or under)

Carbon steel / Alloy steel			★	☆	P
Mold and die steel			★	☆	
Austenitic stainless steel			☆	★	M
Martensitic stainless steel	★			☆	
Precipitation hardening stainless steel				★	
Gray cast iron		★			K
Nodular cast iron		★			
Non-ferrous metals					N
Heat-resistant alloy	★			☆	S
Titanium alloy				★	
Hard materials					H

● : Standard item R : Right-hand only L : Left-hand only □ : Check availability



Recommended cutting conditions

Chipbreaker	Workpiece	Feed (fz: mm/t)	Recommended insert grade (Vc: m/min)			
			MEGACOAT NANO			CVD coating
			PR1535	PR1525	PR1510	CA6535
GM	Carbon steel	0.08 – 0.15 – 0.25	120 – 180 – 250	120 – 180 – 250	–	–
	Alloy steel	0.08 – 0.15 – 0.2	100 – 160 – 220	100 – 160 – 220	–	–
	Mold steel	0.08 – 0.12 – 0.2	80 – 140 – 180	80 – 140 – 180	–	–
	Stainless steel (Austenitic related)	0.08 – 0.12 – 0.15	100 – 160 – 200	100 – 160 – 200	–	–
	Stainless steel (Martensitic related)	0.08 – 0.12 – 0.2	150 – 200 – 250	–	–	180 – 240 – 300
	Stainless steel (Precipitation hardening)	0.08 – 0.12 – 0.2	90 – 120 – 150	–	–	–
	Gray cast iron	0.08 – 0.18 – 0.25	–	120 – 180 – 250	120 – 180 – 250	–
	Nodular cast iron	0.08 – 0.15 – 0.2	–	100 – 150 – 200	100 – 150 – 200	–
	Ni-base heat-resistant alloy	0.08 – 0.12 – 0.15	20 – 30 – 50	–	–	20 – 30 – 50
	Titanium alloy	0.08 – 0.15 – 0.2	40 – 60 – 80	–	30 – 50 – 70	–
SM	Carbon steel	0.08 – 0.15 – 0.2	120 – 180 – 250	120 – 180 – 250	–	–
	Alloy steel	0.08 – 0.12 – 0.18	100 – 160 – 220	100 – 160 – 220	–	–
	Mold steel	0.08 – 0.1 – 0.15	80 – 140 – 180	80 – 140 – 180	–	–
	Stainless steel (Austenitic related)	0.08 – 0.1 – 0.15	100 – 160 – 200	100 – 160 – 200	–	–
	Stainless steel (Martensitic related)	0.08 – 0.1 – 0.15	150 – 200 – 250	–	–	180 – 240 – 300
	Stainless steel (Precipitation hardening)	0.08 – 0.1 – 0.15	90 – 120 – 150	–	–	–
	Ni-base heat-resistant alloy	0.08 – 0.1 – 0.12	20 – 30 – 50	–	–	20 – 30 – 50
	Titanium alloy	0.08 – 0.12 – 0.15	40 – 60 – 80	–	–	–

The number in **bold font** is recommended starting conditions. Adjust the cutting speed and the feed rate within the above conditions according to the actual machining situation.
Cutting with coolant is recommended for ni-base heat resistant alloy and titanium alloy.
Cutting with coolant is recommended to get good finished surface.

★ : 1st recommendation ☆ : 2nd recommendation



Recommended chipbreaker range

GM type for General purpose: Edge shape optimized for various machining applications
SM type with low cutting force design: Sharp cutting and large rake angle

- Cutting edge angle 45°~70°
- Cutting edge angle 75°
- Cutting edge angle 88°/90°
- Cutter for Finishing
- High Feed Cutter
- Multi-Function
- Slot Mill
- Ball-nose Radius
- Others

Shouldering

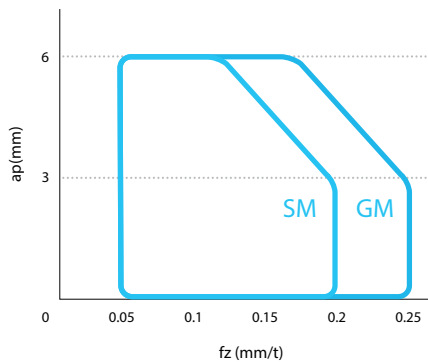

Slotting

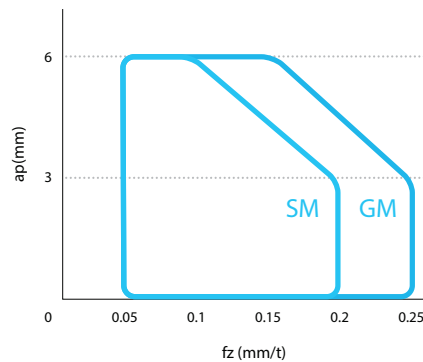

Cutting Conditions : Vc = 150 m/min, ae = DC/2 mm, Workpiece Material : C50

Cutting Conditions : Vc = 150 m/min, ae = DC mm, Workpiece Material : C50

Reference data for Ramping

Description	Cutter Dia. DC (mm)	20	22	25	28	30	32	40	50
MEV...-06-...	Max. Ramping Angle RMPX	1.00°	0.80°	0.65°	0.60°	0.55°	0.50°	0.40°	0.30°
	tan RMPX	0.017	0.014	0.011	0.010	0.010	0.009	0.007	0.005

Decrease ramping angle if chips become excessively long.

Guide for Ramping (Slant Milling)

Ramping angle should be RMPX (Maximum ramping angle) or under in the above cutting conditions.
Feed rate should be 70% or under of the above cutting conditions.

Formula of the cutting length "L" at Max. ramping angle

$$L = \frac{ap}{\tan RMPX}$$

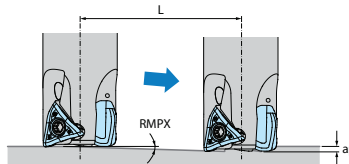

For two-way ramping, the ramping angle should be half of RMPX.

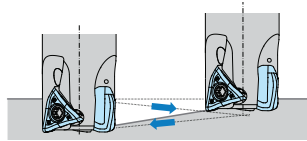

Guide for Helical milling

For helical milling, use between Min. cutting dia. and Max. cutting dia.

⊘ Exceeding Max. Cutting Dia.

Center core part remains after machining

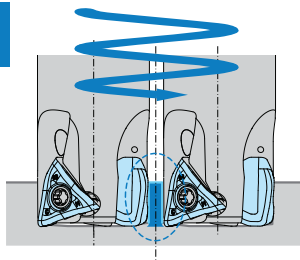

⊘ Under Min. Cutting Dia.

Center core part interferes with toolholder

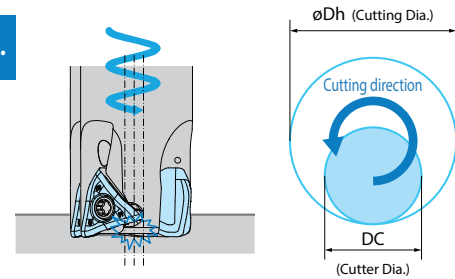

Unit : mm

Description	Min. Cutting Dia.	Max. Cutting Dia.
MEV...-06-...	2×DC-5	2×DC-2

For helical milling, use between Min. cutting dia. and Max. cutting dia. Keep machine depth (h) per rotation less than max. ap (S) in the cutter dimensions chart.
Use caution to eliminate incidences caused by producing long chips.

Guide for Drilling

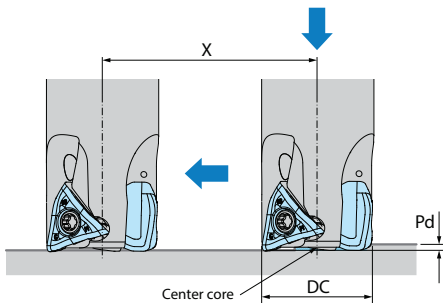

Unit : mm

Description	Max. cutting depth Pd	Min. cutting length X for flat bottom surface
MEV...-06-...	0.25	DC-3

It is recommended to reduce feed by 25% of recommendation until the center core is removed when traversing after drilling. Axial feed rate recommendation per revolution is $f < 0.1 \text{ mm/rev}$.

MEWH

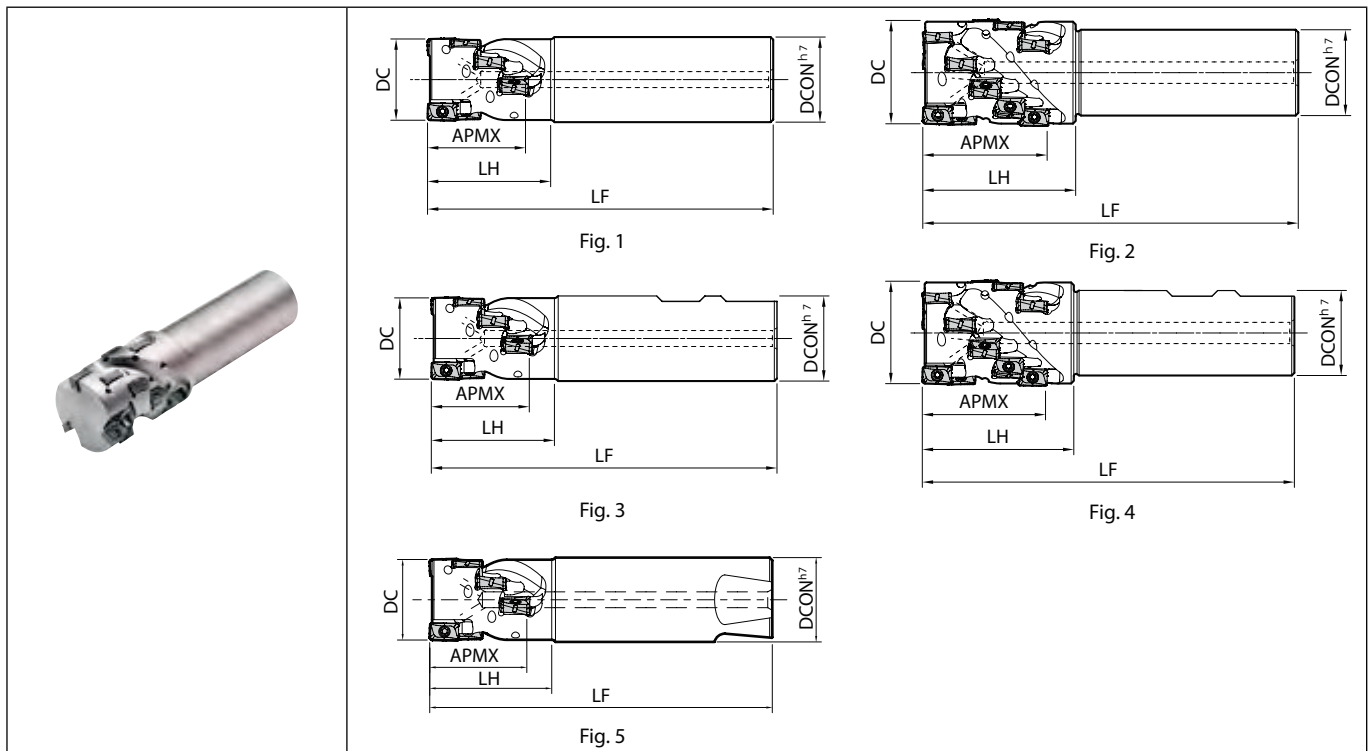

Toolholder dimensions

Description	Availability	Inserts	Flutes	Stages	Dimension (mm)					A.R. max. (°)	R.R. (°)	Coolant hole	Fig.	Spare parts			Applicable inserts M92 M59
					DC	DCON	LF	LH	APMX					Anti-seize compound	Screw	Wrench	
MEWH 025-S25-10-3-2T 032-S32-10-4-2T 040-S32-10-5-2T 040-S32-10-5-3T	●	6	2	3	25	25	120	37	28	+13	-20	Yes	1	P-37	SB-3065TRP	DTPM-8	LOMU1004...
	●	8			4	32	130	46	37								
	●	10	5	40	32	140	57	46									
	●	15							2								
MEWH 040-S32-15-4-2T 050-S42-15-4-2T 050-S42-15-4-3T	●	8	2	4	40	32	160	63	53	+13	-20	Yes	2	P-37	SB-4090TRP	DTPM-15	LOMU1505...
	●	12			50	42											
	●	12	3	2	2	Recommended tightening torque for insert clamp 3.5N·m											
MEWH 025-W25-10-3-2T 032-W32-10-4-2T 040-W32-10-5-2T 040-W32-10-5-3T	●	6	2	3	25	25	95	37	28	+13	-20	Yes	3	P-37	SB-3065TRP	DTPM-8	LOMU1004...
	●	8			4	32	108	46	37								
	●	10	5	40	32	119	57	46									
	●	15							4								
MEWH 040-W32-15-4-2T 050-W40-15-4-2T 050-W40-15-4-3T	●	8	2	4	40	32	125	63	53	+13	-20	Yes	4	P-37	SB-4090TRP	DTPM-15	LOMU1505...
	●	12			50	40	135										
	●	12	3	4	4	Recommended tightening torque for insert clamp 3.5N·m											
MEWH 025S25-10-3-2TXT 032S32-10-4-2TXT	□	6	2	3	25	25	118	37	28	+13	-20	Yes	5	P-37	SB-3065TRP	DTPM-8	LOMU1004...
	□	8			4	32	32	133	46								

Coat Anti-seize Compound thinly on portion of taper and thread when insert is fixed.
MEWH...XT Shank (X-Treme Shank) is for NIKKEN X-Treme chuck.

● : Standard item R : Right-hand only L : Left-hand only □ : Check availability

M90

M

Milling

Cutting edge angle 45°~70°

Cutting edge angle 75°

Cutting edge angle 88°/90°

Cutter for Finishing

High Feed Cutter

Multi-Function

Slot Mill

Ball-nose Radius

Others

MEWH

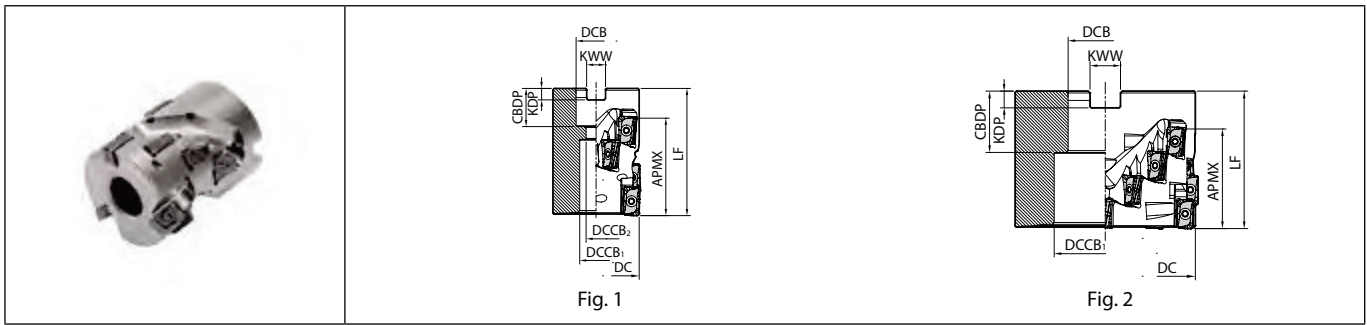

Toolholder dimensions

Description	Availability	Inserts	Flutes	Stages	Dimension (mm)										A.R. max. (°)	R.R. (°)	Coolant hole	Fig.	Spare parts				Applicable inserts ➔ M92 M59
					DC	DCB	DCCB ₁	DCCB ₂	LF	CBDP	KDP	KWW	APMX	Anti-seize compound					Mounting bolt	Screw	Wrench		
					R																		
MEWH 040R-10-4-3T-M	●	12	3	4	40	16	15	9	53	19	5.6	8.4	37	+13	-20	No	1	P-37	HH8X25	SB-3065TRP	DTPM-8	LOMU1004...	
MEWH 050R-10-5-3T-M	●	15		5	50	22	18	11	64	21	6.3	10.4	46						1	HH10X30	Recommended tightening torque for insert clamp 1.2N·m		
MEWH 050R-15-4-3T-M	●	12	3	4	50	22	18	11	70	21	6.3	10.4	53	+13	-20	No	1	P-37	HH10X30	SB-4090TRP	DTPM-15	LOMU1505...	
MEWH 063R-15-3-3T-M	●	9		3	63	27	20	13	58	24	7	12.4	41						1		HH12X35		Recommended tightening torque for insert clamp 3.5N·m
MEWH 080R-15-4-4T-M	●	16	4	4	80	32	26	18	70	28	8	14.4	53				2		HH16X45				
MEWH 100R-15-4-5T-M	●	20		5	100	40	55	-	74	33	9	16.4											

Coat Anti-seize Compound thinly on portion of taper and thread when insert is fixed.

Guidance of applicable inserts for MEWH

Insert location indication	Toolholder description											
	MEWH...10...						MEWH...15...					
	Corner-R(RE) (mm)						Corner-R(RE) (mm)					
Bottom inserts	0.4	0.8	1.2	1.6	2.0	0.4	0.8	1.0	1.2	1.6	2.0	
*Middle inserts	0.4 / 0.8	0.4 / 0.8	0.4 / 0.8	0.4	0.4	0.4~1.6	0.4~1.6	0.4~1.6	0.4~1.6	0.4~1.6	0.4~1.6	

* For middle inserts, it is not recommended to use the insert with larger corner-R(RE) than shown in the table, because it will make finished surface uneven.



LOMU

Classification of usage ★: Roughing / 1st Choice ☆: Roughing / 2nd Choice ■: Finishing / 1st Choice □: Finishing / 2nd Choice (In case hardness is 45HRC or under)		Carbon steel / Alloy steel			★	☆	P						
		Mold and die steel			★	☆							
		Austenitic stainless steel			☆	★	M						
		Martensitic stainless steel	★			☆							
		Precipitation hardening stainless steel				★	K						
		Gray cast iron			★								
		Nodular cast iron			★		N						
		Non-ferrous metals											
		Heat-resistant alloy	★			☆	S						
		Titanium alloy				★							
		Hard materials		★			H						
Insert	Description	Dimension (mm)						Carbide				Applicable toolholder M90 M91 M54~M57	
		S	D1	RE	L	W1	BS	CVD	PVD				
								CA6535	PRO155	PR1510	PR1525	PR1535	
	General purpose	LOMU 100404ER-GM		0.4			2.1	●	●	●	●	●	MEWH...-10-... MEW...-10-...
		LOMU 100408ER-GM	4	3.4	0.8			1.7	●	●	●	●	
LOMU 100412ER-GM				1.2	10.9	6.6	1.3	●	●	●	●		
LOMU 100416ER-GM				1.6			1	●	●	●	●		
LOMU 100420ER-GM				2			1	●	●	●	●		
	Low cutting force	LOMU 150504ER-GM		0.4			2.2	●	●	●	●	MEWH...-15-... MEW...-15-...	
		LOMU 150508ER-GM			0.8			1.8	●	●	●		●
LOMU 150510ER-GM	5.6	4.8	1	15.7	9.2	1.6	●	●	●	●			
LOMU 150512ER-GM			1.2			1.4	●	●	●	●			
LOMU 150516ER-GM			1.6			1	●	●	●	●			
LOMU 150520ER-GM			2			0.6	●	●	●	●			
	Tough edge	LOMU 100408ER-SM	4	3.4	0.8	10.9	6.6	1.7	●	●	●	MEWH...-10-... MEW...-10-...	
		LOMU 150508ER-SM	5.6	4.8	0.8	15.7	9.2	1.8	●	●	●	MEWH...-15-... MEW...-15-...	
	Tough edge	LOMU 100408ER-GH	4	3.4	0.8	10.9	6.6	1.7	●	●	●	MEWH...-10-... MEW...-10-...	
		LOMU 150508ER-GH	5.6	4.8	0.8	15.7	9.2	1.8	●	●	●	MEWH...-15-... MEW...-15-...	

Handed insert shows Right-hand

Recommended cutting conditions M93

Cutting performance

LOMU1004 type

Cutting dia.	Description	2 flute		3 flute	
		ap x ae	Description	ap x ae	Description
ø25	MEWH025 -S25-10-3-2T		-	-	-
ø32	MEWH032 -S32-10-4-2T		-	-	-
ø40	MEWH040 -S32-10-5-2T		MEWH040 -S32-10-5-3T		

LOMU1505 type

Cutting dia.	Description	2 flute		3 flute	
		ap x ae	Description	ap x ae	Description
ø40	MEWH040 -S32-15-4-2T		-	-	-
ø50	MEWH050 -S42-15-4-2T		MEWH050 -S42-15-4-3T		

Cutting conditions>
 • Vc = 120 m/min
 • fz = 0.08~0.12 mm/t
 • GM chipbreaker
 • Workpiece material: 34CrMo4
 • Overhang length
 End mill: Overhang length is "LH" of the dimension list

●: Standard item R: Right-hand only L: Left-hand only □: Check availability

M92

Recommended cutting conditions

Chipbreaker	Workpiece material	fz (mm/t)	Recommended insert grades (Vc: m/min)			
		Toolholder description	MEGACOAT NANO			CVD coated carbide
		MEWHO25~MEWHO50 (Helical end mill)	PR1535	PR1525	PR1510	CA6535
GM	Carbon steel	0.06~ 0.1 ~0.2	120~ [☆] 180 ~250	120~ [★] 180 ~250	-	-
	Alloy steel	0.06~ 0.1 ~0.14	100~ [☆] 160 ~220	100~ [★] 160 ~220	-	-
	Mold steel	0.06~ 0.08 ~0.12	80~ [☆] 140 ~180	80~ [★] 140 ~180	-	-
	Stainless steel (Austenitic related)	0.06~ 0.08 ~0.12	100~ [☆] 160 ~200	100~ [☆] 160 ~200	-	-
	Stainless steel (Martensitic related)	0.06~ 0.08 ~0.1	150~ [☆] 200 ~250	-	-	180~ [★] 240 ~300
	Stainless steel (Precipitation hardening)	0.06~ 0.08 ~0.1	90~ [★] 120 ~150	-	-	-
	Gray cast iron	0.06~ 0.1 ~0.17	-	-	120~ [★] 180 ~250	-
	Nodular cast iron	0.06~ 0.08 ~0.12	-	-	100~ [★] 150 ~200	-
	Ni-base heat-resistant alloys	0.06~ 0.08 ~0.1	20~ [☆] 30 ~50	-	-	20~ [★] 30 ~50
	Titanium alloys	0.06~ 0.08 ~0.12	40~ [☆] 60 ~80	-	30~ [☆] 50 ~70	-
SM	Carbon steel	0.06~ 0.1 ~0.17	120~ [☆] 180 ~250	120~ [★] 180 ~250	-	-
	Alloy steel	0.06~ 0.08 ~0.12	100~ [☆] 160 ~220	100~ [★] 160 ~220	-	-
	Mold steel	0.06~ 0.08 ~0.12	80~ [☆] 140 ~180	80~ [★] 140 ~180	-	-
	Stainless steel (Austenitic related)	0.06~ 0.08 ~0.12	100~ [★] 160 ~200	100~ [☆] 160 ~200	-	-
	Stainless steel (Martensitic related)	0.06~ 0.08 ~0.1	150~ [☆] 200 ~250	-	-	180~ [★] 240 ~300
	Stainless steel (Precipitation hardening)	0.06~ 0.08 ~0.1	90~ [☆] 120 ~150	-	-	-
	Ni-base heat-resistant alloys	0.06~ 0.08 ~0.1	20~ [☆] 30 ~50	-	-	20~ [★] 30 ~50
	Titanium alloys	0.06~ 0.08 ~0.12	40~ [★] 60 ~80	-	30~ [☆] 50 ~70	-
GH	Carbon steel	0.06~ 0.1 ~0.2	120~ [☆] 180 ~250	120~ [★] 180 ~250	-	-
	Alloy steel	0.06~ 0.1 ~0.14	100~ [☆] 160 ~220	100~ [★] 160 ~220	-	-
	Mold steel	0.06~ 0.08 ~0.12	80~ [☆] 140 ~180	80~ [★] 140 ~180	-	-
	Stainless steel (Austenitic related)	0.06~ 0.08 ~0.12	100~ [☆] 160 ~200	100~ [☆] 160 ~200	-	-
	Stainless steel (Martensitic related)	0.06~ 0.08 ~0.1	150~ [☆] 200 ~250	-	-	180~ [☆] 240 ~300
	Stainless steel (Precipitation hardening)	0.06~ 0.08 ~0.1	90~ [☆] 120 ~150	-	-	-
	Gray cast iron	0.06~ 0.1 ~0.2	-	-	120~ [☆] 180 ~250	-
	Nodular cast iron	0.06~ 0.08 ~0.15	-	-	100~ [☆] 150 ~200	-
	Ni-base heat-resistant alloys	0.06~ 0.08 ~0.1	20~ [☆] 30 ~50	-	-	20~ [☆] 30 ~50
	Titanium alloys	0.06~ 0.08 ~0.12	40~ [☆] 60 ~80	-	30~ [☆] 50 ~70	-

* The bold-faced number indicates a center value of recommended cutting condition. Adjust the cutting speed and the feed rate within the above conditions according to the actual machining situation.

* Machining with coolant is recommended for Stainless steel, Ni-base heat-resistant alloys and titanium alloys with MEWH.

★ : 1st Recommendation

☆ : 2nd Recommendation



Milling

MECH End Mill (with coolant hole for bottom insert)

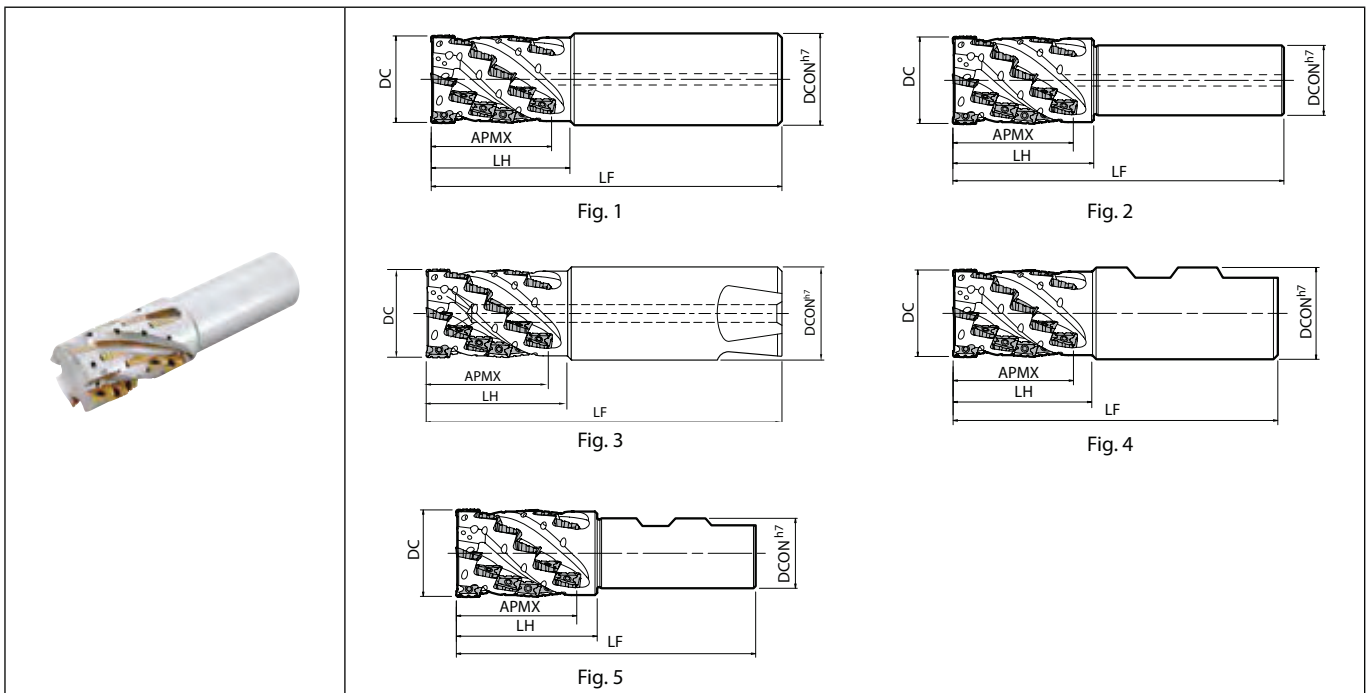

Toolholder dimensions

M	Description	Availability	Inserts	Flutes	Stages	Dimension (mm)					A.R. max. (°)	R.R. (°)	Coolant hole	Fig.	Spare parts			Applicable inserts M99
						DC	DCON	LF	LH	APMX					Anti-seize compound	Screw	Wrench	
MECH	025-S25-11-4-2T	●	8	2	4	25	25	120	46	37	+21	-10	Yes	1	P-37	SB-2555TRG	DTM-8	BDMT11T3...-N2 + BDMT11T3...-N3
	032-S32-11-5-2T	●	10			5	32	32	140	55	46	+23						
	032-S32-11-5-4T	●	20	6	40				42	150	64							
	040-S32-11-6-4T	●	24			7	50	42		160	75	64						
	040-S42-11-6-4T	●	24	6	40				42	172	75	64						
	050-S42-11-7-4T	●	28			7	50	42		172	75	64						
050-S42-11-7-6T	●	42	6	7	50				42	172	75	64						
MECH	040-S32-17-4-2T	●				8	2	4		40	32	160	73	59	+19	-7	Yes	2
	040-S42-17-4-2T	●	8	5	50	42			170		88	74	+19	-6				
	050-S42-17-5-4T	●	20				4	5	50	185	88	74						
MECH	025-W25-11-4-2T	●	8	2	4	25				25	104	46	37	+21	-10	Yes	4	P-37
	032-W32-11-5-2T	●	10				5	32	32									
	032-W32-11-5-4T	●	20	6	40	40				126	64	55						
	040-W32-11-6-4T	●	24				7	50	50	147	75	64						
	050-W40-11-7-4T	●	28	4	7	50				147	75	64						
MECH	040-W32-17-4-2T	●	8				2	4	40	32	136	73	59	+19	-7	Yes	5	P-37
	050-W40-17-5-4T	●	20	5	40	161				88	74	+19	-7					
MECH	025S25-11-4-2TXT	□	8				2	4	25	25	127			46	37	+21	-10	Yes
	032S32-11-5-2TXT	□	10	5	32	32						142	55					
	032S32-11-5-4TXT	□	20				4	4	4	142	55	46						

For installation of notched insert, see page M100.

MECH...XT Shank (X-Treme Shank) is for NIKKEN X-Treme chuck.

Coat Anti-seize Compound thinly on portion of taper and thread when insert is fixed.

● : Standard item R : Right-hand only L : Left-hand only □ : Check availability

MECH Shell Mill (without coolant hole)

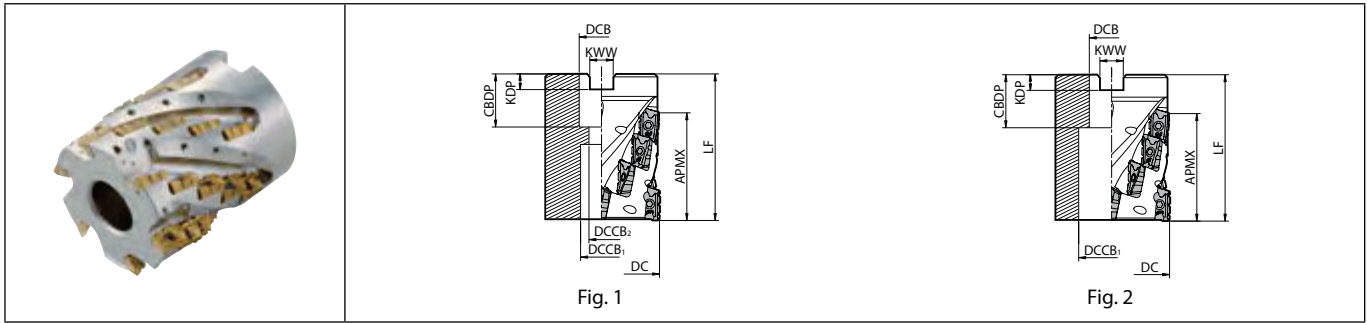

Toolholder dimensions

Description	Availability	Inserts	Flutes	Stages	Dimension (mm)										A.R. max. (°)	R.R. (°)	Coolant hole	Fig.	Spare parts				Applicable inserts M99
					DC	DCB	DCCB ₁	DCCB ₂	LF	CBDP	KDP	KWW	APMX	Anti-seize compound					Mounting bolt	Screw	Wrench		
MECH 040R-11-4-4T-M	●	16	4	4	40	16	15	9	50	19	5.6	8.4	37	+23	-8	No	1	P-37	HH8X25	SB-2555TRG	DTM-8	BDMT11T3...-N2 + BDMT11T3...-N3	
MECH 050R-11-5-6T-M	●	30	6	5	50	22	18	11	63	21	6.3	10.4	46				1		HH10X30				
MECH 050R-17-2-4T-M	●	8		2	50	22	18	11	52	21	6.3	10.4	30				1		HH10X30				
MECH 050R-17-4-4T-M	●	16	4	4					78				59				1		HH10X40				
MECH 063R-17-3-4T-M	●	12		3	63	27	20	14	70	24	7	12.4	45	+19	-7	No	1	P-37	HH12X35	SB-4070TRN	DTM-15	BDMT1704...-N3 + BDMT1704...-N4	
MECH 080R-17-4-6T-M	●				80	32	26	18		28	8	14.4					1		HH16X45				
MECH 100R-17-4-6T-M	●	24	6	4	100	40	56	-	85	30	9	16.4	59				2		-				
MECH 063R-17-3-4T	□	12	4	3	63	25.4	20	14	70	26	6	9.5	45	+19	-7	No	1	P-37	HH12X35	SB-4070TRN	DTM-15	BDMT1704...-N3 + BDMT1704...-N4	
MECH 080R-17-4-6T	□				80	31.75	26	18		32	8	12.7					1		HH16X45				
MECH 100R-17-4-6T	□	24	6	4	100	38.1	56	-	85	38	10	15.9	59				2		-				

For installation of notched insert, see page M100.

Coat Anti-seize Compound thinly on portion of taper and thread when insert is fixed.

X-Treme Chuck [NIKKEN]

Description	See Page	Shank Dia. (DCON)	X-Treme Chuck			
			BT		HSK	
			BT40	BT50	HSK63A	HSK100A
MEWH 025S25-10-3-2TXT	M90	25.0	-	NBT50-C25EX-116	-	HSK100A-C25EX-116
032S32-10-4-2TXT		32.0	-	NBT50-C32EX-121	-	HSK100A-C32EX-121
MECH 025S25-11-4-2TXT	M94	25.0	-	NBT50-C25EX-116	-	HSK100A-C25EX-116
032S32-11-5-○TXT		32.0	-	NBT50-C32EX-121	-	HSK100A-C32EX-121

● : Standard item R : Right-hand only L : Left-hand only □ : Check availability



Milling

MECH-BT50 (Integral Arbor type, without coolant hole)

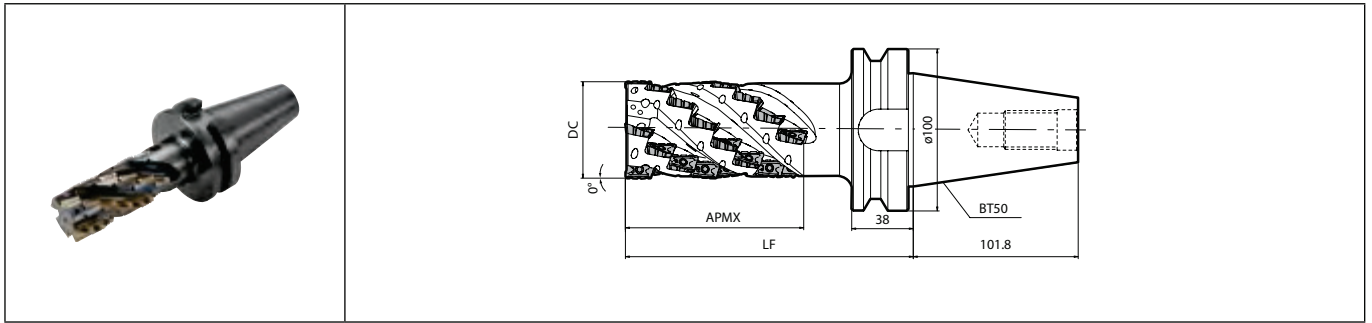

Toolholder dimensions

Description	Availability	Inserts	Flutes	Stages	Dimension (mm)				A.R. max. (°)	R.R. (°)	Coolant hole	Weight (kg)	Spare parts			Applicable inserts M99
					DC	LF	APMX						Anti-seize compound	Screw	Wrench	
MECH 050R11-8-4T-BT50	●	32	4	8	50	143	73	+23	-7	No	4.8	P-37	SB-2555TRG	DTM-8	BDMT11T3...-N2 + BDMT11T3...-N3	
MECH 050R17-7-4T-BT50	●	28	4	7	50	173	104	+19	-7	No	4.9	P-37	SB-4070TRN	DTM-15	BDMT1704...-N3 + BDMT1704...-N4	
063R17-7-4T-BT50	●				63						5.9					
080R17-7-4T-BT50	●				80						7.8					
100R17-7-6T-BT50	●				100						10.2					

For installation of notched insert, see page M100.

Coat Anti-seize Compound thinly on portion of taper and thread when insert is fixed.



MECH-BT50SA (without coolant hole) Arbor Integral Type (Base unit + 1 Front piece + Clamp bolt)

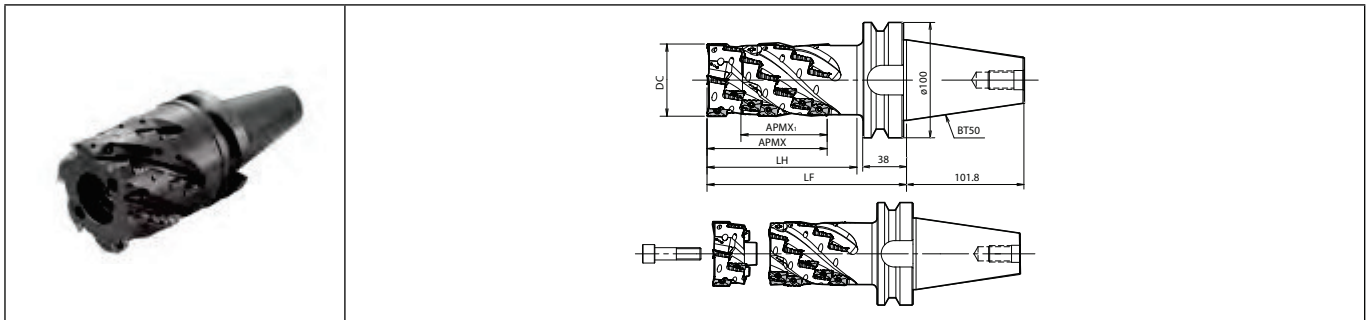

Milling

Cutting edge angle 45°~70°

Cutting edge angle 75°

Cutting edge angle 88°/90°

Cutter for Finishing

High Feed Cutter

Multi-Function

Slot Mill

Ball-nose Radius

Others

Toolholder dimensions

Description	Availability	Inserts	Flutes	Stages	Dimension (mm)					A.R. max. (°)	R.R. (°)	Coolant hole	Weight (kg)	Spare parts					Applicable inserts M99
					DC	LF	LH	APMX	APMXT					Anti-seize compound	Mounting bolt	Wrench (for Mounting bolt)	Screw	Wrench	
MECH 050R11-4T-BT50SA	MT0	32	4	8	50	143	99	73	55	+23	-7	No	4.8	P-37	HH12X35	LW-10	SB-2555TRG	DTM-8	BDMT11T3...-N2 + BDMT11T3...-N3
MECH 063R17-4T-BT50SA	MT0	28	4	7	63	173	130	104	75	+19	-7	No	5.8	P-37	HH16X40	LW-14	SB-4070TRN	DTM-15	BDMT1704...-N3 + BDMT1704...-N4
080R17-4T-BT50SA	MT0				80								7.6						
100R17-6T-BT50SA	MT0				100								9.8						

For installation of notched insert, see page M100.

Coat Anti-seize Compound thinly on portion of taper and thread when insert is fixed.

● : Standard item R : Right-hand only L : Left-hand only □ : Check availability MT0 : Made to order

M96

MECH-BT50-A (without coolant hole) Base unit

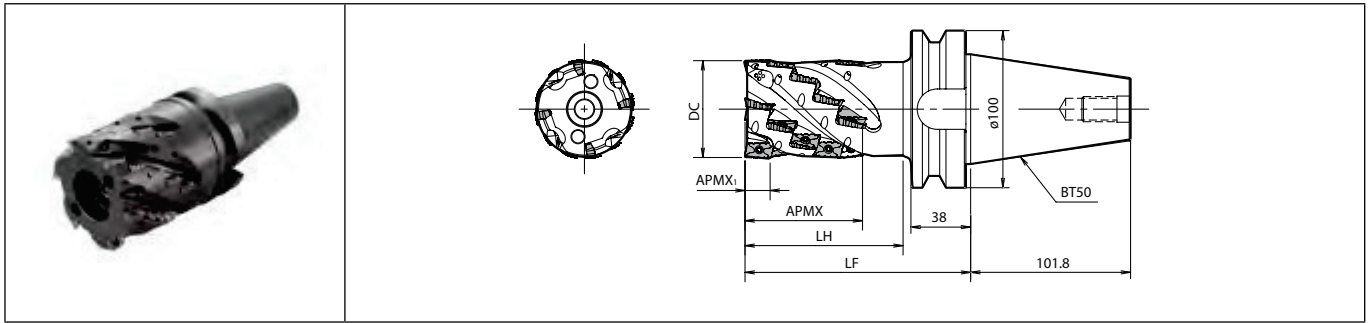

Toolholder dimensions

Description	Availability	Inserts	Flutes	Stages	Dimension (mm)					A.R. max. (°)	R.R. (°)	Coolant hole	Weight (kg)	Spare parts					Applicable inserts ➔ M99
					DC	LF	LH	APMX	APMX1					Anti-seize compound	Mounting bolt	Wrench (for Mounting bolt)	Screw	Wrench	
MECH 050R11-4T-BT50-A	MTO	24	4	6	50	125	81	55	10	+23	-7	No	4.6	P-37	HH12X35	LW-10	SB-255STRG	DTM-8	BDMT11T3...-N2 + BDMT11T3...-N3
MECH 063R17-4T-BT50-A 080R17-4T-BT50-A 100R17-6T-BT50-A	MTO	20	4	5	63	143	100	75	16	+19	-7	No	5.4	P-37	HH12X40	LW-10	SB-4070TRN	DTM-15	BDMT1704...-N3 + BDMT1704...-N4
	MTO				80										HH16X40	LW-14			
	MTO	30	6	100	HH20X40										LW-17				

For installation of notched insert, see page M100.

Coat Anti-seize Compound thinly on portion of taper and thread when insert is fixed.

MECH-F (without coolant hole) Front piece

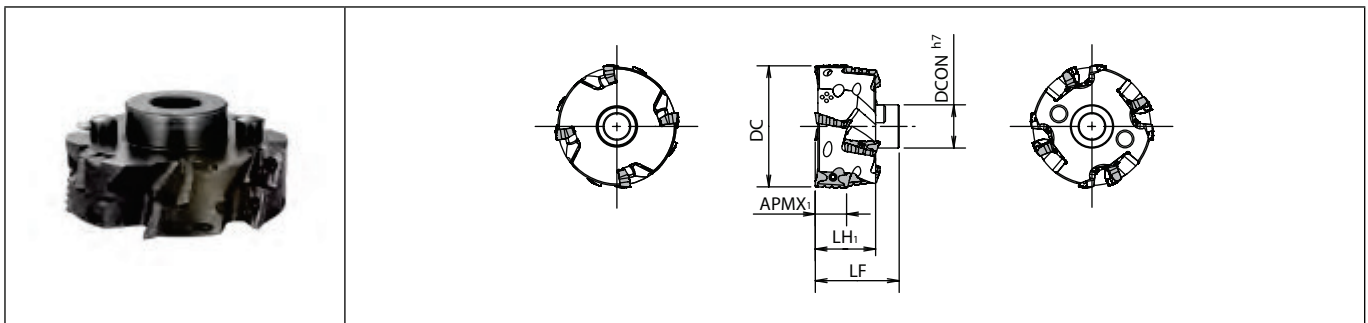

Toolholder dimensions

Description	Availability	Inserts	Flutes	Stages	Dimension (mm)					A.R. max. (°)	R.R. (°)	Coolant hole	Weight (kg)	Spare parts		Applicable inserts ➔ M99
					DC	LF	LH	APMX1	DCON					Anti-seize compound	Screw	
MECH 050R11-4T-F	●	8	4	2	50	32	18	10	22	+23	-7	No	0.2	P-37	SB-255STRG	BDMT11T3...-N2 + BDMT11T3...-N3
MECH 063R17-4T-F 080R17-4T-F 100R17-6T-F	●	8	4	2	63	44	30	16	22	+19	-7	No	0.4	P-37	SB-4070TRN	BDMT1704...-N3 + BDMT1704...-N4
	●				80				32							
	●	12	6	100	45				1.3							

For installation of notched insert, see page M100.

Coat Anti-seize Compound thinly on portion of taper and thread when insert is fixed.



● : Standard item R : Right-hand only L : Left-hand only □ : Check availability MTO : Made to order

M







Milling

Toolholder structure

End Mill			Base Unit  M97		Front Piece (1pc)  M97		Clamp Bolt
MECH	050R11-4T-BT50SA	=	MECH050R11-4T-BT50-A	+	MECH050R11-4T-F	+	HH12X35
	063R17-4T-BT50SA		MECH063R17-4T-BT50-A		MECH063R17-4T-F		HH12X40
	080R17-4T-BT50SA		MECH080R17-4T-BT50-A		MECH080R17-4T-F		HH16X40
	100R17-6T-BT50SA		MECH100R17-6T-BT50-A		MECH100R17-6T-F		HH20X40

Applicable Inserts

End Mill		Base Unit  M97	Front Piece  M97	Applicable Inserts  M99
MECH	050R11-4T-BT50SA	MECH050R11-4T-BT50-A	MECH050R11-4T-F	BDMT11T308ER-N2 + BDMT11T308ER-N3
	063R17-4T-BT50SA	MECH063R17-4T-BT50-A	MECH063R17-4T-F	BDMT170408ER-N3 + BDMT170408ER-N4
	080R17-4T-BT50SA	MECH080R17-4T-BT50-A	MECH080R17-4T-F	
	100R17-6T-BT50SA	MECH100R17-6T-BT50-A	MECH100R17-6T-F	

· For installation of notched insert, see page  M100

M



Milling

Cutting edge angle
45°~70°

Cutting edge angle
75°

Cutting edge angle
88°/90°

Cutter for
Finishing

High Feed
Cutter

Multi-
Function

Slot Mill

Ball-nose
Radius

Others

BDMT

Insert		Description	No. of edges	Dimension (mm)					Angle (°)		Carbide				Applicable toolholder M94~M97	
				S	D1	RE	L	W1	AN	AS	PVD					
												PR1210	PR1225	PR1230		PR1535
Classification of usage ★: Roughing / 1st Choice ☆: Roughing / 2nd Choice ■: Finishing / 1st Choice □: Finishing / 2nd Choice (In case hardness is 45HRC or under)		Carbon steel / Alloy steel		★	★	☆									P	
		Mold and die steel		★	★	☆										
		Austenitic stainless steel		☆	☆	★									M	
		Martensitic stainless steel				☆										
		Precipitation hardening stainless steel				★										
		Gray cast iron		★												K
		Nodular cast iron		★												
		Non-ferrous metals														N
		Heat-resistant alloy								★	★	☆				
		Titanium alloy		★										★		S
Hard materials											□					
		BDMT 11T308ER-N2	2	3.8	2.8	0.8	11	6.7	13	18	●	●	●	●	MECH...11...	
		BDMT 11T308ER-N3	2	3.8	2.8	0.8	11	6.7	13	18	●	●	●	●	MECH...11...	
		BDMT 170408ER-N3	2	4.9	4.4	0.8	17	9.6	13	18	●	●	●	●	MECH...17...	
		BDMT 170408ER-N4	2	4.9	4.4	0.8	17	9.6	13	18	●	●	●	●	MECH...17...	

Handed insert shows Right-hand

Recommended cutting conditions M101



Milling

Applicable Inserts

Description	Applicable Inserts			
		+		
MECH...-11-	BDMT 11T308ER-N2	+	BDMT 11T308ER-N3	-
MECH...-17-		-		BDMT 170408ER-N3 + BDMT 170408ER-N4

●: Standard item R: Right-hand only L: Left-hand only □: Check availability

Smooth chip evacuation

Smooth chip evacuation

Notched insert breaks chips into small pieces

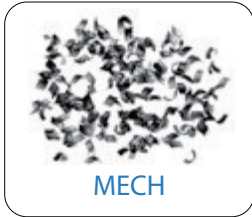

MECH



Competitor A

Workpiece material: SS400
Vc=120m/min
apxae=40mmx10mm
fz=0.12mm/t
MECH032-S32-11-5-4T

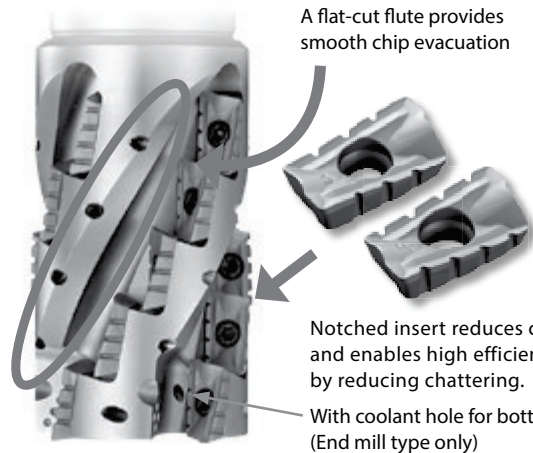

Low cutting force

Low cutting force due to notched inserts

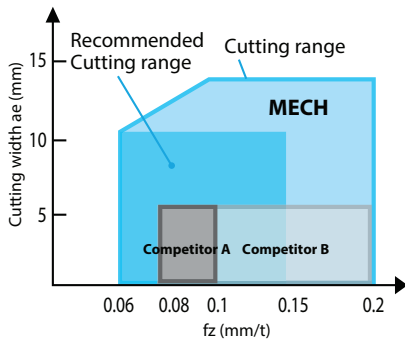

Workpiece material: C50
Vc=120m/min
apxae=40 mmx5~13mm
fz=0.06 ~ 0.2mm/t
MECH032-S32-11-5-4T

Cutting force comparison (Principal force)

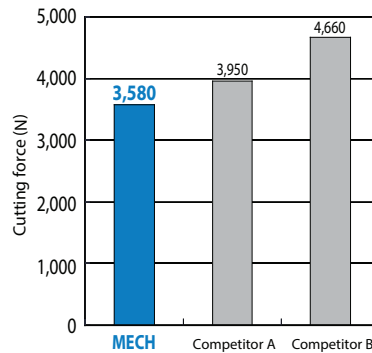

Workpiece material: C50
Vc = 120 m/min
ap x ae = 40 mm x 10 mm
fz = 0.1 mm/t
MECH032-S32-11-5-4T

(Internal evaluation)

Number of inserts installed

Description	No. of flutes	No. of inserts	No. of inserts			
			BDMT11T308ER-		BDMT170408ER-	
MECH 025-S25-11-4-2T 032-S32-11-5-2T 032-S32-11-5-4T 040-S32-11-6-4T 040-S42-11-6-4T	2	8	4	4		
		10	5	5		
	4	20	10	10		
		24	12	12	-	-
		28	14	14		
050-S42-11-7-4T 050-S42-11-7-6T	6	42	21	21		
MECH 040-S32-17-4-2T 040-S42-17-4-2T 050-S42-17-5-4T	2	8			4	4
		20			10	10
	4	20			10	10
MECH 040R-11-4-4T-M 050R-11-5-6T-M	4	16	8	8		
	6	30	15	15		
MECH 050R-17-2-4T-M 050R-17-4-4T-M 063R-17-3-4T-M 080R-17-4-6T-M 100R-17-4-6T-M	4	8			4	4
		16			8	8
	6	12			6	6
		24			12	12
		24			12	12
MECH 063R-17-3-4T 080R-17-4-6T 100R-17-4-6T	4	12			6	6
		24			12	12
	6	24			12	12

Description	No. of flutes	No. of inserts	No. of inserts			
			BDMT11T308ER-		BDMT170408ER-	
MECH 050R11-8-4T-BT50 050R17-7-4T-BT50 063R17-7-4T-BT50 080R17-7-4T-BT50 100R17-7-6T-BT50	32	16	16	-	-	
		28			14	14
	4	28			14	14
		42			21	21
		42	16	16	-	-
MECH 050R11-4T-BT50SA 063R17-4T-BT50SA 080R17-4T-BT50SA	4	32	16	16	-	-
		28			14	14
	6	42			21	21
MECH 100R17-6T-BT50SA	4	24	12	12	-	-
	4	20			10	10
	6	30			15	15
MECH 050R11-4T-BT50-A 063R17-4T-BT50-A 080R17-4T-BT50-A	4	24	12	12	-	-
		20			10	10
	6	30			15	15
MECH 050R11-4T-F 063R17-4T-F 080R17-4T-F 100R17-6T-F	4	8	4	4	-	-
		8			4	4
	6	12			6	6
		12			6	6

Caution when installing notched insert

1. Install notched inserts by cutting the insert with the number of marks on the toolholder body.

<Insert number and toolholder marks>

Insert size	11 type		17 type	
	2	3	3	4
Marks				

* Using the cutter with the inserts installed incorrectly will damage the toolholder.

2. When installing notched inserts in flute line, ensure that the number on the insert is the same as the insert in first stage. (Ref. to Fig. 1, 2 and 3)

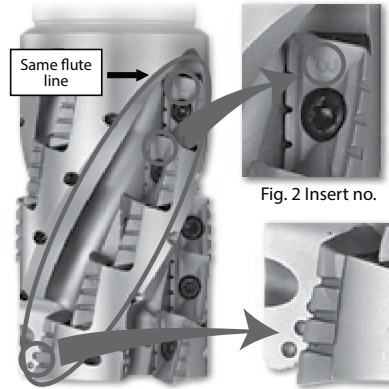

Fig. 1 Same flute line

Fig. 3 Marks

Recommended cutting conditions (When using a notched insert)

Workpiece material	fz (mm/t)	Recommended insert grades (Vc: m/min)			
		MEGACOAT NANO	MEGACOAT		
		PR1535	PR1225	PR1230	PR1210
Carbon steel	0.08~0.1~0.15	☆ 120~180~250	☆ 120~180~250	★ 120~180~220	-
Alloy steel	0.08~0.1~0.15	☆ 100~160~220	☆ 100~160~220	★ 100~160~200	-
Mold steel	0.08~0.1~0.15	☆ 80~140~180	☆ 80~140~180	★ 80~140~160	-
Gray cast iron	0.08~0.15~0.18	-	-	-	★ 120~180~250
Nodular cast iron	0.08~0.15~0.18	-	-	-	★ 100~150~220
*Titanium alloys	0.08~0.1~0.15	★ 40~60~80	-	-	☆ 30~50~70

* Machining with coolant is recommended for titanium alloys.

★: 1st Recommendation ☆: 2nd Recommendation

- The recommended cutting conditions above are for notched inserts.
- If using an insert without notch, the cutting depth (ap) and width (ae) should be 60% or less of those of a notched insert.

When using inserts with corner-R(RE) 1.6 or larger, additional modifications of the cutter body will be necessary. Ref. to the chart below for the recommended modifications. (Additional grind off is not necessary when corner-R(RE) is 1.2mm or less.)

Insert Corner-R(RE) (mm)	Additional processing dimension to body corner (mm)
1.6	R1.0
2.0	
2.4	R1.2
3.1	R1.6
4.0	R2.5

* Round- shaped additional processing is recommended. When applying chamfer shaped additional processing, do not cut away too much.

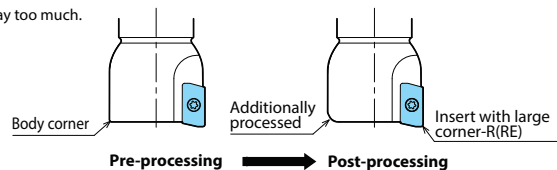

Milling

Cutting performance (Used machine: Machining center equivalent to AC15/18.5kW)

MECH end mill

Cutting dia.	Description	Overhang length LPR (mm)
ø25	MECH025-S25-11-4-2T	48
ø32	MECH032-S32-11-5-2T	57
	MECH032-S32-11-5-4T	
ø40	MECH040-S32-11-6-4T	65
	MECH040-S42-11-6-4T	
ø50	MECH050-S42-11-7-4T	76
	MECH050-S42-11-7-6T	
ø40	MECH040-S32-17-4-2T	74
	MECH040-S42-17-4-2T	
ø50	MECH050-S42-17-5-4T	89

Shape

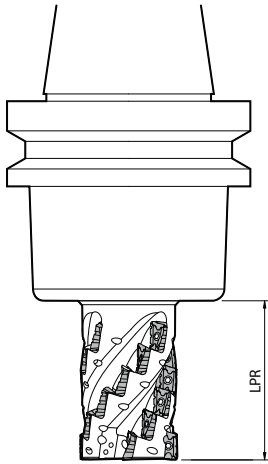

2 flute type

(Workpiece material: C50)

Description	Shouldering	Slotting
	 Cutting speed: $V_c = 100 \sim 180$ m/min Feed: $f_z = 0.08 \sim 0.15$ mm/t	 Cutting speed: $V_c = 100 \sim 120$ m/min Feed: $f_z = 0.08 \sim 0.12$ mm/t
MECH025-S25-11-4-2T		
MECH032-S32-11-5-2T		
MECH040-S32-17-4-2T MECH040-S42-17-4-2T		

4 flute/6 flute type

MECH032-S32-11-5-4T	
MECH040-S32-11-6-4T MECH040-S42-11-6-4T	
MECH050-S42-11-7-4T	
MECH050-S42-11-7-6T	
MECH050-S42-17-5-4T	

4 flute/6 flute type are not recommended for slotting.



- Cutting edge angle 45°~70°
- Cutting edge angle 75°
- Cutting edge angle 88°/90°
- Cutter for Finishing
- High Feed Cutter
- Multi-Function
- Slot Mill
- Ball-nose Radius
- Others

MECH shell mill

(Workpiece material: C50)

Cutting dia.	Description	Overhang length LPR (mm)
ø40	MECH040R-11-4-4T-M	125
ø50	MECH050R-11-5-6T-M	123
	MECH050R-17-2-4T-M	112
	MECH050R-17-4-4T-M	138
ø63	MECH063R-17-3-4T-□	115
ø80	MECH080R-17-4-6T-□	130
ø100	MECH100R-17-4-6T-□	130

Shape

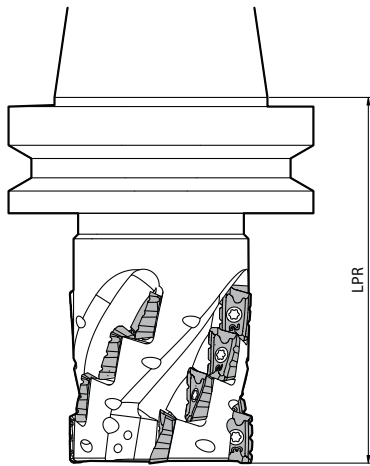

Shouldering			
Cutting speed: Vc = 100~180 m/min Feed: fz = 0.08~0.15 mm/t			
MECH040R-11-4-4T-M		MECH063R-17-3-4T-□	
MECH050R-11-5-6T-M		MECH080R-17-4-6T-□	
MECH050R-17-2-4T-M		MECH100R-17-4-6T-□	
MECH050R-17-4-4T-M		Slotting is not recommended.	

MECH-BT50 (Integral arbor type)

MECH-BT50SA (Head exchangeable type/Integral arbor type)

(Workpiece material: C50)

Cutting dia.	Description	Overhang length LPR (mm)
ø50	MECH050R11-8-4T-BT50 MECH050R11-4T-BT50SA	173
	MECH050R17-7-4T-BT50	
ø63	MECH063R17-7-4T-BT50 MECH063R17-4T-BT50SA	
ø80	MECH080R17-7-4T-BT50 MECH080R17-4T-BT50SA	
ø100	MECH100R17-7-6T-BT50 MECH100R17-6T-BT50SA	

Shape

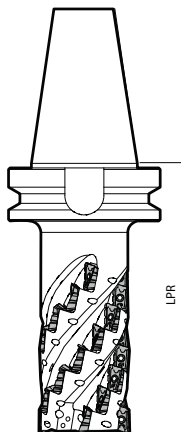

Shouldering			
Cutting speed: Vc = 100~180 m/min Feed: fz = 0.08~0.15 mm/t			
MECH050R11-8-4T-BT50 MECH050R11-4T-BT50SA		MECH080R17-7-4T-BT50 MECH080R17-4T-BT50SA	
MECH050R17-7-4T-BT50		MECH100R17-7-6T-BT50 MECH100R17-6T-BT50SA	
MECH063R17-7-4T-BT50 MECH063R17-4T-BT50SA		Slotting is not recommended.	



Milling

Helical end mill for titanium alloy machining

MECHT

Insert size combination improves roughing capabilities
Maintains stable machining and long tool life

1 Developed to reduce chattering and chip recutting issues

Unique insert combination

The larger bottom inserts are positioned to handle larger cutting forces (excluding $\phi 32$)

Stable machining with improved fracture resistance

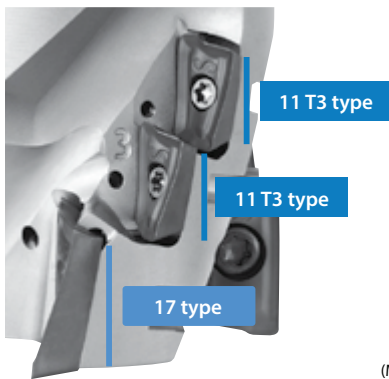

New design for higher reliability

Bottom inserts are held in place by double-faced contacts

Holding surface 1
Wide holding surface



Holding surface 2

Additional hold in the axial direction

Bore dia.

Larger bore diameter improves fastening power and reduces chattering
 $\phi 50$ mm cutter with a $\phi 27$ mm bore (conventional bore: $\phi 22$ mm)

Toolholder hardness Hardened 15% more than conventional holders

Toolholder spec Custom ordering available
Custom number of inserts and stages

- M
- Milling
- Cutting edge angle 45°~70°
- Cutting edge angle 75°
- Cutting edge angle 88°/90°
- Cutter for Finishing
- High Feed Cutter
- Multi-Function
- Slot Mill
- Ball-nose Radius
- Others

Excellent chip evacuation

New flute design

Large, smooth flutes prevent chip clogging

MECHT ($\phi 50$ -4T 3 stages)

Conventional ($\phi 50$ -4T 4 stages)

Large flute

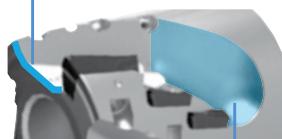

Smooth design

All inserts have coolant holes

Optimized hole diameter controls flow amount and pressure

Smooth chip evacuation as well as superior cooling of the cutting edge



Chips example

2 Longer tool life with low-resistance JS chipbreaker and tough PVD coating

Low cutting force

JS chipbreaker

Heat at the cutting edge is suppressed due to sharp cutting performance. Long tool life

Greater toughness

PR1535

Fracture resistant with a tough substrate and high heat-resistant MEGACOAT NANO coating technology

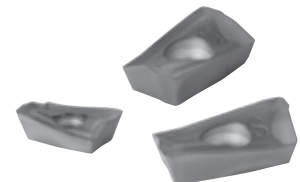

MECHT

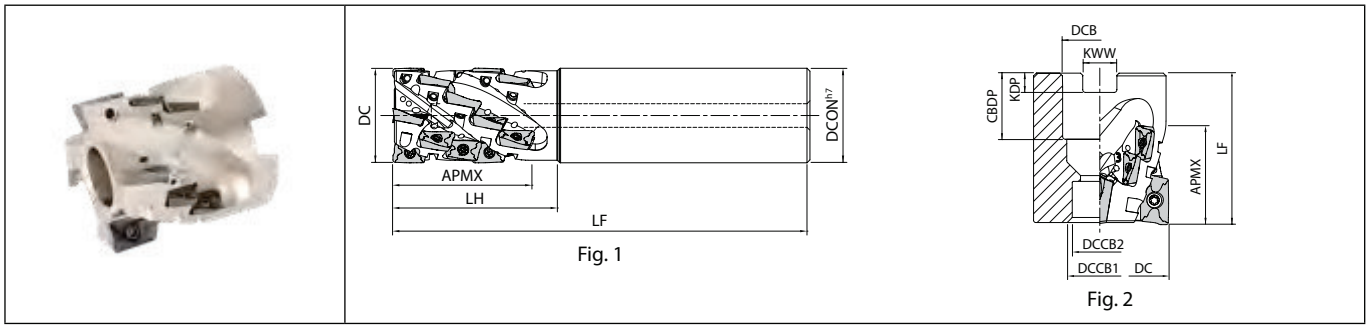

Toolholder dimensions

Description	Availability	Inserts	Flutes	Stages	Dimension (mm)											A.R. max. (°)	R.R. max. (°)	Coolant hole	Fig.	Spare parts			Applicable inserts M106	
					DC	DCON	DCB	DCCB ₁	DCCB ₂	LF	LH	CBDB	KDP	KWW	APMX					Mounting bolt	Screw	Wrench	Stages	
																							1st	2nd or higher
MECHT 32-S32-11-5-4T	●	20	4	5	32	32	-	-	-	140	55	-	-	-	46	+23	-9	Yes	1	-	SB-2555TRG	DTM-8	BDMT11T3..	BDMT11T308..
MECHT 50R-1711-3-4T-M 50R-1711-4-5T-M 63R-17-4-5T-M 80R-17-4-6T-M	●	12	4	3	50		27	20	14	55		24	7	12.4	34	+19	-7	Yes	2	HH12X40	SB-2555TRG	DTM-8	BDMT1704..	BDMT11T308..
		65	43	DTM-15																				
	●	20	5	4	63	-				80					60			Yes	2	HH12X65	SB-4070TRN	DTM-15	BDMT1704..	BDMT170408..
	●	24	6	6	80	32	26	17				28	8	14.4					2	HH16X65				

Use inserts with Corner-R of 0.8 or less for the 2nd or higher stages
 Machining with coolant is recommended (Internal coolant pressure 1.5 MPa or higher)
 Coat Anti-seize Compound(P-37) thinly on portion of taper and thread when insert is fixed.



● : Standard item R : Right-hand only L : Left-hand only □ : Check availability

BDMT

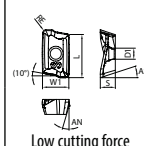
Classification of usage		Carbon steel / Alloy steel		P								
		Mold and die steel										
★ : Roughing / 1st Choice ☆ : Roughing / 2nd Choice ■ : Finishing / 1st Choice □ : Finishing / 2nd Choice (In case hardness is 45HRC or under)		Austenitic stainless steel		M								
		Martensitic stainless steel										
		Gray cast iron		K								
		Nodular cast iron										
		Non-ferrous metals		N								
		Heat-resistant alloy										
		Titanium alloy		★ S								
		Hard materials		H								
Insert	Description	No. of edges	Dimension (mm)					Angle (°)		PVD PR1535	Carbide	Applicable toolholder ➡ M105
			S	D1	RE	L	W1	AN	AS			
  <p>Low cutting force</p>	BDMT 11T302ER-JS 11T304ER-JS 11T308ER-JS	2	3.8	2.8	0.2 0.4 0.8	11	6.7	13	18	● ● ●	MECHT...11...	
	BDMT 170404ER-JS 170408ER-JS	2	4.9	4.4	0.4 0.8	17	9.6	13	18	● ●	MECHT...17...	

Handed insert shows Right-hand

Recommended cutting conditions ➡ M107



Milling

Cutting edge angle 45°~70°
Cutting edge angle 75°
Cutting edge angle 88°/90°
Cutter for Finishing
High Feed Cutter
Multi- Function
Slot Mill
Ball-nose Radius
Others

● : Standard item R : Right-hand only L : Left-hand only □ : Check availability

M106

Recommended cutting conditions

Workpiece	Applications	Depth of cut (mm)		fz (mm/t)	Recommended insert grade (Vc: m/min)
		ap	ae		MEGACOAT NANO
					PR1535
Titanium alloy (Ti6Al4V)	Shouldering	~Length of cut (APMX)	~0.5DC	0.10 ~ 0.12 ~ 0.16	30 ~ 40 ~ 60
	Slotting	~0.5DC	1DC	0.05 ~ 0.07 ~ 0.09	30 ~ 40 ~ 50



Milling

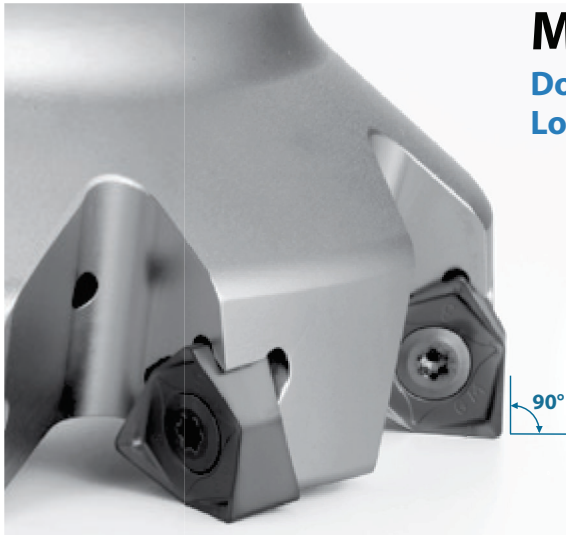

MFWN

Double-sided, 6-edge insert, 90° cutters
Low cutting force and reduced chattering

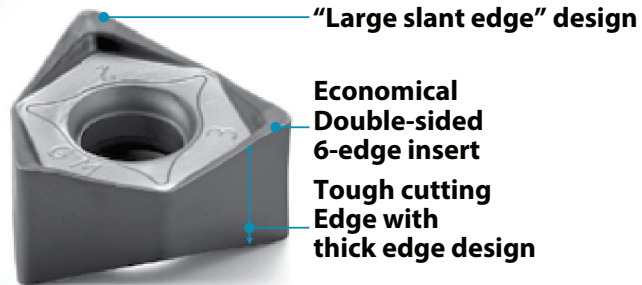

1 Sharp cutting with low cutting force

Sharp cutting by large rake angle

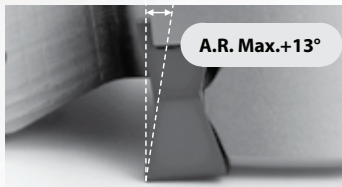

"Large slant edge" design reduces shock when cutting edge enters the workpiece

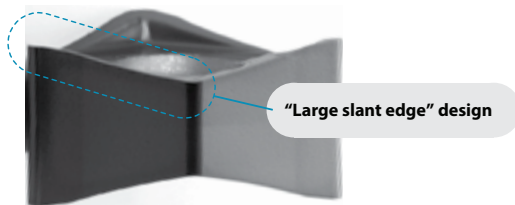

Cutting force comparison (Internal evaluation)

<Cutting conditions>

Vc = 180m/min
apxae = 7x 110mm
fz = 0.2mm/t
Workpiece material: C50
ø125mm Cutter

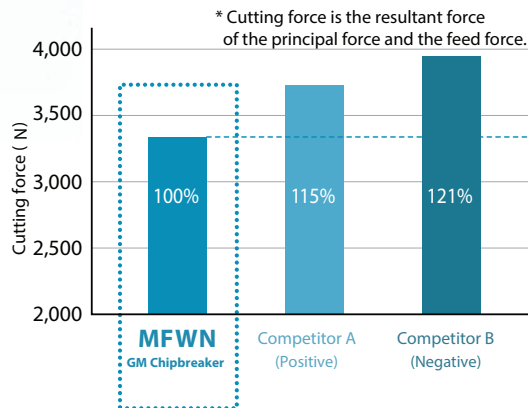

2 Superior fracture resistance with thick edge design

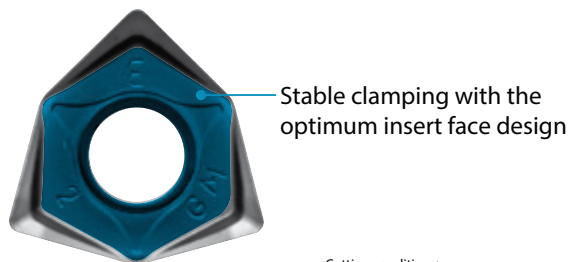
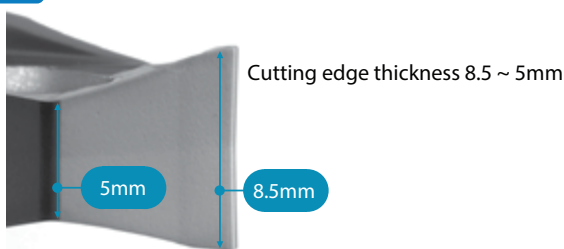

<Cutting conditions>

Workpiece material : 42CrMo4(38-42H5) Interruption with a slot on the workpiece
Vc = 100m/min apxae = 2x100mm fz = 0.2 ~0.45 mm/t Dry

Fracture resistance comparison (Internal evaluation)

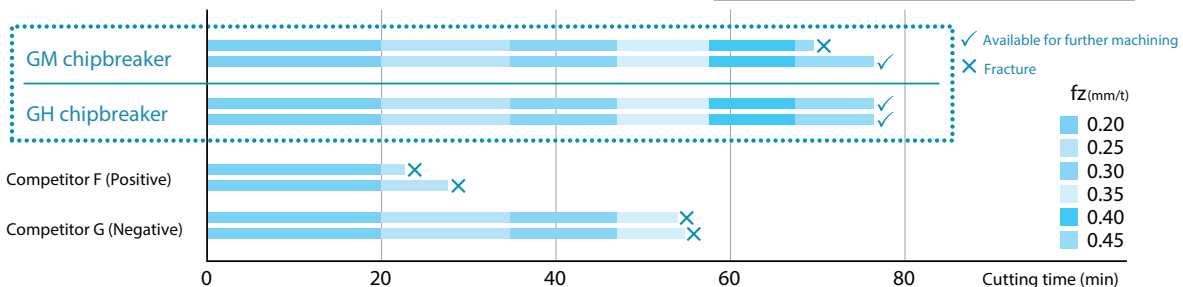

M
Milling

Cutting edge angle 45°~70°
Cutting edge angle 75°
Cutting edge angle 88°/90°
Cutter for Finishing
High Feed Cutter
Multi-Function
Slot Mill
Ball-nose Radius
Others

MFWN

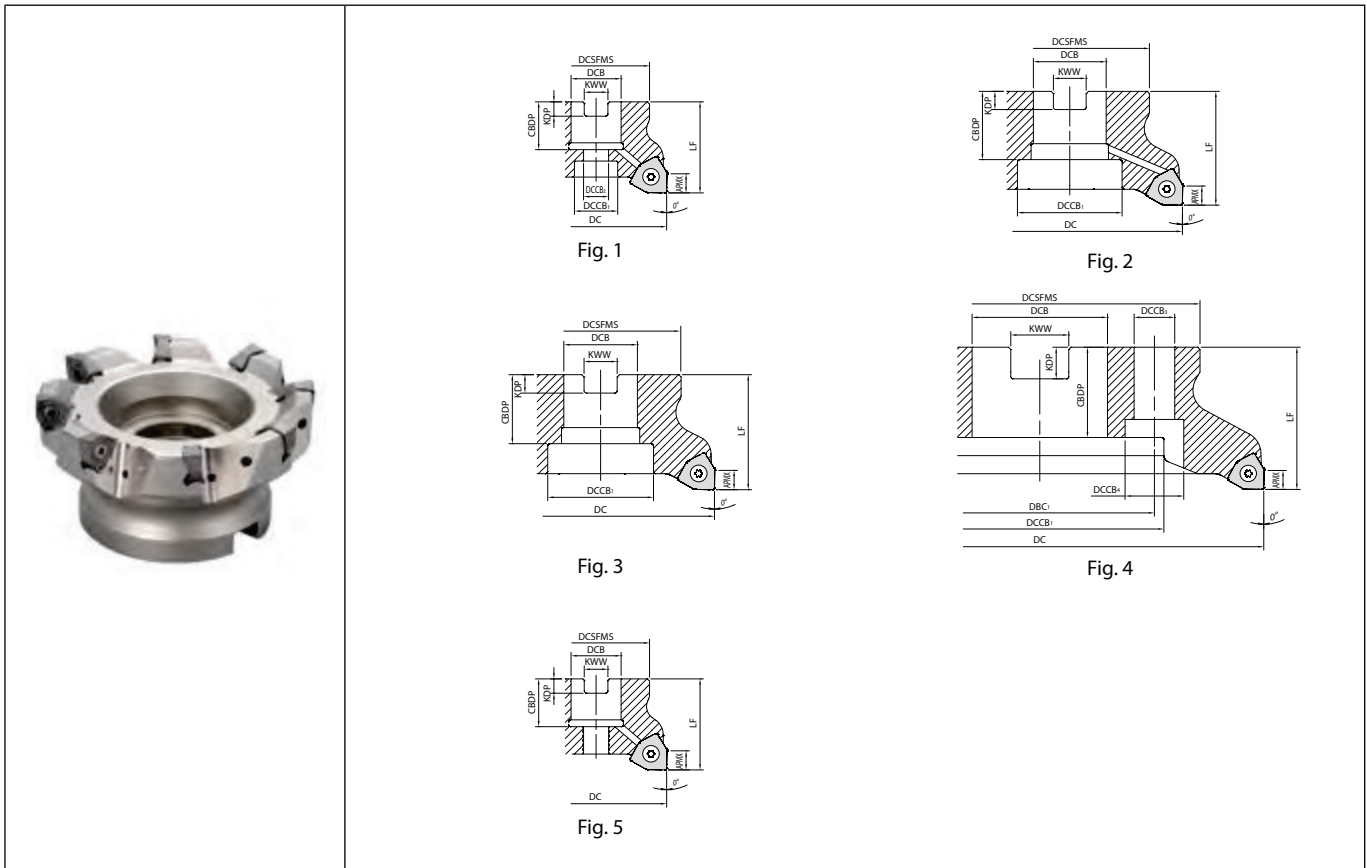

Toolholder dimensions

Description	Availability	Dimension (mm)														A.R. max. (°)	R.R. (°)	Coolant hole	Max. revolution (min ⁻¹)	Weight (kg)	Fig.	Applicable inserts ➔ M113
		Inserts	DC	DCSFMS	DCB	DCCB ₁	DCCB ₂	DCCB ₃	DCCB ₄	DBC ₁	Lf	CBDP	KDP	KWW	APMX							
Coarse pitch	MFWN	90050R-4T-MC-KUA	● 4	50	45	22	-	-	-	-	40	21	6.3	10.4	8	-6	-12	Yes	18500	0.35	5	WNEU0806... WNGT0806... WNMU0806...
		90063R-3T-M	● 3	63	47	22	19	11	-	-	40	21	6.3	10.4		-10	-10		14000	0.5	1	
		90080R-4T-M	● 4	80	60	27	20	13	-	-	50	24	7	12.4		-9	-9		12000	1	1	
		90100R-5T-M	● 5	100	70	32	46	-	-	-	50	30	8	14.4		-8	-8		10500	1.3	2	
		90125R-6T-M	● 6	125	87	40	55	-	-	-	63	33	9	16.4		-7.5	-7.5		9500	2.5	2	
		90160R-8T-M	● 8	160	102	68	-	14	20	66.7	63	32	9	16.4		-7	-7		8000	3.8	4	
		90200R-10T-M	● 10	200	142	60	110	-	18	26	101.6	40	14	25.7		-7	-7		7500	6	4	
90250R-12T-M	● 12	250	142	60	110	-	18	26	101.6	40	14	25.7	-7	-7	6500	8.4	4					
Fine pitch	MFWN	90063R-4T-M	● 4	63	47	22	19	11	-	-	40	21	6.3	10.4	8	-10	-10	Yes	16000	0.5	1	WNEU0806... WNGT0806... WNMU0806...
		90080R-5T-M	● 5	80	60	27	20	13	-	-	50	24	7	12.4		-9	-9		13500	1	1	
		90100R-7T-M	● 7	100	70	32	46	-	-	-	50	30	8	14.4		-8	-8		12000	1.3	2	
		90125R-8T-M	● 8	125	87	40	55	-	-	-	63	33	9	16.4		-7.5	-7.5		10500	2.6	2	
		90160R-10T-M	● 10	160	102	68	-	14	20	66.7	63	32	9	16.4		-7	-7		9000	3.9	4	
		90200R-12T-M	● 12	200	142	60	110	-	18	26	101.6	40	14	25.7		-7	-7		8000	6.3	4	
		90250R-14T-M	● 14	250	142	60	110	-	18	26	101.6	40	14	25.7		-7	-7		7000	8.7	4	
Extra fine pitch	MFWN	90063R-5T-M	● 5	63	47	22	19	11	-	-	40	21	6.3	10.4	8	-10	-10	Yes	16000	0.5	1	WNEU0806... WNGT0806... WNMU0806...
		90080R-7T-M	● 7	80	60	27	20	13	-	-	50	24	7	12.4		-9	-9		10500	1.1	1	
		90100R-9T-M	● 9	100	70	32	46	-	-	-	50	30	8	14.4		-8	-8		9500	1.3	2	
		90125R-12T-M	● 12	125	87	40	55	-	-	-	63	33	9	16.4		-7.5	-7.5		8000	2.6	2	
		90160R-14T-M	● 14	160	102	68	-	14	20	66.7	63	32	9	16.4		-7	-7		7000	3.9	4	

Max. revolution : Do not use the cutter at the maximum revolution or higher since the centrifugal force may cause inserts and parts to scatter even under no load.

● : Standard item R : Right-hand only L : Left-hand only □ : Check availability



Milling

Toolholder dimensions

Description		Availability		Dimension (mm)																A.R. max. (°)	R.R. (°)	Coolant hole	Max. revolution (min ⁻¹)	Weight (kg)	Fig.	Applicable inserts ➔ M113	
		R	Inserts	DC	DCSFMS	DCB	DCCB ₁	DCCB ₂	DCCB ₃	DCCB ₄	DBC ₁	LF	CBDP	KDP	KWW	APMX											
Bore dia. inch spec	Coarse pitch	MFWN 90080R-4T	<input type="checkbox"/>	4	80	60	25.4	20	13							50	27	6	9.5	8	+13	-9		12000	1	1	WNEU0806... WNGT0806... WNMU0806...
		MFWN 90100R-5T	<input type="checkbox"/>	5	100	70	31.75	46								34	8	12.7				-8	Yes	10500	1.3	2	
		MFWN 90125R-6T	<input type="checkbox"/>	6	125	87	38.1	55								38	10	15.9				-7.5		9500	2.6	2	
		MFWN 90160R-8T	<input type="checkbox"/>	8	160	102	50.8	72	-							63	11	19.1				-7	No	8000	3.9	3	
		MFWN 90200R-10T	<input type="checkbox"/>	10	200											40	14	25.4				-7	No	7500	6.3	4	
		MFWN 90250R-12T	<input type="checkbox"/>	12	250	142	47.625	110				18	26	101.6									-7	No	6500	8.7	
	Fine pitch	MFWN 90080R-5T	<input type="checkbox"/>	5	80	60	25.4	20	13							50	27	6	9.5	8	+13	-9		13500	1	1	WNEU0806... WNGT0806... WNMU0806...
		MFWN 90100R-7T	<input type="checkbox"/>	7	100	70	31.75	46								34	8	12.7				-8	Yes	12000	1.4	2	
		MFWN 90125R-8T	<input type="checkbox"/>	8	125	87	38.1	55								38	10	15.9				-7.5		10500	2.7	2	
		MFWN 90160R-10T	<input type="checkbox"/>	10	160	102	50.8	72	-							63	11	19.1				-7	No	9000	4	3	
		MFWN 90200R-12T	<input type="checkbox"/>	12	200											40	14	25.4				-7	No	8000	6.6	4	
		MFWN 90250R-14T	<input type="checkbox"/>	14	250	142	47.625	110				18	26	101.6									-7	No	7000	8.9	
	Extra fine pitch	MFWN 90080R-7T	<input type="checkbox"/>	7	80	60	25.4	20	13							50	27	6	9.5	8	+13	-9		10500	1.1	1	WNEU0806... WNGT0806... WNMU0806...
		MFWN 90100R-9T	<input type="checkbox"/>	9	100	70	31.75	46								34	8	12.7				-8	Yes	9500	1.3	2	
		MFWN 90125R-12T	<input type="checkbox"/>	12	125	87	38.1	55								38	10	15.9				-7.5		8000	2.7	2	
		MFWN 90160R-14T	<input type="checkbox"/>	14	160	102	50.8	72	-							63	11	19.1				-7	No	7000	4.1	3	
		MFWN 90200R-16T	<input type="checkbox"/>	16	200											40	14	25.4				-7	No	6500	6.7	4	
		MFWN 90250R-18T	<input type="checkbox"/>	18	250	142	47.625	110				18	26	101.6									-7	No	5500	9.1	

Max. revolution : Do not use the cutter at the maximum revolution or higher since the centrifugal force may cause inserts and parts to scatter even under no load.











Milling

- Cutting edge angle 45°~70°
- Cutting edge angle 75°
- Cutting edge angle 88°/90°
- Cutter for Finishing
- High Feed Cutter
- Multi-Function
- Slot Mill
- Ball-nose Radius
- Others

● : Standard item R : Right-hand only L : Left-hand only ☐ : Check availability

M110

Spare parts

Description		Spare parts							
		Clamp screw	Wrench		Shim	Shim screw	Wrench	Anti-seize compound	Mounting bolt
			TTW	DTM					
									
Coarse pitch	MFWN 90063R-3T-M	SB-50140TR	TTW-15	-	MFWN-90	SPW-7050	LW-5	P-37	HH10X30
	MFWN 90080R-4T(-M)								HH12X35
	MFWN 90100R-5T(-M)								-
	90250R-12T(-M)								
Fine pitch	MFWN 90063R-4T-M	SB-50140TR	TTW-15	-	-	-	-	P-37	HH10X30
	MFWN 90080R-5T(-M)								HH12X35
	MFWN 90100R-7T(-M)								-
	90250R-14T(-M)								
Extra fine pitch	MFWN 90063R-5T-M	SB-50140TR	TTW-15	-	-	-	-	P-37	HH10X30
	MFWN 90080R-7T(-M)	SB-40140TRN	-	DTM-15					HH12X35
	MFWN 90100R-9T(-M)	-							
	90160R-14T(-M)								

 Coat anti-seize compound thinly on portion of taper and thread when insert is fixed.



MFWN

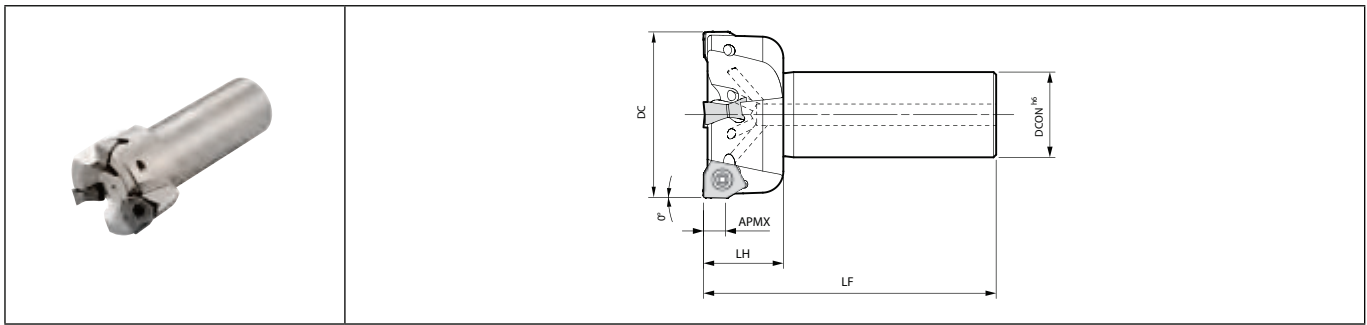

Toolholder dimensions

Description	Availability	Inserts	Dimension (mm)						A.R. max. (°)	R.R. (°)	Coolant hole	Max. revolution (min ⁻¹)	Spare parts			Applicable inserts M113
			R	DC	DCON	LF	LH	APMX					Screw	Wrench	Anti-seize compound	
MFWN 90050R-S32-3T	●	3	50						-12	18500	SB-50140TR	TTW-15		WNEU0806... WNGT0806... WNMU0806...		
90063R-S32-4T	●	4	63	32	110	30	8	+13	-10	16000	Recommended tightening torque for insert clamp 4.2N-m		P-37			
90080R-S32-5T	●	5	80						-9	13500						

Max. revolution : Do not use the cutter at the maximum revolution or higher since the centrifugal force may cause inserts and parts to scatter even under no load.
Coat Anti-seize Compound thinly on portion of taper and thread when insert is fixed.

How to mount an insert

1. Be sure to remove dust and chips from the insert mounting pocket.
2. After applying anti-seize compound on portion of taper and thread, attach the screw to the front end of the wrench. While lightly pressing the insert against the constraint surfaces, put the screw into the hole of the insert and tighten. (Ref. to Fig. 1)
3. When tightening the screw, make sure that the wrench is parallel to the screw.
Remember that the screw hole of the toolholder for Extra fine pitch is inclined to the bearing surface. (Ref. to Fig. 2 and Fig. 3)
4. Be careful not to tighten the screw with excessive torque.
Recommended tightening torque is 4.2N-m for M5 screw (SB-50140TR) and 3.5N-m for M4 screw (SB-40140TRN).
5. After tightening the screw, make sure that there is no clearance between the insert seat surface and the bearing surface of the toolholder or between the insert side surfaces and the constraint surface of the toolholder. If there is any clearance, remove the insert and mount it again according to the above steps.
6. To change the cutting edge of the insert, turn the insert counterclockwise (Ref. to Fig. 4). The insert corner identification number is stamped on the top surface of the insert.

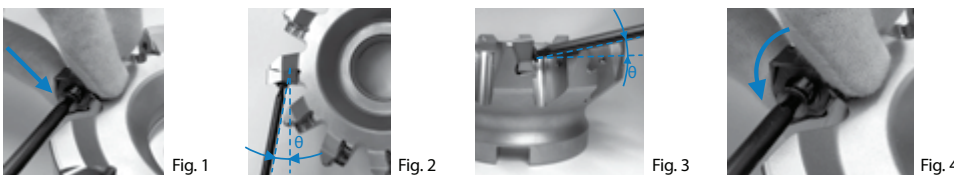

How to replace a shim (For coarse pitch)

1. Be sure to remove dust and chips from the insert mounting pocket.
2. The shim must be mounted in the proper direction. While aligning the surface of the shim with the mark on it to the corresponding constraint surface (Ref. to Fig. 1) and lightly pressing the shim toward the constraint surface (Ref. to Fig. 2), insert the screw into the hole of the shim and tighten (Ref. to Fig. 3). When tightening the screw, make sure that the screw is vertical to the bearing surface (Recommended tightening torque is 6.0N-m).
3. After tightening the screw, make sure that there is no clearance between the shim seat surface and the bearing surface. If there is any clearance, remove the insert and mount it again according to the above steps.

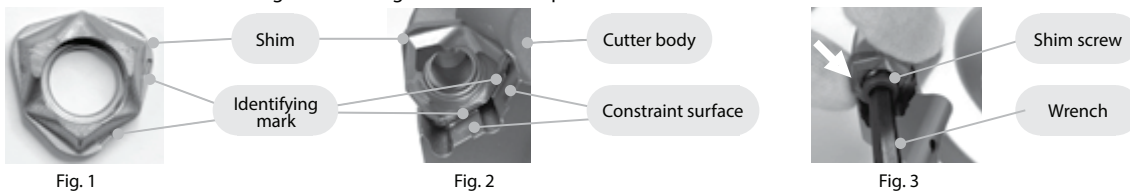

● : Standard item R : Right-hand only L : Left-hand only □ : Check availability

M112

M

Milling

Cutting edge angle 45°~70°

Cutting edge angle 75°

Cutting edge angle 88°/90°

Cutter for Finishing

High Feed Cutter

Multi-Function

Slot Mill

Ball-nose Radius

Others

WNEU/WNMU/WNGT

Insert		Description	No. of edges	Dimension (mm)					Carbide							Applicable toolholder M109 M110 M112		
				IC	S	D1	RE	BS	CVD		DLC		PVD				Cermet	
									CA6535	PDL025	PR0155	PR1510	PR1525	PR1535	GW25			TNG20M
	 Surface finish oriented	WNEU 080608EN-GL	6	14.02	6.65	6.2	0.8	1.5	●		●	●	●					MFWN90...
	 3-edge / Non-Ferrous Metals	WNGT 080608FN-AM	3	14.02	6.65	6.2	0.8	1.5	●									MFWN90...
	 Tough edge	WNMU 080608EN-GH	6	14.02	6.65	6.2	0.8	1.3	●		●	●	●					MFWN90...
	 General purpose	WNMU 080604EN-GM 080608EN-GM	6	14.02	6.65	6.2	0.4 0.8	1.7 1.3	●		●	●	●					MFWN90...
	 Low cutting force	WNMU 080608EN-SM	6	14.02	6.65	6.2	0.8	1.3	●		●	●						MFWN90...

Recommended cutting conditions M114

Classification of usage

- ★ : Roughing / 1st Choice
- ☆ : Roughing / 2nd Choice
- : Finishing / 1st Choice
- : Finishing / 2nd Choice
- (In case hardness is 45HRC or under)

Carbon steel / Alloy steel					★	☆	■	P
Mold and die steel					★	☆	■	
Austenitic stainless steel					☆	★		M
Martensitic stainless steel	★					☆		
Precipitation hardening stainless steel						★		
Gray cast iron					★			K
Nodular cast iron					★			
Non-ferrous metals		★					☆	N
Heat-resistant alloy	★					☆		S
Titanium alloy						★		
Hard materials					★			H



● : Standard item R : Right-hand only L : Left-hand only □ : Check availability

Applicable chipbreaker

Cutter type	Chipbreaker			
	GM	SM (GL)	GH	AM
Coarse pitch (With shim)	●	●	●	●
Fine pitch (Without shim)	●	●	△ (Feed rate is recommended fz=0.3mm/t or under)	●
Extra fine pitch (Without shim)	●	●	Not recommended	Not recommended

Vertical milling (Plunging)

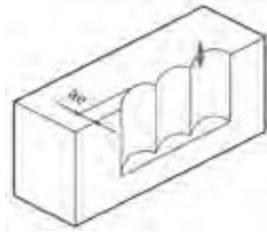

Cutting dia.	Max. width of cut (ae)
All items	8mm

Cutter type and chipbreaker selection

Milling purpose	Cutter type			Chipbreaker				
	Coarse pitch	Fine pitch	Extra fine pitch	GM	SM	GH	GL	AM
General milling for steel and alloy steel		●		●				
Steel and alloy steel (At chattering due to low rigidity machine or poor clamping power)	●				●			
Productivity oriented (Running cost decrease) (ap=4 mm and over, fz=0.25 mm/t and over)	●					●		
Surface finish oriented	●	●					●	
General milling of stainless steel		●			●			
Stainless steel (At chattering due to low rigidity machine or poor clamping power)	●				●			
Cast iron (For processing efficiency improvement)			●	●				
Cast iron (ap=4 mm and over, fz=0.25 mm/t and over)	●					●		
General milling of aluminum alloys		●						●
Aluminum alloys (at chattering due to low rigidity machine or poor clamping power)	●							●

Case studies

GG30

Machine part
 Vc=170m/min
 apxae=2.5x130mm
 fz=0.183mm/t (Vf=500mm/min)
 Wet
 MFWN90160R-8T (8 flutes)
 WNMU080608EN-GM (PR1510)

PR1510	Chip evacuation rate = 163cc/min
Competitor A (Positive cutter)	Chip evacuation rate = 68cc/min

Competitor A proceeded machining under low cutting conditions, as the workpiece was slipping because of the unstable chucking. With MFWN, stable machining was possible at higher cutting conditions. (User evaluation)

Manganese Steel

Construction machine part
 Vc=150m/min
 apxae=1x100mm
 fz=0.2mm/t (Vf=668mm/min)
 Dry
 MFWN90100R-7T (7 flutes)
 WNMU080608EN-GM (PR1525)

PR1525	Machining efficiency: 2 pcs/edge
Competitor B (Negative cutter) (Vertical inserts)	1 pc/edge

Despite instability with the long overhang of the workpiece, MFWN doubled tool life, improving the efficiency by 150%. (User evaluation)



Milling

Low cutting force 90° milling cutter

MFWN Mini

Economical small diameter MFWN series milling cutters
Additional fine pitch, small diameter toolholders available

1 Cost-efficient 6-edge inserts

Smaller insert design technology maintains original MFWN cutting performance
Can be used up to 5 mm depth of cut.

Smaller insert size

MFWN Mini
05 size



D.O.C. ~5 mm

MFWN
08 size

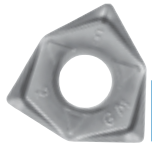

D.O.C. ~8 mm

Increased versatility

Large small-diameter lineup

High-efficiency machining with fine pitch styles

1 ~ 3 additional flutes



Expanded lineup of smaller diameters

Face Mill ø50
End Mill ø25 - ø40



M 2 Inherits previous MFWN series design elements and features

Low cutting force and high chattering-resistance

Sharp cutting by large rake angle
"Large slant edge" design reduces shock when cutting edge enters the workpiece

A.R. Max +11° "Large slant edge" design

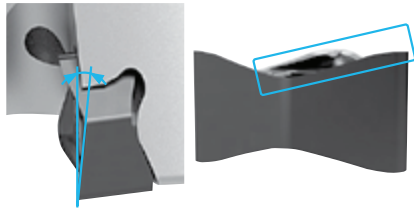

Superior fracture resistance with thick edge design

Stable clamping strength with unique insert face Design

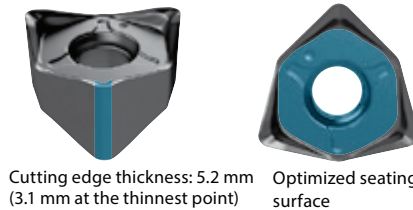

Cutting edge thickness: 5.2 mm (3.1 mm at the thinnest point) Optimized seating surface

Neutral inserts for various uses

Symmetrical side and bottom cutting edges provide a wide range of machining applications

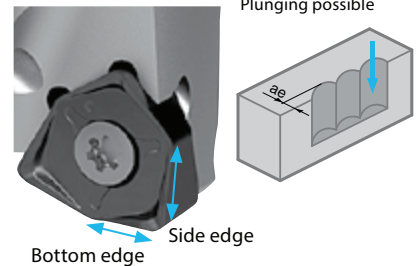

Bottom edge Side edge

Plunging possible

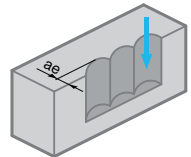

Cutting force comparison (Internal evaluation)

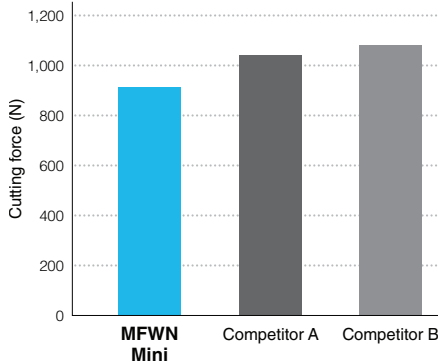

Cutting conditions : Vc = 150 m/min, fz = 0.15 mm/t, ap × ae = 1.5 × 35 mm, dry cutting, Dia.ø63, workpiece material: SCM440

Fracture resistance comparison (Internal evaluation)

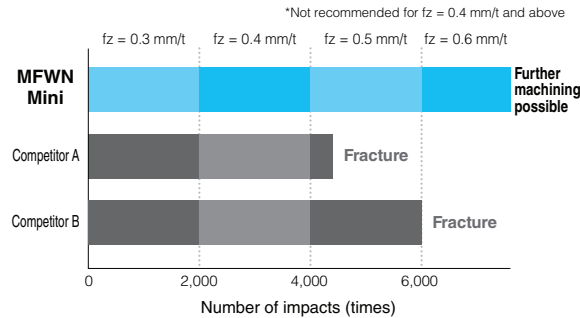

Cutting conditions : Vc = 120 m/min, ap × ae = 1.5 × 30 mm, Dry cutting, Dia.ø63 workpiece material: Mold Steel 37~43HRC

Left-handed toolholders are also available (Custom order)



Milling

- Cutting edge angle 45°~70°
- Cutting edge angle 75°
- Cutting edge angle 88°/90°
- Cutter for Finishing
- High Feed Cutter
- Multi-Function
- Slot Mill
- Ball-nose Radius
- Others

MFWN Mini

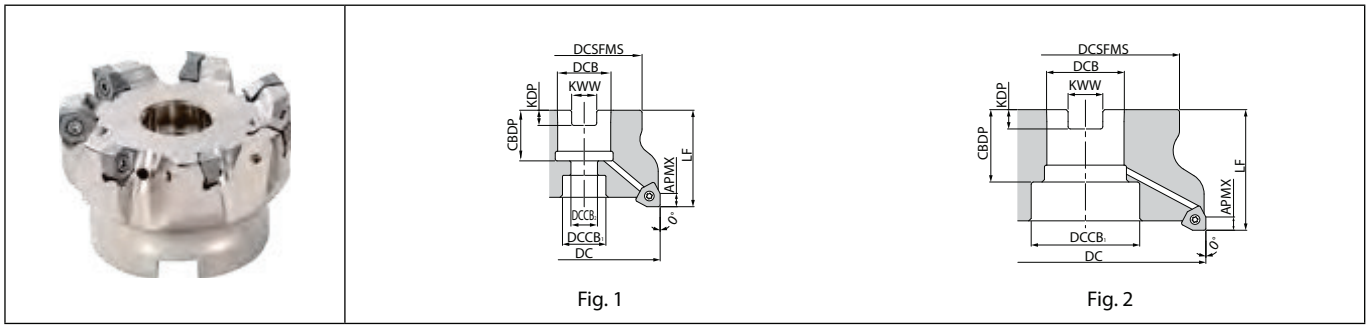

Toolholder dimensions

Description		Availability	Dimension (mm)											A.R. max. (°)	R.R. (°)	Coolant hole	Max. revolution (min ⁻¹)	Weight (kg)	Fig.	Applicable inserts M119	
			Inserts	DC	DCSFMS	DCB	DCCB ₁	DCCB ₂	LF	CBDP	KDP	KWW	APMX								
Metric	Fine pitch	MFWN	●	5	50	48	22	17.5	11	40	21	6.3	10.4	5	+11	-9	Yes	13800	0.4	1	WNMU0504...
			●	6	63			18										12300	0.5	1	
			●	7	80	70	27	20	13	50	24	7	12.4					10900	1.2	1	
			●	8	100	78	32	45	-		30	8	14.4					9700	1.6	2	
			●	11	125	89	40	55	-		63	33	9					16.4	8700	2.8	
Metric	Extra fine pitch	MFWN	●	6	50	48	22	17.5	11	40	21	6.3	10.4	5	+11	-9	Yes	13800	0.4	1	WNMU0504...
			●	7	63			18										12300	0.5	1	
			●	9	80	70	27	20	13	50	24	7	12.4					10900	1.2	1	
			●	11	100	78	32	45	-		30	8	14.4					9700	1.5	2	
			●	14	125	89	40	55	-		63	33	9					16.4	8700	2.7	
Bore dia. inch spec	Fine pitch	MFWN	□	7	80	70	25.4	20	13	50	27	6	9.5	5	+11	-7	Yes	10900	1.3	1	WNMU0504...
			□	8	100	78	31.75	45	-		34	8	12.7					9700	1.6	2	
			□	11	125	89	38.1	55	-		63	38	10					15.9	8700	2.9	
	Extra fine pitch	MFWN	□	9	80	70	25.4	20	13	50	27	6	9.5	5	+11	-7	Yes	10900	1.2	1	WNMU0504...
			□	11	100	78	31.75	45	-		34	8	12.7					9700	1.6	2	
			□	14	125	89	38.1	55	-		63	38	10	15.9			8700	2.8	2		

Max. revolution : Do not use the cutter at the maximum revolution or higher since the centrifugal force may cause inserts and parts to scatter even under no load.

Spare parts

Description		Clamp Screw	Wrench	Anti-seize Compound	Mounting bolt
Fine pitch	MFWN	SB-3065TRP	DTPM-8	P-37	HH10×30
	90063R-05-6T-M				HH10×30
	90080R-05-7T(-M)				HH12×35
	90100R-05-8T(-M)				-
	90125R-05-11T(-M)				-
Extra fine pitch	MFWN	SB-3065TRP	DTPM-8	P-37	HH10×30
	90063R-05-7T-M				HH10×30
	90080R-05-9T(-M)				HH12×35
	90100R-05-11T(-M)				-
	90125R-05-14T(-M)				-

Coat Anti-seize Compound thinly on portion of taper and thread when insert is fixed.

● : Standard item R : Right-hand only L : Left-hand only □ : Check availability



Milling

MFWN Mini

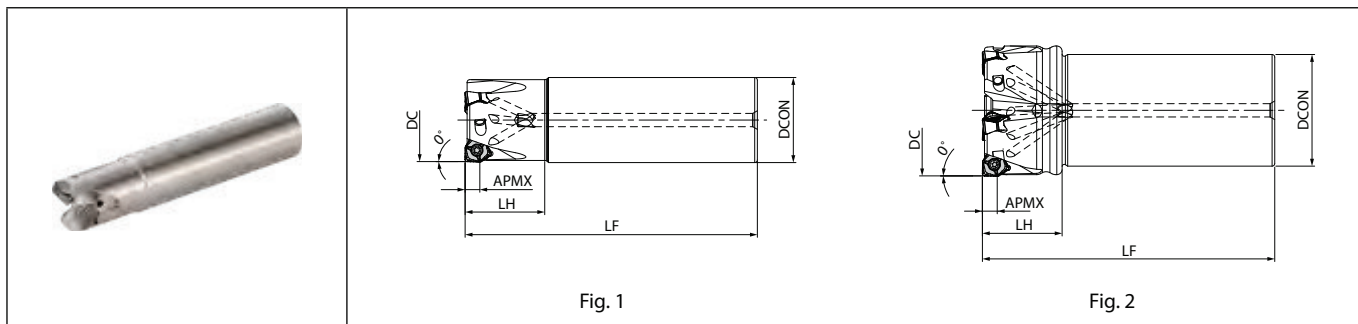

Toolholder dimensions

Description	Availability	Inserts	Dimension (mm)						A.R. max. (°)	R.R. (°)	Coolant hole	Max. revolution (min ⁻¹)	Fig.	Spare parts			Applicable inserts M119
			R	DC	DCON	LF	LH	APMX						Screw	Wrench	Anti-seize compound	
MFWN 90025R-S25-05-2T	●	2	25	25	120	32	5	+11	Yes	-14.5	19500	1	SB-306STRP	DTPM-8	P-37	WNMU0504...	
90032R-S32-05-3T	●	3	32		130	40					-12	17200					1
90040R-S32-05-4T	●	4	40		150	50					-10	15400					2
90050R-S32-05-5T	●	5	50	32							-9	13800					2
90063R-S32-05-6T	●	6	63		110	30					-8	12300					2
90080R-S32-05-7T	●	7	80								-7	10900					2
<div style="border: 1px solid black; padding: 2px; display: inline-block;">Recommended tightening torque for insert clamp 1.2N·m</div>																	

Max. revolution : Do not use the cutter at the maximum revolution or higher since the centrifugal force may cause inserts and parts to scatter even under no load.
Coat Anti-seize Compound thinly on portion of taper and thread when insert is fixed.



Milling

Cutting edge angle 45°~70°
Cutting edge angle 75°
Cutting edge angle 88°/90°
Cutter for Finishing
High Feed Cutter
Multi-Function
Slot Mill
Ball-nose Radius
Others

● : Standard item R : Right-hand only L : Left-hand only □ : Check availability

M118

WNMU

Insert		Description	No. of edges	Dimension (mm)					Carbide				Applicable toolholder M117 M118
				IC	S	D1	RE	BS	PVD				
									PR0155	PR1510	PR1525	PR1535	
		WNMU 050408EN-GM	6	8.8	4.2	3.4	0.8	0.7	●	●	●	●	MFWN90...-05...
General purpose													
		WNMU 050408EN-SM	6	8.8	4.2	3.4	0.8	0.7	●	●	●	●	MFWN90...-05...
Low cutting force													
		WNMU 050408EN-GH	6	8.8	4.2	3.4	0.8	0.7	●	●	●	●	MFWN90...-05...
Tough edge													

Classification of usage

★ : Roughing / 1st Choice
 ☆ : Roughing / 2nd Choice
 ■ : Finishing / 1st Choice
 □ : Finishing / 2nd Choice
 (In case hardness is 45HRC or under)

Carbon steel / Alloy steel	★	☆	☆	P
Mold and die steel	★	☆	☆	P
Austenitic stainless steel	☆	★	★	M
Martensitic stainless steel			☆	M
Precipitation hardening stainless steel			★	M
Gray cast iron	★			K
Nodular cast iron	★			K
Non-ferrous metals				N
Heat-resistant alloy			☆	S
Titanium alloy			★	S
Hard materials	★			H

Recommended cutting conditions M120

● : Standard item R : Right-hand only L : Left-hand only □ : Check availability



Recommended cutting conditions

Chipbreaker	Workpiece material	fz (mm/t)	Recommended insert grades (Vc : m/min)			
			MEGACOAT NANO			MEGACOAT HARD
			PR1535	PR1525	PR1510	PR015S
GM	Carbon steel	0.1 – 0.2 – 0.25	☆ 120 – 180 – 250	★ 120 – 180 – 250	–	–
	Alloy steel		☆ 100 – 160 – 220	★ 100 – 160 – 220	–	–
	Mold steel	0.1 – 0.15 – 0.2	☆ 80 – 140 – 180	★ 80 – 140 – 180	–	–
	Stainless steel (Austenitic related)	0.1 – 0.15 – 0.2	☆ 100 – 160 – 200	☆ 100 – 160 – 200	–	–
	Stainless steel (Martensitic related)		☆ 150 – 200 – 250	–	–	–
	Stainless steel (Precipitation Hardening)		★ 90 – 120 – 150	–	–	–
	Gray cast iron	0.1 – 0.2 – 0.25	–	–	★ 120 – 180 – 250	–
	Nodular cast iron	0.1 – 0.15 – 0.2	–	–	★ 100 – 150 – 200	–
	Ni-base heat-resistant alloys	0.1 – 0.12 – 0.16	☆ 20 – 30 – 50	–	–	–
	SM	Carbon steel	0.06 – 0.12 – 0.2	☆ 120 – 180 – 250	☆ 120 – 180 – 250	–
Alloy steel		☆ 100 – 160 – 220		☆ 100 – 160 – 220	–	–
Mold steel		0.06 – 0.08 – 0.15	☆ 80 – 140 – 180	☆ 80 – 140 – 180	–	–
Stainless steel (Austenitic related)		0.06 – 0.12 – 0.2	★ 100 – 160 – 200	☆ 100 – 160 – 200	–	–
Stainless steel (Martensitic related)			☆ 150 – 200 – 250	–	–	–
Stainless steel (Precipitation Hardening)			☆ 90 – 120 – 150	–	–	–
Gray cast iron		0.06 – 0.12 – 0.2	–	–	☆ 120 – 180 – 250	–
Nodular cast iron		0.06 – 0.08 – 0.15	–	–	☆ 100 – 150 – 200	–
Ni-base heat-resistant alloys		0.06 – 0.08 – 0.15	★ 20 – 30 – 50	–	–	–
Titanium alloys		0.06 – 0.08 – 0.15	★ 40 – 60 – 80	–	☆ 40 – 60 – 80	–
GH	Carbon steel	0.15 – 0.2 – 0.3	☆ 120 – 180 – 250	☆ 120 – 180 – 250	–	–
	Alloy steel		☆ 100 – 160 – 220	☆ 120 – 160 – 220	–	–
	Mold steel	0.15 – 0.2 – 0.25	☆ 80 – 140 – 180	☆ 80 – 140 – 180	–	–
	Stainless steel (Austenitic related)	0.15 – 0.2 – 0.25	☆ 100 – 160 – 200	☆ 100 – 160 – 200	–	–
	Stainless steel (Martensitic related)		☆ 150 – 200 – 250	–	–	–
	Stainless steel (Precipitation Hardening)		☆ 90 – 120 – 150	–	–	–
	Gray cast iron	0.15 – 0.2 – 0.3	–	☆ 120 – 180 – 250	☆ 120 – 180 – 250	–
	Nodular cast iron	0.15 – 0.2 – 0.25	–	☆ 100 – 150 – 200	☆ 100 – 150 – 200	–
	Ni-base heat-resistant alloys	0.1 – 0.15 – 0.2	☆ 20 – 30 – 50	–	–	–
	Hardened Material (60 HRC or less)	0.05 – 0.08 – 0.16	–	–	–	★ 50 – 80 – 100

The bold-faced number indicates a center value of recommended cutting condition. Adjust the cutting speed and the feed rate within the above conditions according to the actual machining situation.

Machining with coolant is recommended for Ni-base heat-resistant alloys and titanium alloys.

When using GH chipbreaker in fine pitch cutters, recommended feed is fz ≤ 0.2 (mm/t).

GH chipbreaker is not recommended for extra fine pitch cutters.

★ : 1st Recommendation

☆ : 2nd Recommendation

M



Milling

Cutting edge angle
45°~70°Cutting edge angle
75°Cutting edge angle
88°/90°Cutter for
FinishingHigh Feed
CutterMulti-
Function

Slot Mill

Ball-nose
Radius

Others

Vertical milling (Plunging)

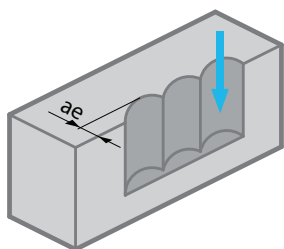

Available for vertical milling (Plunging)

Cutting Dia.	Maximum width of cut (ae)
All Description	5 mm

Ramping and helical milling are not recommended due to interference between workpiece and flank face

Applicable chipbreaker

Cutter type	Chipbreaker		
	GM	SM	GH
Fine pitch	✓	✓	✓
Extra fine pitch	✓	✓	(Feed rate is recommended fz=0.2 mm/t or under)

How to mount an insert

1. Completely eliminate chips and dust from the insert mounting side.
2. Clamp Screw
 - Apply anti-seize compound on portion of taper and thread of clamp screw.
 - After mounting a clamp screw on the top edge of wrench, tighten the screw while keeping the insert pushed against the shim seat surface and holder surface (Fig.1)
3. When tightening the screw, make sure that the wrench is parallel to the screw. Recommended tightening torque . . . 1.2N·m
4. After tightening, check that there is no gap between the insert and the surface of the shim, or between the side surface of insert and the holder surface. If there is a gap, remount the insert using the directions above.

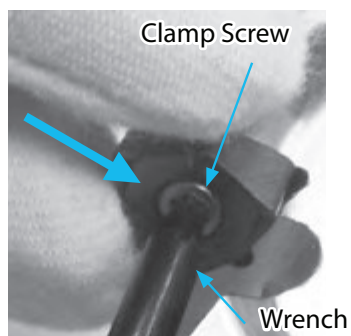

Fig. 1

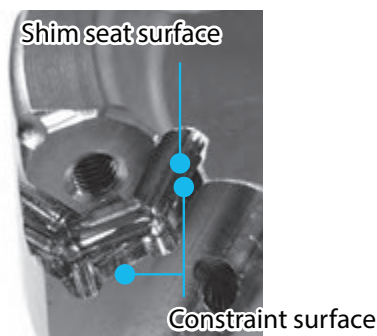

Fig. 2

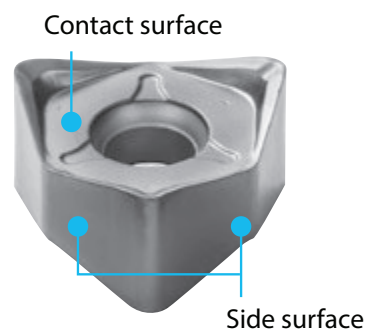

Fig. 3



Milling

Cutting edge angle 88°, high efficiency cutter

MFSN88

Economical double-sided 8-edge insert suitable for shoulder roughing

Reduces chattering with a low cutting force design

Applicable to various types of machining with product lineup from ø32

1 Economical double-sided 8-edge insert suitable for shoulder roughing

Cost reduction in approximately 90° corner cutting

Shoulder roughing

Cost reduction by switching from 90° cutter with positive inserts

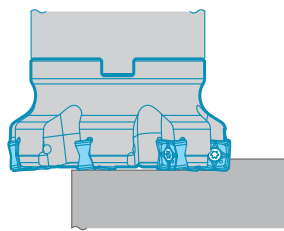

See page M100 for unmachined corner portion

Facing without interfering with fixtures

MFSN88

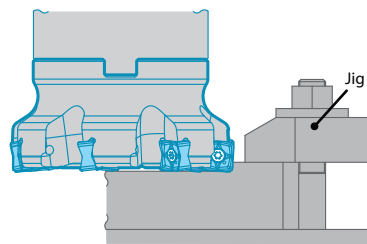

Conventional 45° cutter

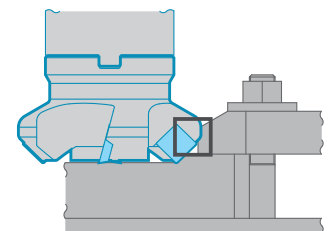

M
Milling

2 Reduces chattering with a low cutting force design

Chatter resistant medium to roughing machining range

Cutting force comparison (Internal evaluation)

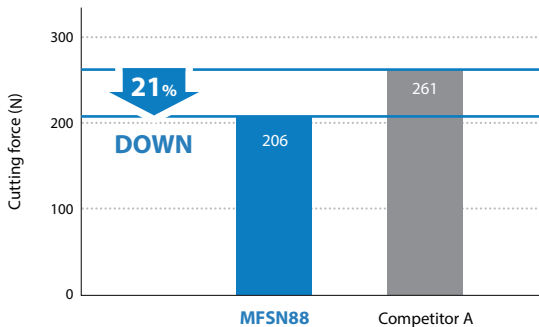

Cutting force is thrust force

3 Extended tool life by MEGACOAT NANO

Insert grade and chipbreaker lineup for various machining application



1st Recommendation (General purpose) GM chipbreaker



Tough edge GH chipbreaker



For stainless steel SM chipbreaker

Cutting conditions: Vc = 200 m/min, ap = 3mm, fz = 0.15mm/t
Cutter dia. ø63: Workpiece material: C50

MFSN88

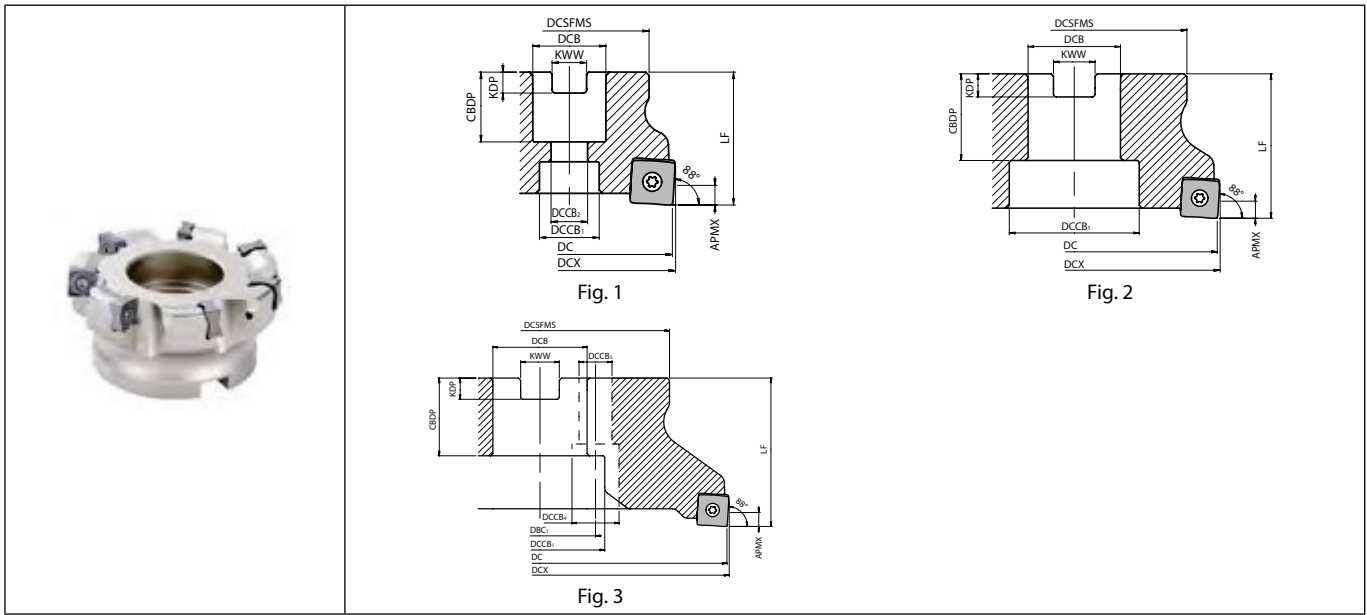

Toolholder dimensions

Description		Availability	Dimension (mm)													A.R. max. (°)	R.R. (°)	Coolant hole	Weight (kg)	Fig.	Applicable inserts M126			
			Inserts																					
			R	DC	DCX	DCSFMS	DCB	DCCB1	DCCB2	DCCB3	DCCB4	DBG	LF	CBDP	KDP							KWW		
Metric	Fine pitch	MFSN 88050R-4T-M-G	●	4	50	52	48	22	17.5	11					40	21	6.3	10.4	+10	-12	No	0.3	1	SNMU1305...
		MFSN 88063R-5T-M-G	●	5	63	65			18						50	24	7	12.4		-10		0.4	1	
		MFSN 88080R-6T-M-G	●	6	80	82	70	27	20	13	-	-	-		50	24	7	12.4		-9		1.1	1	
		MFSN 88100R-7T-M-G	●	7	100	102	78	32	45						30	8	8	14.4		-8		1.4	2	
		MFSN 88125R-9T-M-G	●	9	125	127	89	40	55	-					63	33	9	16.4		-7.5		2.4	2	
		MFSN 88160R-11T-M-G	●	11	160	162	110				14	20	66.7		63	33	9	16.4		-7.5		4.2	3	
Metric	Extra fine pitch	MFSN 88050R-5T-M-G	●	5	50	52	48	22	17.5	11				40	21	6.3	10.4	+10	-12	No	0.3	1	SNMU1305...	
		MFSN 88063R-7T-M-G	●	7	63	65			18					50	24	7	12.4		-10		0.4	1		
		MFSN 88080R-9T-M-G	●	9	80	82	70	27	20	13	-	-	-		50	24	7	12.4		-9		1.1		1
		MFSN 88100R-11T-M-G	●	11	100	102	78	32	45						30	8	8	14.4		-8		1.4		2
		MFSN 88125R-13T-M-G	●	13	125	127	89	40	55	-					63	33	9	16.4		-7.5		2.5		2
		MFSN 88160R-15T-M-G	●	15	160	162	110				14	20	66.7		63	33	9	16.4		-7		4.3		3
Bore dia. inch spec	Fine pitch	MFSN 88080R-6T-G	□	6	80	82	70	25.4	20	13				50	27	6	9.5	+10	-9	No	1.1	1	SNMU1305...	
		MFSN 88100R-7T-G	□	7	100	102	78	31.75	45					34	8	8	12.7		-8		1.5	2		
		MFSN 88125R-9T-G	□	9	125	127	89	38.1	55	-	-	-		63	38	10	15.9		-7.5		2.5	2		
		MFSN 88160R-11T-G	□	11	160	162	110	50.8	70					63	38	11	19.1		-7		4.1	2		
	Extra fine pitch	MFSN 88080R-9T-G	□	9	80	82	70	25.4	20	13				50	27	6	9.5	+10	-9	No	1.1	1	SNMU1305...	
		MFSN 88100R-11T-G	□	11	100	102	78	31.75	45					34	8	8	12.7		-8		1.5	2		
Extra fine pitch	MFSN 88125R-13T-G	□	13	125	127	89	38.1	55	-	-	-		63	38	10	15.9	+10	-7.5		2.6	2			
	MFSN 88160R-15T-G	□	15	160	162	110	50.8	70					63	38	11	19.1		-7		4.3	2			





APMX : 5 mm (GM, SM, GH Chipbreakers, Coated cabide), 3 mm (GM Chipbreaker, Cermet)

● : Standard item R : Right-hand only L : Left-hand only □ : Check availability



Milling

Spare parts (common to Metric / Inch spec)

Description		Clamp screw	Wrench	Anti-seize compound	Mounting bolt
					
Fine pitch	MFSN 88050R-4T-M-G	SB-4090TRP	DTPM-15	P-37	HH10X30
	88063R-5T-M-G				HH10X30
	88080R-6T(-M)-G				HH12X35
	88100R-7T(-M)-G				-
	88125R-9T(-M)-G				-
	88160R-11T(-M)-G				-
<div style="border: 1px solid black; padding: 2px; text-align: center;">Recommended tightening torque for insert clamp 3.5N·m</div>					
Extra fine pitch	MFSN 88050R-5T-M-G	SB-4090TRP	DTPM-15	P-37	HH10X30
	88063R-7T-M-G				HH10X30
	88080R-9T(-M)-G				HH12X35
	88100R-11T(-M)-G				-
	88125R-13T(-M)-G				-
	88160R-15T(-M)-G				-
<div style="border: 1px solid black; padding: 2px; text-align: center;">Recommended tightening torque for insert clamp 3.5N·m</div>					

 Coat anti-seize compound thinly on portion of taper and thread when insert is fixed.



- Cutting edge angle 45°~70°
- Cutting edge angle 75°
- Cutting edge angle 88°/90°
- Cutter for Finishing
- High Feed Cutter
- Multi-Function
- Slot Mill
- Ball-nose Radius
- Others

MFSN88

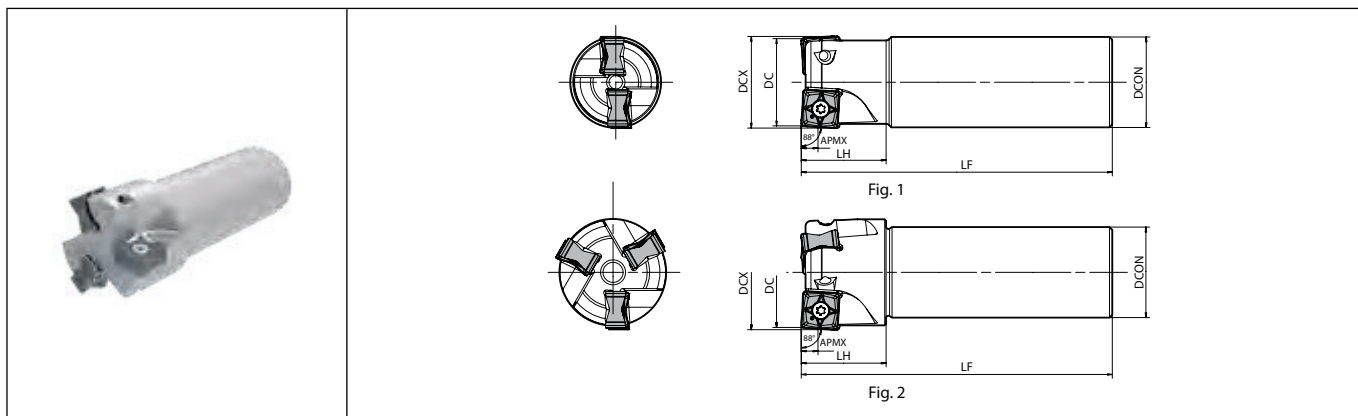

Toolholder dimensions

Description	Availability	Inserts	Dimension (mm)						A.R. max. (°)	R.R. (°)	Coolant hole	Fig.	Spare parts			Applicable inserts M126
			DC	DCX	DCON	LF	LH	Screw					Wrench	Anti-seize compound		
			R													
MFSN 88032R-S32-2T-G	●	2	32	34	32	110	30	+10	-15.5	No	1				SNMU1305...	
88040R-S32-3T-G	●	3	40	42	32	110	30	-13	No	2	SB-4090TRP	DTPM-15	P-37			

APMX : 5 mm (GM, SM, GH Chipbreakers, Coated cabide), 3 mm (GM Chipbreaker, Cermet)

Coat Anti-seize Compound thinly on portion of taper and thread when insert is fixed.

Recommended tightening torque for insert clamp : 3.5N·m



Milling

SNMU

Insert		Description	Dimension (mm)					Carbide				Applicable toolholder M123 M125	
			IC	S	D1	RE	BS	PVD			Cermet		
								PR015S	PR1510	PR1525			PR1535
		SNMU 130508EN-GM General purpose	13	5.51	4.7	0.8	1	●	●	●	●	●	MFSN88...
		SNMU 130508EN-SM Low cutting force	13	5.51	4.7	0.8	1	●	●	●			MFSN88...
		SNMU 130508EN-GH Tough edge	13	5.51	4.7	0.8	1	●	●	●	●		MFSN88...

Recommended cutting conditions M127

Classification of usage

- ★ : Roughing / 1st Choice
- ☆ : Roughing / 2nd Choice
- : Finishing / 1st Choice
- : Finishing / 2nd Choice
- (In case hardness is 45HRC or under)

Carbon steel / Alloy steel	★	☆	■	P
Mold and die steel	★	☆	■	
Austenitic stainless steel	☆	★		M
Martensitic stainless steel		★		
Precipitation hardening stainless steel		★		
Gray cast iron	★			K
Nodular cast iron	★			
Non-ferrous metals				N
Heat-resistant alloy			★	S
Titanium alloy			★	
Hard materials	★			H

M



Milling

Cutting edge angle 45°~70°
Cutting edge angle 75°
Cutting edge angle 88°/90°
Cutter for Finishing
High Feed Cutter
Multi- Function
Slot Mill
Ball-nose Radius
Others

● : Standard item R : Right-hand only L : Left-hand only □ : Check availability

M126

Recommended cutting conditions

Coated carbide

Chipbreaker	Workpiece material	Feed (fz: mm/t)	Recommended insert grades (Vc: m/min)			
			MEGACOAT (PVD Coated carbide)			
			PR1535	PR1525	PR1510	PR0155
GM	Carbon steel	0.1~ 0.2 ~0.3	☆ 120~ 180 ~250	★ 120~ 180 ~250	-	-
	Alloy steel	0.1~ 0.2 ~0.3	☆ 100~ 160 ~220	★ 100~ 160 ~220	-	-
	Mold steel	0.1~ 0.15 ~0.25	★ 80~ 140 ~180	★ 80~ 140 ~180	-	-
	Stainless steel (Austenitic related)	0.1~ 0.15 ~0.25	☆ 100~ 150 ~200	☆ 100~ 150 ~200	-	-
	Stainless steel (Martensitic related)	0.1~ 0.15 ~0.25	☆ 100~ 150 ~200	-	-	-
	Stainless steel (Precipitation hardening)	0.1~ 0.15 ~0.25	★ 90~ 120 ~150	-	-	-
	Gray cast iron	0.1~ 0.2 ~0.3	-	-	★ 120~ 180 ~250	-
	Nodular cast iron	0.1~ 0.15 ~0.25	-	-	★ 100~ 150 ~200	-
	Ni-base heat-resistant alloys	0.1~ 0.12 ~0.2	☆ 20~ 30 ~50	-	-	-
SM	Carbon steel	0.06~ 0.12 ~0.2	-	☆ 120~ 180 ~250	-	-
	Alloy steel	0.06~ 0.12 ~0.2	-	☆ 100~ 160 ~220	-	-
	Mold steel	0.06~ 0.08 ~0.15	-	☆ 80~ 140 ~180	-	-
	Stainless steel (Austenitic related)	0.06~ 0.12 ~0.2	★ 100~ 150 ~200	☆ 100~ 150 ~200	-	-
	Stainless steel (Martensitic related)	0.06~ 0.12 ~0.2	★ 100~ 150 ~200	-	-	-
	Stainless steel (Precipitation hardening)	0.06~ 0.12 ~0.2	☆ 90~ 120 ~150	-	-	-
	Gray cast iron	0.06~ 0.12 ~0.2	-	-	☆ 120~ 180 ~250	-
	Nodular cast iron	0.06~ 0.1 ~0.15	-	-	☆ 100~ 150 ~200	-
	Ni-base heat-resistant alloys	0.06~ 0.08 ~0.15	★ 20~ 30 ~50	-	-	-
GH	Titanium alloys	0.06~ 0.08 ~0.15	★ 40~ 60 ~80	-	-	-
	Carbon steel	0.15~ 0.25 ~0.35	-	☆ 120~ 180 ~250	-	-
	Alloy steel	0.15~ 0.25 ~0.35	-	☆ 100~ 160 ~220	-	-
	Mold steel	0.1~ 0.2 ~0.3	-	☆ 80~ 140 ~180	-	-
	Gray cast iron	0.15~ 0.25 ~0.35	-	-	☆ 120~ 180 ~250	-
	Nodular cast iron	0.1~ 0.2 ~0.3	-	-	☆ 100~ 150 ~200	-
	Hard materials (60HRC or less)	0.1~ 0.2 ~0.3	-	-	-	★ 50~ 80 ~100

* The bold-faced number indicates a center value of recommended cutting condition.
Adjust the cutting speed and the feed rate within the above conditions according to the actual machining situation.
* Machining with coolant is recommended for Ni-base heat-resistant alloys and titanium alloys.

★ : 1st Recommendation
☆ : 2nd Recommendation

Cermet

Chipbreaker	Workpiece material	Feed (fz: mm/t)	Recommended insert grades (Vc: m/min)
			Cermet TN620M
GM	Carbon steel	0.06~ 0.12 ~0.15	★ 200~ 250 ~300
	Alloy steel	0.06~ 0.12 ~0.15	★ 180~ 220 ~250
	Mold steel	0.06~ 0.1 ~0.13	★ 150~ 180 ~220

★ : 1st Recommendation

Applicable chipbreaker range

Coated carbide

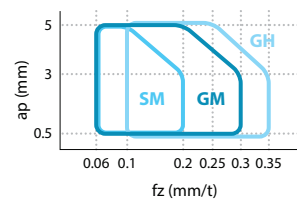

Cermet

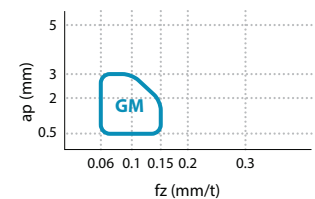

Applicable chipbreaker

Cutter type	Chipbreaker		
	GM	SM	GH
Fine pitch	✓	✓	✓
Extra fine pitch	✓	✓	△ (Feed rate is recommended fz=0.2mm/t or under)

Not available for vertical milling (plunging).

Reference data of Over Machined Radius Portion

ap	1 mm	2 mm	3 mm	4 mm	5 mm
Over Machined Radius Portion	0.12 mm	0.24 mm	0.27 mm	0.31 mm	0.34 mm

Over machined radius portion to 90°cutter

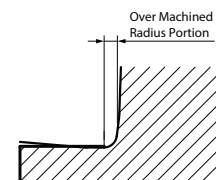

Milling

Face mills for heavy milling

MFLN

Tough 4-edge tangential inserts provide high reliability on heavy milling at large depths of cut and high feed rates.

Three cutting edge angles (incl. MFLN45 and MFLN70) optimized for various machining applications.

1 Tough and reliable inserts for stable heavy milling

22 mm long inserts offer increased rigidity

Tangentially mounted inserts provide
2 cutting edges on both sides

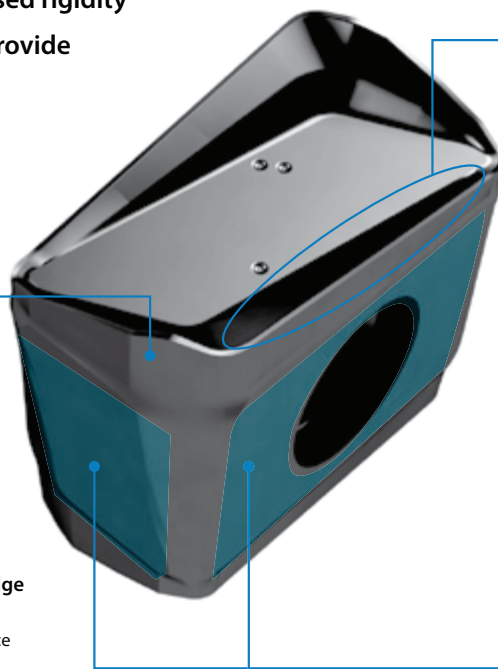

Obtuse edge design

Increases the cutting edge angle only at the tip to maintain both strength and sharpness

Cross-section view of cutting edge

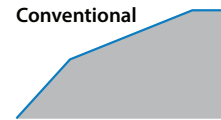
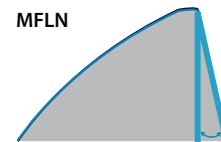

Corner chamfer

only available on MFLN90

Both general corner-R type and chamfered corner type available
Prevents chattering and insert fracturing

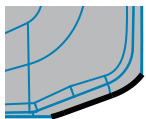

Convex cutting edge ridge
Reduced impact forces when entering the workpiece



Wide flat mounting surface

Hold an insert firmly in heavy milling

M



Milling

Cutting edge angle 45°~70°

Cutting edge angle 75°

Cutting edge angle 88°/90°

Cutter for Finishing

High Feed Cutter

Multi-Function

Slot Mill

Ball-nose Radius

Others

Tangentially mounted inserts increase rigidity

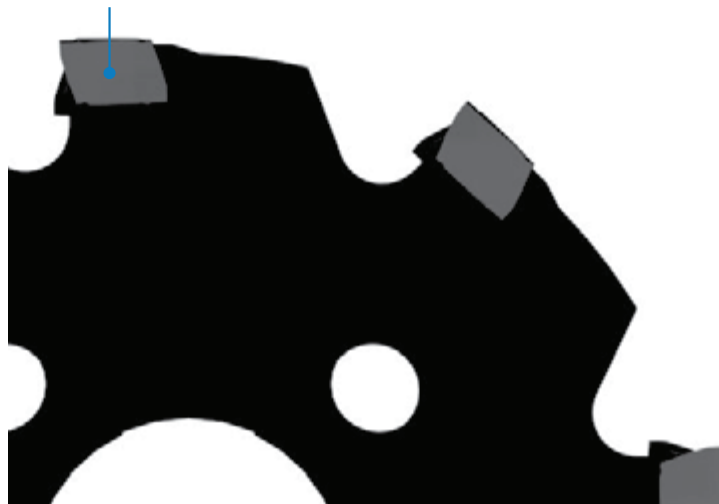

Cutting forces when entering the workpiece (internal evaluation)

MFLN90: Insert - chamfered corner type

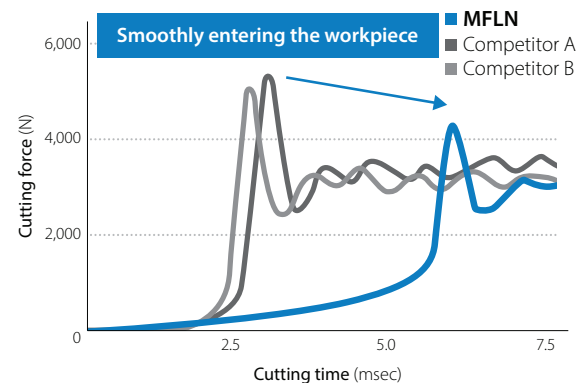

Cutting conditions: Vc = 150 m/min, ap x ae = 5 x 75 mm, fz = 0.3 mm/t ø125 (1 insert), dry, workpiece: C50

2 Large D.O.C. and high feed rates

MFLN90
Cutting edge angle 90°

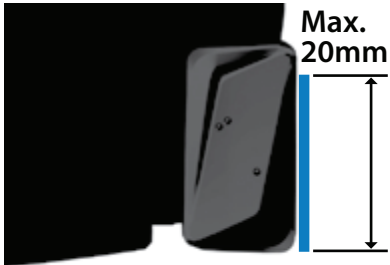

Applicable range

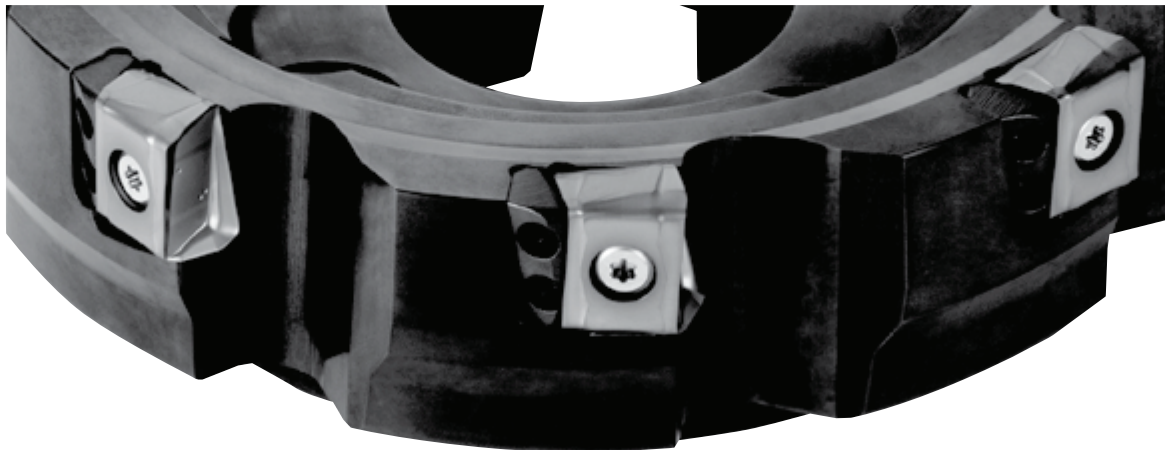
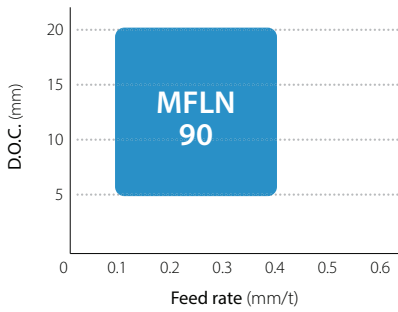

Chip comparison (Internal evaluation)

Helix-shaped chips prevent chip recutting and provide stable machining at high feed rates.

MFLN90	Stable	Competitor A	Unstable	Competitor B	Unstable
fz = 0.3 mm/t	fz = 0.4 mm/t	fz = 0.3 mm/t	fz = 0.4 mm/t	fz = 0.3 mm/t	fz = 0.4 mm/t

MFLN90

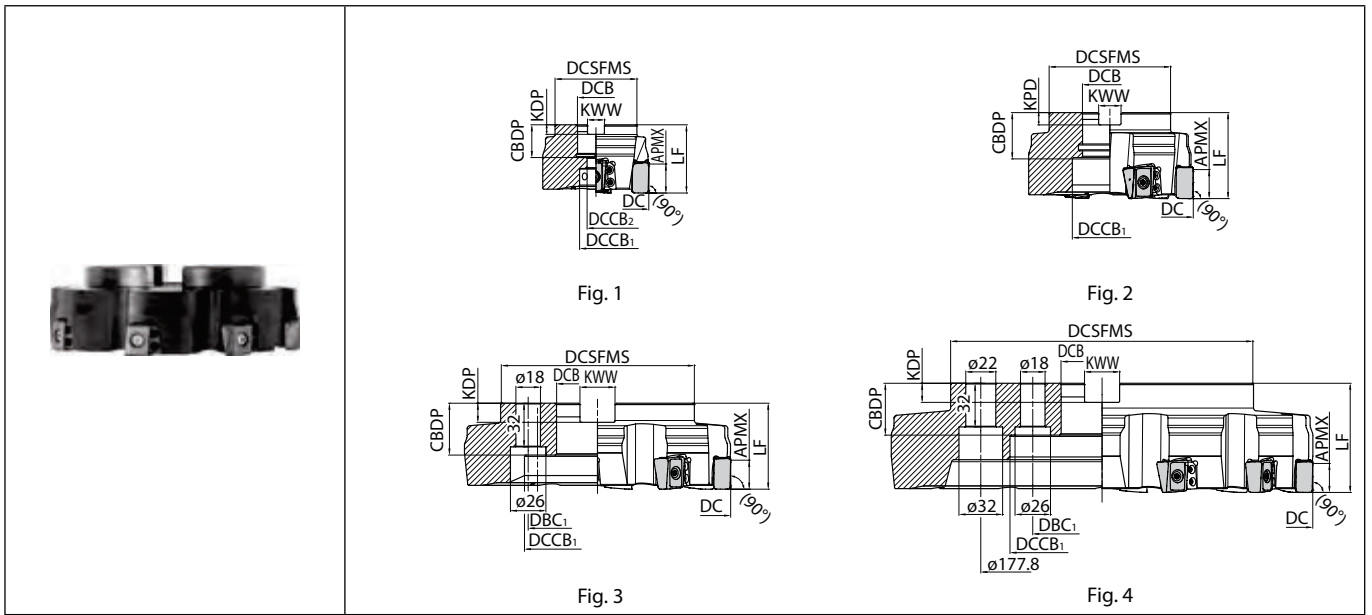

Toolholder dimensions

Description	Availability	Inserts	Dimension (mm)											A.R. max. (°)	R.R. (°)	Coolant hole	Max. revolution (min ⁻¹)	Weight (kg)	Fig.	Applicable inserts M131		
			R	DC	DCSFMS	DCB	DCCB ₁	DCCB ₂	DBG	LF	CDBP	KDP	KWW								APMX	
																						24
Metric	●	4	80	60	27	24	13	-	50	24	7	12.4	+4.5	-16.5	Yes	5970	1	1	LOGU221616ER-GM LOGU2216PAER-GM			
		6	125	89	40	55	-	66.7	33	9	16.4	-14.5								3820	2.9	2
		7	160	110	90	63	38	14	25.7	-13	2990											
		8	200	142	132	101.6	80	14	25.7			No								2390	6.9	3
		10	250	60	172	101.6	80	14	25.4	-13	1910											
		12	315	222	205	80	1520	20.9	4													
Bore dia. inch spec	□	4	80	60	25.4	24	13	-	50	27	6	9.5	+4.5	-16.5	Yes	5970	1	1	LOGU221616ER-GM LOGU2216PAER-GM			
		6	125	89	38.1	55	-	63	10	15.9	-14.5	3820								3	2	
		7	160	110	50.8	90	63	11	19.1	No												2990
		8	200	142	132	101.6	80	14	25.4		-13	2390								7.2	3	
		10	250	47.625	172	101.6	80	14	25.4	No												1910
		12	315	222	205	80	1520	21.8	4													

Coat Anti-seize Compound thinly on portion of taper and thread when insert is fixed.

Spare parts

Description	Parts						
	Clamp screw	Wrench	Shim	Clamp screw	Wrench	Coat anti-seize compound	Arbor bolt
MFLN ○○080R-4T(-M)							HH12X35
○○100R-4T(-M) ~ ○○315R-12T(-M)	SB-60200TRP	TTP-20	MAP-2216	SB-40140TR	DTM-15	P-37	-
	Tightening torque for clamping insert 6.0 N·m			Tightening torque for clamping shim 3.5 N·m			

● : Standard item R : Right-hand only L : Left-hand only □ : Check availability

M130

M

Milling

Cutting edge angle 45°~70°

Cutting edge angle 75°

Cutting edge angle 88°/90°

Cutter for Finishing

High Feed Cutter

Multi-Function

Slot Mill

Ball-nose Radius

Others

LOGU

Insert		Description	Dimension (mm)						Carbide	Applicable toolholder M130 M34 M35
			S	D1	RE	W1	INSL	BS	PVD	
			PR1525		PR1535					
Classification of usage ★: Roughing / 1st Choice ☆: Roughing / 2nd Choice ■: Finishing / 1st Choice □: Finishing / 2nd Choice (In case hardness is 45HRC or under)			Carbon steel / Alloy steel	★	☆			P		
			Mold and die steel	★	☆			P		
			Austenitic stainless steel					M		
			Martensitic stainless steel					M		
			Precipitation hardening stainless steel					M		
			Gray cast iron	★	☆			K		
			Nodular cast iron	★	☆			K		
			Non-ferrous metals					N		
			Heat-resistant alloy					S		
			Titanium alloy					S		
			Hard materials					H		
		LOGU 221616ER-GM	16.6	6.8	1.6	12.5	22.8	6.3	● ●	MFLN90... MFLN45... MFLN70...
		LOGU 2216PAER-GM	16.9	6.8	-	12.5	22.8	4.8	● ●	MFLN90...

Recommended cutting conditions M132

About applicable insert

	LOGU221616ER-GM (Corner-R)	LOGU2216PWER-GM (Corner chamfer)
MFLN 90	✓	✓

●: Standard item R: Right-hand only L: Left-hand only □: Check availability



Recommended cutting conditions

	Workpiece	D.O.C. (mm)		fz: mm/t	Recommended insert grades (Vc: m/min)	
		Width of cut ≤0.5×DC	Width of cut >0.5×DC		MEGACOAT NANO	
					PR1535	PR1525
MFLN 90	Carbon steel	~18	~15	0.1 – 0.2 – 0.4	☆ 80 – 120 – 150	★ 100 – 150 – 180
	Alloy steel				☆ 80 – 120 – 150	★ 100 – 150 – 180
	Mold steel				☆ 70 – 100 – 120	★ 80 – 120 – 150
	Gray cast iron	~20	~18	0.1 – 0.2 – 0.4	☆ 80 – 120 – 150	★ 100 – 150 – 180
	Nodular cast iron				☆ 80 – 120 – 150	★ 100 – 150 – 180

The table above provides recommendations based on product specifications.
Before using the product, check the machine's specifications such as power.

★ : 1st recommendation ☆ : 2nd recommendation

The number in bold font is recommended starting conditions. Adjust the cutting speed and the feed rate within the above conditions according to the actual machining situation.
Dry machining is recommended.

M



Milling

Cutting edge angle
45°~70°Cutting edge angle
75°Cutting edge angle
88°/90°Cutter for
FinishingHigh Feed
CutterMulti-
Function

Slot Mill

Ball-nose
Radius

Others

How to mount an insert

1. Completely eliminate chips and dust from the insert mounting side.
2. After mounting a clamp screw on the top edge of wrench, tighten the screw while keeping the insert pushed against the shim seat surface and holder surface (Fig.1,2)
3. Make sure that the identification on the top of the insert is the same in each pocket.(Fig.3)
4. Tighten the wrench (TTP-20) in while holding parallel to the clamp screw.
5. Tighten the insert clamp screw at an appropriate torque. (Recommended torque: 6.0 N·m)
6. After tightening, check that there is no gap between the insert and the surface of the shim, or between the side surface of insert and the holder surface. If there is a gap, remount the insert using the directions above.

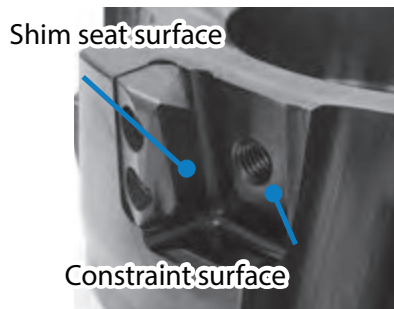

Fig.1

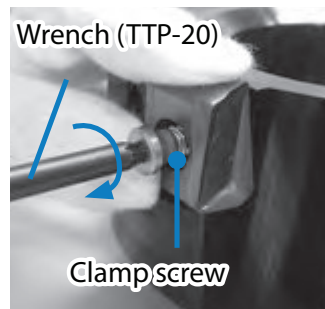

Fig.2



Fig.3

How to replace a shim

1. Completely eliminate chips and dust from the shim mounting side.
2. Coat medium strength screw locking adhesive on the screws.
3. Tighten the screw keeping the shim pushed against the pocket surface of toolholder.
4. After tightening both screws temporarily, tighten them with appropriate torque. (Recommended torque:3.5 N·m)
5. Please check that there is no gap between the shim and the pocket surfaces of toolholder.



Fig.1

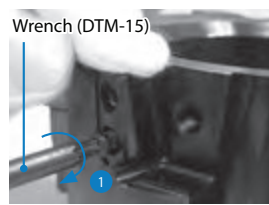

Fig.2

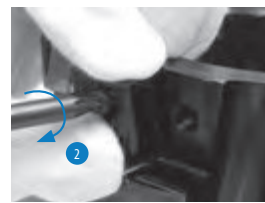

Fig.3



Fig.4

M



Milling

Face mill for heavy milling MSRS90

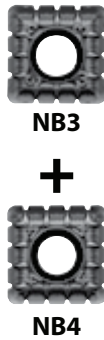
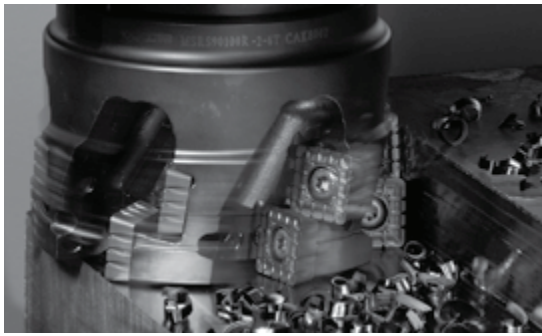

Wide selection of cutting edge length according to cutting conditions

4-stage type (ø80, ø100) is added to the standard lineup as well as 1-stage and 2-stage types.

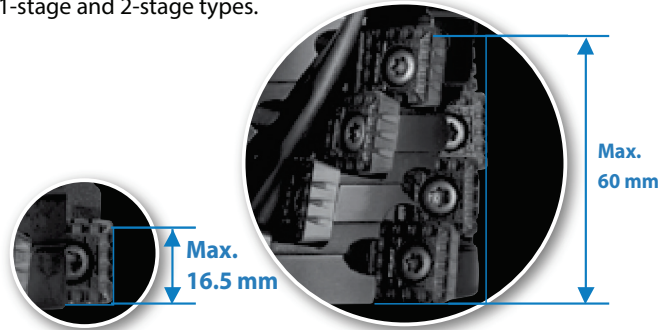

High efficiency, low cutting force and stable machining without chattering
Neutral and corner-R insert

Applicable to shouldering (Cutting edge angle: 90°), high feed milling (Cutting edge angle: 30°), plunging, and side cutter.

Custom-ordered milling cutter with high performance notched neutral inserts provides various applications

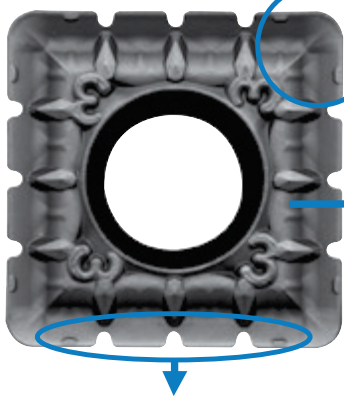

Neutral insert with corner-R is available to various applications

Long tool life: MEGACOAT

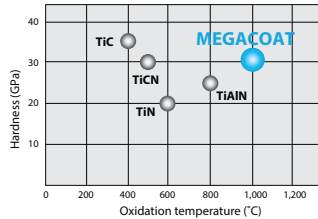

High hardness and high oxidation resistance long tool life: MEGACOAT

Notched insert SPMT180616EN

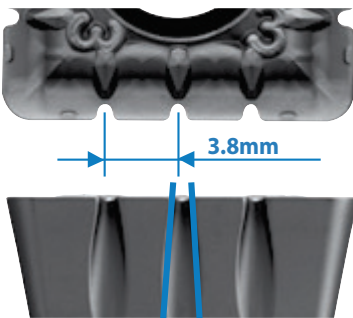

The notched insert breaks chips into small pieces and reduces cutting force. The second land near the cutting edge improves edge strength.

For neutral (Right/Left) hand
Applicable for various cutting edge angle.
Cutting edge length: 18mm

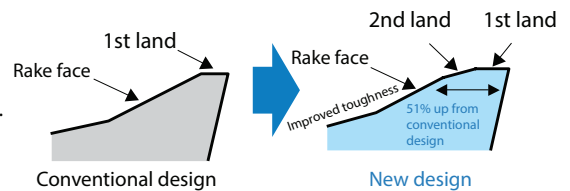

Edge preparation

Low cutting force (Notched insert benefit)

Cutting force comparison (Internal evaluation)

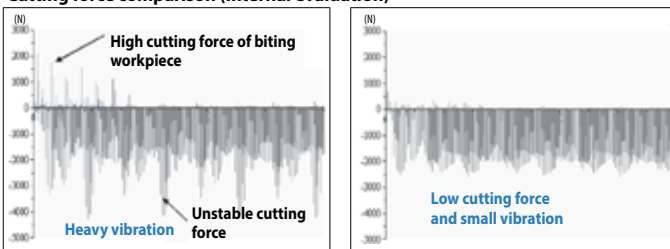

Competitor A







MSRS90

Notched insert realizes lower cutting force and smaller vibration



- Cutting edge angle 45°~70°
- Cutting edge angle 75°
- Cutting edge angle 88°/90°
- Cutter for Finishing
- High Feed Cutter
- Multi-Function
- Slot Mill
- Ball-nose Radius
- Others

Applicable inserts: Available for various applications

Applications	Chipbreaker selection	3-notched		4-notched		Without notch
General purpose	Standard	 NB3	+	 NB4		
Low cutting force	Low cutting force	 NB3P	+	 NB4P		
Edge strength oriented	Without notch (Usable with notched inserts)	( NB3	or	( NB4)	+ 

Various expansive possibilities (Custom-ordered and standard milling cutter)

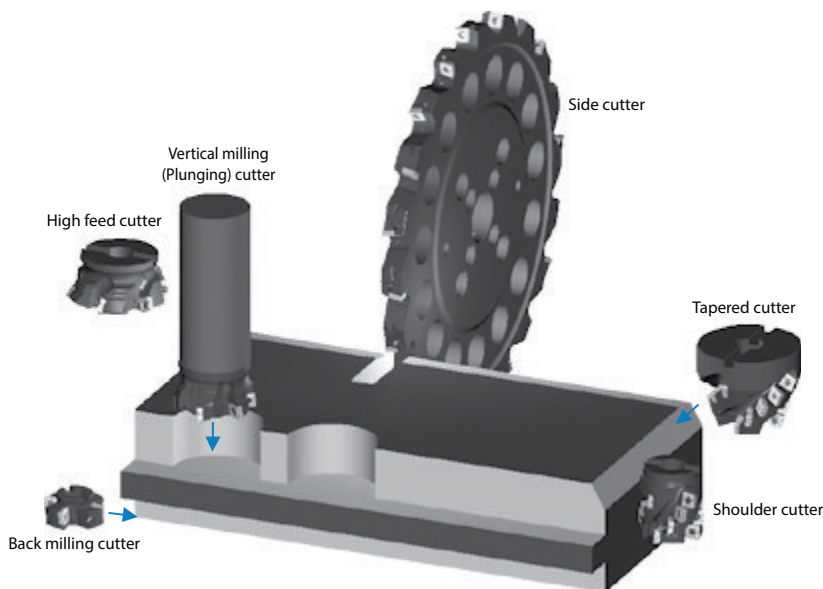

The custom-ordered milling cutter can be customized for your requirements such as diameter, Cutting edge angle, number of insert stages.



Milling

Shaft length determination

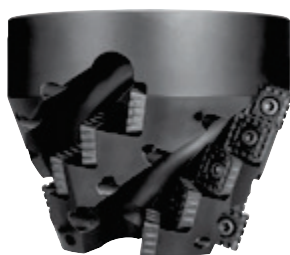

Tapered cutter



Vertical milling (Plunging) cutter



45° Face mill



High feed cutter



Shoulder cutter

MSRS90

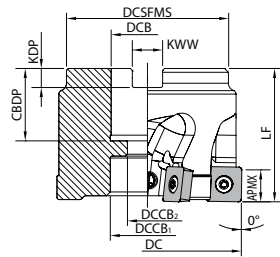

Fig. 1

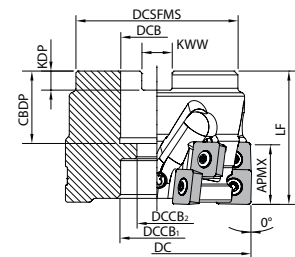

Fig. 2

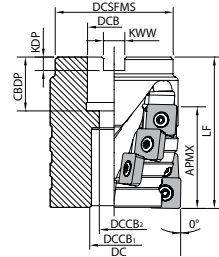

Fig. 3

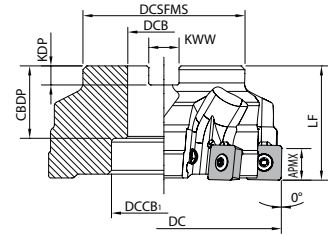

Fig. 4

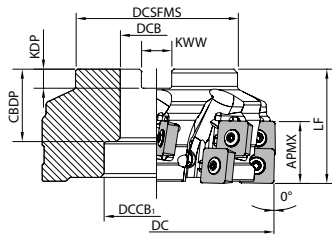

Fig. 5

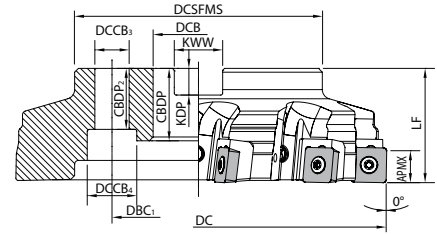

Fig. 6

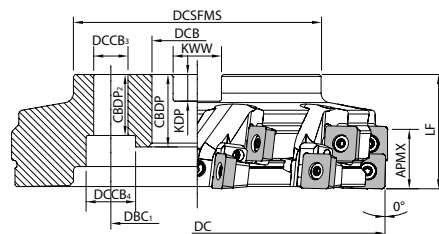

Fig. 7

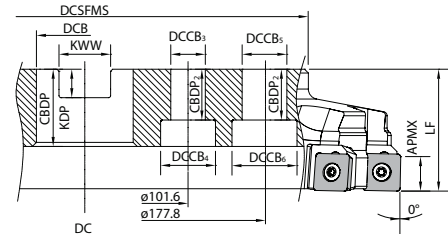

Fig. 8

M



Milling

Cutting edge angle
45°~70°

Cutting edge angle
75°

Cutting edge angle
88°/90°

Cutter for
Finishing

High Feed
Cutter

Multi-
Function







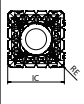

Slot Mill

Ball-nose
Radius

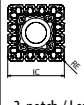
Others

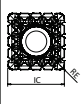
SPMT

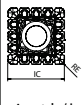
Insert		Description	No. of edges	Dimension (mm)					Angle (°)	Carbide		Applicable toolholder ➔ M137
				IC	S	D1	RE	AN		PVD		
										PR1210	PR1230	
Classification of usage ★: Roughing / 1st Choice ☆: Roughing / 2nd Choice ■: Finishing / 1st Choice □: Finishing / 2nd Choice (In case hardness is 45HRC or under)								★		P		
								★		M		
								★		K		
										N		
								★		S		
								★		H		
									□			

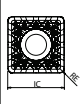
		SPMT 180616EN-NB3	4	18	6.35	6.8	1.6	11	●	●	MSRS90...
		SPMT 180616EN-NB3P	4	18	6.35	6.8	1.6	11	●	●	MSRS90...
		SPMT 180616EN-NB4	4	18	6.35	6.8	1.6	11	●	●	MSRS90...
		SPMT 180616EN-NB4P	4	18	6.35	6.8	1.6	11	●	●	MSRS90...
		SPMT 180616EN-V	4	18	6.35	6.8	1.6	11	●	●	MSRS90...

Recommended cutting conditions ➔ M139

M

Milling

Cutting edge angle 45°~70°

Cutting edge angle 75°

Cutting edge angle 88°/90°

Cutter for Finishing

High Feed Cutter

Multi-Function

Slot Mill

Ball-nose Radius

Others

●: Standard item R: Right-hand only L: Left-hand only □: Check availability

M138

Caution when installing notched insert

It is important to install the appropriate notched insert into the correct position. If it is installed in incorrect position, the tool cannot cut the workpiece and it may damage the toolholder body. For MSRS90, notched insert location indicator is marked at insert installed pocket of the cutter body.

When installing the inserts, match the number on the top surface of insert to the number of the cutter body.

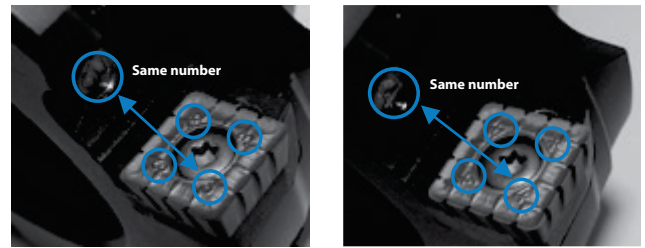

Description	No. of inserts	No. of flutes	No. of stages	No. of inserts	
				Notched	
				NB3(P)	NB4(P)
MSRS 90100R-1-6T	6	6	1	3	3
90100R-2-6T	12		2	6	6
90100R-4-6T	24		4	12	12

Spare parts

Description	Spare parts								
	Clamp screw	Wrench	Cartridge		Clamp screw	Wrench	Anti-seize compound	Mounting bolt	
			MAP-1806M	MAP-1806S (Bottom edge only)					
Without cartridge MSRS 90080R-○-4T-M 90100R-○-6T-M 90125R-○-8T-M	SB-60120TR	TT-25L	-	-	-	-	P-37	HH12X35	
With cartridge MSRS 90160R-○-8T-M ? 90315R-○-14T-M			MAP-1806M*1	MAP-1806S*2	SB-40140TR	DT-15		-	
Recommended tightening torque for cartridge clamp 3.5N·m									
Without cartridge MSRS 90080R-○-4T 90100R-○-6T 90125R-○-8T			Recommended tightening torque for insert clamp 7.5N·m		-	-		-	-
With cartridge MSRS 90160R-○-8T ? 90315R-○-14T			MAP-1806M*1	MAP-1806S*2	SB-40140TR	DT-15	-	-	
Recommended tightening torque for cartridge clamp 3.5N·m									

Notes: *1: MAP-1806M is only for the bottom edge (1st stage) of MSRS90.R-1.
 *2: MAP-1806S is only for the bottom edge (1st stage) of MSRS90.R-2... Use it only for the bottom edge (1st stage).
 How to attach the cartridge: You need to tighten 2 clamp screws to fix the cartridge. Tighten the slant screw first and then tighten the other screw.

Coat anti-seize compound thinly on portion of taper and thread when insert is fixed.

Recommended cutting conditions

Workpiece material	fz (mm/t)		Vc (m/min)	
	Standard NB3+NB4	Low cutting force NB3P+NB4P	MEGACOAT	
			PR1230	PR1210
Soft steel	0.1~0.2~0.25	0.1~0.2~0.25	★ 120~150~220	☆ 120~150~220
Carbon steel	0.1~0.2~0.25	0.1~0.2~0.25	★ 100~150~200	☆ 100~150~200
Alloy steel	0.1~0.15~0.2	0.1~0.15~0.2	★ 100~150~200	☆ 100~150~200
Mold steel	0.1~0.15~0.2	0.1~0.12~0.15	★ 100~150~180	☆ 100~150~180
Gray cast iron	0.1~0.2~0.3	0.1~0.2~0.25	☆ 100~180~250	★ 100~180~250
Nodular cast iron	0.1~0.2~0.25	0.1~0.18~0.2	☆ 100~180~220	★ 100~180~220
Stainless steel	Not recommended			
Aluminum/Copper	Not recommended			

★: 1st Recommendation ☆: 2nd Recommendation



Cutting conditions (Shouldering)

In case of MSRS90100R-1-6T

Workpiece material	Overhang length LPR(mm)	Cutting conditions		(ap × ae)	Chip evacuation rate (cc/min)
		Cutting speed Vc (m/min)	Feed fz (mm/t)		
Cast iron	Less than 120mm	180	0.2	15 × 80	826
	120~200mm	180	0.2	15 × 40	413
	201mm and over	230	0.1	15 × 40	263
Carbon steel	Less than 120mm	150	0.2	15 × 80	689
	120~200mm	150	0.2	15 × 40	344
	201mm and over	200	0.1	15 × 40	229

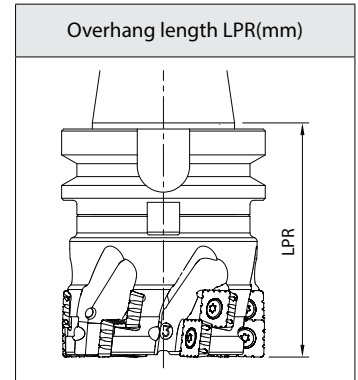

In case of MSRS90100R-2-6T

Workpiece material	Overhang length LPR(mm)	Cutting conditions		(ap × ae)	Chip evacuation rate (cc/min)
		Cutting speed Vc (m/min)	Feed fz (mm/t)		
Cast iron	Less than 120mm	180	0.2	30 × 50	1,032
	120~200mm	180	0.2	30 × 30	619
	201mm and over	230	0.1	30 × 25	329
Carbon steel	Less than 120mm	150	0.2	30 × 50	861
	120~200mm	150	0.2	30 × 30	517
	201mm and over	200	0.1	30 × 25	287

In case of MSRS90100R-4-6T

Workpiece material	Overhang length LPR(mm)	Cutting conditions		(ap × ae)	Chip evacuation rate (cc/min)
		Cutting speed Vc (m/min)	Feed fz (mm/t)		
Cast iron	Less than 140mm	180	0.2	60 × 20	826
	140~200mm	180	0.2	60 × 10	413
	201mm and over	230	0.1	60 × 10	263
Carbon steel	Less than 140mm	150	0.2	60 × 20	689
	140~200mm	150	0.2	60 × 10	344
	201mm and over	200	0.1	60 × 10	229

Case studies

Nodular Cast Iron

Industrial parts

- Vc=150m/min
- ap x ae=6 x 65mm
- fz=0.15mm/t (Vf=430mm/min)

MSRS90100R-1-6T(ø100 -6 flutes)
SPMT180616EN-NB3/NB4
(PR1210)

Machined portion

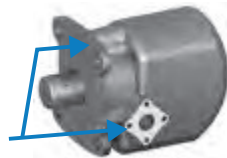

MSRS90(PR1210)

Chip evacuation rate = 258cc/min

Competitor B

107cc/min

- MSRS90 more than doubled the machining efficiency compared with competitor B.
- Competitor B machined with 2 passes (ap x ae=3 x 65mm). MSRS90 machined with only 1 pass.
- Cutting time was reduced. (User evaluation)

20CrM05

Construction machine part

- Vc=200m/min
- ap x ae=10 x 50mm
- fz=0.1mm/t (Vf=400mm/min)

MSRS90125R-1-8T(ø125 -8 flutes)
SPMT180616EN-NB3/NB4
(PR1230)

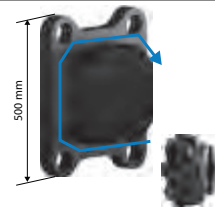

MSRS90(PR1230)

Chip evacuation rate = 200cc/min

Competitor C

153cc/min

- MSRS90 improved the machining efficiency to 1.3 times that of competitor C.
- Competitor C machined with ap x ae=5 x 50mm
- Tool cost is reduced to 1/3 although competitor C is expensive using 2-corner insert.
- MSRS90 reduced machining cost as well as improved machining efficiency. (User evaluation)

Mold steel

Shipbuilding parts

- Vc=150m/min
- ap x ae=10 x 10~50mm
- fz=0.1mm/t (Vf=240mm/min)

MSRS90160R-1-8T(ø160 -8 flutes)
SPMT180616EN-NB3/NB4
(PR1230)

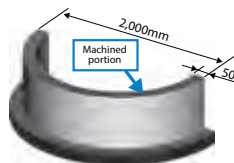

MSRS90(PR1230)

Chip evacuation rate = 120cc/min

Competitor D

60cc/min

- MSRS90 more than doubled the machining efficiency compared with competitor D.
- Competitor D machined with ap x ae=5 x 10~50mm
- Low cutting force of MSRS90 enabled twice as large ap as that of competitor.
- It can double the ap as well as increase the cutting speed (Vc=100 to 150).
- Machining efficiency was improved by MSRS90 (by achieving reduction in cutting time). (User evaluation)

Alloy steel

Power generation parts

- Vc=160m/min
- ap x ae=10 x 0~20mm
- fz=0.15mm/t (Vf=500mm/min)

MSRS90125R-1-8T(ø125 -8 flutes)
SPMT180616EN-NB3/NB4
(PR1230)

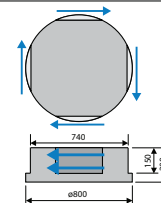

MSRS90(PR1230)

12 surfaces/edge

Competitor E

8 surfaces/edge

- MSRS90 showed 1.5 times longer tool life than that of competitor E.
- Competitor E machined with 2 passes on a side (ap x ae=12 x 0 to 10mm).
- Competitor E was poor in feed rate (Vf=400mm/min). Machining efficiency was improved by MSRS90 (by achieving reduction in cutting time).
- Although competitor E is load due to high cutting force, MSRS90 operates fairly quietly. (User evaluation)

M



Milling

Cutting edge angle 45°~70°

Cutting edge angle 75°

Cutting edge angle 88°/90°

Cutter for Finishing

High Feed Cutter

Multi-Function

Slot Mill

Ball-nose Radius

Others

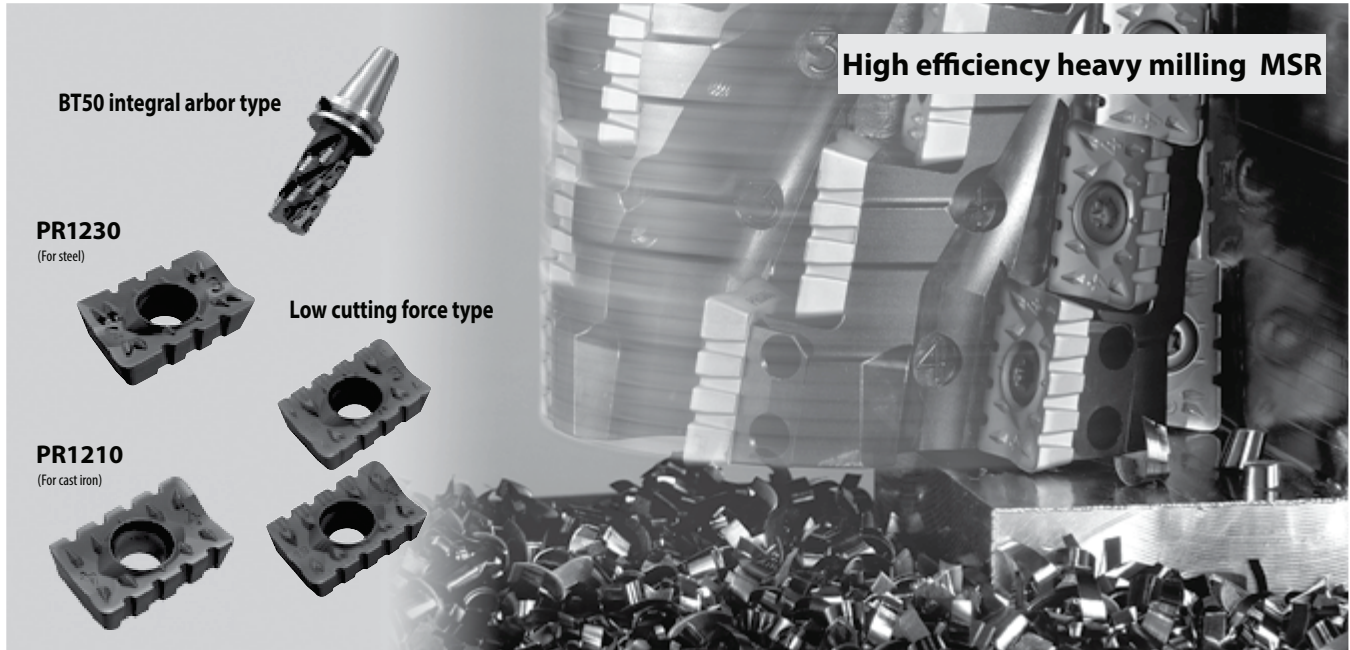

Notched insert reduces cutting force, and enables high feed rates by reducing chattering. Improved chip evacuation and low cutting force with the special chipbreaker. Enables heavy milling and deep cutting, and also drastically improves machining efficiency. (Reduction of cutting time)

Notched insert

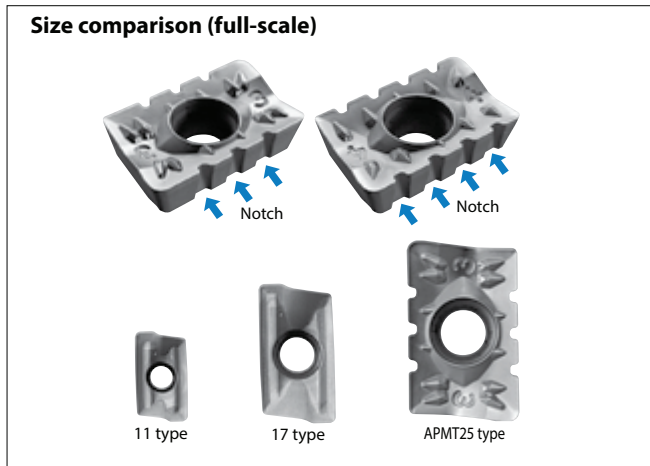

Cutting force comparison

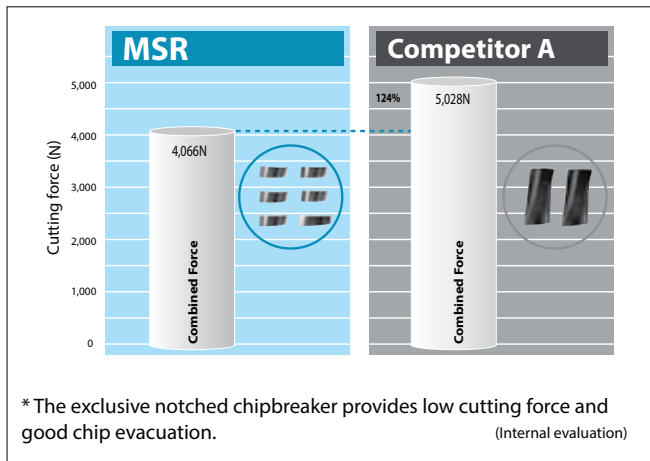

MSR

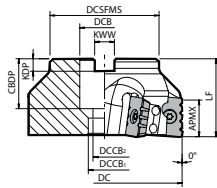

Fig. 1

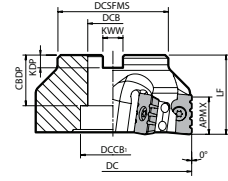

Fig. 2

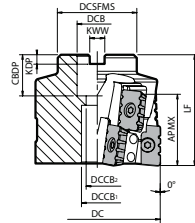

Fig. 3

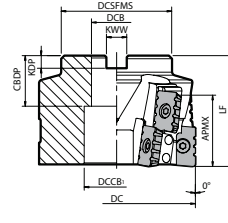

Fig. 4

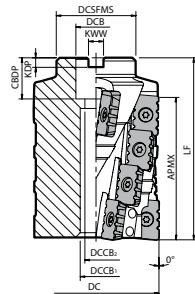

Fig. 5

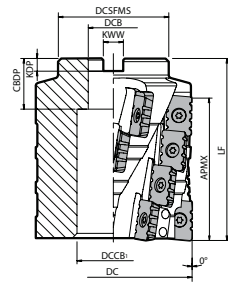

Fig. 6

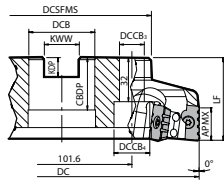

Fig. 7

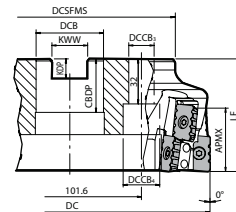

Fig. 8

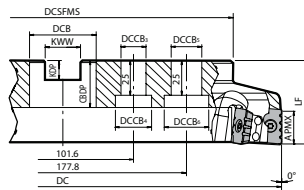

Fig. 9

M



Milling

- Cutting edge angle 45°~70°
- Cutting edge angle 75°
- Cutting edge angle 88°/90°
- Cutter for Finishing
- High Feed Cutter
- Multi-Function
- Slot Mill
- Ball-nose Radius
- Others

MSR

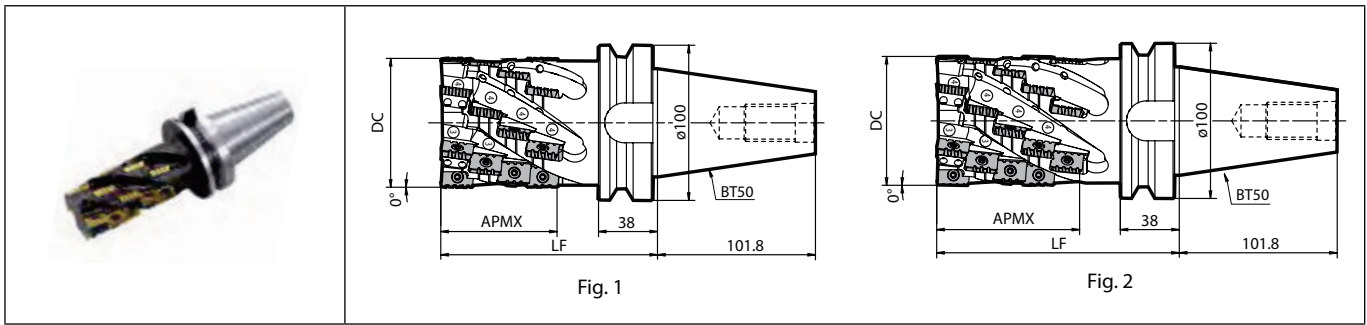

Toolholder dimensions

Description	Availability	Inserts	Flutes	Stages	Dimension (mm)			A.R. (°)	R.R. (°)	Coolant hole	Weight (kg)	Fig.	Spare parts						Applicable inserts M145
					DC	LF	APMX						Anti-seize compound	Cartridge	Screw	Wrench	Screw	Wrench	
MSR 063R-BT50-4	●	16	4	4	160	90	+9	-8	No	5.7	1	P-37	-	-	-	SB-60120TR	TT-25L	APMT2506...	
063R-BT50-5	●	20		5	180	111													6.2
080R-BT50-4	●	16	5	4	160	90	+9	-8	No	6.9	1	P-37	-	-	-	SB-60120TR	TT-25L	APMT2506...	
080R-BT50-5	●	20		5	180	111													7.4
100R-BT50-4	●	24	6	4	160	90	+9	-5	No	9.6	1	P-37	MAP-2506	SB-40140TR	DT-15	SB-60120TR	TT-25L	APMT2506...	
100R-BT50-5	●	30		5	180	111													10.5

Shim is not available for MSR063R (DC=63).

It is not recommended using only top edge part (under ap=30mm) for 4 stages / 5 stages type. If ap is small, use previous page's 1 stage type or 2 stages type.

Deep slotting is not recommended for this cutter.

Coat Anti-seize Compound thinly on portion of taper and thread when insert is fixed.



Milling

Cutting edge angle 45°~70°
Cutting edge angle 75°
Cutting edge angle 88°/90°
Cutter for Finishing
High Feed Cutter
Multi- Function
Slot Mill
Ball-nose Radius
Others

● : Standard item R : Right-hand only L : Left-hand only □ : Check availability

M144

APMT

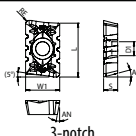
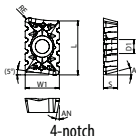
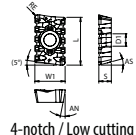
Classification of usage		Carbon steel / Alloy steel		★		P					
		Mold and die steel		★		P					
★: Roughing / 1st Choice ☆: Roughing / 2nd Choice ■: Finishing / 1st Choice □: Finishing / 2nd Choice (In case hardness is 45HRC or under)		Austenitic stainless steel		☆		M					
		Martensitic stainless steel				M					
		Gray cast iron		★		K					
		Nodular cast iron		★		K					
		Non-ferrous metals				N					
		Heat-resistant alloy		★		S					
		Titanium alloy		★		S					
		Hard materials				H					
Insert	Description	No. of edges	Dimension (mm)					Angle (°)		Carbide PVD PR1210 PR1230	Applicable toolholder M143 M144
			S	D1	RE	L	W1	AN	AS		
	APMT 250608ER-NB3 250616ER-NB3 250640ER-NB3	2	6.35	6.5	0.8 1.6 4	25	15.875	11	15	●●	MSR...
	APMT 250616EL-NB3	2	6.35	6.5	1.6	25	15.875	11	15	●●	MSR...
	APMT 250608ER-NB4 250616ER-NB4 250640ER-NB4	2	6.35	6.5	0.8 1.6 4	25	15.875	11	15	●●	MSR...
	APMT 250616EL-NB4	2	6.35	6.5	1.6	25	15.875	11	15	●●	MSR...
	APMT 250616ER-NB3P 3-notch / Low cutting force	2	6.35	6.5	1.6	25	15.875	11	15	●●	MSR...
	APMT 250616ER-NB4P 4-notch / Low cutting force	2	6.35	6.5	1.6	25	15.875	11	15	●●	MSR...

Handed insert shows Right-hand

Recommended cutting conditions M146



Caution when installing notched insert (MSR)

It is important to install the appropriate notched insert into the correct position. If it is installed in incorrect position, the tool cannot cut the workpiece and it may damage the toolholder body. For MSR, notched insert location indicator is marked at insert installed area.

Please bear the following in mind when installing inserts to toolholders.

(Indication is marked near the insert pocket for MSR.)

- (3) is for APMT2506○ER-NB3
- (4) is for APMT2506○ER-NB4

(No. of inserts – example)

Description	No. of inserts	No. of flutes	No. of inserts	
			Notched	
			NB3	NB4
MSR 100R-1	6	6	3	3
100R-2	12		6	6
100R-4	24		12	12

Caution when installing the insert with corner-R(RE) 4.0

When using inserts with corner-R(RE) 4.0mm, additional modifications of the cutter body will be necessary. Ref. to the table below for the recommended modifications.

Insert corner-R(RE) (mm)	Additional processing dimension to body corner (mm)
4.0	R2.0

* Round-shaped additional processing is recommended. When applying chamfer shaped additional processing, do not cut away too much.

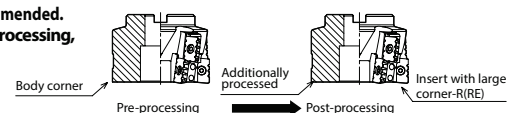

●: Standard item R: Right-hand only L: Left-hand only □: Check availability

Recommended cutting conditions

Workpiece material	fz (mm/t)		Recommended insert grades (Cutting speed Vc: m/min)	
	Low cutting force	General purpose	MEGACOAT	
	NB3P+NB4P	NB3+NB4	PR1230	PR1210
Carbon steel	0.15	0.2	★ 100~150~200	-
Cast iron	0.15	0.2	-	★ 100~150~200
Stainless steel	Not recommended			
Aluminum/Copper	Not recommended			

* For MSR, cutting speed should be carefully adjusted depending on the length of toolholder protruding from the end of machine spindle.
 - When the overhang length of toolholder is small, > set the cutting speed to slightly higher than the recommended cutting conditions.
 - When the overhang length of toolholder is long, > set the cutting speed to slightly lower than the recommended cutting conditions.

★ : 1st Recommendation
 ☆ : 2nd Recommendation

Cutting conditions

1. Shouldering

In case of MSR100R-1

Workpiece material	Overhang length LPR (mm)	Cutting conditions		ap x ae (mm)	Chip evacuation rate (cc/min)
		Cutting speed Vc (m/min)	Feed fz (mm/t)		
Carbon steel	Less than 100mm	150	0.2	20 x 80	920
	100~200mm	150	0.2	20 x 40	460
	201mm and over	100	0.2	20 x 30	228
Cast iron	Less than 100mm	180	0.2	20 x 80	1,100
	100~200mm	180	0.2	20 x 40	550
	201mm and over	120	0.2	20 x 30	276

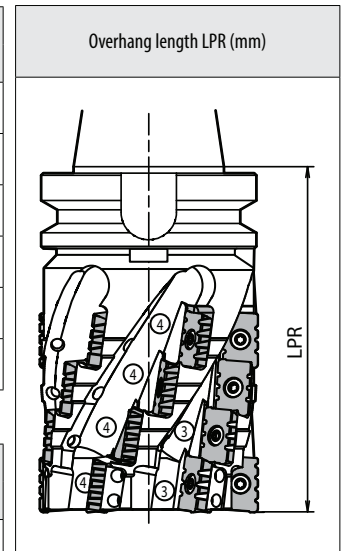

In case of MSR100R-2

Workpiece material	Overhang length LPR (mm)	Cutting conditions		ap x ae (mm)	Chip evacuation rate (cc/min)
		Cutting speed Vc (m/min)	Feed fz (mm/t)		
Carbon steel	Less than 130mm	150	0.2	40 x 40	920
	130~230mm	150	0.2	40 x 20	460
	231mm and over	100	0.2	40 x 20	304
Cast iron	Less than 130mm	180	0.2	40 x 40	1,100
	130~230mm	180	0.2	40 x 20	550
	231mm and over	120	0.2	40 x 20	368

In case of MSR100R-4

Workpiece material	Overhang length LPR (mm)	Cutting conditions		ap x ae (mm)	Chip evacuation rate (cc/min)
		Cutting speed Vc (m/min)	Feed fz (mm/t)		
Carbon steel	Less than 180mm	150	0.2	75 x 20	863
	180~280mm	150	0.2	75 x 10	431
	281mm and over	100	0.2	75 x 10	285
Cast iron	Less than 180mm	180	0.2	75 x 20	1,035
	180~280mm	180	0.2	75 x 10	518
	281mm and over	120	0.2	75 x 10	345



- Cutting edge angle 45°~70°
- Cutting edge angle 75°
- Cutting edge angle 88°/90°
- Cutter for Finishing
- High Feed Cutter
- Multi-Function
- Slot Mill
- Ball-nose Radius
- Others

2. Slotting**In case of MSR100R-1**

Workpiece material	Overhang length LPR (mm)	Cutting conditions		ap x ae (mm)	Chip evacuation rate (cc/min)
		Cutting speed Vc (m/min)	Feed fz (mm/t)		
Carbon steel	Less than 100mm	150	0.2	7 x 100	403
	100~200mm	120	0.2	4 x 100	184
	201mm and over	100	0.2	3 x 100	114
Cast iron	Less than 100mm	180	0.2	14 x 100	966
	100~200mm	150	0.2	7 x 100	403
	201mm and over	120	0.2	4 x 100	184

In case of MSR100R-2

Workpiece material	Overhang length LPR (mm)	Cutting conditions		ap x ae (mm)	Chip evacuation rate (cc/min)
		Cutting speed Vc (m/min)	Feed fz (mm/t)		
Carbon steel	Less than 130mm	150	0.2	7 x 100	403
	130~230mm	120	0.2	4 x 100	184
	231mm and over	100	0.2	3 x 100	114
Cast iron	Less than 130mm	180	0.2	14 x 100	966
	130~230mm	150	0.2	7 x 100	403
	231mm and over	120	0.2	4 x 100	184

In case of MSR160R-1

Workpiece material	Overhang length LPR (mm)	Cutting conditions		ap x ae (mm)	Chip evacuation rate (cc/min)
		Cutting speed Vc (m/min)	Feed fz (mm/t)		
Carbon steel	Less than 100mm	150	0.2	5 x 160	384
	100~200mm	120	0.2	3 x 160	182
	201mm and over	100	0.2	2 x 160	102
Cast iron	Less than 100mm	180	0.2	10 x 160	928
	100~200mm	150	0.2	5 x 160	384
	201mm and over	120	0.2	4 x 160	243

In case of MSR160R-2

Workpiece material	Overhang length LPR (mm)	Cutting conditions		ap x ae (mm)	Chip evacuation rate (cc/min)
		Cutting speed Vc (m/min)	Feed fz (mm/t)		
Carbon steel	Less than 130mm	150	0.2	5 x 160	384
	130~230mm	120	0.2	3 x 160	182
	231mm and over	100	0.2	2 x 160	102
Cast iron	Less than 130mm	180	0.2	10 x 160	928
	130~230mm	150	0.2	5 x 160	384
	231mm and over	120	0.2	4 x 160	243

Notes: MSR...-4 (No. of stage)
Slotting is not recommended.

M



Milling

DMC-SX

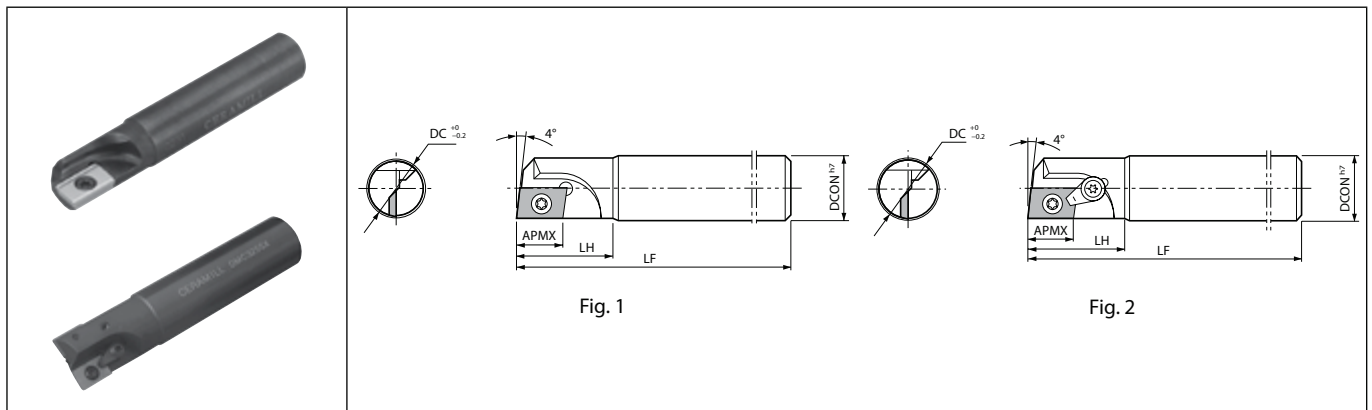

Toolholder dimensions

Description	Availability	Inserts	Dimension (mm)					A.R. (°)	R.R. (°)	Coolant hole	Fig.	Spare parts			Applicable inserts M150
			DC	DCON	LF	LH	APMX					Clamp set	Screw	Wrench	
DMC 316SXT 320SX 325SX 332SX 340SX	●	1	16	16	90	30	14	+3	-2	No	1	-	SB-4060TR	NDCT1503... NDCW1503...	
	●		20	20	110						2				
	●		25	25	120						2	CPS-2TR	SB-4065TR		FT-15
	●	2	32	32	130	40					2				
	●		40		150						2				
DMC 320SX-200 325SX-220 332SX-250	●	1	20	20	200	50					1		SB-4065TR	FT-15	NDCT1503... NDCW1503...
	●		25	25	220	60	14	+3	-2	No	1				
	●	2	32	32	250	80			0		1				



Milling

- Cutting edge angle 45°~70°
- Cutting edge angle 75°
- Cutting edge angle 88°/90°
- Cutter for Finishing
- High Feed Cutter
- Multi-Function
- Slot Mill
- Ball-nose Radius
- Others

● : Standard item R : Right-hand only L : Left-hand only □ : Check availability

M148

DMC-H

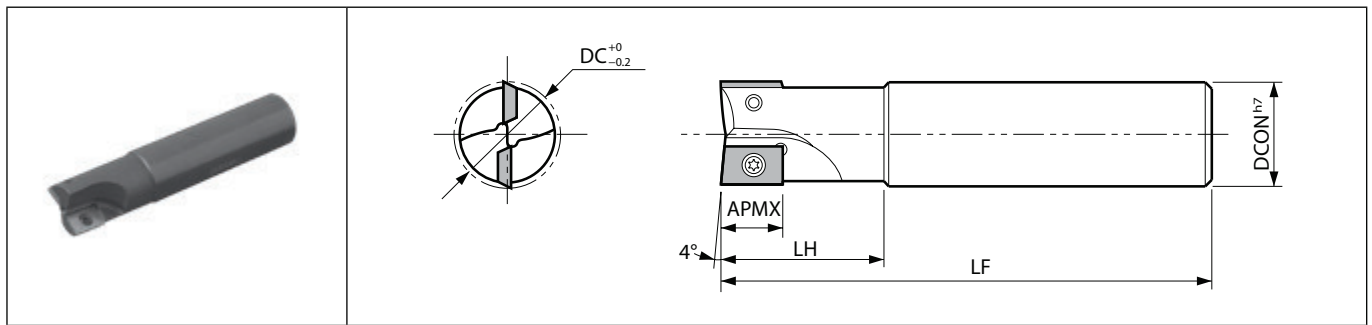







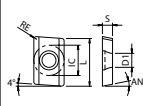

Toolholder dimensions

Description	Availability	Inserts	Dimension (mm)					A.R. (°)	R.R. (°)	Coolant hole	Spare parts		Applicable inserts M150
			DC	DCON	LF	LH	APMX				Screw	Wrench	
DMC 316H	●	1	16	16	90	30	+5	-3.5	No	SB-4060TR	FT-15	NDCT1503... NDCW1503...	
DMC 320H	●		20	20	110		+6	-2					
DMC 325H	●		25	25	120	14							
DMC 332H	●	2	32		130		+8	0		SB-4065TR			
DMC 340H	●		40	32	150								

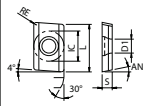
● : Standard item R : Right-hand only L : Left-hand only □ : Check availability

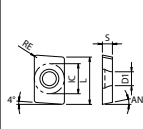

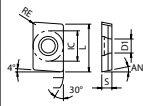
NDCT/NDCW

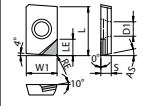
Insert		Description	No. of edges	Dimension (mm)									Angle (°)		Carbide	Cermets	PCD	Applicable toolholder M148 M149
				IC	S	D1	RE	L	INSL	LE	W1	AN	AS					
				IC	S	D1	RE	L	INSL	LE	W1	AN	AS					
 		NDCT 150308FR	2	9.525	3.18	4.5	0.8	15	-	-	-	15	-	●			DMC...SX(...) DMC...H	
		NDCT 150308TR	2	9.525	3.18	4.5	0.8	15	-	-	-	15	-	●				
 		NDCT 150308TRX	2	9.525	3.18	4.4	0.8	15	-	-	-	15	-	●			DMC...SX(...) DMC...H	
 		NDCW 150302TR 150304TR 150308TR 150320TR 150330TR 150340TR	2	9.525	3.18	4.5	0.2 0.4 0.8 2 3 4	15	-	-	-	15	-	● ● ● ● ● ●			DMC...SX(...)	
 		NDCW 150308TRX	2	9.525	3.18	4.4	0.8	15	-	-	-	15	-	●			DMC...SX(...) DMC...H	
 		NDCW 150302FRX 150302FRX-NE	1	-	3.18	4.4	0.2	-	15	5.7 5.1	9.525	-	15	● ●	●			

Handed insert shows Right-hand

Recommended cutting conditions M151

M



Milling

Cutting edge angle 45°~70°

Cutting edge angle 75°

Cutting edge angle 88°/90°

Cutter for Finishing

High Feed Cutter

Multi-Function

Slot Mill

Ball-nose Radius

Others

● : Standard item R : Right-hand only L : Left-hand only □ : Check availability

CBN & PCD Inserts are sold in 1 piece boxes

M150

Recommended cutting conditions (DMC-SX)

Workpiece material	fz (mm/t)	Recommended insert grades (Vc: m/min)		Max. ap (mm)		
		Cermet	Carbide	Cutting dia. (DC)	Slotting (ap)	Shouldering (apxae)
		TN100M	KW10			
Carbon steel	~0.2	★ 120~200		ø16~	3	9x3
Alloy steel	~0.2	★ 100~180		ø16~	3	9x3
Mold steel	~0.15	★ 100~180		ø16~	3	9x3
Stainless steel	~0.15	☆ 120~200		ø16~	2	6x2
Cast iron	~0.2		★ 80~150	ø16~	3	9x3
Non-ferrous metals	~0.2		★ 100~300	ø16~	3	9x3

When using inserts with corner-R(RE) 2.0 or larger, additional modifications of the cutter body will be necessary. Additional modifications for the body will be necessary. Ref. to the chart below for the recommended modifications. (Additional grind off is not necessary when corner-R(RE) is 0.8 mm or less.)

Insert corner-R(RE) (mm)	Additional processing dimension to body corner (mm)
2.0	R1.0
3.0	R1.6
4.0	R2.0

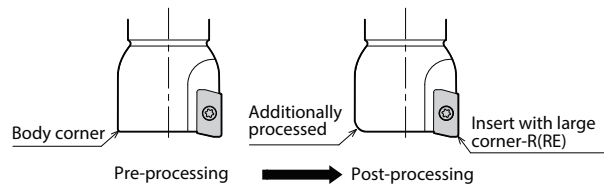

* Round-shaped additional processing is recommended. When applying chamfer shaped additional processing, do not cut away too much.

Recommended cutting conditions (DMC-H)

Workpiece material	fz (mm/t)	Recommended insert grades (Vc: m/min)				Max. ap (mm)		
		Cermet	Carbide	PCD		Cutting Dia. (DC)	Slotting (ap)	Shouldering (apxae)
		TN100M	KW10	KPD230 (KPD001)	KPD010			
Carbon steel	~0.2	★ 120~200				~ø20	4	8x4
						ø25~	8	14x6
Alloy steel	~0.2	★ 100~180				~ø20	4	8x4
						ø25~	8	13x6
Mold steel	~0.15	★ 100~180				~ø20	3	5x2
						ø25~	6	10x3
Stainless steel	~0.15	☆ 120~200				~ø20	3	6x2
						ø25~	6	13x3
Cast iron	~0.2		★ 80~150			~ø20	4	8x4
						ø25~	6	14x6
Non-ferrous metals	~0.2		★ 100~300	★ 300~500	☆ 300~500	~ø20	4	8x4
						ø25~	6	14x6

★: 1st Recommendation ☆: 2nd Recommendation

Above inserts are also applicable to DMC○○○SX, but the conventional NDCW1503○○TR insert is not applicable for this end mill.

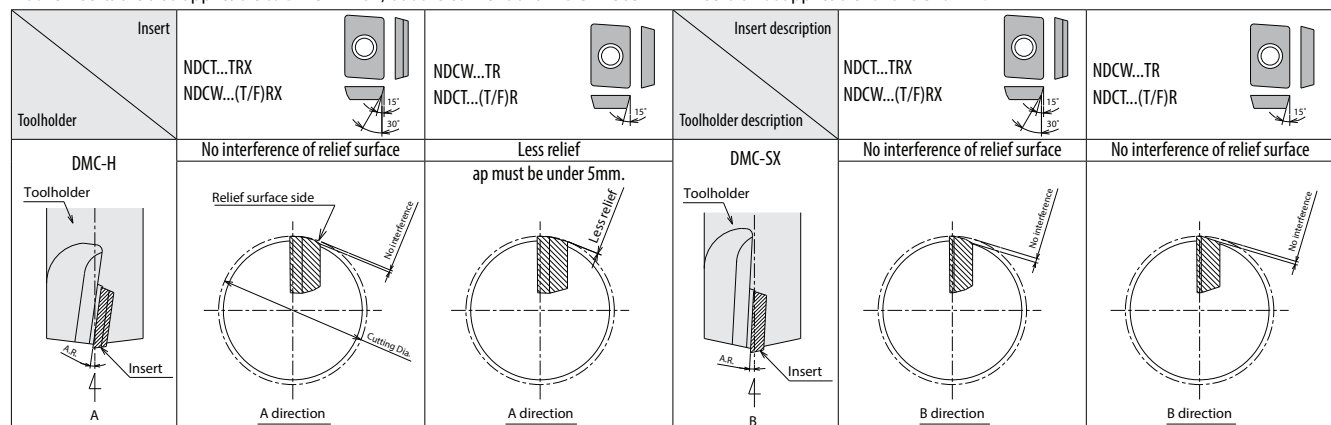

Milling

High efficiency milling cutter for finishing aluminum alloys

MFAH

Low cutting force minimizes burrs and chipping for high quality machining

Easily adjust blade runout

2 body types and 3 inserts for a variety of milling applications

1 Low cutting force minimizes burrs for high quality machining

Large true rake angle and dual cutting edge insert designs

Burr and chipping comparison (Internal evaluation)

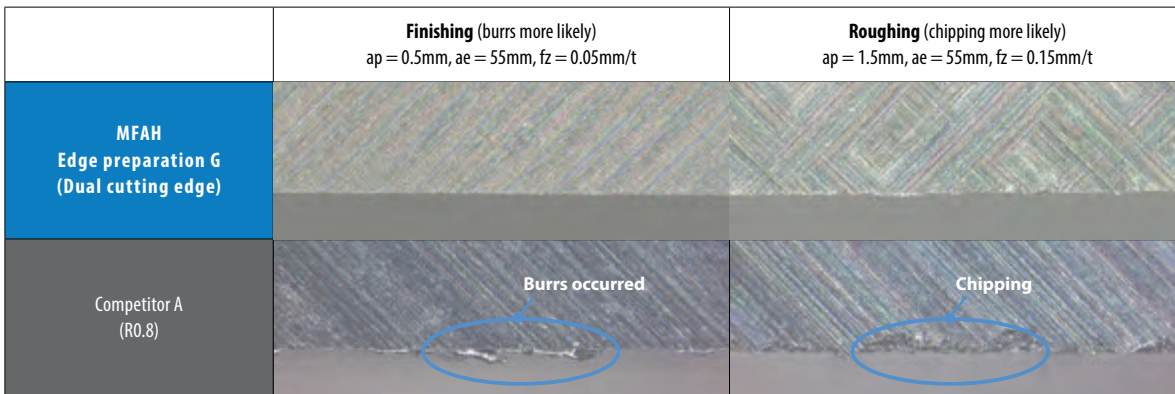

Cutting conditions: Vc = 2,500 m/min, Wet, Cutter dia. ø80
MFAH080RS-10T-SF, ENET0905PAER-G KPD001
Workpiece material: ADC12

2 Low cutting force design

Low cutting force, reduced chattering and high efficiency machining

Cutting force comparison (Internal evaluation)

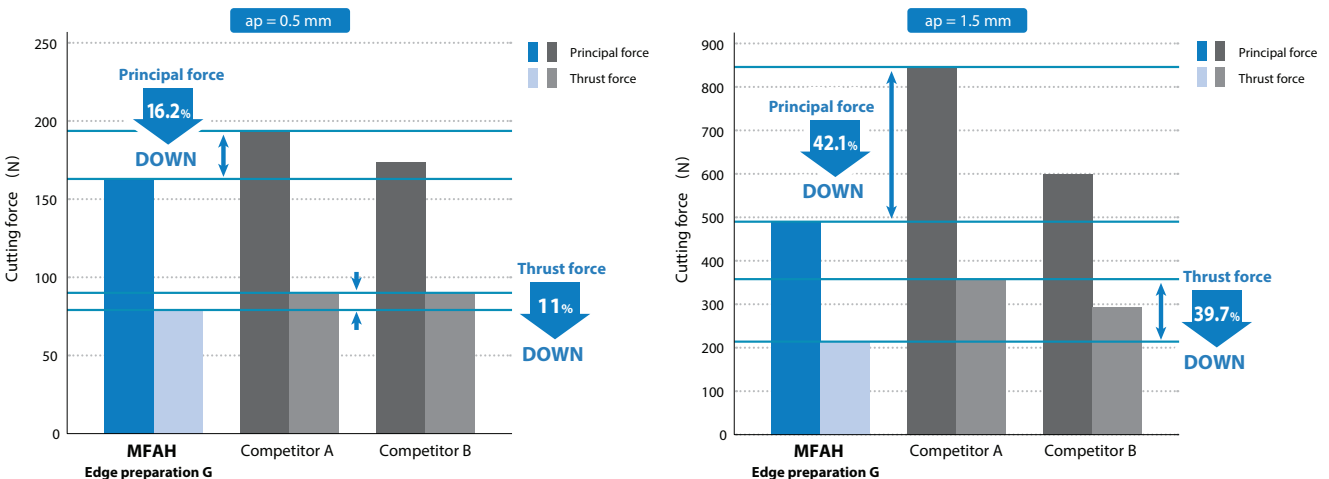

Cutting conditions: Vc = 2,500 m/min, ae = 55 mm, fz = 0.1 mm/t, Wet, Cutter dia. ø80
MFAH080RS-10T-SF, ENET0905PAER-G KPD001
Workpiece material: ADC12

M
Milling

- Cutting edge angle 45°~70°
- Cutting edge angle 75°
- Cutting edge angle 88°/90°
- Cutter for Finishing
- High Feed Cutter
- Multi-Function
- Slot Mill
- Ball-nose Radius
- Others

3 Adjustable blade runout

Easily install inserts and adjust blade runout

Easy insert installment

Guide pin allows for easier positioning

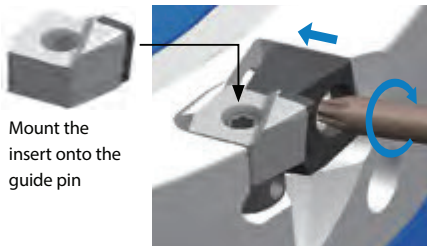

Mount the insert onto the guide pin

Easily adjust blade runout

Adjustable from both the front and outer periphery

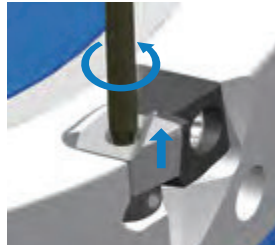

Unique design for easily adjusting from the front

Blade runout setting time comparison

(Internal evaluation)

* Operation Time of 5 Workers Comparison

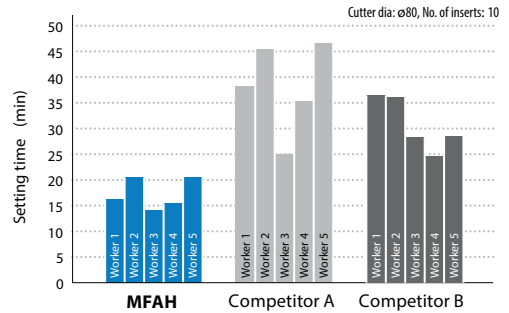

The MFAH can drastically shorten the setting time

4 Large tooling lineup

Steel body and light-weight hybrid body with internal coolant available

3 different edge designs offer a variety of machining applications

Cutter body

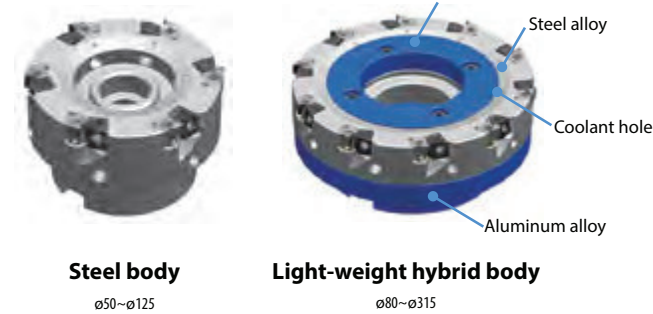

Steel body
ø50~ø125

Light-weight hybrid body
ø80~ø315

Insert (Edge design)

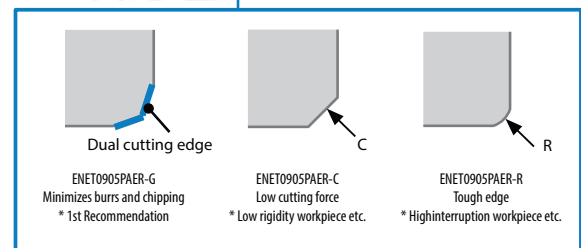
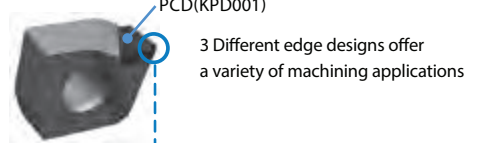

M



Milling

5 Safety enhancements during high-speed revolution

Scattering prevention mechanism

1 Prevention of scattering by wedge-shape design

New wedge-shape feature holds insert firmly in place and reduces chattering

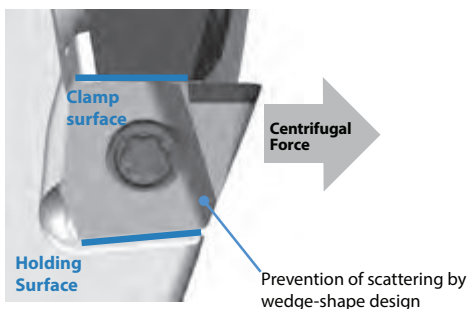

Prevention of scattering by wedge-shape design

2 Prevention of scattering with guide pin

Guide pins improve safety during high-speed rotation

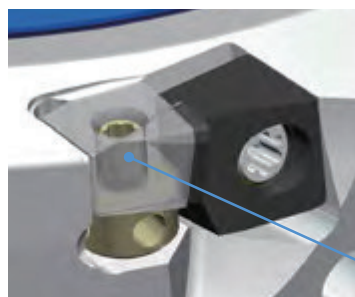

Prevention of scattering with guide pin

MFAH (Light-weight Hybrid body)

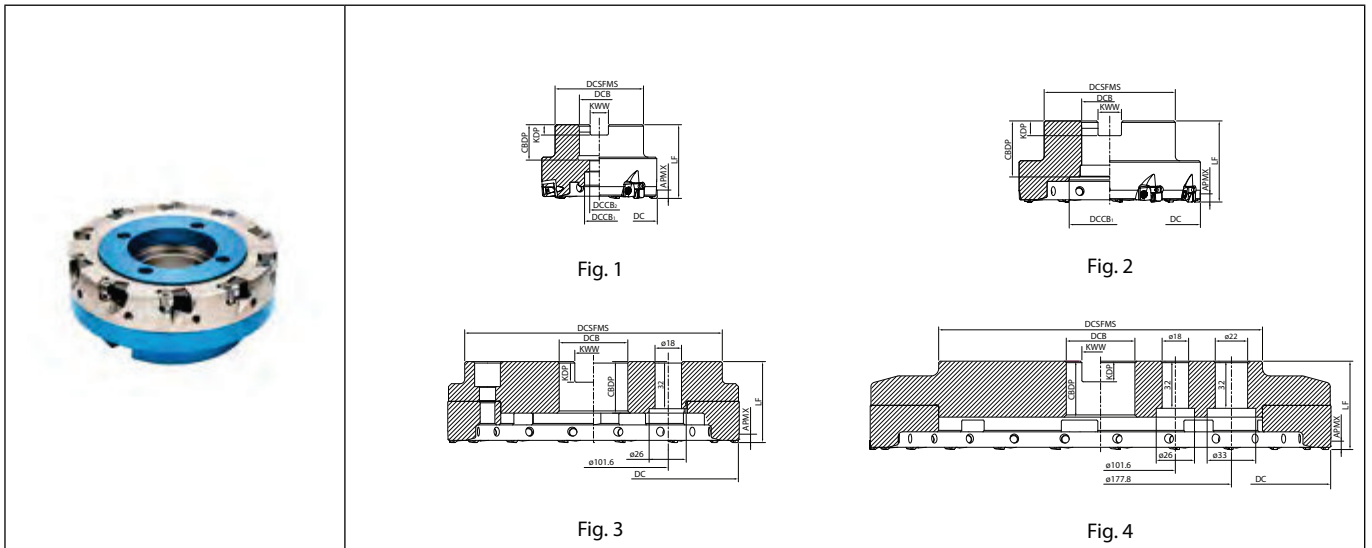

Toolholder dimensions

Description	Availability	Inserts	Dimension (mm)											Coolant hole	Max. revolution (min ⁻¹)	Weight (kg)	Fig.	Spare parts			Applicable inserts ➔ M157
			R	DC	DCSFMS	DCB	DCCB _h	DCCB ₂	LF	CBDP	KDP	KWW	APMX					Mounting bolt (Attachment)	Coolant cover (Attachment)	Coolant cover (sold separately)	
Metric MFAH 080RA-6T-M-SF 080RA-10T-M-SF 100RA-8T-M27-SF 100RA-8T-M-SF 100RA-12T-M27-SF 100RA-12T-M-SF 125RA-10T-M27-SF 125RA-10T-M-SF 125RA-16T-M27-SF 125RA-16T-M-SF 160RA-12T-M-SF 160RA-20T-M-SF	●	6	80	62	27	20	13	50	27	7	12.4	4.6	Yes	14600	0.82	1	-	-	ENET0905PAER-G ENET0905PAER-C ENET0905PAER-R		
	●	10		62	27	20	13		24	7	12.4				0.78	1					
	●	8	100	62	27	20	13	50	24	7	12.4			13000	1.2	1	HH12X35HC	-		-	
	●	8		85	32	42	-		30	8	14.4				1.32	2	HF16X48HC				
	●	12	62	27	20	13	50	24	7	12.4	11400			1.15	1	HH12X35HC	CC-125-MFAH	-			
	●	12	85	32	42	-		30	8	14.4				1.27	2	HF16X48HC					
	●	10	125	60	27	20	13	55	24	7	12.4			8000	1.8	1	HH12X35H	CC-160-MFAH		-	
	●	10		94	40	55	-		33	9	16.4				2.1	2	HF20X53HA				
	●	16	60	27	20	13	55	24	7	12.4	8000			1.73	1	HH12X35H	-	-			
	●	16	94	40	55	-		33	9	16.4				2.1	2	HF20X53HA					
	●	12	160	125	40	57	-	-	33	9	16.4			8000	3.5	2	HF20X53HA	CC-160-MFAH		-	
	●	20		125	40	57	-		33	9	16.4				3.4	2					

Confirm the total weight of the cutter and the arbor is within the machine's acceptable range.

● : Standard item R : Right-hand only L : Left-hand only □ : Check availability MT0 : Made to order

M154



- Cutting edge angle 45°~70°
- Cutting edge angle 75°
- Cutting edge angle 88°/90°
- Cutter for Finishing
- High Feed Cutter
- Multi-Function
- Slot Mill
- Ball-nose Radius
- Others

Toolholder dimensions

Description	Availability		Dimension (mm)													Coolant hole			Spare parts			Applicable inserts ➔ M157						
	R	Inserts	DC	DCSFMS	DCB	DCCB ₁	DCCB ₂	LF	CBDP	KDP	KWW	APMX	Max. revolution (min ⁻¹)	Weight (kg)	Fig.	Mounting bolt (Attachment)	Coolant cover (Attachment)	Coolant cover (sold separately)										
																			DC	DCSFMS	DCB		DCCB ₁	DCCB ₂	LF	CBDP	KDP	KWW
Bore dia. inch spec	MFAH	<input type="checkbox"/>	6	80	62	25.4	20	13	50	27	6	9.5	14600	0.83	1	HH12X35HC			ENET0905PAER-G ENET0905PAER-C ENET0905PAER-R									
		<input type="checkbox"/>	10																									
		<input type="checkbox"/>	8	100	62	25.4	20	13	50	24	6	9.5	13000	1.21	1	HH12X35HC												
		<input type="checkbox"/>	8																									
		<input type="checkbox"/>	8	100	85	31.75	42	-	50	34	8	12.7	13000	1.33	2	HF16X44HC												
		<input type="checkbox"/>	12																									
		<input type="checkbox"/>	12	100	62	25.4	20	13	50	24	6	9.5	13000	1.16	1	HH12X35HC												
		<input type="checkbox"/>	12																									
		<input type="checkbox"/>	12	100	85	31.75	42	-	50	34	8	12.7	13000	1.29	2	HF16X44HC												
		<input type="checkbox"/>	12																									
		<input type="checkbox"/>	10	125	60	25.4	20	13	55	24	6	9.5	11400	1.8	1	HH12X35H												
		<input type="checkbox"/>	10																									
		<input type="checkbox"/>	10	125	89	38.1	55	-	55	38	10	15.9	11400	2	2	HF20X53HA	CC-125-MFAH											
		<input type="checkbox"/>	16																									
		<input type="checkbox"/>	16	125	60	25.4	20	13	50	24	6	9.5	11400	1.74	1	HH12X35H												
		<input type="checkbox"/>	16																									
		<input type="checkbox"/>	16	125	89	38.1	55	-	50	10	15.9		11400	1.95	2	HF20X53HA												
		<input type="checkbox"/>	16																									
		<input type="checkbox"/>	12	160	130	50.8	70			38	11	19.1	8000	3.4	2	HF24X60HA	CC-160-MFAH											
		<input type="checkbox"/>	20																									
	<input type="checkbox"/>	20	160	130	50.8	70			38	11	19.1	8000	3.3	2														
	<input type="checkbox"/>	20																										
	<input type="checkbox"/>	16	200	175		126		55				5600	4.9	3			CC-200-MFAH											
	<input type="checkbox"/>	16																										
	<input type="checkbox"/>	24	200	175		126		55				5600	4.8	3			CC-250-MFAH											
	<input type="checkbox"/>	24																										
	<input type="checkbox"/>	20	250	140	47.625	165		55		14	25.4	4500	7	3			CC-250-MFAH											
	<input type="checkbox"/>	20																										
	<input type="checkbox"/>	32	250	140	47.625	165		55		14	25.4	4500	6.9	3			CC-315-MFAH											
	<input type="checkbox"/>	24																										
	<input type="checkbox"/>	24	315	220		220		60	38			3500	11.7	4			CC-315-MFAH											
	<input type="checkbox"/>	40																										

Confirm the total weight of the cutter and the arbor is within the machine's acceptable range.

● : Standard item R : Right-hand only L : Left-hand only ☐ : Check availability MT0 : Made to order



MFAH (Steel body)

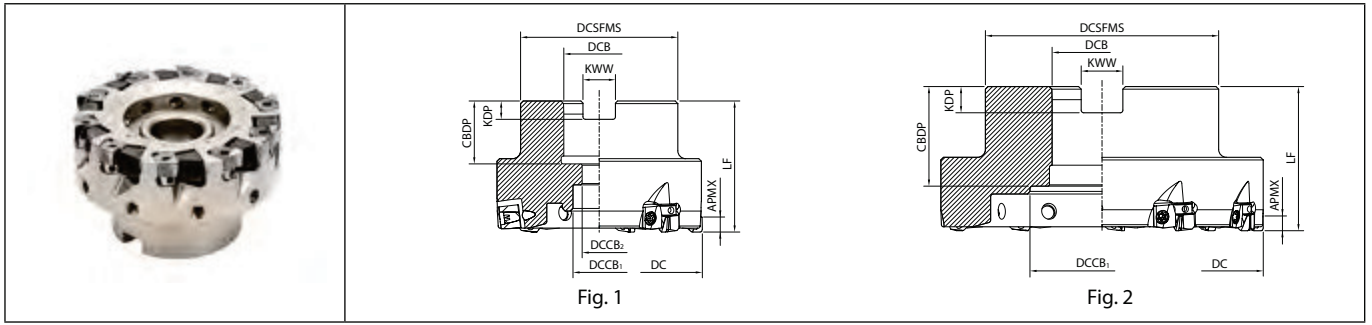

Toolholder dimensions

Description	Availability	Inserts	Dimension (mm)										Coolant hole	Max. revolution (min ⁻¹)	Weight (kg)	Fig.	Applicable inserts M157					
			DC	DCSFMS	DCB	DCCB ₁	DCCB ₂	LF	CDBP	KDP	KWW	APMX										
Metric	MFAH	050RS-4T-M-SF	●	4	50	48	16	13.6	9	40	19	5.6	8.4	4.6	No	19200	0.44	1	ENET0905PAER-G ENET0905PAER-C ENET0905PAER-R			
		050RS-5T-M-SF	●	5													0.43	1				
		063RS-5T-M-SF	●	63	61	22	23	11	21	6.3	10.4	16800	0.69	1								
		063RS-6T-M-SF	●										6	0.68	1							
		080RS-6T-M-SF	●	80	60	27	20	13	24	7	12.4	14600	1.16	1								
		080RS-10T-M-SF	●										10	1.11	1							
		100RS-8T-M-SF	●	100	70	32	45	50	30	8	14.4	13000	1.56	2								
		100RS-12T-M-SF	●										12	1.51	2							
		125RS-10T-M-SF	●	125	89	40	55	55	33	9	16.4	11400	2.6	2								
		125RS-16T-M-SF	●										16	2.5	2							
		Bore dia. inch spec	MFAH	080RS-6T-SF	□	6	80	50	25.4	20	13	50	27	6	9.5	4.6	No	14600		1.02	1	ENET0905PAER-G ENET0905PAER-C ENET0905PAER-R
				080RS-10T-SF	□	8														0.98	1	
100RS-8T-SF	□			100	70	31.75	45	34	8	12.7	13000	1.59	2									
100RS-12T-SF	□											12	1.55	2								
125RS-10T-SF	□			125	89	38.1	55	55	38	10	15.9	11400	2.63	2								
125RS-16T-SF	□												16	2.56	2							



- Cutting edge angle 45°~70°
- Cutting edge angle 75°
- Cutting edge angle 88°/90°
- Cutter for Finishing
- High Feed Cutter
- Multi-Function
- Slot Mill
- Ball-nose Radius
- Others

Spare parts

Description		Wedge	Wedge screw	Wrench	Adjust screw	Wrench	Anti-seize compound	Applicable inserts
Light-weight hybrid body	MFAH080RA- ... MFAH315RA- ...							
Steel body	MFAH050RS- ... MFAH125RS- ...	C08R	W5X13L	TTW-15	AJ-4170	DTPM-8	P-37	

● : Standard item R : Right-hand only L : Left-hand only □ : Check availability

ENET

Classification of usage			Carbon steel / Alloy steel		P					
			Mold and die steel		M					
★ : Roughing / 1st Choice ☆ : Roughing / 2nd Choice ■ : Finishing / 1st Choice □ : Finishing / 2nd Choice (In case hardness is 45HRC or under)			Austenitic stainless steel		K					
			Martensitic stainless steel		N					
Insert			Gray cast iron		S					
			Nodular cast iron		H					
Description			Dimension (mm)					PCD	Applicable toolholder M154~M156	
			S	L	LE	W1	BS			
			ENET 0905PAER-G	7.9	6.02	5.6	9.61	2.6	●	MFAH...RA...-SF MFAH...RS...-SF
			ENET 0905PAER-C	7.9	6.02	5.6	9.61	3	●	MFAH...RA...-SF MFAH...RS...-SF
			ENET 0905PAER-R	7.9	6.02	5.6	9.61	3.1	●	MFAH...RA...-SF MFAH...RS...-SF

Recommended cutting conditions M158



● : Standard item R : Right-hand only L : Left-hand only □ : Check availability

CBN & PCD Inserts are sold in 1 piece boxes

Recommended cutting conditions

Workpiece material	Property	Vc (m/min)	fz (mm/t)	Recommended insert grades
Aluminum alloys	Si Ratio 12.5% or less	1,000 - 2,500 - 3,000	0.05 - 0.10 - 0.20	KPD001
	Si Ratio 12.5% and over	400 - 600 - 800	0.05 - 0.10 - 0.20	

Recommended cutting conditions are reference values. Please adjust cutting speed and feed rate according to actual machining conditions taking into account machine and workpiece rigidity. Do not use the cutter at speeds exceeding the maximum cutting speed limit.

Cutting performance

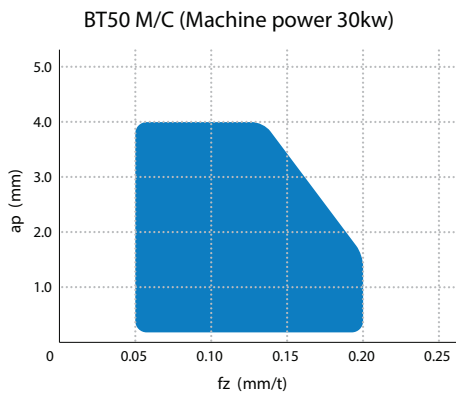

Cutting conditions: Vc = 2,500 m/min, ae = 55mm, Wet, Cutter dia. ø80
MFAH080RS-10T-SF ENET0905PAER-G KPD001 Workpiece material: ADC12



Milling

Cutting edge angle 45°~70°
Cutting edge angle 75°
Cutting edge angle 88°/90°
Cutter for Finishing
High Feed Cutter
Multi-Function
Slot Mill
Ball-nose Radius
Others

Cautions

While in use

! Caution

Please use within recommended cutting conditions

Do not run the cutter at revolutions exceeding the printed maximum revolution limit of the cutter body
Inserts or cutter body may be damaged due to the centrifugal force and cutting load

Please do not use under the following conditions:

When cutter is not fully loaded with inserts
If the body and/or clamp is damaged
If a clamp or clamp screw is removed
If inserts that have different regrind amounts are mounted

Please wear protective equipment such as protective glove when changing inserts or adjusting edge fluctuation
Injury can occur when touching the cutting edge

Dynamic balance

Balance adjustment on the cutter is completed before shipping
Balance adjustment has been made with special high precision inserts to be ISO balance quality grade (ISO 1940-1) G2.5

Do not operate the balance adjustment screw at the outer periphery of cutter

⇨ This could lead to improper dynamic balance

Do not completely remove clamp and clamp screw from cutter

⇨ This requires additional balance adjustment



Balance adjustment screw is mounted at the necessary point

* Do not operate

How to mount insert

- 1 Adjust the clearance between adjustment screw for cutting edge and the surface of insert to be 0.5mm
- 2 Mount insert on guide pin
(Be sure to install from the head. Mounting from outer periphery is not recommended)
- 3 Tighten the clamp screw while lightly pressing the insert against the holding surface (Recommended Torque 4.2N·m)
- 4 Make sure that there is no clearance between the insert side surfaces and the holding surface

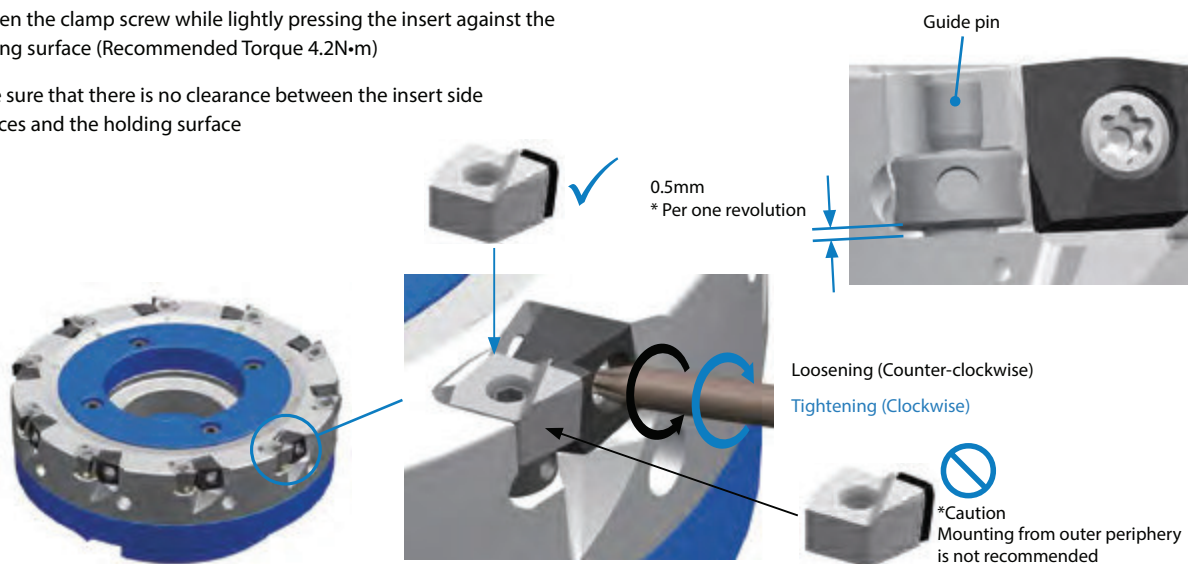

M



Milling

How to adjust blade runout

1 Install an insert



2 Partially tighten



3 Adjustable blade runout

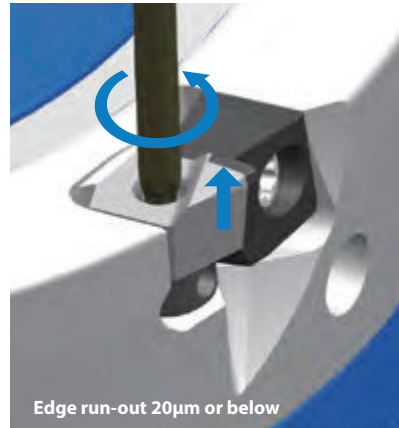

4 Fully tighten



5 Adjustable blade runout

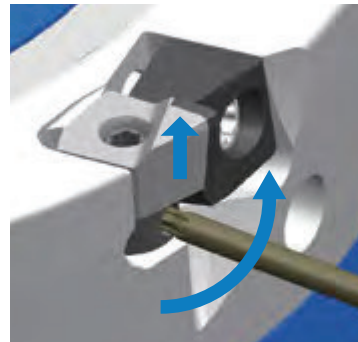
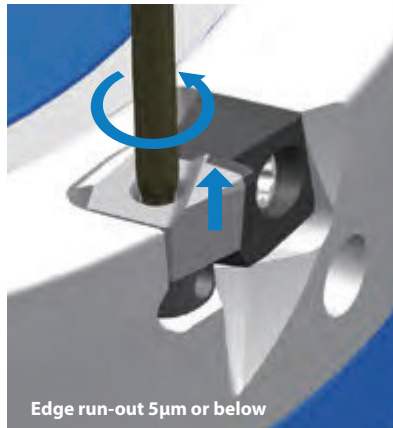

M



Milling

- 1** Install inserts into all pockets
- 2** Partially tighten the clamp screw (Recommended Torque 2.0N·m)
- 3** Turn the screw with the wrench to adjust and make sure that all screw heights are within 20µm of each other (Recommended)
- 4** Fully tighten the clamp screw with tightening torque 4.2 N·m
- 5** Slightly adjust position of cutting edge (Recommended position difference: 5µm or below)
* All inserts should be fine-tuned

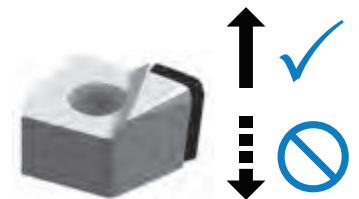

* Caution
Do not adjust cutting edge to lower position

Cutting edge angle
45°~70°

Cutting edge angle
75°

Cutting edge angle
88°/90°

Cutter for
Finishing

High Feed
Cutter

Multi-
Function

Slot Mill

Ball-nose
Radius

Others

Precaution for changing clamp

How to mount a clamp on a holder

1 Attach clamp screw into clamp first



Attaching clamp screw into clamp
(about 1 revolution)

2 Mounting

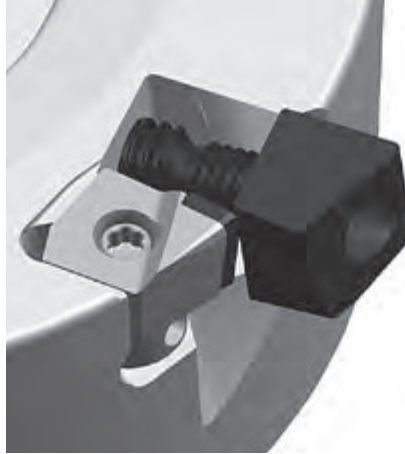

Mount it to the holder

3 Fastening



Fasten with recommended torque
(Completed)

Mount position of clamp screw



Right position

(Screw head does not come out)



Wrong position

(Screw head comes out)

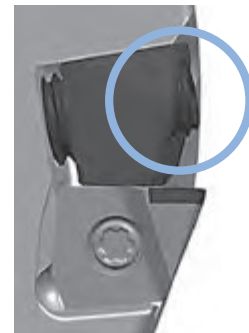

Confirm if clamp screw is not coming out after fastening clamp screw with recommended torque

Re-mount if the clamp screw is coming out

Adjust the balance is needed after mounting in case removing a clamp screw completely such as clamp change

For aluminum alloys high efficiency end mill

MEAS

Excellent scatter prevention to ensure stable, high speed aluminum machining
 Large ramping angle delivers a wide range of machining applications

1 High reliability and high efficiency machining

Grooved connection between the insert and holder
 Provides high speed aluminum machining (ø32: Recommended max. cutting speed Vc = 3,000m/min)

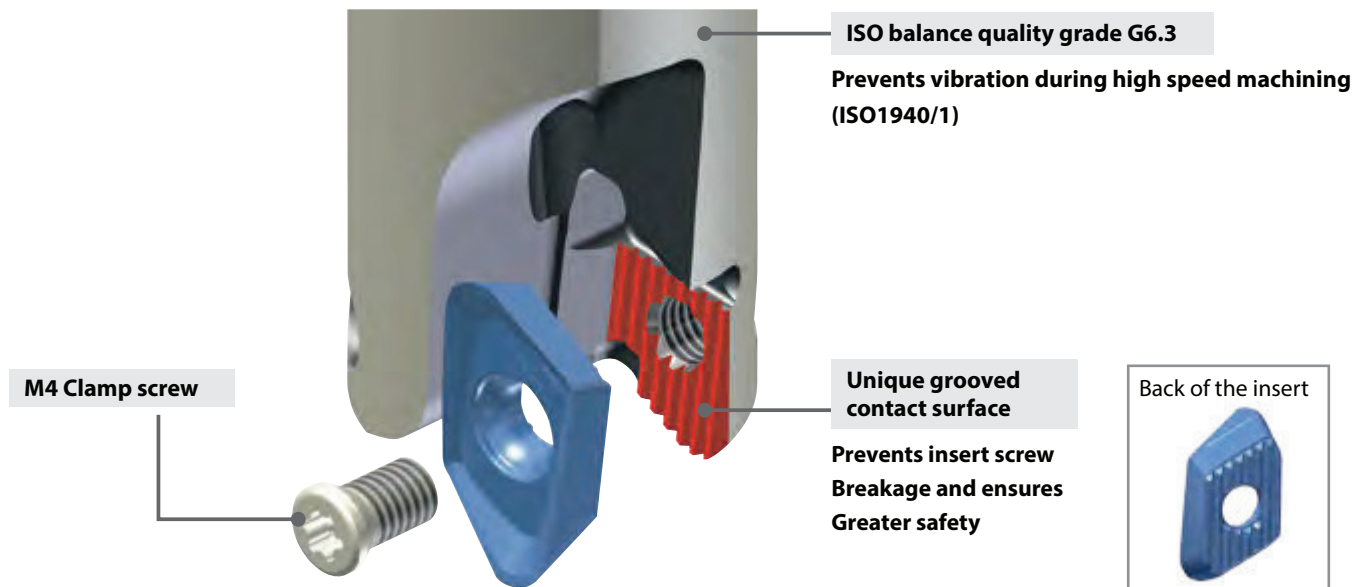

Grooved insert pocket

Centrifugal force is applied across the grooved surface to reduce pressure on the insert screw
 Prevents insert screw breakage and safely secures the insert during high-speed revolutions

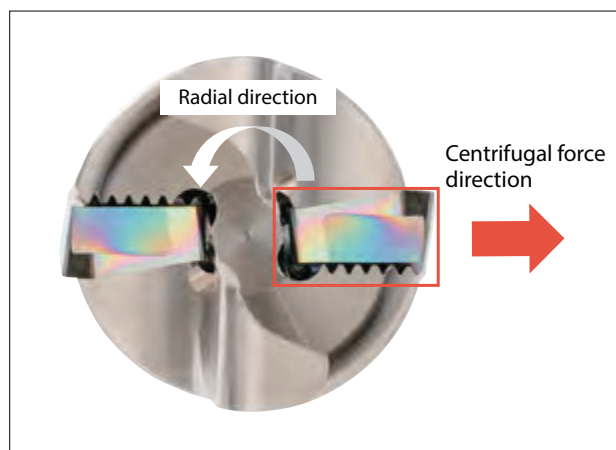

Grooved contact surface

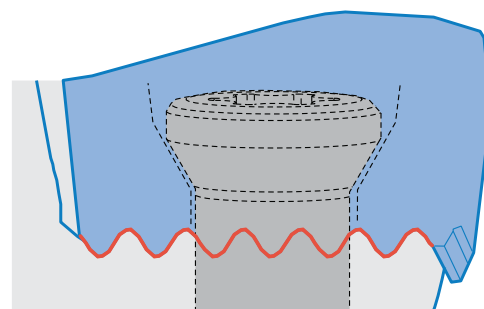

M

Milling

- Cutting edge angle 45°~70°
- Cutting edge angle 75°
- Cutting edge angle 88°/90°
- Cutter for Finishing
- High Feed Cutter
- Multi-Function
- Slot Mill
- Ball-nose Radius
- Others

2 Low cutting force with sharp cutting edge

True rake angle max. 20°

Low cutting force and excellent chattering resistance

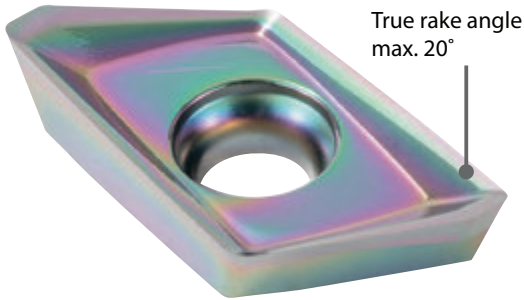

Cutting force comparison (Internal evaluation)

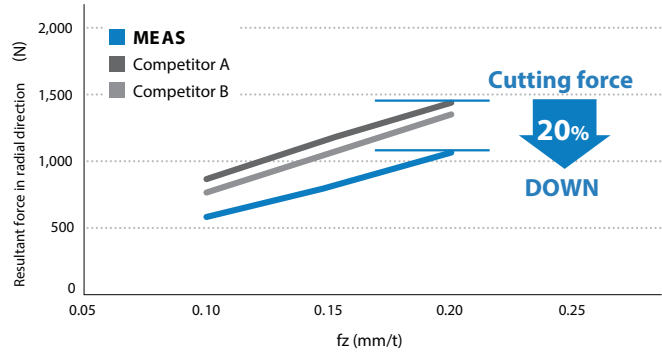

Cutting conditions: Vc = 390 m/min, ap x ae = 8 x 5mm, Dry
Cutter dia. ø25mm (2 Flutes) Workpiece material: AlZnMgCu 1.5

3 Applicable to a wide range of application

Max. ramping angle 20° (ø25)

The MEAS can be used for shouldering, slotting, ramping, and helical milling applications

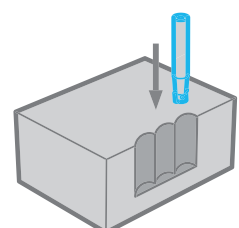
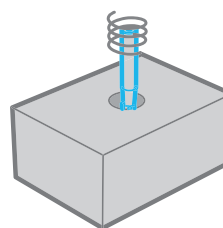
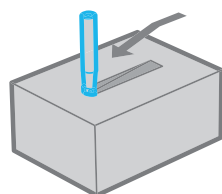
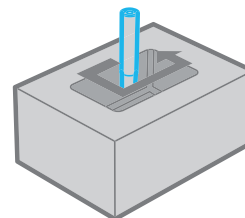
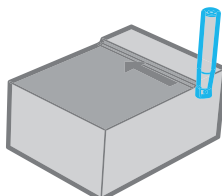
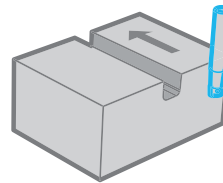
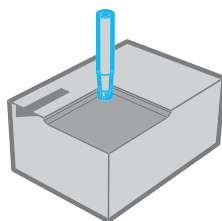

M



Milling

MEAS

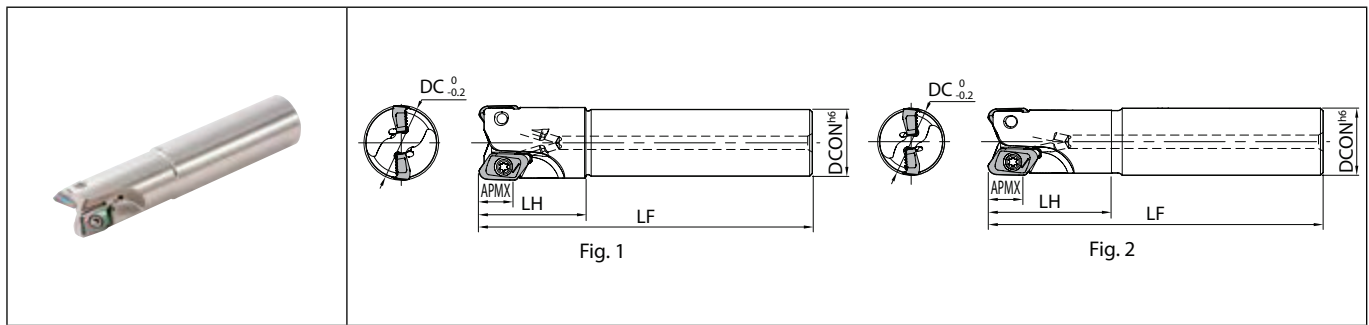

Toolholder dimensions

Description	Availability	Inserts	Dimension (mm)					A.R. max. (°)	R.R. (°)	Coolant hole	Max. revolution (min ⁻¹)	Weight (kg)	Fig.	Spare parts			Applicable inserts M165			
			DC	DCON	LF	LH	APMX							Anti-seize compound	Screw	Wrench				
			Icons			Icons														
Cylindrical Standard shank	MEAS	●	2	28	25	125	40	12	+10	-13	Yes	54000	0.4	1	P-37	SB-4090TRP	DTPM-15	KCGT1305...		
				35	32	150	50					46000							0.9	1
				40								42000								1
Cylindrical Same shank	MEAS	●	2	25	25	125	49	12	+10	-14	Yes	59000	0.4	2	P-37	SB-4075TRP SB-4090TRP	DTPM-15	KCGT1305...		
				32	32	150	69					49000							0.8	2
Cylindrical Long shank	MEAS	●	2	25	25	170	89	12	+10	-14	Yes	49000	0.5	2	P-37	SB-4075TRP SB-4090TRP	DTPM-15	KCGT1305...		
				32	32	200	119					39000							1.1	2

When using inserts with a corner-R(RE) of 3.2 or larger, additional modifications (R3.5 mm or larger) on the corner of cutter body is necessary.

Coat Anti-seize Compound thinly on portion of taper and thread when insert is fixed.

Recommended tightening torque for insert clamp : 3.5N·m

M



Milling

MEAS

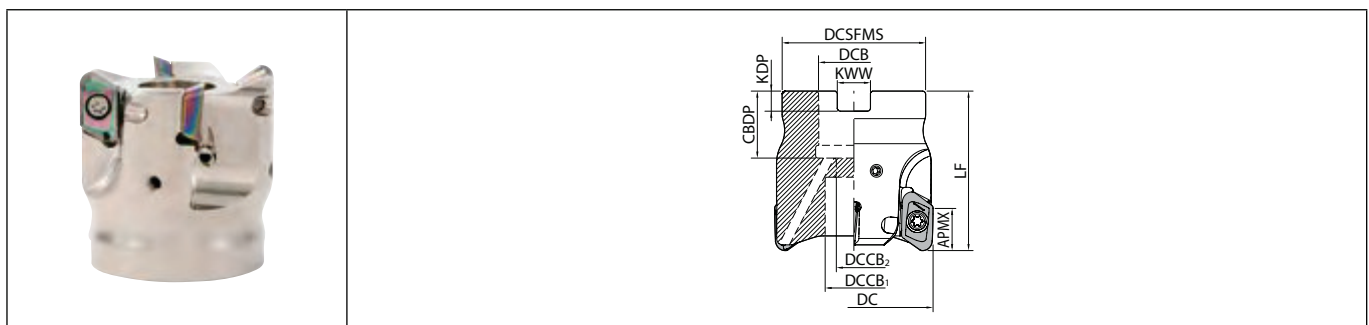

Toolholder dimensions

Description	Availability	Inserts	Dimension (mm)											A.R. max. (°)	R.R. (°)	Coolant hole	Max. revolution (min ⁻¹)	Weight (kg)	Spare parts				Applicable inserts M165
			R	DC	DCSFMS	DCB	DCCB ₁	DCCB ₂	LF	CBDP	KDP	KWW	APMX						Anti-seize compound	Mounting bolt	Screw	Wrench	
			Icons			Icons			Icons														
MEAS 050R-13-4T-M	●	4	50	45	22	18	11	50	21	6.3	10.4	12	+10	-11	Yes	36000	0.4	P-37	HH10X30H	SB-4090TRP	DTPM-15	KCGT1305...	

When using inserts with a corner-R(RE) of 3.2 or larger, additional modifications (R3.5 mm or larger) on the corner of cutter body is necessary.



Coat Anti-seize Compound thinly on portion of taper and thread when insert is fixed.

Recommended tightening torque for insert clamp : 3.5N·m

● : Standard item R : Right-hand only L : Left-hand only □ : Check availability

M164

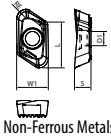
KCGT

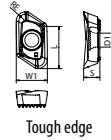
Classification of usage		Carbon steel / Alloy steel		P					
		Mold and die steel							
★: Roughing / 1st Choice ☆: Roughing / 2nd Choice ■: Finishing / 1st Choice □: Finishing / 2nd Choice (In case hardness is 45HRC or under)		Austenitic stainless steel		M					
		Martensitic stainless steel							
		Gray cast iron		K					
		Nodular cast iron							
		Non-ferrous metals		★ N					
		Heat-resistant alloy							
		Titanium alloy		S					
		Hard materials		H					
Insert	Description	Dimension (mm)					DLC PDL025	Carbide	Applicable toolholder M164
		No. of edges	S	D1	RE	L			
  <p>Non-Ferrous Metals</p>	KCGT 130504FR-AL 130508FR-AL 130512FR-AL 130516FR-AL 130520FR-AL 130524FR-AL 130530FR-AL 130532FR-AL 130540FR-AL 130550FR-AL	2	5.1	4.4	0.4	14.1	9.9	●	MEAS...
					0.8	13.9		●	
					1.2	13.8		●	
					1.6	13.3		●	
					2	13.3		●	
					2.4	13.3		●	
					3	13.3		●	
					3.2	12.8		●	
					4	12.8		●	
5	12.8	●							
  <p>Tough edge</p>	KCGT 130504ER-AM 130508ER-AM 130516ER-AM 130525ER-AM 130530ER-AM 130540ER-AM	2	5.1	4.4	0.4	13.7	9.9	●	MEAS...
					0.8	13.7		●	
					1.6	13.3		●	
					2.5	13.3		●	
					3	13.3		●	
					4	12.8		●	

Handed insert shows Right-hand

Recommended cutting conditions

Workpiece	Chip breaker	Vc (m/min)	ae (mm)	fz (mm/t)	
				ap = 0.5 mm (Reference value)	
				DC	Cutting Dia. ø28 or less
Aluminum alloys	AL Si Ratio 12.5% or less	200~1,000~3,000	≤ 0.5DC	0.05~0.15~0.25	
			0.5DC <		
		200~1,000~5,000	≤ 0.5DC	0.05~0.15~0.3	0.05~0.2~0.35
			0.5DC <	0.05~0.15~0.25	0.05~0.15~0.3
	AL Si Ratio 12.5% and over	200~300~400	≤ 0.5DC	0.05~0.1~0.2	
			0.5DC <		
		200~300~800	≤ 0.5DC	0.05~0.15~0.3	0.05~0.2~0.35
			0.5DC <	0.05~0.15~0.25	0.05~0.15~0.3

- Recommended cutting conditions are reference values. Please adjust cutting speed and feed rate according to actual machining conditions taking into account machine and workpiece rigidity
- Do not use the cutter at speeds exceeding the maximum cutting speed limit (See page M167)
- Regularly changing the insert clamp screw is recommended
- Use appropriate safety covers to protect from tool breakage and chip scattering
- When using at a higher revolution (10,000min⁻¹ or over), refer to the table below to adjust the balance of the MEAS and arbor

Revolution (min ⁻¹)	ISO balance quality grade ISO 1940-1/8821 (JIS B0905)
~20,000	G16
~30,000	G6.3
30,000~	G2.5

●: Standard item R: Right-hand only L: Left-hand only □: Check availability

MEAS Cutting performance

ø50 (4 flutes) Shouldering ae = 25mm Workpiece material: AlZnMgCu1.5

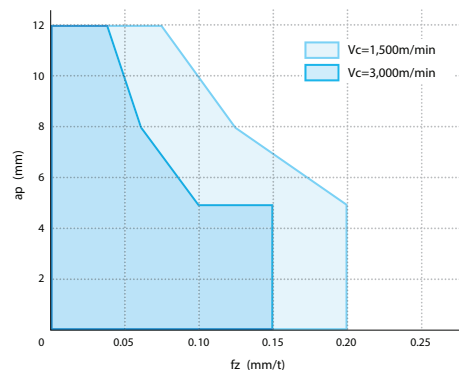

Reduce the feed rate when machining at high speeds



Reference data for ramping

Cutter dia. DC (mm)	25	28	32	35	40	50
Max. ramping angle RMPX	20°	16°	12.5°	11°	8.5°	6°
tan RMPX	0.363	0.287	0.221	0.194	0.149	0.105

Guide for ramping (Slant milling)

Ramping angle should be RMPX (Maximum ramping angle) or under in the above cutting conditions.
Reduce recommended feed rate by 50%

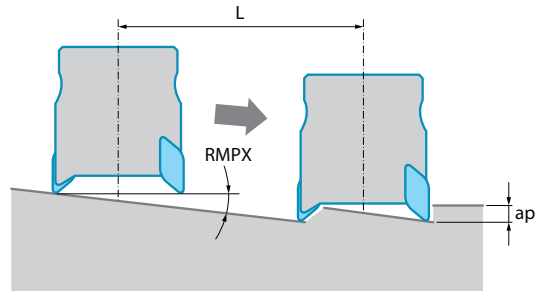

Formula of the cutting length "L" at Max. ramping angle

$$L = \frac{ap}{\tan RMPX}$$

Vertical milling (Plunging)

* For vertical milling (plunging), reduce feed rate to fz=0.1mm/t or less.

Insert description	Max. width of cut (ae)
KCGT13 type	8mm

Helical milling

For helical milling, use between min. cutting dia. and max. cutting dia.

Over max. cutting dia.

Center core part remains after machining

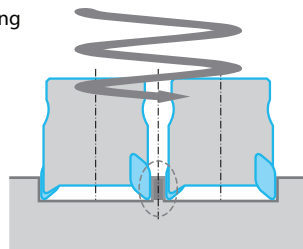

Under min. cutting dia.

Center core part interferes with toolholder

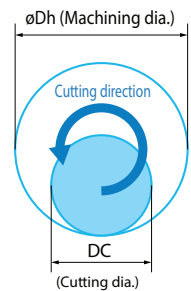
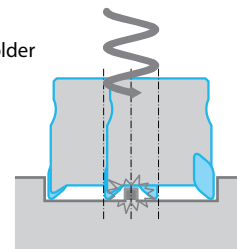

Description	Min. cutting dia.	Max. cutting dia.	Maximum ramping depth per cycle
MEAS...13...	2×DC-16	2×DC-3	3.5

Unit: mm

- Down-cut milling is recommended (refer to the figure above)
- Feed rate should be under 50% of the recommended cutting conditions
- Use caution to eliminate incidences caused by producing long chips

M

Milling

Cutting edge angle 45°~70°

Cutting edge angle 75°

Cutting edge angle 88°/90°

Cutter for Finishing

High Feed Cutter

Multi-Function

Slot Mill

Ball-nose Radius

Others

Guide for drilling

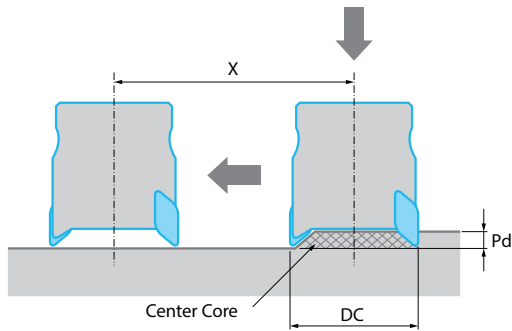

Drilling depth

Please refer to Pd (Max. drilling depth) in the chart.

Traversing after drilling

1. It is recommended to reduce feed by $f_z = 0.15$ (mm/t) or less until the center core is removed.
2. When drilling, reduce feed rate per revolution to $f=0.1$ mm/rev or under.

Description	Max. Cutting depth Pd	Min. cutting length X for flat bottom surface
MEAS...-13-...	3.5	DC-16

Unit: mm

How to mount inserts

1. Be sure to remove dust and chips from the insert mounting pocket.
2. Insert screw
 - Coat anti-seize compound thinly on portion of taper and thread.
 - Attach screw to the magnetized wrench tip and tighten while gently pressing the outside edge of the insert toward the insert pocket surface (grooved surface) (see the picture on the right) (Recommended Torque 3.5N·m)



When using inserts with a corner-R(RE) of 3.2 or larger

When using inserts with corner-R(RE) 3.2 or larger, additional modifications of the cutter body will be necessary. Additional modifications for the body will be necessary. Ref. to the chart below for the recommended modifications. (If corner-R is 3.0 mm or smaller, additional modifications are not needed)

Insert Corner-R(RE) (mm)	Additional processing dimension to body corner (mm)
3.2	R2.0
4.0	R2.5
5.0	R3.0

* Round- shaped additional processing is recommended. When applying chamfer shaped additional processing, do not cut away too much.

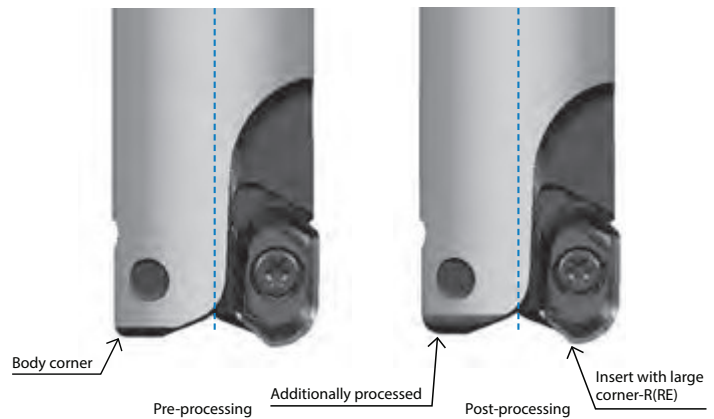

Cautions

While in Use



Please use within recommended cutting conditions

Do not run the cutter at revolutions exceeding the printed maximum revolution limit of the cutter body

Do not use the end mill at the maximum revolution or higher since the centrifugal force may cause inserts and parts to scatter even under no load.

Please do not use under the following conditions :

- When cutter is not fully loaded with inserts
- If the body is damaged

Please wear protective equipment such as protective glove when changing inserts

Injury can occur when touching the cutting edge

Dynamic balance

Balance adjustment on the cutter is completed before shipping

Balance adjustment to be ISO balance quality grade (ISO 1940-1) G6.3

When using at a higher revolution (10,000min⁻¹ or over), refer to the table below to adjust the balance of MEAS and arbor

Do not operate the balance adjustment screw on the outer periphery of the cutter. This could lead to improper dynamic balance

Revolution (min ⁻¹)	ISO balance quality grade
	ISO 1940-1/8821 (JIS B0905)
~20,000	G16
~30,000	G6.3
30,000~	G2.5



High-precision cutter for finishing applications

MFF

Cutter body design provides excellent reliability
Molded wiper inserts increases machining efficiency

1 Our solution for finishing operations

Designed with a unique insert combination of semi-finishing and finishing, the MFF drastically improves productivity by reducing quality issues.



SOLUTION

- Increase feed to $f = 5.0$ mm/rev
- Achieved $0.8 \mu\text{m}$ Ra surface finish
- No grinding required
- Achieved $5 \mu\text{m}$ flatness

The above is the result of a field test. Actual results will depend on machining environment, workpiece rigidity, machine, etc.

M

Milling

Cutting edge angle
45°~70°

Cutting edge angle
75°

Cutting edge angle
88°/90°

Cutter for Finishing

High Feed Cutter

Multi-Function

Slot Mill

Ball-nose Radius

Others

MFF Machining solutions

Can be used on a wide variety of parts and workpieces

Part name	Workpiece material	Industry
Plate / Frame / Case Cylinder pump / Rail Turbine housing Casing / Mold base	Rolled Steel for general structure / Gray cast iron / Spheroidal graphite cast iron Ni-resist cast iron Mold steel Carburized and hardened steel (60 HRC)	Industrial machining / Machine tools Shipbuilding / Automotive Construction machinery / Molds



2 Molded wiper insert for high-quality surface finish

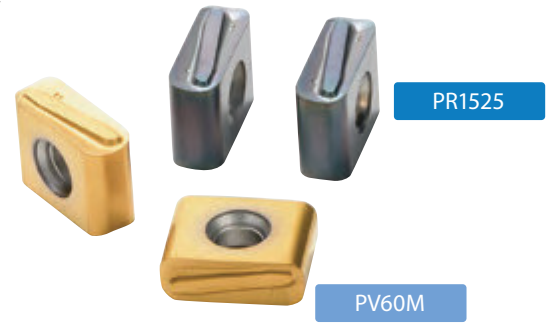

Kyocera's unique molded insert technology realizes high feed rates and excellent surface finish

Low cutting force with special edge preparation

Micro-honing
Good sharpness

Wiper edge

Large S-curve shape developed for higher feed rates

Edge temperature simulation comparison (Internal evaluation)

MFF Conventional tool After 2 sec machining

MEGACOAT NANO Cermet **PV60M**

For high-speed machining
Recommended $V_c \approx 350$ m/min

High-quality surface finish

Molded **TT chipbreaker**

Reduces chip clogging
High feed machining

M
Milling

Comprehensive machining solutions From roughing to finishing machining improvements (Internal evaluation)

Combine with Kyocera's MFH high feed cutter to improve quality and efficiency

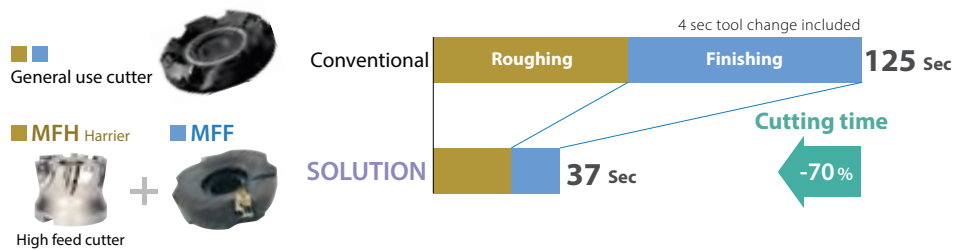

Cutting Conditions	
Conventional ø200 (6 inserts)	
$V_c = 200$ m/min	
Roughing: $V_f = 286$ mm/min ($f_z = 0.15$ mm/t), $a_p = 1.2$ mm	
Finishing: $V_f = 230$ mm/min ($f_z = 0.12$ mm/t), $a_p = 0.3$ mm	
SOLUTION	
Roughing: MFH Harrier ø63 (6 inserts)	
$V_c = 200$ m/min	
$V_f = 7,300$ mm/min ($f_z = 1.2$ mm/t), $a_p = 0.7$ mm	
Finishing: MFF ø200 (2 inserts)	
$V_c = 300$ m/min	
$V_f = 2,400$ mm/min ($f = 5.0$ mm/rev), $a_p = 0.1$ mm	

Surface finish quality after machining



3 Adjustable cutting edge for increased usability

Cartridge height comes pre-adjusted and should not be necessary.
Adjustment is not required after replacing insert.

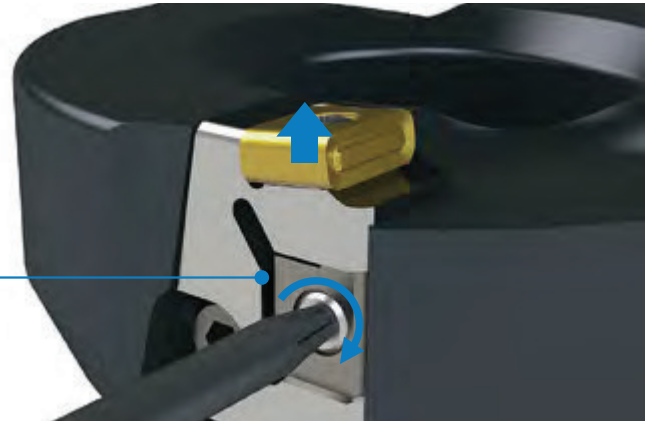

Included adjustment wrench

Easy-to-adjust cutting edge

Cutting edge height can be adjusted easily with one screw

Edge adjustment

If D.O.C. is ap 0.1 ~ 0.2 mm, no adjustment is necessary (Pre-adjusted before holder is shipped).
Cutting edge adjustment is NOT required when replacing inserts.

If D.O.C. is less than 0.1 mm or if you prefer a different edge height, use the following method:

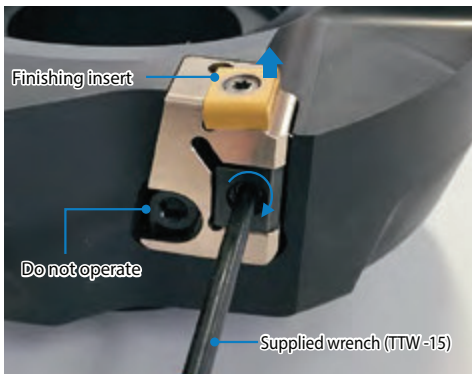

Adjusting the cutting edge

Use the supplied TTW-15 wrench to rotate the screw and easily adjust the cutting edge position.

Procedure

To adjust, start with the screw turned counterclockwise about two rotations (lowering the cutting edge).
Tighten the screw clockwise (raising the cutting edge) to adjust the amount of protrusion.
*Use a dial gauge to measure protrusion amount.

Precautions

Make sure to lower the cutting edge below the desired height first (turning screw counterclockwise) and then raise the edge up to the final height (turning screw clockwise).
If cutting edge is simply lowered to the final edge height, chattering or loosening of the screw may occur due to backlash.
Make sure the measurement position of the cutting edge is the same machining diameter.



Standard Cutting Edge Height

ap = 0.05 mm → protrusion against rough edge : 0.03 mm
ap = 0.10 mm ~ → protrusion against rough edge : 0.06 mm *Pre-adjusted before shipment

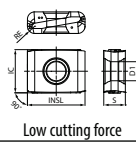

Cutting edge angle 45°~70°
Cutting edge angle 75°
Cutting edge angle 88°/90°
Cutter for Finishing
High Feed Cutter
Multi- Function
Slot Mill
Ball-nose Radius
Others

LNGX

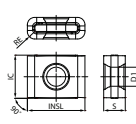
Classification of usage		Carbon steel / Alloy steel				P				
		Mold and die steel								
★ : Roughing / 1st Choice ☆ : Roughing / 2nd Choice ■ : Finishing / 1st Choice □ : Finishing / 2nd Choice (In case hardness is 45HRC or under)		Austenitic stainless steel				M				
		Martensitic stainless steel								
		Precipitation hardening stainless steel								
		Gray cast iron				K				
		Nodular cast iron								
		Non-ferrous metals				N				
		Heat-resistant alloy				S				
		Titanium alloy								
		Hard materials				H				
Insert	Description	No. of edges	Dimension (mm)					Cermets PVD PVI60M	Carbides PVD PRI525	Applicable toolholder M171 M28
			IC	S	D1	RE	INSL			
	 LNGX 120916R-TT Low cutting force	4	9.525	4.76	4.2	1.6	12.7	MTO	MTO	MFF...-SF MFSE45...-W MFSE45...-W-M
	 LNGX 120916	4	9.525	4.76	4.2	1.6	12.7	MTO	MTO	MFF...-SF MFSE45...-W MFSE45...-W-M

Recommended cutting conditions M173

M



Milling

Cutting edge angle
45°~70°

Cutting edge angle
75°

Cutting edge angle
88°/90°

Cutter for Finishing

High Feed Cutter

Multi-Function

Slot Mill

Ball-nose Radius

Others

● : Standard item R : Right-hand only L : Left-hand only □ : Check availability MTO : Made to order

M172

Recommended cutting conditions

Chipbreaker	Workpiece material	f (mm/rev)	ap (mm)	Recommended insert grades (Vc : m/min)	
				PV60M	PR1525
TT	Structural steel	1.5 – 4.0 – 5.0	0.03 – 0.1 – 0.3	★ 230 – 280 – 350	☆ 230 – 280 – 350
	Carbon steel	1.0 – 4.0 – 5.0		★ 200 – 250 – 350	☆ 200 – 250 – 350
	Alloy steel	1.0 – 4.0 – 5.0		★ 200 – 250 – 350	☆ 200 – 250 – 350
	Mold steel	1.0 – 2.0 – 4.0	0.03 – 0.1 – 0.2	☆ 120 – 200 – 250	★ 120 – 200 – 250
	Mold steel (50HRC ~)	0.6 – 1.0 – 1.2	0.03 – 0.05 – 0.1	—	★ 50 – 70 – 80
	Stainless steel (Austenitic related)*	1.0 – 2.0 – 4.0	0.03 – 0.1 – 0.2	☆ 120 – 200 – 250	★ 120 – 200 – 250
	Stainless steel (Martensitic related)*	1.0 – 3.0 – 4.0		☆ 150 – 200 – 300	★ 150 – 200 – 300
Standard	Gray cast iron	1.0 – 2.0 – 4.0	0.03 – 0.1 – 0.3	☆ 200 – 250 – 350	★ 200 – 250 – 350
	Nodular cast iron	1.5 – 2.0 – 4.0		☆ 150 – 250 – 300	★ 150 – 250 – 300

★: 1st Recommendation ☆: 2nd Recommendation

*Machining with coolant is recommended for stainless steel

The bold-faced number indicates a center value of recommended cutting condition.

Adjust the cutting speed and the feed rate within the above conditions according to the actual machining situation.

M



Milling

MFH Harrier

Anti chattering

Applicable to various applications with 4 types of inserts

Increased chip evacuation and shortened cutting time

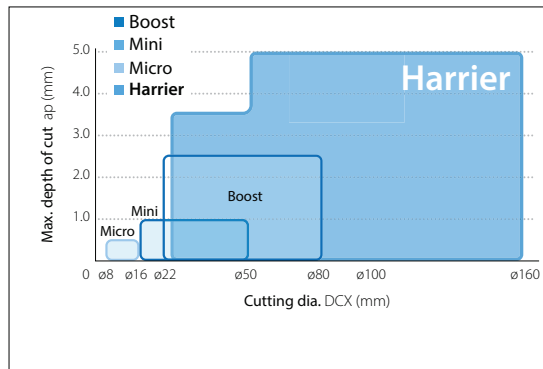

1 Large chipbreaker lineup for various machining applications

4 types of inserts according to your application

	GM type (General purpose)	GH type (Tough edge)	LD type (Large D.O.C.)	FL type (Low cutting force)
Shape				
Applications	1st recommendation for general purpose →Facing, Pocketing, Helical milling	Excellent fracture resistance →Available for facing, ramping and helical milling	Max. ap=5 mm →Applicable for scale removal at high efficiency	Wiper edge with low cutting force →Applicable for both roughing and finishing, for small machining center

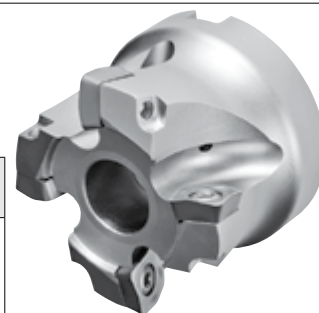

M



Milling

2 3D convex cutting edge reduces shock of biting workpiece

Cutting force (Shock) comparison when biting workpiece (Internal evaluation)

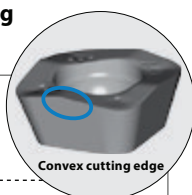
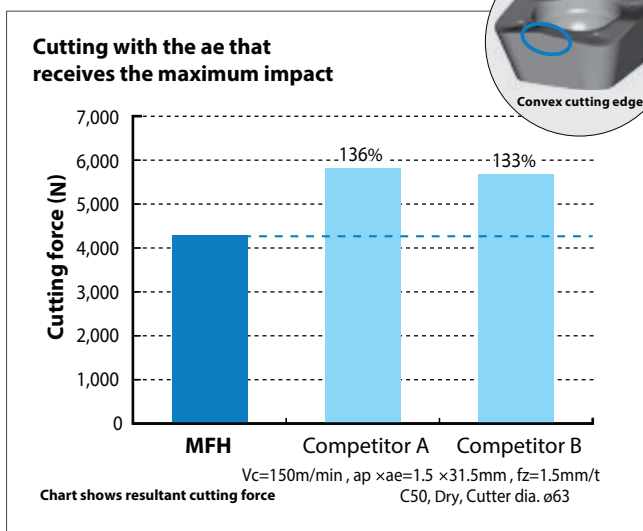

3 Multi-functional cutter

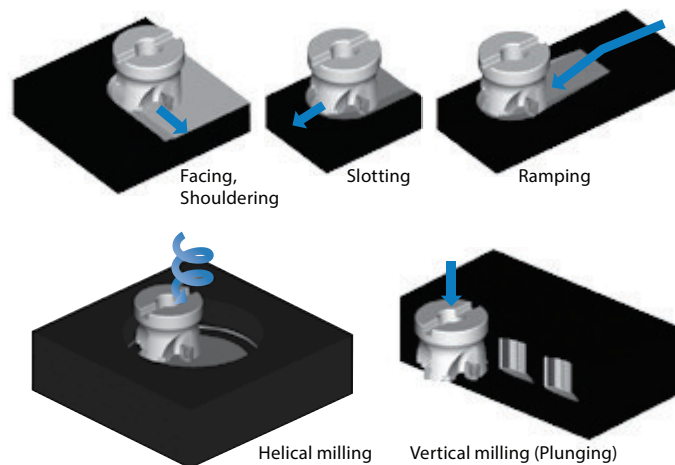

* GM type is applicable for all the above applications
* LD type and FL type are not applicable for helical milling, Plunging and contouring of rising wall (Please refer to M184)

4 Applicable for variety of workpieces from steel to heat-resistant alloys

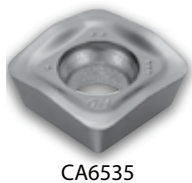

For Martensitic stainless steel and Ni-base heat-resistant alloys high heat resistance and wear resistance with CVD coating
Improved stability due to thin layer coating technology



For Ni-base heat-resistant alloys, titanium alloys and precipitation hardened stainless steel
Stable and longer tool life by special nano coating layer
MEGACOAT NANO

New development high toughness substrate

Smooth TiN layer
Smooth & less adhesion improved stability

Tough α -Al₂O₃ layer
Prevents oxidation and wear of coating layer due to high heat-resistance of aluminum oxide

Special Interlayer
Prevents peeling of coating layer

Ultra fine TiCN layer
High aspect ratio and micro columnar TiCN coating layer improves abrasive wear resistance

MEGACOAT base multi-layer structure

Wear resistance comparison (Internal evaluation)

X153CrMoV12

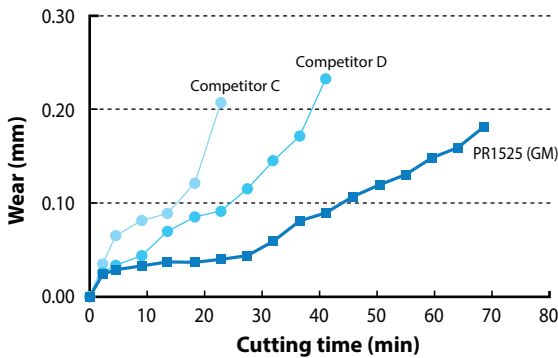

<Cutting conditions> Vc=150m/min, apxae=1.0x16mm, fz=1.5mm/t, Dry

Ni-base heat-resistant alloys

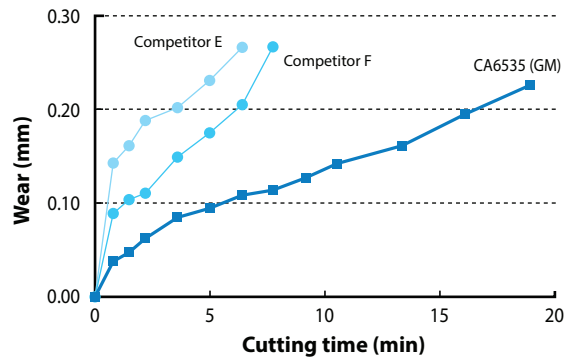

<Cutting conditions> Vc=30m/min, apxae=1.0x40mm, fz=0.8mm/t, Wet

Case studies

SFVAF22B (Forged alloy steel)

Machined portion

Machining efficiency 3 times increase

- Turbine parts • Vc=160m/min • apxae=1.5xmax.160mm
- fz=1.17mm/t • Dry
- MFH160R-14-8T (8 Flutes) • SOMT140520ER-GM (PR1525)

PR1525	Chip evacuation rate = 720cc/min
Competitor G	Chip evacuation rate = 240cc/min

- Small machining noise even at 3 times higher feed rate
- Good edge condition without chipping and stable machining

(User evaluation)

X5CrNi18 10

Chattering reduced

Machining efficiency 1.6 times

- Clutch • Vc=120m/min • apxae=1.0x20mm
- fz=1.2mm/t • Dry
- MFH32-S32-10-2T (2 Flutes) • SOMT100420ER-GM (PR1535)

PR1535	Chip evacuation rate = 58cc/min
Competitor H	Chip evacuation rate = 36cc/min

- Competitor H caused chattering but MFH realized stable machining
- Good edge condition and long tool life

(User evaluation)



MFH Harrier

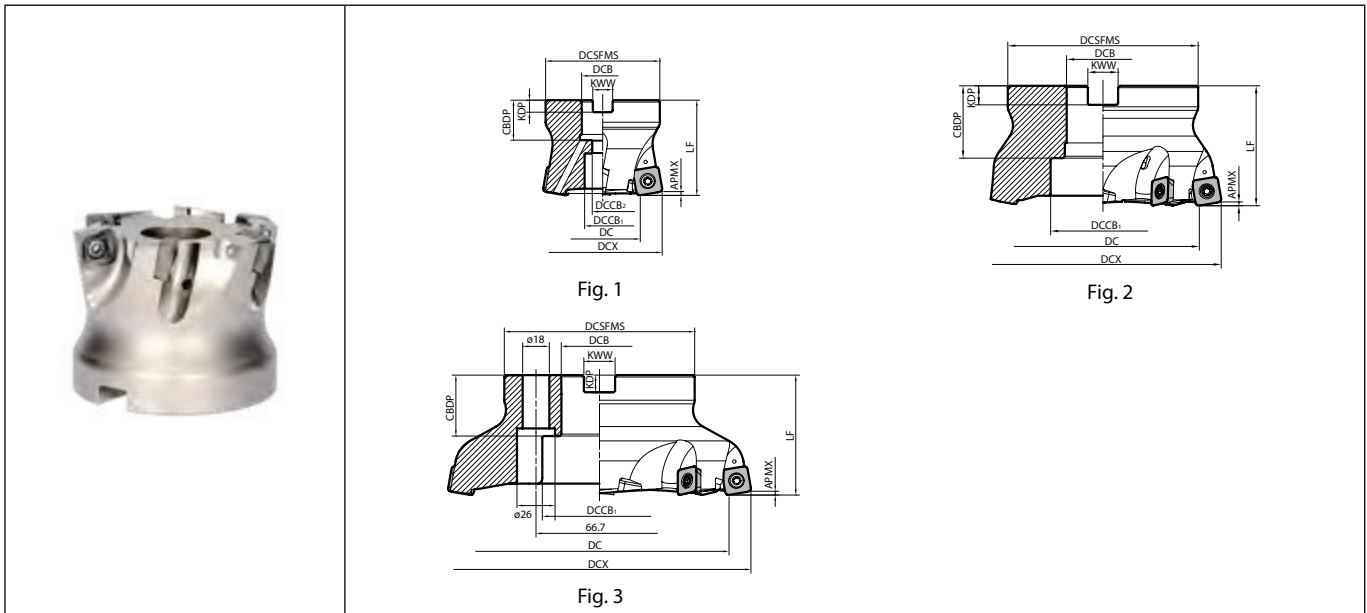

Toolholder dimensions

Description	Availability		Dimension (mm)													A.R. (°)	Coolant hole	Max. revolution (min ⁻¹)	Weight (kg)	Fig.	Applicable inserts M181			
	R	Inserts	DCX	DC (GM/GH)	DC (LD)	DC (FL)	DCSFMS	DCB	DCCB ₁	DCCB ₂	LF	CBDP	KDP	KWW	APMX							APMX ₂		
Metric MFH 050R-10-4T-M 050R-10-5T-M 052R-10-4T-M 052R-10-5T-M 063R-10-5T-22M 063R-10-5T-27M 063R-10-6T-22M 063R-10-6T-27M 080R-10-7T-M	●	4	50	33	37.5	36.5	47	22	19	11	50	21	6.3	10.4	1.5 (3.5)	1.2	+10	Yes	10000	0.4	1	SOMT1004...		
	●	5	52	35	39.5	38.5																	27	20
	●	4	52	35	39.5	38.5	60	22	19	11	50	21	6.3	10.4	1.5 (3.5)	1.2	+10	Yes	8800	0.7	1		SOMT1004...	
	●	5	63	46	50.5	49.5																		27
	●	6	63	46	50.5	49.5	60	22	19	11	50	19	6.3	10.4	1.5 (3.5)	1.2	+10	Yes	8800	0.7	1			SOMT1004...
	●	7	80	63	67.5	66.5	76	27	20	13	63	24	7	12.4	1.5 (3.5)	1.2	+10	Yes	7600	1.6	1			
	●	7	80	63	67.5	66.5	76	31.75	26	17	63	32	8	12.7	1.5 (3.5)	1.2	+10	Yes	7600	1.3	1			
	Bore dia. inch spec MFH 050R-10-4T 050R-10-5T 063R-10-5T 063R-10-6T 080R-10-7T	□	4	50	33	37.5	36.5	47	22.225	19	11	50	19	5	8.4	1.5 (3.5)	1.2	+10	Yes	10000	0.4			1
□		5	52	35	39.5	38.5	47	22.225	19	11	50	19	5	8.4	1.5 (3.5)	1.2	+10	Yes	8800	0.7	1	SOMT1004...		
□		6	63	46	50.5	49.5	60	22.225	19	11	50	19	5	8.4	1.5 (3.5)	1.2	+10	Yes	8800	0.7	1	SOMT1004...		
□		7	80	63	67.5	66.5	76	31.75	26	17	63	32	8	12.7	1.5 (3.5)	1.2	+10	Yes	7600	1.3	1	SOMT1004...		
□		7	80	63	67.5	66.5	76	31.75	26	17	63	32	8	12.7	1.5 (3.5)	1.2	+10	Yes	7600	1.3	1	SOMT1004...		

For APMX₂, refer to the figure in M177

The values (APMX = 3.5) and (APMX = 1.2) are valid in case of LD-Type usage.

Max. revolution : Do not use the cutter at the maximum revolution or higher since the centrifugal force may cause inserts and parts to scatter even under no load.

Coat Anti-seize Compound thinly on portion of taper and thread when insert is fixed.

● : Standard item R : Right-hand only L : Left-hand only □ : Check availability

M

Milling

Cutting edge angle 45°~70°

Cutting edge angle 75°

Cutting edge angle 88°/90°

Cutter for Finishing

High Feed Cutter

Multi-Function

Slot Mill

Ball-nose Radius

Others

MFH Harrier

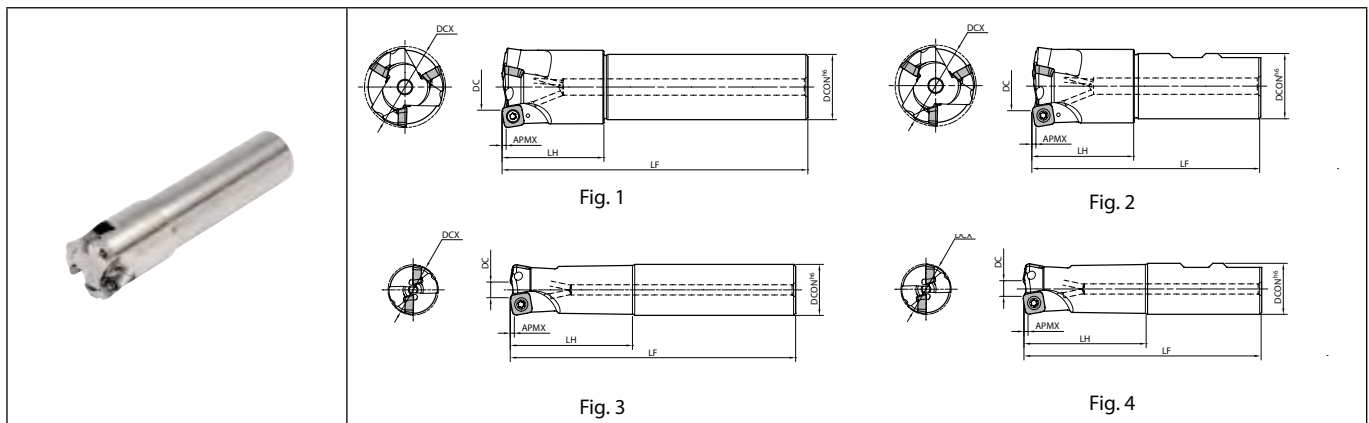

Toolholder dimensions

Description	Availability	Inserts	Dimension (mm)								A.R. (°)	Coolant hole	Max. revolution (min ⁻¹)	Weight (kg)	Fig.	Spare parts			Applicable inserts M181	
			DCX	DCON	DC (GM/GH)	DC (LD)	DC (FL)	LF	LH	APMX						APMX ₂	Anti-seize compound	Screw		Wrench
Cylindrical MFH 25-S25-10-2T 28-S25-10-2T 32-S32-10-2T 32-S32-10-3T 35-S32-10-2T 35-S32-10-3T 40-S32-10-3T 40-S32-10-4T	●	2	25	25	8	12.5	11.5	140	60	1.5 (3.5)	1.2	+10	Yes	17000	0.4	3	P-37 SB-4075TRP DTPM-15 Recommended tightening torque for insert clamp 3.5N·m	SOMT1004...		
	●	2	28	25	11	15.5	14.5	140	40					15500	0.5	1				
	●	3	32		15	19.5	18.5		70					14000		3				
	●	3	32		15	19.5	18.5		70					14000		3				
	●	2	35	32	18	22.5	21.5	150	50					13000	0.8	1				
	●	3	35	32	18	22.5	21.5	150	50					13000	0.8	1				
	●	3	40		23	27.5	26.5							11500	0.9	1				
	●	4	40		23	27.5	26.5							11500	0.9	1				
Weldon MFH 25-W25-10-2T 32-W32-10-3T 40-W32-10-3T 40-W32-10-4T	●	2	25	25	8	12.5	11.5	117	60	1.5 (3.5)	1.2	+10	Yes	17000	0.4	4	P-37 SB-4075TRP DTPM-15 Recommended tightening torque for insert clamp 3.5N·m	SOMT1004...		
	●	3	32		15	19.5	18.5	131	70					14000		4				
	●	3	40	32	23	27.5	26.5	112	50					11500	0.7	2				
	●	4	40		23	27.5	26.5	112	50					11500	0.7	2				
Long Shank MFH 25-S25-10-2T-200 28-S25-10-2T-200 32-S32-10-2T-200 35-S32-10-2T-200 40-S32-10-4T-250	●	2	25	25	8	12.5	11.5		120	1.5 (3.5)	1.2	+10	Yes	17000	0.6	3	P-37 SB-4075TRP DTPM-15 Recommended tightening torque for insert clamp 3.5N·m	SOMT1004...		
	●	2	28		11	15.5	14.5		40					15500	0.7	1				
	●	3	32		15	19.5	18.5		200					14000	1	3				
	●	3	35	32	18	22.5	21.5		120					13000	1.4	1				
Extra Long Shank MFH 25-S25-10-2T-300 28-S25-10-2T-300 32-S32-10-2T-300 35-S32-10-2T-300 40-S32-10-4T-300	●	2	25	25	8	12.5	11.5		180	1.5 (3.5)	1.2	+10	Yes	17000	1	3	P-37 SB-4075TRP DTPM-15 Recommended tightening torque for insert clamp 3.5N·m	SOMT1004...		
	●	2	28		11	15.5	14.5		40					15500	1.1	1				
	●	3	32		15	19.5	18.5		300					14000	1.6	3				
	●	3	35	32	18	22.5	21.5		180					13000	1.7	1				
	●	4	40		23	27.5	26.5		50	11500	1.8	1								

For APMX₂, refer to the figure in M177

The values (APMX = 3.5) and (APMX₂ = 1.2) are valid in case of LD-Type usage.

Max. revolution : Do not use the cutter at the maximum revolution or higher since the centrifugal force may cause inserts and parts to scatter even under no load.

Coat Anti-seize Compound thinly on portion of taper and thread when insert is fixed.

● : Standard item R : Right-hand only L : Left-hand only □ : Check availability

M178

M

Milling

Cutting edge angle 45°~70°

Cutting edge angle 75°

Cutting edge angle 88°/90°

Cutter for Finishing

High Feed Cutter

Multi-Function

Slot Mill

Ball-nose Radius

Others

MFH Harrier

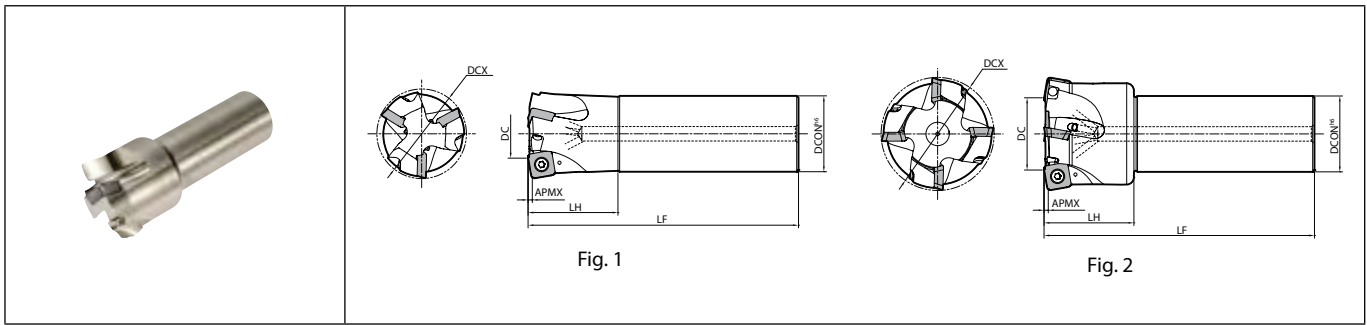

Toolholder dimensions

Description	Availability	Inserts	Dimension (mm)										A.R. (°)	Coolant hole	Max. revolution (min ⁻¹)	Weight (kg)	Fig.	Spare parts			Applicable inserts ● M181	
			DCX	DCON	DC (GM/GH)			DC (LD)	DC (FL)	LF	LH	APMX						APMX ₂	Anti-seize compound	Screw		Wrench
					27	33	32															
MFH 50-S42-14-3T	●	3	50												8800	1.4	1	P-37	SB-50120TRP	TTP-20	SOMT1405...	
63-S42-14-4T	●	4	63	42	40	46	45	150	50	2	(5)	+10	Yes	7400	1.7	2	Recommended tightening torque for insert clamp 3.5N·m					
80-S42-14-5T	●	5	80		57	63	62							6400	2.3	2						

For APMX₂, refer to the figure in M177

The values (APMX = 5) and (APMX₂ = 2) are valid in case of LD-Type usage.

Max. revolution : Do not use the cutter at the maximum revolution or higher since the centrifugal force may cause inserts and parts to scatter even under no load.

Coat Anti-seize Compound thinly on portion of taper and thread when insert is fixed.



MFH Harrier

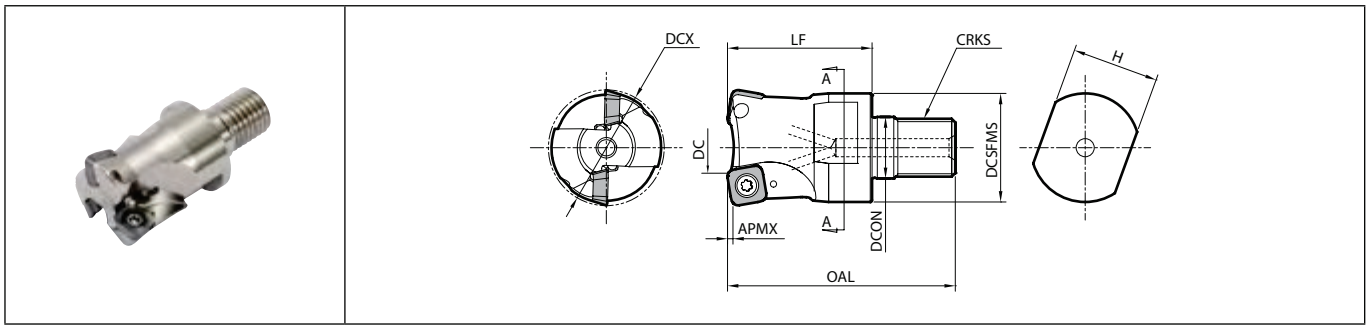

Toolholder dimensions

Description	Availability	Inserts	Dimension (mm)											A.R. (°)	Coolant hole	Max. revolution (min ⁻¹)	Spare parts			Applicable inserts M181	
			DCX	DCON	DC (GM/GH)	DC (LD)	DC (FL)	DCSFMS	OAL	LF	APMX	APMX ₂	CRKS				H	Anti-seize compound	Screw		Wrench
MFH 25-M12-10-2T	●	2	25	12.5	8	12.5	11.5	23	57	35				M12x1.75	19	17000	P-37	SB-407STRP	DTPM-15	SOMT1004...	
28-M12-10-2T	●	2	28	12.5	11	15.5	14.5								15500						
32-M16-10-2T	●	3	32		15	19.5	18.5								14000						
32-M16-10-3T	●	3																			
35-M16-10-2T	●	2	35	17	18	22.5	21.5	30	62	40	1.5 (3.5)	1.2	M16x2.0	24	13000						
35-M16-10-3T	●	3																			
40-M16-10-3T	●	3																			
40-M16-10-4T	●	4	40		23	27.5	26.5								11500						

For APMX₂, refer to the figure in M177

The values (APMX = 3.5) and (APMX₂ = 1.2) are valid in case of LD-Type usage.

Max. revolution : Do not use the cutter at the maximum revolution or higher since the centrifugal force may cause inserts and parts to scatter even under no load.

Coat Anti-seize Compound thinly on portion of taper and thread when insert is fixed.

See page M60 for applicable arbor (BT arbor for exchangeable head / double-face clamping spindle)









Milling

Cutting edge angle 45°~70°
Cutting edge angle 75°
Cutting edge angle 88°/90°
Cutter for Finishing
High Feed Cutter
Multi- Function
Slot Mill
Ball-nose Radius
Others

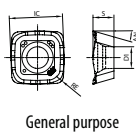
● : Standard item R : Right-hand only L : Left-hand only □ : Check availability

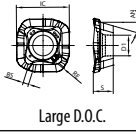
M180

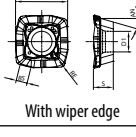
SOMT

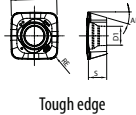
Insert		Description	No. of edges	Dimension (mm)					Angle (°)	Carbide				Applicable toolholder M176~M180	
				IC	S	D1	RE	BS		AN	CVD				
											CA6535	PR0155	PR1510		PR1525
<p>Classification of usage</p> <p>★: Roughing / 1st Choice ☆: Roughing / 2nd Choice ■: Finishing / 1st Choice □: Finishing / 2nd Choice (In case hardness is 45HRC or under)</p>		Carbon steel / Alloy steel								★	☆	P			
		Mold and die steel								★	☆	P			
		Austenitic stainless steel								☆	★	M			
		Martensitic stainless steel							★			☆	M		
		Precipitation hardening stainless steel										★	M		
		Gray cast iron									★		K		
		Nodular cast iron									★		K		
		Non-ferrous metals											N		
		Heat-resistant alloy							★			☆	S		
		Titanium alloy										★	S		
		Hard materials								★			H		
		SOMT 100420ER-GM	4	10.3	4.58	4.6	2	-	16	●	●	●	●	MFH...-10..	
	General purpose	SOMT 140520ER-GM	4	14.14	5.56	5.8	2	-	16	●	●	●	●	MFH...-14..	
		SOMT 100420ER-LD	4	10.45	4.58	4.6	2	0.9	16	●	●	●	●	MFH...-10..	
	Large D.O.C.	SOMT 140520ER-LD	4	14.76	5.56	5.8	2	1.6	16	●	●	●	●	MFH...-14..	
		SOMT 100420ER-FL	4	10.44	4.58	4.6	2	1.4	16	●	●	●	●	MFH...-10..	
	With wiper edge	SOMT 140514ER-FL	4	14.57	5.56	5.8	1.4	3.1	16	●	●	●	●	MFH...-14..	
		SOMT 100420ER-GH	4	10.43	4.57	4.55	2	-	16	●	●	●	●	MFH...-10..	
	Tough edge	SOMT 140520ER-GH	4	14.17	5.56	5.8	2	-	16	●	●	●	●	MFH...-14..	

Handed insert shows Right-hand

Recommended cutting conditions M182, M183



●: Standard item R: Right-hand only L: Left-hand only □: Check availability

Recommended cutting conditions

Insert type	Workpiece material	Toolholder description and feed rate (fz: mm/t)			Recommended insert grades (Vc: m/min)					
		MFH25-...	MFH32-...	MFH40-...	MEGACOAT NANO			MEGACOAT HARD	CVD Coated carbide	
					PR1535	PR1525	PR1510	PR015S	CA6535	
GM GH	Carbon steel	0.5~ 0.8 ~1.0(ap≤1.0mm) 0.2~ 0.4 ~0.5(ap≤1.5mm)	0.5~ 1.0 ~1.5(ap≤1.0mm) 0.3~ 0.7 ~1.0(ap≤1.5mm)	0.5~ 1.2 ~1.8(ap≤1.0mm) 0.4~ 1.0 ~1.5(ap≤1.5mm)	☆ 120~ 180 ~250	★ 120~ 180 ~250	-	-	-	
	Alloy steel	0.5~ 0.8 ~1.0(ap≤1.0mm) 0.2~ 0.4 ~0.5(ap≤1.5mm)	0.5~ 1.0 ~1.5(ap≤1.0mm) 0.3~ 0.7 ~1.0(ap≤1.5mm)	0.5~ 1.2 ~1.8(ap≤1.0mm) 0.4~ 1.0 ~1.5(ap≤1.5mm)	☆ 100~ 160 ~220	★ 100~ 160 ~220	-	-	-	
	Mold steel (~40HRC)	0.5~ 0.8 ~1.0(ap≤1.0mm) 0.2~ 0.3 ~0.4(ap≤1.5mm)	0.5~ 0.8 ~1.2(ap≤1.0mm) 0.3~ 0.6 ~0.8(ap≤1.5mm)	0.5~ 1.0 ~1.6(ap≤1.0mm) 0.4~ 0.8 ~1.2(ap≤1.5mm)	☆ 80~ 140 ~180	☆ 80~ 140 ~180	-	GH★ 80~ 140 ~180	-	
	Mold steel (40~50HRC)	0.15~ 0.3 ~0.5(ap≤1.0mm) 0.15~ 0.2 ~0.25(ap≤1.5mm)	0.2~ 0.5 ~0.8(ap≤1.0mm) 0.2~ 0.3 ~0.45(ap≤1.5mm)	0.2~ 0.6 ~0.9(ap≤1.0mm) 0.2~ 0.5 ~0.7(ap≤1.5mm)	-	☆ 60~ 100 ~130	-	GH★ 60~ 100 ~130	-	
	Mold steel (50~55HRC)	0.15~ 0.25 ~0.4(ap≤1.0mm)	0.15~ 0.35 ~0.6(ap≤1.0mm)	0.15~ 0.4 ~0.7(ap≤1.0mm)	-	☆ 50~ 70 ~100	-	GH★ 50~ 70 ~100	-	
	Mold steel (55~60HRC)	0.03~ 0.06 ~0.1(ap≤1.0mm) Recommended only for GH chipbreaker			-	-	-	GH☆ 50~ 60 ~70	-	
	Stainless steel (Austenitic related)	0.5~ 0.7 ~0.8(ap≤1.0mm) 0.2~ 0.3 ~0.4(ap≤1.5mm)	0.5~ 0.8 ~1.2(ap≤1.0mm) 0.3~ 0.6 ~0.8(ap≤1.5mm)	0.5~ 1.0 ~1.6(ap≤1.0mm) 0.4~ 0.8 ~1.2(ap≤1.5mm)	GM☆ 100~ 160 ~200	GM☆ 100~ 160 ~200	-	-	-	
	Stainless steel (Martensitic related)	0.5~ 0.7 ~0.8(ap≤1.0mm) 0.2~ 0.3 ~0.4(ap≤1.5mm)	0.5~ 0.8 ~1.2(ap≤1.0mm) 0.3~ 0.6 ~0.8(ap≤1.5mm)	0.5~ 1.0 ~1.6(ap≤1.0mm) 0.4~ 0.8 ~1.2(ap≤1.5mm)	☆ 150~ 200 ~250	-	-	-	★ 180~ 240 ~300	
	Stainless steel (Precipitation hardening)	0.5~ 0.7 ~0.8(ap≤1.0mm) 0.2~ 0.3 ~0.4(ap≤1.5mm)	0.5~ 0.8 ~1.2(ap≤1.0mm) 0.3~ 0.6 ~0.8(ap≤1.5mm)	0.5~ 1.0 ~1.6(ap≤1.0mm) 0.4~ 0.8 ~1.2(ap≤1.5mm)	★ 90~ 120 ~150	-	-	-	-	
	Gray cast iron	0.5~ 0.8 ~1.0(ap≤1.0mm) 0.2~ 0.4 ~0.5(ap≤1.5mm)	0.5~ 1.0 ~1.5(ap≤1.0mm) 0.3~ 0.7 ~1.0(ap≤1.5mm)	0.5~ 1.2 ~1.8(ap≤1.0mm) 0.4~ 1.0 ~1.5(ap≤1.5mm)	-	-	★ 120~ 180 ~250	-	-	
	Nodular cast iron	0.5~ 0.7 ~0.8(ap≤1.0mm) 0.2~ 0.3 ~0.4(ap≤1.5mm)	0.5~ 0.8 ~1.2(ap≤1.0mm) 0.3~ 0.6 ~0.8(ap≤1.5mm)	0.5~ 1.0 ~1.6(ap≤1.0mm) 0.4~ 0.8 ~1.2(ap≤1.5mm)	-	-	★ 100~ 150 ~200	-	-	
	Ni-base heat-resistant alloys	0.2~ 0.4 ~0.6(ap≤1.0mm) 0.15~ 0.2 ~0.3(ap≤1.5mm)	0.2~ 0.5 ~0.9(ap≤1.0mm) 0.2~ 0.4 ~0.6(ap≤1.5mm)	0.2~ 0.6 ~1.0(ap≤1.0mm) 0.2~ 0.5 ~0.8(ap≤1.5mm)	☆ 20~ 30 ~50	-	-	-	★ 20~ 30 ~50	
	Titanium alloys	0.2~ 0.4 ~0.6(ap≤1.0mm) 0.15~ 0.2 ~0.3(ap≤1.5mm)	0.2~ 0.5 ~0.9(ap≤1.0mm) 0.2~ 0.4 ~0.6(ap≤1.5mm)	0.2~ 0.6 ~1.0(ap≤1.0mm) 0.2~ 0.5 ~0.8(ap≤1.5mm)	GM★ 40~ 60 ~80	-	GM☆ 30~ 50 ~70	-	-	
LD	Carbon steel	0.5~ 0.8 ~1.0(ap≤1.0mm) 0.06~ 0.1 ~0.2(ap≤3.5mm)	0.5~ 1.0 ~1.5(ap≤1.0mm) 0.06~ 0.15 ~0.3(ap≤3.5mm)	0.5~ 1.2 ~1.8(ap≤1.0mm) 0.06~ 0.2 ~0.3(ap≤3.5mm)	☆ 120~ 180 ~250	★ 120~ 180 ~250	-	-	-	
	Alloy steel	0.5~ 0.8 ~1.0(ap≤1.0mm) 0.06~ 0.1 ~0.2(ap≤3.5mm)	0.5~ 1.0 ~1.5(ap≤1.0mm) 0.06~ 0.15 ~0.3(ap≤3.5mm)	0.5~ 1.2 ~1.8(ap≤1.0mm) 0.06~ 0.2 ~0.3(ap≤3.5mm)	☆ 100~ 160 ~220	★ 100~ 160 ~220	-	-	-	
	Mold steel (~40HRC)	0.5~ 0.8 ~1.0(ap≤1.0mm) 0.06~ 0.08 ~0.15(ap≤3.5mm)	0.5~ 0.8 ~1.2(ap≤1.0mm) 0.06~ 0.1 ~0.2(ap≤3.5mm)	0.5~ 1.0 ~1.6(ap≤1.0mm) 0.06~ 0.15 ~0.2(ap≤3.5mm)	☆ 80~ 140 ~180	★ 80~ 140 ~180	-	-	-	
	Mold steel (40~50HRC)	0.2~ 0.3 ~0.5(ap≤1.0mm) 0.03~ 0.05 ~0.1(ap≤3.5mm)	0.2~ 0.5 ~0.8(ap≤1.0mm) 0.03~ 0.08 ~0.15(ap≤3.5mm)	0.2~ 0.6 ~0.9(ap≤1.0mm) 0.03~ 0.1 ~0.15(ap≤3.5mm)	☆ 60~ 100 ~130	★ 60~ 100 ~130	-	-	-	
	Stainless steel (Austenitic related)	0.5~ 0.7 ~0.8(ap≤1.0mm) 0.06~ 0.08 ~0.15(ap≤3.5mm)	0.5~ 0.8 ~1.2(ap≤1.0mm) 0.06~ 0.1 ~0.2(ap≤3.5mm)	0.5~ 1.0 ~1.6(ap≤1.0mm) 0.06~ 0.15 ~0.2(ap≤3.5mm)	★ 100~ 160 ~200	☆ 100~ 160 ~200	-	-	-	
	Stainless steel (Martensitic related)	0.5~ 0.7 ~0.8(ap≤1.0mm) 0.06~ 0.08 ~0.15(ap≤3.5mm)	0.5~ 0.8 ~1.2(ap≤1.0mm) 0.06~ 0.1 ~0.2(ap≤3.5mm)	0.5~ 1.0 ~1.6(ap≤1.0mm) 0.06~ 0.15 ~0.2(ap≤3.5mm)	☆ 150~ 200 ~250	-	-	-	★ 180~ 240 ~300	
	Stainless steel (Precipitation hardening)	0.5~ 0.7 ~0.8(ap≤1.0mm) 0.06~ 0.08 ~0.15(ap≤3.5mm)	0.5~ 0.8 ~1.2(ap≤1.0mm) 0.06~ 0.1 ~0.2(ap≤3.5mm)	0.5~ 1.0 ~1.6(ap≤1.0mm) 0.06~ 0.15 ~0.2(ap≤3.5mm)	★ 90~ 120 ~150	-	-	-	-	
	Gray cast iron	0.5~ 0.8 ~1.0(ap≤1.0mm) 0.06~ 0.1 ~0.2(ap≤3.5mm)	0.5~ 1.0 ~1.5(ap≤1.0mm) 0.06~ 0.15 ~0.3(ap≤3.5mm)	0.5~ 1.2 ~1.8(ap≤1.0mm) 0.06~ 0.2 ~0.3(ap≤3.5mm)	-	-	★ 120~ 180 ~250	-	-	
	Nodular cast iron	0.5~ 0.7 ~0.8(ap≤1.0mm) 0.06~ 0.08 ~0.15(ap≤3.5mm)	0.5~ 0.8 ~1.2(ap≤1.0mm) 0.06~ 0.1 ~0.2(ap≤3.5mm)	0.5~ 1.0 ~1.6(ap≤1.0mm) 0.06~ 0.15 ~0.2(ap≤3.5mm)	-	-	★ 100~ 150 ~200	-	-	
	Ni-base heat-resistant alloys	0.2~ 0.4 ~0.6(ap≤1.0mm) 0.03~ 0.05 ~0.1(ap≤3.5mm)	0.2~ 0.5 ~0.9(ap≤1.0mm) 0.03~ 0.08 ~0.15(ap≤3.5mm)	0.2~ 0.6 ~1.0(ap≤1.0mm) 0.03~ 0.1 ~0.15(ap≤3.5mm)	☆ 20~ 30 ~50	-	-	-	★ 20~ 30 ~50	
	Titanium alloys	0.2~ 0.4 ~0.6(ap≤1.0mm) 0.03~ 0.05 ~0.1(ap≤3.5mm)	0.2~ 0.5 ~0.9(ap≤1.0mm) 0.03~ 0.08 ~0.15(ap≤3.5mm)	0.2~ 0.6 ~1.0(ap≤1.0mm) 0.03~ 0.1 ~0.15(ap≤3.5mm)	★ 40~ 60 ~80	-	☆ 30~ 50 ~70	-	-	
	FL	Carbon steel	0.5~ 0.8 ~1.0(ap≤1.0mm) 0.2~ 0.4 ~0.5(ap≤1.5mm)	0.5~ 1.0 ~1.5(ap≤1.0mm) 0.3~ 0.7 ~1.0(ap≤1.5mm)	0.5~ 1.2 ~1.8(ap≤1.0mm) 0.4~ 1.0 ~1.5(ap≤1.5mm)	☆ 120~ 180 ~250	★ 120~ 180 ~250	-	-	-
		Alloy steel	0.5~ 0.8 ~1.0(ap≤1.0mm) 0.2~ 0.4 ~0.5(ap≤1.5mm)	0.5~ 1.0 ~1.5(ap≤1.0mm) 0.3~ 0.7 ~1.0(ap≤1.5mm)	0.5~ 1.2 ~1.8(ap≤1.0mm) 0.4~ 1.0 ~1.5(ap≤1.5mm)	☆ 100~ 160 ~220	★ 100~ 160 ~220	-	-	-
Mold steel (~40HRC)		0.5~ 0.8 ~1.0(ap≤1.0mm) 0.2~ 0.3 ~0.4(ap≤1.5mm)	0.5~ 0.8 ~1.2(ap≤1.0mm) 0.3~ 0.6 ~0.8(ap≤1.5mm)	0.5~ 1.0 ~1.6(ap≤1.0mm) 0.4~ 0.8 ~1.2(ap≤1.5mm)	☆ 80~ 140 ~180	★ 80~ 140 ~180	-	-	-	
Mold steel (40~50HRC)		0.15~ 0.3 ~0.5(ap≤1.0mm) 0.15~ 0.2 ~0.25(ap≤1.5mm)	0.2~ 0.5 ~0.8(ap≤1.0mm) 0.2~ 0.3 ~0.45(ap≤1.5mm)	0.2~ 0.6 ~0.9(ap≤1.0mm) 0.2~ 0.5 ~0.7(ap≤1.5mm)	☆ 60~ 100 ~130	★ 60~ 100 ~130	-	-	-	
Stainless steel (Austenitic related)		0.5~ 0.7 ~0.8(ap≤1.0mm) 0.2~ 0.3 ~0.4(ap≤1.5mm)	0.5~ 0.8 ~1.2(ap≤1.0mm) 0.3~ 0.6 ~0.8(ap≤1.5mm)	0.5~ 1.0 ~1.6(ap≤1.0mm) 0.4~ 0.8 ~1.2(ap≤1.5mm)	★ 100~ 160 ~200	☆ 100~ 160 ~200	-	-	-	
Stainless steel (Martensitic related)		0.5~ 0.7 ~0.8(ap≤1.0mm) 0.2~ 0.3 ~0.4(ap≤1.5mm)	0.5~ 0.8 ~1.2(ap≤1.0mm) 0.3~ 0.6 ~0.8(ap≤1.5mm)	0.5~ 1.0 ~1.6(ap≤1.0mm) 0.4~ 0.8 ~1.2(ap≤1.5mm)	☆ 150~ 200 ~250	-	-	-	★ 180~ 240 ~300	
Stainless steel (Precipitation hardening)		0.5~ 0.7 ~0.8(ap≤1.0mm) 0.2~ 0.3 ~0.4(ap≤1.5mm)	0.5~ 0.8 ~1.2(ap≤1.0mm) 0.3~ 0.6 ~0.8(ap≤1.5mm)	0.5~ 1.0 ~1.6(ap≤1.0mm) 0.4~ 0.8 ~1.2(ap≤1.5mm)	★ 90~ 120 ~150	-	-	-	-	
Gray cast iron		0.5~ 0.8 ~1.0(ap≤1.0mm) 0.2~ 0.4 ~0.5(ap≤1.5mm)	0.5~ 1.0 ~1.5(ap≤1.0mm) 0.3~ 0.7 ~1.0(ap≤1.5mm)	0.5~ 1.2 ~1.8(ap≤1.0mm) 0.4~ 1.0 ~1.5(ap≤1.5mm)	-	-	★ 120~ 180 ~250	-	-	
Nodular cast iron		0.5~ 0.7 ~0.8(ap≤1.0mm) 0.2~ 0.3 ~0.4(ap≤1.5mm)	0.5~ 0.8 ~1.2(ap≤1.0mm) 0.3~ 0.6 ~0.8(ap≤1.5mm)	0.5~ 1.0 ~1.6(ap≤1.0mm) 0.4~ 0.8 ~1.2(ap≤1.5mm)	-	-	★ 100~ 150 ~200	-	-	
Ni-base heat-resistant alloys		0.2~ 0.4 ~0.6(ap≤1.0mm) 0.15~ 0.2 ~0.3(ap≤1.5mm)	0.2~ 0.5 ~0.9(ap≤1.0mm) 0.2~ 0.4 ~0.6(ap≤1.5mm)	0.2~ 0.6 ~1.0(ap≤1.0mm) 0.2~ 0.5 ~0.8(ap≤1.5mm)	☆ 20~ 30 ~50	-	-	-	★ 20~ 30 ~50	
Titanium alloys		0.2~ 0.4 ~0.6(ap≤1.0mm) 0.15~ 0.2 ~0.3(ap≤1.5mm)	0.2~ 0.5 ~0.9(ap≤1.0mm) 0.2~ 0.4 ~0.6(ap≤1.5mm)	0.2~ 0.6 ~1.0(ap≤1.0mm) 0.2~ 0.5 ~0.8(ap≤1.5mm)	★ 40~ 60 ~80	-	☆ 30~ 50 ~70	-	-	

★ : 1st Recommendation ☆ : 2nd Recommendation

* Machining with coolant is recommended for Ni-base heat-resistant alloys and titanium alloys.

* The bold-faced number indicates a center value of recommended cutting condition.

Adjust the cutting speed and the feed rate within the above conditions according to the actual machining situation.

* When finishing with LD type and FL type inserts, recommended feed rate for SOMT14 LD type: f=1.5(mm/rev) or less/for SOMT10 LD type: f=0.9(mm/rev) or less for SOMT14 FL type: f=3.0(mm/rev) or less/for SOMT10 FL type: f=1.4(mm/rev) or less

* For machining center equivalent to BT30, reduce feed rate to 25% or less of the recommended condition.

* For slotting, internal coolant is recommended.



- Cutting edge angle 45°~70°
- Cutting edge angle 75°
- Cutting edge angle 88°/90°
- Cutter for Finishing
- High Feed Cutter
- Multi-Function
- Slot Mill
- Ball-nose Radius
- Others

Recommended cutting conditions

Insert type	Workpiece material	Toolholder description and feed rate (fz: mm/t)		Recommended insert grades (Vc: m/min)					
		MFH...R-10-...	MFH...R-14-...	MEGACOAT NANO			MEGACOAT HARD	CVD Coated carbide	
				PR1535	PR1525	PR1510	PR015S	CA6535	
GM GH	Carbon steel	0.5~ 1.5 ~2.0		☆ 120~ 180 ~250	★ 120~ 180 ~250	-	-	-	
	Alloy steel	0.5~ 1.5 ~2.0		☆ 100~ 160 ~220	★ 100~ 160 ~220	-	-	-	
	Mold steel (~40HRC)	0.5~ 1.2 ~1.8		☆ 80~ 140 ~180	★ 80~ 140 ~180	-	GH★ 80~ 140 ~180	-	
	Mold steel (40~50HRC)	0.2~ 0.7 ~1.0		-	☆ 60~ 100 ~130	-	GH★ 60~ 100 ~130	-	
	Mold steel (50~55HRC)	0.2~ 0.5 ~0.8		-	☆ 50~ 70 ~100	-	GH★ 50~ 70 ~100	-	
	Mold steel (55~60HRC)	0.03~ 0.06 ~0.1(ap≤1.0mm) Recommended only for GH chipbreaker		-	-	-	GH☆ 50~ 60 ~70	-	
	Stainless steel (Austenitic related)	0.5~ 1.2 ~1.8		GM☆ 100~ 160 ~200	GM☆ 100~ 160 ~200	-	-	-	
	Stainless steel (Martensitic related)	0.5~ 1.2 ~1.8		☆ 150~ 200 ~250	-	-	-	★ 180~ 240 ~300	
	Stainless steel (Precipitation hardening)	0.5~ 1.2 ~1.8		★ 90~ 120 ~150	-	-	-	-	
	Gray cast iron	0.5~ 1.5 ~2.0		-	-	★ 120~ 180 ~250	-	-	
	Nodular cast iron	0.5~ 1.2 ~1.8		-	-	★ 100~ 150 ~200	-	-	
	Ni-base heat-resistant alloys	0.2~ 0.8 ~1.2		☆ 20~ 30 ~50	-	-	-	★ 20~ 30 ~50	
	Titanium alloys	0.2~ 0.8 ~1.2		GM★ 40~ 60 ~80	-	GM☆ 30~ 50 ~70	-	-	
LD	Carbon steel	0.5~ 1.5 ~2.0(ap≤1.0mm) 0.06~ 0.2 ~0.3(ap≤3.5mm)	0.5~ 1.5 ~2.0(ap≤2.0mm) 0.06~ 0.2 ~0.4(ap≤5.0mm)	☆ 120~ 180 ~250	★ 120~ 180 ~250	-	-	-	
	Alloy steel	0.5~ 1.5 ~2.0(ap≤1.0mm) 0.06~ 0.2 ~0.3(ap≤3.5mm)	0.5~ 1.5 ~2.0(ap≤2.0mm) 0.06~ 0.2 ~0.4(ap≤5.0mm)	☆ 100~ 160 ~220	★ 100~ 160 ~220	-	-	-	
	Mold steel (~40HRC)	0.5~ 1.2 ~1.8(ap≤1.0mm) 0.06~ 0.15 ~0.2(ap≤3.5mm)	0.5~ 1.2 ~1.8(ap≤2.0mm) 0.06~ 0.15 ~0.3(ap≤5.0mm)	☆ 80~ 140 ~180	★ 80~ 140 ~180	-	-	-	
	Mold steel (40~50HRC)	0.2~ 0.7 ~1.0(ap≤1.0mm) 0.03~ 0.1 ~0.15(ap≤3.5mm)	0.2~ 0.7 ~1.0(ap≤2.0mm) 0.03~ 0.1 ~0.2(ap≤5.0mm)	☆ 60~ 100 ~130	★ 60~ 100 ~130	-	-	-	
	Stainless steel (Austenitic related)	0.5~ 1.2 ~1.8(ap≤1.0mm) 0.06~ 0.15 ~0.2(ap≤3.5mm)	0.5~ 1.2 ~1.8(ap≤2.0mm) 0.06~ 0.15 ~0.3(ap≤5.0mm)	★ 100~ 160 ~200	☆ 100~ 160 ~200	-	-	-	
	Stainless steel (Martensitic related)	0.5~ 1.2 ~1.8(ap≤1.0mm) 0.06~ 0.15 ~0.2(ap≤3.5mm)	0.5~ 1.2 ~1.8(ap≤2.0mm) 0.06~ 0.15 ~0.3(ap≤5.0mm)	☆ 150~ 200 ~250	-	-	-	★ 180~ 240 ~300	
	Stainless steel (Precipitation hardening)	0.5~ 1.2 ~1.8(ap≤1.0mm) 0.06~ 0.15 ~0.2(ap≤3.5mm)	0.5~ 1.2 ~1.8(ap≤2.0mm) 0.06~ 0.15 ~0.3(ap≤5.0mm)	★ 90~ 120 ~150	-	-	-	-	
	Gray cast iron	0.5~ 1.5 ~2.0(ap≤1.0mm) 0.06~ 0.2 ~0.3(ap≤3.5mm)	0.5~ 1.5 ~2.0(ap≤2.0mm) 0.06~ 0.2 ~0.4(ap≤5.0mm)	-	-	★ 120~ 180 ~250	-	-	
	Nodular cast iron	0.5~ 1.2 ~1.8(ap≤1.0mm) 0.06~ 0.15 ~0.2(ap≤3.5mm)	0.5~ 1.2 ~1.8(ap≤2.0mm) 0.06~ 0.15 ~0.3(ap≤5.0mm)	-	-	★ 100~ 150 ~200	-	-	
	Ni-base heat-resistant alloys	0.2~ 0.8 ~1.2(ap≤1.0mm) 0.03~ 0.1 ~0.15(ap≤3.5mm)	0.2~ 0.8 ~1.2(ap≤2.0mm) 0.03~ 0.1 ~0.2(ap≤5.0mm)	☆ 20~ 30 ~50	-	-	-	★ 20~ 30 ~50	
	Titanium alloys	0.2~ 0.8 ~1.2(ap≤1.0mm) 0.03~ 0.1 ~0.15(ap≤3.5mm)	0.2~ 0.8 ~1.2(ap≤2.0mm) 0.03~ 0.1 ~0.2(ap≤5.0mm)	★ 40~ 60 ~80	-	☆ 30~ 50 ~70	-	-	
	FL	Carbon steel	0.5~ 1.5 ~2.0		☆ 120~ 180 ~250	★ 120~ 180 ~250	-	-	-
		Alloy steel	0.5~ 1.5 ~2.0		☆ 100~ 160 ~220	★ 100~ 160 ~220	-	-	-
Mold steel (~40HRC)		0.5~ 1.2 ~1.8		☆ 80~ 140 ~180	★ 80~ 140 ~180	-	-	-	
Mold steel (40~50HRC)		0.2~ 0.7 ~1.0		☆ 60~ 100 ~130	★ 60~ 100 ~130	-	-	-	
Stainless steel (Austenitic related)		0.5~ 1.2 ~1.8		★ 100~ 160 ~200	☆ 100~ 160 ~200	-	-	-	
Stainless steel (Martensitic related)		0.5~ 1.2 ~1.8		☆ 150~ 200 ~250	-	-	-	★ 180~ 240 ~300	
Stainless steel (Precipitation hardening)		0.5~ 1.2 ~1.8		★ 90~ 120 ~150	-	-	-	-	
Gray cast iron		0.5~ 1.5 ~2.0		-	-	★ 120~ 180 ~250	-	-	
Nodular cast iron		0.5~ 1.2 ~1.8		-	-	★ 100~ 150 ~200	-	-	
Ni-base heat-resistant alloys		0.2~ 0.8 ~1.2		☆ 20~ 30 ~50	-	-	-	★ 20~ 30 ~50	
Titanium alloys		0.2~ 0.8 ~1.2		★ 40~ 60 ~80	-	☆ 30~ 50 ~70	-	-	

* Machining with coolant is recommended for Ni-base heat-resistant alloys and titanium alloys.

★: 1st Recommendation ☆: 2nd Recommendation

* The bold-faced number indicates a center value of recommended cutting condition.

Adjust the cutting speed and the feed rate within the above conditions according to the actual machining situation.

* When finishing with LD type and FL type inserts, recommended feed rate for SOMT14 LD type: f=1.5(mm/rev) or less/for SOMT10 LD type: f=0.9(mm/rev) or less for SOMT14 FL type: f=3.0(mm/rev) or less/for SOMT10 FL type: f=1.4(mm/rev) or less

* For machining center equivalent to BT30, reduce feed rate to 25% or less of the recommended condition.

* For slotting, internal coolant is recommended.



Milling

Note for machining program (Approx. R)

Shape	Description	Insert type	Cutting edge angle γ	Approx. R (mm)	Unmachined portion K (mm)	Max. inclination angle of workpiece at contouring
	MFH...-10-...	GM / GH	10°	3.0	0.85	90°
		FL	14°	3.0	0.89	80°
		LD	14°	3.5	0.69	65°
	MFH...-14-...	GM / GH	10°	3.5	1.37	90°
		FL	13°	3.0	1.36	80°
		LD	16°	5.0	1.06	65°

Reference data for ramping

MFH...-10-...

Cutter dia. DCX (mm)	25	28	32	35	40	50	63	80
Max. ramping angle RMPX	5°	4.5°	4°	3.5°	3°	2.5°	2°	1°
tan RMPX	0.087	0.078	0.070	0.061	0.052	0.043	0.035	0.017

MFH...-14-...

Cutter dia. DCX (mm)	50	63	80	100	125	160
Max. ramping angle RMPX	2°	1.8°	1°	0.5°	0.4°	0.2°
tan RMPX	0.035	0.031	0.017	0.009	0.007	0.003

M



Milling

Guide for ramping (Slant milling)

Ramping angle should be RMPX (Maximum ramping angle) or under in the above cutting conditions.
Feed rate should be 70% or under of the above cutting conditions.

Formula of the cutting length "L" at max. ramping angle

$$L = \frac{ap}{\tan RMPX}$$

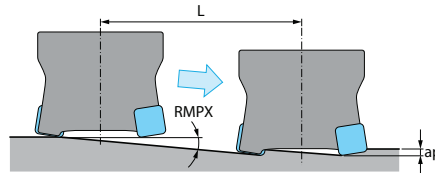

Vertical milling (Plunging)

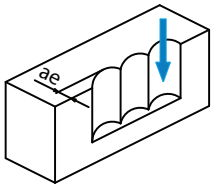

Insert description	Max. width of cut (ae)
SOMT10	8mm
SOMT14	11.5mm

*Vertical milling (Plunging) is available only with GM/GH type insert. (LD type and FL type are not applicable)
For vertical milling (plunging), reduce feed rate to $fz=0.2\text{mm/t}$ or less.

Cutting edge angle 45°~70°

Cutting edge angle 75°

Cutting edge angle 88°/90°

Cutter for Finishing

High Feed Cutter

Multi-Function

Slot Mill

Ball-nose Radius

Others

Guide for helical milling

For helical milling, use between min. cutting dia. and max. cutting dia.

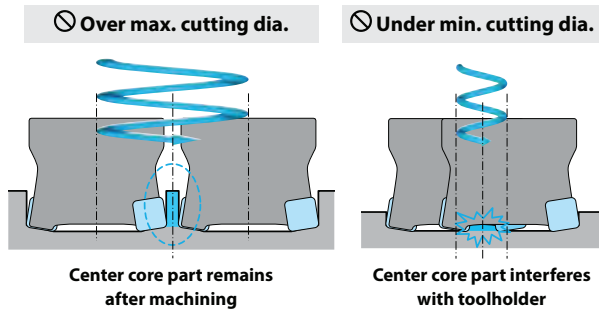

Description	Min. cutting dia.	Max. cutting dia.
MFH...-10-...	2×DCX-18	2×DCX-2
MFH...-14-...	2×DCX-25	2×DCX-2

Unit: mm

- Sinking depth (h) at helical milling should be under max. depth of cut (APMX) in the cutter dimension chart.
- Down-cut milling is recommended. (Ref. to the right figure)
- Feed rate should be under 50% of the recommended cutting conditions.
- Use caution to eliminate incidences caused by producing long chips.

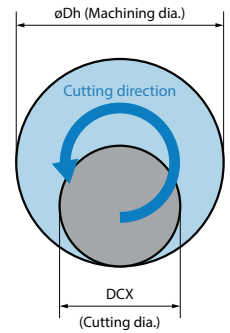

Guide for drilling

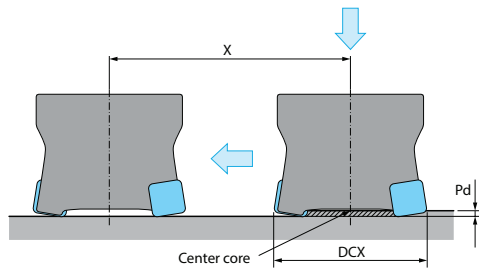

3D machining

Insert type	Ramping	Contouring (Rising wall angle)	Vertical	Helical milling	Pocketing
GM / GH	✓	✓ (90°)	✓	✓	✓
LD	✓	△ (65°)	×	×	×
FL	✓	△ (80°)	×	×	×

- Some applications are not available depending on insert type.
- For FL and LD type, there is a limit of rising wall angle at contouring.

Description	GM type / GH type		LD type		FL type	
	Max. cutting depth Pd	Min. cutting length X for flat bottom surface	Max. cutting depth Pd	Min. cutting length X for flat bottom surface	Max. cutting depth Pd	Min. cutting length X for flat bottom surface
MFH...-10-...	1.5	DCX-18	1.5	DCX-14	1.5	DCX-15
MFH...-14-...	2	DCX-24	2	DCX-18	2	DCX-19

[Drilling depth] Please refer to Pd (Max. cutting depth) in the chart.
[When traversing after drilling]

1. Reduce feed rate 25% or less of the recommended conditions until the center core part (Unmachined part) is removed.
2. When drilling, reduce feed rate per revolution to $f=0.2\text{mm/rev}$ or under.

Unit: mm



High feed and large depth of cut milling

MFH Boost

Large D.O.C. for greater milling capabilities
Excellent performance in a wide range of applications, including automotive parts, difficult-to-cut materials, and molds

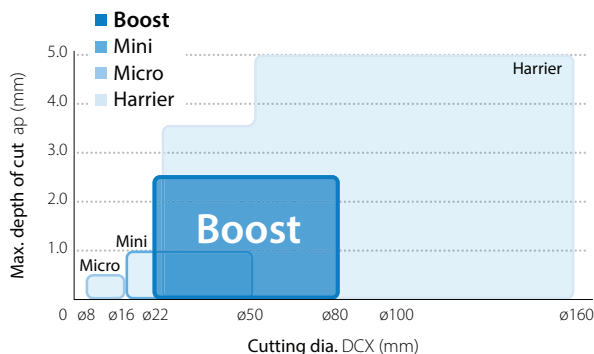

1 High feed milling with large depth of cut capabilities

A small 04 size insert (4-edge, double-sided insert) supports depths of cut up to 2.5 mm with cutting dia. available from $\phi 22$ mm.

Achieves high efficiency machining in various shouldering, slotting, helical milling, and ramping applications.

4-edge, double-sided insert

Max. depth of cut **2.5 mm**

MFH Boost Advantage

Feed rate (mm/min)	90° End mill (mm)	MFH Boost (mm)	Conventional high feed cutter (mm)
0	6.0	2.5	0
0.2	6.0	2.5	0
0.3	3.0	2.5	0
0.5	2.5	2.5	0
0.8	1.5	1.5	0
1.0	1.0	1.0	0
1.3	0.5	0.5	0.5
1.6	0	0	0.5

BT50

M

Milling

- Cutting edge angle 45°~70°
- Cutting edge angle 75°
- Cutting edge angle 88°/90°
- Cutter for Finishing
- High Feed Cutter
- Multi-Function
- Slot Mill
- Ball-nose Radius
- Others

2 Available for a variety of machining applications and environments

1 Solutions for 90° end mills (Rough to medium-finish machining)

High feed rates dramatically improve machining efficiency

Machining efficiency simulation example

Pocketing: Vc = 150 m/min, ae = 12.5 mm

MFH Boost
ø 25 (3 Inserts)

100 cc/min

ap = 2.0 mm, fz = 0.7 mm/t

Machining efficiency
x 1.8

Conventional
90° end mill
ø 25 (3 Inserts)

54 cc/min

ap = 5.0 mm, fz = 0.15 mm/t

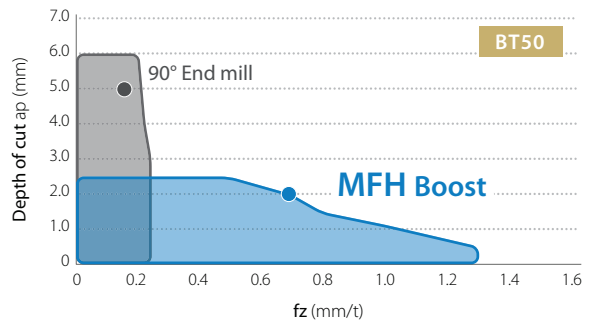

High efficiency and good tool life

Machining efficiency and cutting edge condition comparison (Internal evaluation)

Cutting edge condition after 100 min machining

MFH Boost

ap = 1.6 mm, fz = 0.6 mm/t

Competitor A 90° end mill

ap = 5.0 mm, fz = 0.15 mm/t

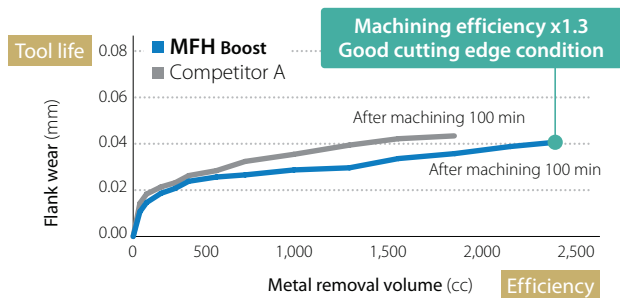

Vc = 150 m/min, ae = 12.5 mm, dry, 42CrMo4, ø 25 (1 Insert) BT50

High stability in unstable machining environment

Chatter resistance comparison (Internal evaluation)

Slotting

ø 25 (3 Inserts)
External air
C50
BT50

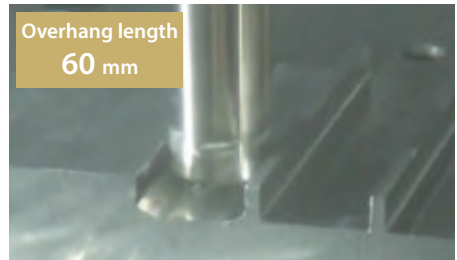

Video



Machining efficiency

MFH Boost

103 cc/min

Vc = 120 m/min, ap = 1.5 mm, fz = 0.6 mm/t

Machining efficiency
x 4.5

Competitor A
90° End Mill

31 cc/min

Chattering (Machining was impossible)

Vc = 80 m/min, ap = 2 mm, fz = 0.2 mm/t

23 cc/min

Vc = 80 m/min, ap = 2 mm, fz = 0.15 mm/t

High efficiency and stable machining designs

Kyocera's original technology

Convex cutting edge design reduces impact when entering workpiece

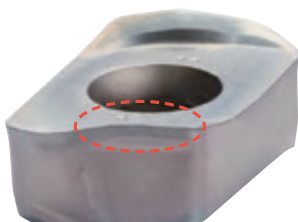

Cutting force when entering workpiece (Internal evaluation)

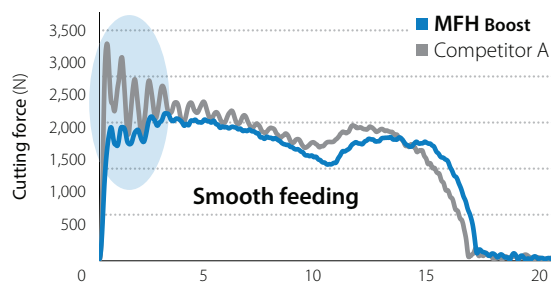

Vc = 150 m/min, ap = 2.0 mm, ae = 25 mm, fz = 0.7 mm/t,

M
Milling

2 Better solution than conventional high feed cutters

Large D.O.C. dramatically improves machining efficiency

Machining efficiency simulation example

Multistage machining (Depth 30 mm): Vc = 150 m/min, ae = 12.5 mm

MFH Boost
ø 25 (3 Inserts)

100 cc/min

ap = 2.0 mm, fz = 0.7 mm/t

Machining efficiency
x 1.3

Conventional high feed cutter
ø 25 (3 Inserts)

76 cc/min

ap = 1.0 mm, fz = 0.8 mm/t

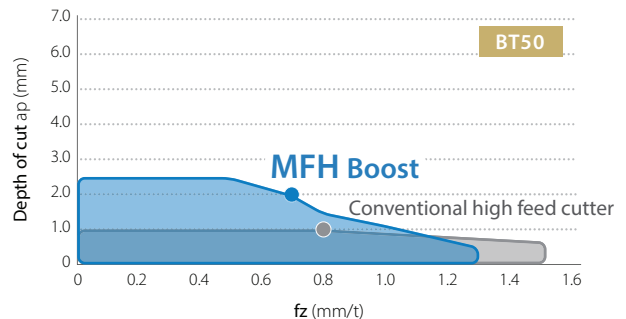

High efficiency and good tool life

Machining efficiency and cutting edge condition comparison (Internal evaluation)

Cutting edge condition after 100 min machining

MFH Boost

ap = 1.6 mm, fz = 0.6 mm/t

Competitor B High feed type

ap = 0.8 mm, fz = 0.6 mm/t

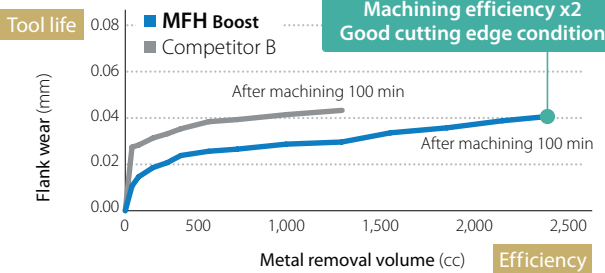

Vc = 150 m/min, ae = 12.5 mm, dry, 42CrMo4, ø 25 (1 Insert), BT50

Excellent wall accuracy

Machining efficiency and wall accuracy comparison (Internal evaluation)

Pocketing (Depth 12mm)

MFH Boost
ø 25 (3 Inserts)

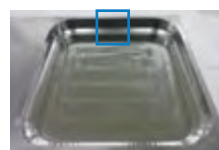

ap = 1.5 mm × 8 passes
Q = 115 cc/min

Competitor B High feed type
ø 25 (4 Inserts)



ap = 0.8 mm × 15 passes
Q = 81 cc/min

Cutting conditions: Vc = 200 m/min, ae = 12.5 mm, fz = 0.8 mm/t, dry, C50, BT50

Superior wall accuracy



Wiper on outer periphery

Reduction of wall level variation in multi-pass machining

3 Solutions for machining difficult-to-cut materials

Dramatic improvement in machining efficiency with titanium alloy, stainless steel machining, etc.

Machining efficiency comparison (Internal evaluation)

Titanium alloy pocketing (Depth 6 mm)

MFH Boost

Approx. 1' 30"

ap = 1.5 mm × 4 passes (fz = ~0.35 mm/t)

Machining efficiency
x 1.8

Competitor C
High feed type

Approx. 2' 50"

ap = 0.6 mm × 10 passes (fz = ~0.4 mm/t)

Vc = 50 m/min, ae = 12.5 mm (ae/DCX = 50%), Ramping angle 3°, Ti-6Al-4V, wet, ø 25 (3 inserts), BT50

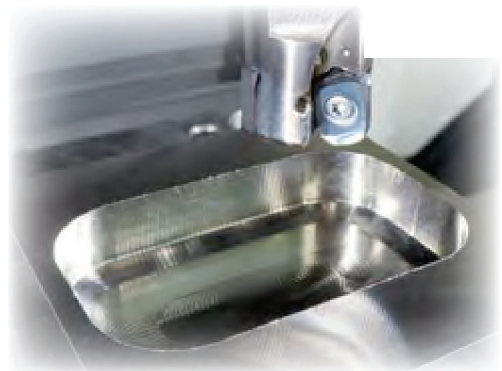

M

Milling

Cutting edge angle 45°~70°

Cutting edge angle 75°

Cutting edge angle 88°/90°

Cutter for Finishing

High Feed Cutter

Multi-Function

Slot Mill

Ball-nose Radius

Others

MFH Boost

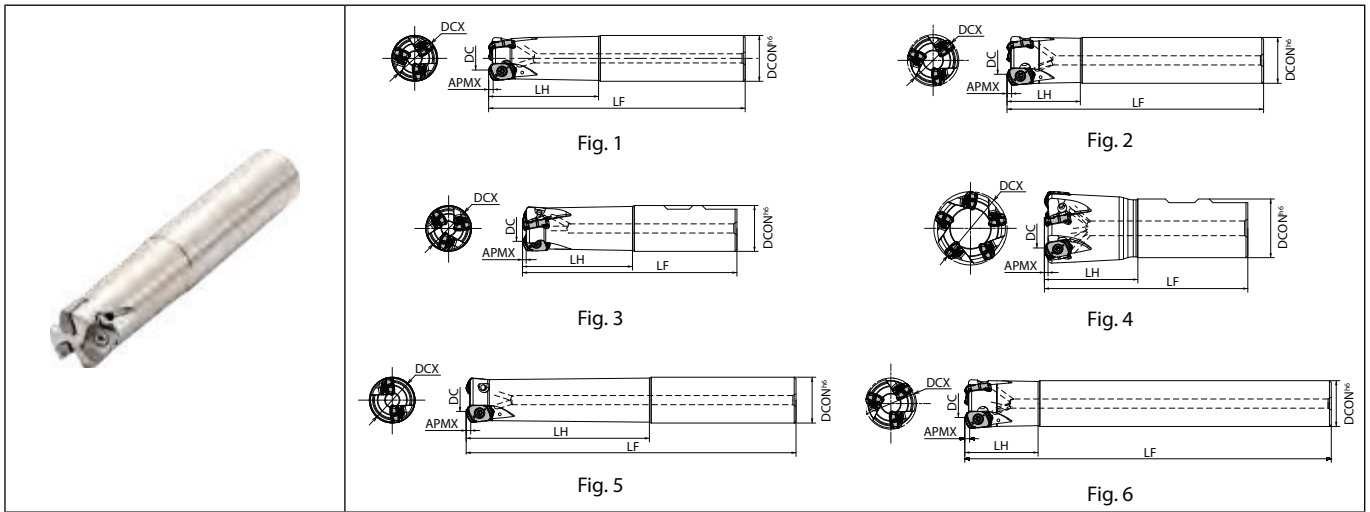

Toolholder dimensions

Description	Availability	Inserts	Dimension (mm)						A.R. (°)	Coolant hole	Max. revolution (min ⁻¹)	Weight (kg)	Fig.	Spare parts			Applicable inserts ➔ M192	
			DC	DCX	DCON	LF	LH	APMX						Anti-seize compound	Screw	Wrench		
			P-37			SB-3575TRP								DTPM-10				
Cylindrical	Same shank	MFH 25-S25-04-2T	● 2	14	25	25	140	60	2.5	-10	Yes	12700	0.5	1	P-37	SB-3575TRP	DTPM-10	LOMU040410ER-GM
		MFH 25-S25-04-3T	● 3									11200	0.8	1				
		MFH 32-S32-04-4T	● 4	21	32	32	150	70						1				
		MFH 32-S32-04-5T	● 5											1				
	Standard shank	MFH 22-S20-04-2T	● 2	11	22	20	130	30	2.5	-10	Yes	13600	0.3	2	P-37	SB-3575TRP	DTPM-10	LOMU040410ER-GM
		MFH 28-S25-04-3T	● 3	17	28	25	140	40				12000	0.5	2				
		MFH 28-S25-04-4T	● 4									10700	0.8	2				
		MFH 35-S32-04-4T	● 4	24	35									2				
		MFH 35-S32-04-5T	● 5			32	150	50						2				
		MFH 40-S32-04-5T	● 5	29	40							10000	0.9	2				
	Long Shank	MFH 25-S25-04-2T-180	● 2	14	25	25	180	100	2.5	-10	Yes	12700	0.6	5	P-37	SB-3575TRP	DTPM-10	LOMU040410ER-GM
		MFH 25-S25-04-3T-180	● 3	17	28		40	12000				0.7	6					
MFH 28-S25-04-3T-200		● 3						11200				1.1	5					
MFH 32-S32-04-4T-200		● 4	21	32		200	120						6					
MFH 35-S32-04-4T-200		● 4	24	35	32		50	10700				1.1	6					
MFH 40-S32-04-5T-250		● 5	29	40		250		10000				1.5	6					
Weldon	MFH 25-W25-04-2T	● 2	14	25	25	117	60	2.5	-10	Yes	12700	0.4	3	P-37	SB-3575TRP	DTPM-10	LOMU040410ER-GM	
	MFH 25-W25-04-3T	● 3											3					
	MFH 32-W32-04-4T	● 4	21	32		131	70				11200		3					
	MFH 32-W32-04-5T	● 4			32								3					
	MFH 40-W32-04-5T	● 5										0.7	4					
	MFH 40-W32-04-6T	● 6	29	40		111	50				10000		4					

Max. revolution : Do not use the cutter at the maximum revolution or higher since the centrifugal force may cause inserts and parts to scatter even under no load.
Coat Anti-seize Compound thinly on portion of taper and thread when insert is fixed.

● : Standard item R : Right-hand only L : Left-hand only □ : Check availability



Milling

MFH Boost

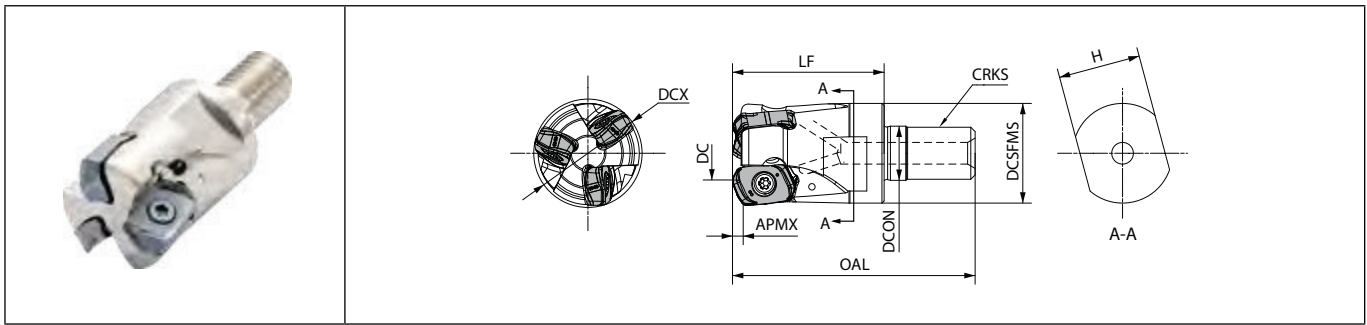

Toolholder dimensions

Description	Availability	Inserts	Dimension (mm)									A.R. (°)	Coolant hole	Max. revolution (min ⁻¹)	Spare parts			Applicable inserts ● M192
			DC	DCX	DCON	DCSFMS	OAL	LF	APMX	CRKS	H				Anti-seize compound	Screw	Wrench	
MFH 22-M10-04-2T	●	2	11	22	10.5	18.7	48	30		M10X1.5	15		13600	P-37	SB-3575TRP	DTPM-10	LOMU040410ER-GM	
25-M12-04-2T	●	2	14	25	12.5	23	56	35		M12X1.75	19		12700					
25-M12-04-3T	●		3	17									28					12000
28-M12-04-3T	●	4		21	32	11200												
28-M12-04-4T	●		5	24	35	10700												
32-M16-04-4T	●	5		29	40	17	30	62	40	M16X2.0	24		10000					
32-M16-04-5T	●		10000															
35-M16-04-4T	●	4	24	35	17	30	62	40	M16X2.0	24		10000						
35-M16-04-5T	●	5	29	40	17	30	62	40	M16X2.0	24		10000						
40-M16-04-5T	●	6	31	42	17	30	62	40	M16X2.0	24		9800						
40-M16-04-6T	●	6	31	42	17	30	62	40	M16X2.0	24		9800						
42-M16-04-5T	●	5	31	42	17	30	62	40	M16X2.0	24		9800						
42-M16-04-6T	●	6	31	42	17	30	62	40	M16X2.0	24		9800						

Max. revolution : Do not use the cutter at the maximum revolution or higher since the centrifugal force may cause inserts and parts to scatter even under no load.

Coat Anti-seize Compound thinly on portion of taper and thread when insert is fixed.

See page M60 for applicable arbor (BT arbor for exchangeable head / double-face clamping spindle)



Milling

LOMU

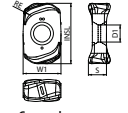
Insert		Description	No. of edges	Dimension (mm)					Carbide			Applicable toolholder M189~M191	
				S	D1	RE	W1	INSL	CVD	PVD			
									CA6535	PR1510	PR1525	PR1535	
  <p>General purpose</p>		LOMU 040410ER-GM	4	4.4	4.1	1	9.1	14.5	●	●	●	●	MFH...-04-..

Classification of usage

★ : Roughing / 1st Choice
 ☆ : Roughing / 2nd Choice
 ■ : Finishing / 1st Choice
 □ : Finishing / 2nd Choice
 (In case hardness is 45HRC or under)

Carbon steel / Alloy steel			★	☆	P
Mold and die steel			★	☆	
Austenitic stainless steel			☆	★	M
Martensitic stainless steel	★			☆	
Precipitation hardening stainless steel			★		
Gray cast iron			★		K
Nodular cast iron			★		
Non-ferrous metals					N
Heat-resistant alloy	★			☆	S
Titanium alloy				★	
Hard materials					H

Handed insert shows Right-hand

Recommended cutting conditions M193

M



- Cutting edge angle 45°~70°
- Cutting edge angle 75°
- Cutting edge angle 88°/90°
- Cutter for Finishing
- High Feed Cutter
- Multi-Function
- Slot Mill
- Ball-nose Radius
- Others

● : Standard item R : Right-hand only L : Left-hand only □ : Check availability

M192

Recommended cutting conditions ★ 1st recommendation ☆ 2nd recommendation

Chipbreaker	Workpiece	Toolholder description and feed (fz: mm/t)		Recommended insert grade (Vc: m/min)			
		ap(mm)	MFH...04...	MEGACOAT NANO			CVD Coating
				PR1535	PR1525	PR1510	CA6535
GM	Carbon steel (~ 280HB)	≤ 0.5	0.20 - 0.80 - 1.30	120 - 160 - 220	120 - 160 - 220	-	-
		≤ 1.0	0.20 - 0.70 - 1.10				
		≤ 1.5	0.20 - 0.60 - 0.80				
		≤ 2.0	0.20 - 0.40 - 0.70				
		≤ 2.5	0.20 - 0.30 - 0.50				
	Alloy steel (~ 350HB)	≤ 0.5	0.20 - 0.75 - 1.20	100 - 150 - 200 (Dry machining recommended)	100 - 150 - 200 (Dry machining recommended)	-	-
		≤ 1.0	0.20 - 0.65 - 1.00				
		≤ 1.5	0.20 - 0.55 - 0.70				
		≤ 2.0	0.20 - 0.40 - 0.55				
		≤ 2.5	0.20 - 0.25 - 0.35				
	Mold steel (~ 40HRC)	≤ 0.5	0.20 - 0.60 - 1.10	80 - 120 - 160 (Dry machining recommended)	80 - 120 - 160 (Dry machining recommended)	-	-
		≤ 1.0	0.20 - 0.50 - 0.90				
		≤ 1.5	0.20 - 0.40 - 0.65				
		≤ 2.0	0.20 - 0.30 - 0.55				
		≤ 2.5	0.20 - 0.25 - 0.35				
	Mold steel (40 ~ 50HRC)	≤ 0.5	0.10 - 0.30 - 0.50	-	60 - 100 - 130 (Dry machining recommended)	-	-
		≤ 1.0	0.10 - 0.25 - 0.40				
		≤ 1.5	0.10 - 0.20 - 0.30				
		≤ 2.0	-				
		≤ 2.5	-				
	Mold steel (50 ~ 55HRC)	≤ 0.5	0.10 - 0.20 - 0.40	-	50 - 70 - 100 (Dry machining recommended)	-	-
		≤ 1.0	0.10 - 0.15 - 0.25				
		≤ 1.5	-				
		≤ 2.0	-				
		≤ 2.5	-				
	Austenitic stainless steel	≤ 0.5	0.20 - 0.60 - 1.00	100 - 140 - 180	100 - 140 - 180	-	-
		≤ 1.0	0.20 - 0.50 - 0.90				
		≤ 1.5	0.20 - 0.45 - 0.60				
		≤ 2.0	0.20 - 0.30 - 0.50				
		≤ 2.5	0.20 - 0.25 - 0.40				
	Martensitic stainless steel	≤ 0.5	0.20 - 0.60 - 1.00	100 - 150 - 200	-	-	150 - 200 - 300
		≤ 1.0	0.20 - 0.50 - 0.90				
		≤ 1.5	0.20 - 0.45 - 0.60				
		≤ 2.0	0.20 - 0.30 - 0.50				
		≤ 2.5	0.20 - 0.25 - 0.40				
	Precipitation hardened stainless steel	≤ 0.5	0.10 - 0.30 - 0.50	90 - 120 - 150	-	-	-
≤ 1.0		0.10 - 0.25 - 0.45					
≤ 1.5		0.10 - 0.15 - 0.25					
≤ 2.0		-					
≤ 2.5		-					
Gray cast iron	≤ 0.5	0.20 - 0.80 - 1.30	-	-	120 - 160 - 220	-	
	≤ 1.0	0.20 - 0.70 - 1.10					
	≤ 1.5	0.20 - 0.60 - 0.80					
	≤ 2.0	0.20 - 0.40 - 0.70					
	≤ 2.5	0.20 - 0.30 - 0.50					
Nodular cast iron	≤ 0.5	0.20 - 0.60 - 1.00	-	-	100 - 150 - 200	-	
	≤ 1.0	0.20 - 0.50 - 0.90					
	≤ 1.5	0.20 - 0.40 - 0.70					
	≤ 2.0	0.20 - 0.30 - 0.60					
	≤ 2.5	0.20 - 0.25 - 0.40					
Ni-base heat-resistant alloy	≤ 0.5	0.10 - 0.30 - 0.45	20 - 30 - 50	-	-	20 - 30 - 50	
	≤ 1.0	0.10 - 0.25 - 0.40					
	≤ 1.5	0.10 - 0.15 - 0.20					
	≤ 2.0	-					
	≤ 2.5	-					
Titanium alloy	≤ 0.5	0.10 - 0.30 - 0.50	40 - 60 - 80	-	-	-	
	≤ 1.0	0.10 - 0.25 - 0.45					
	≤ 1.5	0.10 - 0.15 - 0.25					
	≤ 2.0	-					
	≤ 2.5	-					

- The number in bold font is recommended starting conditions. Adjust the cutting speed and the feed rate within the above conditions according to the actual machining situation.
- Machining with coolant is recommended for precipitation hardened stainless steel, Ni-base heat-resistant alloy and titanium alloy.
- Wet machining may have a lower tool life than dry machining. Set the cutting speed, feed rate and D.O.C. lower than recommended conditions.
- Machining with BT30 or equivalent, feed rate should be reduced to 80% or less of recommended cutting conditions. Slotting is not recommended.
- Center through air is recommended for slotting.
- Slotting or pocketing are not recommended for face mill type.
- For face mill type cutters, it is recommended that width of cut should be set to 75% or less of the cutting diameter.
- It is recommended to set the long shank to 75% or less of the recommended conditions for both ap and feed.



Milling

Approximate programming radius adjustment

Shape	Programmable R (mm)	Over machined radius portion (mm)	Non-machined portion (mm)
	1.5	0	1.42
	2.0	0	1.24
	3.0 (Recommended)	0	0.87
	3.5	0.06	0.69

Ramping tips

- Ramping angle should be under RMPX
- Reduce recommended feed rate in cutting conditions above by 70%

Formula for max. cutting Length (L) at max. ramping angle

$$L = \frac{ap}{\tan RMPX}$$

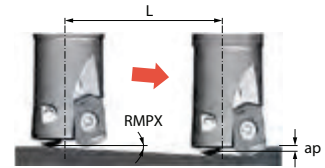

- When ramping both forth and back direction alternately, set the maximum ramping angle RMPX to 50%.

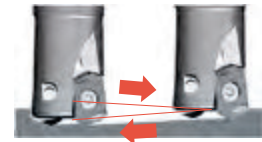

Reference data for ramping

Description	Cutter dia. DCX (mm)	22	25	28	32	35	40	42	50	52	63	80
MFH...-04-...	Max. ramping angle RMPX	3.9°	3.0°	2.4°	2.0°	1.7°	1.4°	1.3°	1.0°	1.0°	0.8°	0.6°
	tan RMPX	0.068	0.052	0.042	0.035	0.029	0.024	0.022	0.018	0.017	0.013	0.010

Guide for helical milling

For helical milling, use between min. cutting dia. and max. cutting dia.

⊘ Exceeding max. cutting dia.

Center core part remains after machining

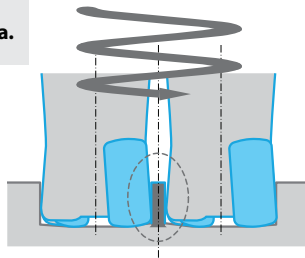

⊘ Under min. cutting dia.

Center core part interferes with toolholder

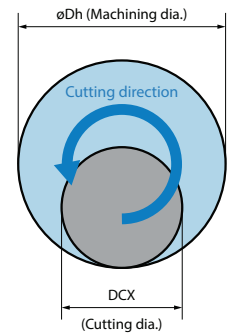
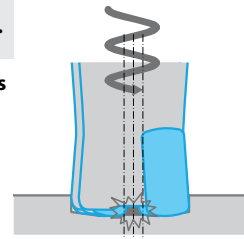

Description	Min. cutting dia. (mm)	Max. cutting dia. (mm)
MFH...-04-...	2×DCX-11	2×DCX-2

• Maximum ramping depth per cycle to be under maximum D.O.C. ap (2.5 mm)
 • Use climb milling. (Refer to the above figure)
 • Feed rates should be reduced to 50% of recommended cutting conditions
 • Use caution to eliminate incidences caused by producing long chips

Guide for drilling

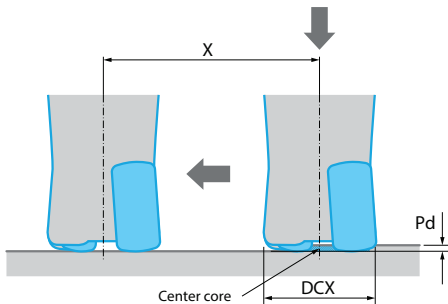

Description	GM type	
	Max. drilling depth Pd (mm)	Min. cutting length X for flat bottom surface (mm)
MFH...-04-...	0.6	DCX-12

- It is recommended to reduce feed by 25% of recommendation until the center core is removed
- Axial feed rate recommendation per revolution is $f \leq 0.2 \text{ mm/rev}$

Vertical milling (Plunging)

Vertical milling (Plunging)

Insert description	Maximum width of cut (ae)
LOMU04 Type	5.0 mm

• Reduce feed rate to $fz \leq 0.2 \text{ mm/t}$ when plunging

MFH Mini

Cutter dia. $\phi 16 \sim \phi 50$

Economical double-sided 4-edge insert

High efficiency and high feed machining at small machining and small machining center

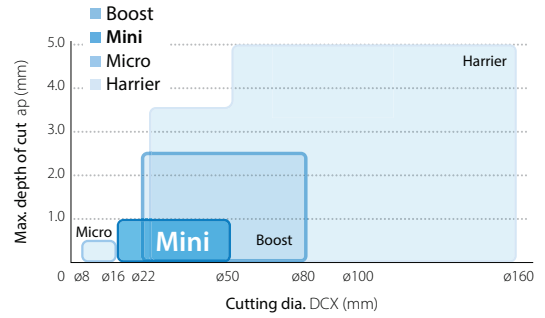

1 Excellent chip evacuation

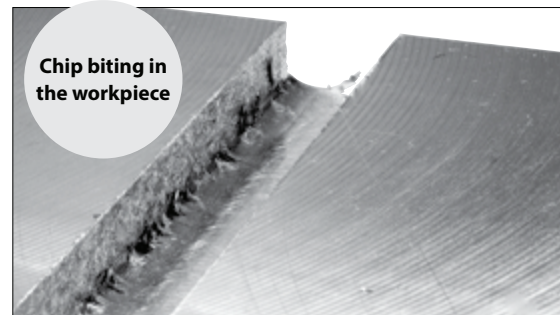
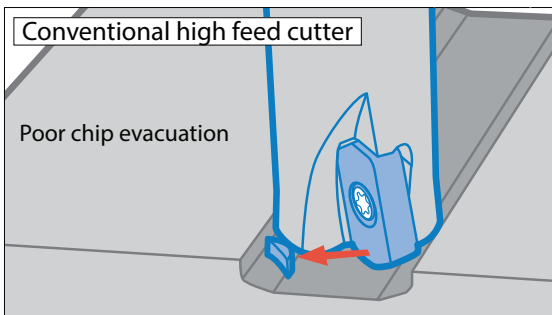
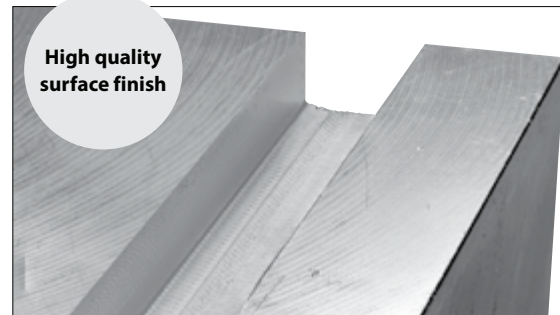
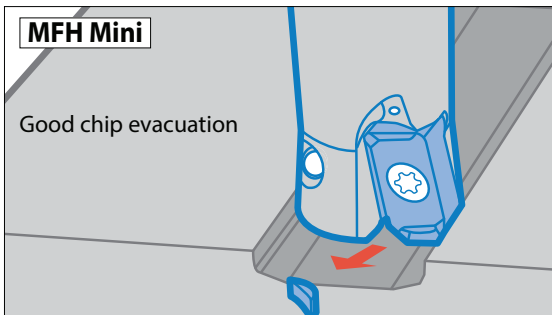

(Internal evaluation)



MFH Mini controls chip biting with 3D convex cutting edge

Cutting conditions: Workpiece material SS400 Cutter dia. $\phi 16$ $V_c = 150$ m/min $a_p \times a_e = 10$ mm (0.5 mm x 20 passes) $x 16$ mm $f_z = 0.6$ mm/t Dry



2 Multi edge design enables high efficiency machining

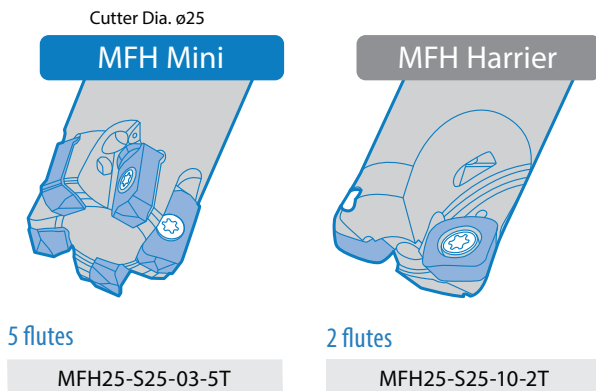

3 High efficiency and high feed machining at small machining center (BT30/BT40)

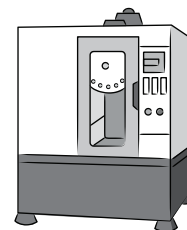

Suitable for roughing of mold

MFH Mini

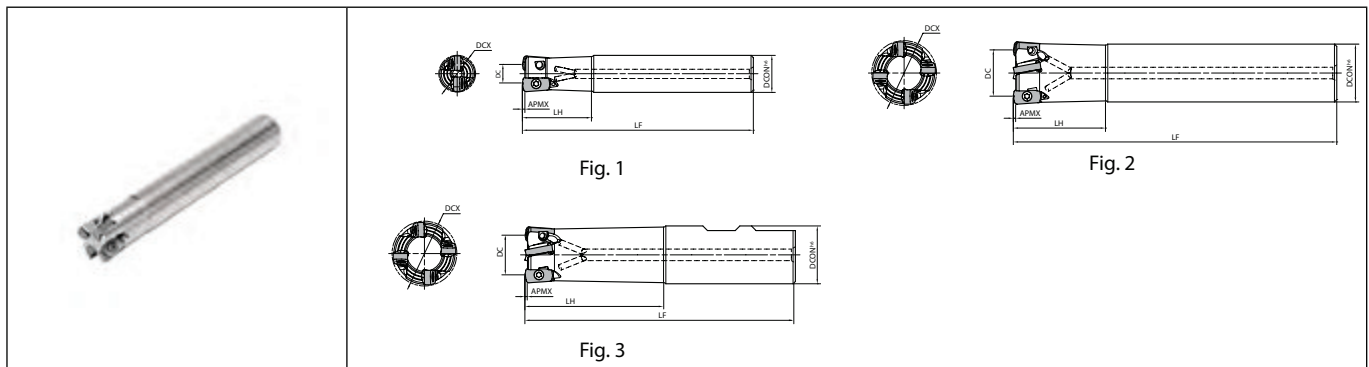

Toolholder dimensions

Description	Availability	Inserts	Dimension (mm)					A.R. (°)	Coolant hole	Max. revolution (min ⁻¹)	Weight (kg)	Fig.	Spare parts			Applicable inserts M199										
			DC	DCK	DCON	LF	APMX						Anti-seize compound	Screw	Wrench											
			Recommended tightening torque for insert clamp 1.2N·m			Recommended tightening torque for insert clamp 1.2N·m							Recommended tightening torque for insert clamp 1.2N·m													
Cylindrical	Same shank	● 2	8	16	16	100	30	1	10	Yes	18800	0.1	1	P-37	SB-3065TRP	DTPM-8	LOGU030310ER-GM LOGU030310ER-GH									
		● 3	12	20	20	130	50				15700	0.3						1								
		● 4	17	25	25	140	60				13400	0.5							1							
		● 5	24	32	32	150	70				11400	0.8						1								
		● 6																								
		Standard shank	● 2	9	17	16	100				20	1						10	Yes	17900	0.1	2	P-37	SB-3065TRP	DTPM-8	LOGU030310ER-GM LOGU030310ER-GH
	● 3		14	22	20	130	30	17000	0.3	2																
	● 4		20	28	25	140	40	14700	0.5		2															
	● 5																									
	Long Shank		● 2	8	16	16	150	50	1	10	Yes		18800	0.2	1	P-37	SB-3065TRP			DTPM-8	LOGU030310ER-GM LOGU030310ER-GH					
			● 3	12	20	20	160	80					15700	0.3												
		● 4	17	25	25	180	100	13400				0.6	1													
● 5		24	32	32	200	120	11400	1.1				1														
● 6																										
Weldon		MFH	● 2	8	16	16	79	30				1	10	Yes				18800	0.1			3	P-37	SB-3065TRP	DTPM-8	LOGU030310ER-GM LOGU030310ER-GH
	● 3		12	20	20	101	50	15700	0.2	3																
	● 4		17	25	25	117	60	13400	0.4		3															
	● 5		24	32	32	131	70	11400	0.7	3																
	● 6																									

Max. revolution : Do not use the cutter at the maximum revolution or higher since the centrifugal force may cause inserts and parts to scatter even under no load.
Coat Anti-seize Compound thinly on portion of taper and thread when insert is fixed.

● : Standard item R : Right-hand only L : Left-hand only □ : Check availability

M196

M

Milling

Cutting edge angle 45°~70°

Cutting edge angle 75°

Cutting edge angle 88°/90°

Cutter for Finishing

High Feed Cutter

Multi-Function

Slot Mill

Ball-nose Radius

Others

MFH Mini

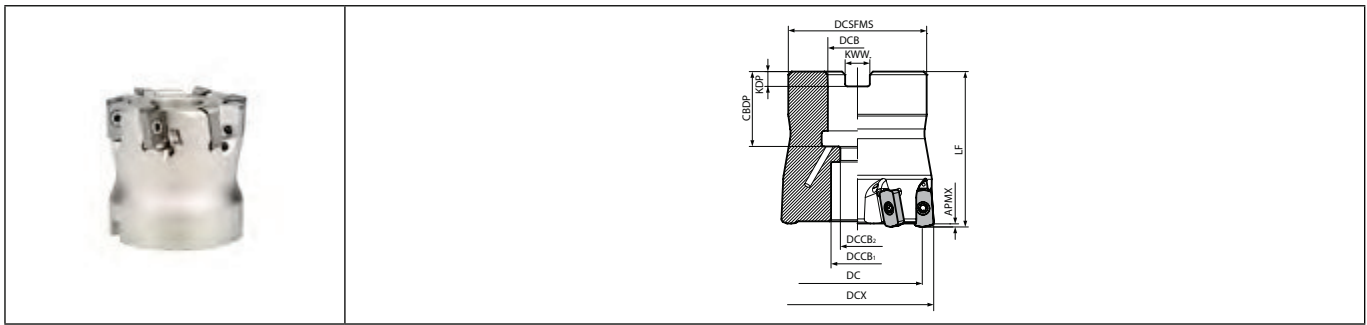

Toolholder dimensions

Description	Availability	Inserts	Dimension (mm)											A.R. (°)	Coolant hole	Max. revolution (min ⁻¹)	Weight (kg)	Spare parts			Applicable inserts ➔ M199
			DC	DCX	DCSFMS	DCB	DCCB ₁	DCCB ₂	LF	CDBP	KDP	KWW	APMX					Anti-seize compound	Screw	Wrench	
MFH 040R-03-5T-M	●	5			38												0.2	P-37 SB-3065TRP DTPM-8 Recommended tightening torque for insert clamp 1.2N•m	LOGU030310ER-GM LOGU030310ER-GH		
040R-03-6T-M	●	6	32	40													0.24				
040R-03-7T-M-KUA	●	7			34	16	15	9		19	5.6	8.4					0.27				
042R-03-5T-M-KUA	●	5	34	42	38				40								0.26				
042R-03-7T-M-KUA	●	7			34												0.39				
050R-03-5T-M-KUA	●	5											1	-10	Yes		0.41				
050R-03-8T-M-KUA	●	8	42	50													0.5				
050R-03-8T-M	●	8						19	11	50							0.43				
052R-03-5T-M-KUA	●	5			47	22				21	6.3	10.4					0.57				
052R-03-8T-M-KUA	●	8	44	52					40								0.6				
063R-03-8T-M-KUA	●	8	55	63				50.7													
066R-03-8T-M-KUA	●	8	58	66				53.7													

Max. revolution : Do not use the cutter at the maximum revolution or higher since the centrifugal force may cause inserts and parts to scatter even under no load.
 Coat Anti-seize Compound thinly on portion of taper and thread when insert is fixed.



Milling

MFH Mini

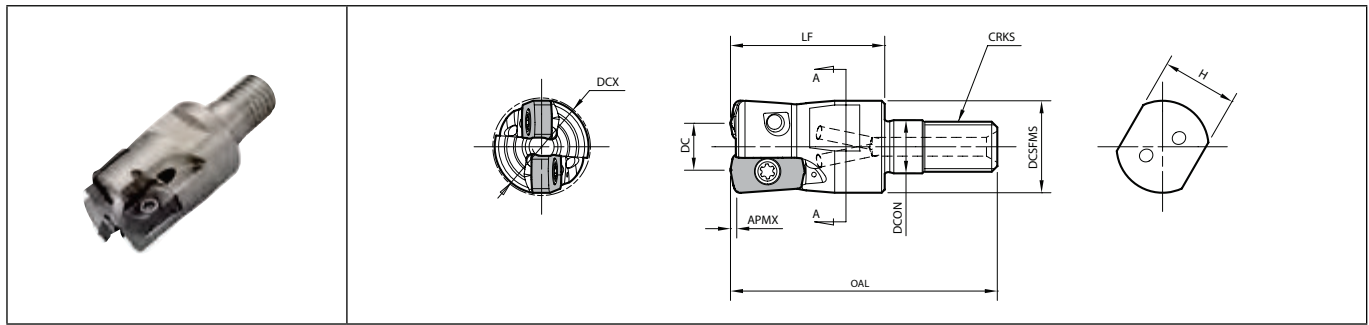

Toolholder dimensions

Description	Availability	Inserts	Dimension (mm)									A.R. (°)	Coolant hole	Max. revolution (min ⁻¹)	Spare parts			Applicable inserts M199
			DC	DCX	DCON	DCSFMS	OAL	LF	APMX	CRKS	H				Anti-seize compound	Screw	Wrench	
MFH 16-M08-03-2T	●		8	16										18880	P-37	SB-3065TRP	DTPM-8	LOGU030310ER-GM LOGU030310ER-GH
MFH 17-M08-03-2T	●	2	9	17	8.5	14.7	42	25	1	M8x1.25	12	-10	Yes	17900	Recommended tightening torque for insert clamp 1.2N·m			
MFH 18-M08-03-2T	●		10	18										17000				
MFH 20-M10-03-3T	●	3	12	20										15700	P-37	SB-3065TRP	DTPM-8	LOGU030310ER-GM LOGU030310ER-GH
MFH 20-M10-03-4T	●	4			10.5	18.7	48	30	1	M10x1.5	15	-10	Yes	14700	Recommended tightening torque for insert clamp 1.2N·m			
MFH 22-M10-03-3T	●	3	14	22														
MFH 22-M10-03-4T	●	4																
MFH 25-M12-03-4T	●	4	17	25										13400	P-37	SB-3065TRP	DTPM-8	LOGU030310ER-GM LOGU030310ER-GH
MFH 25-M12-03-5T	●	5			12.5	23	56	35	1	M12x1.75	19	-10	Yes	12400	Recommended tightening torque for insert clamp 1.2N·m			
MFH 28-M12-03-4T	●	4	20	28														
MFH 28-M12-03-5T	●	5																
MFH 32-M16-03-5T	●	5	24	32						M16x2.0				11400				LOGU030310ER-GM LOGU030310ER-GH
MFH 32-M16-03-6T	●	6																
MFH 35-M16-03-6T-KUA	●	6	27															
MFH 40-M16-03-5T-KUA	●	5	40		17	30	62	40	1		24	-10	Yes		P-37	SB-3065TRP	DTPM-8	
MFH 42-M16-03-5T-KUA	●	5	24							M16x2.0				9900	Recommended tightening torque for insert clamp 1.2N·m			
MFH 42-M16-03-7T-KUA	●	7	42															

Max. revolution : Do not use the cutter at the maximum revolution or higher since the centrifugal force may cause inserts and parts to scatter even under no load.

Coat Anti-seize Compound thinly on portion of taper and thread when insert is fixed.

See page M60 for applicable arbor (BT arbor for exchangeable head / double-face clamping spindle)





- Cutting edge angle 45°~70°
- Cutting edge angle 75°
- Cutting edge angle 88°/90°
- Cutter for Finishing
- High Feed Cutter
- Multi-Function
- Slot Mill
- Ball-nose Radius
- Others

● : Standard item R : Right-hand only L : Left-hand only □ : Check availability

M198

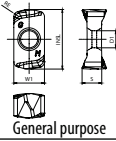
LOGU

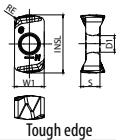
Insert		Description	No. of edges	Dimension (mm)					Carbide				Applicable toolholder M196~M198
				S	D1	RE	INSL	W1	CVD		PVD		
  General purpose		LOGU 030310ER-GM	4	3.96	3.45	1	11.9	6.2	●	●	●	●	MFH...-03-..
  Tough edge		LOGU 030310ER-GH	4	3.96	3.45	1	11.9	6.2	●	●	●	●	MFH...-03-..

Handed insert shows Right-hand

Recommended cutting conditions M200

Classification of usage

- ★ : Roughing / 1st Choice
- ☆ : Roughing / 2nd Choice
- : Finishing / 1st Choice
- : Finishing / 2nd Choice
- (In case hardness is 45HRC or under)

Carbon steel / Alloy steel				★	☆	P
Mold and die steel				★	☆	
Austenitic stainless steel				☆	★	M
Martensitic stainless steel	★				☆	
Precipitation hardening stainless steel					★	
Gray cast iron				★		K
Nodular cast iron				★		
Non-ferrous metals						N
Heat-resistant alloy	★				☆	S
Titanium alloy					★	
Hard materials		★				H



Cutting performance

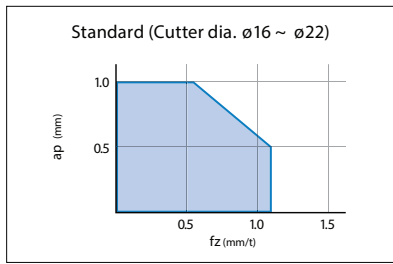

MFH16-...-2T, MFH17-...-2T, MFH18-...-2T
MFH20-...-3T, MFH22-...-3T

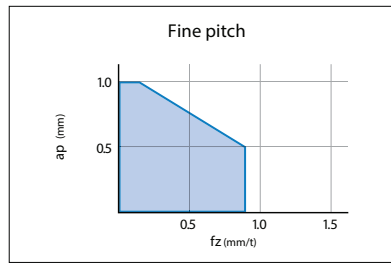

MFH20-...-4T, MFH22-...-4T, MFH25-...-5T
MFH28-...-5T, MFH32-...-6T

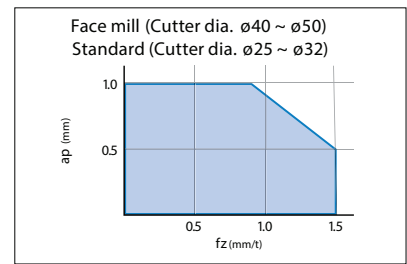

MFH25-...-4T, MFH28-...-4T, MFH32-...-5T
MFH40R-..., MFH50R-...

When using fine pitch type, reduce the cutting conditions compared with standard type.

Recommended cutting conditions

Insert type	Workpiece material	Toolholder description and feed rate (fz: mm/t) * Recommended feed rate (Reference value): ap=0.5mm							Recommended insert grades (Vc: m/min)					
		MFH16 -...-2T	MFH20 -...-3T	MFH20 -...-4T	MFH25 -...-4T	MFH25 -...-5T	MFH32 -...-5T	MFH32 -...-6T	MFH -...-R-03	MEGACOAT NANO			MEGACOAT HARD	CVD Coated carbide
										PR1535	PR1525	PR1510	PR0155	CA6535
GM GH	Carbon steel	0.2~0.7~1.2								☆ 120~180~250	★ 120~180~250	-	-	-
	Alloy steel	0.2~0.7~1.2								☆ 100~160~220	★ 100~160~220	-	-	-
	Mold steel (~40HRC)	0.2~0.5~0.9	0.2~0.4~0.6	0.2~0.6~1.2	0.2~0.4~0.6	0.2~0.6~1.2	0.2~0.4~0.6	0.2~0.4~1.2	☆ 80~140~180	☆ 80~140~180	-	GH★ 80~140~180	-	
	Mold steel (40~50HRC)	0.2~0.3~0.5	0.2~0.25~0.3	0.2~0.3~0.6	0.2~0.25~0.3	0.2~0.3~0.6	0.2~0.25~0.3	0.2~0.25~0.6	-	★ 60~100~130	-	GH★ 60~100~130	-	
	Mold steel (50~55HRC)	0.1~0.3~0.5	0.1~0.2~0.3	0.1~0.3~0.5	0.1~0.2~0.3	0.1~0.3~0.5	0.1~0.2~0.3	0.1~0.3~0.5	-	★ 50~70~100	-	GH★ 50~70~100	-	
	Mold steel (55~60HRC)	0.03~0.06~0.1(* Recommended only for GH chipbreaker)								-	-	-	GH☆ 50~60~70	-
	Stainless steel (Austenitic related)								GM★ 100~160~200	GM☆ 100~160~200	-	-	-	
	Stainless steel (Martensitic related)	0.2~0.5~0.9	0.2~0.4~0.6	0.2~0.6~1.2	0.2~0.4~0.6	0.2~0.6~1.2	0.2~0.4~0.6	0.2~0.4~0.6	☆ 150~200~250	-	-	-	★ 180~240~300	
	Stainless steel (Precipitation hardening)								★ 90~120~150	-	-	-	-	
	Gray cast iron	0.2~0.7~1.2	0.2~0.5~0.8	0.2~0.8~1.5	0.2~0.5~0.8	0.2~0.8~1.5	0.2~0.5~0.8	0.2~0.5~0.8	-	-	★ 120~180~250	-	-	
Nodular cast iron	0.2~0.5~0.9	0.2~0.4~0.6	0.2~0.6~1.2	0.2~0.4~0.6	0.2~0.6~1.2	0.2~0.4~0.6	0.2~0.4~0.6	-	-	★ 100~150~200	-	-		
Ni-base heat-resistant alloys	0.2~0.3~0.6	0.2~0.25~0.4	0.2~0.4~0.8	0.2~0.25~0.4	0.2~0.4~0.8	0.2~0.25~0.4	0.2~0.25~0.4	☆ 20~30~50	-	-	-	★ 20~30~50		
Titanium alloys								GM★ 40~60~80	-	GM☆ 30~50~70	-	-		

* Machining with coolant is recommended for Ni-base heat-resistant alloys and titanium alloys.
The bold-faced number indicates a center value of recommended cutting condition.
Adjust the cutting speed and the feed rate within the above conditions according to the actual machining situation.
For machining center equivalent to BT30, reduce feed rate to 25% or less of the recommended condition.
For slotting, internal coolant or center through coolant is recommended.
Slotting and pocketing are not recommended for face mill type.

Standard Fine pitch ★: 1st Recommendation ☆: 2nd Recommendation

Note for machining program (Approx. R)

Shape	Approx. R (mm)	Max. over machining of radius (mm)	Max. unmachined portion (mm)
	R1.0	0	0.51
	R1.5	0	0.41
	R1.6 (Recommended)	0	0.39
	R2.0	0.09	0.31

Cutting edge angle: 12°

M

Milling

Cutting edge angle 45°~70°

Cutting edge angle 75°

Cutting edge angle 88°/90°

Cutter for Finishing

High Feed Cutter

Multi-Function

Slot Mill

Ball-nose Radius

Others

Reference data for ramping

Description	Cutter dia. DCX (mm)	16	17	18	20	22	25	28	32	40	50
MFH ...-03-...	Max. ramping angle RMPX	2.8°	2.5°	2.1°	1.7°	1.4°	1.2°	1°	0.8°	0.5°	0.4°
	tan RMPX	0.049	0.042	0.037	0.03	0.024	0.021	0.017	0.014	0.009	0.007

Guide for ramping (Slant milling)

Ramping angle should be RMPX (Maximum ramping angle) or under in the above cutting conditions.
 Feed rate should be 70% or under of the above cutting conditions.

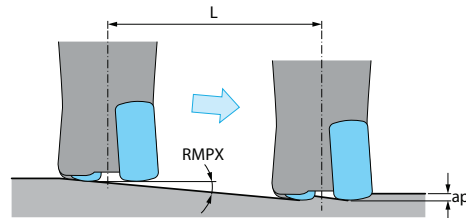

Formula of the cutting length "L" at max. ramping angle

$$L = \frac{ap}{\tan RMPX}$$

Guide for helical milling

For helical milling, use between min. cutting dia. and max. cutting dia.

⊘ Over max. cutting dia.

Center core part remains after machining

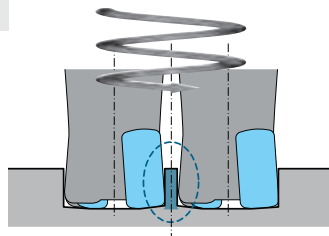

⊘ Under min. cutting dia.

Center core part interferes with toolholder

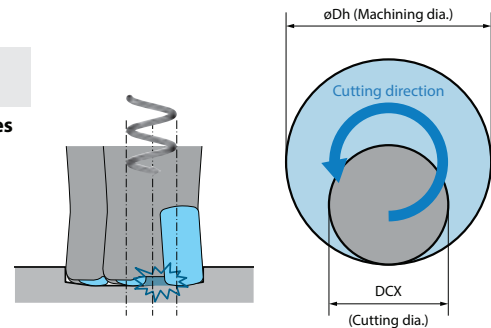

Description	Min. cutting dia.	Max. cutting dia.
MFH...-03-...	2×DCX-8	2×DCX-2

Unit: mm

- Sinking depth at helical milling should be max. ap (1mm) or under.
- Down-cut milling is recommended. (refer to the figure above)
- Feed rate should be under 50% of the recommended cutting conditions.
- Be careful to machine in a safe environment to avoid accident caused by long chips.

Guide for drilling

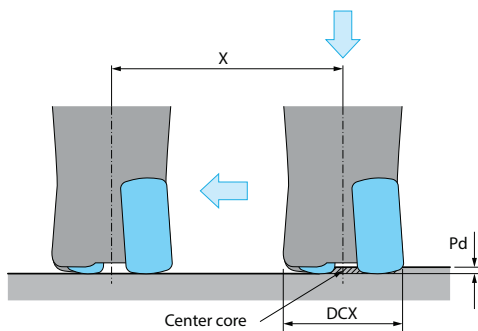

Description	GM type / GH type	
	Max. cutting depth Pd	Min. cutting length X for flat bottom surface
MFH...-03-...	1.0	DCX-9

Unit: mm

- * When traversing directly after drilling, set the table feed at up to 25% of the recommended cutting conditions.
- * When drilling, reduce feed rate per revolution to f=0.2 mm/rev or under.

Vertical milling (Plunging)

Vertical milling (Plunging)

Available for vertical milling (plunging).

Insert description	Max. width of cut
LOGU03 type	3.5mm

For vertical milling (plunging), reduce feed rate to fz=0.2mm/t or less.



MFH Micro

Cutter dia. $\varnothing 8 \sim \varnothing 16$

Low resistance and durable against chatter for highly efficient machining. Max. ap 0.5mm.

Stable high feed machining on a wide range of applications

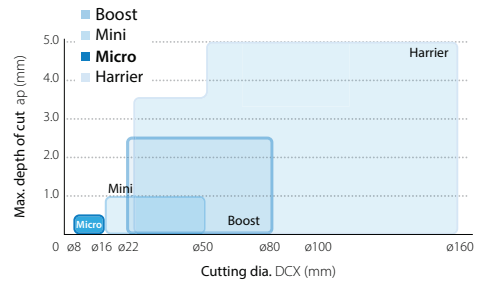

1 Stable machining with chattering resistance

3D convex cutting edge controls initial impact when entering the workpiece

3D convex cutting edge

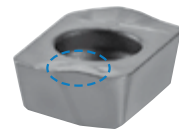

High precision G class insert

Cutting force comparison (Internal evaluation)

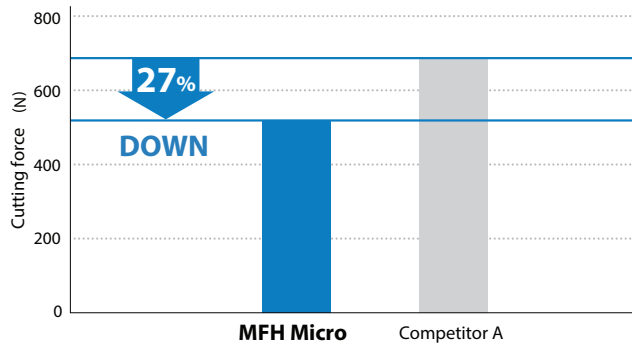

Increase in cutting force when entering workpiece (Internal evaluation)

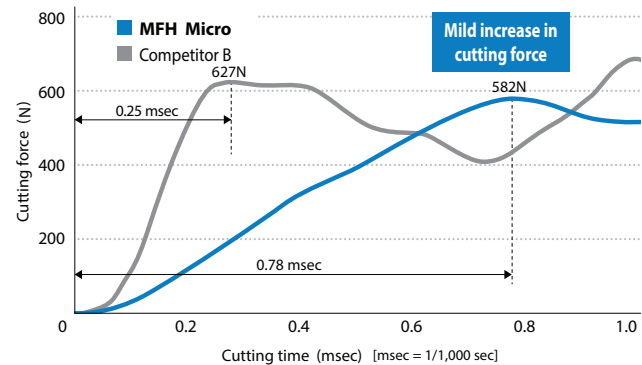

Cutting conditions: $V_c = 120$ m/min, $a_p = 0.4$ mm, $f_z = 0.6$ mm/t
Cutter dia. $\varnothing 10$ mm, slotting, dry workpiece material: 50C

Cutting conditions: $V_c = 120$ m/min, $a_p \times a_e = 0.4 \times 5$ mm, $f_z = 0.6$ mm/t
Cutter dia. $\varnothing 10$ mm, dry workpiece material: 50C

2 Wide range of machining applications

Wide range of machining applications at a maximum depth of cut of 0.5mm

Stable machining even with small machining centers

Cutting performance map (Cutter dia. $\varnothing 10$ mm)

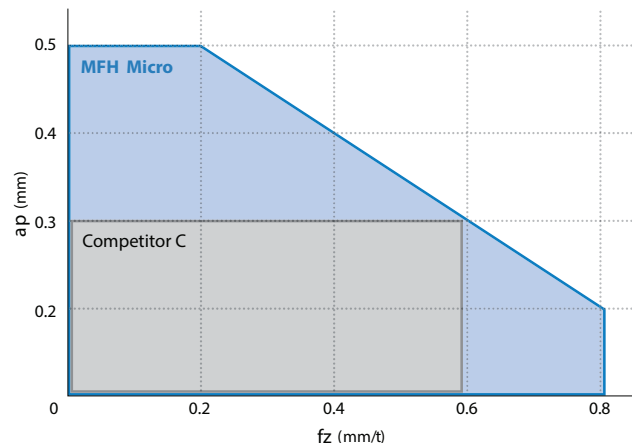

(Internal evaluation)

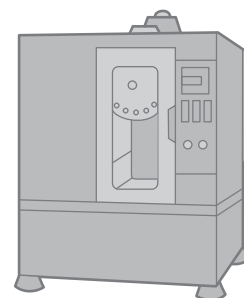

Applicable for BT30/ BT40



Milling

- Cutting edge angle 45°~70°
- Cutting edge angle 75°
- Cutting edge angle 88°/90°
- Cutter for Finishing
- High Feed Cutter
- Multi-Function
- Slot Mill
- Ball-nose Radius
- Others

3 Excellent chip evacuation

Controls chip biting with convex cutting edge

MFH Micro

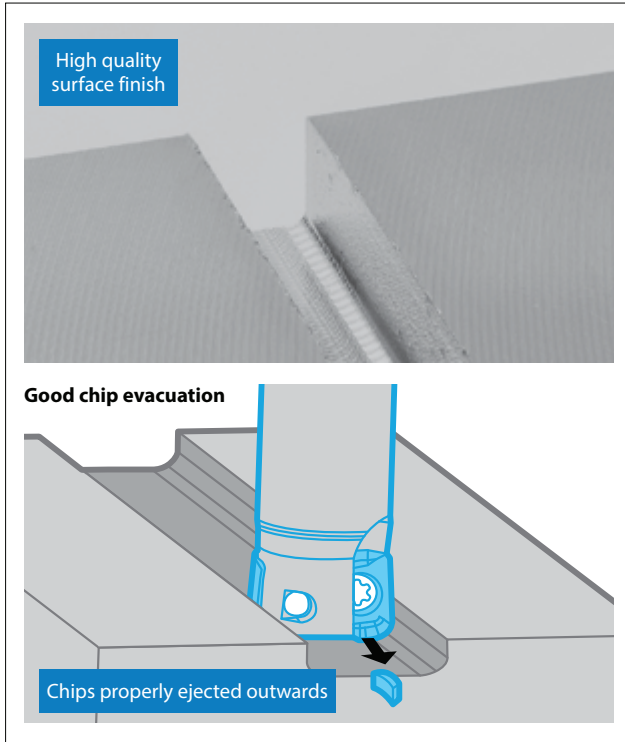

Competitor F

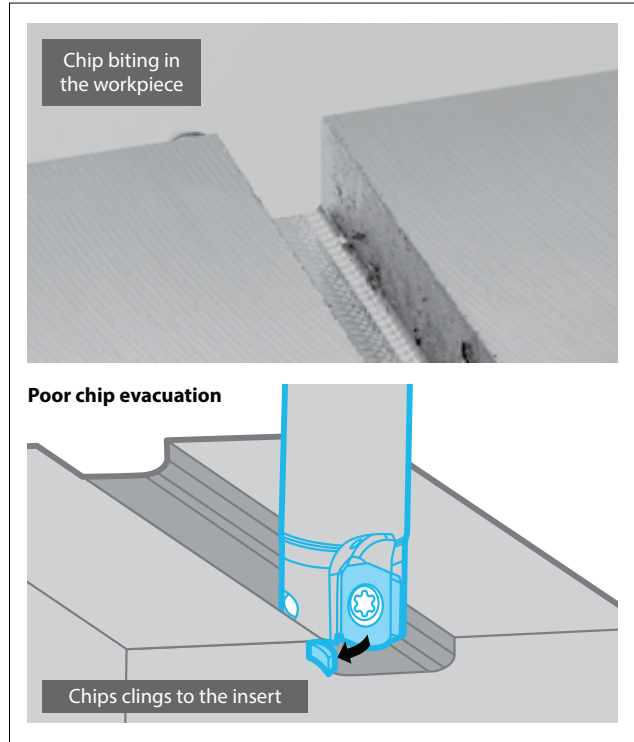

Cutting conditions: Cutter dia. DCX = $\phi 10\text{mm}$, $V_c = 120\text{ m/min}$, $a_p = 0.4\text{mm}$ (25pass), $f_z = 0.6\text{mm/t}$ Total 10mm, Dry workpiece material: S5400

(Internal evaluation)



4 Replaces solid end mills to reduce machining costs

Suppresses chattering and increases milling efficiency

MFH Micro compared to solid end mills

MFH Micro Q = 15.3 cc/min
 $V_c = 150\text{ m/min}$, $f_z = 0.4\text{mm/t}$
 $a_p \times a_e = 0.4 \times 10\text{mm}$, dry
 MFH10-S10-01-2T (2 flutes)
 LPGT010210ER-GM (PR1525)



Solid end mill Q = 12.2 cc/min
 $V_c = 80\text{ m/min}$, $f_z = 0.04\text{mm/t}$
 $a_p \times a_e = 3 \times 10\text{mm}$, dry
 $\phi 10$ (4 flutes)

Machine part slotting workpiece material: 50C

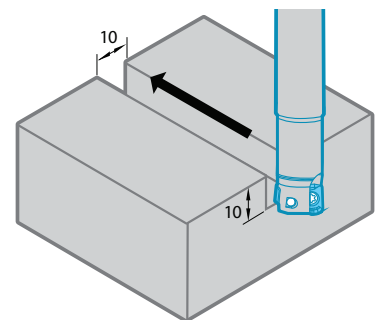
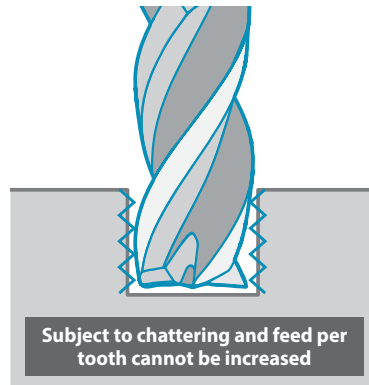
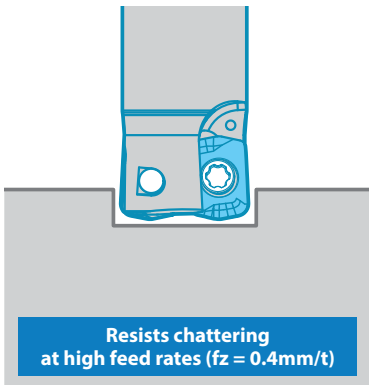

MFH Micro

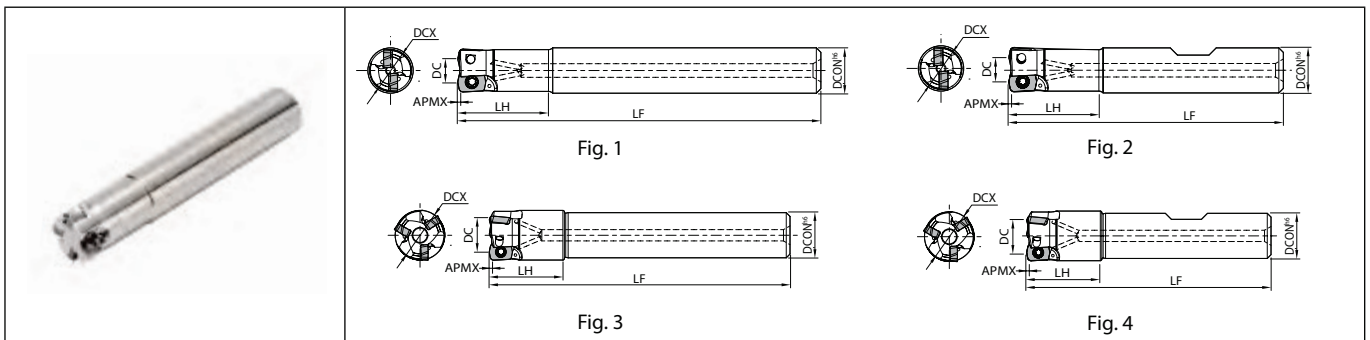

Toolholder dimensions

Description	Availability	Inserts	Dimension (mm)							A.R. (°)	Coolant hole	Max. revolution (min ⁻¹)	Weight (kg)	Fig.	Spare parts			Applicable inserts M204
			DC	DCX	DCON	LF	LH	APMX	Anti-seize compound						Screw	Wrench		
Cylindrical MFH 08-S10-01-1T 10-S10-01-2T 12-S12-01-3T 16-S16-01-4T	●	1	4.2	8	10	75	16	0.5	+5	Yes	20000	0.04	1	P-37	SB-1840TRP	FTP-6	LPGT010210ER-GM	
	●	2	6.2	10	80	20	16200				0.06	1						
	●	3	8.2	12	12	80	20				14000							0.06
	●	4	12.2	16	16	90	25				11400	0.12						1
MFH 14-S12-01-3T	●	3	10.2	14	12	80	20	0.5	+5	Yes	12500	0.07	3	P-37	SB-1840TRP	FTP-6	LPGT010210ER-GM	
Weldon MFH 08-W10-01-1T 10-W10-01-2T 12-W12-01-3T 16-W16-01-4T MFH 14-W12-01-3T	●	1	4.2	8	10	58	16	0.5	+5	Yes	20000	0.03	2	P-37	SB-1840TRP	FTP-6	LPGT010210ER-GM	
	●	2	6.2	10	60	20	16200				0.05	2						
	●	3	8.2	12	12	65	20				14000							0.05
	●	4	12.2	16	16	73	25				11400	0.1						2
	MFH 14-W12-01-3T	●	3	10.2	14	12	65				20	0.5						

Max. revolution : Do not use the cutter at the maximum revolution or higher since the centrifugal force may cause inserts and parts to scatter even under no load.
Coat Anti-seize Compound thinly on portion of taper and thread when insert is fixed.
Recommended tightening torque for insert clamp : 0.5N·m

LPGT

Insert	Description	Dimension (mm)					Carbide			Applicable toolholder M204 M205
		S	D1	RE	W1	INSL	CVD	PVD		
<p>Classification of usage</p> <ul style="list-style-type: none"> ★ : Roughing / 1st Choice ☆ : Roughing / 2nd Choice ■ : Finishing / 1st Choice □ : Finishing / 2nd Choice <p>(In case hardness is 45HRC or under)</p>	LPGT 010210ER-GM	Carbon steel / Alloy steel					★	☆	P	
		Mold and die steel					★	☆		
		Austenitic stainless steel					☆	★	M	
		Martensitic stainless steel					★	☆		
		Precipitation hardening stainless steel						★		
		Gray cast iron							K	
		Nodular cast iron								
		Non-ferrous metals							N	
		Heat-resistant alloy					★	☆	S	
		Titanium alloy						★		
Hard materials							H			
<p>General purpose</p>	LPGT 010210ER-GM	2.19	2.1	1	4.19	6.26	●	●	MFH...-01-..	

Handed insert shows Right-hand

Recommended cutting conditions M206

● : Standard item R : Right-hand only L : Left-hand only □ : Check availability

M204



Cutting edge angle 45°~70°
Cutting edge angle 75°
Cutting edge angle 88°/90°
Cutter for Finishing
High Feed Cutter
Multi- Function
Slot Mill
Ball-nose Radius
Others

MFH Micro

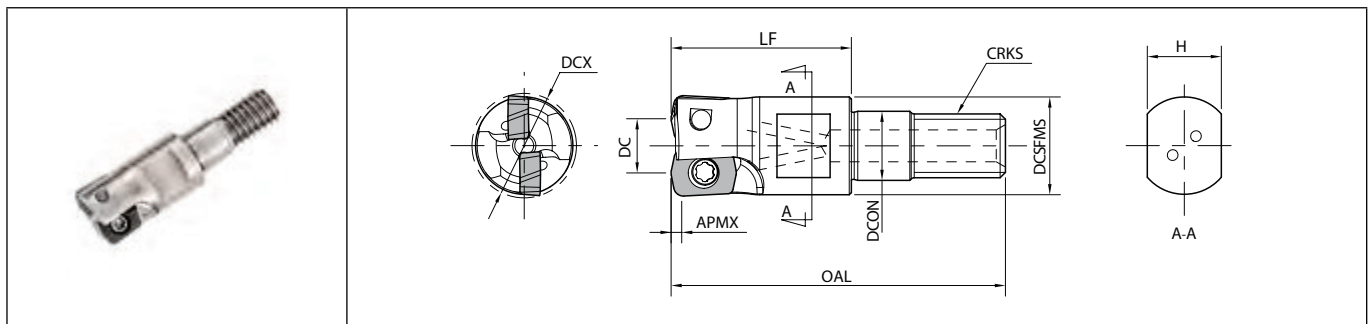

Toolholder dimensions

Description	Availability	Inserts	Dimension (mm)										A.R. (°)	Coolant hole	Max. revolution (min ⁻¹)	Spare parts			Applicable inserts ● M204			
			DC	DCX	DCON	DCSFMS	OAL	LF	APMX	CRKS	H	Anti-seize compound				Screw	Wrench					
			MFH 08-M06-01-1T 10-M06-01-2T 12-M06-01-3T 14-M06-01-3T	●	1	4.2	8	6.5	9.2	30.5	17	0.5				M6x1.0	7	+5		Yes	20000 16200 14000 12500	P-37
MFH 16-M08-01-4T	●	4	12.2	16	8.5	14.7	39		22				0.5	M8x1.25	12				+5			

Max. revolution : Do not use the cutter at the maximum revolution or higher since the centrifugal force may cause inserts and parts to scatter even under no load.

Coat Anti-seize Compound thinly on portion of taper and thread when insert is fixed.

Please use commercial shanks for cutting diameter from ø8 to ø14 (Screw size : M6 x 1.0)

Check screw specifications for the shank in use.

Recommended tightening torque for insert clamp : 0.5N-m

Actual End Mill depth (MFH16-M08-01-4T)

Arbor Description	Applicable End Mill (Head)			Actual End Mill depth (mm)
	Description	Cutting Dia.	Dimension	LUX
		DC	LF	
BT30K-M08-45	MFH16-M08-01-4T	16	22	28.8
BT40K-M08-55	MFH16-M08-01-4T	16	22	28.7

➔ See page M60 for applicable arbor (BT arbor for exchangeable head / double-face clamping spindle)

● : Standard item R : Right-hand only L : Left-hand only □ : Check availability



Milling

Cutting performance

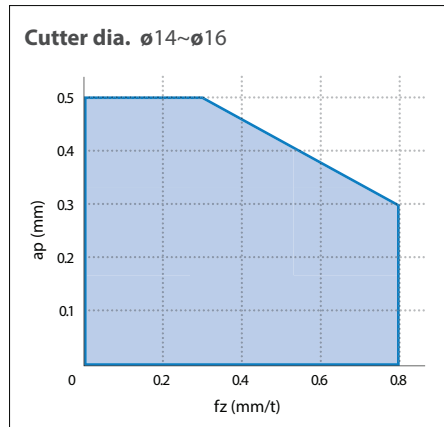
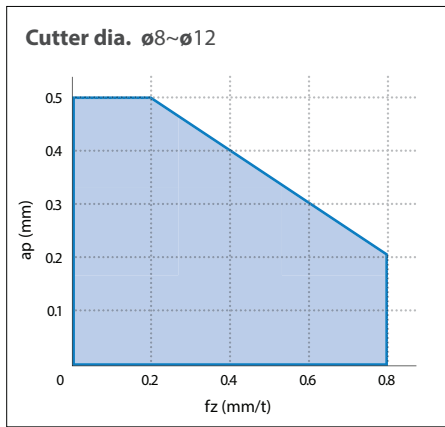

Recommended cutting conditions

Insert type	Workpiece material	Recommended feed rate (fz: mm/t): ap: 0.3mm (Reference value)					Recommended insert grades (Cutting speed Vc: m/min)		
		MFH08-...-1T	MFH10-...-2T	MFH12-...-3T	MFH14-...-3T	MFH16-...-4T	MEGACOAT NANO		CVD Coated carbide
							PR1525	PR1535	CA6535
GM	Carbon steel	0.2~ 0.4 ~0.6			0.2~ 0.5 ~0.8		★ 120~ 180 ~250	☆ 120~ 180 ~250	-
	Alloy steel	0.2~ 0.4 ~0.6			0.2~ 0.5 ~0.8		★ 100~ 160 ~220	☆ 100~ 160 ~220	-
	Mold steel (~40HRC)	0.2~ 0.3 ~0.5			0.2~ 0.4 ~0.6		★ 80~ 140 ~180	☆ 80~ 140 ~180	-
	Mold steel (40~50HRC)	0.2~ 0.25 ~0.3			0.2~ 0.25 ~0.4		★ 60~ 100 ~130	☆ 60~ 100 ~130	-
	Stainless steel (Austenitic related)	0.2~ 0.3 ~0.5			0.2~ 0.4 ~0.6		☆ 100~ 160 ~200	★ 100~ 160 ~200	-
	Stainless steel (Martensitic related)	0.2~ 0.3 ~0.5			0.2~ 0.4 ~0.6		-	☆ 150~ 200 ~250	★ 180~ 240 ~300
	Stainless steel (Precipitation hardening)	0.2~ 0.3 ~0.5			0.2~ 0.4 ~0.6		-	★ 90~ 120 ~150	-
	Gray cast iron	0.2~ 0.4 ~0.6			0.2~ 0.5 ~0.8		★ 120~ 180 ~250	-	-
	Nodular cast iron	0.2~ 0.3 ~0.5			0.2~ 0.4 ~0.6		★ 100~ 150 ~200	-	-
	Ni-base heat-resistant alloys	0.2~ 0.25 ~0.3			0.2~ 0.25 ~0.4		-	☆ 20~ 30 ~50	★ 20~ 30 ~50
	Titanium alloys	0.2~ 0.25 ~0.3			0.2~ 0.25 ~0.4		-	★ 40~ 60 ~80	-

Machining with coolant is recommended for Ni-base heat-resistant alloys and titanium alloys. The bold-faced number indicates a center value of recommended cutting condition. Adjust the cutting speed and the feed rate within the above conditions according to the actual machining situation. Internal coolant is recommended for slotting.

★ : 1st Recommendation ☆ : 2nd Recommendation

Note for machining program (Approx. R)

Shape	Approx. R (mm)	Max. over machining of radius (mm)	Max. unmachined portion (mm)
	R1.0	0	0.21
	R1.2 (Recommended)	0	0.17
	R1.5	0.08	0.1
	R2.0	0.28	0.01

Cutting edge angle: 12°



- Cutting edge angle 45°~70°
- Cutting edge angle 75°
- Cutting edge angle 88°/90°
- Cutter for Finishing
- High Feed Cutter
- Multi-Function
- Slot Mill
- Ball-nose Radius
- Others

Reference data for ramping

Description	Cutter dia. DCX (mm)	8	10	12	14	16
MFH...-01-...	Max. ramping angle RMPX	4.0°	3.0°	2.0°	1.5°	1.2°
	tan RMPX	0.070	0.052	0.035	0.026	0.021

Decrease ramping angle if chips become excessively long.

Guide for ramping (Slant milling)

Ramping angle should be RMPX (Maximum ramping angle) or under in the above cutting conditions.
Feed rate should be 70% or under of the above cutting conditions.

Formula of the cutting length "L" at max. ramping angle

$$L = \frac{ap}{\tan RMPX}$$

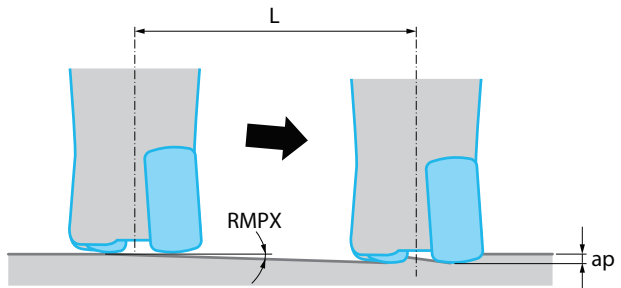

Guide for helical milling

For helical milling, use between min. cutting dia. and max. cutting dia.

⊘ Exceeding max. cutting dia.

Center core part remains after machining

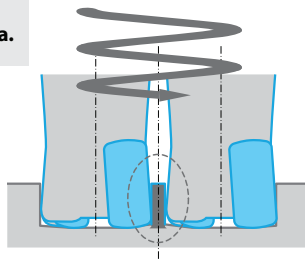

⊘ Under min. cutting dia.

Center core part interferes with toolholder

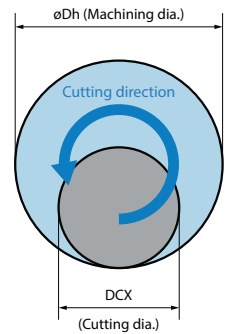
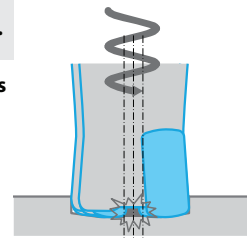

Description	Min. cutting dia.	Max. cutting dia.
MFH...-01-...	2×DCX-3.5	2×DCX-2

Unit: mm

- Sinking depth at helical milling should be max. ap (0.5mm) or under.
- Down-cut milling is recommended (refer to the figure above).
- Feed rate should be under 50% of the recommended cutting conditions.
- Be careful to machine in a safe environment to avoid accident caused by long chips.

Guide for drilling

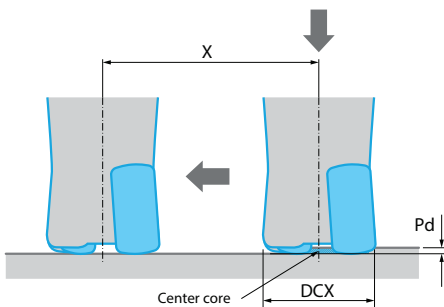

Description	GM type	
	Max. cutting depth	Min. cutting length X for flat bottom surface
MFH...-01-...	0.5	DCX-3.5

Unit: mm

- * When traversing directly after drilling, set the table feed at up to 25% of the recommended cutting conditions.
- * When drilling, reduce feed rate per revolution to under f=0.2mm/rev.

Vertical milling (Plunging)

Vertical milling (Plunging)

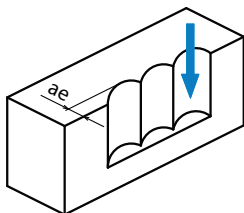

Available for vertical milling (plunging).

Insert description	Max. width of cut
LOGT01 type	1.7mm

For vertical milling (plunging), reduce feed rate to fz=0.2mm/t or less.



Milling

MEY

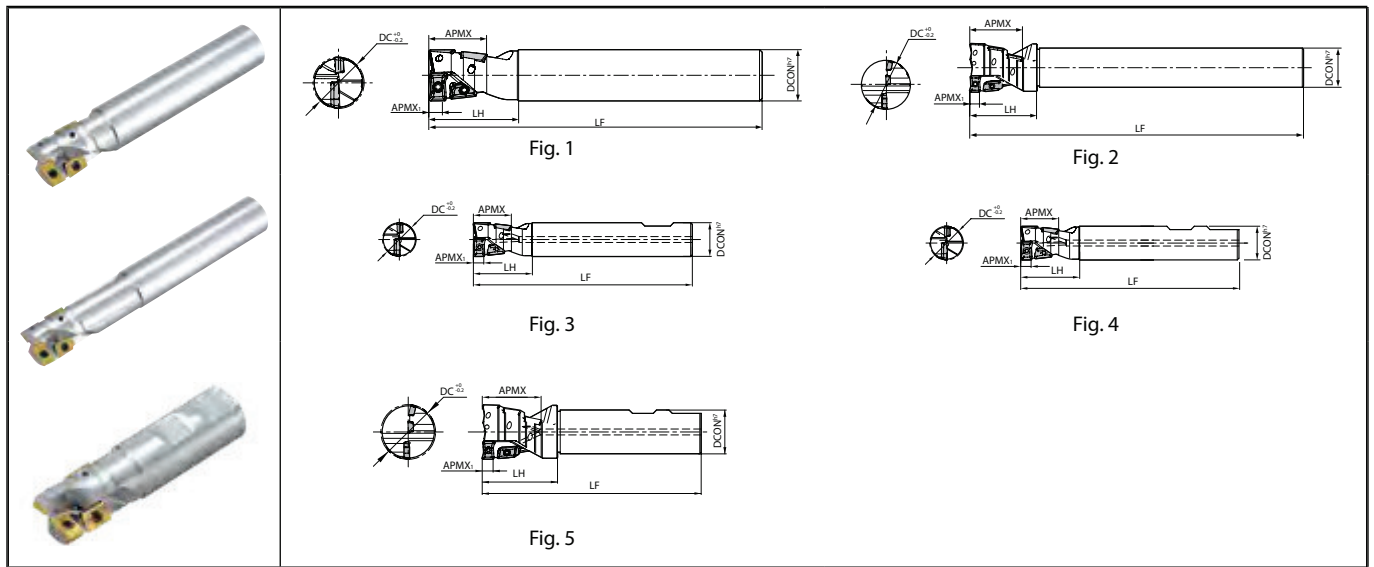

Toolholder dimensions

Description	Availability	Inserts	Flutes	Dimension (mm)						A.R. (°)	R.R. (°)	Coolant hole	Fig.	Spare parts			Applicable inserts M210					
				DC	DCON	LF	LH	APMX	APMX _i					Anti-seize compound	Screw	Wrench						
Standard	MEY	●	4	2	16	16	120	31	19	4.5	+11	-11	No	P-37				Center Edge : GOMT08T208ER-D Side Edge : JOMT08T208ER-D				
					17	17	120	31	19	4.5	+11	-11							1	SB-2040TRG	DTM-6	
					20	20	130	35	22	6	-9	-9							1	SB-2555TRG	DT-8	Center Edge : GOMT100308ER-D Side Edge : JOMT100308ER-D
					21	21	130	35	22	6	-9	-9							1	SB-2555TRG	DT-8	Center Edge : GOMT100308ER-D Side Edge : JOMT100308ER-D
					25	25	140	40	28	7.5	-11	-11							1	SB-3070TRG	DT-10	Center Edge : GOMT13T308ER-D Side Edge : JOMT13T308ER-D
					26	26	140	40	28	7.5	-11	-11							1	SB-3070TRG	DT-10	Center Edge : GOMT13T308ER-D Side Edge : JOMT13T308ER-D
					32	32	150	50	36	9.5	+13	-9							1	SB-4070TRG	DT-15	Center Edge : GOMT160408ER-D Side Edge : JOMT160408ER-D
					33	33	150	50	36	9.5	+13	-9							1	SB-4070TRG	DT-15	Center Edge : GOMT160408ER-D Side Edge : JOMT160408ER-D
					40	40	160	55	42	7.5	-11	-11							2	SB-3070TRG	DT-10	Center Edge : GOMT13T308ER-D Side Edge : JOMT13T308ER-D
					50	50	170	70	54	9.5	-9	-9							2	SB-4070TRG	DT-15	Center Edge : GOMT160408ER-D Side Edge : JOMT160408ER-D
Long head	MEY	●	4	2	16	16	140	51	19	4.5	+11	-11	No	P-37				Center Edge : GOMT08T208ER-D Side Edge : JOMT08T208ER-D				
					20	20	150	53	22	6	-9	-9							1	SB-2555TRG	DT-8	Center Edge : GOMT100308ER-D Side Edge : JOMT100308ER-D
					25	25	170	70	28	7.5	+13	-11							1	SB-3070TRG	DT-10	Center Edge : GOMT13T308ER-D Side Edge : JOMT13T308ER-D
					32	32	180	80	36	9.5	-9	-9							1	SB-4070TRG	DT-15	Center Edge : GOMT160408ER-D Side Edge : JOMT160408ER-D
Long shank	MEY	●	4	2	16	16	190	61	19	4.5	+11	-11	No	P-37				Center Edge : GOMT08T208ER-D Side Edge : JOMT08T208ER-D				
					17	17	190	61	19	4.5	+11	-11							1	SB-2040TRG	DTM-6	
					20	20	200	63	22	6	-9	-9							1	SB-2555TRG	DT-8	Center Edge : GOMT100308ER-D Side Edge : JOMT100308ER-D
					21	21	200	63	22	6	-9	-9							1	SB-2555TRG	DT-8	Center Edge : GOMT100308ER-D Side Edge : JOMT100308ER-D
					25	25	220	80	28	7.5	-11	-11							1	SB-3070TRG	DT-10	Center Edge : GOMT13T308ER-D Side Edge : JOMT13T308ER-D
					26	26	220	80	28	7.5	-11	-11							1	SB-3070TRG	DT-10	Center Edge : GOMT13T308ER-D Side Edge : JOMT13T308ER-D
					32	32	230	90	36	9.5	+13	-9							1	SB-4070TRG	DT-15	Center Edge : GOMT160408ER-D Side Edge : JOMT160408ER-D
					33	33	230	90	36	9.5	+13	-9							1	SB-4070TRG	DT-15	Center Edge : GOMT160408ER-D Side Edge : JOMT160408ER-D
					40	40	240	55	42	7.5	-11	-11							2	SB-3070TRG	DT-10	Center Edge : GOMT13T308ER-D Side Edge : JOMT13T308ER-D
					50	50	250	70	54	9.5	-9	-9							2	SB-4070TRG	DT-15	Center Edge : GOMT160408ER-D Side Edge : JOMT160408ER-D

APMX_i shows the edge length of the complete 2-insert part.

Coat Anti-seize Compound thinly on portion of taper and thread when insert is fixed.

● : Standard item R : Right-hand only L : Left-hand only □ : Check availability

M208

M

Milling

Cutting edge angle 45°~70°

Cutting edge angle 75°

Cutting edge angle 88°/90°

Cutter for Finishing

High Feed Cutter

Multi-Function

Slot Mill

Ball-nose Radius

Others

Toolholder dimensions

Description	Availability	Inserts	Flutes	Dimension (mm)						A.R. (°)	R.R. (°)	Coolant hole	Fig.	Spare parts			Applicable inserts M210
				DC	DCON	LF	LH	APMX	APMX1					Anti-seize compound	Screw	Wrench	
Weldon MEY 16-S16-80W-H 17-S16-80W-H 20-S20-85W-H 21-S20-85W-H 25-S25-95W-H 32-S32-110W-H 33-S32-110W-H 40-S32-130W-H 50-S40-140W-H	●	4	2	16	16	80	31	19	4.5	+11	-11	No	P-37	3	SB-2040TRG	DTM-6	Center Edge : GOMT08T208ER-D Side Edge : JOMT08T208ER-D
	●			17													
	●			20	20	85	35	22	6	-9	3			SB-2555TRG	DT-8	Center Edge : GOMT100308ER-D Side Edge : JOMT100308ER-D	
	●			21													3
	●	25		25	95	40	28	7.5	-11	4	SB-3070TRG			DT-10	Center Edge : GOMT13T308ER-D Side Edge : JOMT13T308ER-D		
	●	32														110	50
	●	33		130	55	42	7.5	-11	5	SB-3070TRG	DT-10			Center Edge : GOMT13T308ER-D Side Edge : JOMT13T308ER-D			
	●	40													50	40	140
	□	50	7														

APMX1 shows the edge length of the complete 2-insert part.
Coat Anti-seize Compound thinly on portion of taper and thread when insert is fixed.



Applicable Inserts

Description	Applicable Inserts M210			
	Side Edge	No. of Inserts	Center Edge	No. of Inserts
MEY 16-S16(-...) 17-S16(-...) 20-S20(-...) 21-S20(-...) 25-S25(-...) 26-S25(-...) 32-S32(-...) 33-S32(-...) 40-S32(-...) 50-S42(-...)	JOMT08T208ER-D JOMT100308ER-D JOMT13T308ER-D JOMT160408ER-D JOMT13T308ER-D JOMT160408ER-D	3 6	GOMT08T208ER-D GOMT100308ER-D GOMT13T308ER-D GOMT160408ER-D GOMT13T308ER-D GOMT160408ER-D	1

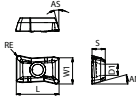

● : Standard item R : Right-hand only L : Left-hand only □ : Check availability

GOMT/JOMT

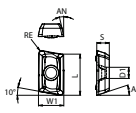
Insert		Description	No. of edges	Dimension (mm)					Angle (°)		Carbide	Applicable toolholder ● M208 ● M209
				S	D1	RE	L	W1	AN	AS		
				Classification of usage ★: Roughing / 1st Choice ☆: Roughing / 2nd Choice ■: Finishing / 1st Choice □: Finishing / 2nd Choice (In case hardness is 45HRC or under)								
				Carbon steel / Alloy steel					★		P	
				Mold and die steel					★			
				Austenitic stainless steel					☆		M	
				Martensitic stainless steel								
				Precipitation hardening stainless steel								
				Gray cast iron					★		K	
				Nodular cast iron					★			
				Non-ferrous metals							N	
				Heat-resistant alloy					★		S	
				Titanium alloy					★			
				Hard materials					□		H	
 	GOMT 08T208ER-D	2	2.78	2.3	0.8	8.7	5.21	17	13	●●	MEY16-S16(-...) MEY17-S16(-...)	
	GOMT 100308ER-D	2	3.3	2.8	0.8	10.7	6.56	17	13	●●	MEY20-S20(-...) MEY21-S20(-...)	
	GOMT 13T308ER-D	2	3.85	3.4	0.8	13.2	8.36	17	13	●●	MEY25-S25(-...) MEY26-S25(-...) MEY40-S32(-...)	
	GOMT 160408ER-D	2	4.76	4.4	0.8	16.7	10.03	17	13	●●	MEY32-S32(-...) MEY33-S32(-...) MEY50-S42(-...)	
 	JOMT 08T208ER-D	2	2.78	2.3	0.8	8.5	5.14	13	17	●●	MEY16-S16(-...) MEY17-S16(-...)	
	JOMT 100308ER-D	2	3.18	2.8	0.8	10.2	6.41	13	17	●●	MEY20-S20(-...) MEY21-S20(-...)	
	JOMT 13T308ER-D	2	3.7	3.4	0.8	13.2	8.07	13	17	●●	MEY25-S25(-...) MEY26-S25(-...) MEY40-S32(-...)	
	JOMT 160408ER-D	2	4.5	4.4	0.8	16.7	9.72	13	17	●●	MEY32-S32(-...) MEY33-S32(-...) MEY50-S42(-...)	

Handed insert shows Right-hand

Recommended cutting conditions ● M211



Cutting edge angle 45°~70°
Cutting edge angle 75°
Cutting edge angle 88°/90°
Cutter for Finishing
High Feed Cutter
Multi- Function
Slot Mill
Ball-nose Radius
Others

●: Standard item R: Right-hand only L: Left-hand only □: Check availability

M210

Recommended cutting conditions

Workpiece material	fz (mm/t)		Recommended insert grades (Vc: m/min)	
			MEGACOAT	
	Drilling	Shouldering, slotting	PR1225	PR1210
Carbon steel	0.08~0.15	0.05~0.25	★ 120~250	-
Alloy steel	0.08~0.15	0.05~0.25	★ 100~220	-
Mold steel	0.08~0.12	0.05~0.15	★ 80~180	-
Stainless steel	0.08~0.12	0.05~0.15	★ 120~220	-
Cast iron	0.05~0.20	0.05~0.25	-	★ 100~220

★: 1st Recommendation ☆: 2nd Recommendation

Caution of drilling

1. Drilling conditions should be calculated as one flute line.
2. Use compressed air during drilling.
3. Carbon steel other than low carbon steel can be drilled to a depth of 0.5D without step feeding.
For soft steel or sticky material such as stainless steel, Step feed drilling (0.5 ~ 1.0mm) is recommended.
4. For stainless steel drilling, coolant is recommended.
5. Please refer to right list for maximum hole depth.

Cutting dia. (DC)	Max. hole depth (mm)
ø16	13
ø17	13
ø20	17
ø21	17
ø25	22
ø26	22
ø32	29
ø33	29
ø40	36
ø50	40

Shape of the bottom of the drilled hole

Cutting dia.	a (mm)	Shape of the bottom
ø16, ø17	0.5	
ø20, ø21	0.64	
ø25, ø26	0.85	
ø32, ø33	1.12	
ø40	1.54	
ø50	1.65	



Milling

Examples of MEY multi-function machining

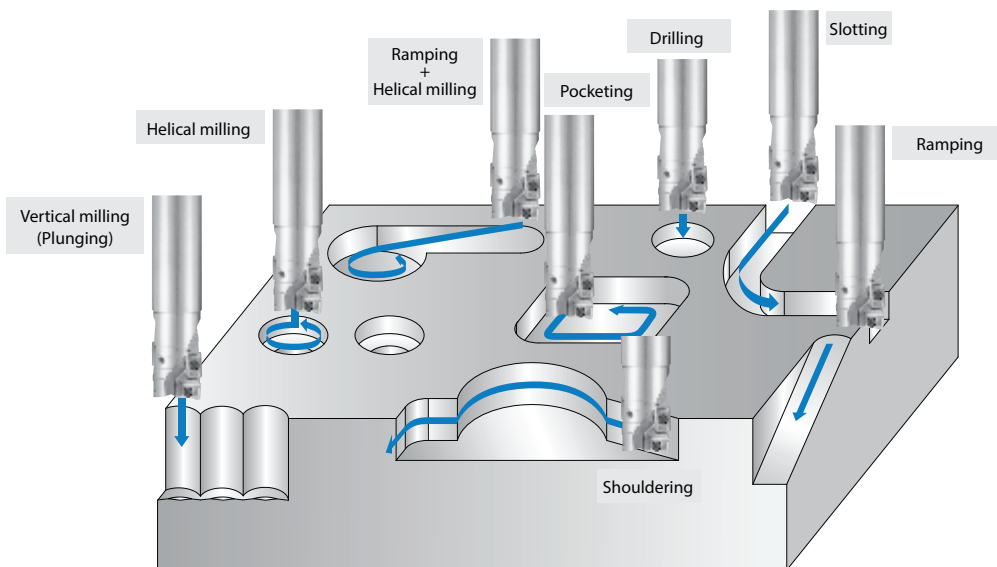

Cutting performance of MEY

Workpiece material: C50

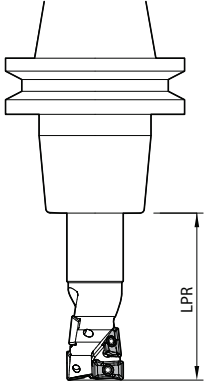
Cutting dia.	Description	Overhang length LPR (mm)			Cutting dia.	Description	Overhang length LPR (mm)			Shape
ø16	MEY16-S16	31	[~61]	(Not recommended)	ø25	MEY25-S25	40	[~70]	(Not recommended)	
	MEY16-S16-140H	-	~61	[~91]		MEY25-S25-170H	-	70	[~100]	
	MEY16-S16-190	-	61	~91		MEY25-S25-220	-	~80	~100	
ø17	MEY17-S16	31	[~61]	(Not recommended)	ø26	MEY26-S25	40	[~70]	(Not recommended)	
	MEY17-S16-190	31	~61	~91		MEY26-S25-220	40	~70	~100	
ø20	MEY20-S20	35	[~65]	(Not recommended)	ø32	MEY32-S32	50	[~80]	(Not recommended)	
	MEY20-S20-150H	-	~65	[~95]		MEY32-S32-180H	-	~80	[~110]	
	MEY20-S20-200	-	65	~95		MEY32-S32-230	-	90	~110	
ø21	MEY21-S20	35	[~65]	(Not recommended)	ø33	MEY33-S32	50	[~80]	(Not recommended)	
	MEY21-S20-200	35	~65	~95		MEY33-S32-230	50	~80	~110	
ø40	MEY40-S32	55	[~85]	[~115]	ø50	MEY50-S42	70	[~100]	[~130]	
	MEY40-S32-240	55	~85	~115		MEY50-S42-250	70	~100	~130	

When using in [] dimension, be careful that the chucking length to the shank may get too short.

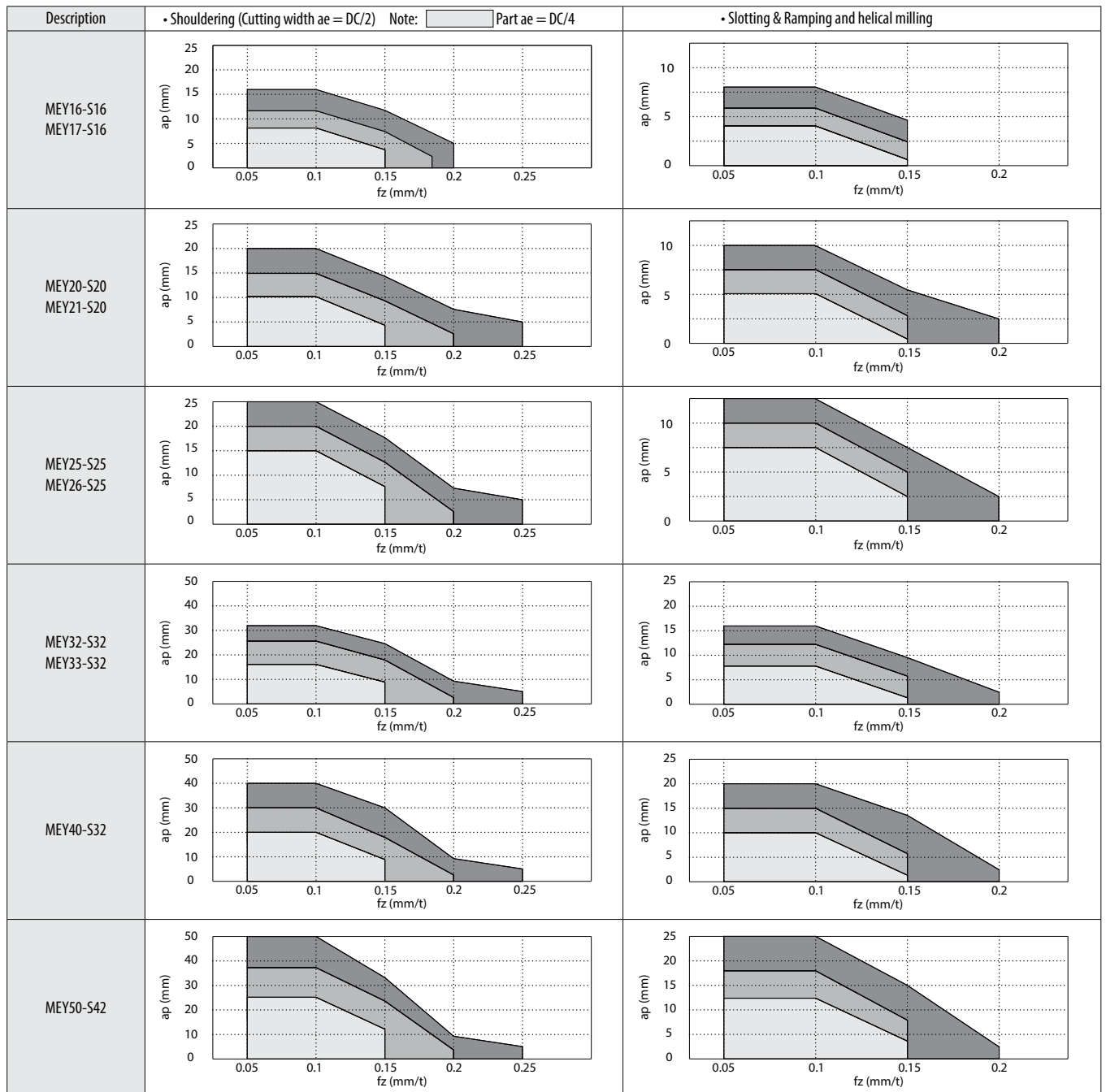

M



Milling

Cutting edge angle 45°~70°

Cutting edge angle 75°

Cutting edge angle 88°/90°

Cutter for Finishing

High Feed Cutter

Multi-Function

Slot Mill

Ball-nose Radius

Others

Drilling (Standard/long head/long shank: C50)

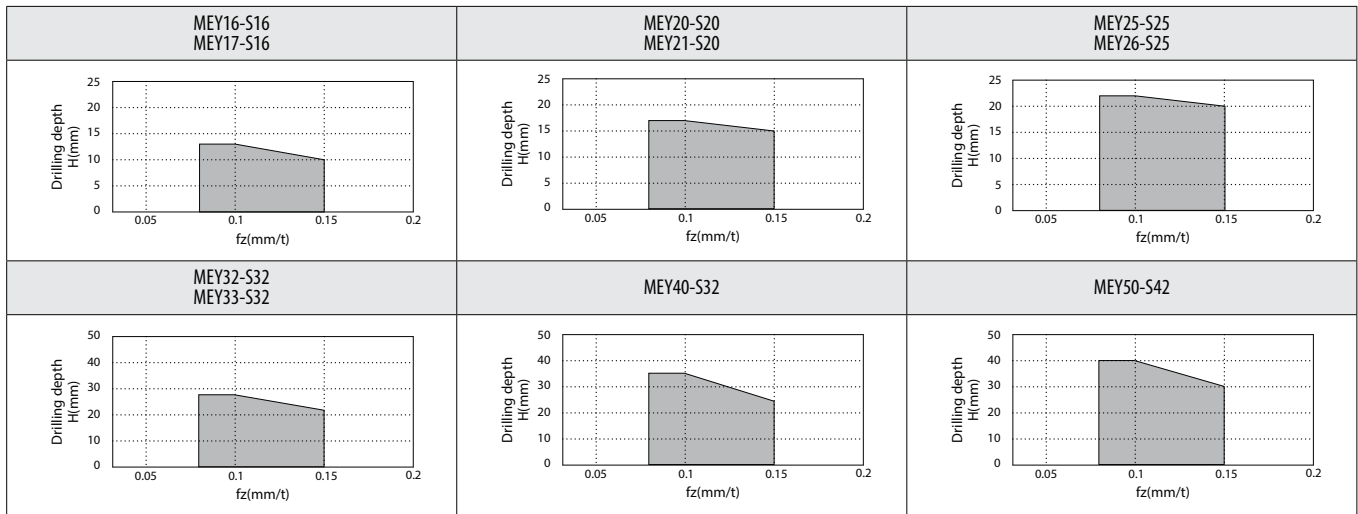

How to use MEY effectively

Ramping/Helical milling

- Ramping angle is recommended to be 8° or under. Sinking depth per revolution when helical milling should be 1/2DC or under.
- Use compressed air during machining.

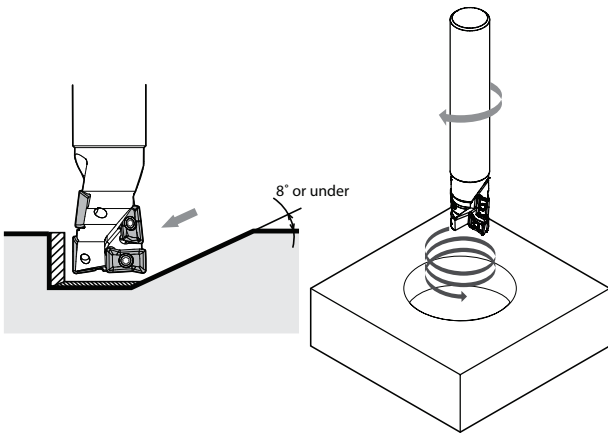

Helical milling factors

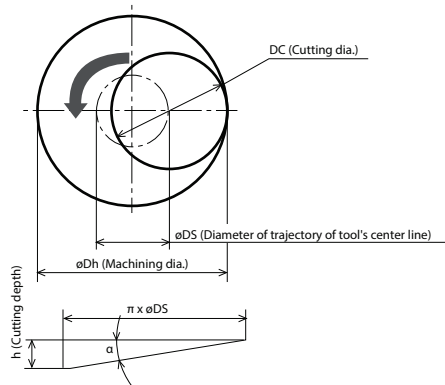

øDS (How to find diameter of trajectory of tool's center line)

$$\text{øDS} = \text{øDh} - \text{DC}$$

h How to find "h"

$$h = \pi \times \text{øDS} \times \tan \alpha$$

(alpha should be 8° or under)

Shouldering

- Tools with 1mm larger cutting diameter than shank diameter are available. High wall shouldering is possible.
- Lineup

Description	DC (mm)	DCON (mm)
MEY17-S16	17	16
MEY21-S20	21	20
MEY26-S25	26	25
MEY33-S32	33	32
MEY17-S16-190	17	16
MEY21-S20-200	21	20
MEY26-S25-220	26	25
MEY33-S32-230	33	32

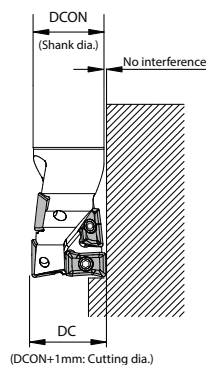



Full range from 1.6 mm to 23.3 mm in 3 types

Lineup of MST series slot mills

Type	Applicable inserts	Features	Slot width (mm)															
			1.6	2.2 (2.25)	3.05	4.05	6	8	10	13	14	16	18	20	22	24		
MSTA	SLT..	1.6 ~ 4.05 mm fixed	●	●	●	●												
MSTB	LNEU12..	6 ~ 13 mm semi-adjustable					▶ * Adjustable in 0.5mm increments between 6mm and 13mm with the combination of inserts											
MSTC	SP..10T3..	14 ~ 18 mm full-adjustable										▶ * Adjustable between 14mm and 18mm						
	SD..1204...	18 ~ 23.3 mm full-adjustable													▶ * Adjustable between 18mm and 23.3mm			



Slot mill MSTA (Slot width 1.6, 2.2(2.25), 3.05, 4.05 mm)

Self-clamping type slot mill

MSTA slot mills have simple self-clamping system to allow for easy attachment by just installing the insert.

High rigidity clamping system

Owing to the high rigidity clamping system – with an end – stopper, the toolholder enable high operability and stable slotting by maintaining an accurate edge position.

Double-prism clamping system

High replacement precision with the double-prism clamping system

Easy replacement

The replacement of inserts is easy and quick by using special wrench.

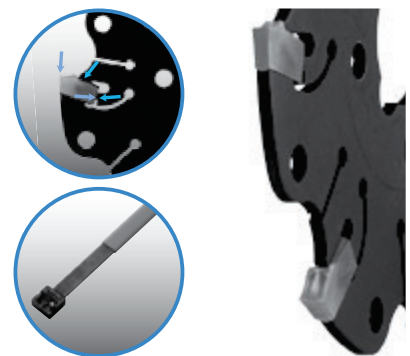

Wrench is not attached. Please purchase it separately.

Slot mill MSTB (Slot width 6.0 ~ 13.0mm)

Up-right type/semi-adjustable slot width

Easy and secure screw holding

Inserts can be attached to the MSTB slot mills very easily by using clamp screws.

Economical inserts with 4 cutting edges

Applicable to a variety of slotting by choosing different inserts

By changing the thickness of inserts, it's applicable to various slotting widths up to max 13mm in 0.5mm increments.

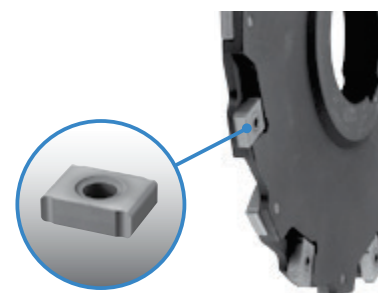

- Cutting edge angle 45°~70°
- Cutting edge angle 75°
- Cutting edge angle 88°/90°
- Cutter for Finishing
- High Feed Cutter
- Multi-Function
- Slot Mill
- Ball-nose Radius
- Others

Slot mill MSTC (Slot width 14.0 ~ 23.3 mm)

Lay-down type/full-adjustable slot width

Applicable to various slotting needs. Slotting widths: 14.0mm to 23.3mm.

Cutter dia.: from 100mm to 160mm

Smooth slotting width adjustment is possible owing to unique cam style adjustment mechanism.

Economical 4-edge Insert

A wide range of corner-R is suitable for various work.

Owing to the wiper edge insert, an excellent surface finish can be expected.

Owing to numerous insert geometries and grades, they are applicable for various types of workpiece machining.

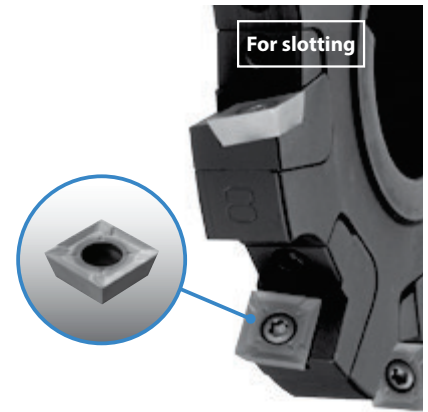

Features of insert grades

Insert shape			
Symbol	SB	SD	SE
Rake angle			
Shape			

CA0835

- TiN+TiCN+Al₂O₃ based CVD coated carbide
- For carbon steel, alloy steel, stainless steel and nodular cast iron.
- For middle to high speed machining.

PR0725

- TiN+TiCN+TiN based multi-layer PVD coated carbide
- For carbon steel, alloy steel, stainless steel, heat-resistant alloys and cast iron.
- For middle speed machining.

PR0110

- TiB₂ based PVD coated carbide
- For non-ferrous metals such as aluminum alloys (Si<10%) and titanium alloys.
- For high speed machining.

With boss

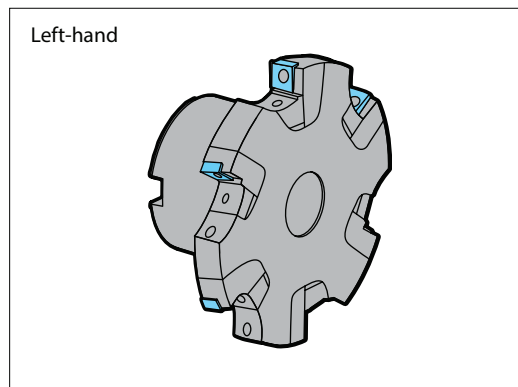
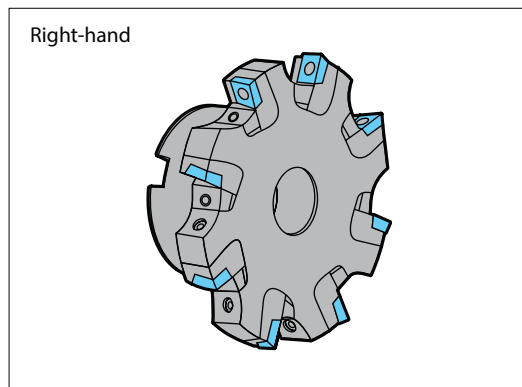

MSTA

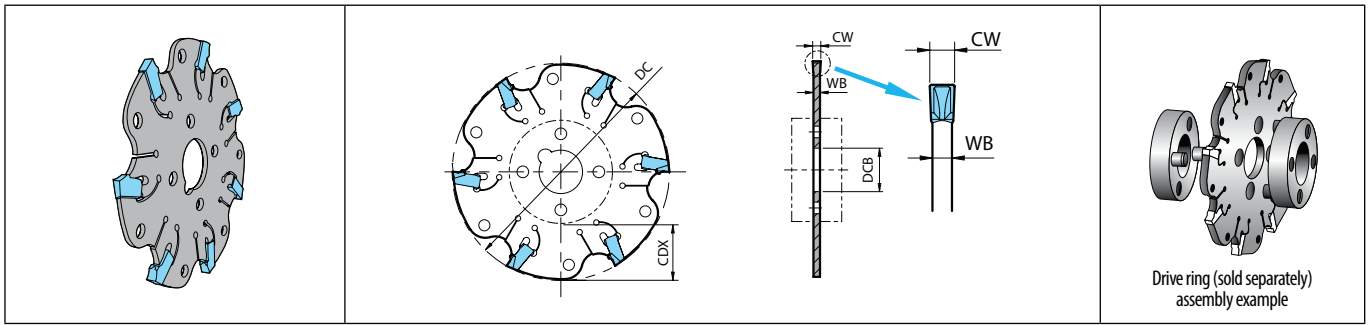

Toolholder dimensions (Metric)

Description	Availability		Dimension (mm)					Coolant hole	Max. revolution (min ⁻¹)	Weight (kg)	Applicable inserts M218
	N	Inserts	DC	DCB	CDX	WB	CW				
MSTA 63N16-5T 80N16-7T 100N16-9T 125N16-11T	●	5	63	16	15	1.3	1.6	No	5100	0.03	SLT...SKB SLT...SKD
	●	7	80	21	4000				0.04		
	●	9	100	27	3200				0.07		
	●	11	125	35	2600				0.1		
MSTA 63N22-5T 80N22-7T 100N22-9T 125N22-11T 160N22-14T	●	5	63	16	15	1.8	2.2	No	5100	0.03	SLT...SKB SLT...SKD
	●	7	80	21	4000				0.05		
	●	9	100	27	3200				0.08		
	●	11	125	35	2600				0.12		
	●	14	160	40	2000				0.3		
MSTA 63N30-4T 80N30-6T 100N30-9T 125N30-11T 160N30-14T	●	4	63	16	15	2.4	3.05	No	5100	0.05	SLT...SKB SLT...SKD
	●	6	80	21	4000				0.08		
	●	9	100	27	3200				0.13		
	●	11	125	35	2600				0.2		
	●	14	160	40	2000				0.35		
MSTA 63N40-4T 80N40-6T 100N40-9T 125N40-11T 160N40-14T	●	4	63	16	15	3.4	4.05	No	5100	0.06	SLT...SKB SLT...SKD
	●	6	80	21	4000				0.1		
	●	9	100	27	3200				0.15		
	●	11	125	35	2600				0.25		
	●	14	160	40	2000				0.4		

Attach the drive ring (sold separately) to MSTA slot mill to use. Drive ring is sold singularly.

Please purchase two drive rings per one MSTA slot mill.

Do not exceed the max. revolution.

Do not operate cutting on reverse revolution.

Wrench (MS-FRW1) is not attached. Please purchase it separately.

Drive ring (For Metric)

Shape	Description	Availability	Dimension (mm)					Drawing	Applicable toolholders			
			DCB	DIOUT	WB	KWW	DCON					
	DR16-32A	●	16	32	8	4.1	3	Fig. 2	MSTA 63N16-5T			
	DR16-32B	●		32					MSTA 63N22-5T			
	DR16-38	●	16	38	8	4.1	4	Fig. 1	MSTA 63N30-4T			
	DR22-46	●		38					MSTA 63N40-4T			
	DR32-55	●	22	46	10	6.1	5	Fig. 3	MSTA 80N○○○T			
	DR40-80	●							55	8.1	6	MSTA 100N○○○T
	DR32-55	●							80	10.1	12	MSTA 125N○○○○T
	DR40-80	●	40	80	12	10.1	12		MSTA 160N○○○○T			

● : Standard item R : Right-hand only L : Left-hand only □ : Check availability

M216



- Cutting edge angle 45°~70°
- Cutting edge angle 75°
- Cutting edge angle 88°/90°
- Cutter for Finishing
- High Feed Cutter
- Multi-Function
- Slot Mill
- Ball-nose Radius
- Others

Identification system MSTA toolholder

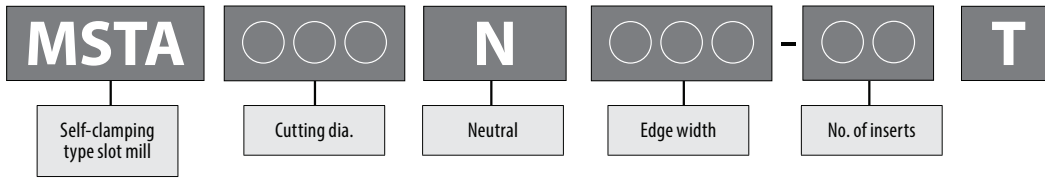

Toolholder dimensions (inch spec)

Description	Availability	Inserts	Dimension (in , (mm))					Coolant hole	Max. revolution (min ⁻¹)	Weight (kg)	Applicable inserts M218
			DC	DCB	CDX	CW	WB				
MSTA 02N063-5T 03N063-7T 04N063-9T 05N063-11T	●	5	2.5 (63.5)	0.625 (15.875)	0.625 (15.875)	0.063 (1.6)	0.051 (1.3)	No	5100	0.03	SLT...SKB SLT...SKD
	●	7	3 (76.2)		0.875 (22.225)				4000	0.04	
	●	9	4 (101.6)	1 (25.4)	1.063 (27)				3200	0.07	
	●	11	5 (127)	1.25 (31.75)	1.375 (34.925)				2600	0.1	
MSTA 03N089-7T 04N089-9T 06N089-14T	●	7	3 (76.2)	0.625 (15.875)	0.875 (22.225)	0.089 (2.2) (2.25)	0.071 (1.8)	No	4000	0.05	SLT...SKB SLT...SKD
	●	9	4 (101.6)	1 (25.4)	1.063 (27)				3200	0.08	
	●	14	6 (152.4)	1.25 (31.75)	1.438 (36.525)				2000	0.3	
MSTA 02N126-4T 03N126-6T 04N126-9T 05N126-11T 06N126-14T	●	4	2.5 (63.5)	0.625 (15.875)	0.625 (15.875)	0.120 (3.05)	0.095 (2.4)	No	5100	0.05	SLT...SKB SLT...SKD
	●	6	3 (76.2)		0.875 (22.225)				4000	0.08	
	●	9	4 (101.6)	1 (25.4)	1.063 (27)				3200	0.13	
	●	11	5 (127)	1.25 (31.75)	1.375 (34.925)				2600	0.2	
MSTA 03N164-6T 04N164-9T 05N164-11T	●	6	3 (76.2)	0.625 (15.875)	0.875 (22.225)	0.160 (4.05)	0.134 (3.4)	No	4000	0.1	SLT...SKB SLT...SKD
	●	9	4 (101.6)	1 (25.4)	1.063 (27)				3200	0.15	
	●	11	5 (127)	1.25 (31.75)	1.375 (34.925)				2600	0.25	

Attach the drive ring (sold separately) to MSTA slot mill to use. Drive ring is sold singularly.
 Please purchase two drive rings per one MSTA slot mill.
 Do not exceed the max. revolution.
 Do not operate cutting on reverse revolution.
 Wrench (MS-FRW1) is not attached. Please purchase it separately.



Milling

Drive ring (For Inch spec)

Shape	Description	Availability	Dimension (inch)					Drawing	Applicable toolholders
			DCB	DIOUT	WB	KWW	DCON		
	DR0625-1250A	○					.158 (4mm)	Fig. 1	MSTA 02N126-4T
	DR0625-1250B	○	.625 (15.875mm)	1.250 (31.75mm)	.315 (8mm)	.130 (3.3mm)		Fig. 2	MSTA 02N063-5T
	DR0625-1250C	○					.120 (3mm)	Fig. 3	MSTA 03N○○○-○T
	DR1000-1875	○	1.000 (25.4mm)	1.875 (47.625mm)	.394 (10mm)	.256 (6.5mm)	.200 (5mm)		MSTA 04N○○○-○T
	DR1250-2250	○	1.250 (31.75mm)	2.250 (57.15mm)	.319 (8.1mm)	.319 (8.1mm)	.240 (6mm)		MSTA 05N○○○-○T
	DR1250-3125	○	1.250 (31.75mm)	3.125 (79.375mm)	.472 (12mm)	.319 (8.1mm)	.472 (12mm)		MSTA 06N○○○-○T

● : Standard item R : Right-hand only L : Left-hand only □ : Check availability

SLT

Insert		Description	Dimension (mm)		Angle (°)	Tolerance (mm)		Carbide		Applicable toolholder M216 M217
			CW	RE	GAN	CW min.	CW max.	CA0835	PR0735	
<p>Low cutting force</p>		SLT 16-15SKB	1.6	0.15	5	-0.1	0	●	○	MSTA...
		SLT 22-20SKB	2.2	0.2	5	-0.05	+0.08	●	●	
		SLT 30-20SKB	3.05	0.2	5	0	+0.15	●	●	
		SLT 40-20SKB	4.05	0.2	5	0	+0.15	●	●	
		SLT 16-15SKD	1.6	0.15	15	-0.1	0	●	●	
		SLT 22-20SKD	2.25	0.2	15	0	+0.15	●	●	
		SLT 30-20SKD	3.05	0.2	15	0	+0.15	●	●	
		SLT 40-20SKD	4.05	0.2	15	0	+0.15	●	●	

Classification of usage

● : 1st Choice

○ : 2nd Choice

Carbon steel / Alloy steel	●	○	P
Mold and die steel			
Stainless steel	○	●	M
Gray cast iron	○		K
Nodular cast iron	○		
Non-ferrous metals			N
Heat-resistant alloy		●	S
Titanium alloy			
Hard materials			H

Recommended cutting conditions M219

Inserts identification system

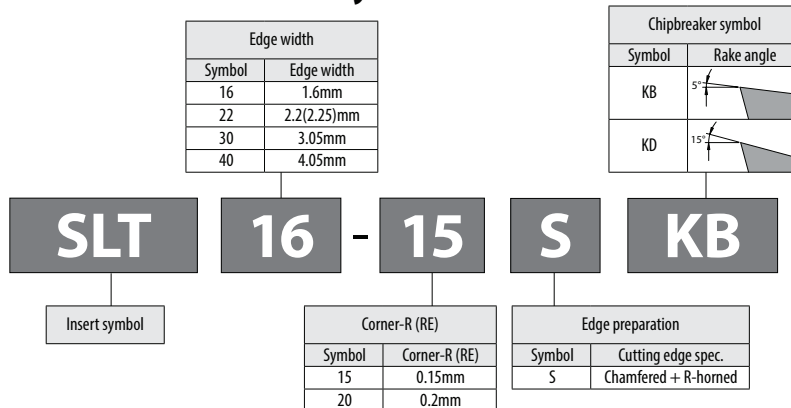

Selection of chipbreaker

- KB chipbreaker ... general purpose chipbreaker for steel and cast iron
- KD chipbreaker ... low cutting force chipbreaker for stainless steel

Features of insert grades

CA0835

- TiN+TiCN+Al₂O₃ based CVD Coated carbide
- For carbon steel, alloy steel, stainless steel and cast iron
- For middle to high speed machining

PR0735

- TiN base PVD Coated carbide
- For stainless steel, heat-resistant alloys, etc.
- For low to middle speed machining

● : Standard item R : Right-hand only L : Left-hand only □ : Check availability

M218



Cutting edge angle 45°~70°
Cutting edge angle 75°
Cutting edge angle 88°/90°
Cutter for Finishing
High Feed Cutter
Multi-Function
Slot Mill
Ball-nose Radius
Others

Set up

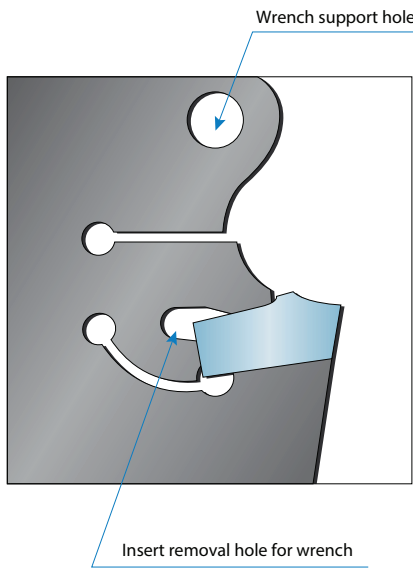

How to attach inserts

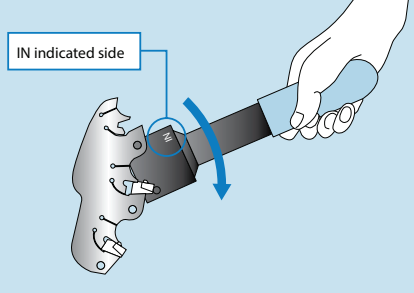

1. Put insert inside the slot mill.
2. Insert one of the pins on the wrench (on IN indicated side) into the wrench support hole.
3. Using the other pin, push the front relief surface of the insert.
4. Rotate the wrench until insert's back end makes contact with slot mill.

How to detach inserts

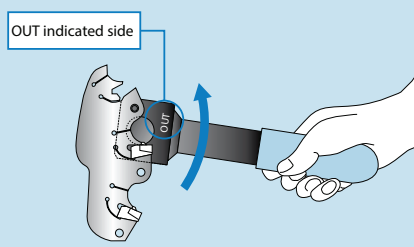

1. Insert one of the pins on the wrench (on OUT indicated side) into the wrench support hole, and insert other pin into the insert releasing hole.
2. Insert can be uninstalled by rotating the wrench counterclockwise. (A magnet is installed on OUT indicated side.)

Note: Use appropriate wrench for set up.

Recommended cutting conditions

Workpiece material		Hardness (HB)	Recommended insert grades (Vc: m/min)		fz (mm/t)				Remarks
			CVD coated carbide	PVD coated carbide	Edge width (mm)				
			CA0835	PR0735	1.6	2.2(2.25)	3.05	4.05	
Low carbon steel	C10 ~ C25	125	250~310	200~250	0.03~0.12	0.04~0.14	0.06~0.18	0.08~0.20	Coolant
Carbon steel	C30 ~ C60 (Annealed)	190	160~190	130~160	0.03~0.12	0.04~0.14	0.06~0.18	0.08~0.20	
	C30 ~ C60 (Heat treated)	250	140~180	110~150	0.03~0.12	0.04~0.14	0.06~0.18	0.08~0.20	
Alloy steel	CrMo, Cr (Annealed)	180	140~180	110~150	0.03~0.12	0.04~0.14	0.06~0.18	0.08~0.20	
	CrMo, Cr (Heat treated)	275	120~160	100~130	0.03~0.10	0.04~0.12	0.06~0.16	0.08~0.18	
High carbon alloy	X153CrMoV12, X40CrMoV51, etc.	280	100~140	80~120	0.03~0.10	0.04~0.12	0.06~0.16	0.08~0.18	
Stainless steel	Austenitic related X5CrNi18 10, X5CrNiMo17 12 2, CrNi2520, etc.	220	150~190	80~120	0.03~0.10	0.04~0.12	0.06~0.16	0.08~0.18	
	Martensitic related X10Cr13, X6Cr17 etc.	300	140~180	60~80	0.03~0.10	0.04~0.12	0.06~0.16	0.08~0.18	
Gray cast iron	GG25 ~ GG35	260	160~200	-	0.03~0.12	0.04~0.14	0.06~0.18	0.08~0.20	Dry
Nodular cast iron	GGG40 ~ GGG50	160	130~160	-	0.03~0.12	0.04~0.14	0.06~0.18	0.08~0.20	
	GGG60 ~ GGG80	250	110~140	-	0.03~0.12	0.04~0.14	0.06~0.18	0.08~0.20	

Note: 1. Use down-cut machining.
 2. If ap is 1/10 or under of cutter dia.(DC), it is possible to increase feed per tooth (fz) by 40%.

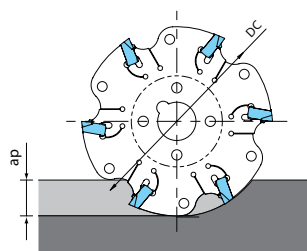

Identification system toolholder MSTB

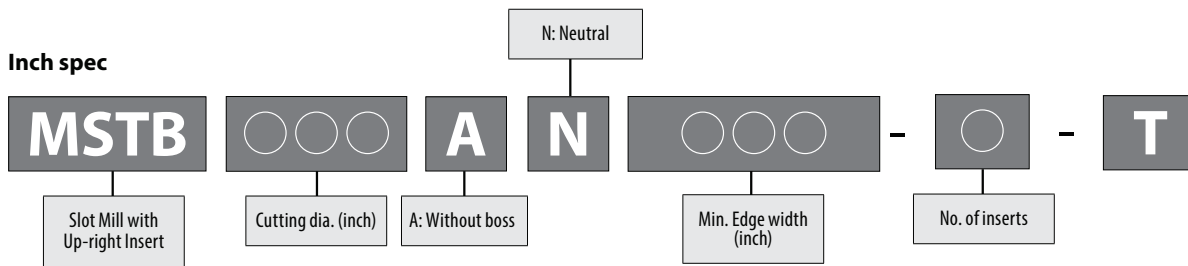

MSTB (Without Boss, Inch spec)

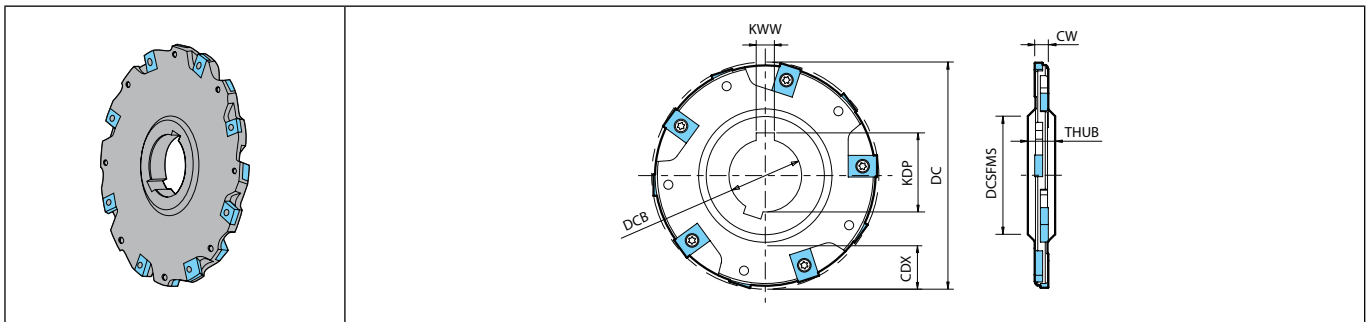

In order to be used in combination with two or more mills, this slot mill has 2 key slots.

Toolholder dimensions

Description	Availability		Dimension (in, (mm))											Coolant hole Max. revolution (min ⁻¹)	Weight (kg)	Spare parts			Applicable inserts ➔ M223	
	N	Inserts	Edge line	DC	DCSFMS	DCB	KDP	KWW	CDX	THUB	CW min.	CW max.	Max. revolution (min ⁻¹)			Weight (kg)	Anti-seize compound	Screw		Wrench
																	●	○		□
MSTB 3000AN250-4T 4000AN250-5T 5000AN250-6T 6000AN250-8T	●	8	4	3 (76.2)	1.5 (38.1)	1 (25.4)	1.106 (28.1)	0.25 (6.35)	0.625 (15.875)					9470	P-37	SE-40055TR	TT-15	LNEU12...		
	●	10	5	4 (101.6)	1.88 (47.8)	1.25 (31.75)	1.386 (35.2)	0.312 (7.92)	0.935 (23.8)	0.5 (12.7)	0.25 (6.35)	0.289 (7.34)	No	8200						
	●	12	6	5 (127)					1.435 (36.4)					7300						
	●	16	8	6 (152.4)	2.25 (57.2)	1.5 (38.1)	1.665 (42.3)	0.375 (9.52)	1.75 (44.45)					6700						
MSTB 4000AN312-5T 5000AN312-6T 6000AN312-8T	●	10	5	4 (101.6)	1.88 (47.8)	1.25 (31.75)	1.386 (35.2)	0.312 (7.92)	0.966 (24.5)					7400	P-37	SE-40068TR	TT-15	LNEU12...		
	●	12	6	5 (127)					1.466 (37.2)	0.5 (12.7)	0.312 (7.92)	0.351 (8.91)	No	6600						
	●	16	8	6 (152.4)	2.25 (57.2)	1.5 (38.1)	1.665 (42.3)	0.375 (9.52)	1.781 (45.2)					6000						
MSTB 4000AN375-3T 5000AN375-4T 6000AN375-5T	●	9	3	4 (101.6)	1.88 (47.8)	1.25 (31.75)	1.386 (35.2)	0.312 (7.92)	1 (25.4)					7400	P-37	SE-40068TR	TT-15	LNEU12...		
	●	12	4	5 (127)					1.5 (38.1)	0.5 (12.7)	0.375 (9.525)	0.414 (10.52)	No	6600						
	●	15	5	6 (152.4)	2.25 (57.2)	1.5 (38.1)	1.665 (42.3)	0.375 (9.52)	1.812 (46)					6000						
MSTB 4000AN500-3T 5000AN500-4T 6000AN500-5T	●	9	3	4 (101.6)	1.88 (47.8)	1.25 (31.75)	1.386 (35.2)	0.312 (7.92)	1.06 (26.9)					4900	P-37	SE-40090TR	TT-15	LNEU12...		
	●	12	4	5 (127)					1.56 (39.6)	0.5 (12.7)	0.5 (12.7)	0.539 (13.69)	No	4400						
	●	15	5	6 (152.4)	2.25 (57.2)	1.5 (38.1)	1.665 (42.3)	0.375 (9.52)	1.875 (47.6)					4000						

Coat Anti-seize Compound thinly on portion of taper and thread when insert is fixed.

● : Standard item R : Right-hand only L : Left-hand only □ : Check availability



MSTB (With Boss, Metric)

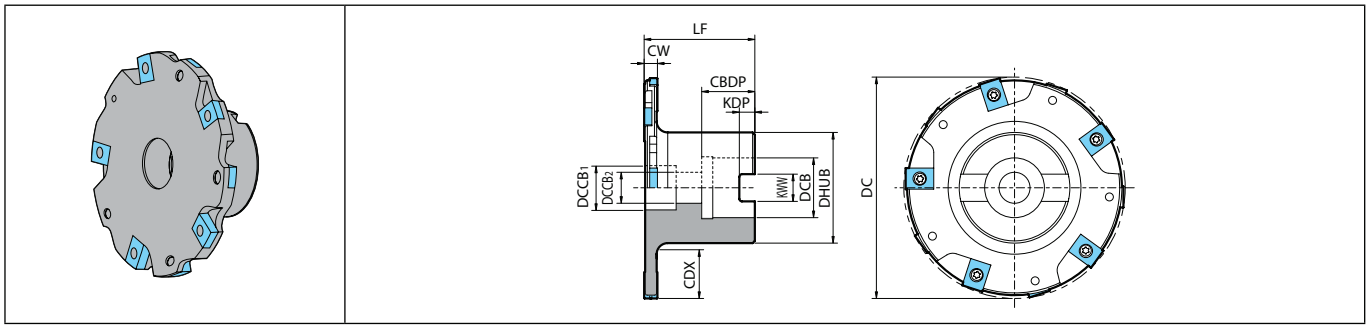

Toolholder dimensions

Description	Availability		Edge line	Dimension (mm)														Coolant hole	Max. revolution (min ⁻¹)	Weight (kg)	Spare parts				Applicable inserts ● M223
	N	Inserts		DC	DCB	DCCB ₁	DCCB ₂	LF (min.)	CDBP	KDP	KWW	CDX	DHUB	CW min.	CW max.	Anti-seize compound	Mounting bolt				Screw	Wrench			
																							Max. rev.	Weight	
MSTB 80SN0607-4T 100SN0607-5T 160SN0607-8T	●	8 4	80	22	18	12		23	6.3	10.4	16	40			No	9240	0.7	P-37	HH10X35	SE-40050TRN	TT-15	LNEU12...			
	●	10 5	100	27	20	14	50	24	7	12.4	21	50	6	7	No	8270	1		HH12X35						
	●	16 8	160	40	33	22		28	9	16.4	41	70			No	6540	1.9		HH20X40						
MSTB 80SN0809-4T 100SN0809-5T 160SN0809-8T	●	8 4	80	22	18	12		23	6.3	10.4	16	40			No	9240	0.8	P-37	HH10X35	SE-40068TR	TT-15	LNEU12...			
	●	10 5	100	27	20	14	50	24	7	12.4	21	50	8	9	No	8270	1.2		HH12X35						
	●	16 8	160	40	33	22		28	9	16.4	41	70			No	6540	2.2		HH20X40						
MSTB 125SN1011-4T 160SN1011-5T	●	12 4	125								26				No	7390	2	P-37	HH20X40	SE-40068TR	TT-15	LNEU12...			
	●	15 5	160	40	33	22	50	28	9	16.4	43	70	10	11	No	6540	2.5								

LF (min.) dimension shows in case of minimum of edge width (CW).
Coat Anti-seize Compound thinly on portion of taper and thread when insert is fixed.



Cutting edge angle 45°~70°
Cutting edge angle 75°
Cutting edge angle 88°/90°
Cutter for Finishing
High Feed Cutter
Multi- Function
Slot Mill
Ball-nose Radius
Others

● : Standard item R : Right-hand only L : Left-hand only □ : Check availability

M222

LNEU

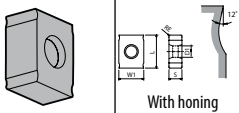
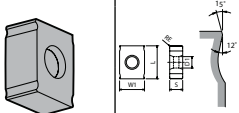
Classification of usage		Carbon steel / Alloy steel		● P				
		Mold and die steel						
● : 1st Choice ○ : 2nd Choice		Stainless steel		● M				
		Gray cast iron		○ K				
		Nodular cast iron		○ K				
		Non-ferrous metals		● N				
		Heat-resistant alloy		● S				
		Titanium alloy		○ S				
		Hard materials		● H				
Insert	Description	No. of edges	Dimension (mm)			Carbide PVD PR0725	Applicable toolholder ➔ M220~M222	Applicable clamp screw
			S	D1	RE			
 <p>With honing</p>	LNEU 1235-03-4	4	3.5	4.4	0.3	●	M220, M222 M220, M222M220, M222M220, M222 M220 M220	SE-40050TRN
	LNEU 1240-08-4	4	4	4.4	0.8	●		SE-40055TR
	LNEU 1245-04 1245-08	4	4.5	4.2	0.4 0.8	● ●		SE-40068TR
	LNEU 1250-04 1250-08	4	5	4.2	0.4 0.8	● ●		SE-40080TR
	LNEU 1255-04 1255-08	4	5.5	4.2	0.4 0.8	● ●		SE-40090TR
	LNEU 1260-04	4	6	4.2	0.4	●		SE-40100TR
 <p>Tough edge</p>	LNEU 1235-03S-4	4	3.5	4.4	0.3	●	MSTB...	SE-40050TRN
	LNEU 1240-03S-4	4	4	4.4	0.3	●		SE-40055TR
	LNEU 1245-04S 1245-08S	4	4.5	4.2	0.4 0.8	● ●		SE-40068TR
	LNEU 1250-04S 1250-08S	4	5	4.2	0.4 0.8	● ●		SE-40080TR

Please select the applicable clamp screw depending on each insert description. Recommended cutting conditions ➔ M225
 See page M224 for insert description and applicable clamp screw depending on edge width.



Inserts identification system

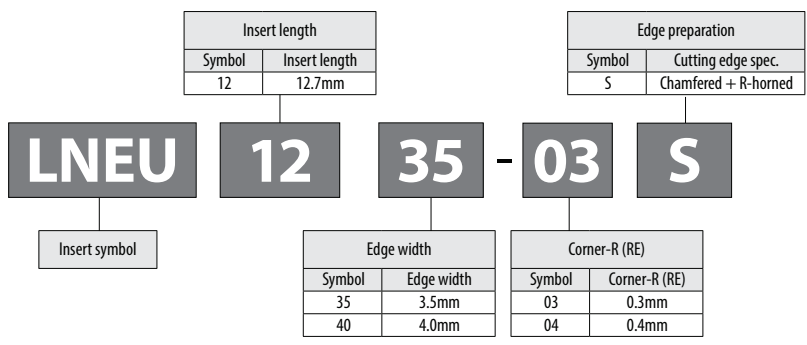

● : Standard item R : Right-hand only L : Left-hand only □ : Check availability

Combination of applicable inserts

Description	Clamp screw (Standard attachment parts)	Edge width		A Line		B Line		C Line		Wrench for clamp screw	Tightening torque (N·m)	
		mm	inch (mm)	Applicable inserts	Clamp screw	Applicable inserts	Clamp screw	Applicable inserts	Clamp screw			
Metric	MSTB ○○○AN0607-○T ○○○SN0607-○T	SE-40050TRN	6	-	LNEU1235..	SE-40050TRN	-	-	LNEU1235..	SE-40050TRN	TT-15	3
			6.5		LNEU1240..	SE-40055TR			LNEU1240..	SE-40055TR		
			7		LNEU1245..	SE-40068TR			LNEU1245..	SE-40068TR		
	MSTB ○○○AN0809-○T ○○○SN0809-○T	SE-40068TR	8	-	LNEU1245..	SE-40068TR	-	-	LNEU1245..	SE-40068TR		
			8.5		LNEU1250..	SE-40080TR			LNEU1250..	SE-40080TR		
			9		LNEU1245..	SE-40068TR			LNEU1245..	SE-40068TR		
	MSTB ○○○AN1011-○T ○○○SN1011-○T	SE-40068TR	10	-	LNEU1245..	SE-40068TR	LNEU1245..	SE-40068TR	LNEU1245..	SE-40068TR		
			10.5		LNEU1250..	SE-40080TR	LNEU1250..	SE-40080TR	LNEU1250..	SE-40080TR		
			11		LNEU1255...	SE-40090TR	LNEU1255...	SE-40090TR	LNEU1255...	SE-40090TR		
	MSTB ○○○AN1213-○T	SE-40090TR	12	-	LNEU1255...	SE-40090TR	LNEU1255...	SE-40090TR	LNEU1255...	SE-40090TR		
			12.5		LNEU1260...	SE-40100TR	LNEU1260...	SE-40100TR	LNEU1260...	SE-40100TR		
			13		LNEU1240..	SE-40055TR	LNEU1240..	SE-40055TR				
Inch spec	MSTB ○○○○AN250-○T	SE-40055TR	.250 (6.35mm)	-	LNEU1240..	SE-40055TR	-	-	LNEU1240..	SE-40055TR		
			.270 (6.86mm)		LNEU1245..	SE-40068TR			LNEU1245..	SE-40068TR		
			.289 (7.34mm)		LNEU1245..	SE-40068TR			LNEU1245..	SE-40068TR		
	MSTB ○○○○AN312-○T	SE-40068TR	.312 (7.92mm)	-	LNEU1245..	SE-40068TR	-	-	LNEU1245..	SE-40068TR		
			.332 (8.43mm)		LNEU1250..	SE-40080TR			LNEU1250..	SE-40080TR		
			.351 (8.91mm)		LNEU1245..	SE-40068TR			LNEU1245..	SE-40068TR		
	MSTB ○○○○AN375-○T	SE-40068TR	.375 (9.525mm)	-	LNEU1245..	SE-40068TR	LNEU1245..	SE-40068TR	LNEU1245..	SE-40068TR		
			.395 (10.33mm)		LNEU1250..	SE-40080TR	LNEU1250..	SE-40080TR				
			.414 (10.52mm)		LNEU1255...	SE-40090TR	LNEU1255...	SE-40090TR				
	MSTB ○○○○AN500-○T	SE-40090TR	.500 (12.7mm)	-	LNEU1255...	SE-40090TR	LNEU1255...	SE-40090TR	LNEU1255...	SE-40090TR		
			.520 (13.21mm)		LNEU1260...	SE-40100TR	LNEU1260...	SE-40100TR				
			.539 (13.69mm)		LNEU1240..	SE-40055TR	LNEU1240..	SE-40055TR				

For clamp screw, above listed "Standard attachment parts" are attached. In case of necessity of another size of clamp screw by changing slotting width, please purchase separately.

Slot width (Edge width) adjustment

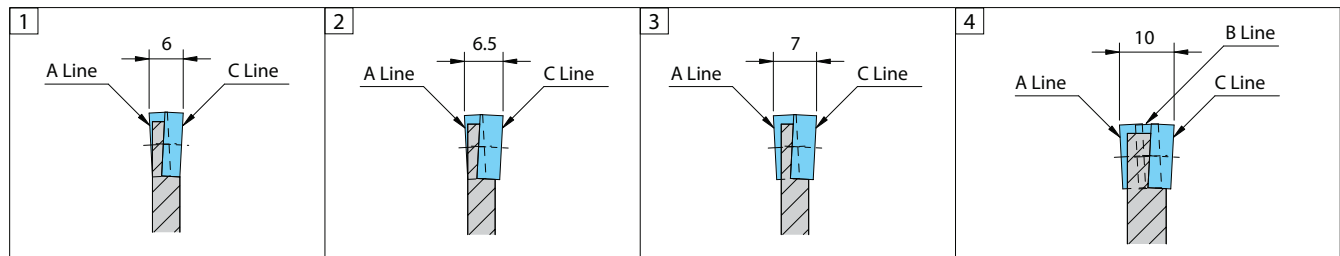

The slot width (Edge width) of MSTB slot mills is adjustable by a maximum of 1 mm with the combination of inserts.

1. In the case of MSTB○○○AN0607-○T the width (W) is 6mm by installing LNEU1235 on both A line and C line.
2. By replacing C line only with LNEU1240 the width (W) is 6.5 mm.
3. By replacing A line and C line with LNEU1240 the width (W) is 7 mm.
4. If the slotting width (Edge width) is 10 mm, the B line (Middle edge) is necessary.

* Caution

1. There is no description such as "A line", "B line", and "C line" on the actual slot mill. These are only for explanation of the combination of insert.
2. Use proper clamp screws for applicable inserts on the basis of the above chart.
3. Please do not use any slot mills, that have a difference of width of more than 1 mm.

Bottom cutting shape of MSTB slot mill
Slot bottom shape will be (Fig. 1) convex shape.

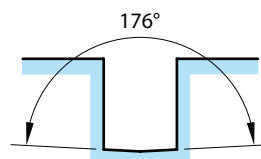
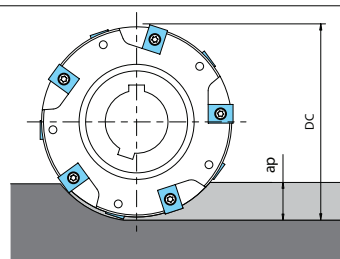

Fig. 1 Convex bottom shape

Recommended cutting conditions

Workpiece material		Hardness (HB)	Recommended insert grades (Vc: m/min)		fz (mm/t)		Remarks
			PVD Coated carbide		Insert thickness (mm)		
			PR0725		3.5~4.0	4.5~6.0	
Low carbon steel	C10 ~ C25	125	170~210		0.07~0.20	0.10~0.22	Dry
Carbon steel	C30 ~ C60 (Annealed)	190	100~140		0.07~0.20	0.10~0.22	
	C30 ~ C60 (Heat treated)	250	90~120		0.07~0.20	0.10~0.22	
Alloy steel	CrMo, Cr (Annealed)	180	90~120		0.07~0.20	0.10~0.22	
	CrMo, Cr (Heat treated)	275	80~110		0.05~0.18	0.08~0.20	
High carbon alloy	X153CrMoV12, X40CrMoV51, etc.	280	70~ 90		0.05~0.18	0.08~0.20	Coolant
Stainless steel	Austenitic related X5CrNi18 10, X5CrNiMo17 12 2, CrNi2520, etc.	220	110~140		0.05~0.18	0.08~0.20	
	Martensitic related X10Cr13, X6Cr17 etc.	300	100~120		0.05~0.18	0.08~0.20	
Heat-resistant alloys	Ni-base heat-resistant alloys	350	15~ 30		0.05~0.18	0.08~0.20	
Titanium alloys	Ti-6Al-4V, etc.	270	20~50		0.05~0.18	0.08~0.20	
Gray cast iron	GG25 ~ GG35	260	110~130		0.07~0.22	0.10~0.25	Dry
Nodular cast iron	GGG40 ~ GGG50	160	80~100		0.07~0.22	0.10~0.25	
	GGG60 ~ GGG80	250	70~ 90		0.07~0.22	0.10~0.25	

Note: 1. Use down-cut machining.
 2. If a_p is 1/10 or under of cutter dia.(DC), it is possible to increase feed per tooth (fz) by 40%.



Identification system toolholder MSTC

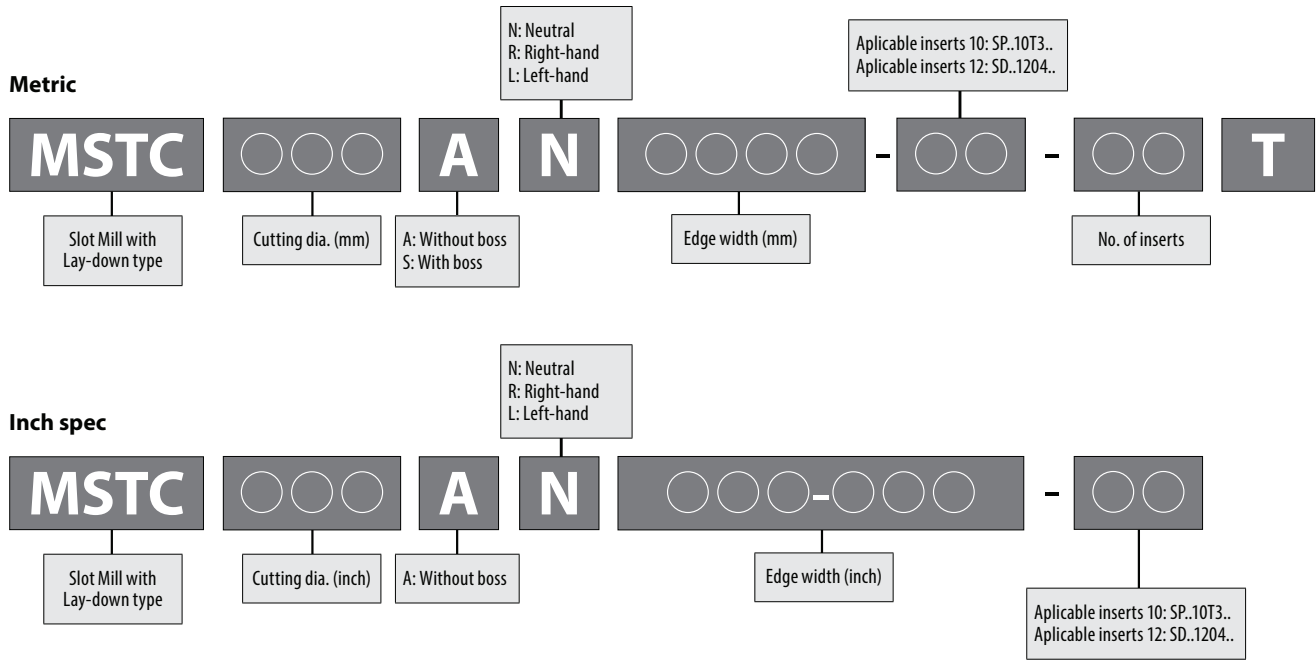

Cutting direction of MSTC slot mill

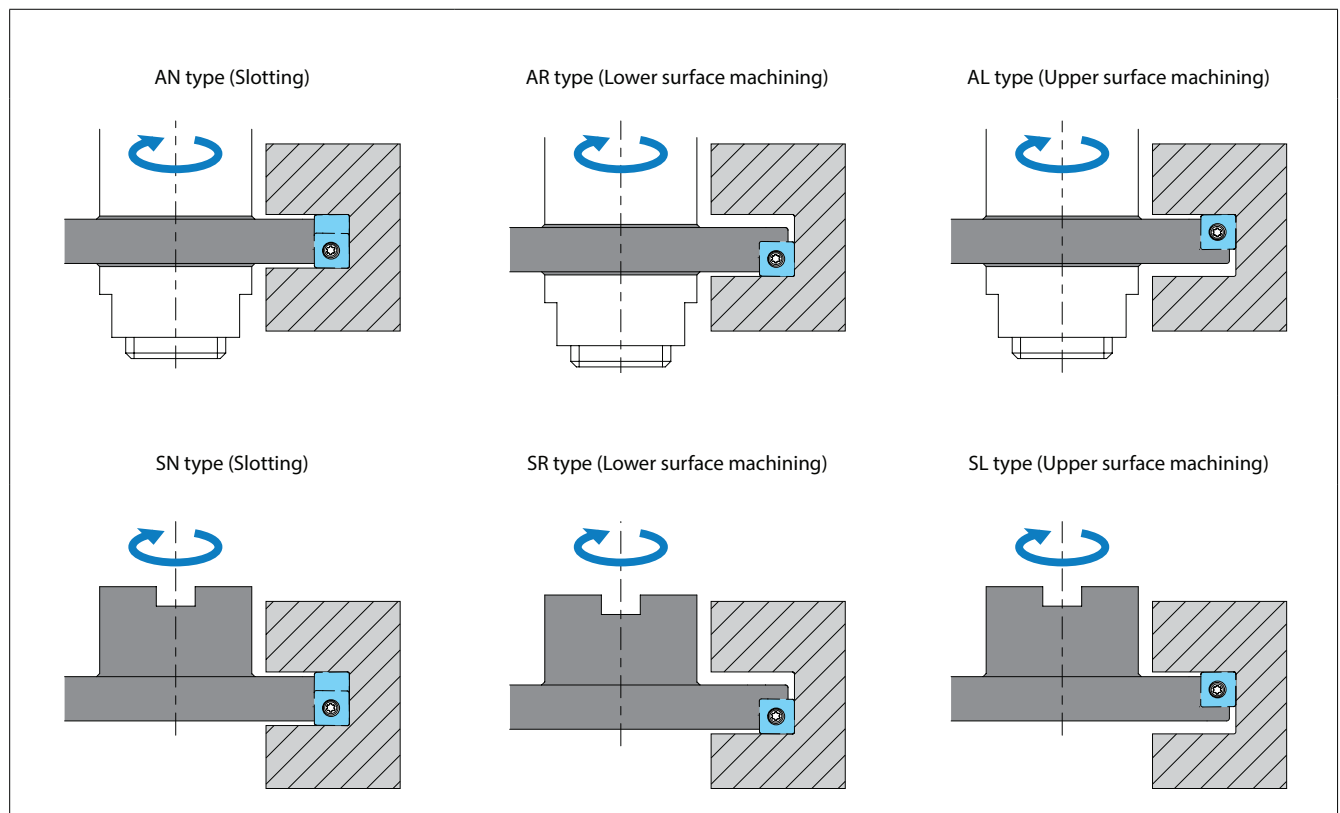

MSTC (Without Boss)

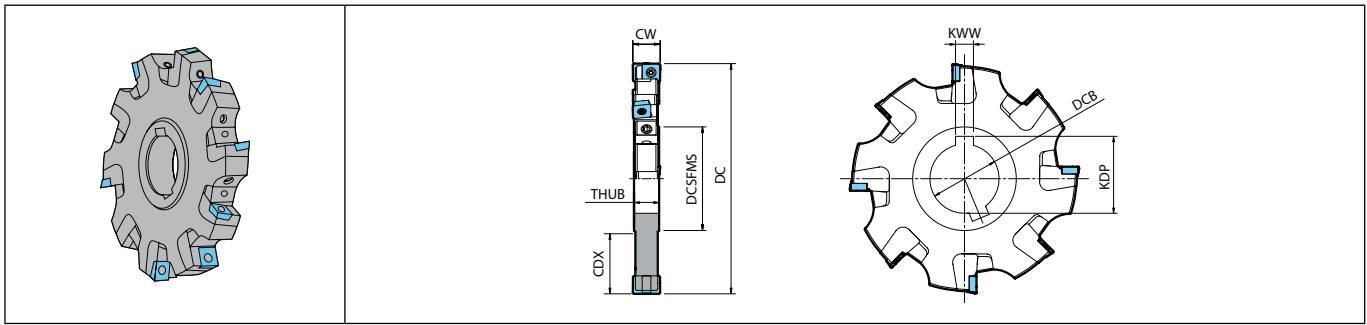

In order to be used in combination with two or more mills, this slot mill has 2 key slots.

Toolholder dimensions (Without Boss, Metric)

Description	Availability		Edge line	Dimension (mm)										Coolant hole	Max. revolution (min ⁻¹)	Weight (kg)	Applicable inserts M236 M237	
	N	Inserts		DC	DCSFMS	DCB	KDP	KWW	CDX	THUB	CW min.	CW max.						
MSTC 100AN1416-10-3T 125AN1416-10-4T 160AN1416-10-5T	●	6	3	100	46.8	32	34.8	8	25.9							17250	0.5	SPCT10T3... SPET10T3...
	●	8	4	125	54.8	40	43.5	10	34.4	13.9	14	16	No		15450	0.8		
	●	10	5	160					51.9						13650	1.5		
MSTC 125AN1618-10-4T 160AN1618-10-5T	●	8	4	125	54.8	40	43.5	10	34.4	15.9	16	18	No		15450	1	SPCT10T3... SPET10T3...	
	●	10	5	160					51.9					13650	1.8			
	●	10	5	160					51.9					13650	1.8			
MSTC 125AN1820-12-4T 160AN1820-12-5T	●	8	4	125	54.8	40	43.5	10	34	18.2	18	20.6	No		10350	1	SDCT1204... SDET1204...	
	●	10	5	160					51.5					9150	1.8			
	●	10	5	160					51.5					9150	1.8			
MSTC 125AN2123-12-4T 160AN2123-12-5T	●	8	4	125	54.8	40	43.5	10	34	20.8	20.6	23.3	No		10350	1.2	SDCT1204... SDET1204...	
	●	10	5	160					51.5					9150	2.1			
	●	10	5	160					51.5					9150	2.1			

Toolholder dimensions (Without Boss, Inch spec)

Description	Availability		Edge line	Dimension (in, (mm))										Coolant hole	Max. revolution (min ⁻¹)	Weight (kg)	Applicable inserts M236 M237	
	N	Inserts		DC	DCSFMS	DCB	KDP	KWW	CDX	THUB	CW min.	CW max.						
MSTC 400AN551-630-10 500AN551-630-10 600AN551-630-10	□	6	3	4 (101.6)	1.88 (47.75)	1.25 (31.75)	1.386 (35.2)	0.312 (7.92)	1.03 (26.1)							17100	0.6	SPCT10T3... SPET10T3...
	□	8	4	5 (127)	2.25 (57.15)	1.5 (38.1)	1.665 (42.3)	0.375 (9.52)	1.345 (34.1)	0.545 (13.84)	0.551 (14)	0.63 (16)	No		15300	0.9		
	□	10	5	6 (152.4)					1.845 (46.8)						14000	1.4		
MSTC 500AN630-709-10 600AN630-709-10	□	8	4	5 (127)	2.25 (57.15)	1.5 (38.1)	1.665 (42.3)	0.375 (9.52)	1.345 (34.1)	0.624 (15.85)	0.63 (16)	0.709 (18)	No		15300	1.1	SPCT10T3... SPET10T3...	
	□	10	5	6 (152.4)					1.845 (46.8)					14000	1.6			
	□	10	5	6 (152.4)					1.845 (46.8)					14000	1.6			
MSTC 500AN709-813-12 600AN709-813-12	□	8	4	5 (127)	2.25 (57.15)	1.5 (38.1)	1.665 (42.3)	0.375 (9.52)	1.331 (33.8)	0.716 (18.2)	0.709 (18)	0.813 (20.6)	No		10300	1.1	SDCT1204... SDET1204...	
	□	10	5	6 (152.4)					1.831 (46.5)					9400	1.7			
	□	10	5	6 (152.4)					1.831 (46.5)					9400	1.7			
MSTC 500AN813-917-12 600AN813-917-12	□	8	4	5 (127)	2.25 (57.15)	1.5 (38.1)	1.665 (42.3)	0.375 (9.52)	1.331 (33.8)	0.82 (20.8)	0.813 (20.6)	0.917 (23.2)	No		10300	1.3	SDCT1204... SDET1204...	
	□	10	5	6 (152.4)					1.831 (46.5)					9400	2			
	□	10	5	6 (152.4)					1.831 (46.5)					9400	2			

Spare parts ● M234

Slot width (Edge width) adjustment ● M239 - M241

● : Standard item R : Right-hand only L : Left-hand only □ : Check availability



Milling

MSTC (With Boss)

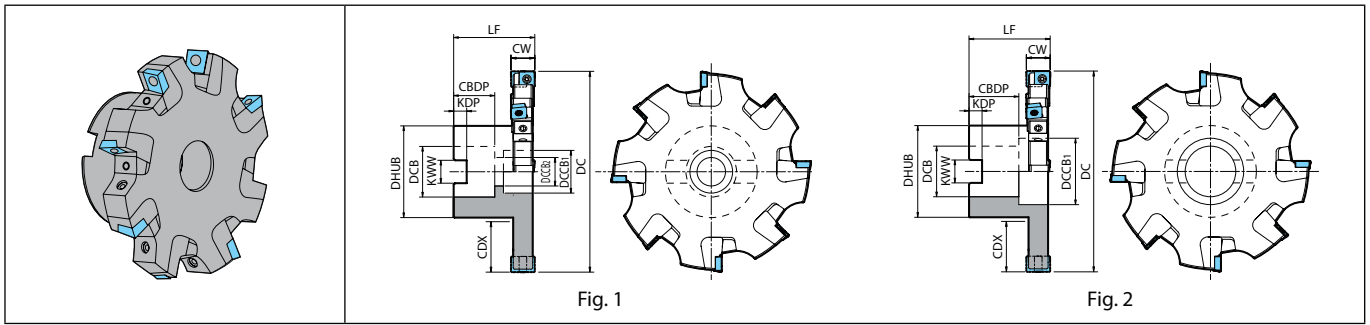

Toolholder dimensions (With Boss, Metric)

Description	Availability		Edge line	Dimension (mm)													Coolant hole	Max. revolution (min ⁻¹)	Weight (kg)	Fig.	Applicable inserts M236 M237		
	N	Inserts		DC	DCB	DCCB ₁	DCCB ₂	LF (min.)	CDBP	KDP	KWW	CDX	DHUB	CW min.	CW max.	Max. revolution (min ⁻¹)						Weight (kg)	Fig.
MSTC 100SN1416-10-3T	●	6	3	100	27	20	14		24	7	12.4	24.4	48			No	17250	1	1	SPCT10T3... SPET10T3...			
MSTC 125SN1416-10-4T	●	8	4	125	32	27	18	50.8	26	8	14.4	31.9	58	14	16	No	15450	1.6	1				
MSTC 160SN1416-10-5T	●	10	5	160	40	56	-		30	9	16.4	43.4	70			No	13650	2	2				
MSTC 125SN1618-10-4T	●	8	4	125	32	27	18	50.8	26	8	14.4	31.9	58	16	18	No	15450	1.7	1	SPCT10T3... SPET10T3...			
MSTC 160SN1618-10-5T	●	10	5	160	40	56	-		30	9	16.4	43.4	70			No	13650	2.3	2				
MSTC 125SN1820-12-4T	●	8	4	125	32	27	18	51	26	8	14.4	31.9	58	18	20.6	No	10350	1.6	1	SDCT1204... SDET1204...			
MSTC 160SN1820-12-5T	●	10	5	160	40	56	-		30	9	16.4	43.4	70			No	9150	2.3	2				
MSTC 125SN2123-12-4T	●	8	4	125	32	27	18	51	26	8	14.4	31.9	58	20.6	23.3	No	10350	1.7	1	SDCT1204... SDET1204...			
MSTC 160SN2123-12-5T	●	10	5	160	40	56	-		30	9	16.4	43.4	70			No	9150	2.6	2				

LF (min.) dimension shows in case of minimum of edge width (CW).

Spare parts **M234**

Slot width (Edge width) adjustment **M239 - M241**

M



Milling

- Cutting edge angle 45°~70°
- Cutting edge angle 75°
- Cutting edge angle 88°/90°
- Cutter for Finishing
- High Feed Cutter
- Multi-Function
- Slot Mill
- Ball-nose Radius
- Others

● : Standard item R : Right-hand only L : Left-hand only □ : Check availability

M228

Applicable insert installation method

When installing handed inserts, it is necessary to equip same number of right-hand and left-hand inserts as shown in "No. of edge lines" respectively. Please Install as show in the figure below.

MSTC...AN... (Without boss)

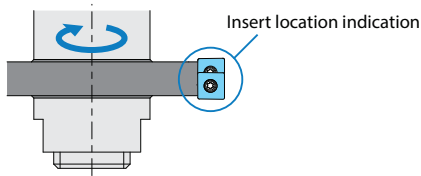

MSTC...SN... (With boss)

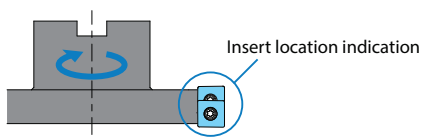

Toolholder description	Insert location indication	Applicable inserts M236, M237	
		Handed	Neutral
MSTC...AN...10.. MSTC...SN...10..		SP..10T3...L...	SP..10T3...N...
		SP..10T3...R...	
MSTC...AN...12.. MSTC...SN...12..		SD..1204...L...	SD..1204...N...
		SD..1204...R...	

Recommended cutting conditions M238

MSTC (Without Boss, Right-hand)

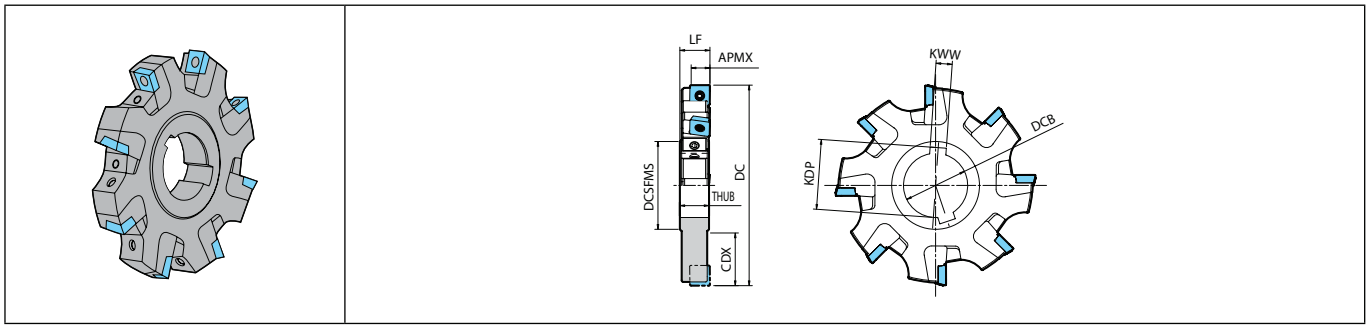

Right-hand shown | In order to be used in combination with two or more mills, this slot mill has 2 key slots.

Toolholder dimensions (Without Boss, Right-hand, Metric)

Description	Availability		Dimension (mm)										Coolant hole	Max. revolution (min ⁻¹)	Weight (kg)	Applicable inserts M236 M237	
	R	Inserts	DC	DCSFMS	DCB	LF min.	LF max.	KDP	KWW	APMX	CDX	THUB					
MSTC 100AR1416-10-6T	●	6	100	46.8	32			34.8	8		25.9			No	17250	0.5	SPCT10T3... SPET10T3...
MSTC 125AR1416-10-8T	●	8	125	54.8	40	13.9	14.9	43.5	10	9.1	34.4	13.9	No	15450	0.8		
MSTC 160AR1416-10-10T	●	10	160											13650	1.5		
MSTC 125AR1618-10-8T	●	8	125	54.8	40	15.9	16.9	43.5	10	9.1	34.4	15.9	No	15450	1	SPCT10T3... SPET10T3...	
MSTC 160AR1618-10-10T	●	10	160											13650	1.8		
MSTC 125AR1820-12-8T	●	8	125	54.8	40	18.1	19.4	43.5	10	11.7	34	18.2	No	10350	1	SDCT1204... SDET1204...	
MSTC 160AR1820-12-10T	●	10	160											9150	1.8		
MSTC 125AR2123-12-8T	●	8	125	54.8	40	20.7	22	43.5	10	11.7	34	20.8	No	10350	1.2	SDCT1204... SDET1204...	
MSTC 160AR2123-12-10T	●	10	160											9150	2.1		



Milling

Toolholder dimensions (Without Boss, Right-hand, Inch spec)

Description	Availability		Dimension (in , mm)										Coolant hole	Max. revolution (min ⁻¹)	Weight (kg)	Applicable inserts M236 M237	
	R	Inserts	DC	DCSFMS	DCB	LF min.	LF max.	KDP	KWW	APMX	CDX	THUB					
MSTC 400AR551-630-10	●	6	4 (101.6)	1.88 (47.75)	1.25 (31.75)			1.386 (35.2)	0.312 (7.92)		1.03 (26.1)			No	17100	0.6	SPCT10T3... SPET10T3...
MSTC 500AR551-630-10	●	8	5 (127)	2.25 (57.15)	1.5 (38.1)	0.548 (13.9)	0.588 (14.9)	1.665 (42.3)	0.375 (9.52)	0.359 (9.1)	1.345 (34.1)	0.545 (13.84)	No	15300	0.9		
MSTC 600AR551-630-10	●	10	6 (152.4)											14000	1.4		
MSTC 500AR630-709-10	●	8	5 (127)	2.25 (57.15)	1.5 (38.1)	0.627 (15.9)	0.667 (16.9)	1.665 (42.3)	0.375 (9.52)	0.359 (9.1)	1.345 (34.1)	0.624 (15.85)	No	15300	1.1	SPCT10T3... SPET10T3...	
MSTC 600AR630-709-10	●	10	6 (152.4)											14000	1.6		
MSTC 500AR709-813-12	●	8	5 (127)	2.25 (57.15)	1.5 (38.1)	0.712 (18.1)	0.764 (19.4)	1.665 (42.3)	0.375 (9.52)	0.461 (11.7)	1.331 (33.8)	0.716 (18.2)	No	10300	1.1	SDCT1204... SDET1204...	
MSTC 600AR709-813-12	●	10	6 (152.4)											9400	1.7		
MSTC 500AR813-917-12	●	8	5 (127)	2.25 (57.15)	1.5 (38.1)	0.816 (20.7)	0.868 (22)	1.665 (42.3)	0.375 (9.52)	0.461 (11.7)	1.331 (33.8)	0.82 (20.8)	No	10300	1.3	SDCT1204... SDET1204...	
MSTC 600AR813-917-12	●	10	6 (152.4)											9400	2		

- Cutting edge angle 45°~70°
- Cutting edge angle 75°
- Cutting edge angle 88°/90°
- Cutter for Finishing
- High Feed Cutter
- Multi-Function
- Slot Mill
- Ball-nose Radius
- Others

● : Standard item R : Right-hand only L : Left-hand only □ : Check availability

M230

MSTC (With Boss, Right-hand)

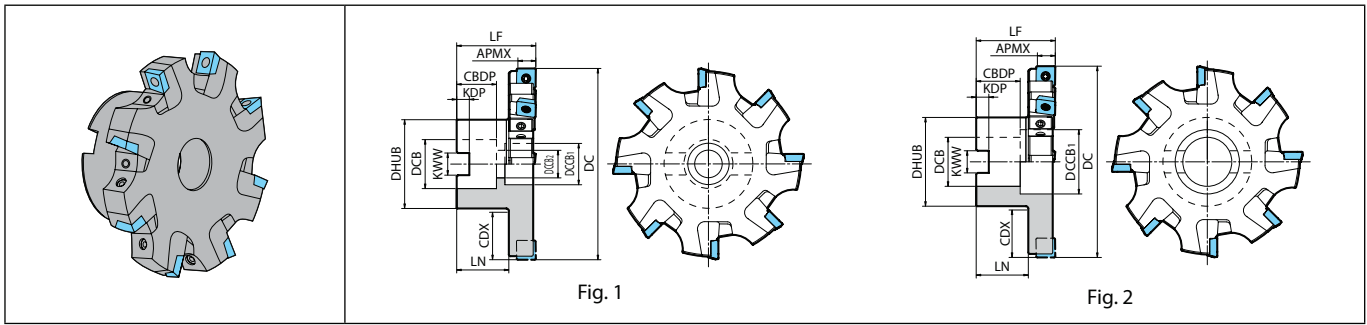

Right-hand shown

Toolholder dimensions (With Boss, Right-hand, Metric)

Description	Availability	Inserts	Dimension (mm)														Coolant hole	Max. revolution (min ⁻¹)	Weight (kg)	Fig.	Applicable inserts ● M236 ● M237
			R	DC	DCB	DCB ₁	DCB ₂	LF min.	LF max.	LN	CBDP	KDP	KWW	APMX	CDX	DHUB					
MSTC 100SR1416-10-6T	●	6	100	27	20	14				24	7	12.4		24.4	48		17250	1	1	SPCT10T3... SPET10T3...	
MSTC 125SR1416-10-8T	●	8	125	32	27	18	50.8	51.8	37.7	26	8	14.4	9.1	31.9	58	No	15450	1.6	1		
MSTC 160SR1416-10-10T	●	10	160	40	56	-				30	9	16.4		43.4	70		13650	2	2		
MSTC 125SR1618-10-8T	●	8	125	32	27	18				26	8	14.4	9.1	31.9	58	No	15450	1.7	1	SPCT10T3... SPET10T3...	
MSTC 160SR1618-10-10T	●	10	160	40	56	-	50.8	51.8	35.7	30	9	16.4		43.4	70		13650	2.3	2		
MSTC 125SR1820-12-8T	●	8	125	32	27	18				26	8	14.4		31.9	58	No	10350	1.6	1	SDCT1204... SDET1204...	
MSTC 160SR1820-12-10T	●	10	160	40	56	-	51	52.3	34	30	9	16.4	11.7	43.4	70		9150	2.3	2		
MSTC 125SR2123-12-8T	●	8	125	32	27	18				26	8	14.4		31.9	58	No	10350	1.7	1	SDCT1204... SDET1204...	
MSTC 160SR2123-12-10T	●	10	160	40	56	-	51	52.3	31.4	30	9	16.4	11.7	43.4	70		9150	2.6	2		

Applicable inserts

Toolholder description	Applicable inserts ● M236, M237	
	Handed	Neutral
MSTC...AR...10.. MSTC...SR...10..	SP..10T3...R...	SP..10T3...N...
MSTC...AR...12.. MSTC...SR...12..	SD..1204...R...	SD..1204...N...

Recommended cutting conditions ● M238

Spare parts ● M235

Slot width (Edge width) adjustment ● M239 - M241

● : Standard item R : Right-hand only L : Left-hand only □ : Check availability



Milling

MSTC (Without Boss, Left-hand)

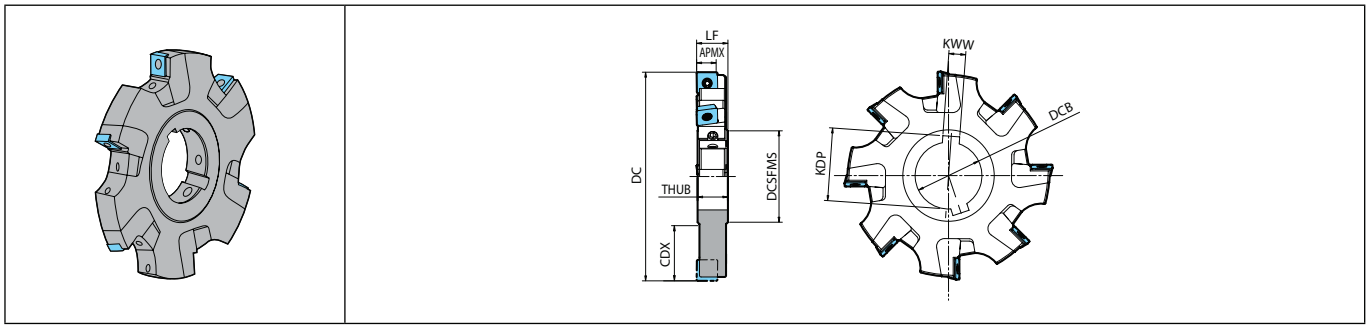

Left-hand shown | In order to be used in combination with two or more mills, this slot mill has 2 key slots.

Toolholder dimensions (Without Boss, Left-hand, Metric)

Description	Availability		Dimension (mm)										Coolant hole	Max. revolution (min ⁻¹)	Weight (kg)	Applicable inserts M236 M237
	L	Inserts	DC	DCSFMS	DCB	LF min.	LF max.	KDP	KWW	APMX	CDX	THUB				
MSTC 100AL1416-10-6T	●	6	100	46.8	32			34.8	8		25.9		No	17250	0.5	SPCT10T3... SPET10T3...
MSTC 125AL1416-10-8T	●	8	125	54.8	40	13.9	14.9	43.5	10	9.1	34.4	13.9	No	15450	0.8	
MSTC 160AL1416-10-10T	●	10	160													
MSTC 125AL1618-10-8T	●	8	125	54.8	40	15.9	16.9	43.5	10	9.1	34.4	15.9	No	15450	1	SPCT10T3... SPET10T3...
MSTC 160AL1618-10-10T	●	10	160													
MSTC 125AL1820-12-8T	●	8	125	54.8	40	18.1	19.4	43.5	10	11.7	34	18.2	No	10350	1	SDCT1204... SDET1204...
MSTC 160AL1820-12-10T	●	10	160													
MSTC 125AL2123-12-8T	●	8	125	54.8	40	20.7	22	43.5	10	11.7	34	20.8	No	10350	1.2	SDCT1204... SDET1204...
MSTC 160AL2123-12-10T	●	10	160													



Milling

Toolholder dimensions (Without Boss, Left-hand, Inch spec)

Description	Availability		Dimension (in , mm)										Coolant hole	Max. revolution (min ⁻¹)	Weight (kg)	Applicable inserts M236 M237
	L	Inserts	DC	DCSFMS	DCB	LF min.	LF max.	KDP	KWW	APMX	CDX	THUB				
MSTC 400AL551-630-10	●	6	4 (101.6)	1.88 (47.75)	1.25 (31.75)			1.386 (35.2)	0.312 (7.92)		1.03 (26.1)		No	17100	0.6	SPCT10T3... SPET10T3...
MSTC 500AL551-630-10	●	8	5 (127)	2.25 (57.15)	1.5 (38.1)	0.548 (13.9)	0.588 (14.9)	1.665 (42.3)	0.375 (9.52)	0.359 (9.1)	1.345 (34.1)	0.545 (13.84)	No	15300	0.9	
MSTC 600AL551-630-10	●	10	6 (152.4)													
MSTC 500AL630-709-10	●	8	5 (127)	2.25 (57.15)	1.5 (38.1)	0.627 (15.9)	0.667 (16.9)	1.665 (42.3)	0.375 (9.52)	0.359 (9.1)	1.345 (34.1)	0.624 (15.85)	No	15300	1.1	SPCT10T3... SPET10T3...
MSTC 600AL630-709-10	●	10	6 (152.4)													
MSTC 500AL709-813-12	●	8	5 (127)	2.25 (57.15)	1.5 (38.1)	0.712 (18.1)	0.764 (19.4)	1.665 (42.3)	0.375 (9.52)	0.461 (11.7)	1.331 (33.8)	0.716 (18.2)	No	10300	1.1	SDCT1204... SDET1204...
MSTC 600AL709-813-12	●	10	6 (152.4)													
MSTC 500AL813-917-12	●	8	5 (127)	2.25 (57.15)	1.5 (38.1)	0.816 (20.7)	0.868 (22)	1.665 (42.3)	0.375 (9.52)	0.461 (11.7)	1.331 (33.8)	0.820 (20.8)	No	10300	1.3	SDCT1204... SDET1204...
MSTC 600AL813-917-12	●	10	6 (152.4)													

- Cutting edge angle 45°~70°
- Cutting edge angle 75°
- Cutting edge angle 88°/90°
- Cutter for Finishing
- High Feed Cutter
- Multi-Function
- Slot Mill
- Ball-nose Radius
- Others

● : Standard item R : Right-hand only L : Left-hand only □ : Check availability

M232

MSTC (With Boss, Left-hand)

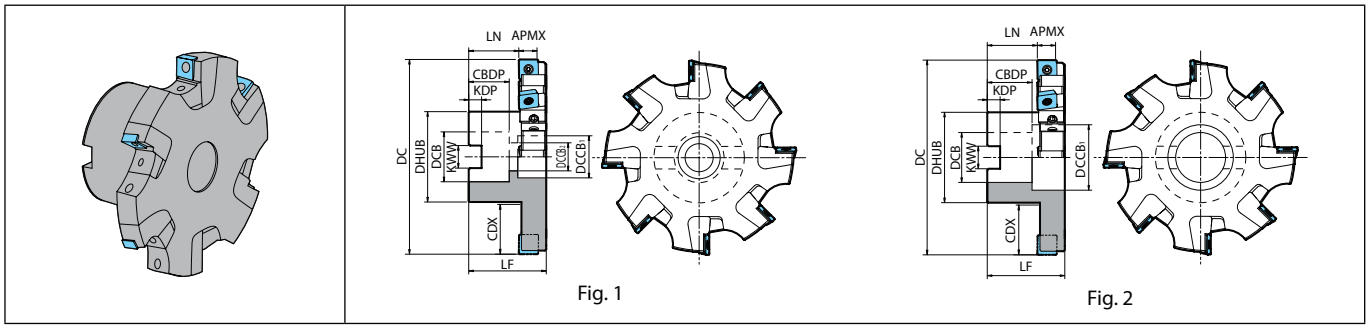

Left-hand shown

Toolholder dimensions (With Boss, Left-hand, Metric)

Description	Availability	Inserts	Dimension (mm)														Coolant hole	Max. revolution (min ⁻¹)	Weight (kg)	Fig.	Applicable inserts M236 M237
			L	DC	DCB	DCCB ₁	DCCB ₂	LF	CBDP	KDP	KWW	APMX	CDX	DHUB	LN min.	LN max.					
MSTC 100SL1416-10-6T 125SL1416-10-8T 160SL1416-10-10T	●	6	100	27	20	14		24	7	12.4	24.4	48					17250	1	1	SPCT10T3... SPET10T3...	
	●	8	125	32	27	18	50	26	8	14.4	9.1	31.9	58	35.8	36.8	No	15450	1.6	1		
	●	10	160	40	56	-		30	9	16.4		43.4	70				13650	2	2		
MSTC 125SL1618-10-8T 160SL1618-10-10T	●	8	125	32	27	18	50	26	8	14.4	9.1	31.9	58	33.8	34.8	No	15450	1.7	1	SPCT10T3... SPET10T3...	
	●	10	160	40	56	-		30	9	16.4		43.4	70				13650	2.3	2		
MSTC 125SL1820-12-8T 160SL1820-12-10T	●	8	125	32	27	18	50	26	8	14.4	11.7	31.9	58	31.7	33	No	10350	1.6	1	SDCT1204... SDET1204...	
	●	10	160	40	56	-		30	9	16.4		43.4	70				9150	2.3	2		
MSTC 125SL2123-12-8T 160SL2123-12-10T	●	8	125	32	27	18	50	26	8	14.4	11.7	31.9	58	29.1	30.4	No	10350	1.7	1	SDCT1204... SDET1204...	
	●	10	160	40	56	-		30	9	16.4		43.4	70				9150	2.6	2		

Coat Anti-seize Compound thinly on portion of taper and thread when insert is fixed.

Applicable inserts

Toolholder description	Applicable inserts M236, M237	
	Handed	Neutral
MSTC...AL...10.. MSTC...SL...10..	SP..10T3...L...	SP..10T3...N...
MSTC...AL...12.. MSTC...SL...12..	SD..1204...L...	SD..1204...N...

Recommended cutting conditions M238

Spare parts M235

Slot width (Edge width) adjustment M239 - M241

● : Standard item R : Right-hand only L : Left-hand only □ : Check availability





Milling

Spare parts (MSTC) (common to Metric / Inch spec)

Description		Spare parts														
		Cartridge		Wedge	Wedge screw	Cam pin	Clamp screw	Wrench			Anti-seize compound	Mounting bolt				
		Right-hand	Left-hand					for wedge screw	for cam pin	for clamp screw						
Without boss	Metric	MSTC 100AN1416-10-3T	C90SP1416-10R	C90SP1416-10L	WC-14	W6X18	AP-1416	SE-3070TRP	TH-3L	LW-2.5	DTP-9	P-37	-			
		MSTC 125AN1416-10-4T				W6X20										
		MSTC 160AN1416-10-5T			W6X20											
		MSTC 125AN1618-10-4T	C90SP1618-10R	C90SP1618-10L	WC-16	W6X20				AP-1820	SB-3590TRP			TH-3L	LW-3	DTP-15
		MSTC 160AN1618-10-5T				W6X20										
		MSTC 125AN1820-12-4T			C90SD1820-12R	C90SD1820-12L										
	MSTC 160AN1820-12-5T	W6X20														
	MSTC 125AN2123-12-4T	C90SD2023-12R	C90SD2023-12L	WC-20			W6X18	AP-1416	SE-3070TRP						TH-3L	LW-2.5
	MSTC 160AN2123-12-5T				W6X20											
	MSTC 400AN551-630-10			C90SP1416-10R	C90SP1416-10L	WC-14	W6X18			AP-1820	SB-3590TRP			TH-3L		
	MSTC 500AN551-630-10	W6X20														
	MSTC 600AN551-630-10	W6X20														
MSTC 500AN630-709-10	C90SP1618-10R	C90SP1618-10L	WC-16	W6X20	AP-1820	SB-3590TRP	TH-3L					LW-2.5	DTP-9			
MSTC 600AN630-709-10				W6X20												
MSTC 500AN709-813-12			C90SD1820-12R	C90SD1820-12L				WC-18	W6X20							
MSTC 600AN709-813-12	W6X20															
MSTC 500AN813-917-12	C90SD2023-12R	C90SD2023-12L						WC-20	W6X18	AP-1416	SE-3070TRP	TH-3L	LW-3	DTP-15		
MSTC 600AN813-917-12			W6X20													
MSTC 100SN1416-10-3T			C90SP1416-10R	C90SP1416-10L	WC-14	W6X20	AP-1416	SE-3070TRP	TH-3L						LW-2.5	DTP-9
MSTC 125SN1416-10-4T	W6X20	HH16X35														
MSTC 160SN1416-10-5T	W6X20	-														
MSTC 125SN1618-10-4T	C90SP1618-10R	C90SP1618-10L	WC-16	W6X20	AP-1820	SB-3590TRP							TH-3L	LW-3	DTP-15	P-37
MSTC 160SN1618-10-5T				W6X20						-						
MSTC 125SN1820-12-4T			C90SD1820-12R	C90SD1820-12L						WC-18	W6X20					
MSTC 160SN1820-12-5T	W6X20	HH16X35														
MSTC 125SN2123-12-4T	C90SD2023-12R	C90SD2023-12L					WC-20	W6X20								
MSTC 160SN2123-12-5T			W6X20	-												

 Coat anti-seize compound thinly on portion of taper and thread when insert is fixed.











Tightening torque

Wrench	TH-3L	DTP-9	DTP-15
			
Tightening torque (N·m)	5~6	1.5	4





Cutting edge angle 45°~70°
Cutting edge angle 75°
Cutting edge angle 88°/90°
Cutter for Finishing
High Feed Cutter
Multi-Function
Slot Mill
Ball-nose Radius
Others

Spare parts (MSTC) (common to Metric / Inch spec)

Description		Spare Parts																
		Cartridge		Wedge	Wedge Screw	Cam Pin	Clamp Screw	Wrench			Anti-seize Compound	Mounting bolt						
		Right-hand	Left-hand					for Wedge Screw	for Cam Pin	for Clamp Screw								
																		
Without Boss	Metric	MSTC 100AR1416-10-6T	C90SP1416-10R	-	WC-14	W6X18	AP-1416	SE-3070TRP	TH-3L	LW-2.5	DTP-9	P-37	-					
		MSTC 125AR1416-10-8T												W6X20				
		MSTC 160AR1416-10-10T			W6X20													
		MSTC 125AR1618-10-8T			W6X20													
		MSTC 160AR1618-10-10T	W6X20															
		MSTC 125AR1820-12-8T	C90SD1820-12R	WC-18	AP-1820	SB-3590TRP	LW-3	DTP-15										
		MSTC 160AR1820-12-10T		WC-20														
		MSTC 160AR2123-12-10T	C90SD2023-12R	WC-20														
	MSTC 100AL1416-10-6T	-	C90SP1416-10L	WC-14	W6X18	AP-1416	SE-3070TRP	TH-3L	LW-2.5	DTP-9								
	MSTC 125AL1416-10-8T				W6X20													
	MSTC 160AL1416-10-10T			W6X20														
	MSTC 125AL1618-10-8T			W6X20														
	MSTC 160AL1618-10-10T		W6X20															
	MSTC 125AL1820-12-8T		C90SD1820-12L	WC-18	AP-1820	SB-3590TRP	LW-3	DTP-15										
	MSTC 160AL1820-12-10T			WC-20														
	MSTC 125AL2123-12-8T		C90SD2023-12L	WC-20														
MSTC 160AL2123-12-10T																		
Inch spec	Metric	MSTC 400AR551-630-10	C90SP1416-10R	-	WC-14	W6X18	AP-1416	SE-3070TRP	TH-3L	LW-2.5	DTP-9							
		MSTC 500AR551-630-10				W6X20												
		MSTC 600AR551-630-10			W6X20													
		MSTC 500AR630-709-10			C90SP1618-10R	WC-16	AP-1820	SB-3590TRP		LW-3	DTP-15							
		MSTC 600AR630-709-10	WC-18															
		MSTC 500AR709-813-12	C90SD1820-12R	WC-18	AP-1820	SB-3590TRP	LW-3	DTP-15										
		MSTC 600AR709-813-12		WC-20														
		MSTC 500AR813-917-12	C90SD2023-12R	-	WC-20	W6X20	AP-1416	SE-3070TRP	TH-3L	LW-2.5	DTP-9							
	MSTC 600AR813-917-12	W6X20																
	MSTC 400AL551-630-10	-										C90SP1416-10L	WC-14	AP-1416	SE-3070TRP	TH-3L	LW-2.5	DTP-9
	MSTC 500AL551-630-10												W6X20					
	MSTC 600AL551-630-10		W6X20															
	MSTC 500AL630-709-10		C90SP1618-10L	WC-16	AP-1820	SB-3590TRP	LW-3	DTP-15										
	MSTC 600AL630-709-10	WC-18																
	MSTC 500AL709-813-12	C90SD1820-12L	WC-18	AP-1820	SB-3590TRP	LW-3	DTP-15											
	MSTC 600AL709-813-12		WC-20															
MSTC 500AL813-917-12	C90SD2023-12L	-	WC-20	W6X20	AP-1416	SE-3070TRP	TH-3L	LW-2.5	DTP-9									
MSTC 600AL813-917-12										W6X20								
With Boss	Metric	MSTC 100SR1416-10-6T	C90SP1416-10R	-	WC-14	W6X20	AP-1416	SE-3070TRP	TH-3L	LW-2.5	DTP-9	P-37	HH12X35					
		MSTC 125SR1416-10-8T											HH16X35					
		MSTC 160SR1416-10-10T			-													
		MSTC 125SR1618-10-8T			HH16X35													
		MSTC 160SR1618-10-10T	-															
		MSTC 125SR1820-12-8T	C90SP1618-10R	WC-16	AP-1820	SB-3590TRP	LW-3	DTP-15	HH16X35									
		MSTC 160SR1820-12-10T		WC-18					HH16X35									
		MSTC 125SR2123-12-8T	C90SD1820-12R	WC-18	AP-1820	SB-3590TRP	LW-3	DTP-15	HH16X35									
	MSTC 160SR2123-12-10T	WC-20		HH16X35														
	MSTC 100SL1416-10-6T	-	C90SP1416-10L	WC-14	W6X20	AP-1416	SE-3070TRP	TH-3L	LW-2.5	DTP-9	HH12X35							
	MSTC 125SL1416-10-8T										HH16X35							
	MSTC 160SL1416-10-10T			W6X20	HH16X35													
	MSTC 125SL1618-10-8T			C90SP1618-10L	WC-16	AP-1820	SB-3590TRP		LW-3	DTP-15	HH16X35							
	MSTC 160SL1618-10-10T		WC-18		HH16X35													
	MSTC 125SL1820-12-8T		C90SD1820-12L	WC-18	AP-1820	SB-3590TRP	LW-3	DTP-15	HH16X35									
	MSTC 160SL1820-12-10T			WC-20					HH16X35									
MSTC 125SL2123-12-8T	C90SD2023-12L		-	WC-20	W6X20	AP-1416	SB-3590TRP	TH-3L	LW-2.5	DTP-9	HH12X35							
MSTC 160SL2123-12-10T		HH16X35																

 Coat anti-seize compound thinly on portion of taper and thread when insert is fixed.

Tightening Torque

Wrench	TH-3L	DTP-9	DTP-15
			
Tightening Torque (N m)	5~6	1.5	4



Milling

SPCT/SPET

Insert		Description	No. of edges	Dimension (mm)					Carbide			Applicable toolholder M227~M235																																																																																																																				
				IC	S	D1	RE	BS	CVD CA0835	PVD PRO110 PRO725																																																																																																																						
Classification of usage ● : 1st Choice ○ : 2nd Choice																																																																																																																																
<table border="1"> <tr><td>Carbon steel / Alloy steel</td><td>●</td><td>●</td><td>●</td><td>●</td><td>●</td><td>●</td><td>●</td><td>●</td><td>●</td><td>●</td><td>●</td><td>P</td></tr> <tr><td>Mold and die steel</td><td>○</td><td>○</td><td>○</td><td>○</td><td>○</td><td>○</td><td>○</td><td>○</td><td>○</td><td>○</td><td>○</td><td>M</td></tr> <tr><td>Stainless steel</td><td>○</td><td>○</td><td>○</td><td>○</td><td>○</td><td>○</td><td>○</td><td>○</td><td>○</td><td>○</td><td>○</td><td>M</td></tr> <tr><td>Gray cast iron</td><td>○</td><td>○</td><td>○</td><td>○</td><td>○</td><td>○</td><td>○</td><td>○</td><td>○</td><td>○</td><td>○</td><td>K</td></tr> <tr><td>Nodular cast iron</td><td>○</td><td>○</td><td>○</td><td>○</td><td>○</td><td>○</td><td>○</td><td>○</td><td>○</td><td>○</td><td>○</td><td>K</td></tr> <tr><td>Non-ferrous metals</td><td>○</td><td>○</td><td>○</td><td>○</td><td>○</td><td>○</td><td>○</td><td>○</td><td>○</td><td>○</td><td>○</td><td>N</td></tr> <tr><td>Heat-resistant alloy</td><td>○</td><td>○</td><td>○</td><td>○</td><td>○</td><td>○</td><td>○</td><td>○</td><td>○</td><td>○</td><td>○</td><td>S</td></tr> <tr><td>Titanium alloy</td><td>○</td><td>○</td><td>○</td><td>○</td><td>○</td><td>○</td><td>○</td><td>○</td><td>○</td><td>○</td><td>○</td><td>S</td></tr> <tr><td>Hard materials</td><td>○</td><td>○</td><td>○</td><td>○</td><td>○</td><td>○</td><td>○</td><td>○</td><td>○</td><td>○</td><td>○</td><td>H</td></tr> </table>												Carbon steel / Alloy steel	●	●	●	●	●	●	●	●	●	●	●	P	Mold and die steel	○	○	○	○	○	○	○	○	○	○	○	M	Stainless steel	○	○	○	○	○	○	○	○	○	○	○	M	Gray cast iron	○	○	○	○	○	○	○	○	○	○	○	K	Nodular cast iron	○	○	○	○	○	○	○	○	○	○	○	K	Non-ferrous metals	○	○	○	○	○	○	○	○	○	○	○	N	Heat-resistant alloy	○	○	○	○	○	○	○	○	○	○	○	S	Titanium alloy	○	○	○	○	○	○	○	○	○	○	○	S	Hard materials	○	○	○	○	○	○	○	○	○	○	○	H
Carbon steel / Alloy steel	●	●	●	●	●	●	●	●	●	●	●	P																																																																																																																				
Mold and die steel	○	○	○	○	○	○	○	○	○	○	○	M																																																																																																																				
Stainless steel	○	○	○	○	○	○	○	○	○	○	○	M																																																																																																																				
Gray cast iron	○	○	○	○	○	○	○	○	○	○	○	K																																																																																																																				
Nodular cast iron	○	○	○	○	○	○	○	○	○	○	○	K																																																																																																																				
Non-ferrous metals	○	○	○	○	○	○	○	○	○	○	○	N																																																																																																																				
Heat-resistant alloy	○	○	○	○	○	○	○	○	○	○	○	S																																																																																																																				
Titanium alloy	○	○	○	○	○	○	○	○	○	○	○	S																																																																																																																				
Hard materials	○	○	○	○	○	○	○	○	○	○	○	H																																																																																																																				
		SPCT 10T316EN-SD	4	10	3.97	3.4	1.6	-	-	●	●	MSTC...-10-..																																																																																																																				
		SPCT 10T308ER-SD	4	10	3.97	3.4	0.8	2.5	●	●	●	MSTC...-10-..																																																																																																																				
		SPCT 10T308EL-SD					0.8	2.5	●																																																																																																																							
		SPCT 10T312ER-SD					1.2	1.8	●																																																																																																																							
		SPCT 10T312EL-SD					1.2	1.8	●																																																																																																																							
		SPCT 10T316FN-SE	4	10	3.97	3.4	1.6	-	●	●	●	MSTC...-10-..																																																																																																																				
		SPCT 10T308FR-SE	4	10	3.97	3.4	0.8	2.7	●	●	●	MSTC...-10-..																																																																																																																				
							0.8	2.7	●																																																																																																																							
							1.2	2.2	●																																																																																																																							
							1.2	2.2	●																																																																																																																							
		SPET 10T308ER-SB	4	10	3.97	3.4	0.8	2.7	●	●	●	MSTC...-10-..																																																																																																																				
		SPET 10T308EL-SB	4	10	3.97	3.4	0.8	2.7	●	●	●	MSTC...-10-..																																																																																																																				
		SPET 10T308SR-SB							●																																																																																																																							
		SPET 10T308SL-SB	●																																																																																																																													

Handed insert shows Right-hand

Recommended cutting conditions M238

Inserts identification system

Shape		Tolerance			Edge length	Corner-R (RE)		Hand of tool	
Symbol	Shape	Symbol	Corner height	Thickness	L.C Size	Symbol	Corner-R (RE)	Symbol	Hand of tool
S	Square	C	±0.013mm	±0.025mm	±0.025mm	16	1.6mm	N	Neutral
		E	±0.025mm			12	1.2mm	L	Left-hand
						08	0.8mm	R	Right-hand

S P C T 10 T3 08 E R - SD

Relief angle	
Symbol	Relief angle
D	15°
P	11°

Hole/Chipbreaker	
Symbol	Shape
T	

Thickness	
Symbol	Thickness
T3	3.97mm
04	4.76mm

Edge Preparation	
Symbol	Cutting edge spec.
E	Honed
F	Sharp edge
S	Chamfered + R-honed

Chipbreaker symbol	
Symbol	Rake angle
SB	5°
SD	15°
SE	20°

● : Standard item R : Right-hand only L : Left-hand only □ : Check availability



Cutting edge angle 45°~70°
Cutting edge angle 75°
Cutting edge angle 88°~90°

Cutter for Finishing

High Feed Cutter

Multi-Function

Slot Mill

Ball-nose Radius

Others

SDCT/SDET

Insert		Description	No. of edges	Dimension (mm)					Carbide			Applicable toolholder M227~M235	
				IC	S	D1	RE	BS	CVD				
									CA0835	PRO110	PRO725		
Classification of usage ● : 1st Choice ○ : 2nd Choice													
		SDCT 120416EN-SD	4	12.7	4.76	4.4	1.6	-				●	MSTC...-12-..
		SDCT 120408ER-SD	4	12.7	4.76	4.4	0.8	2.5				●	MSTC...-12-..
		SDCT 120408EL-SD					0.8	2.5			●		
		SDCT 120412ER-SD					1.2	1.8			●		
		SDCT 120412EL-SD					1.2	1.8			●		
		SDCT 120416FN-SE	4	12.7	4.76	4.4	1.6	-				●	MSTC...-12-..
		SDCT 120408FR-SE	4	12.7	4.76	4.4	0.8	2.7				●	MSTC...-12-..
		SDCT 120408FL-SE					0.8	2.7			●		
		SDCT 120412FR-SE					1.2	1.9			●		
		SDCT 120412FL-SE					1.2	1.9			●		
		SDET 120408ER-SB	4	12.7	4.76	4.4	0.8	2.5	●	●		●	MSTC...-12-..
		SDET 120408EL-SB					0.8	2.5	●	●	●		
		SDET 120412ER-SB					1.2	1.8	●	●	●		
		SDET 120412EL-SB					1.2	1.8	●	●	●		
		SDET 120416SN-SB	4	12.7	4.76	4.4	1.6	-	●			●	MSTC...-12-..
		SDET 120408SR-SB	4	12.7	4.76	4.4	0.8	2.5	●	●		●	MSTC...-12-..
		SDET 120408SL-SB					0.8	2.5	●	●	●		

Handed insert shows Right-hand

Recommended cutting conditions M238



Milling

● : Standard item R : Right-hand only L : Left-hand only □ : Check availability

Recommended cutting conditions

Workpiece material		Hardness (HB)	Recommended insert grades (Vc: m/min)			fz (mm/t)				Remarks
			CVD Coated carbide	PVD Coated carbide		Chipbreaker				
				CA0835	PR0725	PR0110	EN-SD ER-SD EL-SD	ER-SB EL-SB	SN-SB SR-SB SL-SB	
Low carbon steel	C10 ~ C25	125	250~310	170~210	-	0.07~0.20	0.10~0.22	0.15~0.3	-	Dry
Carbon steel	C30 ~ C60 (Annealed)	190	160~190	100~140	-	0.07~0.20	0.10~0.22	0.15~0.3	-	
	C30 ~ C60 (Heat treated)	250	140~180	90~120	-	0.07~0.20	0.10~0.22	0.15~0.3	-	
Alloy steel	CrMo, Cr (Annealed)	180	140~180	90~120	-	0.07~0.20	0.10~0.22	0.15~0.3	-	
	CrMo, Cr (Heat treated)	275	120~160	80~110	-	0.05~0.18	0.08~0.20	0.12~0.25	-	
High carbon alloy	X153CrMoV12, X40CrMoV51, etc.	280	110~130	70~90	-	0.05~0.18	0.08~0.20	0.12~0.25	-	
Stainless steel	Austenitic related X5CrNi18 10, X5CrNiMo17 12 2, CrNi2520, etc.	220	160~200	110~140	-	0.05~0.18	0.08~0.20	0.12~0.25	-	Coolant
	Martensitic related X10Cr13, X6Cr17 etc.	300	150~180	100~120	-	0.05~0.18	0.08~0.20	0.12~0.25	-	
Heat-resistant alloys	Ni-base heat-resistant alloys	350	-	15~30	-	0.05~0.18	0.08~0.20	0.12~0.25	-	
Titanium alloys	Ti-6Al-4V, etc.	270	-	20~50	-	0.05~0.18	0.08~0.20	0.12~0.25	-	
Gray cast iron	GG25 ~ GG35	260	160~200	110~130	-	0.07~0.22	0.10~0.25	0.15~0.35	-	Dry
Nodular cast iron	GGG40 ~ GGG50	160	130~160	80~100	-	0.07~0.22	0.10~0.25	0.15~0.35	-	
	GGG60 ~ GGG80	250	110~140	70~90	-	0.07~0.22	0.10~0.25	0.15~0.35	-	
Non-ferrous metals	AlZnMgCu1.5 etc.	-	-	-	750~950	-	-	-	0.07~0.20	Coolant



- Cutting edge angle 45°~70°
- Cutting edge angle 75°
- Cutting edge angle 88°/90°
- Cutter for Finishing
- High Feed Cutter
- Multi-Function
- Slot Mill
- Ball-nose Radius
- Others

Note: 1. Use down-cut machining.
 2. If ap is 1/10 or under of cutter dia.(DC), it is possible to increase feed per tooth (fz) by 40%.

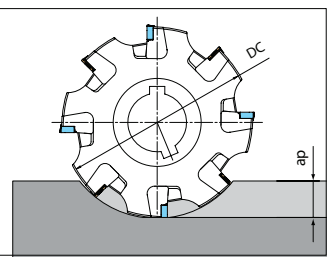

Slot width (Edge width) adjustment of MSTC slot mill

Slot width (Edge width) measurement and adjustment

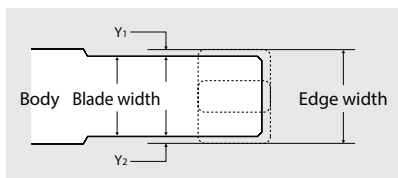
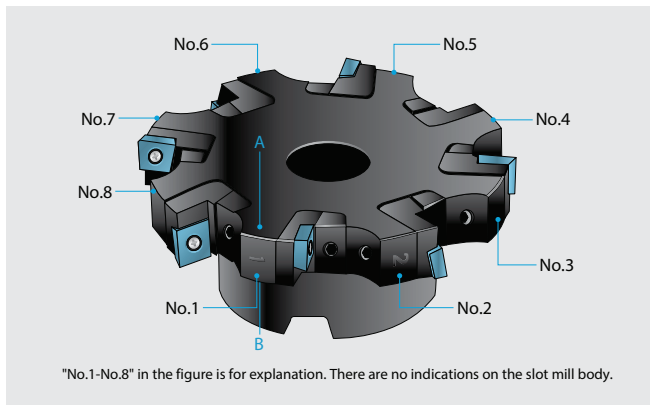

1. Set up the slot mill on length measuring equipment such as tool presetters.
2. Choose any one of the edges as a reference position. (No.1)
3. Measure the blade width of the slot mill body at position No.1. (between point A and B in the figure)
4. Move the length measuring equipment to the insert corner part and measure the step (Y_1) between the point A and the insert No.1.
5. Using the same procedure, measure (Y_2) dimension based on point B.

$$\text{Edge width} = \text{Blade width} + Y_1 + Y_2$$

6. Place the point A of the slot mill body near the position No.1 to "0 (zero)" of the length measuring equipment.
7. Adjust the edge position of the inserts in odd numbered positions (No. 3, 5, 7) to "0 (zero)" with the length measuring equipment.
8. Adjust the edge position of the inserts in even numbered positions (No. 2, 4, 6, 8) to the required edge width.

For steps 7. and 8., see "In the case of changing the slot width (Edge width)" on next page.

In the case of changing the slot width (Edge width)

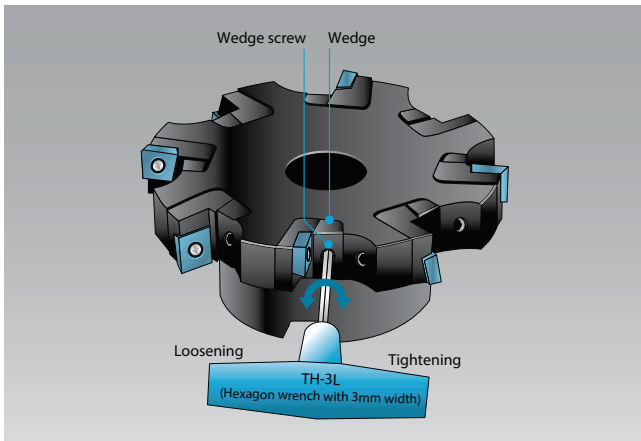

1. Set up the slot mill on length measuring equipment such as tool presettlers.
2. Insert a hexagon wrench with 3mm width (TH-3L) into the wedge screw.
3. Turn TH-3L counterclockwise to loosen the wedge.
4. Turn TH-3L clockwise by the torque of 1 N·m to tighten the wedge lightly and make the wedge contact the cartridge and the slot mill body. In doing so, some resistance occurs against the cartridge.

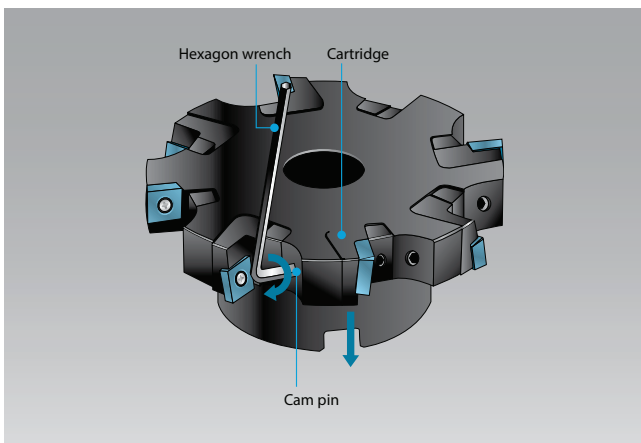

5. Insert a hexagon wrench (LW-2.5 OR LW-3) into the cam pin on the back of the cartridge.
6. Turn the wrench and adjust the position of the cartridge.
7. To secure the adjustment, back-turn the cam pin and make sure that it does not touch the groove surface of the back of the cartridge.
8. Remove the hexagon wrench from the cam pin.

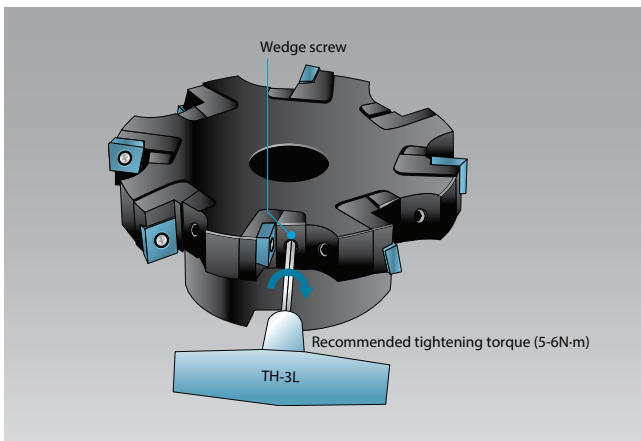

9. Insert TH-3L into the wedge screw.
10. Tighten the wedge screw by the torque of 5-6N·m. (Use a torque wrench to get the correct torque.)
11. Make sure there is no clearance between the cartridge and the slot mill body.

Make sure there is no clearance.

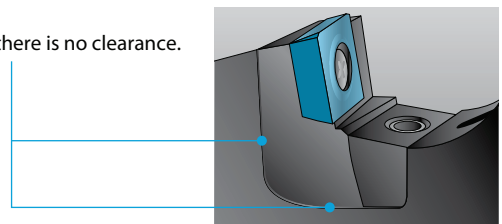

M

Milling

Cutting edge angle	45°~70°
Cutting edge angle	75°
Cutting edge angle	88°/90°
Cutter for Finishing	
High Feed Cutter	
Multi-Function	
Slot Mill	
Ball-nose Radius	
Others	

Replacement of the cartridge

Follow the instruction below to replace the cartridge.

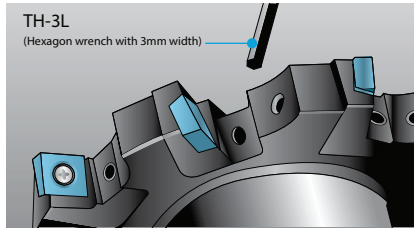

1. Insert hexagon wrench with 3mm width (TH-3L) into the wedge screw.

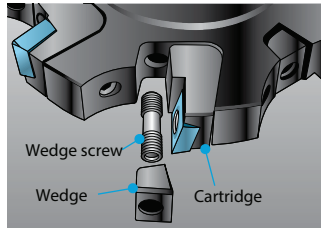
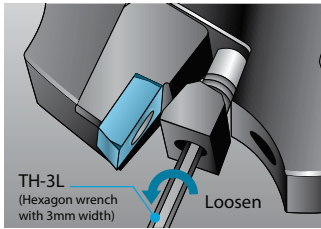

2. Loosen the wedge screw.
3. Remove the wedge screw and wedge.

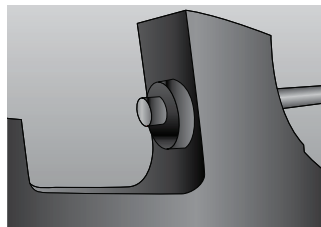
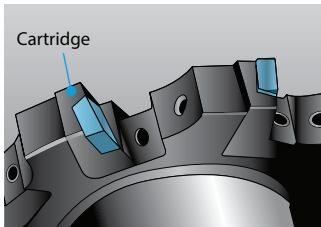

4. Remove the cartridge.

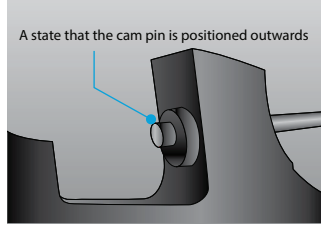
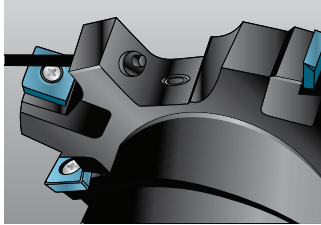

5. Before replacing the cartridge, make sure that the cam pin is positioned radially-outwards.

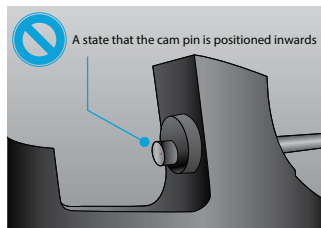

6. If the cam pin is in the position shown in the left diagram, assembling the cartridge is not possible.

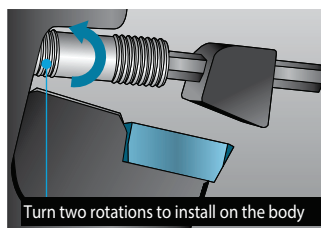
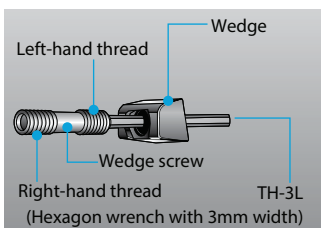

7. Place the wedge so that its larger slant surface faces toward the cartridge.
8. Turn the wedge screw two rotations to install the wedge to the body.
9. When installing the wedge screw to the body, keep the wedge from rotating and screw it in.
10. Tighten the wedge screw by the torque of 5-6N·m. Keep the screw head and the wedge even (Prevent either of those from sticking out).

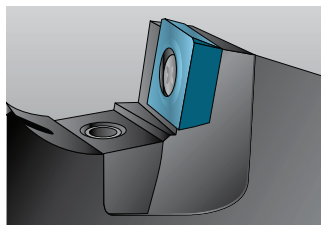

MRF

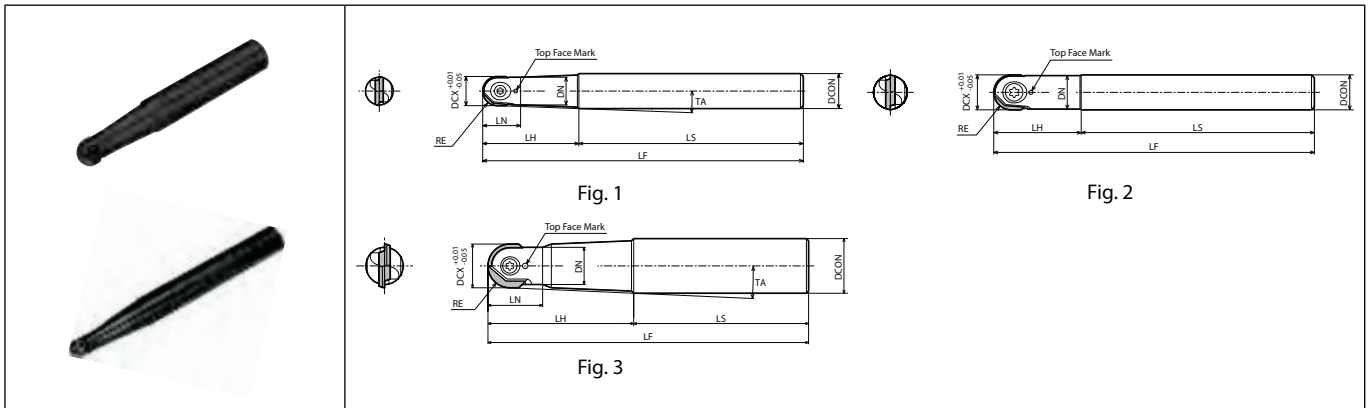

Top Face Shown

Toolholder dimensions

Description	Availability	Inserts	Dimension (mm)										TA	Coolant hole Fig.	Spare parts				Applicable inserts ➔ M244
			RE	DCX	DCON	LF	LH	DN	LN	LS	Anti-seize compound	Screw			Wrench	Wrench			
Standard Neck MRF 08-S12 10-S12 12-S12 16-S20 20-S25 25-S32	●	1	4	8	12	100	22	7.5	10	78	6°20'	No	1	P-37	SC-30067	DT-8		RDFG08FR	
	●		5	10			25	9.5	13	75	3°00'				SC-35085	DT-10		RDFG10FR	
	●		6	12	110	30	11.5	-	-	SC-40100	DT-15				RDFG12FR				
	●		8	16	20	130	50	14	20	2°50'	SC-50130				DT-20	RDFG16FR			
	●		10	20	25	140	60	17	25	3°00'	SC-60160				-	TT-25		RDFG20FR	
	●		12.5	25	32	150	70	22	31	3°30'	SC-60210				-	TT-30		RDFG25FR	
Long Neck MRF 08-S12-130 10-S16-150 12-S16-160 16-S20-160 20-S25-180 25-S32-200	●	1	4	8	12	130	50	7.5	10	80	2°30'	No	1	P-37	SC-30067	DT-8		RDFG08FR	
	●		5	10	16	150	9.5	15	100	3°50'	SC-35085				DT-10	RDFG10FR			
	●		6	12	60	11.5	16	100	2°10'	SC-40100	DT-15				RDFG12FR				
	●		8	16	20	160	65	14	20	95	2°00'				SC-50130	DT-20		RDFG16FR	
	●		10	20	25	180	80	17	25	100	2°10'				SC-60160	-		TT-25	RDFG20FR
	●		12.5	25	32	200	90	22	31	110	2°40'				SC-60210	-		TT-30	RDFG25FR

TA (Toolholder's interference angle) is the angle formed by the tangential line from insert dia. to toolholder's shank dia.
Coat Anti-seize Compound thinly on portion of taper and thread when insert is fixed.

- Cutting edge angle 45°~70°
- Cutting edge angle 75°
- Cutting edge angle 88°/90°
- Cutter for Finishing
- High Feed Cutter
- Multi-Function
- Slot Mill
- Ball-nose Radius
- Others

● : Standard item R : Right-hand only L : Left-hand only □ : Check availability

M242

MRFW (Carbide Shank)

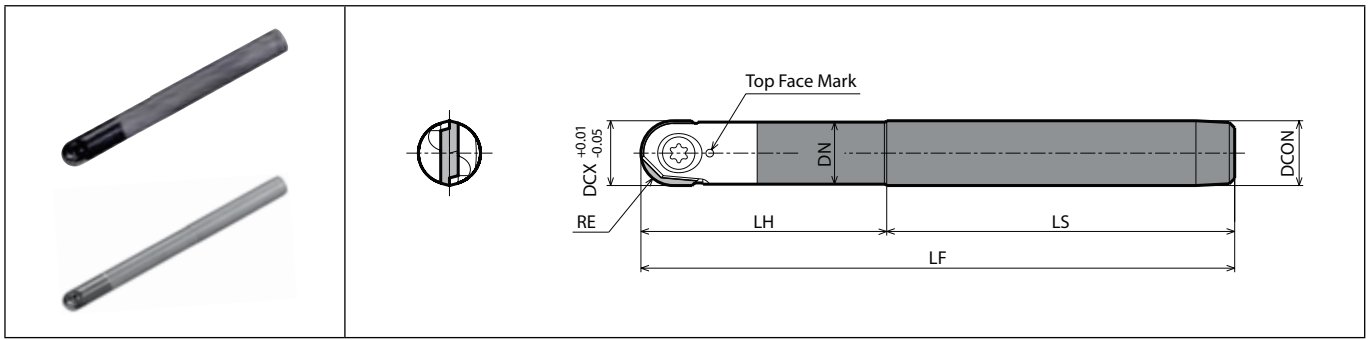

Top Face Shown

Toolholder dimensions

Description	Availability	Inserts	Dimension (mm)							Coolant hole	Spare parts			Applicable inserts ➔ M244	
			RE	DCX	DCON	LF	LH	DN	LS		Anti-seize compound	Screw	Wrench		
Carbide Standard MRFW 08-S08 10-S10 12-S12	●	1	4	8	8	100	30	7.4	70	No	P-37	SC-30067	DT-8	RDFG08FR	
	●		5	10	10		35	9.5				65	SC-35085	DT-10	RDFG10FR
	●		6	12	12	110	45	11.5	65			SC-40100	DT-15	RDFG12FR	
Carbide Long Neck MRFW 08-S08-130 10-S10-140 12-S12-150	●	1	4	8	8	130	65	7.4	65	No	P-37	SC-30067	DT-8	RDFG08FR	
	●		5	10	10	140	75	9.5				65	SC-35085	DT-10	RDFG10FR
	●		6	12	12	150	85	11.5				65	SC-40100	DT-15	RDFG12FR

Coat Anti-seize Compound thinly on portion of taper and thread when insert is fixed.



Milling

● : Standard item R : Right-hand only L : Left-hand only □ : Check availability

RDFG

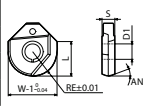
Classification of usage ● : 1st Choice ○ : 2nd Choice		Carbon steel / Alloy steel						●	P M K N S H
		Mold and die steel						●	
		Stainless steel						○	
		Gray cast iron						○	
		Nodular cast iron						○	
		Non-ferrous metals							
		Heat-resistant alloy							
		Titanium alloy							
		Hard materials							
Insert	Description	Dimension (mm)					Angle (°)	Carbide PVD M242 M243	
		S	D1	RE	L	W1	AN		
 	RDFG 08FR	2.1	3.1	4	6.6	8	15	●	MRF(W)08...
	10FR	2.7	3.6	5	8	10	15	●	MRF(W)10...
	12FR	3.2	4.1	6	9.4	12	15	●	MRF(W)12...
	16FR	4.2	5.1	8	11.3	16	10	●	MRF16...
	20FR	5.2	6.1	10	14.1	20	10	●	MRF20...
	25FR	6.2	6.1	12.5	15.5	25	10	●	MRF25...

Handed insert shows Right-hand

Recommended cutting conditions **M245**

M







Milling

Cutting edge angle 45°~70°
Cutting edge angle 75°
Cutting edge angle 88°/90°
Cutter for Finishing
High Feed Cutter
Multi- Function
Slot Mill
Ball-nose Radius
Others

● : Standard item R : Right-hand only L : Left-hand only □ : Check availability

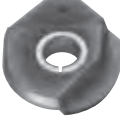
M244

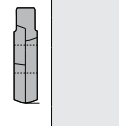
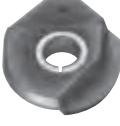
Applicable inserts

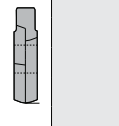
Insert	Description
	RDFG 08FR
	10FR
	12FR
	16FR
	20FR
	25FR

Check the top face mark of both insert and toolholder.

Recommended depth of cut

Description	Depth of cut (mm)		Applications
	ap	Pf	
Standard neck	MRF08-S12	0.2 (Max0.3)	0.8
	MRF10-S12	0.2	1
	MRF12-S12	0.5	1.2
	MRF16-S20	0.5	1.6
	MRF20-S25	1	2
	MRF25-S32	1	2.5
Long neck	MRF08-S12-130	0.2 (Max0.3)	0.8
	MRF10-S12-150	0.2	1
	MRF12-S12-160	0.5	1.2
	MRF16-S20-160	0.5	1.6
	MRF20-S25-180	1	2
	MRF25-S32-200	1	2.5
Carbide standard neck	MRFW08-S08	0.2 (Max0.3)	0.8
	MRFW10-S10	0.2	1
	MRFW12-S12	0.5	1.2
Carbide long Neck	MRFW08-S08-130	0.2 (Max0.3)	0.8
	MRFW10-S10-140	0.2	1
	MRFW12-S12-150	0.5	1.2

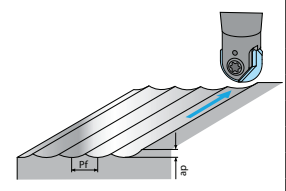

For ø8, holder may be broken because of over load if ap exceeds 0.3mm.

Recommended cutting conditions (At cutting dia. DCX)

Workpiece material	Insert grades	Vc (m/min)	fz (mm/t)	ø8		ø10		ø12	
				Vc(m/min) (n.min ⁻¹)	fz(mm/t) (Vf:mm/min)	Vc(m/min) (n.min ⁻¹)	fz(mm/t) (Vf:mm/min)	Vc(m/min) (n.min ⁻¹)	fz(mm/t) (Vf:mm/min)
Carbon steel	PR915	100~200	0.1~0.3	150 (5,970)	0.2 (2,390)	150 (4,770)	0.2 (1,910)	150 (3,980)	0.2 (1,590)
Alloy steel	PR915	80~180	0.1~0.3	130 (5,170)	0.2 (2,070)	130 (4,140)	0.2 (1,660)	130 (3,450)	0.2 (1,380)
Mold steel	PR915	50~150	0.1~0.2	100 (3,980)	0.15 (1,190)	100 (3,180)	0.15 (950)	100 (2,650)	0.15 (800)
Stainless steel	PR915	50~150	0.1~0.2	100 (3,980)	0.15 (1,190)	100 (3,180)	0.15 (950)	100 (2,650)	0.15 (800)
Cast iron	PR915	100~200	0.2~0.4	150 (5,970)	0.3 (3,580)	150 (4,770)	0.3 (2,860)	150 (3,980)	0.3 (2,390)
Workpiece material	Insert grades	Vc (m/min)	fz (mm/t)	ø16		ø20		ø25	
				Vc(m/min) (n.min ⁻¹)	fz(mm/t) (Vf:mm/min)	Vc(m/min) (n.min ⁻¹)	fz(mm/t) (Vf:mm/min)	Vc(m/min) (n.min ⁻¹)	fz(mm/t) (Vf:mm/min)
Carbon steel	PR915	100~200	0.1~0.3	150 (2,980)	0.2 (1,190)	150 (2,390)	0.2 (950)	150 (1,910)	0.2 (760)
Alloy steel	PR915	80~180	0.1~0.3	130 (2,590)	0.2 (1,030)	130 (2,070)	0.2 (830)	130 (1,660)	0.2 (660)
Mold steel	PR915	50~150	0.1~0.2	100 (1,990)	0.15 (600)	100 (1,590)	0.15 (480)	100 (1,270)	0.15 (380)
Stainless steel	PR915	50~150	0.1~0.2	100 (1,990)	0.15 (600)	100 (1,590)	0.15 (480)	100 (1,270)	0.15 (380)
Cast iron	PR915	100~200	0.2~0.4	150 (2,980)	0.3 (1,790)	150 (2,390)	0.3 (1,430)	150 (1,910)	0.3 (1,150)



Actual cutting speed (Vd) conversion coefficient table

- Vd varies depending on ap and slant face angle.
- Vd can be obtained by dividing the conversion coefficient into the recommended cutting speed.

Model	Tool dia. (DCX)	ø8		ø10		ø12		
	Depth of cut (t:mm)							
	Slant face angle (α)	0.1	0.2	0.1	0.2	0.2	0.5	
		15°	1.00	1.00	1.00	1.00	1.00	1.00
		30°	1.05	1.02	1.05	1.03	1.04	1.01
		45°	1.18	1.12	1.20	1.14	1.16	1.07
		60°	1.47	1.34	1.51	1.38	1.42	1.24
		75°	2.15	1.82	2.24	1.92	2.02	1.60
	90°(Horizontal plane)	4.48	3.22	5.06	3.57	3.92	2.50	
	Tool dia. (DCX)							
	Slant face angle (α)	0.2	0.5	0.5	1	0.5	1	
15°		1.00	1.00	1.00	1.02	1.00	1.01	
30°		1.05	1.01	1.02	1.00	1.03	1.00	
45°		1.18	1.10	1.12	1.06	1.14	1.08	
60°		1.47	1.30	1.34	1.21	1.38	1.25	
75°		2.14	1.73	1.83	1.53	1.93	1.62	
90°(Horizontal plane)	4.48	2.87	3.20	2.29	3.57	2.55		

e.g.) Suppose tool dia. 8mm, ap=0.1mm, slant face angle 90°: The actual Cutting speed Vd for carbon steel machining, when Vc is 150m/min at the biggest diameter, Vd can be obtained as Vd=150÷4.48=33.5m/min



MRW

Economical and high efficiency radius cutter with double-sided insert for various types of workpieces

Economical double-sided 8-edge insert
Combine sharpness and cutting edge strength

Obtuse edge increases cutting edge toughness

Helical cutting edge design with maximum axial rake 12° reduces cutting force, equivalent to positive inserts.

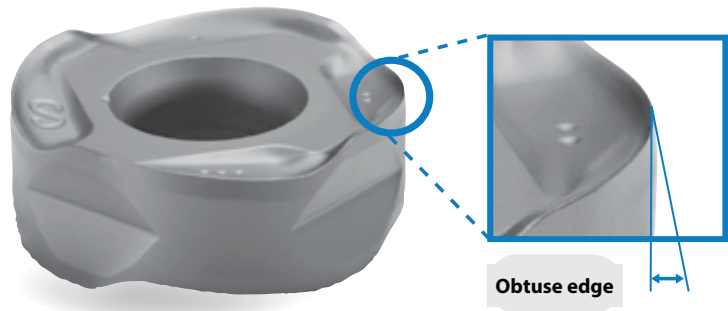

Low cutting force chipbreaker

M



Milling

Cutting edge angle
45°~70°

Cutting edge angle
75°

Cutting edge angle
88°/90°

Cutter for
Finishing

High Feed
Cutter

Multi-
Function

Slot Mill

Ball-nose
Radius

Others

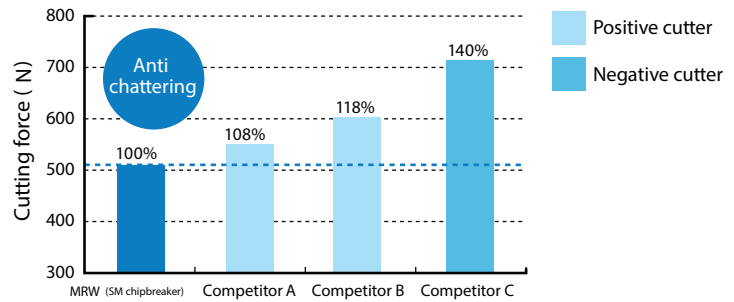
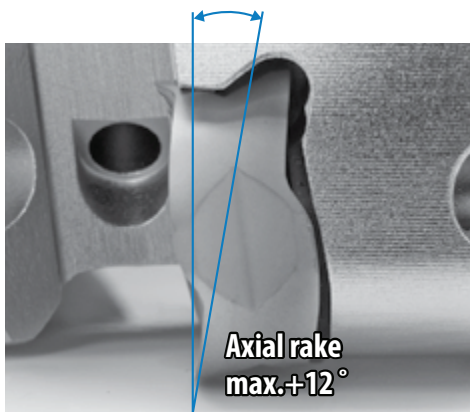

<Cutting conditions>
Vc=120m/min, ap × ae=1×40mm, fz=0.2mm/t
X5CrNi18 10, cutter ø50

1 Flat lock structure to hold insert firmly

Prevent insert rotation during machining and realizes stable machining

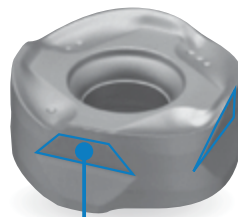

Wide and flat constraint surface

Flat lock structure

- Wide flat constraint surface**
- Receives even cutting forces
 - Controls insert rotation

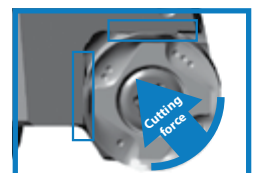

Long tool life by wide lineup with 4 grades and 3 chipbreakers, available for steel, stainless steel and heat-resistant alloys

Workpiece material		Applicable insert grades	Applicable chipbreaker
P Carbon steel/Alloy steel/Mold steel		PR1525	GM/SM/GH chipbreaker
K Cast iron		PR1510	GH/GM chipbreaker
S Ni-base heat-resistant alloys	M Stainless steel (Martensitic related)	CA6535	SM/GM chipbreaker
S Ni-base heat-resistant alloys S Titanium alloys	M Stainless steel (Austenitic related) M Stainless steel (Precipitation hardening)	PR1535	SM/GM chipbreaker

2 Insert grades for difficult-to-cut material

Controls sudden fracture and realizes stable machining
Suitable for high efficiency machining

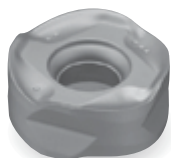

CA6535

for martensitic stainless steel and Ni-base heat-resistant alloys
High heat resistance and wear resistance with CVD coating
Improved stability with thin layer coating technology

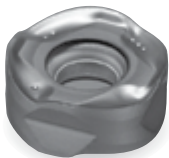

PR1535

For Ni-base heat-resistant alloys, titanium alloys and precipitation hardened stainless steel
Stable and longer tool life by special nano coating layer
MEGACOAT NANO

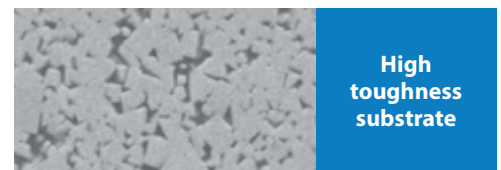

High toughness substrate

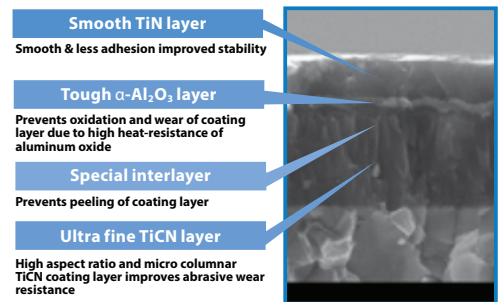

Smooth TiN layer
Smooth & less adhesion improved stability

Tough α -Al₂O₃ layer
Prevents oxidation and wear of coating layer due to high heat-resistance of aluminum oxide

Special interlayer
Prevents peeling of coating layer

Ultra fine TiCN layer
High aspect ratio and micro columnar TiCN coating layer improves abrasive wear resistance



Milling

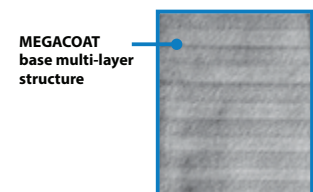

MEGACOAT base multi-layer structure

Tool life comparison (Internal evaluation)

Ni-base heat-resistant alloys

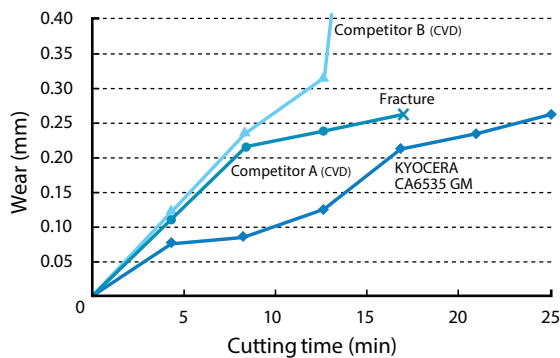

<Cutting conditions> Vc=50m/min, ap=1.0mm, fz=0.15mm/t, wet

1st choice GM chipbreaker

Stainless steel (Martensitic related)

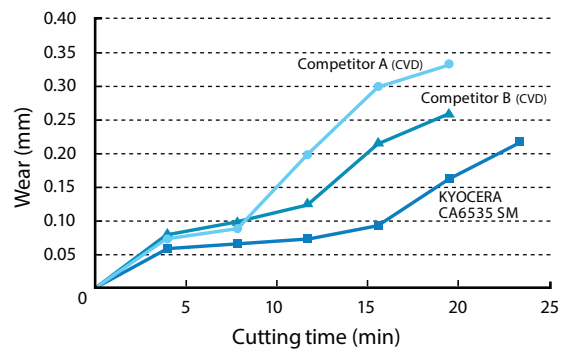

<Cutting conditions> Vc=300m/min, ap=2.0mm, fz=0.2mm/t, wet

1st choice SM chipbreaker

MRW

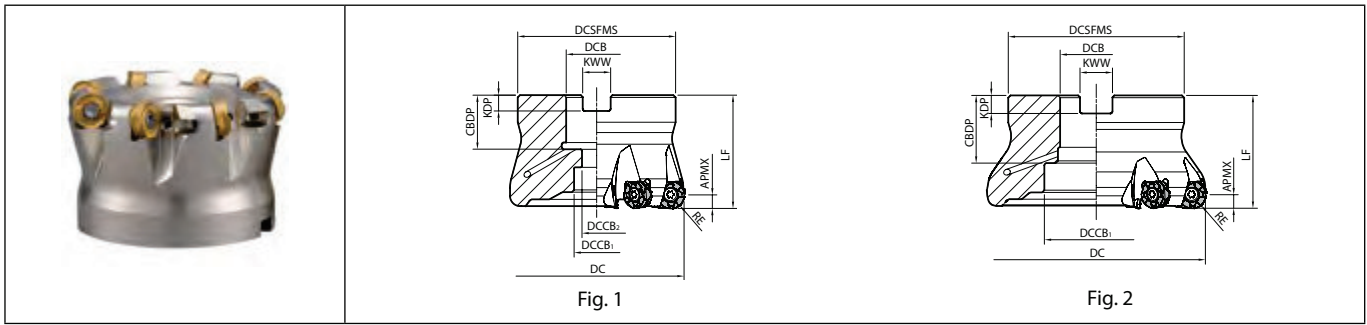

Toolholder dimensions

Description	Availability		Dimension (mm)											A.R. (°)	R.R. (°)	Coolant hole	Max. revolution (min ⁻¹)	Weight (kg)	Fig.	Applicable inserts M251
	R	Inserts	RE	DC	DCSFMS	DCB	DCCB ₁	DCCB ₂	LF	CBDP	KDP	KWW	APMX							
Metric MRW 050R-12-5T-M 050R-12-6T-M 063R-12-6T-M 063R-12-7T-M 080R-12-6T-M 080R-12-8T-M 100R-12-7T-M 100R-12-9T-M	●	5	6	50	48	18	11	40	21	6.3	10.4	6	+12	-15.5	Yes	16000	0.3	1	ROMU1204MOER-..	
	●	6		63	60											19	50	12000		1.1
	●	7		80	70	27	20	13	24	7	12.4					10600	1.1	1		
	●	6		100	78	32	46	-	30	8	14.4					10600	1.5	2		
	●	8		100	78	32	46	-	30	8	14.4					10600	1.4	2		
	●	7		100	78	32	46	-	30	8	14.4					10600	1.5	2		
	●	9		100	78	32	46	-	30	8	14.4					10600	1.4	2		
Metric MRW 063R-16-5T-M 063R-16-6T-M 080R-16-6T-M 080R-16-7T-M 100R-16-6T-M 100R-16-8T-M 125R-16-8T-M 125R-16-10T-M	●	5	8	63	60	22	19	11	40	21	6.3	10.4	8	+11	-16.5	Yes	12800	0.5	1	ROMU1605MOER-..
	●	6		80	70	27	20	13	24	7	12.4	11000					1.1	1		
	●	7		100	78	32	46	-	30	8	14.4	9600					1.4	2		
	●	6		100	78	32	46	-	30	8	14.4	9600					1.3	2		
	●	8		125	89	40	55	-	63	33	9	16.4					8500	2.6	2	
	●	8		125	89	40	55	-	63	33	9	16.4					8500	2.6	2	
	●	10		125	89	40	55	-	63	33	9	16.4					8500	2.5	2	
Bore dia. inch spec MRW 080R-12-6T 080R-12-8T 100R-12-7T 100R-12-9T MRW 080R-16-6T 080R-16-7T 100R-16-6T 100R-16-8T 125R-16-8T 125R-16-10T	□	6	6	80	70	25.4	20	13	27	6	9.5	6	+12	-15.5	Yes	12000	1.2	1	ROMU1204MOER-..	
	□	8		100	78	31.75	46	-	34	8	12.7					10600	1.5	2		
	□	7		100	78	31.75	46	-	34	8	12.7					10600	1.5	2		
	□	9		100	78	31.75	46	-	34	8	12.7					10600	1.4	2		
	□	6		80	70	25.4	20	13	27	6	9.5					11000	1.1	1		
	□	7		100	78	31.75	46	-	34	8	12.7					9600	1.4	2		
	□	6		100	78	31.75	46	-	34	8	12.7					9600	1.4	2		
Bore dia. inch spec MRW 125R-16-8T 125R-16-10T	□	8	8	125	89	38.1	55	-	63	38	10	15.9	8	+11	-16.5	Yes	8560	2.6	2	ROMU1605MOER-..
	□	8		125	89	38.1	55	-	63	38	10	15.9					8560	2.6	2	
	□	8		125	89	38.1	55	-	63	38	10	15.9					8560	2.6	2	
	□	10		125	89	38.1	55	-	63	38	10	15.9					8560	2.6	2	

Max. revolution : Do not use the cutter at the maximum revolution or higher since the centrifugal force may cause inserts and parts to scatter even under no load.
 Coat Anti-seize Compound thinly on portion of taper and thread when insert is fixed.
 APMX is Maximum ap. For more details, see page M252 below.

● : Standard item R : Right-hand only L : Left-hand only □ : Check availability

M248

M

Milling

Cutting edge angle 45°~70°

Cutting edge angle 75°

Cutting edge angle 88°/90°

Cutter for Finishing

High Feed Cutter









Multi-Function

Slot Mill

Ball-nose Radius

Others

Spare parts and applicable inserts

Description	Spare parts					Applicable Inserts  M251		
	Clamp screw	Wrench		Anti-seize compound	Mounting bolt			
		DTPM-15 	TTP-20 			General purpose	Low cutting force	Tough Edge (For Heavy Milling)
MRW 050R-12... 063R-12... 080R-12... 100R-12...	SB-4085TRP	DTPM-15		P-37	HH10X30	ROMU1204M0ER-GM	ROMU1204M0ER-SM	ROMU1204M0ER-GH
	Recommended tightening torque for insert clamp 3.5N·m		HH12X35					
			-					
MRW 063R-16... 080R-16... 100R-16... 125R-16...	SB-50140TRP	TTP-20		P-37	HH10X30	ROMU1605M0ER-GM	ROMU1605M0ER-SM	ROMU1605M0ER-GH
	Recommended tightening torque for insert clamp 4.5N·m		HH12X35					
			-					



Milling

MRW

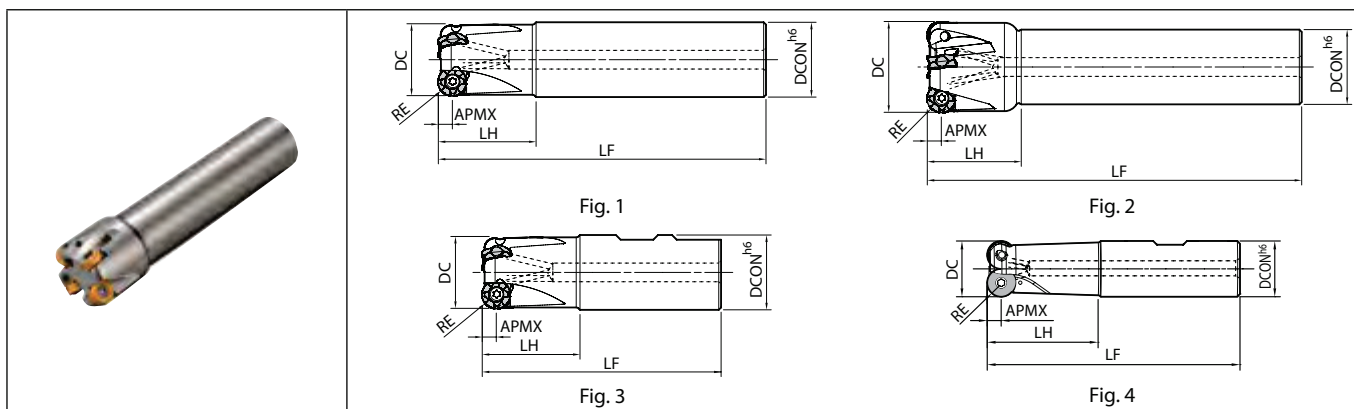

Toolholder dimensions

Description	Availability	Inserts	Dimension (mm)						A.R. max. (°)	R.R. (°)	Coolant hole	Max. revolution (min ⁻¹)	Fig.	Applicable inserts ➔ M251
			RE	DC	DCON	LF	LH	APMX						
Cylindrical MRW 32-S32-12-3T 40-S32-12-4T 50-S42-12-5T	●	3	32	32	140	40	6	+12	-20	Yes	22000	1	ROMU1204MOER-..	
	●	4	6	40	32	160	40	-16.5	-16.5	Yes	18800	2		
	●	5	50	42	170	40	6	-15.5	-15.5	Yes	16000	2		
Cylindrical MRW 40-S32-16-3T 50-S42-16-4T 63-S42-16-5T	●	3	40	32	160	40	8	+11	-18	Yes	17200	2	ROMU1605MOER-..	
	●	4	8	50	42	170	40	-16.5	-16.5	Yes	14800	2		
	●	5	63	42	170	50	8	-16.5	-16.5	Yes	12800	2		
Long Shank MRW 32-S32-12-2T-200 40-S32-12-3T-200 50-S42-12-4T-300	●	2	32	32	200	40	6	+12	-20	Yes	22000	1	ROMU1204MOER-..	
	●	3	6	40	32	200	40	-16.5	-16.5	Yes	18800	2		
	●	4	50	42	300	40	6	-15.5	-15.5	Yes	16000	2		
Long Shank MRW 40-S32-16-2T-200 50-S42-16-3T-300 63-S42-16-4T-300	●	2	40	32	200	40	8	+11	-18	Yes	17200	2	ROMU1605MOER-..	
	●	3	8	50	42	300	40	-16.5	-16.5	Yes	14800	2		
	●	4	63	42	300	50	8	-16.5	-16.5	Yes	12800	2		
Weldon MRW 32-W32-12-3T 40-W32-12-4T 50-W40-12-5T	●	3	32	32	102	40	6	+12	-20	Yes	22000	3	ROMU1204MOER-..	
	●	4	6	40	100	40	6	-16.5	-16.5	Yes	18800	4		
	●	5	50	40	110	40	6	-15.5	-15.5	Yes	16000	4		
Weldon MRW 40-W32-16-3T 50-W40-16-4T 63-W40-16-5T	●	3	40	32	100	40	8	+11	-18	Yes	17200	4	ROMU1605MOER-..	
	●	4	8	50	110	40	8	-16.5	-16.5	Yes	14800	4		
	●	5	63	40	120	50	8	-16.5	-16.5	Yes	12800	4		

Max. revolution : Do not use the cutter at the maximum revolution or higher since the centrifugal force may cause inserts and parts to scatter even under no load.

Coat Anti-seize Compound thinly on portion of taper and thread when insert is fixed.

APMX is Maximum ap. For more details, see page M252 below.

Spare parts and applicable inserts

Description	Spare parts				Applicable Inserts ➔ M251		
	Clamp screw	Wrench		Anti-seize compound	General purpose	Low cutting force	Tough edge (For Heavy Milling)
		DTPM-15 	TTP-20 				
MRW ...-12...	SB-4085TRP	DTPM-15		P-37	ROMU1204MOER-GM	ROMU1204MOER-SM	ROMU1204MOER-GH
	Recommended tightening torque for insert clamp 3.5N-m						
MRW ...-16...	SB-50140TRP	TTP-20		P-37	ROMU1605MOER-GM	ROMU1605MOER-SM	ROMU1605MOER-GH
	Recommended tightening torque for insert clamp 4.5N-m						

● : Standard item R : Right-hand only L : Left-hand only □ : Check availability

M250

M

Milling

Cutting edge angle 45°~70°

Cutting edge angle 75°

Cutting edge angle 88°/90°

Cutter for Finishing

High Feed Cutter





Multi-Function

Slot Mill

Ball-nose Radius

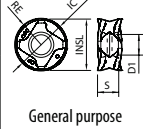
Others

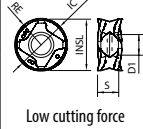
ROMU

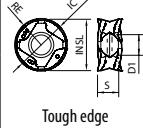
Insert		Description	Dimension (mm)					Carbide				Applicable toolholder M248 M250	
			IC	S	D1	RE	INSL	CVD		PVD			
								CA6535	PR1510	PR1525	PR1535		
<p>Classification of usage</p> <p>★: Roughing / 1st Choice ☆: Roughing / 2nd Choice ■: Finishing / 1st Choice □: Finishing / 2nd Choice (In case hardness is 45HRC or under)</p>		Carbon steel / Alloy steel						★	☆			P	
		Mold and die steel						★	☆				
		Austenitic stainless steel						☆	★			M	
		Martensitic stainless steel					★		☆				
		Precipitation hardening stainless steel							★				
		Gray cast iron						★				K	
		Nodular cast iron						★					
		Non-ferrous metals										N	
		Heat-resistant alloy						★		☆			S
		Titanium alloy								★			
		Hard materials										H	
		ROMU 1204M0ER-GM	12	4.75	4.6	6	11.8	●	●	●	●	MRW...-12-..	
	General purpose	ROMU 1605M0ER-GM	16	5.48	6.2	8	15.8	●	●	●	●	MRW...-16-..	
		ROMU 1204M0ER-SM	12	4.75	4.6	6	11.8	●	●	●	●	MRW...-12-..	
	Low cutting force	ROMU 1605M0ER-SM	16	5.48	6.2	8	15.8	●	●	●	●	MRW...-16-..	
		ROMU 1204M0ER-GH	12	4.75	4.6	6	11.8	●	●	●	●	MRW...-12-..	
	Tough edge	ROMU 1605M0ER-GH	16	5.48	6.2	8	15.8	●	●	●	●	MRW...-16-..	

Handed insert shows Right-hand

Recommended cutting conditions M252



Milling

●: Standard item R: Right-hand only L: Left-hand only □: Check availability

Recommended cutting conditions

Workpiece material	Recommended chipbreaker (fz: mm/t) *Recommended feed rate (Reference value) for ROMU12 type: ap=3 mm/for ROMU16 type: ap=4 mm			Recommended insert grades (Vc: m/min)			
	GM	SM	GH	MEGACOAT NANO			CVD Coated carbide
				PR1535	PR1525	PR1510	CA6535
Carbon steel	★ 0.1~ 0.2 ~0.3	☆ 0.06~ 0.15 ~0.2	☆ 0.15~ 0.3 ~0.35	☆ 120~ 180 ~250	★ 120~ 180 ~250	-	-
Alloy steel	★ 0.1~ 0.2 ~0.3	☆ 0.06~ 0.15 ~0.2	☆ 0.15~ 0.3 ~0.35	☆ 100~ 160 ~220	★ 100~ 160 ~220	-	-
Mold steel	★ 0.1~ 0.15 ~0.25	☆ 0.06~ 0.12 ~0.2	☆ 0.15~ 0.2 ~0.3	☆ 80~ 140 ~180	★ 80~ 140 ~180	-	-
Stainless steel (Austenitic related)	☆ 0.1~ 0.15 ~0.2	★ 0.06~ 0.12 ~0.2	☆ 0.15~ 0.2 ~0.25	★ 100~ 160 ~200	☆ 100~ 160 ~200	-	-
Stainless steel (Martensitic related)	☆ 0.1~ 0.15 ~0.2	★ 0.06~ 0.12 ~0.2	☆ 0.15~ 0.2 ~0.25	☆ 150~ 200 ~250	-	-	★ 180~ 240 ~300
Stainless steel (Precipitation Hardening)	★ 0.1~ 0.15 ~0.2	☆ 0.06~ 0.12 ~0.2	☆ 0.15~ 0.2 ~0.25	★ 90~ 120 ~150	-	-	-
Gray cast iron	★ 0.1~ 0.2 ~0.3	-	☆ 0.15~ 0.3 ~0.35	-	-	★ 120~ 180 ~250	-
Nodular cast iron	★ 0.1~ 0.15 ~0.25	-	☆ 0.15~ 0.2 ~0.3	-	-	★ 100~ 150 ~200	-
Ni-base heat-resistant alloys	★ 0.1~ 0.12 ~0.15	☆ 0.06~ 0.1 ~0.15	☆ 0.12~ 0.15 ~0.2	☆ 20~ 30 ~50	-	-	★ 20~ 30 ~50
Titanium alloys	☆ 0.1~ 0.12 ~0.15	★ 0.06~ 0.1 ~0.15	-	★ 40~ 60 ~80	-	☆ 30~ 50 ~70	-

* Machining with coolant is recommended for Ni-base heat-resistant alloys and titanium alloys.
 * The bold-faced number indicates a center value of recommended cutting condition. Adjust the cutting speed and the feed rate within the above conditions according to the actual machining situation.
 * Recommended feed rate is the reference value when ap is RE/2 (3mm for ROMU12, 4mm for ROMU16).
 For lower ap than the above conditions, the conversion factor in the following table is recommended.

★: 1st Recommendation ☆: 2nd Recommendation

M



Milling

Insert	ap (Recommended)	Max. ap	Conversion factor for feed per tooth fz				
			ap=0.5mm	ap=1mm	ap=2mm	ap=3mm	ap=4mm
ROMU12 type	3mm or less	6mm	2.1	1.5	1.1	1.0 (Standard)	-
ROMU16 type	4mm or less	8mm	2.4	1.7	1.3	1.1	1.0 (Standard)

* Example (ROMU12 type, carbon steel, GM chipbreaker, ap=1mm)

$$\boxed{fz=0.2\text{mm/t (Reference value for carbon steel and GM chipbreaker)}} \times \boxed{1.5 \text{ (Conversion factor for ROMU12 type, ap=1mm)}} = \boxed{fz = 0.3 \text{ mm/t (Recommended feed rate)}}$$

* Recommended ap: 3mm or less for ROMU12, 4mm or less for ROMU16
 Except the case that ap temporarily surpass the recommended ap, machining under the recommended ap is recommended.

Corner-R shape during processing

Corner-R shape during processing with MRW (Ref. to the right figure)

Insert	APMX	X	Y
ROMU12 type	6 mm	3 mm	0.1 mm
ROMU16 type	8 mm	4 mm	0.1 mm

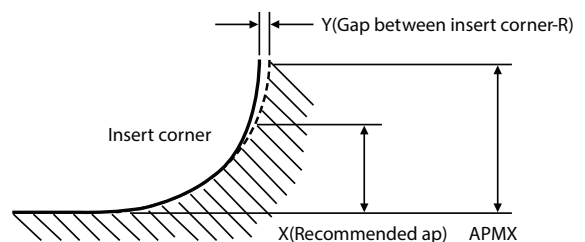

* When machining with larger ap than recommended ap (X), there is a gap (Y) between the workpiece corner and Insert corner-R(RE).
 * The above figure is estimation. There would be ±0.2mm variation depending on the cutting conditions.

Cutting edge angle
45°~70°

Cutting edge angle
75°

Cutting edge angle
88°/90°

Cutter for Finishing

High Feed Cutter

Multi-Function

Slot Mill

Ball-nose Radius

Others

How to mount an insert

- Be sure to remove dust and chips from the insert mounting pocket.
- Clamp screw
 - Apply anti-seize compound on portion of taper and thread of clamp screw.
 - Attach the screw to the front end of the wrench. While lightly pressing the insert against the constraint surfaces, put the screw into the hole of the insert and tighten. (Ref. to Fig. 1)
- Wrenches and clamp screws are "Torx Plus".
 - Fig. 2 wrench is for MRW-12. (Straight grip)
 - Fig. 3 wrench is for MRW-16. (T-shaped grip)

Please use a "Torx Plus" Wrench for tightening clamp screw.

* If a "Torx" wrench (Fig. 4) is used to tighten, the screw head might become damaged and then the screw cannot be removed.
- When tightening the screw, make sure that the wrench is parallel to the screw.
Recommended Tightening torque, See spare parts table.
- After tightening the screw, make sure that there is no clearance between the insert seat surface and the bearing surface of the toolholder or between the insert side surfaces and the constraint surface of the toolholder. If there is any clearance, remove the insert and mount it again according to the above steps.

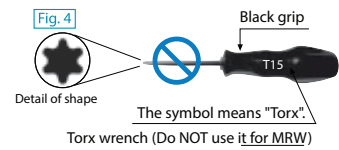
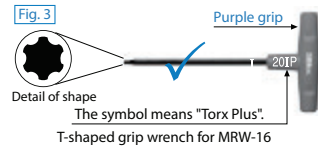
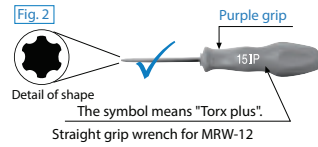
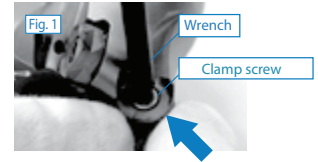

Case studies

12Cr Steel

Machining efficiency 1.2 times
Economical double-sided insert

- Turbine blade • Vc=270m/min • fz=0.278mm/t
- ap=0.5~1.0mm ae=max.35mm • Dry
- MRW050R-12-6T-M (6 flutes) • ROMU1204M0ER-SM (CA6535)

CA6535	Stable machining
Competitor A (Positive cutter)	Unstable machining with large noise

• MRW improved machining efficiency by 1.2 times with same tool life compared with competitor A.
• MRW has cost advantage due to double-sided inserts.

(User evaluation)

12Cr Steel

Same or longer tool life
Economical double-sided insert

- Turbine Blade • Vc=250m/min • fz=0.16mm/t
- ap=2.0mm ae=5~30mm • Wet
- MRW050R-12-5T-M (5 flutes) • ROMU1204M0ER-SM (CA6535)

CA6535	Stable, available for further machining
Competitor B (Positive cutter)	Unstable machining with large noise

• MRW showed less damage on the cutting edge and reduced machining noise.
• MRW has equal or longer tool life and cost advantage due to double sided inserts.

(User evaluation)

Applications

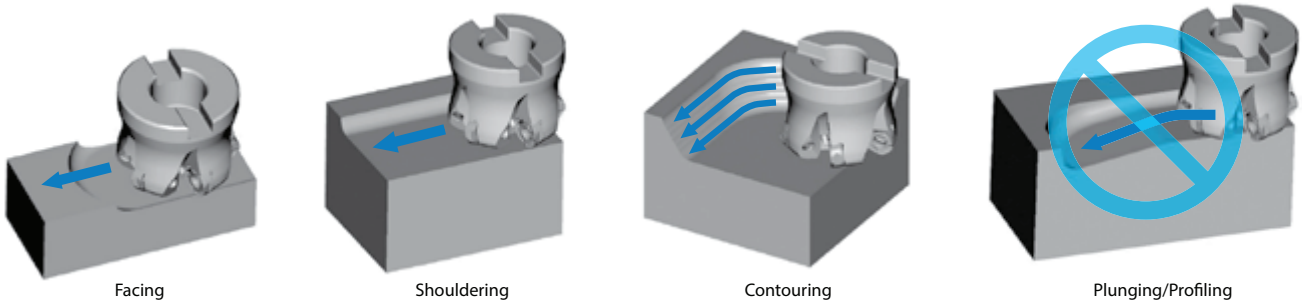

MRX

Excellent cutting performance with low cutting force design
High efficiency radius cutter

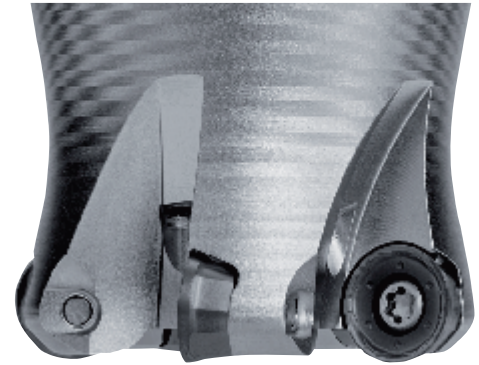

1 Low cutting force design

Low cutting force with helical cutting-edge design

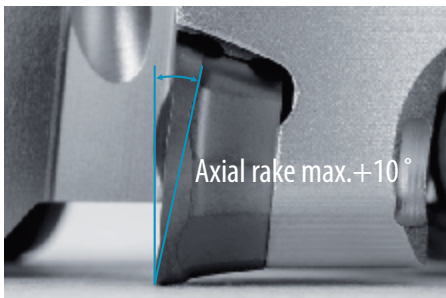

Cutting force comparison (Internal evaluation)

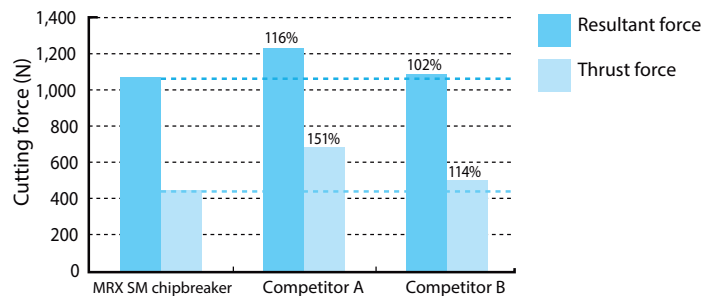

<Cutting conditions>
Vc=120m/min, ap.ae=2.25mm, fz=0.2mm/t, SUS304, Cutterø50

2 Flat lock structure to hold insert firmly

Prevent insert rotation during machining and realizes stable machining

Flat lock structure

- Wide flat constraint surface**
- Receives even cutting forces
 - Controls insert rotation

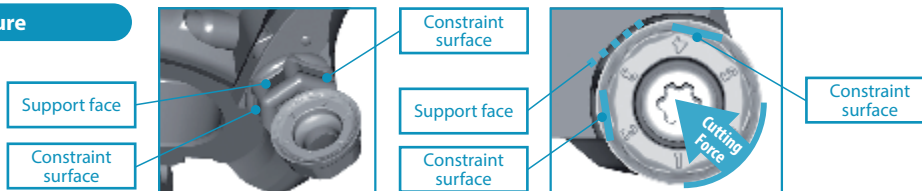

3 Various applications

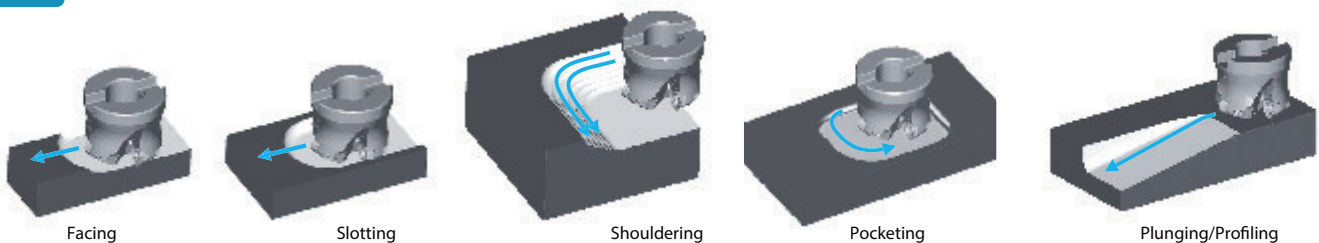

4 Machining of various materials possible

Insert grades **CA6535/PR1535** for difficult-to-cut material are available. Long tool life by wide lineup with 4 grades and 3 chipbreakers, available for steel, stainless steel and heat-resistant alloys.

Cost-effective M class inserts are available



MRX

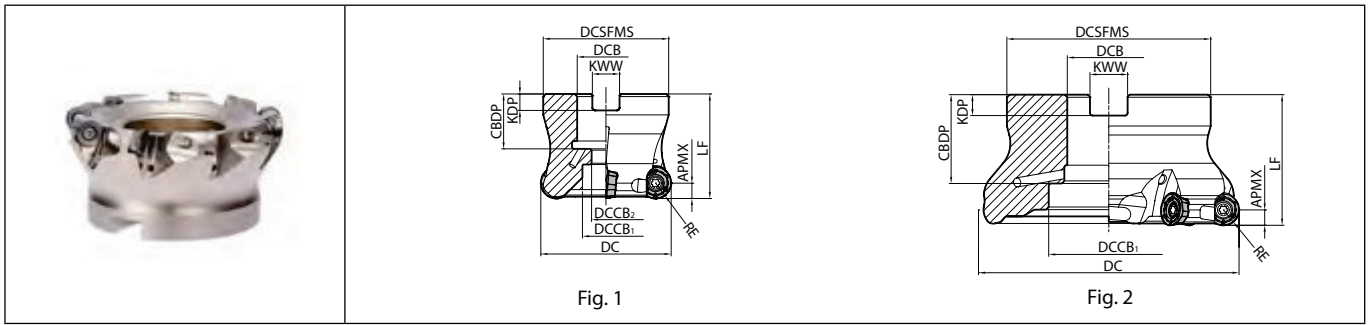

Toolholder dimensions

Description	Availability		Dimension (mm)											A.R. (°)	R.R. (°)	Coolant hole	Max. revolution (min ⁻¹)	Weight (kg)	Fig.	Applicable inserts M260				
	R	Inserts	RE	DC	DCSFMS	DCB	DCCB ₁	DCCB ₂	LF	CBDP	KDP	KWW	APMX											
Metric	MRX	●	5	40	38	16	15	9		19	5.6	8.4	5	+10	-5.5	Yes	20000	0.2	1	RPGT10T3... RPMT10T3...				
		●	6	50	48		22	18	11	40	21	6.3					10.4	17500	0.3		1			
		●	7	63	60													15000	0.6		1			
	Metric	MRX	●	4	40	38	16	13.5	9		19	5.6	8.4	6	+10	-5.5	Yes	21000	0.2	1	RPGT1204... RPMT1204...			
			●		50														18000			1		
			●		5	48														0.3		1		
			●		4	52				40	21	6.3	10.4					17500		1				
			●	5			22	18	11													15500		1
			●	6	63																	15000		1
			●	5	60																		1	
			●	6	66																			1
			●	6	80	70	27	20	13		24	7	12.4									13500	1.2	1
●			8						50	30	8	14.4								12000		1.1	1	
●			7	100	78	32	46	-		30	8	14.4								12000		1.4	2	
●			9																				2	
Bore dia. inch spec	MRX	●	4	63									8	+10	-5.5	Yes	13500	0.5	1	RPGT1605... RPMT1605...				
		●	5	60	22	18	11	40	21	6.3	10.4								1					
		●	4	66															13000		0.6	1		
		●	5																0.5		1			
		●	6	80	70	27	20	13		24	7	12.4							11500		1.1	1		
		●	6						50	30	8	14.4							10000		1.4	2		
	MRX	●	7	100	78	32	46	-		30	8	14.4					10000	1.4	2					
		●	6	125	89	40	55		63	33	9	16.4				9000	2.6	2						
		●	8														2							
		□	6	80	70	25.4	20	13		27	6	9.5				13500	1.2	1						
		□	8						50	34	8	12.7				12000	1.1	1						
		□	7	100	78	31.75	46	-		34	8	12.7				12000	1.5	2						
MRX	□	5	80	70	25.4	20	13		27	6	9.5				11500	1.1	1							
	□	6						50	34	8	12.7				10000	1.4	2							
	□	7	100	78	31.75	46	-		34	8	12.7				10000	1.4	2							
	□	6	125	89	38.1	55		63	38	10	15.9				9000	2.7	2							
	□	6														2								
	□	8														2								





Max. revolution : Do not use the cutter at the maximum revolution or higher since the centrifugal force may cause inserts and parts to scatter even under no load.
Coat Anti-seize Compound thinly on portion of taper and thread when insert is fixed.

● : Standard item R : Right-hand only L : Left-hand only □ : Check availability



Milling

Spare parts and applicable inserts

Description	Spare parts					Applicable inserts M260
	Clamp screw	Wrench		Anti-seize compound	Mounting bolt	
		DTPM 	TTP 			
MRX 040R-10... 050R-10... 063R-10...	SB- 3070TRP	DTPM-10		P-37	HH8X25 HH10X30	RPMT10T3MOER-GM RPMT10T3MOER-GM RPMT10T3MOER-SM RPMT10T3MOEN-GH * 1
Recommended tightening torque for insert clamp 2.0N•m						
MRX 040R-12... 050R-12... 063R-12... 080R-12... 100R-12...	SB- 4090TRPN	DTPM-15		P-37	HH8X25 HH10X30 HH12X35 -	RPMT1204MOER-GM RPMT1204MOER-GM RPMT1204MOER-SM RPMT1204MOEN-GH * 2
Recommended tightening torque for insert clamp 3.5N•m						
MRX 063R-16... 080R-16... 100R-16... 125R-16...	SB- 50120TRP	TTP-20		P-37	HH10X30 HH12X35 -	RPMT1605MOER-GM RPMT1605MOER-GM RPMT1605MOER-SM RPMT1605MOEN-GH * 3
Recommended tightening torque for insert clamp 4.5N•m						

Max. Revolution

Do not use the cutter at the maximum revolution or higher since the centrifugal force may cause inserts and parts to scatter even under no load.

 Coat anti-seize compound thinly on portion of taper and thread when insert is fixed.

- *1... Not compatible with the conventional RPMT10T3M0.
- *2... Not compatible with the conventional RPMT1204M0 and RPMT1204M0-H.
- *3... Not compatible with the conventional RPMT1606M0-H.

M



Milling

Cutting edge angle
45°~70°

Cutting edge angle
75°

Cutting edge angle
88°/90°

Cutter for
Finishing

High Feed
Cutter

Multi-
Function

Slot Mill

Ball-nose
Radius

Others

MRX

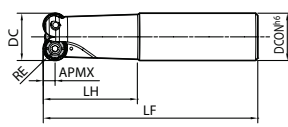

Fig. 1

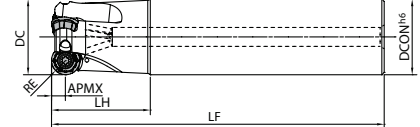

Fig. 2

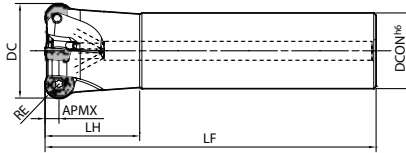

Fig. 3

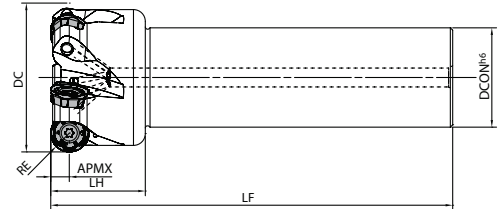

Fig. 4

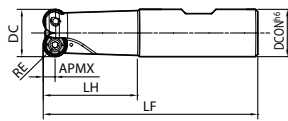

Fig. 5

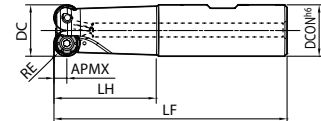

Fig. 6

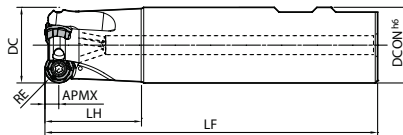

Fig. 7

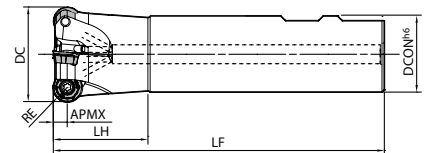

Fig. 8

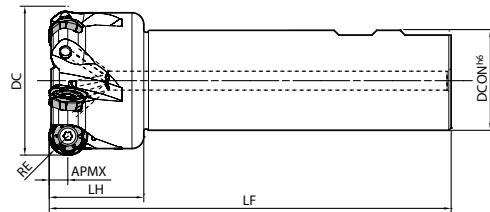

Fig. 9

M



Milling

Toolholder dimensions

Description	Availability	Inserts	Dimension (mm)							A.R. max. (°)	R.R. (°)	Coolant hole	Max. revolution (min ⁻¹)	Fig.	Applicable inserts M260			
			RE	DC	DCON	LF	LH	APMX										
Cylindrical	MRX 16-S16-08-2T 20-S20-08-2T 25-S25-08-4T	● 2	4	16	16	110	40	4	+3	No	38000	1	RDGT0803... RDMT0803...					
		● 4		20	20	120			-5.5					Yes	32000	2		
		● 4		25	25	120			+10						28000	2		
	MRX 20-S20-10-2T 25-S25-10-3T 32-S32-10-4T	● 2	5	20	20	120	40	5	+5	-8	No	30000	1	RPGT10T3... RPMT10T3...				
		● 3		25	25				+10						-5.5	Yes	28000	2
		● 4		32	32				140						+10		-5.5	22500
	MRX 32-S32-12-3T 40-S32-12-4T 50-S42-12-5T	● 3	6	32	32	140	40	6	+10	-5.5	Yes	24500	2	RPGT1204... RPMT1204...				
		● 4		40					21000						3			
		● 5		50					42						170	18000	3	
	MRX 40-S32-16-2T 50-S42-16-4T 63-S42-16-5T	● 2	8	40	32	140	40	8	+10	-5.5	Yes	18000	3	RPGT1605... RPMT1605...				
		● 4		50	42	170			15500						3			
		● 5		63	42	170			13500						4			
Weldon	MRX 16-W16-08-2T 20-W20-08-2T 25-W25-08-4T	● 2	4	16	16	89	40	4	+3	No	38000	5	RDGT0803... RDMT0803...					
		● 4		20	20	91			-5.5					Yes	32000	6		
		● 4		25	25	97			+10						28000	7		
	MRX 20-W20-10-2T 25-W25-10-3T 32-W32-10-4T	● 2	5	20	20	91	40	5	+5	-8	No	30000	5	RPGT10T3... RPMT10T3...				
		● 3		25	25	97			+10						-5.5	Yes	28000	7
		● 4		32	32	101			+10						-5.5		22500	7
	MRX 32-W32-12-3T 40-W32-12-4T 50-W40-12-5T	● 3	6	32	32	101	40	6	+10	-5.5	Yes	24500	7	RPGT1204... RPMT1204...				
		● 4		40					21000						8			
		● 5		50					40						111	18000	8	
	MRX 40-W32-16-2T 50-W40-16-4T 63-W40-16-5T	● 2	8	40	32	101	40	8	+10	-5.5	Yes	18000	8	RPGT1605... RPMT1605...				
		● 4		50	40	111			15500						8			
		● 5		63	40	112			13500						9			
Long Shank	MRX 16-S16-08-2T-160 20-S20-08-2T-180 25-S25-08-4T-180	● 2	4	16	16	160	70	4	+3	No	38000	1	RDGT0803... RDMT0803...					
		● 4		20	20	180			80					+10	-5.5	Yes	32000	2
		● 4		25	25	180											28000	2
	MRX 20-S20-10-2T-180 25-S25-10-2T-180 32-S32-10-4T-200	● 2	5	20	20	180	80	5	+5	-8	No	30000	1	RPGT10T3... RPMT10T3...				
		● 4		25	25				+10						-5.5	Yes	28000	2
		● 4		32	32				200						+10		-5.5	22500
	MRX 32-S32-12-2T-200 40-S32-12-4T-200 50-S42-12-4T-300	● 2	6	32	32	200	80	6	+10	-5.5	Yes	24500	2	RPGT1204... RPMT1204...				
		● 4		40					21000						3			
		● 4		50					42						300	18000	3	
	MRX 40-S32-16-2T-200 50-S42-16-4T-300 63-S42-16-4T-300	● 2	8	40	32	200	40	8	+10	-5.5	Yes	18000	3	RPGT1605... RPMT1605...				
		● 4		50	42	300			15500						3			
		● 4		63	42	300			13500						4			

Max. revolution : Do not use the cutter at the maximum revolution or higher since the centrifugal force may cause inserts and parts to scatter even under no load.
Coat Anti-seize Compound thinly on portion of taper and thread when insert is fixed.

M

Milling

Cutting edge angle 45°~70°

Cutting edge angle 75°

Cutting edge angle 88°/90°

Cutter for Finishing

High Feed Cutter

Multi-Function

Slot Mill

Ball-nose Radius

Others

● : Standard item R : Right-hand only L : Left-hand only □ : Check availability

MRX

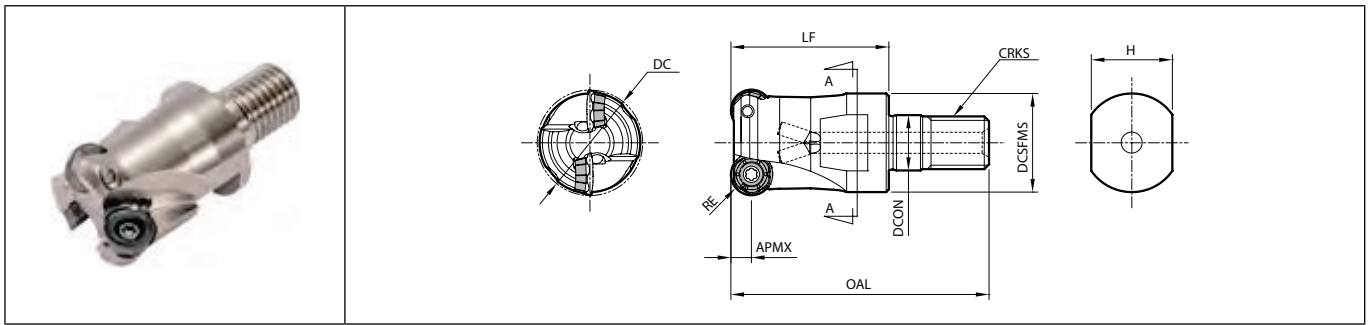

Toolholder dimensions

Description	Availability	Inserts	Dimension (mm)								A.R. max. (°)	R.R. (°)	Coolant hole	Max. revolution (min ⁻¹)	Applicable inserts ● M260	
			RE	DC	DCON	DCSFMS	OAL	LF	APMX	CRKS						H
MRX 16-M08-08-2T 20-M10-08-2T 25-M12-08-4T	●	2	16	8.5	14.7	42	25		M8x1.25	12	+3	No	38000	RDGT0803... RDMT0803...		
	●	4	20	10.5	18.7	48	30	4	M10x1.5	15	-5.5	Yes	32000			
	●	4	25	12.5	23	56	35		M12x1.75	19	+10	Yes	28000			
MRX 20-M10-10-2T 25-M12-10-3T 32-M16-10-4T	●	2	20	10.5	18.7	48	30		M10x1.5	15	+5	-8	No	30000	RPGT10T3... RPMT10T3...	
	●	3	25	12.5	23	56	35	5	M12x1.75	19	+10	-5.5	Yes	28000		
	●	4	32	17	30	62	40		M16x2.0	24	+10	-5.5	Yes	22500		
MRX 32-M16-12-3T 40-M16-12-4T	●	3	32	17	30	62	40	6	M16x2.0	24	+10	-5.5	Yes	24500	RPGT1204... RPMT1204...	
	●	4	40										Yes	21000		
MRX 40-M16-16-2T	●	2	8	40	17	30	62	40	8	M16x2.0	24	+10	-5.5	Yes	18000	RPGT1605... RPMT1605...

Max. revolution : Do not use the cutter at the maximum revolution or higher since the centrifugal force may cause inserts and parts to scatter even under no load.

Coat Anti-seize Compound thinly on portion of taper and thread when insert is fixed.

See page M60 for applicable arbor (BT arbor for exchangeable head / double-face clamping spindle)

Spare parts and applicable inserts

Description	Clamp screw	Wrench		Anti-seize compound	Applicable inserts ● M260
		DTPM	TTP		
MRX ...-08...	SB-2555TRP	DTPM-8		P-37	RDMT0803MOER-GM RDGT0803MOER-GM RDGT0803MOER-SM RDMT0803MOEN-GH * 1
	Recommended tightening torque for insert clamp 1.2N·m				
MRX ...-10...	SB-3070TRP	DTPM-10		P-37	RPMT10T3MOER-GM RPGT10T3MOER-GM RPGT10T3MOER-SM RPMT10T3MOEN-GH * 2
	Recommended tightening torque for insert clamp 2.0N·m				
MRX ...-12...	SB-4090TRPN	DTPM-15		P-37	RPMT1204MOER-GM RPGT1204MOER-GM RPGT1204MOER-SM RPMT1204MOEN-GH * 3
	Recommended tightening torque for insert clamp 3.5N·m				
MRX ...-16...	SB-50120TRP	TTP-20		P-37	RPMT1605MOER-GM RPGT1605MOER-GM RPGT1605MOER-SM RPMT1605MOEN-GH * 4
	Recommended tightening torque for insert clamp 4.5N·m				

Max. Revolution

Do not use the cutter at the maximum revolution or higher since the centrifugal force may cause inserts and parts to scatter even under no load.

Coat anti-seize compound thinly on portion of taper and thread when insert is fixed.

*1... Not compatible with the conventional RDMT08T2M0-H.

*2... Not compatible with the conventional RPMT10T3M0.





*3... Not compatible with the conventional RPMT1204M0 and RPMT1204M0-H.

*4... Not compatible with the conventional RPMT1606M0-H.

● : Standard item R : Right-hand only L : Left-hand only □ : Check availability



RDMT/RDGT/RPMT/RPGT

Insert		Description	Dimension (mm)				Angle (°)	Carbide				Applicable toolholder M255 M258 M259	
			IC	S	D1	RE		AN	CVD		PVD		
									CA6535	PR1510	PR1525		PR1535
 General purpose		RDGT 0803M0ER-GM	8	3.18	3	4	15	●	●	●	●	MRX...-08..	
		RPMT 10T3M0ER-GM	10	3.97	3.5	5	11	●	●	●	●	MRX...-10..	
		RPMT 1204M0ER-GM	12	4.76	4.6	6	11	●	●	●	●	MRX...-12..	
		RPMT 1605M0ER-GM	16	5.56	5.8	8	11	●	●	●	●	MRX...-16..	
 General purpose		RDMT 0803M0ER-GM	8	3.18	3	4	15	●	●	●	●	MRX...-08..	
		RPMT 10T3M0ER-GM	10	3.97	3.5	5	11	●	●	●	●	MRX...-10..	
		RPMT 1204M0ER-GM	12	4.76	4.6	6	11	●	●	●	●	MRX...-12..	
		RPMT 1605M0ER-GM	16	5.56	5.8	8	11	●	●	●	●	MRX...-16..	
 Low cutting force		RDGT 0803M0ER-SM	8	3.18	3	4	15	●	●	●	●	MRX...-08..	
		RPMT 10T3M0ER-SM	10	3.97	3.5	5	11	●	●	●	●	MRX...-10..	
		RPMT 1204M0ER-SM	12	4.76	4.6	6	11	●	●	●	●	MRX...-12..	
		RPMT 1605M0ER-SM	16	5.56	5.8	8	11	●	●	●	●	MRX...-16..	
 Tough edge		RDMT 0803M0EN-GH	8	3.18	3	4	15	●	●	●	●	MRX...-08..	
		RPMT 10T3M0EN-GH	10	3.97	3.5	5	11	●	●	●	●	MRX...-10..	
		RPMT 1204M0EN-GH	12	4.76	4.6	6	11	●	●	●	●	MRX...-12..	
		RPMT 1605M0EN-GH	16	5.56	5.8	8	11	●	●	●	●	MRX...-16..	

Handed insert shows Right-hand

Recommended cutting conditions M261

Classification of usage

- ★ : Roughing / 1st Choice
- ☆ : Roughing / 2nd Choice
- : Finishing / 1st Choice
- : Finishing / 2nd Choice
- (In case hardness is 45HRC or under)

Carbon steel / Alloy steel	★	☆			P
Mold and die steel	★	☆			P
Austenitic stainless steel		☆	★		M
Martensitic stainless steel	★		☆		M
Precipitation hardening stainless steel			★		M
Gray cast iron	★				K
Nodular cast iron	★				K
Non-ferrous metals					N
Heat-resistant alloy	★		☆		S
Titanium alloy			★		S
Hard materials					H

- M
- Milling
- Cutting edge angle 45°~70°
- Cutting edge angle 75°
- Cutting edge angle 88°/90°
- Cutter for Finishing
- High Feed Cutter
- Multi-Function
- Slot Mill
- Ball-nose Radius
- Others

● : Standard item R : Right-hand only L : Left-hand only □ : Check availability

M260

Recommended cutting conditions

Workpiece material	Recommended chipbreaker (fz: mm/t)				Recommended insert grades (Vc: m/min)			
	* RD**08 type: ap=2mm, RP**10 type: ap=2.5mm RP**12 type: ap=3mm, RP**16 type: ap=4mm				MEGACOAT NANO			CVD Coated carbide
	RDMT-GM RPMT-GM	RDGT-GM RPGT-GM	RDGT-SM RPGT-SM	RDMT-GH RPMT-GH	PR1535	PR1525	PR1510	CA6535
Carbon steel	★ 0.1~0.2-0.3	☆ 0.1~0.2-0.3	☆ 0.06~0.15-0.2	☆ 0.15~0.3-0.35	☆ 120~180-250	★ 120~180-250	-	-
Alloy steel	★ 0.1~0.2-0.3	☆ 0.1~0.2-0.3	☆ 0.06~0.15-0.2	☆ 0.15~0.3-0.35	☆ 100~160-220	★ 100~160-220	-	-
Mold steel	★ 0.1~0.15-0.25	☆ 0.1~0.15-0.25	☆ 0.06~0.12-0.2	☆ 0.15~0.2-0.3	☆ 80~140-180	★ 80~140-180	-	-
Stainless steel (Austenitic related)	☆ 0.1~0.15-0.2	☆ 0.1~0.15-0.2	★ 0.06~0.12-0.2	☆ 0.15~0.2-0.25	★ 100~160-200	☆ 100~160-200	-	-
Stainless steel (Martensitic related)	☆ 0.1~0.15-0.2	☆ 0.1~0.15-0.2	★ 0.06~0.12-0.2	☆ 0.15~0.2-0.25	☆ 150~200-250	-	-	★ 180~240-300
Stainless steel (Precipitation Hardening)	☆ 0.1~0.15-0.2	★ 0.1~0.15-0.2	☆ 0.06~0.12-0.2	☆ 0.15~0.2-0.25	★ 90~120-150	-	-	-
Gray cast iron	★ 0.1~0.2-0.3	☆ 0.1~0.2-0.3	-	☆ 0.15~0.3-0.35	-	-	★ 120~180-250	-
Nodular cast iron	★ 0.1~0.15-0.25	☆ 0.1~0.15-0.25	-	☆ 0.15~0.2-0.3	-	-	★ 100~150-200	-
Ni-base heat-resistant alloys	☆ 0.1~0.12-0.15	★ 0.1~0.12-0.15	☆ 0.06~0.1-0.15	☆ 0.12~0.15-0.2	☆ 20~30-50	-	-	★ 20~30-50
Titanium alloys	☆ 0.1~0.12-0.15	☆ 0.1~0.12-0.15	★ 0.06~0.1-0.15	-	★ 40~60-80	-	☆ 30~50-70	-

* Machining with coolant is recommended for Ni-base heat-resistant alloys and titanium alloys. ★: 1st Recommendation ☆: 2nd Recommendation
 * RDGT/RPGT are recommended for stainless steel, Ni-base heat-resistant alloys and titanium alloy.
 * The bold-faced number indicates a center value of recommended cutting condition. Adjust the cutting speed and the feed rate within the above conditions according to the actual machining situation.
 * Recommended feed rate in the table is the reference value when ap is RE/2. (2 mm for RD**08/2.5 mm for RP**10/3mm for RP**12/4 mm for RP**16)
 * For other ap, calculate the recommended feed rate based on the conversion factor below.
 * For MRX16-S16-08-2T(-160), MRX16-W-08-2T, MRX20-S20-10-2T(-180) and MRX20-W20-10-2T, set the feed rate not higher than 50% of the recommended cutting conditions.

Conversion factor for feed per tooth by depth of cut (ap)

Insert	Max. ap	Conversion factor for feed per tooth fz									
		ap=0.5 mm	ap=1 mm	ap=1.5 mm	ap=2 mm	ap=2.5 mm	ap=3 mm	ap=4 mm	ap=5 mm	ap=6 mm	ap=8 mm
RD**08 type (GM/SM/GH chipbreaker)	4mm	1.7	1.3	1.1	1 (Standard)	0.9	0.8	0.8	-	-	-
RP**10 type (GM/SM/GH chipbreaker)	5mm	1.9	1.4	1.2	1	1 (Standard)	0.9	0.8	0.8	-	-
RP**12 type (GM/SM/GH chipbreaker)	6mm	2.1	1.5	1.3	1.1	1 (Standard)	0.9	0.8	0.8	0.8	-
RP**16 type (GM/SM/GH chipbreaker)	8mm	2.4	1.7	1.4	1.3	1.1	1.1 (Standard)	0.9	0.8	0.8	0.8

* Example (ROMU12 type, carbon steel, GM chipbreaker, ap=1mm)

$$\begin{matrix} fz=0.2 \text{ mm/t} \\ \text{(Reference value for carbon steel and GM chipbreaker)} \end{matrix} \times \begin{matrix} 1.5 \\ \text{(Conversion factor for ROMU12 type, ap=1mm)} \end{matrix} = \begin{matrix} fz=0.3 \text{ mm/t} \\ \text{(Recommended feed rate)} \end{matrix}$$

Recommended cutting conditions for drilling/ramping/helical milling

Tool spec.		Max. ap	Drilling		Ramping (Slant milling)			Helical milling		
Insert	Tool dia.		ap	Max. cutting depth Pd	Min. Cutting length X for flat bottom surface	Max. ramping angle RMPX	tan RMPX	Cutting length L at max. ramping angle	Min. cutting dia. øDh1	Min. cutting dia. for flat bottom facing øDh2
RD**08 type	16	4	0.7	9	8°	0.141	28	20	24	30
	20			13	9°	0.158	25	26	32	38
	25			18	5°	0.087	45	36	42	48
RP**10 type	20	5	0.6	11	5°	0.087	57	26	30	38
	25			16	10°	0.176	28	33	40	48
	32			23	6°	0.105	47	47	54	62
	40			31	4°	0.070	71	63	70	78
	50			41	3°	0.052	95	83	90	98
	63			54	2°	0.035	143	109	116	124
RP**12 type	32	6	2.4	21	9°	0.158	37	43	52	62
	40			29	5°	0.087	68	59	68	78
	50			39	4°	0.070	85	79	88	98
	63			52	2°	0.035	171	105	114	124
	80			139				148	158	
	100			179				188	198	
RP**16 type	40	8	3.4	25	11°	0.194	41	51	64	78
	50			35	7°	0.123	65	71	84	98
	63			48	4°	0.070	114	97	110	124
	80			65	3°	0.052	152	131	144	158
	100			85	2°	0.035	229	171	184	198
	125			110	1°	0.017	458	221	234	248

* Above is the value considering the clearance 1mm between the tool body and the workpiece.

Unit: mm



Milling

Guide for drilling

Depth of drilling

Refer to max. cutting depth (Pd) shown in the lower table of M261. (Pd Shows the maximum plunge depth.)

When traversing after drilling

1. Reduce the table feed by 50% until the center core part (do not forget to grind) is completely cut off.
(The internal cutting edge's radial rake angle is large in the negative direction)
2. The min. cutting length "X" for flat bottom surface is as follows M261.

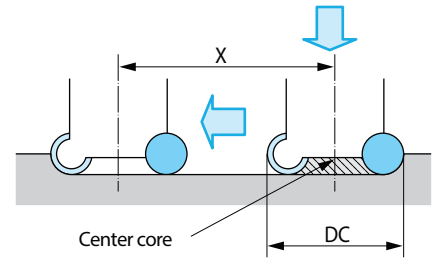

Guide for ramping (Slant milling)

- Ramping angle should be RMPX (Maximum ramping angle) or under in the above cutting conditions.
- Feed rate should be 70% or under of the above cutting conditions.

Formula of the cutting length "L" at max. ramping angle

$$L = \frac{ap}{\tan RMPX}$$

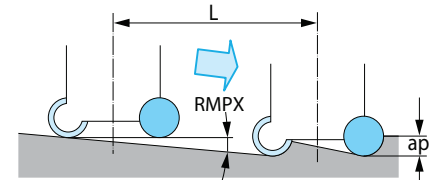

Guide for helical milling

- Sinking depth (h) per revolution when helical milling should be max. ap or under in the above cutting conditions.
- Ramping angle (with trajectory of the center line of tool) should be RMPX (Maximum ramping angle) or under in the above cutting conditions.
- Feed rate should be 70% or under of the above cutting conditions.
- Down-cut machining is recommended.

Helical milling factors

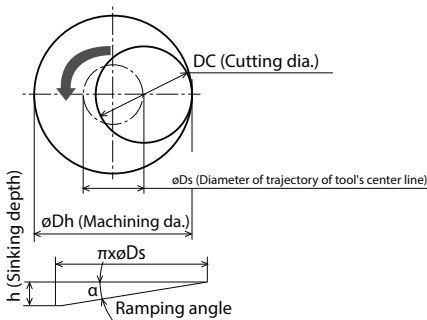

ϕD_s (How to find diameter of trajectory of tool's center line)
 $\phi D_s = \phi D_h - DC$

Formula for sinking depth (h)
 $h = \pi \times \phi D_s \times \tan \alpha$
(h should be ap or under)
(α should be RMPX or under)

[When cutting dia. $\phi D_h1 \leq \phi D_h < \phi D_h2$]

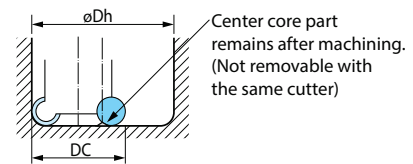

[When cutting dia. $\phi D_h2 \leq \phi D_h \leq \phi D_h3$]

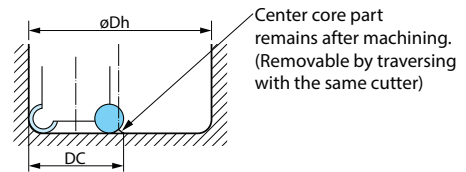

Please refer to M261 the list for $\phi D_h1 \sim Dh3$.

Max. ap and usable edges

Usable edges	Insert corner-R (mm)			
	R4	R5	R6	R8
3 edges	ap=2.0~4.0	ap=2.5~5.0	ap=3.0~6.0	ap=4.0~8.0
6 edges	ap=2.0 Less than	ap=2.5 Less than	ap=3.0 Less than	ap=4.0 Less than

Case studies

X5CrNi18 10

- Nozzle parts
- Vc = 113m/min
- ap x ae = 1.0 x 65mm
- fz = 0.14mm/t
- Dry
- MRX100R-12-9T-M (9 flutes)
- RPGT1204M0ER-SM (PR1535)

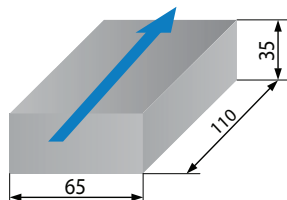

4.5 times longer tool life

X40CrMoV51 (47~49HRC)

- Mold part
- Vc = 125m/min
- ap x ae = 1.0~2.0x 10mm
- fz = 0.25mm/t
- Dry
- MRX20-S20-08-2T (2 flutes)
- RDGT0803M0ER-GM (PR1525)

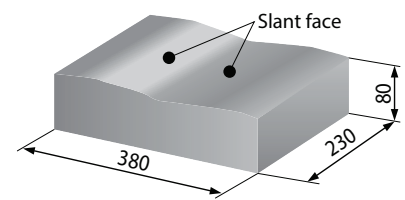

More than double tool life

PR1535

450 pcs/edge

Conventional

100 pcs/edge

• High cost efficiency with 4.5 times longer tool life and 1.5 times more insert edges.
• MRX prevented burr formation and improved surface finish.

(User evaluation)

PR1525

2 pcs and more Stable tool life

Conventional

1 pc unstable tool life

• Conventional tool machined only 1 pc of workpiece due to unstable tool life, but MRX doubled the tool life with stable machining.

(User evaluation)

MCSE

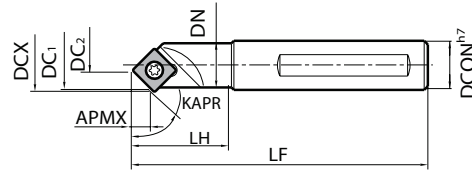

Fig. 1

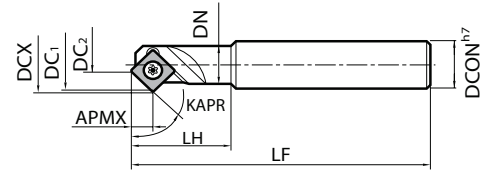

Fig. 2

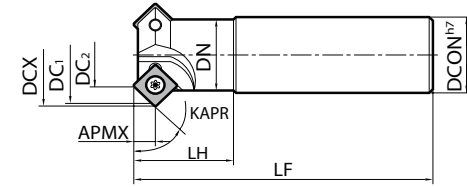

Fig. 3

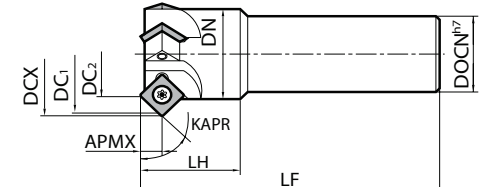

Fig. 4

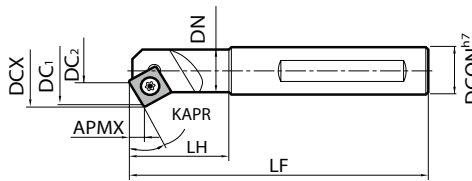

Fig. 5

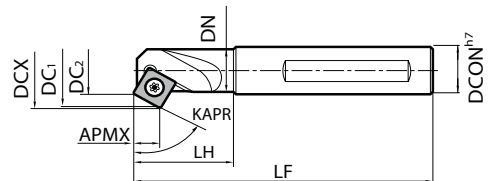

Fig. 6

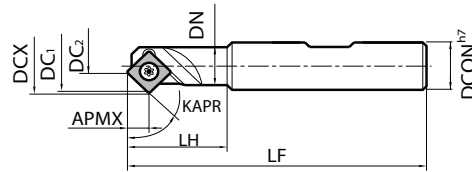

Fig. 7

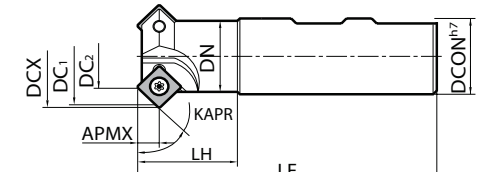

Fig. 8

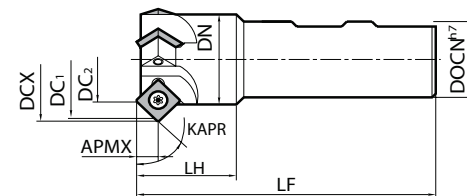





Fig. 9

M





Milling

Toolholder dimensions

Description	Availability	Inserts	Dimension (mm)								Standard corner-R(RE)	KAPR (°)	A.R. (°)	R.R. (°)	Coolant hole	Fig.	Spare parts			Applicable inserts ➔ M264													
			DCX	DC1	DC2	DCON	LF	LH	APMX	DN							Screw	Wrench	Wrench														
																																	
MCSE 104	●	1	16	15	4	16	85	31	6.5	15	0.4	45	0	-4.5	No	1	SB-3060TR	DT-10	-	SDKW09T2... SDMT09T204C													
MCSE 106	●	1	22	21	6	20	121	41	8.6	16	0.8						0	-1	No	2	SB-5090TR	-	LTW-20	SEKW1203... SEMT120304C									
MCSE 115	●	1	31	30	15																				18								
MCSE 227	●	2	43	42	27	30	32	110	41	6.3															0.8	0	+5	No	2	SB-5090TR	-	LTW-20	SEKW1203... SEMT120304C
MCSE 336	●	3	52	51	36	38																											
MCSE 106-W	□	1	22	21	6	20	92	40	8.6	16		0.8	45	0	-1	No																	
MCSE 115-W	□	1	31	30	15	20	92	40	8.6	18	0.8	45	0	+5	No	7	SB-5090TR	-	LTW-20	SEKW1203... SEMT120304C													
MCSE 104-30D	●	1	19	18	4	16	85	31	4.7	15	0.4	30	0	-4	No	5	SB-3060TR	DT-10	-	SDKW09T2... SDMT09T204C													
MCSE 108-30D	●	1	28	27	8	20	110	41	6.3	19	0.8						0	-2.5	No	5	SB-5090TR	-	LTW-20	SEKW1203... SEMT120304C									
MCSE 110-30D	●	1	30	28	10																				120	40	18						
MCSE 108-60D	●	1	19.5	19	8	20	110	41	10	19		0.8	60	0	-3.5	No									6	SB-5070TR	-	LTW-20	SEKW1203... SEMT120304C				
MCSE 120-60D	●	1	31	30	20	20	120	40	18	18		0.8	60	0	0	No									6	SB-5090TR	-	LTW-20	SEKW1203... SEMT120304C				

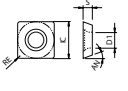
SDKW/SDMT/SEKW/SEMT

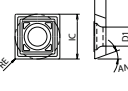
Insert	Description	Dimension (mm)		Angle (°)	Carbide		Cermef	Applicable toolholder ➔ M264
		IC	S		PVD	-		
		PR1225	PR1825		KW10	TN 100M		
 	SDKW 09T204FN	9.525	2.78	3.4	0.4	15	●	MCSE104-30D MCSE104
	SDKW 09T204TN	9.525	2.78	3.4	0.4	15	● ● ●	MCSE104-30D MCSE104
	SEKW 120304FN 120308FN	12.7	3.18	5.5	0.4 0.8	20	● ● ●	MCSE106(-W), MCSE108-..D MCSE110-30D, MCSE115(-W) MCSE120-60D, MCSE227(-W) MCSE336(-W)
	SEKW 120304TN 120308TN	12.7	3.18	5.5	0.4 0.8	20	● ● ● ● ●	MCSE106(-W), MCSE108-..D MCSE110-30D, MCSE115(-W) MCSE120-60D, MCSE227(-W) MCSE336(-W)
  <p>Low cutting force</p>	SDMT 09T204C	9.525	2.78	3.4	0.4	15	● ● ● ● ●	MCSE104-30D MCSE104
	SEMT 120304C	12.7	3.18	5.5	0.4	20	● ● ● ● ●	MCSE106(-W), MCSE108-..D MCSE110-30D, MCSE115(-W) MCSE120-60D, MCSE227(-W) MCSE336(-W)

Recommended cutting conditions ➔ M265

● : Standard item R : Right-hand only L : Left-hand only □ : Check availability

M264

M

Milling

Cutting edge angle 45°~70°

Cutting edge angle 75°

Cutting edge angle 88°/90°

Cutter for Finishing

High Feed Cutter



Multi-Function

Slot Mill

Ball-nose Radius

Others

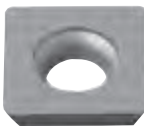
Applicable inserts

Description		Applicable inserts  M264		
				
MCSE	104 104-30D	SDKW 09T204TN	SDKW 09T204FN	SDMT 09T204C
MCSE	106 115 227 336	SEKW 120304TN 120308TN	SEKW 120304FN 120308FN	SEMT 120304C
MCSE	108-30D 110-30D			
MCSE	108-60D 120-60D			

Recommended cutting conditions

Workpiece material	fz (mm/t)		Recommended insert grades (Vc: m/min)		
			Cermet	MEGACOAT	Carbide
	DC ₂ (ø4~ø20)	DC ₂ (ø27~ø36)	TN100M	PR1225	KW10
Carbon steel	0.05~0.25	0.2~0.4	★ 100~180	★ 120~250	-
Alloy steel	0.05~0.25	0.2~0.4	★ 100~180	★ 100~220	-
Mold steel	0.05~0.25	0.2~0.4	★ 100~150	★ 80~180	-
Stainless steel	0.05~0.2	0.1~0.3	☆ 100~180	★ 120~220	-
Cast iron	0.1~0.3	0.3~0.5	-	-	☆ 80~150
Non-ferrous metals	0.1~0.3	0.3~0.5	-	-	★ 100~300

★: 1st Recommendation ☆: 2nd Recommendation



Milling

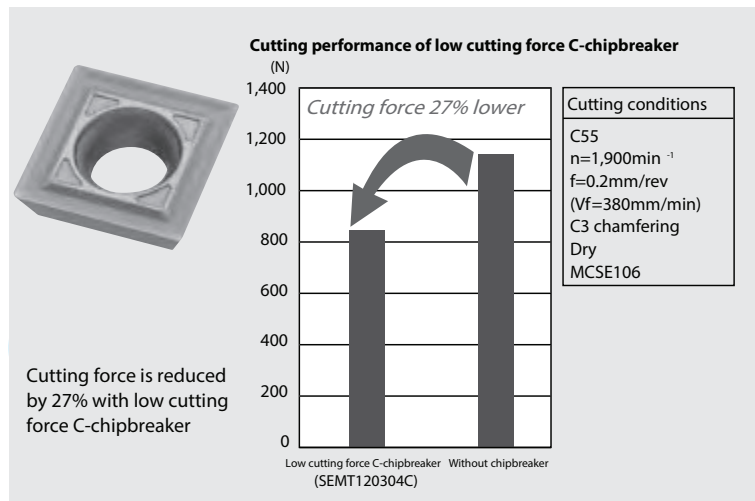
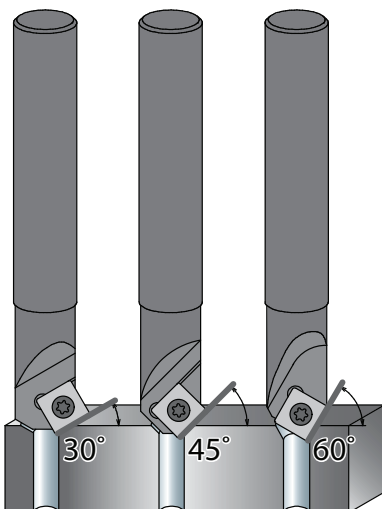

MEF

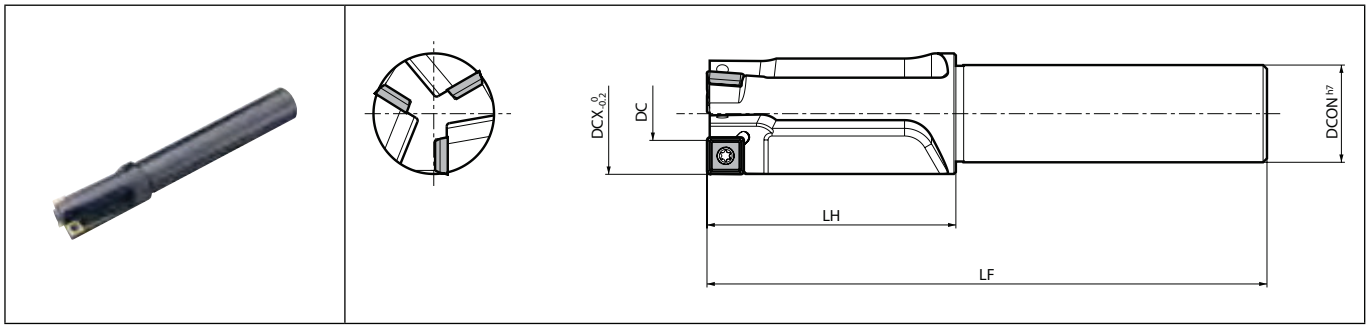

Toolholder dimensions

Description	Availability	Inserts	Dimension (mm)					Standard corner-R(RE)	A.R. (°)	R.R. (°)	Objective bolt size	Spare parts		Applicable inserts M267
			DC	DCX	DCON	LF	LH					Screw	Wrench	
			Coolant hole		Screw		Wrench							
MEF 11-S10 14-S12 17-S16 18-S16 20-S16 22-S20 23-S20 24-S20 25-S20	●	1	3	11	10	103	23	0.4	+5	-13	M6	SB-2250TR	DT-7	SPMT060204E-Z SPMT060208E-Z
	●		4.5	14	12	108	28				M8			
	●		7.3	17.5	11	115	35				M10			
	●	2	7.7	18	16	117	38			-	No	SB-2260TR	DT-7	
	●		9.5	20	120	40	M12							
	●		11.4	22	124	44	-							
	●	3	12.4	23	20	126	46			-12	M14	-		
	●		13.4	24	128	48	-							
	●		14.4	25	130	50	-							
MEF 26-S25 27-S25 28-S25 29-S25 30-S25 32-S25 35-S32 39-S32 43-S32 48-S32	●	3	9.8	26	25	132	52	0.8	+5	-13	M16	SB-3080TR	DT-10	SPMT090304E-Z SPMT090308E-Z
	●		10.6	27	134	54	-							
	●		11.5	28	136	56	-							
	●	4	12.6	29	138	58	-			No	SB-3080TR	DT-10		
	●		13.5	30	140	60	M18							
	●		15.5	32	144	64	-							
	●	4	18.4	35	32	150	70			-	M20	-		
	●		22.5	39	158	78	M22							
	●		26.2	43	166	86	M24							
	●	4	31.3	48	176	96	-			M27	-			
	●		31.3	48	176	96	M30							

Although Corner-R(RE) pertains to MEF11-S10, DC = 3.0 mm.

M

Milling

Cutting edge angle 45°~70°

Cutting edge angle 75°

Cutting edge angle 88°/90°

Cutter for Finishing

High Feed Cutter

Multi-Function

Slot Mill

Ball-nose Radius

Others

● : Standard item R : Right-hand only L : Left-hand only □ : Check availability

M266

SPMT

Classification of usage		Carbon steel / Alloy steel		★		P	
		Mold and die steel		★			
★: Roughing / 1st Choice ☆: Roughing / 2nd Choice ■: Finishing / 1st Choice □: Finishing / 2nd Choice (In case hardness is 45HRC or under)		Stainless steel		★		M	
		Gray cast iron		★ ☆		K	
Insert		Description		■		N	
		Heat-resistant alloy		★		S	
Titanium alloy		★ ☆				H	
		Hard materials		□			
Dimension (mm)		Angle (°)		Carbide		Applicable toolholder ➡ M266	
		IC S D1 RE AN		PVD -			
SPMT 060204E-Z 060208E-Z		6.35 2.38 2.5 0.4 0.8 11		● ● ●		MEF(11~25)-S..	
		9.525 3.18 3.4 0.4 0.8 11		● ● ●		MEF(26~48)-S..	

Recommended cutting conditions ➡ M267

Bolt countersink (Hexagon socket head cap screw)

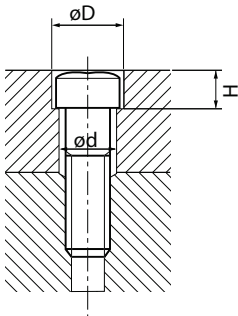

Nominal screw size	M6	M8	M10	M12	M14	M16	M18	M20	M22	M24	M27	M30
øD (mm)	11	14	17.5	20	23	26	29	32	35	39	43	48
H (mm)	6.5	8.6	10.8	13	15.2	17.5	19.5	21.5	23.5	25.5	29	32
ød (mm)	6.6	9	11	14	16	18	20	22	24	26	30	33
Applicable end mill	MEF11	MEF14	MEF17	MEF20	MEF23	MEF26	MEF29	MEF32	MEF35	MEF39	MEF43	MEF48



Milling

Recommended cutting conditions

Workpiece material	fz (mm/t)	Recommended insert grades (Vc: m/min)		
		MEGACOAT		Carbide
		PR1225	PR1210	KW10
Carbon steel	0.1~0.15	★ 120~220	-	-
Alloy steel	0.1~0.15	★ 120~220	-	-
Mold steel	0.05~0.1	★ 100~180	-	-
Stainless steel	0.05~0.1	★ 80~180	-	-
Cast iron	0.1~0.2	-	★ 100~220	☆ 80~120
Non-ferrous metals	0.1~0.2	-	-	★ 100~300

★: 1st Recommendation ☆: 2nd Recommendation

●: Standard item R: Right-hand only L: Left-hand only □: Check availability

Points at bolt countersinking

1. Carbon steel

Increase the feed rate to **fz=0.1 ~ 0.15 (mm/t)** for preventing long chips at low feed rates.

Chip control is good when setting (**Vc=80m/min**) for **MEF11~MEF25**, and (**Vc=120m/min**) for **MEF26~MEF48**.

Toolholder description	Vc(m/min)	fz(mm/t)
MEF11~MEF25	80	0.1~0.15
MEF26~MEF48	120	0.1~0.15

2. Sticky materials

Step feed is recommended for good chip control

Increase the feed rate to **fz=0.1 ~ 0.15 (mm/t)** for preventing long chips at low feed rate (**fz=0.05mm/t**).

Use cover to prevent accidents or injury by thick chips at higher feed rates.

Toolholder description	Vc(m/min)	fz(mm/t)	Step feed (mm)
MEF11~MEF48	80~150	0.1~0.15	0.5~1.5

3. Stainless steel

Use a lower cutting speed. high cutting speeds cause chattering.

Cutting performance when shouldering

MEF bolt countersink end mill is also recommended of shouldering.

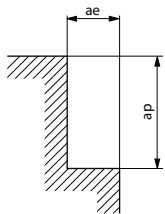

Vc=80~120m/min

C55

Dry

Overhang length:
Same as LH in the dimension table

- When shouldering, both side edge and bottom edges function.
- Both edges wear at the same time depending on ap. The insert uses 2 edges instead of 4. (Fig. 1)

- MEF type's side edge is designed to have a slight clearance for the countersinking. Therefore, worked side wall is approx. 1° inclined against the vertical face. (Fig. 2)

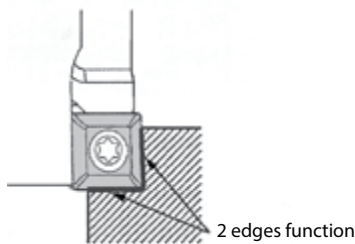

Fig. 1

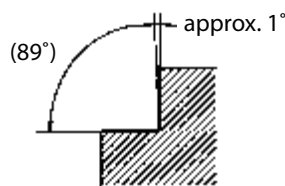

Fig. 2

Description	Cutting range
MEF11-S12 MEF14-S12 MEF17-S16 MEF18-S16	
MEF20-S16 MEF22-S20 MEF25-S20	
MEF26-S25 MEF32-S25 MEF35-S32	
MEF39-S32 MEF43-S32 MEF48-S32	

M



Milling

Cutting edge angle 45°~70°

Cutting edge angle 75°

Cutting edge angle 88°/90°

Cutter for Finishing

High Feed Cutter

Multi-Function

Slot Mill

Ball-nose Radius

Others

METS

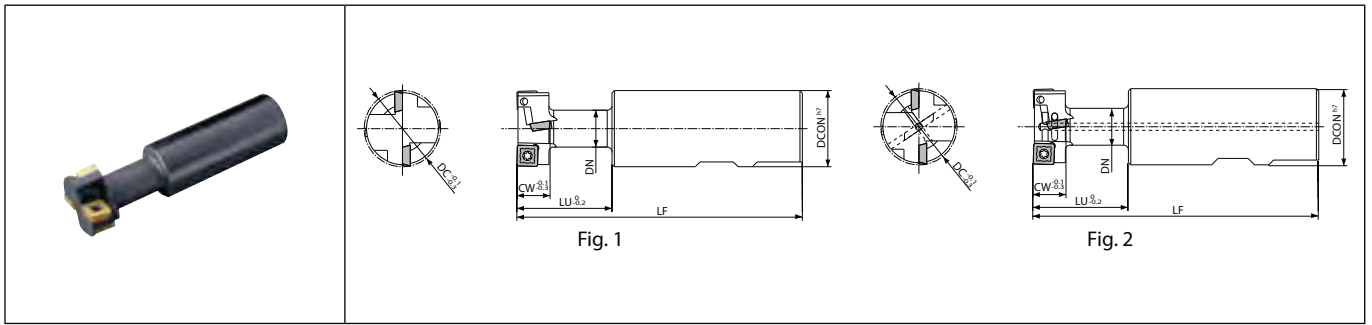

Toolholder dimensions

Description	Availability	Inserts	Flutes	Dimension (mm)						A.R. (°)	R.R. (°)	Coolant hole	Fig.	Spare parts		Applicable inserts M270
				DC	DCON	LF	LU	CW	DN					Screw	Wrench	
METS 21-S25 25-S25 32-S32 40-S32 50-S32	●	2	1	21	25	109	29	9	10.5	-10	No	1	SB-2560TR	DT-8	SDMT060304E-K	
	●			25		112	32	11	12.5			1				
	●	4	2	32		120	38	14	15.5	+9		1	SB-3060TR	DT-10	SDMT080308E-K	
	●			40	32	130	50	18	20.5			1	SB-4085TR	DT-15	SDMT120408E-K	
	●			50		140	60	22	26.5			1				
METS 21-S25-H 25-S25-H 32-S32-H 40-S32-H 50-S32-H	●	2	1	21	25	109	29	9	10.5	-10	Yes	2	SB-2560TR	DT-8	SDMT060304E-K	
	●			25		112	32	11	12.5			2	SB-3060TR	DT-10	SDMT080308E-K	
	●	4	2	32		120	38	14	15.5	+9		2	SB-4085TR	DT-15	SDMT120408E-K	
	●			40	32	130	50	18	20.5			2				
	●			50		140	60	22	26.5			2				

METS...-H has air holes

JIS standard of T-slot (Extracted from B0952)

(Unit: mm)

A (Nominal size)	B	C	H	
			Max.	Min.
12	19 ⁺² ₀	8 ⁺¹ ₀	25	20
14	23 ⁺² ₀	9 ⁺² ₀	28	23
18	30 ⁺² ₀	12 ⁺² ₀	36	30
22	37 ⁺³ ₀	16 ⁺² ₀	45	38
28	46 ⁺⁴ ₀	20 ⁺² ₀	56	48

● : Standard item R : Right-hand only L : Left-hand only □ : Check availability



Milling

SDMT

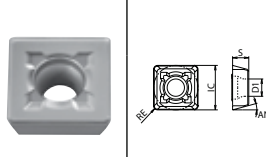
Insert		Description	Dimension (mm)				Angle (°)	Carbide			Applicable toolholder ➔ M269
			IC	S	D1	RE		AN	PVD		
							-		-	-	
		SDMT 060304E-K	6.35	3.18	2.8	0.4	15	●	●	●	METS21-S25(-H) METS25-S25(-H)
		SDMT 080308E-K	8	3.18	3.4	0.8	15	●	●	●	METS32-S32(-H)
		SDMT 120408E-K	12.7	4.76	4.4	0.8	15	●	●	●	METS40-S32(-H) METS50-S32(-H)

Recommended cutting conditions ➔ M271

Classification of usage

- ★ : Roughing / 1st Choice
- ☆ : Roughing / 2nd Choice
- : Finishing / 1st Choice
- : Finishing / 2nd Choice

(In case hardness is 45HRC or under)

Carbon steel / Alloy steel	★		P
Mold and die steel	★		P
Stainless steel	★		M
Gray cast iron	★	☆	K
Nodular cast iron	★		K
Non-ferrous metals		★	N
Heat-resistant alloy		★	S
Titanium alloy	★	☆	S
Hard materials		□	H



- Cutting edge angle 45°~70°
- Cutting edge angle 75°
- Cutting edge angle 88°/90°
- Cutter for Finishing
- High Feed Cutter
- Multi-Function
- Slot Mill
- Ball-nose Radius
- Others

Recommended cutting conditions

Workpiece material	fz (mm/t)	Recommended insert grades (Vc: m/min)		
		MEGACOAT		Carbide
		PR1230	PR1210	KW10
Carbon steel	0.1~0.15	★ 100~200	-	-
Alloy steel	0.08~0.12	★ 100~200	-	-
Mold steel	0.05~0.1	★ 80~150	-	-
Cast iron	0.1~0.15	-	★ 100~200	☆ 80~120
Non-ferrous metals	0.1~0.15	-	-	★ 100~300

★: 1st Recommendation ☆: 2nd Recommendation

Description (T-Slot nominal size)	Steel			Cast iron		
	Groove shape at pre-process	T-Slotting conditions	Conditions to prevent chattering	Groove shape at pre-process	T-Slotting conditions	Conditions to prevent chattering
METS21-S25(-H) (Nominal size 12)	C=1~3mm 	Vc= 120 fz= 0.1 (n= 1,820) (Vf= 182)	Vc= 60 fz= 0.15 (n= 920) (Vf= 137)	C=1mm and over 	Vc= 120 fz= 0.12 (n= 1,820) (Vf= 218)	Vc= 80 fz= 0.15 (n= 1,210) (Vf= 182)
METS25-S25(-H) (Nominal size 14)	C=1~3mm 	Vc= 120 fz= 0.1 (n= 1,530) (Vf= 306)	Vc= 60 fz= 0.15 (n= 760) (Vf= 228)	C=1mm and over 	Vc= 120 fz= 0.12 (n= 1,530) (Vf= 367)	Vc= 80 fz= 0.15 (n= 1,020) (Vf= 306)
METS32-S32(-H) (Nominal size 18)	C=1~3mm 	Vc= 100 fz= 0.1 (n= 1,000) (Vf= 200)	Vc= 60 fz= 0.15 (n= 600) (Vf= 180)	C=1mm and over 	Vc= 120 fz= 0.12 (n= 1,190) (Vf= 286)	Vc= 80 fz= 0.15 (n= 800) (Vf= 240)
METS40-S32(-H) (Nominal size 22)	C=9mm 	Vc= 80 fz= 0.15 Chattering is likely when set to shallower than C=9mm.	Vz= 60 fz= 0.15 (n= 480) (Vf= 144)	C=9mm and over 	Vc= 120 fz= 0.15 (n= 960) (Vf= 228)	Vc= 80 fz= 0.15 (n= 640) (Vf= 192)
METS50-S32(-H) (Nominal size 28)	Not recommended for steel because of chattering				Vc= 120 fz= 0.15 (n= 760) (Vf= 228)	Vc= 80 fz= 0.15 (n= 510) (Vf= 153)

Cutting speed: Vc(m/min), Revolution: n(min⁻¹), Feed rate fz(mm/t), Table feed Vf(mm/min)

Chattering is likely when fz is less than fz=0.1mm/t. Keep feed rate between fz=0.1 ~ 0.15mm/t.

How to prevent damaging chips when steel machining

Before Improvement (Deep Groove at Pre-Process)

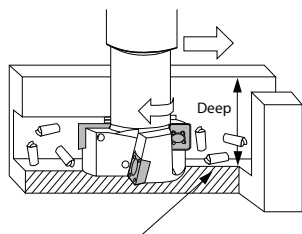

Chips stay in the pre-process groove.

After Improvement (Shallow Groove at Pre-Process)

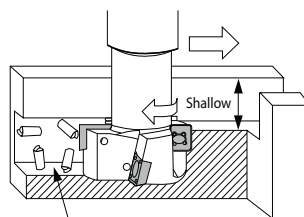

Chips are evacuated backward and chances of damaging chips are less.

Improvement of
chip biting

Make pre-process groove shallower to prevent the tool damage from chips.
Use compressed air to aid in chip evacuation.



Milling

MGI

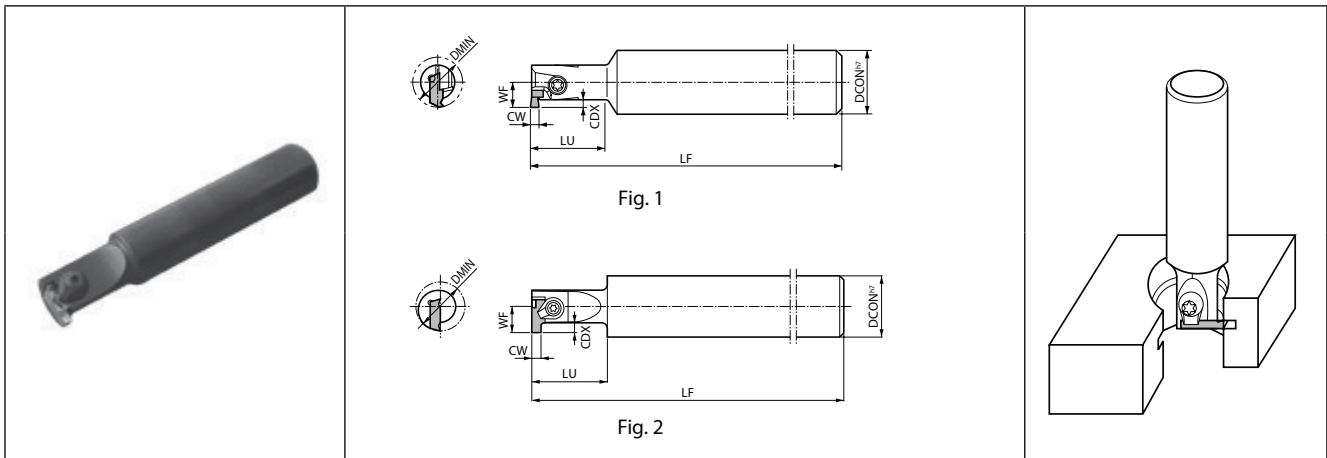

Toolholder dimensions

Description	Availability	Dimension (mm)									Coolant hole	Fig.	Spare parts					Applicable inserts ➔ M273
		DMIN	DCON	LF	LU	CDX	WF	CW		Clamp set			Clamp set	Screw	Wrench	Wrench		
								min.	max.									
MGI 1420-1SS	●	14	20	100	20	2.2	6.8	1	3	No	1	-	-	SB-4065TR	-	FT-15	GVR...-020SS	
MGI 1620-1S	●	16	20	110	25	2.2	7.8	1	3.4	No	1	-	-	SB-4085TR	-	FT-15	GVR...-020S	
MGI 2020-1A	●	20	20	110	30	2.2	9.8	1	3.4	No	2	CPS-5F	-	-	-	FT-15	GVR...-020A, GVR...-...AR	
MGI 2220-1B	●	22	20	110	30	2.8	11	1.45	4	No	2	CPS-5F	-	-	-	FT-15	GVR...-020B, GVR...-...BR	
MGI 3225-1C	●	32	25	120	35	5.5 (4.5)	16	2.8	4	No	2	-	CPS-6F	-	LW-3	-	GVR...-020C	

CDX shows available grooving depth.

GVR280-020C, GVR300-020C is available to the groove depth up to 4.5mm.

GVR430 ~ 500-020C can be installed to MGI3225-1C, but not recommended for steel machining because of toolholder's rigidity.

M



Milling

Cutting edge angle
45°~70°

Cutting edge angle
75°

Cutting edge angle
88°/90°

Cutter for
Finishing

High Feed
Cutter

Multi-
Function

Slot Mill



Ball-nose
Radius

Others

● : Standard item R : Right-hand only L : Left-hand only □ : Check availability

M272

GVR

Classification of usage		Carbon steel / Alloy steel										●	○	□	P		
		Stainless steel										●	○	□	M		
<ul style="list-style-type: none"> ● : Continuous ~Light interruption / 1st Choice ○ : Continuous ~Light interruption / 2nd Choice ● : Continuous / 1st Choice ○ : Continuous / 2nd Choice 		Gray cast iron										●	○	□	K		
		Non-ferrous metals										●	○	□	N		
		Titanium alloy										●	○	□	S		
		Hard materials (~ 40HRC)										●	○	□	H		
Hard materials (40HRC ~)																	
		Insert	Description	No. of edges	Dimension (mm)					Tolerance (mm)		Carbide				Cermet	Applicable toolholder
			CW	CDX	S	RE	INSL	W1	CW min.	CW max.	PVD	-	-		M272		
											PR1225	PR930	KW10	TC60	TC60		
 <p>1-edge</p>	GVR	100-020SS 125-020SS 145-020SS 200-020SS 250-020SS 300-020SS	1	1 1.25 1.45 2 2.5 3							●	●	●	●	●	M272, G86	
	GVR	100-020S 125-020S 145-020S 185-020S 200-020S 250-020S 340-020S	1	1 1.25 1.45 1.85 2 2.5 3.4	2.3	4	0.2	11	4	-0.03	+0.03	●	●	●	●	●	M272, G86
	GVR	100-020A 125-020A 145-020A 185-020A 200-020A 250-020A 300-020A 340-020A	2	1 1.25 1.45 1.85 2 2.5 3 3.4	2.3	5	0.2	12	4	-0.03	+0.03	●	●	●	●	●	M272, G86
	GVR	145-020B 185-020B 200-020B 230-020B 250-020B 280-020B 300-020B 340-020B 400-020B	2	1.45 1.85 2 2.3 2.5 2.8 3 3.4 4	2.8 2.8 3.2 3.2 3.2 3.2 4.2 4.2 4.2			15	4.5	-0.03	+0.03	●	●	●	●	●	M272, G86
	GVR	280-020C 300-020C 340-020C 400-020C (430-020C) (460-020C) (500-020C)	2	2.8 3 3.4 4 4.3 4.6 5	4.5 4.5 5.5 5.5 6.3 6.3 6.3	6.5	0.2	21	5.8	-0.03	+0.03	●	●	●	●	●	M272, G86
 <p>2-edge / Full R / Copying</p>	GVR	200-100AR 250-125AR 300-150AR	2	2 2.5 3	2.3	5	1 1.25 1.5	12	4	-0.03	+0.03	●	●	●	●	M272, G86	
	GVR	200-100BR 300-150BR	2	2 3	3.2 4.2	5.5	1 1.5	15	4.5	-0.03	+0.03	●	●	●	●	M272, G86	

CDX shows available grooving depth.
Right-hand shown

Recommended cutting conditions  M272

● : Standard item R : Right-hand only L : Left-hand only □ : Check availability



MVG

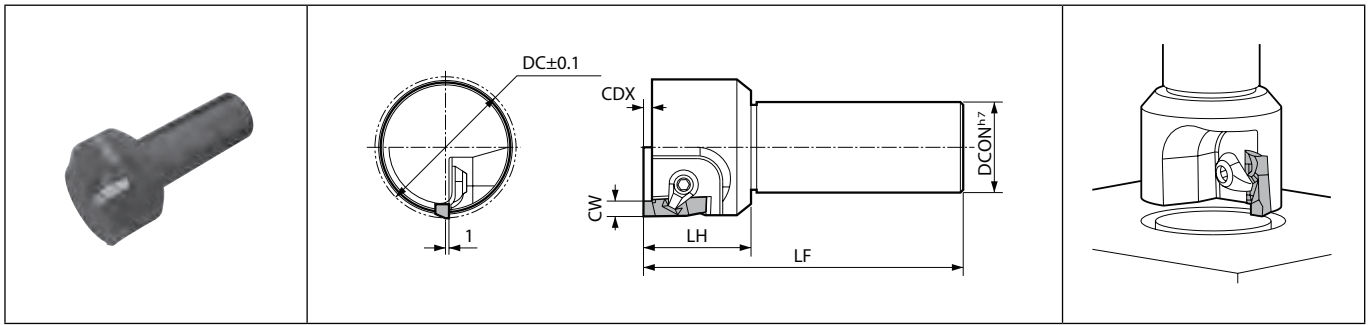

Toolholder dimensions

Description	Availability	Dimension (mm)							Coolant hole	Spare parts		Applicable inserts ➔ M274
		DC	DCON	LF	LH	CDX	CW min.	CW max.		Clamp set	Wrench	
MVG 3032	● 30	32	120	40	5.2	4	4.9	No	CPS-6V	LW-3	GVFR400-020B GVFR430-020B GVFR460-020B GVFR490-020B	
3532	● 35											
4032	● 40											
4532	● 45											
5032	● 50											
5532	● 55											
6032	● 60											

CDX shows available grooving depth.

M



Milling

GVFR

Classification of usage		Carbon steel / Alloy steel							Stainless steel		Gray cast iron		Non-ferrous metals		Titanium alloy		Hard materials (~40HRC)		Hard materials (40HRC ~)		Applicable toolholder ➔ M274
		●	☉	●	☉	●	☉	●	☉	●	☉	●	☉	●	☉	●	☉	●	☉		
Insert	Description	No. of edges	Dimension (mm)						Tolerance (mm)		Carbide		Cermet		Applicable toolholder ➔ M274						
			CW	CDX	S	RE	INSL	W1	CW min.	CW max.	PVD	-	-	-							
	GVFR 400-020B 430-020B 460-020B 490-020B	2	4	5.3	5	0.2	20	5.8	-0.03	+0.03	●	●	●	●	M274, G127						
			4.3								●	●	●	●							
			4.6								●	●	●	●		●					
			4.9								●	●	●	●		●					

CDX shows available grooving depth.
Right-hand shown

Recommended cutting conditions ➔ M275

● : Standard item R : Right-hand only L : Left-hand only ☐ : Check availability

M274

- Cutting edge angle 45°~70°
- Cutting edge angle 75°
- Cutting edge angle 88°/90°
- Cutter for Finishing
- High Feed Cutter
- Multi-Function
- Slot Mill
- Ball-nose Radius
- Others

MGI

Recommended cutting conditions

Workpiece material	fz (mm/t)	Recommended insert grades (Vc: m/min)				
		Cermet		MEGA COAT	PVD Coated carbide	Carbide
		TC40	TC60	PR1225	PR930	KW10
Carbon steel	0.05~0.15	☆ 120~200	☆ 100~180	★ 80~150	☆ 80~150	-
Alloy steel	0.05~0.15	☆ 120~200	☆ 100~180	★ 80~150	☆ 80~150	-
Mold steel	0.03~0.12	☆ 100~180	☆ 80~150	★ 60~130	☆ 60~130	-
Stainless steel	0.03~0.12	☆ 100~180	★ 80~150	★ 60~130	☆ 60~130	-
Cast iron	0.05~0.2	☆ 100~150	-	-	-	★ 80~150
Non-ferrous metals	0.05~0.2	-	-	-	-	★ 100~300

Use down-cut machining.

★: 1st Recommendation ☆: 2nd Recommendation

MVG

Recommended cutting conditions

Workpiece material	fz (mm/t)	Recommended insert grades (Vc: m/min)				
		Cermet		MEGACOAT	PVD coated carbide	Carbide
		TC40	TC60	PR1225	PR930	KW10
Carbon steel	0.05~0.15	★ 120~200	☆ 100~180	★ 80~170	☆ 80~150	-
Alloy steel	0.05~0.15	★ 120~200	☆ 100~180	★ 80~170	☆ 80~150	-
Mold steel	0.03~0.12	★ 100~180	☆ 80~150	★ 60~150	☆ 60~130	-
Stainless steel	0.03~0.12	☆ 100~180	☆ 80~150	★ 60~150	☆ 60~130	-
Cast iron	0.05~0.2	-	-	-	-	★ 80~150
Non-ferrous metals	0.05~0.2	-	-	-	-	★ 100~300

★1st Recommendation ☆2nd Recommendation

M



Milling

S-type inserts

Insert		Description	No. of edges	Dimension (mm)						Angle (°)		Carbide				Cermets	Applicable toolholder	
				IC	S	BCH	INSL	RE	BS	AN	AS	CVD	PVD	-	-			
												CA420M	PR1210	PR1225	KW10			TN100M
		<p>Classification of usage</p> <p>★ : Roughing / 1st Choice ☆ : Roughing / 2nd Choice ■ : Finishing / 1st Choice □ : Finishing / 2nd Choice (In case hardness is 45HRC or under)</p>																
		<p>Carbon steel / Alloy steel</p>																
		<p>Mold and die steel</p>																
		<p>Stainless steel</p>																
		<p>Gray cast iron</p>																
		<p>Nodular cast iron</p>																
		<p>Non-ferrous metals</p>																
		<p>Heat-resistant alloy</p>																
		<p>Titanium alloy</p>																
		<p>Hard materials</p>																
		<p>P</p>																
		<p>M</p>																
		<p>K</p>																
		<p>N</p>																
		<p>S</p>																
		<p>H</p>																
		SDKN 1203AUFN	4	12.7	3.18	0.5	-	-	1.2	15	23				●			
		SDKN 1203AUTN	4	12.7	3.18	0.5	-	-	1.2	15	23	●	●		●			
		SDKN 1504AUTN	4	15.875	4.76	0.5	-	-	1.2	15	23			●		●		
		SDKR 1203AUEN-S	4	12.7	3.18	0.5	-	-	1.7	15	23			●		●		
		SDMR 1203AUER-H	4	12.7	3.18			1	0.8	15	23			●				
		SEEN 1203AFTN	4	12.7	3.18	0.5	-	-	1.4	20	25					●		
		SEKN 1203AFFN	4	12.7	3.18	0.5	-	-	1.4	20	25				●			
		SEKN 1203AFTN	4	12.7	3.18	0.5	-	-	1.4	20	25	●	●		●			
		SEKN 1204AFTN	4	12.7	4.76	0.5	-	-	1.4	20	25			●				
		SEKN 1504AFTN	4	15.875	4.76	0.5	-	-	1.4	20	25			●				
		SEEN 1203AFFR-W	1	12.7	3.18	-	14.56	-	3.5	20	25				●			
		SEEN 1203AFTR-W	1	12.7	3.18	-	14.56	-	3.5	20	25					●		
		SEKN 1203EFTR	4	12.7	3.18	1.2	-	-	1.4	20	25					●		
		SEKR 1203AFEN-S	4	12.7	3.18	0.5	-	-	1.7	20	25			●		●		
		SEMR 1203AFER-H	4	12.7	3.18	-	-	1	1	20	25			●				

Handed insert shows Right-hand

● : Standard item R : Right-hand only L : Left-hand only □ : Check availability

SEEN-W inserts are sold in 5 piece boxes

M

Milling

Cutting edge angle 45°~70°

Cutting edge angle 75°

Cutting edge angle 88°/90°

Cutter for Finishing

High Feed Cutter

Multi-Function

Slot Mill

Ball-nose Radius

Others

S-type inserts

Insert		Description	Dimension (mm)					Angle (°)		Coating				Applicable toolholder			
			IC	S	BCH	RE	BS	AN	AS	Carbide					Cermet		
										CVD	PVD	-	-		-		
									CA420M	PR1210	PR1225	KW10	TN100M	TN60			
<p>Classification of usage</p> <ul style="list-style-type: none"> ★ : Roughing / 1st Choice ☆ : Roughing / 2nd Choice ■ : Finishing / 1st Choice □ : Finishing / 2nd Choice (In case hardness is 45HRC or under) 		SPCN 1203EDTR	12.7	3.18	-	1	2	11	15								P
		SPKN 1203EDER	12.7	3.18	1	-	1.6	11	15	●							M
		SPKN 1203EDFR	12.7	3.18	1	-	1.6	11	15					●			K
		SPKN 1203EDTR	12.7	3.18	-	1	2	11	15					●			N
		SPKN 1203EDTL	12.7	3.18	1	-	1	11	15	●					●		S
		SPKN 1504EDFR	15.875	4.76	1	-	2.2	11	15					●			H
SPKN 1504EDTR	15.875	4.76	1	-	2.2	11	15	●	●			●					
		SPEN 1203EEER	12.7	3.18	1	-	1.4	11	20	●							
		SPEN 1203EESR	12.7	3.18	1	-	1.4	11	20		●						
		SPCN 1203XPTR	12.7	3.18	-	1	2	11	11						●		
		SPKN 1203XPFR	12.7	3.18	1	-	2	11	11						●		
		SPKN 1203XPTR	12.7	3.18	-	1	2	11	11						●		
SPKN 1504XETR	15.875	4.76	1	-	2	11	20							●			
		SPCN 1904EETR1	19.05	4.76	0.7	-	1.2	11	20						●		
		SPKR 1203EDER-S	12.7	3.18	-	2	1	11	15				●				
		SPMR 1203EDER-H	12.7	3.18	-	1	2	11	15				●				
		SPGN 090304	9.525	3.18	-	0.4	-	11	-							●	
		0.8				●											
		SPGN 120304	12.7	3.18	-	0.4	-	11	-							●	
		0.8				●											
		SPMN 120308	12.7	3.18	-	0.8	-	11								●	
		1.2				●											
		SPMN 120408	12.7	4.76	-	0.8	-	11								●	
		1.2				●											

Handed insert shows Right-hand

● : Standard item R : Right-hand only L : Left-hand only □ : Check availability



S-type inserts

Insert		Description	No. of edges	Dimension (mm)					Angle (°)		Carbide			Applicable toolholder		
				IC	S	RE	BCH	BS	AN	AS	C4420M	PR1210	TN100M			
<p>Classification of usage</p> <p>★ : Roughing / 1st Choice ☆ : Roughing / 2nd Choice ■ : Finishing / 1st Choice □ : Finishing / 2nd Choice (In case hardness is 45HRC or under)</p>		Carbon steel / Alloy steel										■		P		
		Mold and die steel												■		P
		Stainless steel														M
		Gray cast iron										★ ☆				K
		Nodular cast iron										★ ☆				
		Non-ferrous metals														N
Heat-resistant alloy														S		
Titanium alloy										★						
Hard materials														H		
		SNCN 1204XNTN	8	12.7	4.76	-	2	2	-	-				●	-	
		SNKN 1204XNTN	8	12.7	4.76	-	2	2	-	-				●	-	
		SNMF 1204XNTN	8	12.7	4.76	-	2	2	-	-				●	-	
		SNMN 120408 120412 120424	8	12.7	4.76	0.8 1.2 2.4	-	-	-	-				● ● ●	-	

Handed insert shows Right-hand













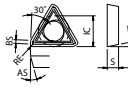

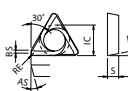

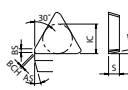

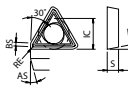
- Cutting edge angle 45°~70°
- Cutting edge angle 75°
- Cutting edge angle 88°/90°
- Cutter for Finishing
- High Feed Cutter
- Multi-Function
- Slot Mill
- Ball-nose Radius
- Others

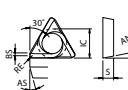
● : Standard item R : Right-hand only L : Left-hand only □ : Check availability

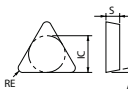
M278

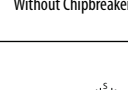
T type inserts





Insert		Description	No. of edges	Dimension (mm)					Angle (°)		Carbide		Cermet	Applicable toolholder
				IC	S	BCH	RE	BS	AN	AS	PVD	-	-	
				PR1210	PR1225	KW10	TN100M	TN60						
<p>Classification of usage</p> <p>★ : Roughing / 1st Choice ☆ : Roughing / 2nd Choice ■ : Finishing / 1st Choice □ : Finishing / 2nd Choice (In case hardness is 45HRC or under)</p>		Carbon steel / Alloy steel		★	■							P		
		Mold and die steel		★	■									
		Stainless steel		★								M		
		Gray cast iron		★	☆							K		
		Nodular cast iron		★										
		Non-ferrous metals			★							N		
		Heat-resistant alloy			★							S		
		Titanium alloy		★	☆									
		Hard materials			□							H		
 	TEKN 1603PTFR	3	9.525	3.18	0.7	-	1.4	20	22		●			
	TEKN 1603PTTR	3	9.525	3.18	0.7	-	1.4	20	22	●		●		
	TEEN 2204PTTR	3	12.7	4.76	-	1	1.4	20	22			●		
	TEKN 2204PTFR	3	12.7	4.76	0.7	-	1.4	20	22		●			
	TEKN 2204PTTR	3	12.7	4.76	0.7	-	1	1.4	20	22	●		●	
 	TEKR 2204PTER-S	3	12.7	4.76	-	1	1.4	20	22		●			
 	TEMR 1603PTER-H	3	9.525	3.18	-	0.8	1.2	20	22		●			
	TEMR 2204PTER-H	3	12.7	4.76	-	1	1.4	20	22		●			
 	TPKN 1603PDFR	3	9.525	3.18	0.7	-	1.2	11	15		●			
	TPKN 1603PDTR	3	9.525	3.18	0.7	-	1.2	11	15	●	●	●		
	TPKN 2204PDFR	3	12.7	4.76	0.7	-	1.6	11	15		●			
	TPKN 2204PDTR	3	12.7	4.76	0.7	-	1.6	11	15	●	●	●		
 	TPKR 2204PDER-S	3	12.7	4.76	-	1	1.4	11	15		●			
 	TPMR 1603PDER-H	3	9.525	3.18	-	0.8	1.2	11	15		●			
	TPMR 2204PDER-H	3	12.7	4.76	-	1	1.4	11	15		●			
 	TPGN 090202	3	5.56	2.38	-	0.2	-	11	-		●		●	
	TPGN 090204					0.4					●		●	
	TPGN 110302	3	6.35	3.18	-	0.2	-	11	-		●		●	
	TPGN 110304					0.4					●		●	
  <p>Without Chipbreaker</p>	TPGN 110308	3	6.35	3.18	-	0.8	-	11	-		●		●	
	TPGN 160304	3	9.525	3.18	-	0.4	-	11	-		●		●	
	TPGN 160308					0.8					●		●	
	TPGN 160308					0.8					●		●	
  <p>Without Chipbreaker</p>	TPMN 110304	3	6.35	3.18	-	0.4	-	11	-		●		●	
	TPMN 110308					0.8					●		●	
	TPMN 160304	3	9.525	3.18	-	0.4	-	11	-		●	●	●	
	TPMN 160308					0.8					●	●	●	
TPMN 160312					1.2					●	●	●		
TPMN 220408	3	12.7	4.76	-	0.8	-	11	-		●		●		

Handed insert shows Right-hand

● : Standard item R : Right-hand only L : Left-hand only □ : Check availability

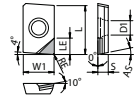

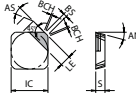
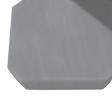
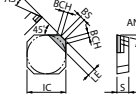
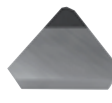
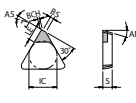
PCD inserts

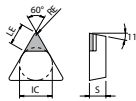
Insert		Description	No. of edges	Dimension (mm)										Angle (°)		PCD		Applicable toolholder
				IC	W1	S	D1	RE	INSL	LE	BCH	BS	AN	AS	KPD001	KPD010		
 		NDCW 150302FRX 150302FRX-NE	1	-	9.525	3.18	4.4	0.2	15	5.7 5.1	-	-	-	15	●	●	DMC...SX(...) DMC...H	
 		SDKN 1203AUFN 1203AUFN-NE	1	12.7	-	3.18	-	-	-	3.6 3.1	0.5	1.2	15	23	●	-	-	
 		SEEN 1203AFFN 1203AFFN-NE	1	12.7	-	3.18	-	-	-	3.5 3	0.5	1.4	20	25	●	●	-	
 		TEEN 1603PTFR 1603PTFR-NE	1	9.525	-	3.18	-	-	-	4.7 4.1	0.6	1.4	20	22	●	●	-	
 		TPGN 110302 110304	1	6.35	-	3.18	-	0.2 0.4	-	3.9 3.7	-	-	11	-	●	●	-	

Handed insert shows Right-hand

Classification of usage

- ★ : Roughing / 1st Choice
- ☆ : Roughing / 2nd Choice
- : Finishing / 1st Choice
- : Finishing / 2nd Choice
- (In case hardness is 45HRC or under)

Carbon steel / Alloy steel

Mold and die steel

Stainless steel

Gray cast iron

Nodular cast iron

Non-ferrous metals

Heat-resistant alloy

Titanium alloy

Hard materials

P

M

K

N

S

H

M



Milling

- Cutting edge angle 45°~70°
- Cutting edge angle 75°
- Cutting edge angle 88°/90°
- Cutter for Finishing
- High Feed Cutter
- Multi-Function
- Slot Mill
- Ball-nose Radius
- Others

● : Standard item R : Right-hand only L : Left-hand only □ : Check availability

CBN & PCD Inserts are sold in 1 piece boxes

Available geometries

Insert		Description	Dimension (mm)								Angle (°)		Material				Applicable toolholder
			IC	S	D1	RE	BCH	BS	L	AN	AS	Carbide		Cermets			
												PVD	-	-	-		
												PR1210	PR1225	PR1230	KW10	TN100M	
		RDHX 0702M0T	7	2.39	2.8	-	-	-	-	15	-	●	●	●	●		-
		RDHX 1003M0T	10	3.18	3.8	-	-	-	-	15	-	●	●	●	●		-
		RDHX 12T3M0T	12	3.97	3.8	-	-	-	-	15	-	●	●	●	●		-
		RDMT 08T2M0-H	8	2.78	3.4	-	-	-	-	15	-	●	●	●	●		-
		RPMT 10T3M0	10	3.97	3.4	-	-	-	-	11	-	●	●	●	●		-
		RPMT 1204M0	12	4.76	4.4	-	-	-	-	11	-	●	●	●	●		-
		RPMT 1204M0-H	12	4.76	4.4	-	-	-	-	11	-	●	●	●	●		-
		RPMT 1606M0-H	16	6.35	5.5	-	-	-	-	11	-	●	●	●	●		-
		RPMT 2006M0-H	20	6.35	6.5	-	-	-	-	11	-	●	●	●	●		-
		SDKW 1204AESN	12.7	4.76	5.5	1	-	1.5	-	15	20	●	●	●	●		-
		SDKW 1204AETN	12.7	4.76	5.5	1	-	1.5	-	15	20	●	●	●	●		-
		SEKW 1204AFTN	12.7	4.76	5.5	-	0.5	1.7	-	20	25	●	●	●	●		-
		SDMT 1204AESR-H	12.7	4.76	5.5	1	-	0.8	-	15	20	●	●	●	●		-
		SEKT 1204AFEN-S	12.7	4.76	5.5	-	0.5	1.7	-	20	25	●	●	●	●		-

Handed insert shows Right-hand

● : Standard item R : Right-hand only L : Left-hand only □ : Check availability



P



Screws	P2
Pins	P7
Shims	P8
Cartridges	P12
Clamp sets	P13
Clamps	P15
Chipbreakers	P16
Wrenches	P17
Springs / Nuts / Punches / Others	P18
Former parts list	P20

Shape	Description	Availability	Dimension (mm)						Angle		Torque (N-m)	Remarks
			A	B	C	D	E	F	α	θ		
	AJ -6X38	☉	M6X1.0	38.0	6.0	10.0	3.0	3.0	-	-	-	
	-8X44-9.5	☉	M8X1.25	44.0	9.5	6.0	4.0	4.0	-	-		
	-10X46	☉	M10X1.5	46.0	11.5	8.0	5.0	5.0	-	-		
	AJ -519TR	☉	M5X0.8	19.0	10.0	-	T15	-	-	40°	-	
	BH 3X6	☉	M3X0.5	6.0	-	2.0	2.0	-	-	-	-	
	3X12	☉	M3X0.5	12.0	-	2.0	2.0	-	-	-		
	6X25	☉	M6X1.0	25.0	-	4.0	4.0	-	-	-		
	BH 6X10TR	☉	M6X1.0	10.0	12.0	5.0	T25	-	-	-	6.5	
	CP 8X15TL	☉	M8X1.25	15.0	15.0	-	T25	-	-	-	6.0	L... shows Left-hand thread
	8X23TL	☉		23.0								
	CS -2D	☉	M4X0.7	21.5	6.4	3.5	2.5	2.0	-	-	1.7	
	-3D	☉	M5X0.8	22.0	8.0	4.0	3.0	2.5	-	-	3.9	
	-5D	☉	M5X0.8	28.0	8.0	4.0	3.0	2.5	-	-	3.0	
	CS -3D-TR	☉	M5X0.8	22.0	8.0	4.0	T15	T15	-	-	3.9	
	GS -50	☉	M5X0.8	13.0	7.5	-	3.0	-	-	82°	-	
	HF 20X53H	☉	M20X2.5	35.0	43.0	18.0	14.0	14.0				With Coolant Hole
	20X53HA	☉		33.0	50.0	20.0						
	24X60H	☉	M24X3.0	40.5	65.0	19.5	17.0					
	24X60HA	☉		36.0		24.0						
	HH 3X6	☉	M3X0.5	6.0	5.5	3.0	2.5	-	-	-		
	3X12	☉		12.0								
	HH 4X16	☉	M4X0.7	16.0	7.0	4.0	3.0	-	-	-		
	HH 5X15	☉	M5X0.8	15.0	8.5	5.0	4.0	-	-	-		
	5X15L	☉		16.0								
	5X16	☉		20.0								
	5X20	☉		25.0								
	5X25	☉		30.0								
	5X30	☉										
	HH 6X12	☉	M6X1.0	12.0	10.0	6.0	5.0	-	-	-		
	6X16	☉		16.0								
	6X16A	☉										
	6X18	☉		18.0								
	6X18A	☉										
	6X20	☉		20.0								
	6X25	☉		25.0								
6X30	☉	30.0										
HH 8X20	☉	M8X1.25	20.0	13.0	8.0	6.0	-	-	-			
8X25	☉		25.0									

☉ : Available

P
Spare parts

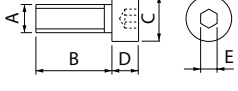
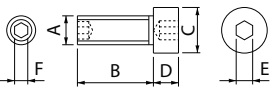
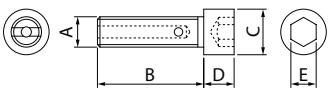
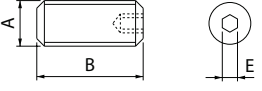
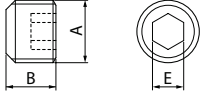
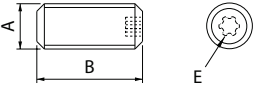
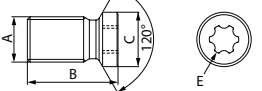
Shape	Description	Availability	Dimension (mm)					Angle		Torque (N-m)	Remarks
			A	B	C	D	E	F	α		
	HH 10X25	⊙	M10X1.5	25.0	16.0	10.0	8.0	-	-	-	-
	10X30	⊙		30.0							
	10X30S	⊙		30.0							
	10X35	⊙		35.0							
	10X40	⊙		40.0							
	HH 12X35	⊙	M12X1.75	35.0	18.0	12.0	10.0	-	-	-	
	12X40	⊙		40.0							
	HH 16X35	⊙	M16X2.0	35.0	24.0	16.0	14.0	-	-	-	
	16X40	⊙		40.0							
	16X45	⊙		45.0							
HH 20X40	⊙	M20X2.5	40.0	30.0	20.0	17.0	-	-	-		
20X55	⊙		55.0								
	HH 4X12	⊙	M4X0.7	10.0	7.0	4.0	3.0	2.0	-	-	-
	HH 8X25H	⊙	M8X1.25	25.0	13.0	8.0	5.0	-	-	-	-
	10X30H	⊙	M10X1.5	30.0	16.0	10.0	6.0				
	10X35HK	⊙		35.0							
	12X35H	⊙	M12X1.75	35.0	18.0	12.0	8.0				
	12X35HK	⊙		35.0							
	16X52H	⊙	M16X2.0	36.0	24.0	16.0	12.0				
	HS 3X3P	⊙	M3X0.5	2.9	-	-	1.5	-	-	-	1.0
	3X4P	⊙		3.9							
	3X4	⊙		4.0							
	HS 4X4P	⊙	M4X0.7	3.9	-	-	2.0	-	-	-	2.0
	4X4	⊙		4.0							
	HS 5X5	⊙	M5X0.8	5.0	-	-	2.5	-	-	-	3.0
	HS 6X4P	⊙	M6X1.0	3.9	-	-	3.0	-	-	-	4.0
	6X6	⊙		6.0							
	6X8T	⊙		8.0							
	6X14	⊙		14.0							
	6X22	⊙		22.0							
	HS 8X10	⊙	M8X1.25	10.0	-	-	4.0	-	-	-	-
	8X12	⊙		12.0							
	HS 10X10	⊙	M10X1.5	10.0	-	-	5.0	-	-	-	-
	10X16	⊙		16.0							
	HS 12X12	⊙	M12X1.75	12.0	-	-	6.0	-	-	-	-
	12X16	⊙		16.0							
	12X18	⊙		18.0							
	12X20	⊙		20.0							
12X25	⊙	25.0									
12X30	⊙	30.0									
12X35	⊙	35.0									
HS 16X12	⊙	M16X2.0	12.0	-	-	8.0	-	-	-	-	
16X18	⊙		18.0								
16X20	⊙		20.0								
	HS 5X4LP	⊙	M5X0.8	4.0	-	-	2.5	-	-	-	-
	HS -2524TRP	⊙	M2.5X0.35	2.4	-	-	5IP	-	-	-	0.5
	-2534TRP	⊙		3.4							
	-3048TRP	⊙	M3X0.5	4.8			6IP				0.8
	-4067TRP	⊙	M4X0.7	6.7			7IP				1.2
	HS -50100TRP	⊙	M5X0.8	10	6.0	1.6	15IP	-	-	-	3.5

⊙: Available



Spare parts

Shape	Description	Availability	Dimension (mm)								Angle		Torque (N-m)	Remarks	
			A	B	C	D	E	F	α	θ					
	HSB 4X8%	⊙	M4X0.7	8.0	R2.0	-	2.0	-	-	-	-	2.0	R... shows Right-hand thread L... shows Left-hand thread		
	LS -03N	⊙	M5X0.8	9.7	M5X0.8	-	2.0	-	-	-	-	2.0	N: Silver coated		
	LS -03SN	⊙		12.0			2.5					3.0			
	LS -05	⊙	M5X0.8	15.5	M5X0.8	-	2.0	2.0	-	-	-	2.0			
	LS -1N	⊙	M6X1.0	17.0	6.0	-	2.5	2.5	-	-	-	3.0	N: Silver coated		
	LS -15N	⊙		14.2											
	LS -1T	⊙		21.0											
	LS -2N	⊙	M8X1.0	20.0	8.0	-	3.0	3.0	-	-	-	4.0			
	LS -3	⊙		22.0											
	LS -4N	⊙		24.0											
LS -5	⊙	M10X1.0	29.0	10.0	-	4.0	4.0	-	-	-	-				
	LS -1P	⊙	M6X1.0	16.5	6.0	-	10IP	10IP	-	-	-	2.0	IP shows Torx Plus		
	LS -2P	⊙	M8X1.0	18.2	8.0	-	15IP	15IP	-	-	-	3.5			
	LS -3P	⊙		21.8											
	LS -11	⊙	M6X1.0	9.5	-	-	3.0	-	-	-	-	-			
	LS -15	⊙		12.5											
	M 3X8	⊙	M3X0.5	8.0	5.5	2.0	-	-	-	-	-	-	Flat fillister head screw equivalent to JIS B-1101		
	M 3X12	⊙		12.0											
	M 4X10	⊙	M4X0.7	10.0	7.0	2.6									
	SB -1TR	⊙	M2X0.4	5.3	3.8	-	-	-	-	-	-	T6	82°	0.5	R... shows right-hand thread
	SB -2TR	⊙	M2.5X0.45	6.2	4.5							T8	1.2		
	SB -3TR	⊙	M3X0.5	7.2	4.8							T10	2.0		
	SB -3STR	⊙		6.4	5.2										
	SB -3.5TR	⊙	M3.5X0.6	9.3	5.6							T15	3.5		
	SB -4TR	⊙	M4X0.7	7.7	5.8										
	SB -5TR	⊙	M5X0.8	20.0	8.7								T20	90°	
	SB -2290TR	⊙	M2.2X0.45	9.2	2.8							T6	60°	0.5	
	SB -25100TR	⊙	M2.5X0.45	10.0	3.5							T7		0.8	
	SB -40115TR	⊙	M4X0.7	11.5	5.5							T15		3.5	
	SB -5070TR	⊙	M5X0.8	7.0	6.8							T20		4.5	
	SB -5090TR	⊙		9.0											
	SB -50120TR	⊙	12.0												

⊙: Available

Reference

Torx and Torx Plus have different cross-sections.



Torx



Torx Plus

P



Spare parts

Shape	Description	Availability	Dimension (mm)						Angle		Torque (N-m)	Remarks
			A	B	C	D	E	F	α	θ		
<p>SB-40125TRN</p>	SB -1635TR	⊙	M1.6X0.35	3.3	2.6				T6	60°	0.5	R... shows right-hand thread L... shows left-hand thread IP shows Torx Plus
	SB -15TR	⊙	M2X0.4	5.0	3.1				6IP	55°		
	SB -1840TRP	⊙	M1.8X0.35	4.0	2.5				6IP	55°		
	SB -2035TR	⊙	M2X0.4	3.7	3.0				T6	60°		
	SB -2035TRG	⊙		3.5	2.7				6IP	55°		
	SB -2037TRP	⊙		3.7								
	SB -2040TR	⊙		3.8	3.0				T6	60°		
	SB -2040TRG	⊙		4.0								
	SB -2041TRP	⊙		4.1	2.7				6IP	60°		
	SB -2042TRG	⊙		4.3								
	SB -2045TR	⊙		4.3	2.8				T6	37°		
	SB -2045TRN	⊙		4.8								
	SB -2050TR	⊙		4.8	3.0							
	SB -2060TR	⊙	5.8	3.5				T8	60°			
	SB -2080TR	⊙	8.3	2.8				T6	0.5			
	SB -2250TR	⊙	5.1	3.1								
	SB -2255TR	⊙	5.5	3.5								
	SB -2260TR	⊙	5.8	3.1				T7	60°			
	SB -2270T ⁹⁰ /L	⊙	6.8	3.2								
	SB -2545TR	⊙	4.6	3.5				T8	60°	1.2		
	SB -2555TRG	⊙	5.4									
	SB -2555TRP	⊙	5.5					8IP				
	SB -2560TR	⊙	5.7									
	SB -2570TR	⊙	6.8					T8				
	SB -3060TR	⊙	5.3	4.2				T10	60°	2.0		
	SB -3060TRP	⊙	6.0					10IP				
	SB -3065TRP	⊙	6.5	4.0				8IP	1.2			
	SB -3070TRG	⊙	7.0	4.2				T10	2.0			
	SB -3070T ⁹⁰ /L	⊙		4.0				T8	1.2			
	SB -3070TRP	⊙	4.2									
	SB -3076TRP	⊙	7.6	3.9				10IP	55°			
	SB -3080TR	⊙	8.0	4.2				T10	60°			
	SB -3573TRP	⊙	7.3	5.0								
	SB -3575TRP	⊙	7.5	4.9				10IP	2.0			
	SB -3580TR	⊙	8.0	5.3				T15	3.5			
	SB -3590TRP	⊙	9.0					15IP	4.0			
	SB -3592TR	⊙	9.2		5.1				T10	2.0		
	SB -35120TRP	⊙	12.0		5.2				15IP	4.0		
	SB -4050TRN	⊙	4.6		5.1				T10	57°		
	SB -4060TR	⊙	5.9	5.5								
	SB -4065TR	⊙	6.7					T15	3.5			
	SB -4070TRG	⊙	7.0									
	SB -4070TRN	⊙	7.7	5.4								
	SB -4070TRS	⊙	6.7	5.5				T10	2.0			
	SB -4075TRP	⊙	7.5									
	SB -4082TPR	⊙	8.2					15IP				
	SB -4085TR	⊙	8.5					T15				
	SB -4085TRP	⊙										
	SB -4086TRP	⊙	8.6				15IP					
	SB -4090TRP	⊙	9.0	5.7								
SB -4090TRPN	⊙		5.5									
SB -40120TR	⊙	12.0	5.1									
SB -40125TRN	⊙	12.5	5.2				T15	50°				
SB -40140TR	⊙	14.0	5.5					60°				
SB -40140TRN	⊙		6.7					75°				
SB -4570TRN	⊙	M4.5X0.5	6.8	6.0			T10	57°				
SB -45130TR	⊙	M4.5X0.75	13.0	6.6			20IP	55°				
SB -5085TR	⊙	M5X0.8	8.5	6.8			T20	50°				
SB -50120TRP	⊙		12.0					20IP	60°			
SB -50120TRPH	⊙			7.2				15IP	3.5			
SB -50120TRS	⊙		13.7	9.7			T20	70°				
SB -50137K	⊙		14.0	7.3			T15	50°				
SB -50140TR	⊙											
SB -50140TRP	⊙								20IP	4.5		
SB -60120TR	⊙	M6X1.0	12.0	8.5			T25	60°				
SB -60130TRP	⊙		13.0						6.0			
SB -60200TRP	⊙		20.0					20IP	4.5			
SB -60200TRP	⊙							6.0				
SB -4070TRW	⊙	M4X0.7	6.7	5.5			T8	60°				
SB -4590TRWN	⊙	M4.5X0.75	9.3	5.6			T10	57°				



Spare parts

Shape	Description	Availability	Dimension (mm)						Angle		Torque (N-m)	Remarks
			A	B	C	D	E	F	α	θ		
	SC	-30067	⊙	M3X0.35	6.7	4.4	-	-	T8	60°	1.2	
		-35085	⊙	M3.5X0.35	8.5	5.7	-	-	T10	60°	2.0	
		-40100	⊙	M4X0.5	10.0	6.0	-	-	T15	60°	3.5	
		-50130	⊙	M5X0.5	13.0	6.6	-	-	T20	40°	4.5	
		-60160	⊙	M6X0.75	16.0	8.0	-	-	T25	40°	6.0	
		-60210	⊙	M6X0.75	21.0	9.6	-	-	T30	40°	8.0	
	SE	-3070TRP	⊙	M3X0.5	7.0	4.3	-	-	9IP	43°	1.7	IP shows Torx Plus
		-40050TRN	⊙	M4X0.7	5.0	5.0	-	-	T15	44°	3.5	
		-40055TR	⊙	M4X0.7	5.5	5.0	-	-	T15	44°	3.5	
		-40068TR	⊙	M4X0.7	6.8	5.0	-	-	T15	44°	3.5	
		-40080TR	⊙	M4X0.7	8.0	5.0	-	-	T15	44°	3.5	
		-40090TR	⊙	M4X0.7	9.0	5.0	-	-	T15	44°	3.5	
		-40100TR	⊙	M4X0.7	10.0	5.0	-	-	T15	44°	3.5	
		-40100TR	⊙	M4X0.7	10.0	5.0	-	-	T15	44°	3.5	
	SE	-40120TR	⊙	M4X0.7	12.0	5.6	-	-	T15	60°	3.5	
		-50125TR	⊙	M5X0.8	12.5	6.8	-	-	T20	60°	4.5	
	SH	-50150TR	⊙	M5X0.8	15.1	7.3	3.1	-	T20	-	4.5	
	SP	3X4	⊙	M3X0.5	4.0	4.0	-	-	-	90°	-	With additional machining below the flat head screw
		3X6	⊙	M3X0.5	6.0	6.0	-	-	-	90°	-	Cross recessed flat head screw equivalent to JIS...B-1111
		3X8	⊙	M3X0.5	8.0	6.0	-	-	-	90°	-	
		3X10	⊙	M3X0.5	10.0	6.0	-	-	-	90°	-	
	SP	4X9	⊙	M4X0.7	9.0	5.6	-	2.0	-	90°	-	
	SP	8X35	⊙	M8X1.25	35.0	11.0	4.4	5.0	-	90°	-	
	SPW	-5035	⊙	M5X0.5	7.0	6.3	M3.5X0.6	3.5	-	-	-	A shows External, D shows Internal. External and Internal threads are both Right-hand threads.
		-6045	⊙	M6X0.75	9.0	7.5	M4.5X0.75	4.5	-	-	-	
		-7050	⊙	M7X0.75	9.0	8.8	M5X0.8	5.0	-	-	-	
	SS	-4N	⊙	M5.5X0.5	8.5	6.6	M4X0.7	4.0	-	-	-	
	SV	-60136R	⊙	M6X1.0	13.6	6.3	-	-	T25	6°	-	Torx
		-60136TR	⊙	M6X1.0	13.6	6.3	-	-	T20	6°	4.5	
	TH	8X15	⊙	M8X1.25	20.0	8.5	-	4.0	-	-	-	
	W	6X17	⊙	M6X1.0	17.0	-	-	-	T20	-	4.5	
		6X18N	⊙	M6X1.0	18.0	-	-	-	T15	-	3.5	
		8X16	⊙	M8X1.0	16.0	-	-	-	T25	-	6.0	
	W	6X18	⊙	M6X1.0	17.5	-	-	3.0	-	-	-	
		6X20	⊙	M6X1.0	20.5	-	-	3.0	-	-	-	
		8X18	⊙	M8X1.25	18.0	-	-	4.0	-	-	-	
		*8X21	⊙	M8X1.0	21.0	-	-	4.0	-	-	-	
	W	10X31	⊙	M10X1.0	31.0	M10X1.5	-	5.0	-	-	-	

* No socket on right-hand thread side

⊙ : Available

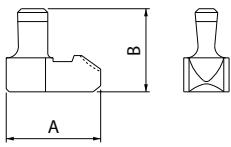
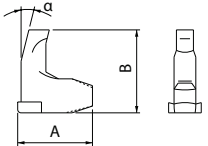
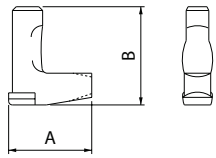
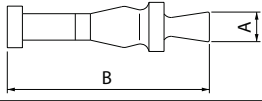
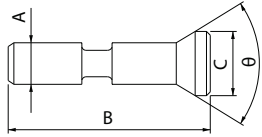
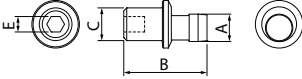
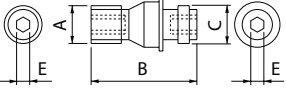
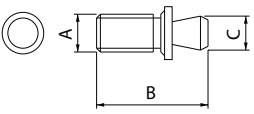
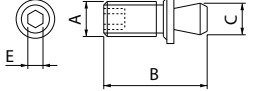
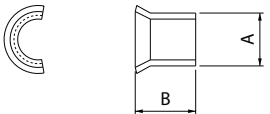
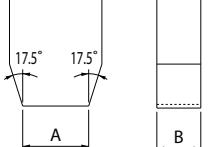

Spare parts

Shape	Description	Availability	Dimension (mm)						Angle		Remarks
			A	B	C	D	E	F	α	θ	
	LL -03N	☉	7.8	6.3							
	-03SN	☉	11.1	8.9	-	-	-	-	-	-	
	-03TN	☉	8.3	8.9							
	LL -05C	☉	10.7	11.7					12°		
	-1CN	☉	13.0	13.3	-	-	-	-	14°	-	
	-2C	☉	18.8	17.6					14°		
	LL -1K	☉	10.0	12.0							
	-1N	☉	10.3	12.0							
	-1DN	☉	12.3	12.0							
	-2K	☉	13.3	13.2							
	-2N	☉	13.5	13.0							
	-3K	☉	16.0	14.8							
	-3N	☉	16.4	13.0							
	-4	☉	16.4	14.7							
	-5N	☉	17.1	16.7							
-6	☉	20.7	21.0								
	LP -2S	☉	3.65	20.0	-	-	-	-	-	-	
	-6S	☉	3.65	25.0	-	-	-	-	-	-	
	LPA -11	☉		11.0							
	-13	☉	2.8	13.0	4.2	-	-	-	-	60°	
	-17	☉		17.0							
	LPF -11	☉		11.0							
	-1113	☉	2.5	13.0	3.5						60°
	-1117	☉		17.0							
	-13	☉	3.8	13.0	5.5						
-17	☉		17.0								
	PP -4	☉	4.6	14.0	5.5	-	3.0	-	-	-	
	TS -3S	☉	M5X0.8	15.0	3.60	-	2.0	-	-	-	
	WP -1S	☉	M5X0.8	18.0	3.65	-	-	-	-	-	
	5X15	☉		15.0	5.0						
	WP 5X11	☉	M5X0.8	10.5	5.0	-	2.0	-	-	-	
	LSP -1	☉	5.0	5.3							
	-2	☉	6.5	5.6							
	-3	☉	8.25	7.9							
	-4	☉	9.5	10.0							
	LSP -2K	☉	5.1	5.2							
-3K	☉	6.7	5.7								
	P -03	☉	2.8	1.95	-	-	-	-	-	-	
	-03S	☉	3.5	1.95	-	-	-	-	-	-	

☉: Available



Spare parts

Shape Handed spare parts show right-hand	Description	Availability	Dimension (mm)						Angle		Remarks
			A	B	C	D	E	F	α	θ	
	DC -42	☉	12.0	3.2	1.2	6.0	4.4	R1.2	-	-	Shim screw: SB-4085TR
	-44	☉	12.55	5.0	1.5			R0.8	-	-	
	DC -44-C	☉	12.55	5.0	1.5	6.0	4.4	-	-	-	Shim screw: SB-4085TR
	DD -42	☉	12.55	3.2	1.2	6.0	4.4	R1.2	-	-	Shim screw: SB-4085TR
	-42-16	☉						R1.6			
	-43	☉		3.4	1.3			R0.8			
	-44	☉		5.0	1.5						
	DS -42	☉	12.0	3.2	1.2	6.0	4.4	R1.2	-	-	Shim screw: SB-4085TR
	-44	☉	12.55	5.0	1.5			R0.8			
	DT -32	☉	8.63	3.2	0.95	5.0	3.4	R1.6	3°	-	Shim screw: SB-3080TR
	-42	☉	12.46		1.2	6.0	4.4	R1.2	-	-	Shim screw: SB-4085TR
	DV -33	☉	9.40	3.5	1.2	6.0	4.4	R1.0	-	-	Shim screw: SB-4085TR
	DW -42	☉	11.5	3.2	1.2	6.0	4.4	R1.2	4°	-	Shim screw: SB-4085TR
	-44	☉	12.65	5.0	1.5			R0.8	-	-	
	556 C%	☉	34.0	10.0	12.7	5.6	5.0	R1.6	0°	55°	R...shows Right-hand L...shows Left-hand Shim screw: HH5X16
	KPS -42	☉	11.5	3.2	2.0	7.2	3.2	C1.0	7°	-	Shim screw: SP3X8
	KPT -32	☉	8.0	3.2	1.9	7.0	3.2	R0.4	11°	-	Shim screw: SP3X8 SP3X10
	-42	☉	10.5	3.2	1.9	7.0	3.2	R0.8	11°	-	
	KVN -32	☉	9.52	3.2	2.1	7.6	5.5	R0.8	-	-	Lock pin: LP-2S LP-6S
	LC -32N	☉	9.47	2.4	1.3	6.18	4.68	R0.8	-	-	Shim pin: LSP-1
	-4K	☉	11.7	3.2	1.4	8.1	6.73	R0.8	-	-	Shim pin: LSP-3K
	-42N	☉	12.65	3.2	1.5	8.01	6.28	R0.8	-	-	Shim pin: LSP-2
	-42N-20	☉						R2.0			
	-53N	☉	15.9	4.8	1.7	10.0	8.0	R1.2	-	-	Shim pin: LSP-3
	-63	☉	19.0	4.8	2.0	11.61	9.3	R1.6	-	-	Shim pin: LSP-4

☉: Available



Spare parts

Shape Handed spare parts show right-hand	Description	Availability	Dimension (mm)						Angle		Remarks
			A	B	C	D	E	F	α	θ	
	LC -42N-C	☉	12.65	3.2	1.5	8.01	6.28	-	-	-	Shim pin: LSP-2
	-53N-C	☉	15.9	4.8	1.7	10.0	8.0	-	-	-	Shim pin: LSP-3
	-63-C	☉	19.0	4.8	2.0	11.61	9.3	-	-	-	Shim pin: LSP-4
	LC -42N ^{9/16}	☉	12.65	3.2	1.5	8.01	6.28	R0.8	10°	-	R... shows right-hand L... shows left-hand Shim pin: LSP-2
	LD -32N	☉	9.47	2.4	1.3	6.18	4.68	R0.8	-	-	Shim pin: LSP-1
	-4K	☉	11.7	3.2	1.4	8.1	6.73	R0.8	-	-	Shim pin: LSP-3K
	-4K43	☉		4.8	3.0	8.3	6.60	R1.2			
	-42	☉	12.65	3.2	1.5	8.01	6.28	R0.8	-	-	Shim pin: LSP-2
	-42-20	☉	12.65	4.8	3.1	8.5	6.28	R2.0			
	-43	☉						R0.8			
-43-20	☉					R2.0	-	-			
	LR -80	☉	9.47	3.2	1.3	6.25	4.75	-	-	-	Shim pin: LSP-1
	-81	☉	12.65	3.2	1.5	8.01	6.28	-	-	-	Shim pin: LSP-2
	LR -10C	☉	8.5	3.2	6.3	6.3	4.7	-	-	-	Shim pin: LSP-1
	-12C	☉	10.0	3.2	6.3	6.3	4.7	-	-	-	
	-16C	☉	13.6	3.2	7.9	8.01	6.28	-	-	-	Shim pin: LSP-2
	LS -32	☉	9.47	3.2	1.3	6.18	4.68	R0.8	-	-	Shim pin: LSP-1
	-42	☉	12.65	3.2	1.5	8.01	6.28	R0.8	-	-	Shim pin: LSP-2
	LT -3K	☉	8.53	2.7	1.0	6.1	5.13	R0.8	-	-	Shim pin: LSP-2K
	-32N	☉	9.47	2.7	1.3	6.18	4.68	R0.8	-	-	Shim pin: LSP-1
	-32N-20	☉						R2.0			
	-42N	☉	12.65	3.2	1.5	8.01	6.28	R0.8	-	-	Shim pin: LSP-2
	-42N-20	☉					R2.0				
	LW -32N	☉	9.47	2.4	1.3	6.18	4.68	R0.8	-	-	Shim pin: LSP-1
	-42N	☉	12.65	3.2	1.5	8.01	6.28	R0.8	-	-	Shim pin: LSP-2
	LW -42N ^{9/16}	☉	12.65	3.2	1.5	8.01	6.28	R0.8	10°	-	R... shows right-hand L... shows left-hand shim pin: LSP-2
	MFPN -45	☉	17.07	3.5	1.95	9.8	7.18	R3.5	-	-	Shim screw: SPW-7050
	MFSE -105	☉	10.5	3.0	1.4	7.0	5.3	-	7°	45°	
	MFWN -90	☉	15.25	4.0	2.5	9.44	7.25	R3.0 R4.0	-	-	Shim screw: SPW-7050
	MSD -42	☉	10.7	3.2	1.85	7.0	3.3	-	20°	45°	Shim screw: SP3X8
	MSE -4245S	☉	10.3	3.2	2.0	6.0	5.0	-	20°	45°	Shim screw: SP4X9
	MSE -4215	☉	10.53	3.2	1.5	6.4	3.4	-	25°	15°	Shim screw: SP3X8
	-4245	☉	10.53	3.2	1.5	6.4	3.4	-	25°	45°	Shim screw: SP3X8

☉: Available



Spare parts

Shape	Description	Availability	Dimension (mm)							Angle		Remarks
			A	B	C	D	E	F	α	θ		
	MS0 -4T245	●	10.0	2.0	4.7	6.4	4.8	-	27°	45°	Shim screw: SP3X6	
	MS0 -5200	●	12.6	3.18	1.8	8.27	6.66	R0.8	15°	-	Shim screw: SPW-6045	
	MSP -42	●	11.3	3.2	1.85	7.0	3.3	-	15°	15°	Shim screw: SP3X8	
	MTE -42	●	9.8	3.2	-	6.4	3.4	-	25°	-	Shim screw: SP3X8	
	MVN -32	●	9.52	3.2	2.1	7.4	6.5	R0.8	-	-	Lock pin: TS-35	
	PD -42	●	12.7	3.2	1.7	6.0	8.4	0.8	12°	-	Shim screw: SB-2050TR	
	SP -129	●	9.52	9.52	R0.8	R1.6	R1.2	R1.6	-	-	Shim screw: HH3X12	
	SP -141	●	12.7	4.0	2.4	6.2	3.3	R1.2	-	-	Shim screw: M3X8	
	-143	●	12.7	7.2	2.4	6.2	3.3	R1.2	-	-	Shim screw: M3X12	
	-162	●	15.8	6.0	3.4	8.0	4.4	R1.5	-	-	Shim screw: M4X10	
	SP -148	●	12.7	8.8	2.4	6.2	3.3	R1.2	-	-	Shim screw: BH3X12	
	SP -219	●	6.35	9.52	R0.8	R1.2	R1.6	-	-	-	Shim screw: HH3X12	
	SP -221	●	9.52	4.0	2.5	6.5	3.5	R1.2	-	-	Shim screw: M3X8	
	-223	●	9.52	7.2	2.5	6.5	3.5	R1.2	-	-	Shim screw: M3X12	
	SP -342	●	12.7	6.0	2.5	6.5	3.5	R1.2	-	75°	Shim screw: M3X8	
	-441	●	12.7	4.0	2.5	6.2	3.3	R0.8	-	80°	Shim screw: M3X8	
	-443	●	12.7	7.2	2.5	6.2	3.3	R0.8	-	80°	Shim screw: M3X12	
	-454	●	15.7	8.0	3.4	8.0	4.5	R1.6	-	80°	Shim screw: M4X10	

● : Available



Shape	Description	Availability	Dimension (mm)						Angle		Remarks
			A	B	C	D	E	F	α	θ	
	SP -429	Available	9.52	9.52	-	-	-	R1.2	-	-	Shim Screw : HH3X12
	SP -521	Available	10.0	4.0	2.5	6.2	3.3	R1.0	-	-	Shim Screw : M3X8
	SP -523	Available		7.2							Shim Screw : M3X12
	SP -541	Available	12.7	4.0	2.5	6.2	3.3	R1.2	-	-	Shim Screw : M3X8
	SP -543	Available		7.2							Shim Screw : M3X12
	SP -826	Available	9.52	7.9	-	-	-	-	-	-	Shim Screw : HH3X12
	SP -829	Available	9.52	9.52	-	-	-	-	-	-	
	SP -841	Available	12.7	4.0	2.4	6.2	3.3	-	-	-	Shim Screw : M3X8
	SP -843	Available	12.7	7.2	2.4	6.2	3.3	-	-	-	Shim Screw : M3X12
	SP -849	Available	12.7	8.8	2.4	6.2	3.3	-	-	-	Shim Screw : BH3X12
	SP -861	Available	15.8	6.0	3.4	8.0	4.4	-	-	-	Shim Screw : M4X10
	SP -130A	Available	9.52	3.2	-	R0.4	R0.8	R1.2	8°	-	Shim Screw : BH3X12
	SP -210A	Available	6.35	3.2	R0.4	R0.8	R1.2	-	8°	-	Shim Screw : BH3X6
	SP -420A	Available	9.52	3.2	-	-	R0.8	R1.2	8°	-	Shim Screw : BH3X6
	SP -141P	Available	12.7	4.0	2.4	6.2	3.3	R1.2	7°	-	Shim Screw : M3X8
	SP -143P	Available	12.7	7.2	2.4	6.2	3.3	R1.2	7°	-	Shim Screw : M3X12
	SP -230P	Available	8.3	3.2	2.0	7.2	3.2	R0.5	7°	-	Shim Screw : SP3X10
	SP -341P	Available	12.6	4.0	2.5	6.5	3.5	R1.2	7°	-	Shim Screw : M3X8
	SP -441P	Available	12.7	4.0	2.5	6.2	3.3	R1.2	11°	-	Shim Screw : M3X8
	SP -443P	Available		7.2							Shim Screw : M3X12
	SP -521P	Available	10.0	4.0	2.5	6.2	3.3	R1.2	11°	-	Shim Screw : M3X8
	SP -523P	Available		7.2							Shim Screw : M3X12

Available



Spare parts

Shape Handed spare parts show right-hand	Description	Availability	Dimension (mm)						Angle		Remarks
			A	B	C	D	E	F	α	θ	
	SP -RC	☉	12.6	3.0	-	7.35	3.35	-	-	-	Shim screw: SP3X8
	SVN -32	☉	8.0	3.2	1.5	3.1	2.3	R0.4	-	-	Shim screw: SB-2050TR
	SVN -32N	☉	8.2	3.2	1.5	7.0	5.9	R0.6	-	-	Shim screw: SS-4N
	SVN -32S	☉	8.2	3.2	1.5	7.0	5.9	R0.2	-	-	Shim screw: SS-4N 1-edge
	TN -32	☉	9.52	3.2	6.5	7.0	4.2	R0.4	-	-	Shim screw: SP3X8
	-43	☉	12.70	3.2	8.1	7.0	4.2	R0.5	-	-	
	TNW -32	☉	9.52	3.2	4.8	7.0	4.2	-	-	-	Shim screw: SP3X8
	WTN -33	☉	9.52	4.76	2.5	7.0	5.3	R0.8	-	-	Shim pin: WP-1S
	-33-20	☉						R2.0			
	WWN -42	☉	12.7	3.0	1.4	7.0	5.3	R1.2	-	-	Shim pin: WPSX15
	WWP -42	☉	12.7	3.0	1.5	8.3	5.3	R1.2	11°	-	Shim pin: WPSX11
	-42-16	☉						R1.6			
	MAP -2216	☉	-	9.0	11.0	19.8	-	-	20°	-	Clamp screw SB-40140TR
	MAP -2506	☉	-	9.5	14.9	20	-	-	5°	-	Clamp screw SB-40140TR
	LSE -445R	☉	12.7	13.0	19.5	26.0	-	-	20°	45°	Dimension A shows insert I.C.
	LSO -445R	☉	13.494	12.0	21.3	23.5	-	-	27°	45°	

☉: Available

P

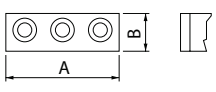
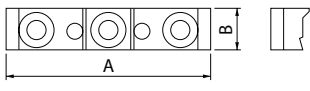
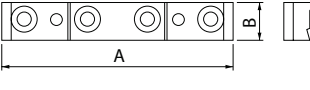
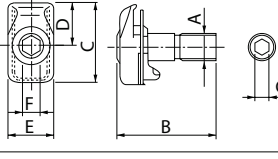
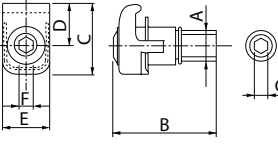
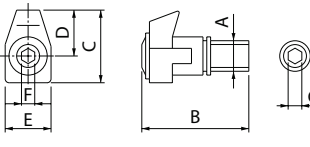
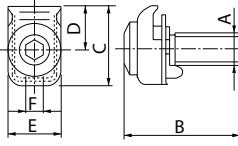
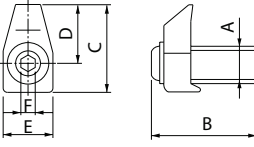
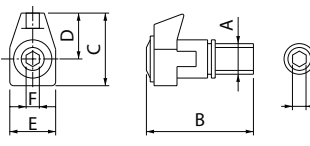
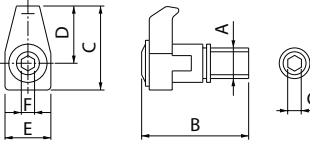
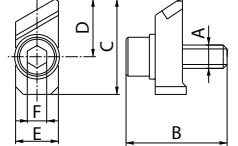

Spare parts

Shape Handed spare parts show right-hand	Description	Availability	Dimension (mm)							Remarks
			A	B	C	D	E	F	G	
	BCS -1	☉	64.0	13.0	-	-	-	-	-	
	BCS -5	☉	48.0	16.5	-	-	-	-	-	
	BCS -2	☉	74.0	15.0	-	-	-	-	-	
	BCS -3	☉	88.0	16.0	-	-	-	-	-	
	BCS -4	☉	98.0	16.0	-	-	-	-	-	
	CE -010	☉	M8X1.25	28.0	24.0	12.8	13.0	4.0	4.0	G: Indicates hexagon hole two side widths of back side of bolts
	CE -220	☉			27.0	15.8	15.0			
	CE -020	☉	M8X1.25	30.0	17.0	10.5	12.7	4.0	4.0	G: Indicates hexagon hole two side widths of back side of bolts
	CE -030	☉	M8X1.25	30.0	19.0	12.5	12.7	4.0	4.0	G: Indicates hexagon hole two side widths of back side of bolts
	CE -040	☉			22.5	16.0				
	CE -320	☉	M6X1.0	24.5	18.2	9.7	12.7	4.0	-	
	CE -360S	☉	M6X1.0	16.0	18.0	10.55	12.4	4.0	-	
	CE -030A	☉	M8X1.25	30.0	20.0	13.7	12.7	4.0	-	G: Indicates hexagon hole two side widths of back side of bolts
	CE -410	☉	M8X1.25	30.0	26.0	19.5	12.7	4.0	4.0	G: Indicates hexagon hole two side widths of back side of bolts
	CE -430	☉			29.0	22.5				
	CP -RC%L	☉	M6X1.0	20.0	24.5	14.8	11.0	5.0	-	R...shows right-hand L...shows left-hand

☉: Available



Spare parts

Shape Handed Spare Parts show Right-hand	Description	Availability	Dimension (mm)							Remarks
			A	B	C	D	E	F	G	
	CPS -1	☉	M3X0.5	9.0	10.0	5.2	5.5	2.0	-	
	CPS -2	☉	M5X0.8	14.5	14.0	8.5	6.8	2.5	2.5	G: Indicates hexagon hole two side widths of back side of bolts
	-2P	☉		18.0						
	-3	☉	M6X1.0	19.0	16.5	10.0	8.8	3.0	3.0	
	CPS -2S	☉	M5X0.8	13.5	14.0	8.5	6.8	T15	2.0	G: Indicates hexagon hole two side widths of back side of bolts
	-2TR	☉		15.0						
	CPS -4V	☉	M4X0.7	8.9	11.3	7.3	8.0	T10	-	G: Indicates hexagon hole two side widths of back side of bolts
	-5F	☉	M5X0.8	11.3	12.7	7.5	10.3	T15	2.5	
	-5S	☉		18.0	15.0	9.5	11.0		2.0	
	-5V	☉		13.5	12.7	7.5	10.3		2.5	
	CPS -6F	☉	M6X1.0	16.5	15.6	9.5	12.2	3.0	-	G: Indicates hexagon hole two side widths of back side of bolts
	-6M	☉		18.5	17.5	11.0	13.0		3.0	
	-6S	☉			18.0	12.0	12.0			
	-6V	☉			15.6	9.5	12.2			
	-8V	☉	M8X1.25	24.0	20.8	13.0	15.5	4.0	4.0	
	CPS -5E	☉	M5X0.8	13.5	17.5	12.0	9.0	T15	2.5	G: Indicates hexagon hole two side widths of back side of bolts
	CPS -5%L	☉	M5X0.8	18.0	17.5	12.0	9.0	2.5	2.5	G: Indicates hexagon hole two side widths of back side of bolts R...shows Right-hand Thread L...shows Left-hand Thread
	LGBA -16%S	☉	M5X0.8	15.0	16.1	11.2	9.85	T15	2.0	G: Indicates hexagon hole two side widths of back side of bolts R...shows right-hand L...shows left-hand
	-22%S	☉			17.6	12.7				
	WCS -1N	☉	M6X1.0	21.0	15.7	-	15.0	3.0	-	
	WCS -8	☉	M6X1.0	21.0	19.4	-	15.0	3.0	-	

☉: Available



Spare parts

Shape Handed spare parts show right-hand	Description	Availability	Dimension (mm)						Angle		Remarks
			A	B	C	D	E	F	α	θ	
	C 08R	●	7.6	8.7	8.9	3.6	M5X0.8 (Left-hand Thread)	-	10°	-	
	C 09N	●	6.0	9.0	9.8	5.3	M6X1.0 (Left-hand Thread)	-	10°	-	Clamp screw: W6X18N
	C 17R	●	12.2	20.0	14.3	8.5	M8X1.25 (Left-hand Thread)	-	12°	-	Clamp screw: W8X18
	C 20R	●	15.1	15.5	15.0	7.5	5.3	-	10°	-	Clamp screw: TH8X15
	CH -20R	●	13.1	15.5	14.8	7.5	5.3	-	10°	-	Clamp screw: TH8X15
	C 25R	●	13.2	15.5	15.0	7.5	5.3	-	10°	-	Clamp screw: TH8X15
	CGA -3%/	●	24.0	17.66	12.0	6.2	1.9	11.0	-	-	R...shows right-hand L...shows left-hand
	-4%/	●	24.0	17.66	12.0	6.2	2.9	11.0	-	-	
	-5%/	●	27.5	18.66	12.0	6.2	3.9	14.5	-	-	
	CGB 5%/	●	19.0	14.0	8.2	6.35	9.5	-	-	-	R...shows right-hand L...shows left-hand
	CGH -1%/	●	25.0	22.0	8.0	6.05	3.0	5.5	-	-	R...shows right-hand L...shows left-hand
	-2%/	●					5.0				
	-3%/	●	30.0	23.0	8.5		6.0	7.0			
	CGIA -3R	●	10.7	17.0	10.5	5.2	1.8	2.0	-	-	
	-4R	●			11.5		2.5				
	-5R	●	15.7		10.5		3.5	7.0			

●: Available



Spare parts

Shape Handed spare parts show right-hand	Description	Availability	Dimension (mm)						Angle		Remarks
			A	B	C	D	E	F	α	θ	
	CP -2D	☉		10.0	21.6		10.4				
	-3D	☉	-	12.0	27.6	-	14.0	-	-	-	
	-5D	☉		13.0	32.0						
	CP -2D-90°-JCT	☉	-	13.5	25.3	-	21.5	-	-	-	
	CP -3D-90°-JCT	☉			26.4		17.9				
	-4D-90°-JCT	☉	-	13.1	28.4	-	18.2	-	-	-	
	-5D-JCT	☉			31.9		21.5				
	CP -8TE	☉	17.9	12.0	12.0	M8X1.25 (Left-hand Thread)	10.0	-	15°	-	
	CP -8W	☉	20.9	12.0	8.0	M8X1.25 (Left-hand Thread)	13.0	-	3°	-	
	CB -11	☉	11.5	12.7	3.5	-	-	-	-	-	
	-51	☉	16.0	15.6	3.5	-	-	-	-	-	
	CB -12	☉	14.0	12.7	3.5	-	-	-	-	Right-hand	
	-13	☉	14.0	12.7	3.5	-	-	-	-	Left-hand	
	CB -14	☉	18.51	12.7	3.5	-	-	-	-	Right-hand	
	-15	☉	18.51	12.7	3.5	-	-	-	-	Left-hand	
	CB -16	☉	18.0	12.7	3.5	-	-	-	-		
	-17	☉	21.0	15.6	3.5	-	-	-	-		
	CB -S3220	☉	7.94	7.94	1.0	2.0	-	-	-	-	
	-S4220	☉	11.12	11.12	2.0	2.0	-	-	-	-	
	CB -T2212	☉	7.48	-	1.5	1.2	-	-	-	-	
	-T3220	☉	10.87	-	2.0	2.0	-	-	-	-	

☉ : Available



Spare parts

Wrenches

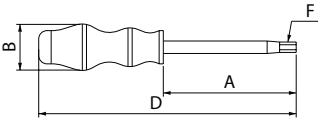
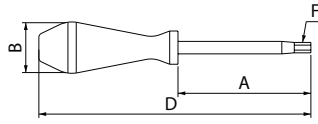
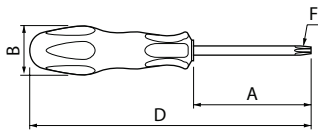
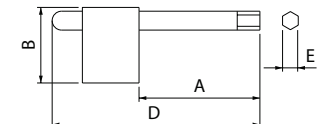
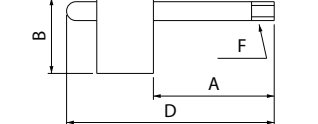
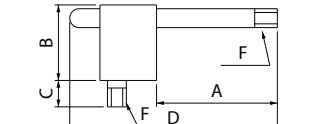
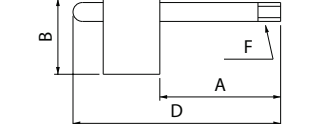
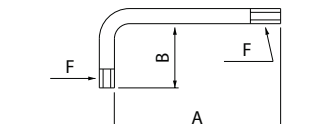
Shape	Description	Availability	Dimension (mm)						Angle		Remarks	
			A	B	C	D	E	F	α	θ		
	DT -7	☉	44	16	-	114	-	T7	-	-	Torx	
	-8	☉	70	26	-	150	-	T8	-	-		
	DT -10	☉	70	29	-	160	-	T10	-	-	Torx	
	-15	☉	70	32	-	170	-	T15	-	-		
	-20	☉	90	32	-	190	-	T20	-	-		
	-25	☉	82	36	-	190	-	T25	-	-		
	DTM -6	☉	40	17	-	115	-	T6	-	-	Torx Top of wrench is magnetized	
	-7	☉	44	17	-	119	-	T7	-	-		
	-8	☉	70	24	-	150	-	T8	-	-		
	-10	☉	70	28	-	167	-	T10	-	-		
	-15	☉	70	31	-	174	-	T15	-	-		
	DTP -6	☉	73	23	-	150	-	6IP	-	-	IP shows Torx Plus	
	-7	☉						7IP				
	-9	☉	61	30				174				9IP
	-15	☉	81	33				186				15IP
	-20	☉	100					206				20IP
	DTPM -8	☉	70	24	-	150	-	8IP	-	-	IP shows Torx Plus Top of wrench is magnetized	
	-10	☉	70	28	-	165	-	10IP	-	-		
-15	☉	70	31	-	174	-	15IP	-	-			
	FH -2	☉	40	20	-	71	2.0	-	-	-	Hexagon	
	-2.5	☉	45	20	-	76	2.5	-	-	-		
	FT -6	☉	35	15	-	65	-	T6	-	-	Torx	
	-7	☉	34	15	-	62	-	T7	-	-		
	-8	☉	40	20	-	74	-	T8	-	-		
	-10	☉	40	20	-	74	-	T10	-	-		
	FT -15	☉	45	25	10	80	-	T15	-	-	Torx	
	FTP -5	☉	35	15	-	65	-	5IP	-	-	IP shows Torx Plus	
	-6	☉	34		-	62	-	6IP	-	-		
	LTW -8SS	☉	43	6	-	-	-	T8	-	-	Torx	
	-10S	☉	62	10	-	-	-	T10	-	-		
	-10SS	☉	47	7	-	-	-	T10	-	-		
	-15S	☉	62	10	-	-	-	T15	-	-		
	-20	☉	58	19	-	-	-	T20	-	-		
	-25	☉	65	20	-	-	-	T25	-	-		

☉: Available



Spare parts

Shape	Description	Availability	Dimension (mm)						Angle		Remarks
			A	B	C	D	E	F	α	θ	
	LW	-1.5	⊕	45	14			1.5			Hexagon
		-2	⊕	50	16			2.0			
		-2.5	⊕	56	18			2.5			
		-3	⊕	63	20			3.0			
		-4	⊕	70	25			4.0			
		-4.5	⊕	78	26			4.5			
		-5	⊕	80	28			5.0			
		-6	⊕	90	32			6.0			
		-8	⊕	109	36			8.0			
		-10	⊕	112	40			10.0			
		-14	⊕	140	56			14.0			
		-17	⊕	160	63			17.0			
		-19	⊕	180	70			19.0			
	TH	-4	⊕	-	80		83	4.0			Hexagon
	TT	-15	⊕		70		118		T15		Torx
		-25	⊕		70		69		T25		
		-25L	⊕		80		145		T25		
		-30	⊕		80		110		T30		
	TTC	-20	⊕		98		130		T20		
		-25	⊕		98		130		T25		
	TTP	-20	⊕		70		138		20IP		IP shows Torx Plus
	TTW	-15	⊕		80		125		T15		Torx
	LTK	-5	⊕	70	30						
	SP	-20	⊕	8.5	5.6						Spring
		-30	⊕	12.0	7.2						
		-5	⊕	12.0	6.7						
		-50	⊕	12.0	7.2						
		-6	⊕	12.0	7.7						
	W	-6	⊕	11.5	1.6	6.4					Washer
		6-14	⊕	11.5	1.4	6.4					
	WB	-5	⊕	10.0	1.0	5.3					Washer (Brass)
		-6	⊕	11.5	1.6	6.4					
	WSP	-1	⊕	15.1	4.0	3.5	2.5		R1.25		Spacer

⊕ : Available

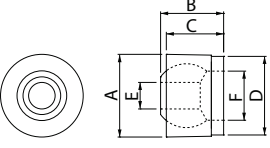
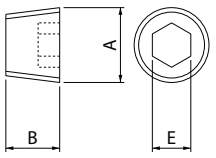
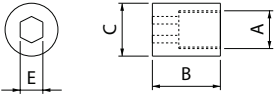
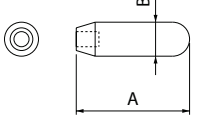
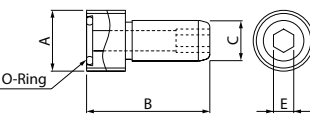
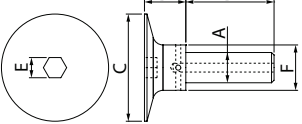
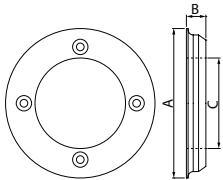
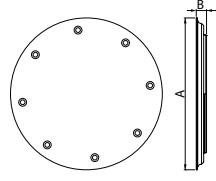
Shape	Description	Availability	Dimension (mm)						Angle		Remarks
			A	B	C	D	E	F	α	θ	
	DN 10	☉	6.2	5.1	4.5	5.7	2.6	4.0	-	-	Nozzle
	20	☉	10.1	7.7	7.0	9.6	M4X0.7	6.0	-	-	
	GP -1	☉	PT1/8	7.0	-	-	5.0	-	-	-	Plug
	-2	☉	PT1/4	9.0	-	-	6.0	-	-	-	
	WN -1	☉	M5X8	10.0	7.0	-	3.0	-	-	-	Nut
	PC -1	☉	60.0	8.5	-	-	-	-	-	-	Punch
	-2	☉	62.2	10.0	-	-	-	-	-	-	
	CL 63-1	☉	M18X1.0	36.5	12	-	6.0	-	-	-	Coolant pipe
	100-1	☉	M24X1.5	44.0	16.0	-	8.0	-	-	-	
	HH 12X35HC	☉	M12X1.75	35.0	42.5	16.4	8.0	18.0	-	-	Arbor bolt
	HF 16X44HC	☉	M16X2.0	-	-	14.4	-	-	-	-	
	16X48HC	☉	M16X2.0	30.0	62.5	18.4	12.0	40.0	-	-	
	CC -125-MFAH	☉	87.5	11.4	53.0	-	-	-	-	-	Coolant cover
	-160-MFAH	☉	122.5	12.4	70.0	-	-	-	-	-	
	CC -200-MFAH	☉	162.5	-	-	-	-	-	-	-	Coolant cover
	-250-MFAH	☉	212.5	14.4	-	-	-	-	-	-	
	-315-MFAH	☉	277.5	-	-	-	-	-	-	-	

☉: Available



Spare parts

External toolholders

Description			Spare Parts					
			Lever	Lock screw	Shim	Shim Pin	Punch	Wrench
PSBN%	1616H	-09	LL-1N	LS-1N	LS-32	LSP-1	PC-1	FH-2.5
PSKN%	1616H	-09	LL-1N	LS-1N	LS-32	LSP-1	PC-1	FH-2.5

External toolholders

Description			Spare Parts			
			Lever	Lock screw	Shim Pin	Wrench
PTGN%	1212F	-11	LL-03N	LS-03N	P-03	FH-2
	-11	LL-03TN	LS-03SN	P-03S	FH-2.5
PTFN%	1212F	-11	LL-03N	LS-03N	P-03	FH-2
	-11	LL-03TN	LS-03SN	P-03S	FH-2.5

Toolholders for ceramic tools

Description			Spare parts				
			Chipbreaker	Clamp set	Wrench	Shim	Shim screw
CCLNR	2525M	-16	CB-17	CE-220	LW-4	SP-454	M4X10
CS-N%	-12	CB-11	CE-020	LW-4	SP-141 *(SP-143)	M3X8 *(M3X12)
CSKN%	-12	CB-11	CE-020	LW-4	SP-141 *(SP-143)	M3X8 *(M3X12)
CSYN%	-12	CB-11	CE-020	LW-4	SP-141 *(SP-143)	M3X8 *(M3X12)
CSSN%	-12	CB-11	CE-020	LW-4	SP-141 *(SP-143)	M3X8 *(M3X12)

* Shim & shim screw: When using SN□□1204 Insert, purchase spare parts in () separately.

Toolholders for ceramic tools

Description			Spare parts			
			Clamp set	Wrench	Shim	Shim screw
CCLN%	-12GX	CE-410	LW-4	SP-441	M3X8
CDHN%	-12GX	CE-410	LW-4	SP-521	M3X8
		-15GX			SP-541	
CDJN%	-12GX	CE-410	LW-4	SP-521	M3X8
		-15GX			SP-541	
CSRN%	-12GX	CE-410	LW-4	SP-141	M3X8
		-15GX			SP-162	M4X10
CSDNN	-12GX	CE-410	LW-4	SP-141	M3X8
		-15GX			SP-162	M4X10
CSSN%	-12GX	CE-410	LW-4	SP-141	M3X8
		-15GX			SP-162	M4X10
CS-N%	-12GX	CE-410	LW-4	SP-141	M3X8
		-15GX			SP-162	M4X10
CSKN%	-12GX	CE-410	LW-4	SP-141	M3X8
		-15GX			SP-162	M4X10
CSYN%	-12GX	CE-410	LW-4	SP-141	M3X8
		-15GX			SP-162	M4X10

P



Spare parts

Toolholders for solid CBN tools

Description	Spare parts			
	Clamp set	Wrench	Shim	Shim screw
CCLN% -09A	CE-030A	LW-4	SP-429	HH3X12
CSRN% 2525M -09A 2525M -12A	CE-030A	LW-4	SP-129	HH3X12
			SP-148 *(SP-143)	BH3X12
CSKN% 2525M -09A 2525M -12A	CE-030A	LW-4	SP-129	HH3X12
			SP-148 *(SP-143)	BH3X12
CSYN% 2525M -09A 2525M -12A	CE-030A	LW-4	SP-129	HH3X12
			SP-148 *(SP-143)	BH3X12
CSDNN -09A 2525M -12A	CE-040	LW-4	SP-129	HH3X12
			SP-148 *(SP-143)	BH3X12
CTUN% -11A	CE-030A	LW-4	SP-219	HH3X12

* Shim for -12A type toolholder : When using SN□□1204 insert, purchase spare parts in () separately.

Toolholders for bearing machining

Description	Spare parts					
	Lever	Lock screw	Shim	Shim pin	Punch	Wrench
PRGC% -12BE -16BE	LL-1CN	LS-1N	LR-12C	LSP-1	PC-1	FH-2.5
	LL-2C	LS-1T	LR-16C	LSP-2	PC-2	FH-2.5
PRGC% -12BF -16BF	LL-1CN	LS-1N	LR-12C	LSP-1	PC-1	FH-2.5
	LL-2C	LS-1T	LR-16C	LSP-2	PC-2	FH-2.5

Toolholders for back turning

Description	Spare parts			
	Anchor pin	Lock screw	Clamp screw	Wrench
AABSR 0810K -40F 1010.. -40F 1212.. -40F 1616.. -40F	LPA-11	HSB4X8R	-	FH-2
	LPA-13			
	LPA-17			
	-			
SABSR -40F	-	-	SB-3080TR	FT-10
AABWR 0810K -40F 1010.. -40F 1212.. -40F 1616.. -40F	LPA-11	HSB4X8R	-	FH-2
	LPA-13			
	LPA-17			
	-			
SABWR -40F	-	-	SB-3080TR	FT-10
AABWR 0810K -50F 1010.. -50F 1212.. -50F 1616.. -50F	LPA-11	HSB4X8R	-	FH-2
	LPA-13			
	LPA-17			
	-			
SABWR -50F	-	-	SB-3080TR	FT-10

KTKF

Description	Spare parts	
	Clamp screw	Wrench
KTKF% -12 -16	SB-4590TRWN	LTW-10S



External toolholders (back clamp)

Description	Spare Parts		
	Anchor Pin	Lock Screw	Wrench
ACLC%	0810K -06F	LPF-11	HSB4X8%
	1010K -06F		
	1010K -09F		
	1212M -09F		
	1616M -09F		
ADJC%	0810K -07F	LPF-11	HSB4X8%
	1010K -07F		
	1010K -11F		
	1212M -11F		
	1616M -11F		
ADNCR	0810K -07F	LPF-11	HSB4X8R
	1010K -07F		
	1010K -11F		
	1212M -11F		
	1616M -11F		
AVJB%	1010K -11F	LPF-11	HSB4X8%
	1212M -11F		
	1616M -11F		
AVVBR	1010K -11F	LPF-1113	HSB4X8R
	1212M -11F		
	1616M -11F		

* Lock screw: HSB4X8R for R-hand toolholder, HSB4X8L for L-hand toolholder.

External toolholders (screw clamp)

Description	Spare parts		
	Clamp screw	Wrench	
SCLC% -06	SB-2570TR	FT-8
 -09	SB-4085TR	FT-15
 -12	SB-5090TR	LTW-20
SCAC% -06	SB-2570TR	FT-8
 -09	SB-4085TR	FT-15
	1212F -09FF		
SDJC% -07F	SB-2570TR	FT-8
 -11F	SB-4085TR	FT-15
SDLC% -07FF	SB-2570TR	FT-8
 -11FF	SB-4085TR	FT-15
SDXC% -07	SB-2570TR	FT-8
 -11	SB-4085TR	FT-15
SDNC% -07F	SB-2570TR	FT-8
 -11F	SB-4085TR	FT-15
SDNCN -07	SB-2570TR	FT-8
 -11	SB-4085TR	FT-15
SDLP% -07F	SB-2570TR	FT-8
 -11F	SB-4085TR	FT-15
STGC% -08	SB-2050TR	FT-6
STGP% -08	SB-2050TR	FT-6
 -11	SB-3080TR	FT-10
 -11F	SB-2570TR	FT-8
SVJB% -11F	SB-2570TR	FT-8
SVLP% -08FF	SB-2050TR	FT-6
 -11FF	SB-2570TR	FT-8
 -11F		
SVPP% -08FF	SB-2050TR	FT-6
 -11FF	SB-2570TR	FT-8
 -11		
SYXP% -06F	SB-2050TR	FT-6

P

Spare parts

External toolholders (screw clamp)

Description	Spare parts		
	Clamp screw	Wrench	Plug
SCLCR -09FFJCT	SB-4085TR	FT-15	GP-1
SDJCR -11..JCT	SB-4085TR	FT-15	GP-1
SVJBR -11FFJCT	SB-2570TR	FT-8	GP-1
SVJPR -11FFJCT	SB-2570TR	FT-8	GP-1

External toolholders (screw clamp)

Description	Spare parts				
	Clamp screw	Wrench	Shim	Shim screw	Wrench
SVBP%L -11	SB-2570TR	FT-8	-	-	-
..... -16N	SB-40125TRN	FT-15	SVN-32N	SS-4N	LW-4
SVVBN -11	SB-2570TR	FT-8	-	-	-
..... -16N	SB-40125TRN	FT-15	SVN-32N	SS-4N	LW-4

External toolholders (top clamp)

Description	Spare Parts				
	Clamp Set	Wrench	Shim	Shim Screw	Chipbreaker
CSBP%L -09N	CPS-2P	LW-2.5	-	-	CB-S3220
CSKP%L -09N	CPS-2P	LW-2.5	-	-	CB-S3220
 -12N	CPS-3	LW-3	KPS-42	SP3X8
CSSP%L -09N	CPS-2P	LW-2.5	-	-	CB-S3220
 -12N	CPS-3	LW-3	KPS-42	SP3X8
CSDPN -12N	CPS-3	LW-3	KPS-42	SP3X8	CB-S4220
CTGP%L -11N	CPS-2P	LW-2.5	-	-	CB-T2212
 -16N	CPS-3	LW-3	KPT-32	SP3X8
CTFP%L -11N	CPS-2P	LW-2.5	-	-	CB-T2212
 -16N	CPS-3	LW-3	KPT-32	SP3X8
CTTP%L -11N	CPS-2P	LW-2.5	-	-	CB-T2212
 -16N	CPS-3	LW-3	KPT-32	SP3X8



Spare parts

EZ Bar PLUS

Description	Spare parts	
	Clamp screw	Wrench
S045X-SCLCR03-050EZ	SB-1635TR	FT-6
S060X-SCLCR04-070EZ	SB-2035TR	
C045X-SCLCR03-050EZ	SB-1635TR	FT-6
C060X-SCLCR04-070EZ	SB-2035TR	

Twin-bars

Description			Spare parts	
			Clamp screw	Wrench
STW%	-15	SB-3080TR	LTW-10S
STWSR	-15T	SB-3080TR	LTW-10S

System tip-bars

Description			Spare parts			
			Clamp screw	Wrench	Screw (Side stopper)	Wrench
SVNR	1010H	-12	SB-3080TR	FT-10	HS3X4	LW-1.5
	1212K	-12			HS3X8	
	1616K	-12			HS3X12	
	2020K	-12			HS3X16	
	2525M	-12				
SVNSR	-12-..	SB-3080TR	LTW-10S	HS3X4	LW-1.5
S12F-	SVNR	12	SB-3080TR	FT-10	HS3X4	LW-1.5
S14G-	SVNR	12				
S16H-	SVNR	12				
S19H-	SVNR	12				
S19N-	SVNR	12				
S20H-	SVNR	12				
S25H-	SVNR	12				
S25Q-	SVNR	12				
S...	SVNR	12S			SB-3080TR	

P

System tip-bars (S-SVN-XN)

Description			Spare Parts		
			Clamp screw	Wrench	Clamp screw
S...-	SVNR	12XN	SB-3080TR	FT-10	SP3X4

PSH Sleeve

Description			Spare parts	
			Clamp screw	Wrench
PSH	02..	..	HS3X4P	LW-1.5
	03..	..		
PSH	04..	..	HS4X4P	LW-2
	05..	..		
	06..	..		
	07..	..		

Spare parts

Boring bars (screw clamp)

Description	Spare parts	
	Clamp screw	Wrench
S10H- SCLC%03-.E	SB-1635TR	FT-6
S10J- SCLC%04-.E	SB-2035TR	
S08X- SCLC%06-10E	SB-2545TR	FT-8
S08X- SCLC%06-10	SB-2545TR	FT-8
C...- SCLC%03-..	SB-1635TR	FT-6
C...- SCLC%04-..	SB-2035TR	
C08L- SCLC%06-10	SB-2545TR	FT-8
A08H- SCLC%06-10E	SB-2545TR	FT-8
E...- SCLC%06-..	SB-2545TR	FT-8
S..M- SCLP%08-.E	SB-35TR	FT-10
S...- SCLP%09-.E	SB-4TR	FT-15
S..M- SCLP%08-..	SB-35TR	FT-10
S...- SCLP%09-..	SB-4TR	FT-15
C10N- SCLP%08-..	SB-35TR	FT-10
C...- SCLP%09-..	SB-4TR	FT-15
A..X- SCLP%08-.E	SB-35TR	FT-10
A...- SCLP%09-.E	SB-4TR	FT-15
E10N- SCLP%08-12	SB-35TR	FT-10
E10N- SCLP%08-12A-..	SB-3060TR	
E...- SCLP%09-..	SB-4TR	FT-15
S...- SDUC%07-.E	SB-2560TR	FT-8
S...- SDUC%11-.E	SB-4085TR	FT-15
S...- SDUC%07-..	SB-2560TR	FT-8
S...- SDUC%11-..	SB-4085TR	FT-15
C...- SDUC%07-..	SB-2560TR	FT-8
C...- SDUC%11-..	SB-4085TR	FT-15
S...- SDZC%07-.E	SB-2560TR	FT-8
S...- SDZC%11-.E	SB-4085TR	FT-15
S...- SDZC%07-..	SB-2560TR	FT-8
S...- SDZC%11-..	SB-4085TR	FT-15
C06J- STLB%06-08A	SB-2035TR	FT-6
E08L- STLP%08-10A	SB-1TR	
E08L- STLP%09-10A	SB-2545TR	FT-8
E10N- STLP%09-..	SB-3060TR	FT-10
E10N- STLP%11-..		
S06H- STUB%06-08E	SB-15TR	FT-6
S08K- STUP%08-10E	SB-1TR	
S..M- STUP%09-.E	SB-2TR	FT-8
S...- STUP%11-.E	SB-3TR	FT-10
S..X- STUP%16-.E	SB-4TR	FT-15
S06H- STUB%06-08	SB-15TR	FT-6
S08K- STUP%08-10	SB-1TR	
S..M- STUP%09-..	SB-2TR	FT-8
S...- STUP%11-..	SB-3TR	FT-10
S25X- STUP%16-32	SB-4TR	FT-15
C10L- STUB%06-08	SB-15TR	FT-6
C08L- STUP%08-10	SB-1TR	
C...- STUP%09-..	SB-2TR	FT-8
C...- STUP%11-..	SB-3TR	FT-10
C20S- STUP%16-..	SB-4TR	FT-15
A08H- STUP%08-10E	SB-1TR	FT-6
A..X- STUP%09-.E	SB-2TR	FT-8
A...- STUP%11-.E	SB-3TR	FT-10
A...- STUP%16-.E	SB-4TR	FT-15
E08L- STUP%08-10	SB-1TR	FT-6
E...- STUP%09-..	SB-2TR	FT-8
E...- STUP%11-..	SB-3TR	FT-10
E20S- STUP%16-25	SB-4TR	FT-15



Boring bars (screw clamp)

Description	Spare parts		
	Clamp screw		Wrench
S...- SWUB%08...E	SB-2050TR		FT-6
S12M- SWUP%11-14E	SB-2545TR		FT-8
S...- SWUP%11...E	SB-2560TR		
S...- SWUP%16...E	SB-4065TR		FT-15
S...- SWUB%06...	SB-2040TR		FT-6
S10J- SWUB%08...	SB-2035TR		
C...- SWUB%06...	SB-2035TR		FT-6
C07K- SWUB%08...			
C08L- SWUB%08...		SB-2050TR	
C10N- SWUB%08...			
C12Q- SWUP%11-14(-./.)	SB-2545TR		FT-8
C12Q- SWUP%11-16(-./.)	SB-2560TR		
C16X- SWUP%11-18(-./.)			
C...- SWUP%16...	SB-4065TR		FT-15
E...- SWUB%08...	SB-2050TR		FT-6
S16Q- SSKPR09-20	SB-4TR		FT-15
S20R- SSKPR09-25			
S25X- SSKPR12-32	GS-50S		LW-3
S32S- SSKPR12-40	GS-50		
S12M- SYXP%06-12E	SB-2040TR		FT-6
S16Q- SYXP%06-16E	SB-2045TR		

Boring bars (screw clamp)

Description	Spare parts				
	Clamp screw	Wrench	Shim	Shim screw	Wrench (For shim screw)
S12M- SVJP%08-16E	SB-2050TR	FT-6	-	-	-
S...- SVJC%08...E					
S...- SVJB%11...E	SB-2570TR	FT-8			
S...- SVJB%16...EN	SB-40125TRN	FT-15	SVN-32N	SS-4N	LW-4
S32S- SVJB%16-40E	SB-40115TR	FT-15	SVN-32	SB-2050TR	FT-6
S40T- SVJB%16-50E					
S10M- SVPC%08-16E	SB-2050TR	FT-6			
S...- SVPB%11...E	SB-2570TR	FT-8			
S...- SVPB%16...EN	SB-40125TRN	FT-15	SVN-32N	SS-4N	LW-4
S25X- SVPB%16-34E	SB-40115TR	FT-15	SVN-32	SB-2050TR	FT-6
S32S- SVPB%16-40E					
S12M- SVUC%08-16E	SB-2050TR	FT-6			
S...- SVUB%11...E	SB-2570TR	FT-8			
S...- SVUB%16...EN	SB-40125TRN	FT-15	SVN-32N	SS-4N	LW-4
S25X- SVUB%16-34E	SB-40115TR	FT-15	SVN-32	SB-2050TR	FT-6
S32S- SVUB%16-40E					
S12M- SVZC%08-16E	SB-2050TR	FT-6			
S...- SVZB%11...E	SB-2570TR	FT-8			
S...- SVZB%16...EN	SB-40125TRN	FT-15	SVN-32N	SS-4N	LW-4
S25X- SVZB%16-34E	SB-40115TR	FT-15	SVN-32	SB-2050TR	FT-6
S32S- SVZB%16-40E					
S12M- SVZC%08-16E	SB-2050TR	FT-6			
S...- SVZB%11...E	SB-2570TR	FT-8			
S...- SVZB%16...EN	SB-40125TRN	FT-15	SVN-32N	SS-4N	LW-4
S25X- SVZB%16-34E	SB-40115TR	FT-15	SVN-32	SB-2050TR	FT-6
S32S- SVZB%16-40E					

Boring bars (top clamp)

Description	Spare Parts				
	Chipbreaker	Clamp Set	Wrench	Shim	Shim Screw
S12L- CTUP%09-16	-	CPS-1	FH-2	-	-
S...- CTUP%11...	-	CPS-2	FH-2.5	-	-
S25X- CTUP%16-34	-	CPS-3	LW-3	-	-
S32S- CTUP%16-43				KPT-32	SP3X10
S40X- CTUP%16-50					
S32S- CTUC%16-40	*CB-13/12	CE-320	LW-4	SP-230P	SP3X10
S...- CCLN%09...A	-	CE-360S	LW-4	SP-420A	BH3X6
S...- CSKN%09...A	-	CE-360S	LW-4	SP-130A	BH3X12
S32S- CSKPR12-43	CPS-3	-	LW-3	KPS-42	SP3X10

* CB-13 for Right-hand Toolholder, CB-12 for Left-hand Toolholder.



Boring bars for ceramic tools (top clamp)

Description	Spare parts				
	Chipbreaker	Clamp set	Wrench	Shim	Shim screw
S32S- CCLN%L -12-40GX	-	CE-410	LW-4	-	-
S40T- CCLN%L -12-50GX				SP-441P	M3X8
S32S- CDUN%L -12-40GX	-	CE-410	LW-4	-	-
S40T- CDUN%L -12-50GX				SP-521P	M3X8
S32S- CSKN%L -12-40GX	-	CE-410	LW-4	-	-
S40T- CSKN%L -12-50GX				SP-141P	M3X8
S40T- CSKN%L -12-50	*1 CB-13/12	CE-320	LW-4	SP-141P *2 (SP-143P)	M3X8 *2 (M3X12)

*1 CB-13 for right-hand toolholder, CB-12 for left-hand toolholder.

*2 When using SN□□1204 Insert, please purchase spare parts in () separately.

Boring toolholders for bearing machining (Square shank) (Boring)

Description	Spare parts		
	Clamp screw	Wrench	
SRCP%L 2020B-12 -A20	SB-4TR	FT-15	
2525B-16 -A32	SB-5090TR	LTW-20	

Boring toolholders for bearing machining (Square shank) (Internal round chamfering)

Description	Spare parts		
	Clamp set	Wrench	
CBSN%L ...B-12 -A20	CP-RC%L	LW-5	

Sleeves for tip-bars

Description	Spare parts			
	Screw	Wrench		
PH 02 ...	HS3X4	LW-1.5		
				03 ...
				04 ...
05 ...	HS4X4	LW-2		
06 ...				
07 ...				

KTGF

Description	Spare parts		
	Clamp screw	Wrench	
KTGF%L -16F	SB-4070TRW	FT-8	
KTGF%L -16	SB-4070TRS	FT-10	

S-KTGF

Description	Spare parts		
	Clamp screw	Wrench	
S.... -KTGFL16	SB-4070TRS	FT-10	

KTG

Description	Spare parts		
	Clamp screw	Wrench	
KTG%L -16	SB-4TR	FT-15	
.... 22-..	GS-50	LW-3	

KN91

Description	Spare parts					
	Clamp	Clamp bolt	Washer	Spring	Wrench	
KN91%L 44 -4	*CE-111/121	BH8X30	W-8	SP-8	LW-5	
						44 -5
						44 -7
	*CE-131/141					

* KN91%L44-4/5 ... CE-111 for right-hand toolholder, and CE-121 for left-hand toolholder.

KN91%L44-7 ... CE-131 for right-hand toolholder, and CE-141 for left-hand toolholder.

KGHS

Description	Spare parts					
	Clamp	Clamp bolt	Washer	Spring	Wrench	
KGHS%L -4	CGH-1 ¹ / _r	HH6X25	W-6	SP-6	LW-5	
					 -5
					 -7
	CGH-2 ¹ / _r					

Clamp: KGHS%L ... CGH-○L for right-hand toolholder, and CGH-○R for left-hand toolholder.



Spare parts

KGA

Description	Spare parts			
	Clamp	Clamp bolt	Spring	Wrench
KGA [®] /L -3	CGA-3 [®] /L	HH6X20	SP-6	LW-5
..... -4	CGA-4 [®] /L			
..... -5	CGA-5 [®] /L			

Clamp: CGA-[®]R for right-hand toolholder and CGA-[®]L for left-hand toolholder.

KGD[®]/L.....-S

Description	Spare parts		
	Clamp bolt (for insert clamp)	Clamp screw (for blade)	Wrench
KGD [®] /L-S	BH6X10TR	SB-60120TR	LTW-25

KGD-JCT (for automatic lathe)

Description	Spare parts		
	Clamp screw	Wrench	Plug
KGD [®] /L - ... JCT	SB-40120TR	LTW-15S	GP-1

KGDF[®]/L.....-S

Description	Spare Parts		
	Clamp bolt (for insert clamp)	Clamp screw (for blade)	Wrench
KGDF [®] /L-S	BH6X10TR	SB-60120TR	LTW-25

KGM

Description	Spare parts	
	Screw	Wrench
KGM [®] /L 1212H -3	SB-5TR	LTW-20
1616H -3	HH5X16	LW-4
2020K -3		
2525M -3		
KGM [®] /L 2020K -4	HH5X16	LW-4
2525M -4	HH5X25	
KGM [®] /L 2020K -5	HH5X16	LW-4
2525M -5	HH5X25	
3232P -5		
KGM [®] /L 2525M -8	HH6X25	LW-5
3232P -8		

KGM-T

Description	Spare parts	
	Screw	Wrench
KGM [®] /L 2012K-2T17	SB-5TR	LTW-20
2020K-2T17	HH5X16	LW-4
2525M-2T17	HH5X25	
KGM [®] /L 1616H-3T20	HH5X16	LW-4
2012K-3T20	SB-5TR	LTW-20
2020K-3T20	HH5X16	LW-4
2525M-3T20	HH5X25	
KGM [®] /L 2020K-4T20	HH5X16	LW-4
2525M-4T20	HH5X25	
2525M-4T25		
KGM [®] /L 2525M-5T25	HH5X25	LW-4
3232P-5T25		
KGM [®] /L 2525M-6T30	HH5X25	LW-4

KGM (for automatic lathe)

Description	Spare parts	
	Clamp screw	Wrench
KGM [®] /L 0810K - ...	SE-40120TR	LTW-15S
1010.. - ...		
1212.. - 1.5-...		
1212.. - 2-...		
1212.. - 2.5-...		
1616.. - 2-...	SE-50125TR	LTW-20
1616.. - 2.5-...		
1616.. - 3-...		

KGMM / KGMS

Description	Spare parts	
	Screw	Wrench
KGMM [®] /L 1212H-3	SB-5TR	LTW-20
1616H-3	HH5X16	LW-4
2020K-3		
2525M-3		
KGMS [®] /L 1212H-3	SB-5TR	LTW-20
1616H-3	GS-50	LW-3
2020K-3	HH5X16	LW-4
2525M-3	HH5X25	

P

Spare parts

KGMU

Description	Spare parts	
	Clamp bolt	Wrench
KGMU% 2020K	HH5X16	LW-4
2525M	HH5X25	

KIGH

Description	Spare parts				
	Clamp	Clamp bolt	Washer	Spring	Wrench
KIGHR-4	CGH-1L	HH6X25	W-6	SP-6	LW-5
....-5					
....-7					

KIGM-V

Description	Spare parts	
	Clamp screw	Wrench
KIGM% 2016B-3V	GS-50	LW-3
2520B-3V		
3225B-3V	SB-5TR	LTW-20
3225B-4V	SB-5TR	LTW-20
4032B-4V		

GFVS-AA / GFVT-AA

Description	Spare parts	
	Clamp set	Wrench
GFVS% -08AA	CPS-5V	FT-15
GFVT% -08AA	CPS-5V	FT-15

GIFV

Description	Spare parts	
	Clamp set	Wrench
GIFV% 5032B-502B	CPS-6V	LW-3

KTKF-JCT

Description	Spare parts		
	Clamp screw	Wrench	Plug
KTKF% - ...JCT	SB-4590TRWN	FT-10	GP-1

KTKFS (for sub spindle tooling)

Description	Spare parts	
	Clamp screw	Wrench
KTKFS% - ...	SB-4050TRN	LTW-10S

KTKH-S

Description	Spare parts
	Releasing wrench
KTKH% - ...S	LTK-5

KTKH-B

Description	Spare parts	
	Clamp screw	Wrench
KTKH% 0808K - ...B	SE-40120TR	FT-15
1010K - ...B		
1212M - ...B		
1414M - ...B		
1616M - ...B	SE-50125TR	LTW-20

KTTX

Description	Spare parts	
	Clamp screw	Wrench
KTTXR -16F	SB-4070TRW	FT-8



DRS

Description			Spare parts	
			Clamp screw	Wrench
S20	-DRS 10...		SB-2080TR	FT-6
	-DRS 11...		SB-2290TR	FT-6
	-DRS 12...		SB-25100TR	DT-7

DRX

Description			Spare parts	
			Clamp screw	Wrench
S..	-DRX - . -03		SB-2042TRG	DTM-6
	-DRX - . -04		SB-2042TRG	DTM-6
	-DRX - . -05		SB-2045TR	DTM-6
	-DRX - . -06		SB-2250TR	DTM-7
	-DRX - . -07		SB-2570TR	DTM-8
	-DRX - . -09		SB-3080TR	DTM-10
	-DRX - . -11		SB-4085TR	DTM-15
	-DRX - . -14		SB-5090TR	DT-20
	-DRX - . -17		SB-60120TR	DT-25

P



Spare parts

MFPN45 (Face mill)

Description	Spare parts		
	Clamp screw	Wrench	Anti-seize compound
MFPN 45100R-10T-M ? 45200R-20T-M	SB-40140TRN	DTM-15	P-37

MOF45

Description	Spare parts		
	Clamp screw	Wrench	Mounting bolt
MOF 45080R-05-6T 45100R-05-.T ? 45200R-05-.T	SB-4082TPR	DTP-15	HH12X35
MOF 45080R-07-5T 45100R-07-.T ? 45200R-07-.T			HH12X35
MOF 45040R-05-3T-M 45050R-05-4T-M 45063R-05-5T-M 45080R-05-6T-M 45100R-05-.T-M ? 45200R-05-.T-M	SB-4082TPR	DTP-15	HH8X25
MOF 45063R-07-4T-M 45080R-07-5T-M 45100R-07-.T-M ? 45200R-07-.T-M			HH10X30
			HH12X35
			-
			-

MOFX45

Description	Cartridge	Cartridge screw	Wedge	Wedge screw
MOFX45 ...	LOF07R	SH-50150TR	WOF07R	W8X21
Description	Adjustment screw	Wrench (for Wedge)	Wrench (for Cartridge)	
MOFX45 ...	AJ-412	TH-4	TTC-20	

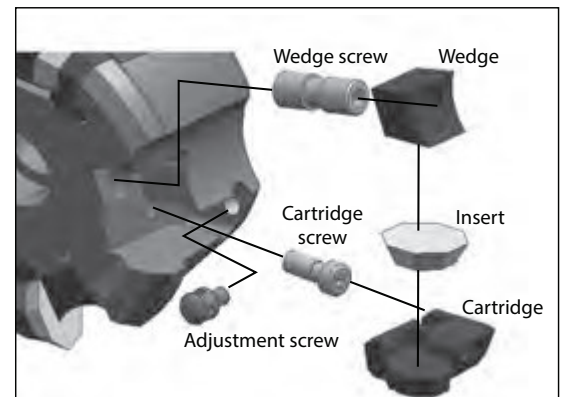

MSE45 (Face mill)

Description	(1) Clamp screw	(2) Wrench	(3) Shim	(4) Shim Screw	(5) Wrench
MSE 45040R-.T-M 45050R-.T-M	CP8X15TL (Left-hand Thread)	TTC-25	MSE-4245S	SP4X9	LW-2 (for Shim Screw)
MSE 45080R-.T 45200R-.T	CP8X23TL (Left-hand Thread)				
MSE 45063R-.T-M 45200R-.T-M					

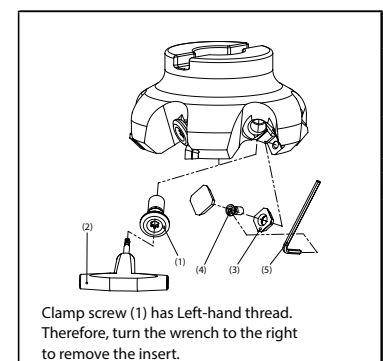

Mounting bolt (SP8X35) is included for MSE45040R-.T-M.
 Mounting bolt (HH10X30S) is included for MSE45050R-.T-M and MSE45063R-.T-M.
 Mounting bolt (HH12X35) is included for MSE45080R-.T-M and MSE45080R-.T.

MSE45 (End mill)

Description	Spare parts			
	Clamp set	Wrench	Shim	Shim screw
MSE 4550	CPS-6M	LW-3	MSE-4245	SP3X8
4563				
4580-32				

MSE45-SF (Face mill)

Description	(1) Cartridge	(2) Clamp	(3) Clamp	(4) Clamp screw	(5) Adjustment screw	(6) Wrench
MSE 45...R-T-SF 45...R-T-M-SF	LSE-445SR	C43R (for Insert)	C44R (for Cartridge)	W6X17	SV-60136TR	TTC-20

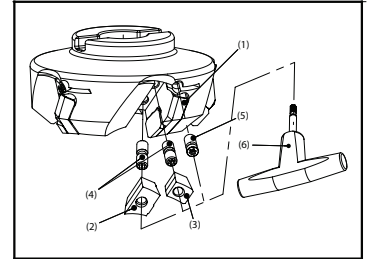

Mounting bolt (HH10X30S) is included for MSE45063R-4T-M-SF.
Mounting bolt (HH12X35) is included for MSE45080R-5T-M-SF.

MSD45 (Face mill)

Description	(1) Cartridge	(2) Cartridge clamp screw	(3) Clamp	(4) Clamp screw	Wrench
MSD 45...R	LSD-445R	HH4X16	C20R	TH8X15	TH-4

Mounting bolt (HH12X35) is included for MSD4580R.

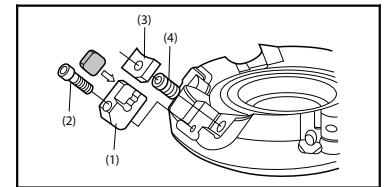

MSD45 (End mill)

Description	Spare parts			
	Clamp set	Wrench	Shim	Shim screw
MSD 4550	CPS-6M	LW-3	MSD-42	SP3X8
4563				
4580-32				



Spare parts

MSO45 (Face mill)

Description	(1) Cartridge	(2) Cartridge clamp screw	(3) Clamp	(4) Clamp screw	Wrench
MSO 45...R	LSO-445R	HH4X16	CH-20R	TH8X15	TH-4

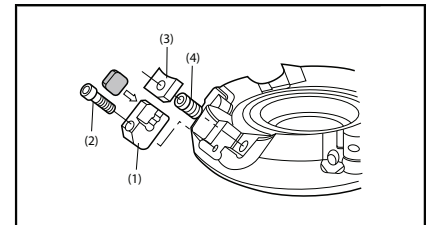

MSO45-S (End mill)

Description	Spare parts				
	Shim	Shim screw	Clamp	Clamp screw	Wrench
MSO 45...S	MSO-4T245	SP3X6	CH-20R	TH8X15	TH-4





MSO45-09 (Face mill)

Description	Spare parts	
	Clamp screw	Wrench
MSO 45...R-09	SB-3060TR	DT-10





MSO45-S-09 (End mill)

Description	Spare parts	
	Clamp screw	Wrench
MSO 45...S32-09	SB-3060TR	DT-10

MSP15 / MSE15 (End mill)

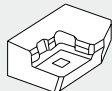
Description	Clamp set	Wrench	Shim	Shim screw
				
MSP 15..	CPS-6M	LW-3	MSP-42	SP3X8
MSE 15..	CPS-6M	LW-3	MSE-4215	SP3X8

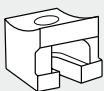
MSP15 (Face mill)

Description	(1) Cartridge	(2) Cartridge clamp screw	(3) Clamp	(4) Clamp screw	Wrench
					
MSP 15...R	LSP-415R	HH4X16	C25R	TH8X15	TH-4

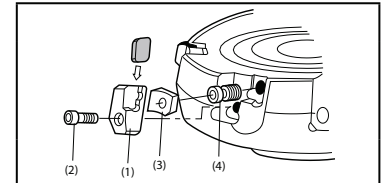

Mounting bolt (HH12X35) is included in MSP1580R.

MEC (Face mill)

Description	Spare parts	
	Clamp screw	Wrench
MEC ...R-11-..T(-M)	SB-2555TRG	DTM-8
MEC ...R-17-..T(-M)	SB-4070TRN	DTM-15

MEC (End mill)

Description	Spare parts	
	Clamp screw	Wrench
MEC ...W.-1103(-H)	SB-2545TR	DTM-8
MEC ...W.-11T3(-H)	SB-2555TRG	DTM-8
MEC ...W.-1704-H	SB-4070TRN	DTM-15





MECX (Face Mill)

Description	Spare parts	
	Clamp screw	Wrench
MECX 050R-07-12T-M 063R-07-14T-M	SB-2042TRG	DTM-6



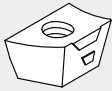

MECX (End mill)

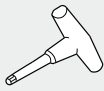
Description	Spare parts	
	Clamp screw	Wrench
MECX 32-S32-07-6T 33-S32-200-07-6T	SB-2042TRG	DTM-6

MTE90-SF

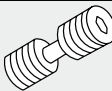

Description	Cartridge	Clamp	Clamp	Clamp screw	Adjustment screw	Wrench
						
MTE 90...SF	LTE-490SR	C91R (for Insert)	C92R (for Cartridge)	W8X16	SV-60136R	TTC-25

MTE90 (Face mill)

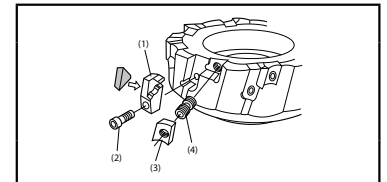
Description	(1) Cartridge	(2) Cartridge clamp screw	(3) Clamp	(4) Clamp screw	Wrench
					
MTE 90...R	LTE-490R	HH4X16	C17R	W8X18	TH-4

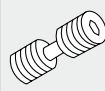
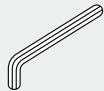

MTE90 (End mill)





Description	Spare parts				
	Clamp	Clamp screw	Wrench	Shim	Shim screw
					
MTE 9050 9063 9080-32	CP-8TE	W8X18	LW-4	MTE-42	SP3X8

P
Spare parts

MFWN (Face Mill)

Description	Spare parts		
	Clamp screw	Wrench	Anti-seize compound
MFWN 90100R-9T-M 2 90250R-18T-M	SB-40140TRN	DTM-15	P-37

MSO90 (Face mill)

Description	(1) Clamp screw	(2) Wrench	(3) Shim	(4) Shim screw	(5) Wrench
	MSO 90...R-15-T MSO 90...R-15-T-M				
	SB-45130TR	DTP-20	MSO-5200	SPW-6045	Lw-4.5 (For shim screw)

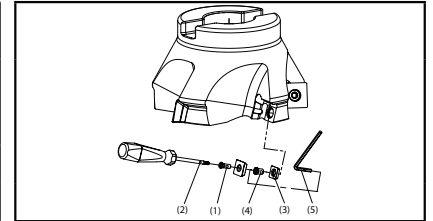

Mounting bolt (HH12X35) is included for MSO90080R-15-T-M and MSO90080R-15-T
Mounting bolt (HH10X30S) is included for MSO90063R-15-T-M

MSO90-S (End mill)

Description	Spare parts	
	Clamp screw	Wrench
MSO 90...S32-09 90...S32-15	SB-3080TR SB-5085TR	DT-10 DT-20

MSO90-09 (Face mill)

Description	Spare parts	
	Clamp screw	Wrench
MSO 90...R-09	SB-3080TR	DT-10

MEA / MEB

Description	Spare parts	
	Clamp screw	Wrench
MEA .. -S..(- ..)	SB-2560TR	DT-8
MEB .. -S..	SB-4085TR	DT-15



DMC

Description	Spare parts	
	Clamp screw	Wrench
DMC 8.. (- S..)	SB-2545TR	FT-8
DMC 0..	SB-3060TR	FT-10

MTP

Description	Spare parts				
	Clamp	Clamp screw	Wrench	Shim	Shim screw
MTP 90..	CP-8W	W8X18	LW-4	KPT-42	SP3X8

MTPS / MTES

Description	Clamp Set	Wrench
	 	2S 5ES
MTPS ... MTES ...	CPS-2S CPS-5ES	FT-15

MEAL

Description	Spare parts	
	Clamp screw	Wrench
MEAL .. -S..	SB-5085TR	DT-20

MRP-S (End mill)

Description	Spare parts	
	Clamp screw	Wrench
MRP ...-S.. -08(-...)	SB-3060TR	DT-10
...-S.. -10-T(-...)	SB-3080TR	DT-10
...-S.. -12(-T)(-...)	SB-4085TR	DT-15
050-S42 -12(-300)	SB-40115TR	
...-S.. -16(-...)	SB-50120TR	DT-20



Spare parts

MRP (Face mill)

Description			Spare parts	
			Clamp screw	Wrench
MRP	...R	-10-.T	SB-3080TR	DT-10
MRP	050R	-12	SB-40115TR	DT-15
	063R	-12		
	080R	-12		
	080R	-12-.7T	SB-4085TR	
MRP	...R	-16(-.T)	SB-50120TR	DT-20
MRP	...R	-20	SB-60120TR	DT-25

MHD (Helical end mill)

Description			Spare parts				
			Clamp screw	Wrench	Clamp bolt		Wrench
					1 Front piece	2 Front pieces	
MHD	32-S32	-SA	SB-2560TR	DT-8	-	HH8X50	LW-6
	40-S32	-SA					
	40-S42	-SA	SB-3080TR	DT-10		HH8X65	
	50-S42	-SA				HH12X65	LW-10
MHD	40-S42	-SB	SB-3080TR	DT-10	HH8X40	-	LW-6
	50-S42	-SB			HH12X40	-	LW-10
MHD	20S-S20	-C	SB-2560TR	DT-8	-	-	-
	25-S25	-C					
	32-S32	-C					
	40-S42	-C	SB-3080TR	DT-10			
	50-S42	-C					
MHD	32-S32	-A	SB-2560TR	DT-8	HH8X35	HH8X50	LW-6
	40-S32	-A					
	40-S42	-A	SB-3080TR	DT-10	HH8X40	HH8X65	
	50-S42	-A			HH12X40	HH12X65	LW-10
MHD	32-S32	-A-130	SB-2560TR	DT-8	HH8X35	HH8X50	LW-6
	40-S32	-A-150	SB-3080TR	DT-10	HH8X40	HH8X65	
	50-S42	-A-150			HH12X40	HH12X65	LW-10
MHD	40-S42	-B	SB-3080TR	DT-10	HH8X40	-	LW-6
	50-S42	-B			HH12X40	-	LW-10
MHD	32	-F	SB-2560TR	DT-8	-	-	-
	40	-F	SB-3080TR	DT-10			
	50	-F					



Spare parts

MHD (face mill and integral arbor type)

Description			Spare parts			
			Clamp screw	Wrench	Clamp bolt	Wrench
MHD	63-FMA	-SA	SB-3080TR	DT-10	HH16X90	LW-14
	80-FMA	-SA			HH20X110	LW-17
	100-FMA	-SA			HH24X110	LW-19
MHD	63-FMA	-A			HH16X90	LW-14
	80-FMA	-A			HH20X110	LW-17
	100-FMA	-A			HH24X110	LW-19
MHD	63-BT50	-SA			HH16X65	LW-14
	80-BT50	-SA			HH20X90	LW-17
	100-BT50	-SA			HH24X90	LW-19
MHD	63-BT50	-A			HH16X65	LW-14
	80-BT50	-A			HH20X90	LW-17
	100-BT50	-A			HH24X90	LW-19
MHD	63	-F			-	-
	80	-F				
	100	-F				

MHD (Radius)

Description	Spare parts							
	Clamp screw		Wrench		Clamp bolt		Wrench	
	For bottom insert	For middle insert	For bottom insert	For middle insert	1 Front piece	2 Front pieces		
MHD 32-S32 -4RSA	SB-2560TR	SB-2560TR	DT-8	DT-8	-	HH8X50	LW-6	
40-S32 -5RSA	SB-3080TR	SB-3080TR	DT-10	DT-10		HH8X55		
40-S42 -5RSA			DT-15			HH12X55		LW-10
50-S42 -6RSA	SB-4085TR							
MHD 32-S32 -A	SB-2560TR		DT-8		-	HH8X50	LW-6	
40-S32 -A	SB-3080TR		DT-10			HH8X65		
40-S42 -A						HH12X65		LW-10
50-S42 -A								
MHD 32 -F	SB-2560TR		DT-8		-	-	-	
40 -F	SB-3080TR		DT-10					
50 -F								
MHD 32 -4RF	SB-2560TR	SB-2560TR	DT-8	DT-8	-	-	-	
40 -5RF	SB-3080TR	SB-3080TR	DT-10	DT-10				
50 -6RF	SB-4085TR		DT-15					

MEZ

Description	Spare parts	
	Clamp screw	Wrench
MEZ 16-S16....	SB-2040TRG	DTM-6
20-S20....	SB-2555TRG	DT-8
25-S25....	SB-3070TRG	DT-10
32-S32....	SB-4070TRG	DT-15
40-S32....	SB-3070TRG	DT-10
50-S42....	SB-4070TRG	DT-15

MGI

Description	Spare parts	
	Clamp set	Wrench
MGI-1C	CPS-6F	LW-3

MVG

Description	Spare parts	
	Clamp set	Wrench
MVG	CPS-6V	LW-3

Blank tool

Description	Spare parts	
	Coolant pipe	
T63H -BL...-....	CL63-1	

Flange holder

Description	Spare parts						
	Screw	Wrench	Mounting bolt	Wrench	Adjustment screw	Wrench	
SF22F -SCLCL09 -40P	SB-4085TR	FT-15	HH5X30	LW-4	HS3X4	LW-1.5	
-SDUCL11 -40P	SB-4085TR	FT-15	HH5X30	LW-4	HS3X4	LW-1.5	
-SVUBL11 -40P	SB-2570TR	FT-8	HH5X30	LW-4	HS3X4	LW-1.5	
-KTGFL16 -40P	SB-4070TRS	FT-10	HH5X30	LW-4	HS3X4	LW-1.5	
-KTTXL16 -40P	SB-4070TRW	FT-8	HH5X30	LW-4	HS3X4	LW-1.5	

Flange holder (Sleeve type)

Description	Spare parts					
	Mounting bolt	Wrench	Adjustment screw	Wrench	Screw (for fixing toolholder)	Wrench
SF22F -SH.. -40P	HH5X30	LW-4	HS3X4	LW-1.5	HS6X4P	LW-3



R

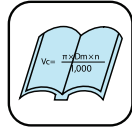

General information	R2-R19
ISO13399 compliant dimension markings	R2
SI unit conversion table / Cutting symbol	R6
Surface roughness	R7
Heat treatment and hardness expression	R8
Vickers hardness conversion chart	R9
Material list (JIS)	R10
Material cross reference table	R11
Various cross reference tables	R20-R29
Insert grades cross reference table	R20
Molded chipbreaker cross reference table	R26
Milling insert description cross reference table	R28
Terms and angles of toolholder	R30-R35
Turning toolholder	R30
Milling cutter	R31
End mills	R32
Solid drills	R33
Precautions when using wiper inserts	R34
Trouble shooting	R38-R41
Cutting edges figuration and countermeasures	R38
Turning	R39
Milling	R40
Drilling	R41
Basic formulas	R42-R45
Turning	R42
Milling	R44
Drilling	R45
Tooling examples of small parts machining	R46-R55
Tooling example	R46
Automatic lathe list by manufacturer	R48
List of instruments and applicable small parts machining and toolholders	R54
Parts compatibility of lever lock toolholders	R55

All dimension markings in the catalog are complied with ISO13399. Symbol, detail and previous symbol are shown below.

1. Insert

Symbol	Detail	Previous symbol
AN	Relief angle	α
D1	Hole diameter	$\varnothing d$
IC	I.C. Size	A
RE	Corner-R	$r\epsilon$
S	Insert thickness	T

2. Toolholder for external

Symbol	Detail	Previous symbol
B	Shank width	B
H	Shank height	H1
HF	Edge height	h
LF	Overall length	L1
LH	Head length	L2
WF	Functional width	F1

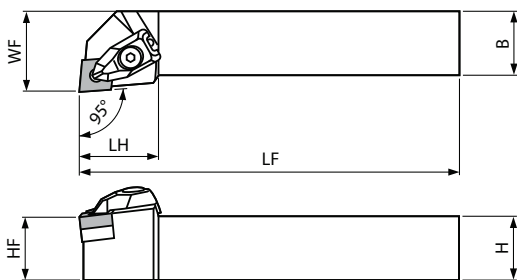
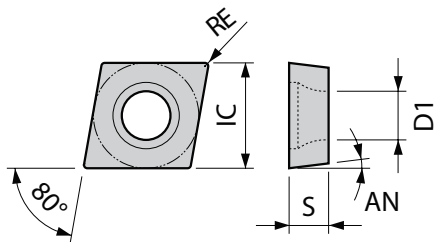
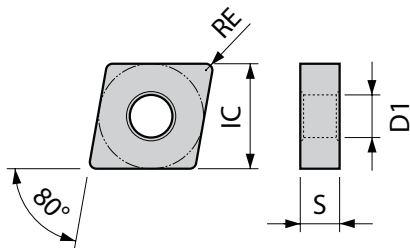

3. Small parts machining

Symbol	Detail	Previous symbol
B	Shank width	B
H	Shank height	H1
HF	Edge height	h
LF	Overall length	L1
LH	Head length	L2
LU	Usable length	L2
WF	Functional width	F1

4. Boring bars

Symbol	Detail	Previous symbol
DMIN	Min. bore dia.	$\varnothing A$
DCON	Shank dia.	$\varnothing D, \varnothing D1$
GAMO	Rake angle	θ
H	Shank width	H
LF	Overall length	L1
LH	Head length	L2
LPR	Overall length	L1
LU	Usable length	L2
RE	Corner-R	$r\epsilon$
WF	Functional width	F

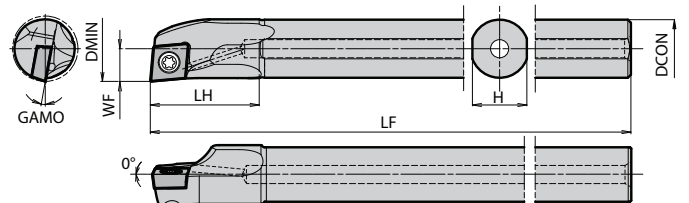
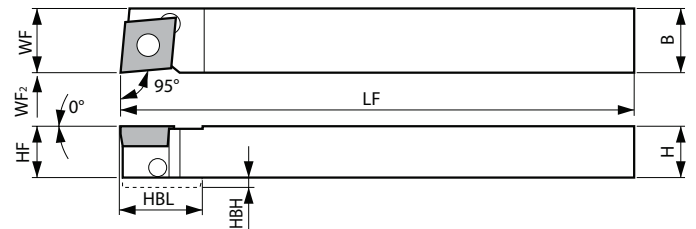

R



Technical information

5. Grooving / Cut-off inserts

Symbol	Detail	Previous symbol
IC	I.C. Size	A
BCH	Chamfer width	C
CDX	Max. cutting depth	B
CW	Edge width	W
D1	Hole diameter	$\varnothing d$
DAXN	External dia. of the groove (max.)	$\varnothing D$
DAXX	External dia. of the groove (min.)	$\varnothing D$
INSL	Insert length	L
PSIR ⁹ /L	Lead angle	θ
RE	Corner-R	r_e
S	Insert thickness	H, T
W1	Insert width	A

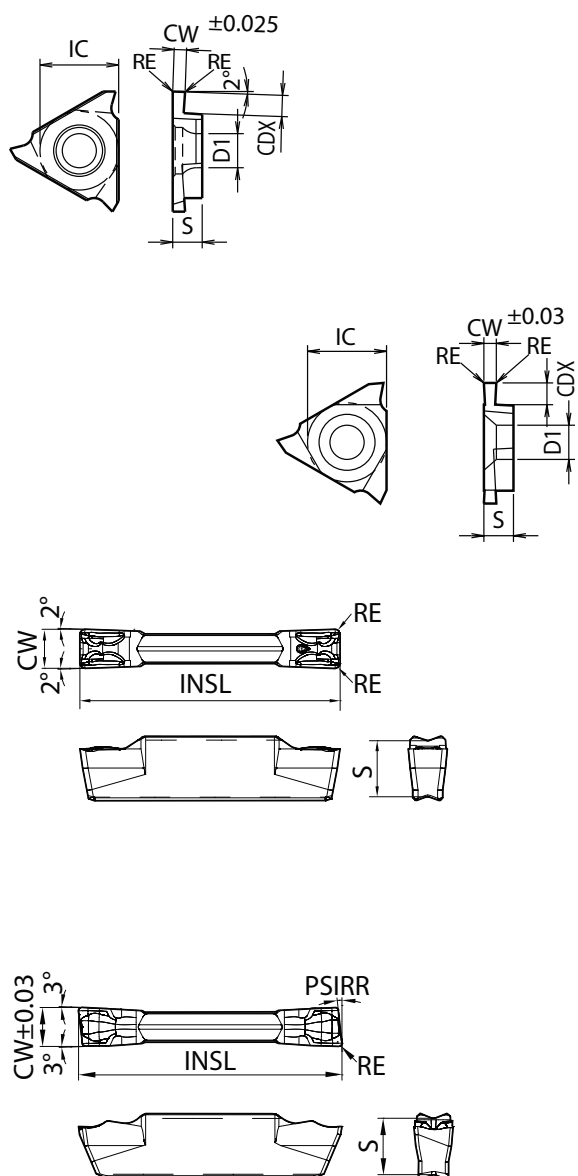

6. Grooving / Cut-off toolholders

Symbol	Detail	Previous symbol
B	Shank width	B
CDX	Max. cutting depth	T
CUTDIA	Max. cut-off dia.	$\varnothing D_{max}$
DAXN	External dia. of the groove (max.)	$\varnothing D$
DAXX	External dia. of the groove (min.)	$\varnothing D$
DCB	Connection bore dia. (Sleeve)	$\varnothing d_1$
DMIN	Min. Bore dia.	$\varnothing A$
DCON	Shank dia.	$\varnothing D, \varnothing D_1$
H	Shank height	H1
HF	Edge height	h
LF	Overall length	L1
LH	Head length	L2
WF	Functional width	F1

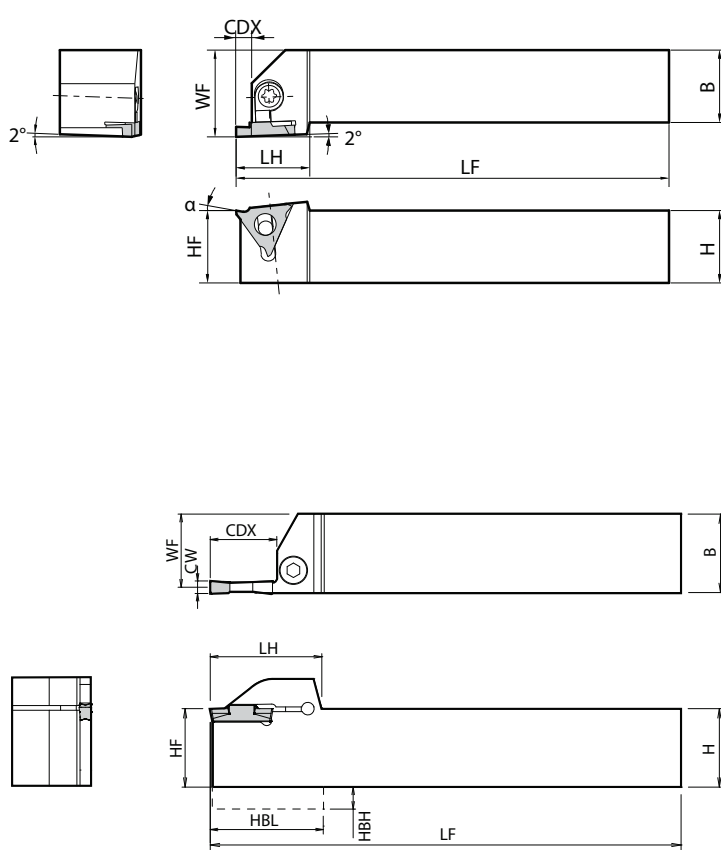

R
 Technical information

7. Threading inserts

Symbol	Detail	Previous symbol
IC	I.C. S size	A
D1	Hole diameter	$\varnothing d$
PNA	Thread angle	θ
PDX	Profile distance	S
S	Insert thickness	T
RE	Corner-R	$r\epsilon$

8. Threading toolholders

Symbol	Detail	Previous symbol
B	Shank width	B
DMIN	Min. Bore dia.	$\varnothing A$
DCON	Shank dia.	$\varnothing D$
H	Shank height	H1
HF	Edge height	h
LF	Overall length	L1
LH	Head length	L2
LU	Usable length	L2
WF	Functional width	F, F1

9. Inserts for drill

Symbol	Detail	Previous symbol
IC	I.C. Size	A
D1	Hole diameter	$\varnothing d$
DC	Drill dia.	$\varnothing Dc$
PL	Insert point length	Lp
RE	Corner-R	$r\epsilon$
S	Insert thickness	T
INSL	Insert length	A
W1	Insert width	W

10. Drill holder

Symbol	Detail	Previous symbol
DC	Drill dia.	$\varnothing Dc$
DCON	Shank dia.	$\varnothing Ds$
OAL	Overall length	L
LU	Usable length (Drilling depth)	L3
PL	Insert point length	Lp
LS	Shank length	Ls
DCSFMS	Flange dia.	$\varnothing d1$
LFS	Functional length	L1
LCF	Flute length	L2

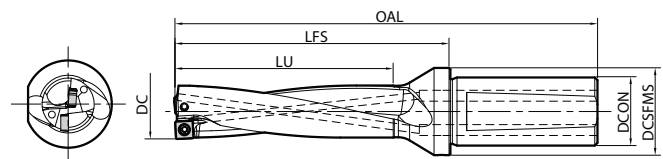
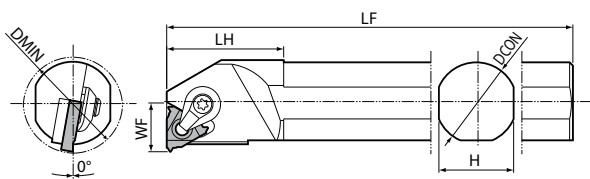
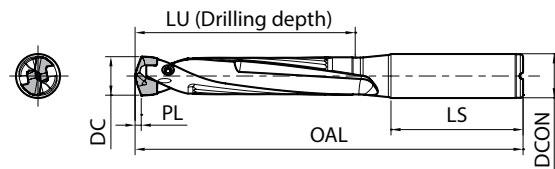
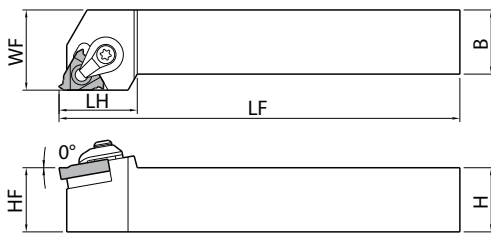
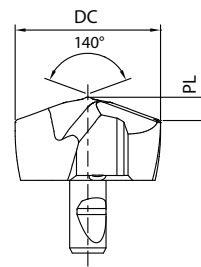
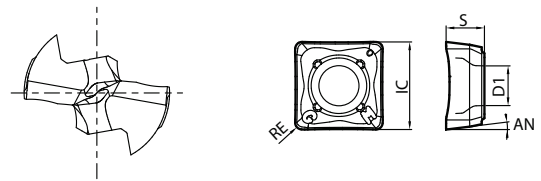
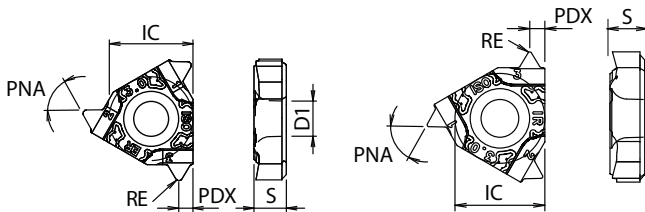

R



Technical information

11. Solid end mill

Symbol	Detail	Previous symbol
APMX	Max. depth of cut	ℓ
CHW	Chamfer width	C
DC	Cutting dia.	ϕD_c
DCON	Shank dia.	ϕD_s
DN	Neck dia.	ϕD_1
LF	Overall length	L
LU	Under neck length	ℓ_2
RE	Corner-R	$r\epsilon, r$
ZEPF	No. of inserts	Z

12. Solid drill

Symbol	Detail	Previous symbol
OAL	Overall length	L
DC	Cutting dia.	ϕD_c
DCON	Shank dia.	ϕD_s
LCF	Flute length	ℓ
LN	Under neck length	ℓ_2
LS	Shank length	Ls
LU	Usable length	ℓ_e

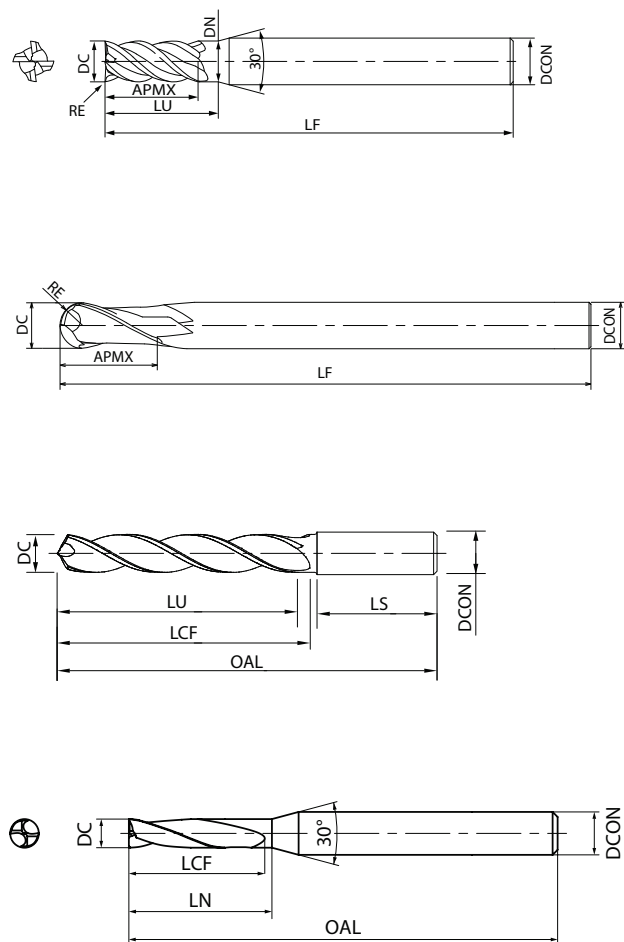

13. Milling inserts

Symbol	Detail	Previous symbol
BCH	Corner chamfer length	X
BS	Wiper edge width	Z
D1	Hole diameter	ϕd
IC	I.C. Size	A
INSL	Insert length	W
L	Cutting edge length	W
RE	Corner-R	$r\epsilon$
S	Insert thickness	T

14. Toolholder for milling

Symbol	Detail	Previous symbol
APMX	Max. depth of cut	S
CBDP	Connection bore depth	E
DC	Cutting dia.	ϕD
DCB	Bore dia.	ϕd
DCON	Shank dia.	ϕD_s
DCSFMS	Contact surface dia.	ϕD_2
DCX	Maximum cutting dia.	ϕD_1
KDP	Keyway depth	a
KWW	Keyway width	b
LF	Toolholder height	H
LH	Head length	ℓ

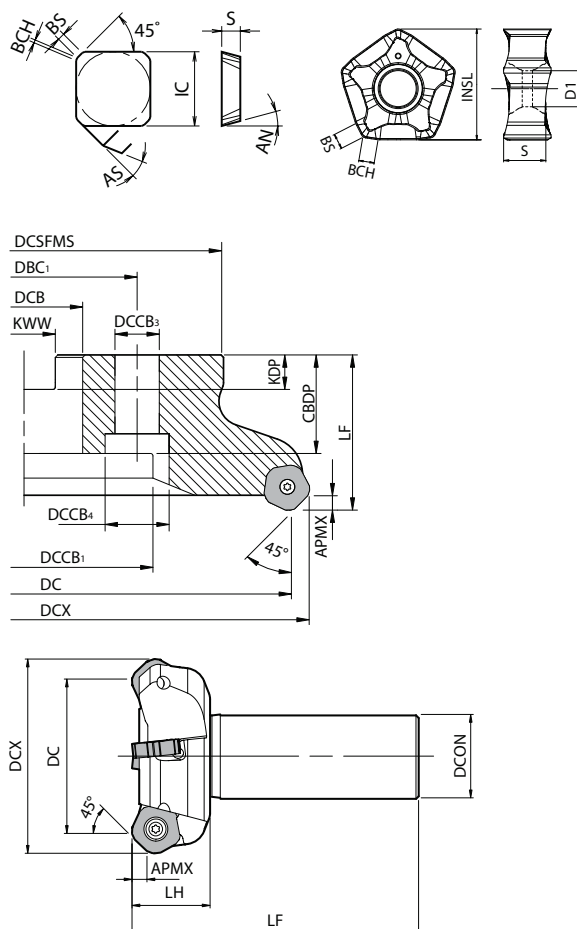

R



Technical information

SI derived units conversion chart

Bold units are the ones by SI derived unit.

Extracted from JIS handbook "Iron & steel"

Force

N	kgf	dyn
1	1.01972×10^{-1}	1×10^5
9.806 65	1	$9.806 65 \times 10^5$
1×10^5	1.01972×10^{-6}	1

Stress

1Pa=1N/m², 1MPa=1N/mm²

Pa or N/m ²	MPa or N/mm ²	kgf/mm ²	kgf/cm ²	kgf/m ²
1	1×10^{-6}	1.01972×10^{-7}	1.01972×10^{-5}	1.01972×10^{-1}
1×10^6	1	1.01972×10^{-1}	1.01972×10	1.01972×10^5
9.806 65 x 10⁶	9.806 65	1	1×10^2	1×10^6
9.806 65 x 10⁴	9.806 65 x 10⁻²	1×10^{-2}	1	1×10^4
9.806 65	9.806 65 x 10⁻⁶	1×10^{-6}	1×10^{-4}	1

Pressure

1Pa=1N/m²

Pa	kPa	MPa	bar	kgf/cm ²
1	1×10^{-3}	1×10^{-6}	1×10^{-5}	1.01972×10^{-5}
1×10^3	1	1×10^{-3}	1×10^{-2}	1.01972×10^{-2}
1×10^6	1×10^3	1	1×10	1.01972×10
1×10^5	1×10^2	1×10^{-1}	1	1.01972
9.806 65 x 10⁴	9.806 65 x 10	9.806 65 x 10⁻²	$9.806 65 \times 10^{-1}$	1

Cutting symbol

Cutting conditions below are indicated by the new symbols listed in 2nd column.

1. Turning

Cutting conditions	Symbol	Previous symbol	Unit
Cutting speed	Vc	V	m/min
Feed rate	f	f	mm/rev
Depth of cut	ap	d	mm
Edge width	CW	W	mm
Workpiece dia.	Dm	D	mm
Required power	Pc	Pkw	kW
Specific cutting force	kc	Ks	MPa
Theoretical surface roughness	h	Rz	μm
Corner radius	RE	R	mm
Revolution	n	N	min ⁻¹

3. Drilling

Cutting conditions	Symbol	Previous symbol	Unit
Cutting speed	Vc	V	m/min
Feed speed	Vf	F	mm/min
Feed rate	f	f	mm/rev
Drill dia.	DC	D (Ds)	mm
Required power	Pc	Pkw	kW
Specific cutting force	kc	Ks	MPa
Drilling depth	H	d	mm
Revolution	n	N	min ⁻¹

2. Milling

Cutting conditions	Symbol	Previous symbol	Unit
Cutting speed	Vc	V	m/min
Feed speed	Vf	F	mm/min
Feed per tooth	fz	f	mm/t
Feed rate	f	f	mm/rev
No. of inserts	Z	Z	teeth
Depth of cut	ap	d	mm
Width of cut	ae	w	mm
Pick feed	Pf	Pf	mm
Required power	Pc	Pkw	kW
Specific cutting force	kc	Ks	MPa
Chip removal volume	Q	Q	cm ³ /min
Revolution	n	N	min ⁻¹

R



Technical information

Theoretical (Geometrical) surface roughness

Theoretical surface roughness for turning indicates the minimum roughness value from the cutting conditions and it is shown by the formula as follows.

$$Rz(h) = \frac{f^2}{8RE} \times 10^3$$

Rz(h): Theoretical surface roughness [μm]
 f: Feed rate [mm/rev]
 RE: Corner radius of insert [mm]

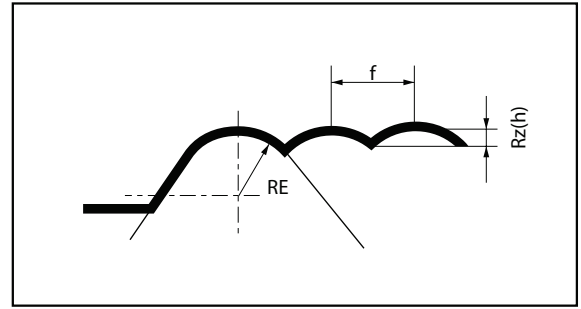

How to obtain surface roughness values

Type	Symbol	How to obtain	Explanation
Max. height roughness	Rz	Rz is a mean value in micron meter obtained from the distance of the highest peaks and the lowest valleys within the range of sampled reference length ("l") in the direction of the center line of the roughness curve. Note) When calculating Rz, extraordinarily high or low threads are considered as damages and excluded from the calculation, and only standard lengths are used. $Rz = Rp + Rv$	
Ten points mean roughness	RzJIS	RzJIS is a mean value in micron meter obtained from the distance of 5 highest peaks (Yp) and the 5 lowest valleys (Yv) measured from the center line of the roughness curve within the range of sampled reference length "l". $RzJIS = \frac{(Yp1+Yp2+Yp3+Yp4+Yp5) + (Yv1+Yv2+Yv3+Yv4+Yv5)}{5}$	 Yp1, Yp2, Yp3, Yp4, Yp5: Distance from the mean line to the highest 5 peaks in the range of sampled reference length "l" Yv1, Yv2, Yv3, Yv4, Yv5: Distance from the mean line to the lowest 5 valleys in the range of sampled reference length "l"
Arithmetical mean roughness	Ra	Ra is obtained from the following formula in micron meter, the roughness curve is expressed by $y=f(x)$, the X-axis is in the direction of the center line and the Y-axis is the vertical magnification of the roughness curve in the range of sampled reference length "l". $Ra = \frac{1}{l} \int_0^l \{f(x)\} dx$	

Relationship with triangle symbol

Arithmetical mean roughness Ra (μm)	Max. height roughness Rz (μm)	Ten points mean roughness RzJIS (μm)	*(Triangle symbol)
0.025	0.1	0.1	▽▽▽▽
0.05	0.2	0.2	
0.1	0.4	0.4	
0.2	0.8	0.8	
0.4	1.6	1.6	▽▽▽
0.8	3.2	3.2	
1.6	6.3	6.3	
3.2	12.5	12.5	▽▽
6.3	25	25	
12.5	50	50	▽
25	100	100	

* Triangle symbol was removed from JIS standard in the 1994 Revision.

How to Indicate

- When Ra is $1.6\mu\text{m} \rightarrow 1.6\mu\text{m}Ra$
- When Rz is $6.3\mu\text{m} \rightarrow 6.3\mu\text{m}Rz$
- When RzJIS is $6.3\mu\text{m} \rightarrow 6.3\mu\text{m}RzJIS$

Indication in JIS standard

Example of Ra indication		Example of Rz indication	
1. When indicating the upper limit only (when upper limit is $6.3\mu\text{m}Ra$)		1. When indicating the upper limit only indicate surface roughness following the parameter symbol.	
2. When indicating both lower and upper limit (when upper limit is $6.3\mu\text{m}Ra$, lower limit is $1.6\mu\text{m}Ra$)		2. When indicating both lower and upper limit indicate surface roughness as (upper limit ~ lower limit) following the parameter symbol.	

Note: The indications of Ra and Rz are different.

Caution-symbols for surface roughness

The above information is based on JIS B 0601-2001. However, some symbols were revised as shown in the right table in accordance with ISO Standard from JIS B 0601-2001 version. Ten Points Mean Roughness (Rz) was eliminated from 2001 version but it still remains as RzJIS reference, since it was popular in Japan.

Type	Symbol of JIS B 0601-1994	Symbol of JIS B 0601-2001
Max. height roughness	Ry	Rz
Ten points mean roughness	Rz	(RzJIS)
Arithmetical mean roughness	Ra	Ra

Heat treatment

One of the ways to determine the hardness of steel is the heat treatment and it is classified to 3 types.

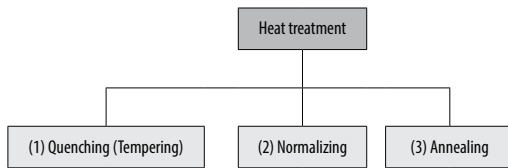

Heat treatment method	Detail	Effect
	<ul style="list-style-type: none"> · Quenching (Tempering) After heating to 727°C or over, cool rapidly down to 550°C in water or oil. 	Quenching makes steel hard. Because it cools down red-hot steel very rapidly in water or oil, but it may promote internal stress. In order to remove such internal stress, tempering is used. (After cooled down once, reheat it to 200°C ~ 600°C)
	<ul style="list-style-type: none"> · Normalizing After heating to 727°C or over, cool down rapidly to 600°C and then to normal temperature. 	It miniaturizes the crystals. (Steel is also composed of small cells.) It is used to improve the mechanical character or machinability.
	<ul style="list-style-type: none"> · Annealing After heating to 727°C or over, cool down very slowly to 600°C, then to normal temperature. 	It miniaturizes the crystals like the process of normalizing, but the crystal size is bigger than that of normalizing. It targets machinability improvement and distortion correction.

Hardness expression

Hardness	Reference standard	Example	Explanation of example
Brinell hardness	JIS Z 2243: 1992	250HB	Hardness value: 250, Hardness symbol: HB
		200 ~ 250HB	When the hardness has the range
Vickers hardness	JIS Z 2244: 1998	640HV	Hardness value: 640, Hardness symbol: HV
Rockwell hardness	JIS Z 2245: 1992	60HRC	Hardness value: 60, Hardness symbol: HRC
Shore hardness	JIS Z 2246: 1992	50HS	Hardness value: 50, Hardness symbol: HS



Vickers hardness conversion chart

Vickers hardness (HV)	Brinell hardness 10mm dia. ball Load: 3,000kgf (HB)		Rockwell hardness ²⁾			Shore hardness (HS)	Tensile strength MPa ¹⁾
	Standard ball	Tungsten carbide ball	A scale Load: 60kgf Diamond point (HRA)	B scale Load: 100kgf 1.6mm (1/16in) dia. ball (HRB)	C scale Load: 150kgf Diamond point (HRC)		
940	-	-	85.6	-	68.0	97	
920	-	-	85.3	-	67.5	96	
900	-	-	85.0	-	67.0	95	
880	-	(767)	84.7	-	66.4	93	
860	-	(757)	84.4	-	65.9	92	
840	-	(745)	84.1	-	65.3	91	
820	-	(733)	83.8	-	64.7	90	
800	-	(722)	83.4	-	64.0	88	
780	-	(710)	83.0	-	63.3	87	
760	-	(698)	82.6	-	62.5	86	
740	-	(684)	82.2	-	61.8	84	
720	-	(670)	81.8	-	61.0	83	
700	-	(656)	81.3	-	60.1	81	
690	-	(647)	81.1	-	59.7	-	
680	-	(638)	80.8	-	59.2	80	
670	-	630	80.6	-	58.8	-	
660	-	620	80.3	-	58.3	79	
650	-	611	80.0	-	57.8	-	
640	-	601	79.8	-	57.3	77	
630	-	591	79.5	-	56.8	-	
620	-	582	79.2	-	56.3	75	
610	-	573	78.9	-	55.7	-	
600	-	564	78.6	-	55.2	74	
590	-	554	78.4	-	54.7	-	2055
580	-	545	78.0	-	54.1	72	2020
570	-	535	77.8	-	53.6	-	1985
560	-	525	77.4	-	53.0	71	1950
550	505	517	77.0	-	52.3	-	1905
540	496	507	76.7	-	51.7	69	1860
530	488	497	76.4	-	51.1	-	1825
520	480	488	76.1	-	50.5	67	1795
510	473	479	75.7	-	49.8	-	1750
500	465	471	75.3	-	49.1	66	1705
490	456	460	74.9	-	48.4	-	1660
480	448	452	74.5	-	47.7	64	1620
470	441	442	74.1	-	46.9	-	1570
460	433	433	73.6	-	46.1	62	1530
450	425	425	73.3	-	45.3	-	1495
440	415	415	72.8	-	44.5	59	1460
430	405	405	72.3	-	43.6	-	1410
420	397	397	71.8	-	42.7	57	1370
410	388	388	71.4	-	41.8	-	1330
400	379	379	70.8	-	40.8	55	1290
390	369	369	70.3	-	39.8	-	1240
380	360	360	69.8	(110.0)	38.8	52	1205
370	350	350	69.2	-	37.7	-	1170
360	341	341	68.7	(109.0)	36.6	50	1130
350	331	331	68.1	-	35.5	-	1095
340	322	322	67.6	(108.0)	34.4	47	1070
330	313	313	67.0	-	33.3	-	1035

Vickers hardness (HV)	Brinell hardness 10mm dia. ball Load: 3,000kgf (HB)		Rockwell hardness ²⁾			Shore hardness (HS)	Tensile strength MPa ¹⁾
	Standard ball	Tungsten carbide ball	A scale Load: 60kgf Diamond point (HRA)	B scale Load: 100kgf 1.6mm (1/16in) dia. ball (HRB)	C scale Load: 150kgf Diamond point (HRC)		
320	303	303	66.4	(107.0)	32.2	45	1005
310	294	294	65.8	-	31.0	-	980
300	284	284	65.2	(105.5)	29.8	42	950
295	280	280	64.8	-	29.2	-	935
290	275	275	64.5	(104.5)	28.5	41	915
285	270	270	64.2	-	27.8	-	905
280	265	265	63.8	(103.5)	27.1	40	890
275	261	261	63.5	-	26.4	-	875
270	256	256	63.1	(102.0)	25.6	38	855
265	252	252	62.7	-	24.8	-	840
260	247	247	62.4	(101.0)	24.0	37	825
255	243	243	62.0	-	23.1	-	805
250	238	238	61.6	99.5	22.2	36	795
245	233	233	61.2	-	21.3	-	780
240	228	228	60.7	98.1	20.3	34	765
230	219	219	-	96.7	(18.0)	33	730
220	209	209	-	95.0	(15.7)	32	695
210	200	200	-	93.4	(13.4)	30	670
200	190	190	-	91.5	(11.0)	29	635
190	181	181	-	89.5	(8.5)	28	605
180	171	171	-	87.1	(6.0)	26	580
170	162	162	-	85.0	(3.0)	25	545
160	152	152	-	81.7	(0.0)	24	515
150	143	143	-	78.7	-	22	490
140	133	133	-	75.0	-	21	455
130	124	124	-	71.2	-	20	425
120	114	114	-	66.7	-	-	390
110	105	105	-	62.3	-	-	-
100	95	95	-	56.2	-	-	-
95	90	90	-	52.0	-	-	-
90	86	86	-	48.0	-	-	-
85	81	81	-	41.0	-	-	-

Extracted from JIS handbook "Iron & steel" (SAE J 417)

Note:

1. 1 MPa = 1 N/mm²

2. Value in () is not in practical use, but reference only.



Technical information

Ferrous materials

Classification	Name of JIS standard	Symbol	
Structural steel	Rolled steel for welded structure	SM	
	Re-rolled steel	SRB	
	Rolled steel for general structure	SS	
	Light gauge steel for general structure	SSC	
	Hot-rolled steel plate, sheet and strip for automobile structural use	SAPH	
Steel sheet	Cold-rolled steel plate, sheet and strip	SPC	
	Hot-rolled soft steel plate, sheet and strip	SPH	
Steel pipe	Carbon steel pipe for ordinary piping	SGP	
	Carbon steel pipe for boiler / heat exchanger	STB	
	Seamless steel pipe for high pressure gas cylinder	STH	
	Carbon steel pipe for general structural use	STK	
	Carbon steel pipe for machine structural use	STKM	
	Alloy steel pipe for structural use	STKS	
	Stainless steel pipe for machine structural use	SUS-TK	
	Steel square pipe for general structural use	STKR	
	Alloy steel pipe for ordinary piping	STPA	
	Carbon steel pipe for pressure service	STPG	
	Carbon steel pipe for high-temperature service	STPT	
	Carbon steel pipe for high-pressure service	STS	
	Stainless steel pipe for ordinary piping	SUS-TP	
	Machine structural steel	Carbon steel for machine structural use	SxxC,SxxCK
Aluminum chromium molybdenum steel		SACM	
Chromium molybdenum steel		SCM	
Chromium steel		SCr	
Nickel chromium steel		SNC	
Nickel chromium molybdenum steel		SNCM	
Manganese steel and manganese chromium steel for machine structural use		SMn,SMnC	
Special steel	Tool steel	Carbon tool steel	SK
		Hollow drill steel	SKC
		Alloy tool steel	SKS,SKD,SKT
		High speed tool steel	SKH
	Special steel	Free cutting carbon steel	SUM
		High carbon chromium bearing steel	SUJ
		Spring steel	SUP
	Stainless steel	Stainless steel bar	SUS-B
		Hot-rolled stainless steel plate, sheet and strip	SUS-HP,SUS-HS
		Cold-rolled stainless steel plate, sheet and strip	SUS-CP,SUS-CS
	Heat-resisting steel	Heat-resisting steel bar	SUH-B,SUH-CB
		Heat-resisting steel plate and sheet	SUH-HP,SUH-CP
	Superalloy	Corrosion-resisting and heat-resisting superalloy bar	NCF-B
		Corrosion-resisting and heat-resisting superalloy plate and sheet	NCF-P

Classification	Name of JIS standard	Symbol	
Forged steel	Carbon steel forging	SF	
	Chromium molybdenum steel forging	SFCM	
	Nickel chromium molybdenum steel forging	SFNCM	
Cast iron	Gray cast iron	FC	
	Spheroidal graphite cast iron	FCD	
	Blackheart malleable cast iron	FCMB	
	Whiteheart malleable cast iron	FCMW	
	Pearlitic malleable cast iron	FCMP	
	Cast steel	Carbon cast steel	SC
		High tensile strength carbon cast steel & low alloy cast steel	SCC
		Stainless cast steel	SCS
Heat-resisting cast steel		SCH	
High manganese cast steel		SCMnH	
Cast steel for high temperature and high pressure service		SCPH	

Non-ferrous metals

Classification	Name of JIS standard	Symbol	
Copper	Copper and copper alloy sheet / strip	CxxxxP CxxxxPP CxxxxR	
	Copper and copper alloy rod and bar	CxxxxBD CxxxxBDS CxxxxBE	
Aluminum alloys and aluminum alloys expanded material	Aluminum and Al. alloy sheet / strip	AxxxxP AxxxxPC	
	Aluminum and Al. alloy rod, bar, and wire	AxxxxBE AxxxxBES AxxxxBD AxxxxBDS AxxxxW AxxxxWS	
		Aluminum and Al. alloy extruded shape	AxxxxS
		Aluminum and Al. alloy forging	AxxxxFD AxxxxFH
	Magnesium alloy expanded material	Magnesium alloy sheet and plate	MP
Magnesium alloy rod and bar		MB	
Nickel alloy	Nickel copper alloy sheet and plate	NCuP	
	Nickel copper alloy rod and bar	NCuB	
Titanium expanded material	Titanium rod and bar	TB	
Casting	Brass casting	CAC20x	
	High strength brass casting	CAC30x	
	Bronze casting	CAC40x	
	Phosphoric bronze casting	CAC50x	
	Aluminum bronze casting	CAC70x	
	Aluminum alloy casting	AC	
	Magnesium alloy casting	MC	
	Zinc alloy die casting	ZDCx	
	Aluminum alloy die casting	ADC	
	Magnesium alloy die casting	MD	
	White metal	WJ	

R



Technical information

Material cross reference table

Steel

Classification	Japan	China	USA	UK	Germany	France	Russia
	JIS	GB	AISI/SAE	BS	DIN	NF	ГОСТ
Carbon steel for machine structural use	S10C	08 10	1010	040A10 045A10 045M10	C10E C10R	XC10	
	S12C		1012	040A12		XC12	
	S15C	15	1015	055M15	C15E C15R		
	S17C		1017			XC18	
	S20C	20	1020	070M20 C22 C22E C22R	C22 C22E C22R	C22 C22E C22R	
	S22C		1023				
	S25C	25	1025	C25 C25E C22R	C25 C25E C25R	C25 C25E C25R	
	S28C		1029				25Г
	S30C	30	1030	080A30 080M30 C30 C30E C30R	C30 C30E C30R	C30 C30E C30R	30Г
	S33C						30Г
	S35C	35	1035	C35 C35E C35R	C35 C35E C35R	C35 C35E C35R	35Г
	S38C		1038				35Г
	S40C	40	1039 1040	080M40 C40 C40E C40R	C40 C40E C40R	C40 C40E C40R	40Г
	S43C		1042 1043	080A42			40Г
	S45C	45	1045 1046	C45 C45E C45R	C45 C45E C45R	C45 C45E C45R	45Г
	S48C			080A47			45Г
	S50C	50	1049	080M50 C50 C50E C50R	C50 C50E C50R	C50 C50E C50R	50Г
	S53C		1050 1053				50Г
	S55C	55	1055	070M55 C55 C55E C55R	C55 C55E C55R	C55 C55E C55R	
	S58C	60	1059 1060	C60 C60E C60R	C60 C60E C60R	C60 C60E C60R	60Г
	S09CK			045A10 045M10	C10E	XC10	
	S15CK	15F			C15E	XC12	
	S20CK					XC18	

R



Technical information

Material cross reference table

Steel

Classification	Japan	China	USA	UK	Germany	France	Russia
	JIS	GB	AISI/SAE	BS	DIN	NF	ГОСТ
Nickel chromium steel	SNC236				36NiCr6		40XH
	SNC415	12CrNi2			14NiCr10		
	SNC631	30CrNi3			36NiCr10		30XH3A
	SNC815	12Cr2Ni4		655M13	15NiCr13		
	SNC836	37CrNi3			31NiCr14		
Nickel chromium molybdenum steel	SNM220	20CrNiMo	8615	805A20	20NiCrMo2 20NiCrMoS2	20NCD 2	
			8617	805M20			
			8620	805A22			
			8622	805M22			
	SNM240		8637		40NiCrMo2-2		
			8640				
	SNM415						
	SNM420	18CrNiMnMoA	4320		17NiCrMo6-4		20XH2M (20XHM)
	SNM431				30CrNiMo8		
	SNM439	40CrNiMoA	4340		40NiCrMo6		
SNM447				34CrNiMo6			
SNM616							
SNM625							
SNM630							
SNM815							
Chromium steel	SCr415	15Cr			17Cr3		15X
		15CrA			17CrS3		15XA
	SCr420	20Cr	5120				20X
	SCr430	30Cr	5130	34Cr4	34Cr4	34Cr4	30X
			5132	34CrS4	34CrS4	34CrS4	
	SCr435	35Cr	5132	37Cr4	37Cr4	37Cr4	35X
37CrS4				37CrS4	37CrS4		
SCr440	40Cr	5140	530M40	41Cr4	41Cr4	40X	
			41Cr4	41CrS4	41CrS4		
SCr445	45Cr 50Cr					45X	
Chromium molybdenum steel	SCM415	15CrMo			15CrMo4		
	SCM418	20CrMo			18CrMo4 18CrMoS4		20XM
	SCM420			708M20	20CrMo5		20XM
	SCM421						
	SCM430	30CrMo 30CrMoA	4130				30XM 30XMA
	SCM432						
	SCM435	35CrMo	4137	34CrMo4	34CrMo4	34CrMo4	35XM
				34CrMoS4	34CrMoS4	34CrMoS4	
	SCM440	42CrMo	4140 4142	708M40	42CrMo4	42CrMo4	
709M40				42CrMoS4	42CrMoS4		
42CrMoS4							
SCM445		4145					
		4147					
SCM822							

R



Technical information

Material cross reference table

Steel

Classification	Japan	China	USA	UK	Germany	France	Russia
	JIS	GB	AISI/SAE	BS	DIN	NF	ГОСТ
Manganese steel Manganese Chromium steel	SMn420	20Mn2	1522	150M19	20Mn5		
	SMn433	30Mn2 35Mn2	1536	150M36	34Mn5		30Г2 35Г2
	SMn438	40Mn2	1541	150M36	36Mn5		35Г2 40Г2
	SMn443	45Mn2	1541				40Г2 45Г2
	SMnC420	15CrMn	5115		16MnCr5		
	SMnC443	40CrMn	5140				
Structural steel with specified hardenability band	SMn420H		1522H				
	SMn433H						
	SMn438H		1541H				
	SMn443H		1541H				
	SMnC420H						
	SMnC443H						
	SCr415H	15CrH			17Cr3 17CrS3		15X
	SCr420H	20Cr1H	5120H		17Cr3		20X
	SCr430H		5130H 5132H	34Cr4 34CrS4	34Cr4 34CrS3	34Cr4 34CrS4	30X
	SCr435H		5135H	37Cr4 37CrS4	37Cr4 34CrS4	37Cr4 37CrS4	35X
	SCr440H	40CrH	5140H	41Cr4 41CrS4	41Cr4 41CrS4	41Cr4 41CrS4	40X
	SCM415H	15CrMoH	4118H		15CrMo5		
	SCM418H				18CrMo4 18CrMoS4		
	SCM420H	20CrMoH	4118H	708H20	18CrMo4		
	SCM435H		4135H 4137H	34CrMo4 34CrMoS4	34CrMo4 34CrMoS4	34CrMo4 34CrMoS4	
	SCM440H	42CrMoH	4140H 4142H	42CrMo4 42CrMoS4	42CrMo4 42CrMoS4	42CrMo4 42CrMoS4	
	SCM445H		4145H 4147H				
	SCM822H						
	SNC415H						
	SNC631H						
SNC815H	12Cr2Ni4H			655H13	15NiCr13		
SNCM220H	20CrNiMoH	8617H 8620H 8622H	805H17 805H20 805H22		21NiCrMo2	20N CD 2	
SNCM420H	20CrNi2MoH	4320H			20NiCrMoS6-4		

R



Technical information

Material cross reference table

Steel

Classification	Japan	China	USA		UK	Germany	France	Russia
	JIS	GB	UNS	AISI	BS	DIN	NF	ГОСТ
Stainless steel	SUS 201	1Cr17Mn6Ni5N	S20100	201			Z12CMN17-07Az	
	SUS 202	1Cr18Mn8Ni5N	S20200	202	284S16			12X17F9AH4
	SUS 301	1Cr18Mn10Ni5Mo3N 1Cr17Ni7	S30100	301	301S21	X12CrNi17 7	Z11CN17-08	07X16H6
	SUS 301L		S30153			X2CrNi18-7		
	SUS 301J1					X12CrNi17 7		
	SUS 302	1Cr18Ni9	S30200	302	302S25		Z12CN18-09	12X18H9
	SUS 302B		S30215	302B				
	SUS 303	Y1Cr18Ni9	S30300	303	303S21	X10CrNiS18 9	Z8CNF18-09	
	SUS 303Se	Y1Cr18Ni9Se	S30323	303Se	303S41			12X18H10E
	SUS 304	0Cr18Ni9	S30400	304	304S31	X5CrNi18 10	Z7CN18-09	08X18H10
	SUS 304L	00Cr18Ni10	S30403	304L	304S11	X2CrNi19 11	Z3CN19-11	03X18H11
	SUS 304N1	0Cr18Ni9N	S30451	304N			Z6CN19-09Az	
	SUS 304N2	0Cr19Ni10NbN	S30452					
	SUS 304LN	00Cr18Ni10N	S30453	304LN		X2CrNi18 10	Z3CN18-10Az	
	SUS 304J1							
	SUS 304J2							
	SUS 304J3		S30431	S30431				
	SUS 305	1Cr18Ni12	S30500	305	305S19	X5CrNi18 12	Z8CN18-12	06X18H11
	SUS 305J1							
	SUS 309S	0Cr23Ni13	S30908	309S			Z10CN24-13	
	SUS 310S	0Cr25Ni20	S31008	310S	310S31		Z8CN25-20	10X23H18
	SUS 316	0Cr17Ni12Mo2	S31600	316	316S31	X5CrNiMo17 12 2	Z7CND17-12-02	
	SUS 316F					X5CrNiMo17 13 3	Z6CND18-12-03	
	SUS 316L	00Cr17Ni14Mo2	S31603	316L	316S11	X2CrNiMo17 13 2	Z3CND17-12-02	
						X2CrNiMo17 14 3	Z3CND17-13-03	03X17H14M3
	SUS 316N	0Cr17Ni12Mo2N	S31651	316N				
	SUS 316LN	00Cr17Ni13Mo2N	S31653	316LN		X2CrNiMoN17 12 2	Z3CND17-11Az	
						X2CrNiMoN17 13 3	Z3CND17-12Az	
	SUS 316Ti		S31635			X6CrNiMoTi17 12 2	Z6CNDT17-12	08X17H13M2T
	SUS 316J1	0Cr18Ni12Mo2Cu2						
	SUS 316J1L	00Cr18Ni14Mo2Cu2						
	SUS 317	0Cr19Ni13Mo3	S31700	317	317S16			
SUS 317L	00Cr19Ni13Mo3	S31703	317L	317S12	X2CrNiMo18 16 4	Z3CND19-15-04		
SUS 317LN		S31753				Z3CND19-14Az		
SUS 317J1	0Cr18Ni16Mo5							
SUS 317J2								
SUS 317J3L								
SUS 836L		N08367						
SUS 890L		N08904	N08904	904S14		Z2NCU25-20		
SUS 321	1Cr18Ni9Ti 0Cr18Ni10Ti	S32100	321	321S31	X6CrNiTi18 10	Z6CNT18-10	08X18H10T	
SUS 347	0Cr18Ni11Nb	S34700	347	347S31	X6CrNiNb18 10	Z6CNNb18-10	08X18H12b	
SUS 384		S38400	384			Z6CN18-16		
SUS XM7	0Cr18Ni9Cu3	S30430	304Cu	394S17		Z2CNU18-10		
SUS XM15J1	0Cr18Ni13Si4	S38100				Z15CNS20-12		
SUS 329J1	0Cr26Ni5Mo2	S32900	329					
SUS 329J3L		S39240	S31803			Z3CNDU22-05Az	08X21H6M2T	
SUS 329J4L		S39275	S31260			Z3CNDU25-07Az		

R



Technical information

Steel

Classification	Japan	China	USA		UK	Germany	France	Russia
	JIS	GB	UNS	AISI	BS	DIN	NF	ГОСТ
Stainless steel	SUS 405	0Cr13Al 0Cr13	S40500	405	405S17	X6CrAl13	Z8CA12	
	SUS 410L	00Cr12					Z3C14	
	SUS 429		S42900	429				
	SUS 430	1Cr17	S43000	430	430S17	X6Cr17	Z8C17	12X17
	SUS 430F	Y1Cr17	S43020	430F		X7CrMoS18	Z8CF17	
	SUS 430LX		S43035			X6CrTi17	Z4CT17	
	SUS 430J1L					X6CrNb17	Z4CNb17	
	SUS 434	1Cr17Mo	S43400	434	434S17	X6CrMo17 1	Z8CD17-01	
	SUS 436L		S43600	436				
	SUS 436J1L							
	SUS 444		S44400	444			Z3CDT18-02	
	SUS 447J1	00Cr30Mo2	S44700					
	SUS XM27	00Cr27Mo	S44627				Z1CD26-01	
	SUS 403	1Cr12	S40300	403				
	SUS 410	1Cr13	S41000	410	410S21	X10Cr13	Z13C13	
	SUS 410S		S41008	410S	403S17	X6Cr13	Z8C12	08X13
	SUS 410F2							
	SUS 410J1	1Cr13Mo 1Cr12Mo	S41025			X12CrS13		
	SUS 416	Y1Cr13	S41600	416	416S21		Z11CF13	
	SUS 420J1	2Cr13	S42000	420	420S29	X20Cr13	Z20C13	20X13
	SUS 420J2	3Cr13	S42000	420	420S37	X30Cr13	Z33C13	30X13
	SUS 420F	Y3Cr13	S42020	420F			Z30CF13	
	SUS 420F2							
	SUS 429J1							
	SUS 431	1Cr17Ni2	S43100	431	431S29	X20CrNi17 2	Z15CN16-02	20X17H2
	SUS 440A	7Cr17	S44002	440A			Z70C15	
	SUS 440B	8Cr17	S44003	440B				
	SUS 440C	9Cr18	S44004	440C				Z100CD17
11Cr17								
9Cr18Mo								
SUS 440F	Y11Cr17	S44020	S44020					
SUS 630	0Cr17Ni4CuNb	S17400	S17400		X5CrNiCuNb16-4	Z6CNU17-04		
SUS 631	0Cr17Ni7Al	S17700	S17700		X7CrNiAl17 7	Z9CNA17-07	09X17H7 Ю	
SUS 632J1								

Representative classification of stainless steel

Stainless steel (Austenitic related)

JIS	
SUS201	SUS309S
SUS202	SUS310S
SUS301	SUS316
SUS302	SUS316L
SUS302B	SUS316N
SUS303	SUS317
SUS303Se	SUS317L
SUS304	SUS321
SUS304L	SUS347
SUS304N1	SUS384
SUS304N2	SUSXM7
SUS305	SUSXM15J1
SUS308	

Stainless steel (Ferritic related)

JIS
SUS405
SUS429
SUS430
SUS430F
SUS434
SUSXM27

Stainless steel (Martensitic related)

JIS
SUS403
SUS410
SUS410S
SUS416
SUS420J1
SUS420F
SUS431
SUS440A
SUS440B
SUS440C
SUS440F

Stainless steel (Precipitation hardening)

JIS
SUS630
SUS631

R



Technical information

Steel

Classification	Japan	China	USA		UK	Germany	France	Russia
	JIS	GB	UNS	AISI	BS	DIN	NF	ГОСТ
Heat-resisting steel	SUH 31				331S42		Z35CNWS14-14	45X14H14B2M
	SUH 35				349S52		Z52CMN21-09Az	
	SUH 36	5Cr21Mn9Ni4N	S63008		349S54	X53CrMnNi21 9	Z55CMN21-09Az	55X20 Г 9AH4
	SUH 37	2Cr21Ni12N	S63017		381S34			
	SUH 38							
	SUH 309	2Cr23Ni13	S30900	309	309S24		Z15CN24-13	
	SUH 310	2Cr25Ni20	S31000	310	310S24	CrNi2520	Z15CN25-20	20X25H20C2
	SUH 330	1Cr16Ni35	N08330	N08330			Z12NCS35-16	
	SUH 660	0Cr15Ni25Ti2MoAlVB	S66286				Z6NCTV25-20	
	SUH 661		R30155					
	SUH 21					CrAl1205		
	SUH 409		S40900	409	409S19	X6CrTi12	Z6CT12	
	SUH 409L						Z3CT12	
	SUH 446	2Cr25N	S44600	446			Z12C25	15X28
	SUH 1	4Cr9Si2	S65007		401S45	X45CrSi9 3	Z45CS9	
	SUH 3	4Cr10Si2Mo					Z40CSD10	40X10C2M
	SUH 4	8Cr20Si2Ni			443S65		Z80CSN20-02	
	SUH 11							40X 9C2
SUH 600	2Cr12MoVNbN						20X12BHMБ0P	
SUH 616	2Cr12NiMoWV	S42200						

Representative classification of heat-resisting steel

Heat-resisting steel (Austenitic related)

JIS
SUH31
SUH35
SUH36
SUH37
SUH38
SUH309
SUH310
SUH330
SUH660
SUH661

Heat-resisting steel (Ferritic related)

JIS
SUH21
SUH409
SUH446

Heat-resisting steel (Martensitic related)

JIS
SUH1
SUH3
SUH4
SUH11
SUH600
SUH616

R



Technical information

Material cross reference table

Steel

Classification	Japan	China	USA	UK	Germany	France	Russia
	JIS	GB	AISI/ASTM	BS	DIN	NF	ГОСТ
Carbon tool steel	SK140 (SK1)	T13				C140E3U	Y13
	SK120 (SK2)	T12	W1-11½			C120E3U	Y12
	SK105 (SK3)	T11	W1-10		C105W1	C105E2U	Y11
	SK95 (SK4)	T10	W1-9			C90E2U	Y10
	SK85 (SK5)	T8Mn T9	W1-8		C80W1	C90E2U C80E2U	Y8Г Y9
	SK75 (SK6)	T8			C80W1	C80E2U C70E2U	Y8
	SK65 (SK7)	T7			C70W2	C70E2U	Y7
High speed tool steel	SKH2	W18Cr4V	T1	BT1		HS18-0-1	P18
	SKH3	W18Cr4VCo5	T4	BT4	S18-1-2-5	HS18-1-1-5	P18K5Φ2
	SKH4	W18Cr4V2Co8	T5	BT5		HS18-0-2-9	P18K5Φ
	SKH10	W12Cr4V5Co5	T15	BT15	S12-1-4-5	HS12-1-5-5	
	SKH51	W6Mo5Cr4V2	M2	BM2	S6-5-2	HS6-5-2	P6M5
	SKH52	CW6Mo5Cr4V2 W6Mo5Cr4V3	M3-1				P6M5Φ3
	SKH53	CW6Mo5Cr4V3	M3-2		S6-5-3	HS6-5-3	P6M5Φ3
	SKH54		M4	BM4		HS6-5-4	
	SKH55	W6Mo5Cr4V2Co5 W7Mo5Cr4V2Co5	M35 M41	BM35	S6-5-2-5	HS6-5-2-5HC	P6M5K5
	SKH56		M36				
	SKH57			BT42	S10-4-3-10	HS10-4-3-10	
SKH58	W2Mo9Cr4V2	M7			HS2-9-2		
SKH59	W2Mo9Cr4VCo8	M42	BM42	S2-10-1-8	HS2-9-1-8		
Alloy tool steel	SKS11		F2				XB4
	SKS2				105WCr6	105WCr5	XBГ
	SKS21	W					
	SKS5						
	SKS51		L6				
	SKS7						
	SKS8	Cr06				C140E3UCr4	13X
	SKS4	5CrW2Si 6CrW2Si	S1				6XB2C 5XB2CΦ
	SKS41	4CrW2Si	S1				4XB2C
	SKS43		W2-9½	BW2		100V2	
	SKS44		W2-8				
	SKS3	9CrWMn					9XBГ
	SKS31	CrWMn			105WCr6	105WCr5	XBГ
	SKS93						
	SKS94						
	SKS95	8MnSi					
	SKD1	Cr12	D3	BD3	X210Cr12	X200Cr12	X12
	SKD10	Cr12Mo1V1	D2		X153CrMoV12		X12MΦ
	SKD11	Cr12MoV	D2	BD2	X153CrMoV12	X160CrMoV12	
	SKD12	Cr5Mo1V	A2	BA2		X100CrMoV5	
	SKD4					X32WCrV3	
SKD5	3Cr2W8V	H21	BH21	X30WCrV9-3	X30WCrV9		
SKD6	4Cr5MoSiV	H11	BH11	X38CrMoV51	X38CrMoV5	4X5MΦC	
SKD61	4Cr5MoSiV1	H13	BH13	X40CrMoV51	X40CrMoV5	4X5MΦ1C	
SKD62		H12	BH12		X35CrWMoV5	3X3M3Φ	
SKD7	4Cr3Mo3SiV	H10	BH10	X32CrMoV33	32CrMoV12-18		
SKD8		H19	BH19				
SKT3					55CrNiMoV4		
SKT4	5CrNiMo			BH224/5	55NiCrMoV6	55NiCrMoV7	5XHM

R



Technical information

Material cross reference table

Steel

Classification	Japan	China	USA	UK	Germany	France	Russia
	JIS	GB	AISI/ASTM	BS	DIN	NF	ГОСТ
Spring steel	SUP3		1075 1078				75 80 85
	SUP6	55Si2Mn			56SiCr7	60Si7	60C2
	SUP7	60Si2Mn 60Si2MnA	9260		61SiCr7	60Si7	60C2Г
	SUP9	55CrMnA	5155		55Cr3	55Cr3	
	SUP9A	60CrMnA	5160		55Cr3	60Cr3	
	SUP10	50CrVA	6150	735A51, 735H51	50CrV4	51CrV4	XΦA50XГΦA
	SUP11A	60CrMnBA	51B60		51CrV4		50XГP
	SUP12		9254	685A57, 685H57	54SiCr6	54SiCr6	
	SUP13	60CrMnMoA	4161	705A60, 705H60	60CrMn3-2	60CrMo4	
Free cutting carbon steel	SUM11		1110				
	SUM12	Y12	1108				
	SUM21		1212				
	SUM22	Y15	1213	(230M07)	9SMn28	S250	
	SUM22L	Y12Pb	12L13		9SMnPb28	S250Pb	
	SUM23		1215				
	SUM23L						
	SUM24L	Y15Pb	12L14		9SMnPb28	S250Pb	
	SUM25				9SMn36	S300	
	SUM31		1117		15S10		
	SUM31L						
	SUM32	Y20		210M15, 210A15		(13MF4)	
	SUM41	Y30 Y35	1137			(35MF6)	
	SUM42	Y40Mn	1141			(45MF6.1)	
SUM43		1144	(226M44)		(45MF6.3)		
High carbon chromium bearing steel	SUJ1	GCr4	51100				
	SUJ2	GCr15	52100		100Cr6	100Cr6	ЦХ15
	SUJ3	GCr15SiMn	ASTM A 485 Grade 1				
	SUJ4	GCr15SiMo					
	SUJ5	GCr18Mo					

R



Technical information

Material cross reference table

Cast iron

Classification	Japan	China	USA	UK	Germany	France	Russia
	JIS	GB	AISI/SAE	BS	DIN	NF	ГОСТ
Gray cast iron	FC100	HT100	NO.20	100	GG10		CY10
	FC150	HT150	NO.30	150	GG15	FGL150	CY15
	FC200	HT200	NO.35	200	GG20	FGL200	CY20
	FC250	HT250	NO.45	250	GG25	FGL250	CY25
	FC300	HT300	NO.50	300	GG30	FGL300	CY30
	FC350	HT350	NO.60	350	GG35	FGL350	CY35
					GG40	FGL400	CY40
Nodular cast iron	FCD400	QT400-18	60-40-18	400/17	GGG40	FGS370-17	BY40
	FCD450	QT450-10	65-45-12	420/12		FGS400-12	BY45
	FCD500	QT500-7	70-50-05	500/7	GGG50	FGS500-7	BY50
	FCD600	QT600-3	80-60-03	600/7	GGG60	FGS600-2	BY60
	FCD700	QT700-2	100-70-03	700/2	GGG70	FGS700-2	BY70
	FCD800	QT800-2	120-90-02	800/2	GGG80	FGS800-2	BY80
		QT900-2		900/2			BY100

Non-ferrous metals

Classification	Japan	China	USA	UK	Germany	France	Russia
	JIS	GB	ASTM	BS	DIN	NF	ГОСТ
Aluminum alloys		1A99	1199		A199.99R		A99
		1A97			A199.98R		A97
		1A95					A95
	A1080	1A80		1080(1A)	A199.90	1080A	A8
	A1050	1A50	1050	1050(1B)	A199.50	1050A	A5
	A5052	5A02	5052	NS4	AlMg2.5	5052	Amg
		5A03		NS5			AMg3
	A5056	5A05	5056	NB6	AlMg5		AMg5V
	A5556	5A30	5456	NG61		5957	
	A2117	2A01	2036		AlCu2.5Mg0.5	2117	D18
	A2017	2A11		HF15	AlCuMg1	2017S	D1
	A2024	2A12	2124		AlCuMg2	2024	D16AVTV
		2B16	2319				
	A2N01	2A80					AK4
	A2018	2A90	2218				AK2
	A2014	2A14	2014		AlCuSiMn	2014	AK8
A7075	7A09	7175		AlZnMgCu1.5	7075	V95P	
Aluminum alloy casting	AC4C	ZAlSi7Mn	356.2	LM25	G-AlSi7Mg		
	AC3A	ZAlSi12	413.2	LM6	G-Al12	A-S12-Y4	AL2
		ZAlSi5Cu1Mg	355.2				AL5
	AC8A	ZAlSi2Cu2Mg1	413.0		G-Al12(Cu)		
		ZAlCu5Mn					AL19
		ZAlCu5MnCdVA	201.0				
		ZAlMg10	520.2	LM10	G-AlMg10	AG11	AL8
	ZAlMg5Si			G-AlMg5Si		AL13	

R



Technical information

Insert grade cross reference table

CVD Coated Carbide (Turning)

This table is Kyocera's own estimation based on publications and is not authorized by companies mentioned in it.

Classification		Kyocera	Dijet	MOLDINO (Mitsubishi Hitachi Tool)	Mitsubishi	NTK	Sandvik	Seco	Sumitomo	Tungaloy	Kennametal	Iscar
	Symbol											
P (Steel)	P01	CA510 CA5505	JC110V	HG8010 HC5000 HG3305	UE6105 UE6005 UE6015		GC4305 GC4005 GC4205	TP0501 TP0500 TP1000	AC700G AC810P	T9005 T9105	KCPK05 KCP05B KC9105	IC8150 IC9150
	P10	CA510 CA515 CA5505 CA5515	JC110V JC215V	GM10 GM20 GM8015 HG8010	MC6105 MC6115 UE6105 UE6110 UE6010 UE6020	CP2 CP5 CP7	GC4415 GC4205 GC4015 GC3115 GC4215 GC4315	TP1501 TP1000 TP1500 TP100	AC700G AC2000 AC810P AC820P AC8015P AC8025P	T9005 T9105 T9015 T9115 T9215	KCK05 KCP10B KCP10 KC9010 KC9110	IC8150 IC9150 IC9250
	P20	CA025P CA525 CA5515 CA5525 CR9025	JC110V JC215V	GM20 GM8020 HG8025	MC6125 MC6025 UC6010 UE6110 UE6020	CP2 CP5 CP7	GC4425 GC4215 GC4220 GC4225 GC4325	TP2501 TP2000 TP2500 TP200	AC2000 AC3000 AC820P AC830P AC8020P	T9015 T9115 T9025 T9125 T9225	KCP25B KCP25 KC9125 KC9225 KC9325	IC8250 IC9125 IC9250 IC9350
	P30	CA025P CA525 CA5525 CA530 CA5535 CR9025	JC215V JC325V	GM25 GM8035 HG8025	MC6125 MC6025 UE6020 MC6035 UE6035 UH6400		GC4425 GC4225 GC4230 GC4235 GC2135 GC4335	TP2501 TP3501 TP2500 TP2000 TP3500 TP200	AC3000 AC630M AC830P ACP100 AC8035P	T9125 T9035 T9135 T3130	KCP30B KCP30 KC9040 KC9140	IC635 IC8350 IC9350
	P40	CA530 CA5535	JC325V JC450V JC540V	GX30	MC6035 UE6035 UH6400		GC4035 GC4235 GC4240 GC4335	TP40	AC630M AC830P ACP100	T9035 T3130	KCP40B KCP40 KC9140 KC9240	IC635
M (Stainless steel)	M10	CA6515	JC605X JC110V	GM10 HS9105	MC7015 US7020	CP2 CP5	GC2015 GC2220	TM1501 TP1500 TP100	AC610M AC6020M	T9015 T9115 T6215	KCM15B KCM15 KC9010 KC9110 KC9210	IC8250 IC9250 IC9350 IC6015
	M20	CA6525	JC110V JC215V	GM8020 HG8025 HS9115	US7020 MC7025	CP2 CP5	GC1515 GC2015 GC2025 GC2220	TM2501 TM2000 TP200	AC6020M AC6030M AC610M AC630M AC830P	T6020 T6120 T9115 T9125	KCM25B KCM25 KC9025 KC9125 KC9225	IC8350 IC9250 IC9350 IC6025
	M30		JC215V JC325V JC525X	GM25 GM8035	MC7025 US735		GC2040 GC235	TM4000 TP3501 TP300	AC6030M AC630M AC830P	T6030 T6130 T9125	KCM35B KCM35 KC9240	IC8350 IC9350 IC4050
	M40		JC525X	GX30 IP100S	US735			TP40				KC9045 KC9245
K (Cast iron)	K01	CA310 CA4505 CA5505	JC105V JC605W JC050W	HG3305 HG3315 HX3505 HX3515	MC5005 UC5105 UC5015	CP1	GC3205 GC3210	TK0501 TK1000 TK1001	AC405K AC410K AC300G AC4010K	T505 T5105 T5010	KCPK05 KC9315 KCK05B KCK05	IC5005 IC428 IC9007 IC9150
	K10	CA310 CA315 CA4505 CA4515 CA5505	JC050W JC110V JC605W JC108W	GM8015 HX3515 HG8010 HG3315	UC5015 UC5105 UC5115 UE6010 MC5015	CP1 CP2 CP5	GC3205 GC3210 GC3215 GC3115	TK1501 TK1000 TK2000 TK2001 MK1500	AC4010K AC410K AC415K AC700G AC4015K	T515 T5105 T5115 T5010	KC9110 KC9120 KC9315 KCK15B KCK15	IC5010 IC418 IC428 IC9015 IC9007
	K20	CA315 CA320 CA4515	JC110V JC215V JC108W JC605W	GM8020 HG8025	MC5015 MY5015 UE6010 UC5115 UE6110	CP2 CP5	GC4225 GC3215 GC3220 GC3225	TK2000 TX150 TP200	AC4015K AC420K AC700G AC820P	T515 T5115 T5125 T5020	KC9125 KC9320 KC9325 KCK20B KCK20	IC418 IC9015
	K30	CA320	JC215V	GM25	UE6110		GC3040 GC4335	TP2500 TP200		T5125 T9125	KCP25B KC9320	

R



Technical information

Insert grade cross reference table

PVD Coated Carbide (Turning)

This table is Kyocera's own estimation based on publications and is not authorized by companies mentioned in it.

Classification		Kyocera	Dijet	MOLDINO (Mitsubishi Hitachi Tool)	Mitsubishi	NTK	Sandvik	Seco	Sumitomo	Tungaloy	Kennametal	Iscar
	Symbol											
P (Steel)	P01	PR1705	JC5003						ACZ150		KC5510	
	P10	PR1705 PR930 PR1025 PR1115 PR1215 PR1225 PR1725	JC5003 JC5030	CY15 CY150 IP2000	MS6015 VP10MF	VM1 TM1 TA1 TAS DT4 DM4	GC1025	CP200	ACZ150 ACZ310 AC520U	AH710	KC5010 KC5510 KU10T	IC507 IC807 IC907 IC1010
	P20	PR930 PR1025 PR1115 PR1215 PR1225 PR1625 PR1725	JC5015 JC5030 JC5040	CY150 IP2000	MS6015 VP10RT VP15TF VP20MF UP20M VP20RT	QM1 VM1 TA1 TAS TM4	GC1020 GC1025 GC4125 GC1125	CP250	ACZ310 ACZ330 AC520U	AH7025 AH710 AH725 AH730 SH725 SH730	KC5025 KC5525 KC7215 KC7315 KU25T	IC507 IC907 IC908
	P30	PR1025 PR1225 PR1535	JC5015 JC5040	CY250 CY9020 HC844 IP3000	VP10RT VP15TF VP20MF UP20M MS7025	ZM3 QM3 TAS	GC1125 GC1145 GC1115 GC1105	CP500	ACZ330 ACZ350 AC530U AC1030U	GH330 AH120 AH740 AH9030	KC7015 KC7020 KC7235 KU25T	IC328 IC928 IC3028 IC1030
	P40	PR1535	JC5040	CY250 HC844		ZM3 QM3 TAS	GC1145 GC2145	CP600	ACZ350	AH140 AH740 J740	KC7030 KC7040 KC7140	IC328 IC3028
	M (Stainless steel)	M10	PR1025 PR1215 PR1225	JC5003	IP0505 JP9105	VP10MF VP10RT	VM1 TM1 TA1	GC1005 GC1025 GC1105 GC15	TS2000 CP200 CP250	EH510Z ACZ150 AC510U	AH710	KC5010 KC5510 KC6005 KCU10
M20	PR930 PR1025 PR1125 PR1215 PR1725 PR1225 PR1515	JC5015 JC5030 JC5040 JC8015 JC5118	IP1005 GX30 JP9115	MS9025 VP10RT VP15TF VP20MF UP20M VP20RT MS7025	ST4 QM1 VM1 TA1 TM4 TAS DT4 DM4	H5D6 GC1025 GC1115 GC4125 GC1125 GC30	TTP2050 TS2500 CP200 CP250 CP500	EH520Z ACZ150 ACZ310 AC520U AC1030U	AH6225 AH630 AH725 AH730 GH330 GH730 SH725 SH730	KC5025 KC5525 KC7020 KC7025 KCU25	IC308 IC507 IC907 IC908 IC3028	
M30	PR1125 PR1535	JC5015 JC5030 JC5040 JC5118		CY250 CY9020	VP15TF VP20MF UP20M MP7035	ST4 ZM3 QM3 TAS	GC1020 GC2035 GC2030	CP500	ACZ330 ACZ350 AC530U AC6040M	AH6030 AH120 AH725 AH6235	KC7030 KC7225	IC1030 IC908 IC1008 IC1028 IC3028
M40	PR1535	JC5118			MP7035	ZM3 QM3 TAS	GC2145 GC1145	CP600	AC6040M ACZ350	J740 AH140 AH645		IC228 IC928 IC328
K (Cast iron)	K01		JC5003						EH10Z	AH110	KC5515	IC910
	K10	PR905 PR1215	JC5003 JC5015	CY100H CY10H	VP05RT	TA1 TM1	GC1010	TS2000 CP200	EH10Z EH510Z AC510U	GH110 AH110	KC5010 KC7210	IC1010 IC807 IC910 IC908
	K20	PR905 PR1215	JC5015	IP2000 CY9020	VP10RT VP15TF VP20RT	QM1 TA1	GC1020 GC1120	TS2500 CP200 CP250	EH20Z ACZ310 AC520U AC530U AC1030U	AH120 AH725	KC5025 KC5525 KC7015 KC7215 KC7315	IC508 IC908
	K30				VP15TF VP20RT	QM3 TA3	GC1030	CP500	ACZ310		KC7225	IC508 IC908
S (Difficult-to-cut material)	S01	PR005S	JC5003		MP9005 VP05RT				AC5005S	AH8005 AH905		IC804 IC806
	S10	PR005S PR015S	JC5015 JC8015	JP9105	MV9005 MP9005 MP9015 VP10RT		GC1105 GC1005 GC1025	TH1000 CP200 TS2000	AC510U AC5015S	AH8015 AH905 SH730 AH110	KC5010 KC5510 KCU10 KCS10	IC1010 IC808 IC907 IC908
	S20	PR015S PR1535	JC5015 JC8015	JP9115	MP9015 MT9015 VP20RT MS9025		GC1025 GC1125	CP250 TS2500	AC510U AC520U AC5025S	AH8015 AH120 AH725	KCS10B KC5025 KC5525 KCU25	IC806 IC808 IC908
	S30	PR1535			MP9025		GC1125		AC520U	AH725		IC3028

R



Technical information

Insert grade cross reference table

Cermet (Turning)

This table is Kyocera's own estimation based on publications and is not authorized by companies mentioned in it.

Classification		Kyocera	Dijet	MOLDINO (Mitsubishi Hitachi Tool)	Mitsubishi	NTK	Sandvik	Seco	Sumitomo	Tungaloy	Kennametal	Iscar
	Symbol											
P (Steel)	P01	TN610 PV710	LN10 CX50	CH350	AP25N VP25N NX1010	T3N T15 Q15			T110A T1000A	NS520 GT530 GT720 J530	KT1120 KT125 HTX	IC20N IC520N
	P10	TN610 TN620 TN6020 TN60 PV710 PV720 CCX	LN10 CX50 CX75 NIT PX75	CH350 CZ25	NX2525 AP25N VP25N	T15 C7Z Z15	CT5015 CT525	TP1020 CM CMP	T1500Z T2000Z T1200A T1500A	NS9530 NS520 GT9530 GT530 GT730 AT9530	KT315 KT175 HT2 KTP10	IC20N IC520N IC530N IC75T
	P20	CCX TN620 TN90 TN6020 PV720	CX50 CX75 CX90 NAT PX90	CH550 CH7030 CZ1025 CZ25	MP3025 NX2525 NX3035 AP25N VP45N	T15 C7X C7Z	CT525 CT530 GC1525	TP1020 C15M TP1030	T1200A T1500A T2000Z T2500Z T3000Z	NS9530 NS530/730 GT9530 GT530/730 AT9530	PS5 KT5020	IC20N IC520N IC530N IC75T IC30N
	P30	PV730	CX90 CX99 SUZ		NX4545 VP45N	N40 C7X	CT530 GC1525	TP1030	T3000Z T250A	NS740		IC75T IC30N
M (Stainless steel)	M10	TN620 TN60 TN6020 PV720	LN10	CH350	NX2525 AP25N VP25N	T15 C7X C7Z Z15	CT5015 CT525	CM CMP	T110A T1000A T2000Z	NS520 J530	KT1120 KT315 KT125	IC20N IC520N
	M20	TN620 TN90 TN6020 PV720	CX50 CX75 PX75 NIT NAT	CH550 CH7030 CZ1025	NX2525 NX3025 AP25N VP25N	C7X C7Z Q15	CT530 GC1525	TP1020 C15M	T1500A T2000Z	NS530 NS730 GT530 GT730	KT175 HT2 PS5 KT5020	IC30N IC530N
	M30	PV730	CX75 CX90 PX90 CX99 SUZ	CZ25	NX4545	C7X		TP1030	T3000Z T250A	NS740		
K (Cast iron)	K01	PV7005 CCX	LN10		AP25N VP25N	T3N T15 Q15			T110A T1000A	NS520	KT1120	
	K10	TN610 CCX PV710 PV7005	LN10	CH350	NX2525 AP25N VP25N	T15 C7X C7Z Z15	CT5015		T1200A T1500A T2000Z	NS530 NS730 GT530 GT730	KT315 HTX KTP10	
	K20		NIT	CZ25	NX2525 AP25N VP25N				T3000Z		KT5020	

Boldface grade shows PVD Coated Cermet. (CCX is CVD Coated Cermet grade)

Carbide

Classification		Kyocera	Dijet	MOLDINO (Mitsubishi Hitachi Tool)	Mitsubishi	NTK	Sandvik	Seco	Sumitomo	Tungaloy	Kennametal	Iscar
	Symbol											
P (Steel)	P10		SRT	WS10	STi10T		S1P		ST10P	TX10S	K2885	IC70
	P20		SRT DX30	EX35	STi20 UTi20T		SMA	S10M	ST20E	TX20 TX25	K125M	IC70 IC50M
	P30		SR30 DX30 DX35	EX35 EX40	UTi20T		SM30	S25M	A30N A30 ST30E	TX30 UX30	KMF	IC50M IC54
	P40		SR30 DX35	EX45			S6	S60M	ST40E	TX40	PVA	IC54
K (Cast iron)	K01		KG03	WH02 WH05	HTi05T		H1P		H1 H2	TH03 KS05F	K68 K10	IC04
	K10	KW10 GW15	KG10 KT9	WH10	HTi10	KM1	H1P H10 HM	890	EH10 EH510	G1F TH10 H10T	KMI K8735 K313	IC20
	K20	GW25	CR1 KG20	WH20	HTi20T UTi20T	KM3	H13A	883 890 HX	G10E EH20 EH520	G2F KS15F KS20	KMF	IC20 IC10
	K30		KG30					883	G3 G10E	G3 UX30	THR	IC10 IC28
V (Wear and shock resistant tool)	V40		G5 GD195	WH50	GTi30				G5	D40		
	V50	VW50	MH3 MH4 GD174 GD201	WH60	GTi35 GTi40 GTi30S				G6	D50		
	V60		MH5 MH7 MH8 GD206	WB60	GTi40S GTi50S				G7 G8	D60		

R

Technical information

Insert grade cross reference table

Coated carbide (Milling / Drill)

This table is Kyocera's own estimation based on publications and is not authorized by companies mentioned in it.

Classification		Kyocera	Dijet	MOLDINO (Mitsubishi Hitachi Tool)	Mitsubishi	NTK	Sandvik	Seco	Sumitomo	Tungaloy	Kennametal	Iscar
Symbol												
P (Steel)	P10	PR1225	JC5003 JC5030 JC8003 DH103	JP4105 JX1020 JP4005 PN08N	F7010		GC1025 GC1010		ACP100		KC715M	
	P20	PR1525 PR1225 PR1230 CA520D	DH111 DH110 DH115 JC8015 JC8118 JC7518	JP4120 JS4045 JP4020 TB6020 JX1015 GX2140	MC7020 MP6120 F7030 UP20M MV1020	TM1 DT4 DM4	GC1130 GC1030 GC4220 GC4020 GC4030 GC4334	MP1500 T250M T25M T20M	ACP200 ACP2000 ACU2500 XCU2500	T313W AH725 AH3225	KC522M KC525M KCPM20	IC5500 IC330 IC520M IC950 IC5400 IC1008
	P30	PR1230 PR1535	JC6235 JC5015 JC5040 JC5240 JC8050 JC7550	CY250 CY9020 TB6045 JX1045 JM4060 GX2160	MP6130 F7030 VP15TF VP30RT	ZM3	GC1130 GC4040 GC4230 GC4330	MP2500 T250M T25M F25M F30M	AC230 ACP300 ACP3000	AH9130 T3130 GH330 AH330 AH730 AH3135	KC994M KC725M KC792M KC530M KCPK30 KCPM40	IC330 IC328 IC635 IC830 IC908 IC928
	P40		JC7550 JC5040 JC7560	CY250 HC844 TB6060 JX1060	VP30RT		GC4040 GC4240 GC4340	MP3000 T350M T60M T25M	AC230 ACZ330 ACZ350	AH140	KC735M	IC635 IC928 IC4050
M (Stainless steel)	M10	PR1225	DH108 DH111	CY9020 JX1020 JP4020	F7010		GC1025 GC1030		ACM100 ACM200 EH10Z		KC522M	
	M20	PR1525 PR1225	JC730U JC8355 JC8118 JC5015 JC5030 JC5040 JC7518	PN215 CY150 TB6020 JX1015 CY250	MV1020 MC7020 F7030 VP15TF VP20RT MP7030 MP7130	DT4 DM4	GC2030 S30T GC2334 GC2044	MS2050 MP2500 T250M T25M F20M F25M F30M	XCU2500 ACM200 ACP200 EH20Z ACU2500 AH3225	GH330 AH330 AH120 AH130 AH725 AH3135	KC730M KC525M	IC380 IC908 IC928 IC882
	M30	CA6535 PR1535	JC8355 JC8015 JC5015 JC5118 JC8050	JM4160 JM4060 TB6045 JX1045 GX2160	F7030 VP30RT MP7140	ZM3	GC1040 GC2040 S40T	T350M T250M F40M	ACM300 ACP300 ACZ350	T3130 AH130 AH9130	KC994M KC725M KCPK30	IC380 IC328 IC330
	M40		JC7560		VP30RT			MM4500	ACZ350	AH140		IC830
K (Cast iron)	K01		DH202 DH102	TB6005				MH1000	ACK100	AH110		IC5100 IC4100
	K10	PR1510 PR905 PR1210	DH103 JC8015 JC610 JC605W JC8118	JP4005 CY10H CY100H CY9020	MP8010 MCS020 VP10RT MV1020		GC1010 GC3220 K15W	MK1500 T150M F15M	XCK2000 ACK2000 ACK200 AC211 ACU2500	T1015 T1115 AH110 T1215	KCKP10 KCK15 KC915M	IC5100 IC4010 IC910 DT7150 IC810
	K20	CA420M PR905 PR1210 CA415D	JC605X JC610 JC5015 JC8015 JC8118	TH315 CY150 TB6020 JX1015	VP15TF VP20RT		GC1020 GC3020 K20W/K20D GC3330 GC3334	MP1500 T150M T250M MK2000 MK2050	EH20Z ACZ310 ACK300 ACK3000	AH120 AH725 T1215	KCK20B KC520M KC920M KC925M KC992M	IC810 IC910 IC928
	K30		JC5080 JC6235				GC3040 GC4040	MK3000 T250M		AH9130 GH130	KC930M	IC928
S (Difficult-to-Cut Material)	S10	CA6535 PR1535 PR1210	DH202 DH102 DH103 JC7518	PCS08M PTH135 JS1025	MP9120 VP15TF		GC1030 GC1025 GC1010	MS2050	ACM100 ACM200 ACK300	AH8015	KC510M	IC903 IC807 IC808 IC908
	S20	CA6535 PR1535 PR1210	DH111 JC8118 IC5015 JC8050 JC7560 JC7550	CY100H CY10H	MP9120 VP15TF MP9130 MP9030		GC1030 GC2030 S30T GC1130 GC4344	MP2050	ACU2500 ACM200		KC522M KC525M KCSM30	IC882 IC903 IC808 IC908 IC830 IC928
	S30	PR1535	JC8050 JC7560		MP9140		GC2040 S40T	F40M	ACM300		KC725M KCSM40	IC328 IC330



Technical information

Insert grade cross reference table

Cermet (Milling)

This table is Kyocera's own estimation based on publications and is not authorized by companies mentioned in it.

Classification		Kyocera	Dijet	MOLDINO (Mitsubishi Hitachi Tool)	Mitsubishi	NTK	Sandvik	Seco	Sumitomo	Tungaloy	Kennametal	Iscar
Symbol												
P (Steel)	P10	TN60 TN620M PV60M	NIT CX75	CH550 MZ1000	NX2525			C15M		NS530 NS730	KT530M KT195M	
	P20	TN620M TN100M TN60 PV60M	NAT CX75 CX90	CH570 CH7030	NX2525 MX3020	C7X C7Z	CTS30	C15M MP1020	T2500A T250A T1500A	NS530 NS730 NS740	HT7 KT530M KT605M	IC30N
	P30		CX90 CX99 SC30	CH7035	NX4545 MX3030				T4500A	NS540		IC30N
M (Stainless steel)	M10	TN60 TN620M PV60M		MZ1000	NX2525			C15M				
	M20	TN620M TN100M TN60 PV60M	NIT CX75 NAT	CH550 CH570 CH7030	NX2525			CTS30	C15M	T2500A T250A	KT7 KT530M KT605M	IC30N
	M30		CX75 CX90 CX99 SC30		NX4545				T4500A	NS740 N308		
K (Cast Iron)	K01		LN10									
	K10	PV60M	LN10 CX75	MZ1000 CH550	NX2525							IC30N
	K20		NIT	CH7030 CH7035	NX2525							

Boldface grade shows PVD Coated Cermet.

Ceramic

Classification		Kyocera	Dijet	Nippon Tungsten	Mitsubishi	NTK	Sandvik	Seco	Sumitomo	Tungaloy	Kennametal	Iscar
Symbol												
K (Cast Iron)	K01	KA30 A65 KT66 PT600M CS7050 KS6015		NPC-H2 NPC-A2		SE1 HC1 HC2 HC5 HC6 HW2	CC620 CC650		NB90S NB90M WX120	TZ120	KW80 KY1615 AC5	IN11 IS6
	K10	KS6015 A65 KT66 A66N PT600M CS7050 KS6050		NX NXA Whiskal WIN		WA1 HC2 HC6 HC7	CC6090 CC6190 GC1690		WX120 NS260C	LX11 LX21	KYK10 KYK25 KB90 KY1320 KY3000 KY3400	IN420 IN23 IN23 IS80
	K20	KS6050				SX6 SX9 SP9	CC6090 CC6190 GC1690		WX120	WG300 FX105 CX710	KYK35 KY3400 KY3500	IS8
S (Difficult-to-cut material)	S01					JP0	CC650				KY2100	
	S10	KS6030 KS6040	CA200	Whiskal WIN		JX1 JP2 WA1 WA5 SX3 SX7 SX9	CC670 CC6060 CC6065 CC6160		WX120	WG300	KYHK15B KYS25 KY4300 KY1525 KY1540	IS25 IS9
	S20					JX3	CC6220 CC6230		WX120		KYS30	IS35 IW7
H (Hard materials)	H01	A65 KT66 A66N PT600M		NPC-A2		HX5 HC4 HC7 ZC7	CC650 CC670 CC6050		NB100C	LX10 LX11 LX21	KY4400	
	H10	A65 KT66 A66N PT600M		NPC-A2 Whiskal WIN		ZC7 WA1 WA5	CC670			WG300	KY4300 KYHK15B	

Boldface grade shows PVD Coated Ceramic.

R



Technical information

Insert grade cross reference table

CBN

This table is Kyocera's own estimation based on publications and is not authorized by companies mentioned in it.

Classification		Kyocera	Dijet	MOLDINO (Mitsubishi Hitachi Tool)	Mitsubishi	NTK	Sandvik	Seco	Sumitomo	Tungaloy	Kennametal	Iscar
Symbol												
K (Cast iron)	K01	KBN475	JBN795		BC5110	B20 B22 B30	CB7525 CB50 CB7050	CBN050C CBN300P	BN500 BNC500	BX910 BX930 BX950		IB50 IB85
	K10	KBN60M KBN900	JBN330	BH200	MB710 MB5015 MB4020	B22 B23	CB50 CB7050	CBN20 CBN200 CBN300	BNC8115 BN700 BN7000	BX950 BXC90 BX470	KB1630 KB1345 KB9610	IB55 IB90
	K20	KBN900		BH250	MB4120 MBS140 BC5030	B16 B40		CBN350 CBN500 CBN600	BN7000 BNS800	BX950 BXC90 BX905	KB9640	
H (Hard materials)	H01	KBN510 KBN05M KBN10M KBN020	DH102		BC8105 BC8210 BC8110 MBC010 MB810	B24 B52	CB20	CBN050C CBN010 CBN10 CBN100 CH0550	BN1000 BNC100 BNC160 BNC2010 BNC2115	BXA10 BXA30 BX310 BXC30 BXM10	KB1610	IB20H IB25HC IB50
	H10	KBN510 KBN525 KBN05M KBN10M KBN25M KBN020	JC6102 JC8003 JBN500 JBN300 JBN330	BH200	BC8120 MBC020 BC8020 MB8025 MB825	B24 B36 B54 B52	CB7015 CB7050 CB50 CB7105	CBN150 CBN060K CBN200 CBN160C CK2065	BNC160 BNX20 BN2000 BNC200 BNC2020 BNC2125	BXM10 BXA10 BXA40 BX360 BXC50 BXA20	KBH10 KBH10B KB1615 KB1625 KB5610 KB9610	IB10HC IB50
	H20	KBN020 KBN25M KBN35M KBN900	JC8003 JC5015 JBN245	BH250	BC8220 BC8120 MBC020 BC8020 MB8025	B22 B36	CB7025 CB7525 CB7115	CBN350 CBN300P CBN400C CBN500 CH2540	BNX25 BN350 BNC300	BX380 BXC50 BXA20 BR35F	KBH20 KBH20B KB1340 KB5625 KB9640	IB55 IB25HA
	H30	KBN35M KBN900	JBN245	BH250	MB835 BC8130	B40 B6K	CB7125 CB7525 CB7135	CH3515	BNC300 BN350	BX380 BXC50 BXM20 BXA20	KB5630 KB9640	IB55 IB25HA
Sintered steel	-	KBN65B KBN570 KBN65M KBN70M	JBN795 JBN500		MB4120 MB4020			CBN200	BN7115 BN350 BN7000 BN7500	BX450 BX470 BX480	KB5630	IB05S IB10H IB10S

Boldface grade shows PVD Coated CBN.

PCD

Classification		Kyocera	Dijet	MOLDINO (Mitsubishi Hitachi Tool)	Mitsubishi	NTK	Sandvik	Seco	Sumitomo	Tungaloy	Kennametal	Iscar
Symbol												
N (Non-ferrous metals)	N01	KPD001	JDA30 JDA735		MD205	PD1	CD05 CD10	PCD05 PCD10	DA90 DA1000 DA2200	DX180 DX160	PD100 KD1400 KD1405	
	N10	KPD001 KPD010 KPD230 KPD250	JDA40 JDA745		MD220	PD2	CD10	PCD10 PCD20	DA150 DA1000 DA2200	DX140	KD100 KD1400 KD1415	ID5
	N20	KPD001 KPD010 KPD230 KPD250	JDA10 JDA715		MD230			PCD30 PCD30M	DA1000 DA2200	DX110 DX120	KD1425	

R



Technical information

Molded chipbreaker cross reference table

Molded chipbreaker cross reference table

Negative inserts

This table is Kyocera's own estimation based on publications and is not authorized by companies mentioned in it.

Cutting range	Kyocera		Dijet	MOLDINO (Mitsubishi Hitachi Tool)	Mitsubishi	NTK	Sandvik	Seco	Sumitomo	Tungaloy	Kennametal	Iscar	
	General chip-breaker	Chipbreaker for sticky material /Soft steel											
Carbon steel / Alloy steel	Finishing (with wiper edge)	WF WP	-	-	-	SW	-	WL WF	W-FF2 W-MF2	SEW LUW	AFW FW	FW	WF
	Finishing - Medium (with wiper edge)	WE WQ	-	-	-	MW	-	WM WMX	W-M3 W-M5	GUW	ASW SW	MW	WG
	Finishing	DP GP PP	XF XP	F1 FA FT PF	BE BH FE	F FH FS FY PK FP	UL WM ZF1	XF QF	FF1	FP FB FE SP FA FL LU	TF 01 AS TSF	FF UF FS LF	F3P SF PF
	Finishing - Medium	HQ PQ CQ CJ VC VF	XQ	UA UT	AB B CE CT	SH C SA LP SY	WV WR	LC PF	FF2 MF2	SU EX SJ SX UJ SE	TS NS CB 11 17 27 ZF	K RP FN FM	NF SM
	Medium - Roughing	PG GS PS	XS	UR UB	AE DE AH	MV MP MA MH	Z5 ZW1	XM QM SM SMC PM PMC	M3 MF3	UA UG GE GU	AM DM NM TM ZM	MN	M3P TF PP
	Medium - Roughing High feed rate	PT GT	-	GC PQ	AR AY	GH RP	GS	MR XMR	M5 MR5 MR6	MU UX ME	TH 32Y 32 37	RP RN	R3P NR
	Roughing	Standard PH	-	GG LG GQ	RE	MT Standard	G	Standard 23 HM	MR7	MC MU MX UZ	31 33 F-K THS	PR MG	GN
	Roughing Single-sided High feed rate	PX	-	GS RM UC UP UD	H HX HE TE UE	HV HR HX HZ HL HM	-	QR PR HR	R4 R5 R6 R7 RR6 R57 RP	HG HP MP HF	TU TRS 57 65 TUS	RP RH RM RW	TNM NM
Stainless steel, Difficult-to-cut material	Finishing	MQ SQ	-	SF	BH MP	FS SH FJ LM LS	ZF1	MF	M1	SU EF	SF SS	FP	F3M VL F3S
	Medium - Roughing	MS MU TK SG SX	-	GP SZ	DE SE PV VI	MS MA GM MJ MM ES MH GH GJ RM RS	ZP WS	MM MMC MR XMR SM SMR SF SGF SMC MRR	MF1 MF3 A3 A5 M5 56 R8 RR9 MF4	EG EX MU UP EM	HMM SM SA S SH HRM HPF	P MP MS UP	TF PP M3M R3M
Cast iron	Medium	KQ KG C Standard	-	-	AH VA VY	LK MF Standard	-	KF KM	-	UZ UX UJ	Standard 33 CF	FN	GN
	Roughing	KH GC ZS	-	-	-	GH RK	-	KR KRR	MR9	GZ	CM CH	RP UN	NR
Non-ferrous metals	Medium - Roughing	AH	-	-	-	-	-	AL	95	AG	P	GP MS	PP

R



Technical information

Molded chipbreaker cross reference table

Positive inserts

Cutting range	Kyocera		Dijet	MOLDINO (Mitsubishi Hitachi Tool)	Mitsubishi	NTK	Sandvik	Seco	Sumitomo	Tungaloy	Kennametal	Iscar	
	General chipbreaker	Chipbreaker for sticky material / Soft steel											
Carbon steel / Alloy steel	Minute ap	CF	-	-	-	-	-	-	-	01	-	-	
	Finishing (with wiper edge)	WP	-	-	-	SW	-	WF WK WM	W-F1 W-F2	LUW SDW	SW	FW WF	
	Finishing	PF DP GP PP VF	XP	ASF	-	FV SQ FP SMG	AZ3 AMX AZ7 FG	PF UF XF	FF1	FB GU FC FK FP LU	PF PSF 23	11 GF UF FP PF SM	
	Finishing - Medium (1)	HQ	XQ	ACB FT	JE	MQ MV LP	AF1	PM UM SMC	F1 M3	LB SF SU SS	PS PSS 24	LF	14
	Finishing - Medium (2)	GK	-	BM	JQ	No Indication	QD CL	PF PMC XM	MF2 M5	US GU	-	-	F3P
	Medium	Standard	-	-	J	MP Standard	AM5 AM3 AZ8	PR UR KM XR	F2	MU SC	PM	GM MP MR	Standard
Stainless steel, Difficult-to-cut material	Finishing - Medium	MQ	-	-	MP	FM FV SV LM LS MS	-	MF MMC SM MR MM	-	LU	PSS JS PF PSF PS PM	FW FP MW	PF WF F2M
Non-ferrous metals	Finishing - Medium	AP AH	-	ALU	-	AZ	-	AL	AL	AG AW	AL	HP	AF AS

Positive inserts (for automatic lathe)

Cutting range	Kyocera	Dijet	MOLDINO (Mitsubishi Hitachi Tool)	Mitsubishi	NTK	Sandvik	Seco	Sumitomo	Tungaloy	Kennametal	Iscar	
Carbon steel / Alloy steel	Minute ap	CF	-	-	-	-	-	-	01	-	-	
	Finishing	PF CK GF SKS	ASF	JQ	FP FV SMG LS-P	AZ7 AMX ZR	PF XF	FF1	SI FC	PF	11 UF FP PF SM	
	Finishing - Medium	GQ SK	ACB FT	JE	LP AM MV	AM3 YL	PM XM	F1 MF2	SU	PS	LF	14
	Medium	GK	-	J	MP Standard	QD CL	PR	F2	SC	PM	MF MP	Standard
Stainless steel	Finishing	MQ	-	MP	FM FV SV LM	-	MF	-	LU	JS PF PSF	FW FP MW	WF
Non-ferrous metals	Finishing - Medium	AP AH	ALU AWI	-	AZ	-	AL	AL	AG AW	AL	HP	AF AS

R



Technical information

Milling insert description cross reference table

Milling insert description cross reference table

This table is Kyocera's own estimation based on publications and is not authorized by companies mentioned in it.

Kyocera	Class	Applications	MOLDINO (Mitsubishi Hitachi Tool)	Mitsubishi	Sandvik	Sumitomo	Tungaloy	Iscar	
SDMR1203AUER-H SDKR1203AUEN-S	M K	Steel	SDKR42TN	(SDNR1203AEEN-JS)		SDMR1203AEEN SDMR1203AETN	SDMR1203AETN-MJ SDKR1203AESR-MJ SDKR1203AETN-MJ SDKR1203AEPN-MS SDKR42ZSR-MJ SDKR42ZPN-MS	SDKR1203AUTR-HS SDKR1203AUN-76	
SDKN1203AUTN	K		SDK42TN-C9	SDKN1203AEN SDKN1203AETN (SDNN1203AETN1)		SDKN42MT (SDNN1203AETN)	SDKN1203AETN-12 SDKN42ZTN	SDKN1203AETN	
SDKN1203AUFN	K	Cast Iron	SDK42FN-C9			SDKN42M (SDNN1203AEEN)	SDKN1203AEFN-12 SDKN42ZFN		
		Non-ferrous metals				SDKN42M	(SDCN1203AEFN-D) (SDCN42ZFN-DIA)		
SDKN1504AUTN	K	Steel	SDK53TN-C9	SDKN1504AEN SDKN1504AETN		SDKN53MT	SDKN1504AETN SDKN53ZTN	SDKN1504AETN	
SEMR1203AFER-H SEKR1203AFEN-S	M K	Steel	SEKR42TN	(SEER1203AFEN-JS)	SEKR1203AZ-WM (SEER1203AZ-WL)	SEMR1203AFEN (SEER1203AFEN)	SEMR1203AFTN-MJ SEKR1203AFSR-MJ SEKR1203AFTN-MJ SEKR1203AFP-MS	SEKR1203AFTR-HS SEKR1203AFR-HS SEKR1203AFN-76 SEKR1203AF-N-42	
SEEN1203AFTN	E		SEE42TN-C9	SEEN1203AFTN1		SEEN42MT	SEEN1203AFTNCR-14		
SEKN1203AFTN	K		SEK42TN-C9	SEKN1203AFTN1 (SENN1203AFTN1)	SEKN1203AZ (SENN1203AZ)	SEKN42MT (SENN1203AFTN)	SEKN1203AFTN SEKN1203AFTN-16 SEKN42AFTN SEKN42AFTN16		
SEKN1203AFFN	K	Cast Iron	SEK42FN-C9	(SEEN1203AFFN1)	SEKN1203AZ (SENN1203AZ)	SEKN42M (SENN1203AFEN)	SEKN1203AFFN SEKN42AFFN		
SEEN1203AFFN	E	Non-ferrous metals	SEE42FN-C9	(SECN1203AFFR1)					
SEKN1203EFTR	K	Steel	SEK42TR-G3	SEKN1203EFTR1	(SECN1203EER)		SEKN1203EFTR (SECN1203EFTR) (SEEN1203EFTR) (SECN42EFTRCR) (SEEN42EFTRCR)		
SEKN1504AFTN	K	Steel	SEK53TN-C9		SEKN1504AZ	SEKN53MT		SEKN1504AFTN	
SPEN1203EESR	E	Cast iron	(SPK42FR-A3E)	SPEN42EFSR1 SPEN1203EESR1 SPEN1203EEER1 (SPNN1203EEER1)					
SPMR1203EDER-H SPKR1203EDER-S	M K	Steel		(SPER1203EDER-JS)	SPKN1203EDR-WH		SPKR1203EDSR-MJ SPKR42SSR-MJ	SPKR1203EDR-76 SPKR1203EDTR-HS	
SPCN1203EDTR	C				(SPEN1203EDR)	(SPAN1203EDR)	SPCH42TR-R	SPCN1203EDTR SPCN42STR	
SPKN1203EDTR	K		SPK42TR-A3	SPKN1203EDR	SPKN1203EDR	(SPCH42TR) (SPCH42TR-R)	SPKN1203EDTR SPKN42STR (SPEN1203EDTR) (SPEN42STR)	SPKN1203EDTR SPKN1203EDTR-42	
SPKN1203EDFR	K	Cast iron	SPK42FR-A3		SPKN1203EDR	(SPCH42R)	SPKN1203EDFR SPKN42SFR	SPKN1203EDFR	
SPKN1504EDTR	K	Steel	SPK53TR-A3	SPKN1504EDR	SPKN1504EDR	(SPCH53TR-R)	SPKN1504EDTR SPKN53STR (SPCN1504EDTR) (SPCN53STR)	SPKN1504EDTR	
SPKN1504EDFR	K	Cast iron	SPK53FR-A3			(SPCH53R-R) (SPCH53TR-R)	SPKN1504EDFR SPKN53SFR	SPKN1504EDFR	

Note 1. Tolerance class is different for description in ().

2. Since edge shape of milling insert is slightly different by each maker, please adjust edges (Z-axis direction) during operation.

R



Technical information

Milling insert description cross reference table

Milling insert description cross reference table

This table is Kyocera's own estimation based on publications and is not authorized by companies mentioned in it.

Kyocera	Class	Applications	MOLDINO (Mitsubishi Hitachi Tool)	Mitsubishi	Sandvik	Sumitomo	Tungaloy	Iscar
SPCN1203XPTR	C	Steel	SPC42TR-A5				SPCN1203ZPTR SPCN42ZTR	
SPKN1203XPTR	K		SPK42TR-A5				SPKN1203ZPTR SPKN42ZTR (SPEN1203ZPTR) (SPEN42ZTR)	
SPKN1203XPFR	K	Cast iron	SPK42FR-A5				SPKN1203ZPFR SPKN42ZFR	
SPKN1504XETR	K	Steel		SPK53C2SR				
TPMR1603PDER-H	M	Steel		(TPER1603PPER-JS)	(TPKN1603PPR-WH)			(TPKR1603PPTR-HS)
TPKN1603PDTR	K		TPK32TR-E0 TPK32TR-G0	TPKN1603PPR (TPEN1603PPR)	TPKN1603PPR	TPKN32TR		TPKN1603PPTR
TPKN1603PDFR	K	Cast iron	TPK32FR-E0		TPKN1603PPR	TPKN32R		TPKN1603PPFR
TPMR2204PDER-H TPKR2204PDER-S	M K	Steel		(TPER2204PDER-JS)	TPKN2204PDR-WH		TPMR2204PDSR-MJ TPKR2204PDSR-MJ TPKR43ZSR-MJ	TPKR2204PDTR-HS TPKR2204PD-R-76
TPKN2204PDTR	K		TPK43TR-E0 TPK43TR-G0	TPKN2204PDR (TPEN2204PDR)	TPKN2204PDR	(TPCH43TR)	TPKN2204PPTR TPKN43ZTR (TPCN2204PPTR) (TPCN43ZTR)	TPKN2204PDTR TPKN2204PDTR-42
TPKN2204PDFR	K	Cast iron	TPK43FR-E0			(TPCH43R)	TPKN2204PPFR TPKN43ZFR (TPCN2204PPFR) (TPCN43ZFR) (TPEN2204PPTR-16) (TPEN43ZTR)	TPKN2204PDFR
TEMR1603PTER-H	M	Steel		(TEER1603PEER-JS)			(TEKR1603PEPR-MS)	
TEKN1603PTTR	K		TEK32TR-G0 (TEE32TR-G0)	(TEEN1603PETR1)		TEKN32TR	(TECN1603PETR) (TEEN1603PETR) (TECN32ZTR) (TEEN32ZTR)	
TEKN1603PTFR	K	Cast iron	TEK32FR-G0 (TEE32FR-G0)	(TEEN1603PEFR1)		TEKN32R	(TEEN1603PEFR) (TEEN32ZFR)	
TEEN1603PTFR	E	Non-ferrous metals		(TECN1603PEFR1)		TEEN32R	(TECN1603PEFR-D) (TECN32ZFR-DIA)	
TEMR2204PTER-H TEKR2204PTER-S	M K	Steel		(TEER2204PEER-JS)			TEKR2204PEPR-MS	
TEEN2204PTTR	E		TEE43TR-G0E (TEK43TR-G0E)	TEEN2204PETR1		TEEN43TR	TEEN2204PETR (TECN2204PETR) TEEN43ZTR (TECN43ZTR)	
TEKN2204PTTR	K		TEK43TR-G0E	TEKN2204PETR1		TEKN43TR	(TEEN2204PETR) (TECN2204PETR) (TEEN43ZTR) (TECN43ZTR)	
TEKN2204PTFR	K	Cast iron	TEK43FR-G0E	(TEEN2204PEFR1)		TEKN43R	(TEEN2204PEFR) (TEEN43ZFR)	
		Non-ferrous metals		(TECN2204PEFR1)		(TEEN43R)	(TECN2204PEFR-D) (TECN43ZFR-DIA)	
SNCN1204XNTN	C	Steel	SNC43TN-D5	SNC43B2S		(CSN43MT)	SNCN1204ZNTN SNCN43ZTN	
SNKN1204XNTN	K		SNK43TN-D5	SNK43B2S		(CSN43MT)	SNKN1204ZNTN SNKN43ZTN	
SNMF1204XNTN	M	Steel	(SNKF43TN-D5)	(SNKF43B2S)		(CSNB43MT)	(SNKF1204ZNTN) (SNKF43ZFN)	

Note 1. Tolerance class is different for description in ().

2. Since edge shape of milling insert is slightly different by each maker, please adjust edges (Z-axis direction) during operation.

R



Technical information

Terms and angles of turning toolholder

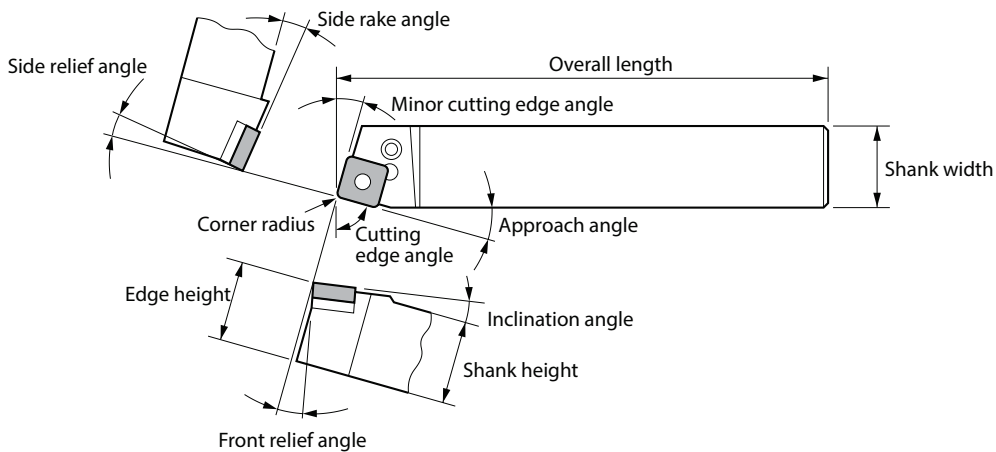

Function of tool angle

Tool angle	Name	Function	Effect
Rake angle	Side rake angle	· Affects cutting force, cutting heat, chip evacuation and tool life.	· If it is positive (+) angle, sharper cutting performance is obtained. (less cutting force, less edge strength) · Positive (+) angle is recommended for easy to machine workpieces or thin workpieces. · Smaller rake angle or negative (-) angle is recommended when a stronger edge is required like scale machining or interrupted machining.
	Inclination angle		
Relief angle	Front relief angle	· Prevents the tool's contact to the workpiece surface, except the cutting edge.	· When it is small, the cutting edge becomes strong, but the wear at relief faces may shorten the tool life.
	Side relief angle		
Cutting edge angle	Cutting edge angle	· Affects chip control and the direction of cutting force.	· When it is large, chip thickness becomes thick and chip control improves.
	Approach angle	· Affects chip control and the direction of cutting force.	· When it is large, chip thickness becomes thin and chip control worsens, but cutting force is dispersed and edge strength improves. · When it is small, chip control ability improves.
	Minor cutting edge angle	· Prevents friction between cutting edge and workpiece surface.	· When it is large, edge strength deteriorates.

R

Toolholder rigidity

1. Flexure of toolholder

$$\delta = \frac{4 \times F \times (LPR)^3}{E \times B \times H^3} = \frac{4 \times k \times ap \times f \times (LPR)^3}{E \times B \times H^3}$$

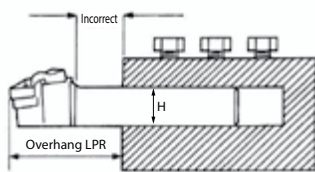

The flexural strength of toolholder will decrease by increasing of shank height by third root and will decrease of reducing overhang by third root. Minimizing toolholder shank overhang as much as possible is important as well as shank's sectional square measure.

2. Flexure of boring bar

$$\delta = \frac{64 \times F \times (LPR)^3}{3 \times E \times \pi \times (DCON)^4} = \frac{64 \times k \times ap \times f \times (LPR)^3}{3 \times E \times \pi \times (DCON)^4}$$

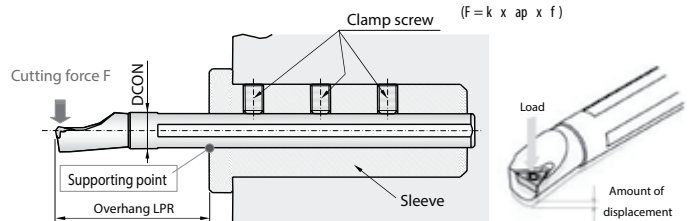

Symbol	Name	Unit
δ (delta)	Deflection	mm
DCON	Shank dia.	mm
E	Young ratio	N/mm ²
ap	Depth of cut	mm
f	Feed rate	mm/rev
k	Specific cutting force	N/mm ³
LPR	Overhang	mm
F	Cutting force	N

(F = k x ap x f)

Technical information

Terms and angles of milling cutter

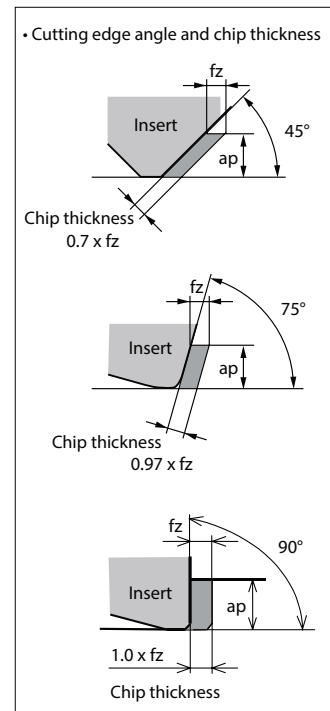
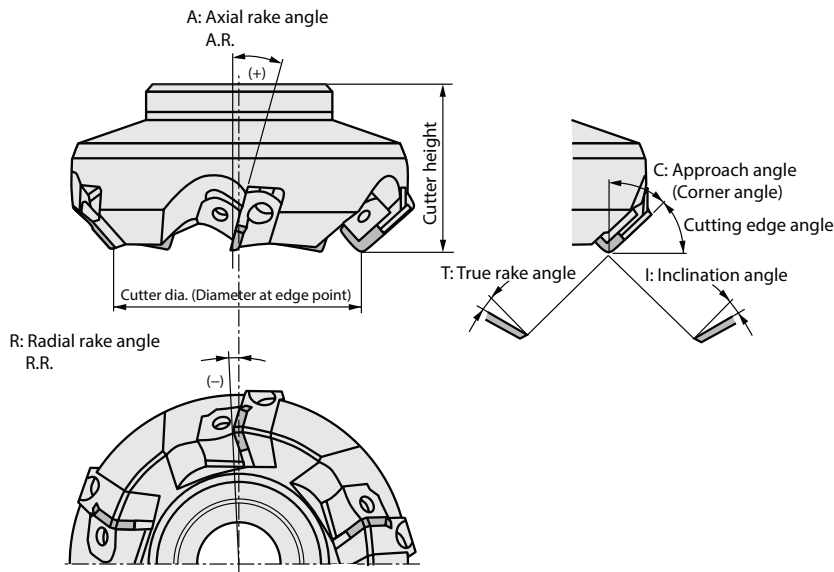

Function of tool angle

Symbol	Name	Function	Effect
A	Axial rake angle (A.R.)	Controls chip flow direction and cutting force	When it is positive ... Good cutting performance and less chip welding
R	Radial rake angle (R.R.)	Controls chip flow direction and cutting force	When it is negative ... Good chip evacuation
C	Approach angle	Controls chip thickness and chip flow direction	When it is large ... Thinner chip thickness Lower cutting load
T	True rake angle	Actual rake angle	When it is positive ... Good cutting performance and less chip welding, but lower edge strength When it is negative ... Higher edge strength but easier to weld
I	Inclination angle	Controls chip flow direction	When it is positive ... Good chip evacuation Less cutting force Lower edge stability of the corner part

The formula for true rake angle: $\tan T = \tan R \times \cos C + \tan A \times \sin C$

The formula for inclination angle: $\tan I = \tan A \times \cos C - \tan R \times \sin C$

No. of Inserts (Z)

1) If the number of stages is one

If the number of stages is one, it is not indicated on the catalogue.
Please use "No. of inserts" of the catalogue for "Z" of the formula to calculate cutting conditions.

MECX End Mill

• Toolholder Dimensions

Description	Stock	No. of Inserts	DC
MECX 08-S10-07-1T	●	1	8
14-S12-07-2T	●	2	14

$fz = \frac{Vf}{Z \times n}$ → $Vf = fz \times Z \times n$

2) If the number of stages is more than two

If the number of stages is more than two, it is indicated on the catalogue.
Please use "No. of flutes" of the catalogue for "Z" of the formula to calculate cutting conditions.

MSR

• Toolholder Dimensions (Metric)

Description	Stock	No. of Inserts	No. of Flutes	No. of Stages	DC	DC(SMS)
MSR 08SR-1M	●	4	4	1	63	50
08SR-2M	●	8	4	2	63	50

$fz = \frac{Vf}{Z \times n}$ → $Vf = fz \times Z \times n$



Technical information

Terms of solid end mill

Square

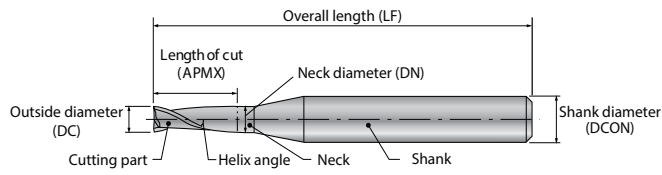

Radius

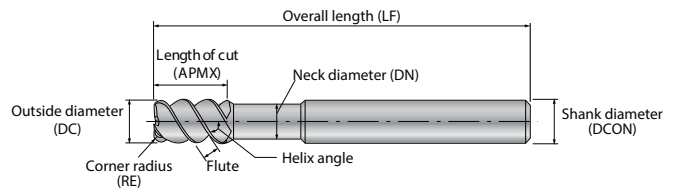

Ball-nose

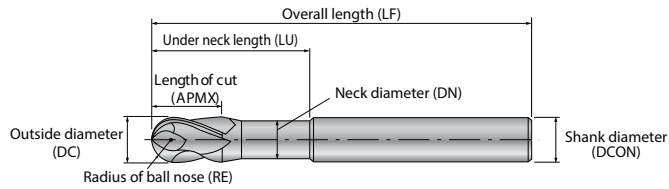

Cutting edge shape

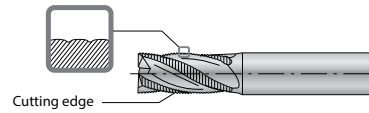

Cutting edge profile

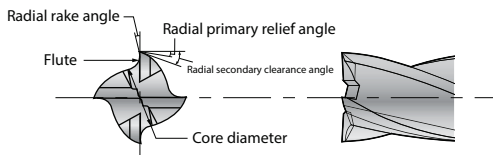

* The illustration shows squared 4 flutes tool

Core diameter rate (%) = Core diameter ÷ Outside dia. x 100

Cutting edge with corner land

Advanced fracture resistance with corner land

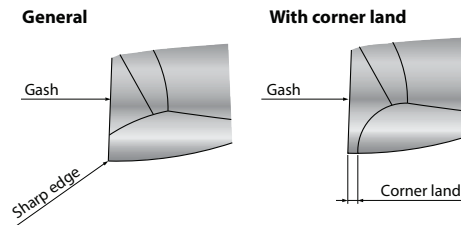

Trouble shooting of solid end mill

Trouble	Check item	Cutting conditions										Tool geometry				Setting		Machine	
		Countermeasures			Cutting direction	Low pick feed	Compressed air	Coolant			Helix angle	No. of blades	Diameter	Tool rigidity enhancement	Large chip pocket	Workpiece / tool installation	Shorten tool overhang	Power, rigidity	
		Vc	fz	ap				Increase volume	Oil based coolant	Wet working									
Edge damage	Cutting edge wear	Unsuitable cutting conditions	● ↓																
		Less number of blades																	
		Up cut																	
Edge damage	Chipping of cutting edge	Unsuitable cutting conditions		● ↓	● ↓														
		Lack of cutting edge strength																	
		Insufficient clamping force																	
Edge damage	Fracture occurs	Unsuitable cutting conditions			● ↓														
		Lack of tool rigidity																	
		Chip packing																	
Cutting accuracy	Poor finished surface on walls	Unsuitable cutting conditions	● ↓		● ↓														
		Chip jamming																	
		Cutting edge wear	● ↓																
Cutting accuracy	Poor finished surface on faces	Large pick feed																	
		Unsuitable cutting conditions		● ↓	● ↓														
		Lack of tool rigidity																	
Cutting accuracy	Out of vertical	Cutting edge wear	● ↓																
		Unsuitable cutting conditions	● ↓	● ↓	● ↓														
		Insufficient clamping force																	
Others	Heavy chattering, vibration	Unsuitable cutting conditions	● ↓	● ↓															
		Lack of tool rigidity																	
		Insufficient clamping force																	
Others	Chip jamming	Unsuitable cutting conditions		● ↓	● ↓														
		Improper tool geometry																	

R



Technical information

Terms of solid drill

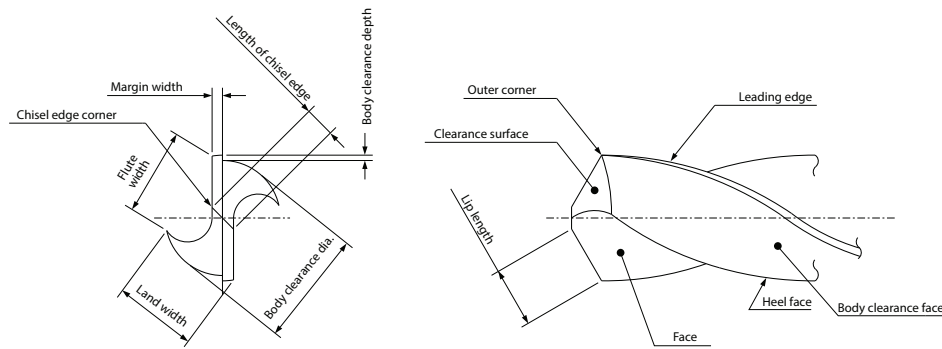
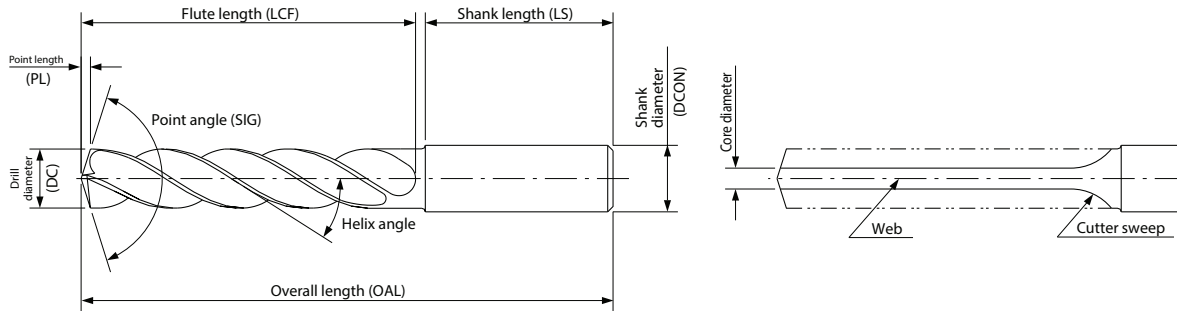

Trouble shooting of solid drill

Trouble	Check item	Countermeasures		Cutting conditions				Tool geometry			Setting		Machine					
		Trouble item	Vc	fz	Lower feed at initial cutting	Lower feed when breaking through	Coolant		Chisel width	Honing width	Core diameter	Shorten flute length	Use internal coolant type tool	Improve tool installation accuracy	Flat workpiece face	Shorten tool overhang	Power, rigidity	
			Higher (larger)↑ Lower (smaller)↓				Increase volume	Increase pressure										Larger ↑ more Smaller ↓ less
Edge damage	Fracture occurs	Unsuitable cutting conditions		● ↓														
		Poor rigidity of drill							● ↑		●				●			
		Sloping machine face																
	Large peripheral cutting edge and margin land wear	Unsuitable cutting conditions	● ↓															
		High cutting heat at the cutting edge point						●					●					
		Poor run-out accuracy												●				
Chipping on peripheral cutting edge	Unsuitable cutting conditions		● ↓			●												
	Large deflection of tool holder													●			●	
	Chattering occurs (vibration)													●			●	
Chipping on chisel	Too wide chisel width							● ↓										
	Poor entry				●													
	Chattering occurs (vibration)																●	
Cutting accuracy	Enlarge hole diameter	Unsuitable cutting conditions	● ↑															
		Poor rigidity of drill																
	Reduce hole diameter	Unsuitable cutting conditions	● ↓															
		High cutting heat at cutting edge point						●					●					
	Poor straightness	Poor rigidity of drill									● ↑	●						
		Large deflection of tool holder												●				●
Poor hole position accuracy, roundness, straightness, surface roughness	Unsuitable cutting conditions			●														
	Poor rigidity of drill									● ↑	●							
	Large deflection of tool holder													●			●	
	Insufficient clamping force																	
Burr	Large burrs at hole exit	Unsuitable cutting conditions				●												
		Improper tool geometry																●
Chip control	Long chips	Unsuitable cutting conditions		● ↑														
		Poor chip disposal						●	●									
	Chip packing	Unsuitable cutting conditions	● ↓	● ↓														
		Poor chip disposal						●	●					●				



Technical information

About wiper inserts

A wiper insert is designed with a wiper edge that is located between corner radius and straight cutting edge shown as right figure.

Advantages

- A wiper edge geometry provides improved surface finish quality even at increased feed rate
- Improved machining efficiency : Reduced cutting time with higher feed rate as well as consolidation of roughing and finishing provide high machining efficiency
- Longer tool life : Reduced cutting time with higher feed rate leads to increase part production
- Excellent chip control : Higher feed rate makes chips thicker, which provides easier-to-break chips

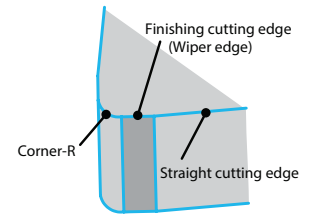

Precautions when using WF / WE chipbreaker (negative insert)

Tip of corner-R (DNMX, TNMX)

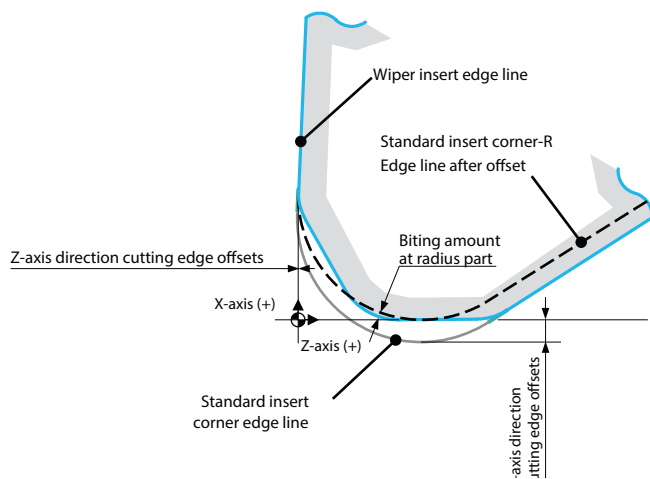

Cautions when machining inside corner-R

Do not use this wiper insert if a precise inside corner-R is required when such a machining in the figure below.

R



Technical information

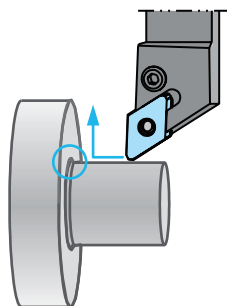

* From external turning to up facing without arc complement (A wiper edge does not work during up facing)

DNMX / TNMX WF chipbreaker

- More incomplete cutting and excessive cutting during machining with this chipbreaker than the machining with a standard insert
- The inside corner-R dimension become smaller than the requirement.

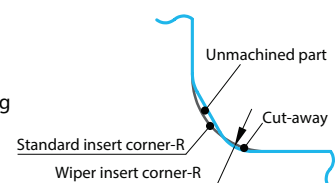

CNMG / WNMG WF / WE chipbreaker

- The inside corner-R dimension would be smaller than the requirement (Cutting excessively).

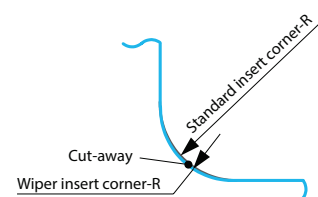

WF / WE chipbreaker edge position offset adjustment

WF / WE chipbreaker (Negative Insert) edge position offset adjustment

For D type and T type, cutting edge offsets are required.

Cutting edge offsets (mm)					
DNMX150404WF DNMX150604WF		DNMX150408WF DNMX150608WF		DNMX150412WF DNMX150612WF	
X-axis direction	Z-axis direction	X-axis direction	Z-axis direction	X-axis direction	Z-axis direction
0.24	0.02	0.14	0.01	0.11	0.01

Cutting edge offsets (mm)					
TNMX160404WF		TNMX160408WF		TNMX160412WF	
X-axis direction	Z-axis direction	X-axis direction	Z-axis direction	X-axis direction	Z-axis direction
0.24	0.01	0.16	0.00	0.11	0.00

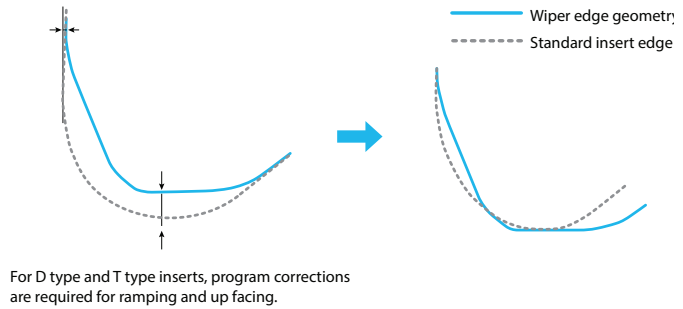

Program corrections for tapered part of workpiece (Z-axis direction cutting edge offsets)

DNMX1504 / DNMX1506 type

Corner-R(RE) (mm)	Ramping angle θ					
	0°	5°	10°	15°	20°	25°
0.4	0.00	-0.34	-0.35	-0.36	-0.36	-0.36
0.8	0.00	-0.26	-0.26	-0.25	-0.24	-0.22
1.2	0.00	-0.15	-0.17	-0.16	-0.15	-0.15

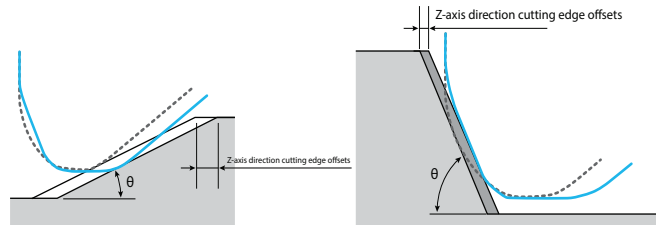

Corner-R(RE) (mm)	Up facing angle θ																			
	0°	5°	10°	15°	20°	25°	30°	35°	40°	45°	50°	55°	60°	65°	70°	75°	80°	85°	90°	
0.4	0.00	-0.02	-0.03	-0.03	-0.04	-0.05	-0.06	-0.07	-0.08	-0.09	-0.10	-0.11	-0.12	-0.10	-0.08	-0.06	-0.04	-0.02	0.00	
0.8	0.00	0.13	0.12	0.11	0.09	0.07	0.05	0.04	0.02	0.00	-0.02	-0.05	-0.07	-0.06	-0.04	-0.02	-0.01	-0.01	0.00	
1.2	0.00	0.36	0.34	0.31	0.27	0.24	0.20	0.16	0.13	0.09	0.05	0.00	-0.04	-0.04	-0.03	-0.02	-0.01	-0.01	0.00	

TNMX1604 type

Corner-R(RE) (mm)	Ramping angle θ					
	0°	5°	10°	15°	20°	25°
0.4	0.00					
0.8	0.00					
1.2	0.00					

Do not use TNMX1604 type insert for ramping.

Corner-R(RE) (mm)	Up facing angle θ																			
	0°	5°	10°	15°	20°	25°	30°	35°	40°	45°	50°	55°	60°	65°	70°	75°	80°	85°	90°	
0.4	0.00	-0.06	-0.05	-0.05	-0.06	-0.07	-0.08	-0.08	-0.09	-0.10	-0.11	-0.12	-0.13	-0.12	-0.10	-0.07	-0.05	-0.02	0.00	
0.8	0.00	0.11	0.11	0.10	0.08	0.06	0.04	0.02	0.00	-0.02	-0.04	-0.06	-0.08	-0.08	-0.06	-0.04	-0.02	-0.01	0.00	
1.2	0.00	0.34	0.32	0.29	0.25	0.22	0.19	0.15	0.14	0.08	0.04	0.00	-0.05	-0.05	-0.03	-0.01	0.00	0.00	0.00	

Caution (Finished edge line)

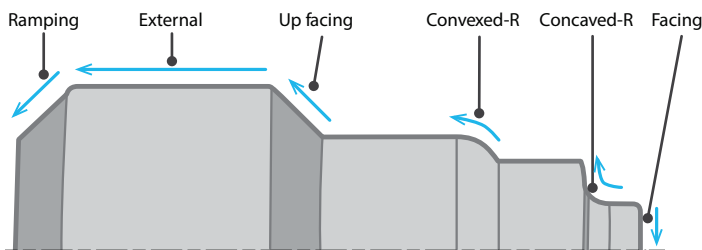

Applications	Notes
External / Facing	Toolholders for D type and T type would not be able to provide sufficient performance depending on a toolholder. Please use an applicable toolholder.
Up facing Ramping	For D type and T type inserts, program corrections on Z-axis direction are required.
Convexed-R / Concaved-R	Do not use wiper insert if a precise R shape is needed.

Precautions when using WP chipbreaker (Positive insert)

Proper use for a neutral insert and a handed insert

Neutral

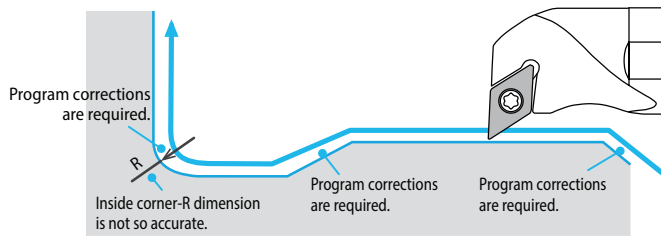
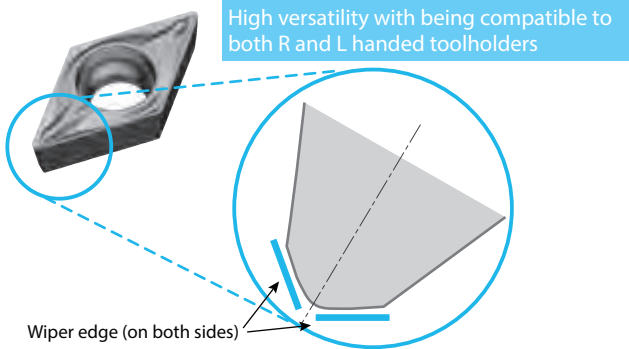

- When use a neutral type insert,
- you need to correct programs for three areas.
 - it should be used for machining which does not require inside corner-R accuracy.

Handed (Left-hand shown)

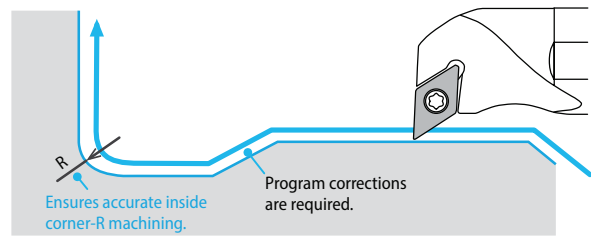
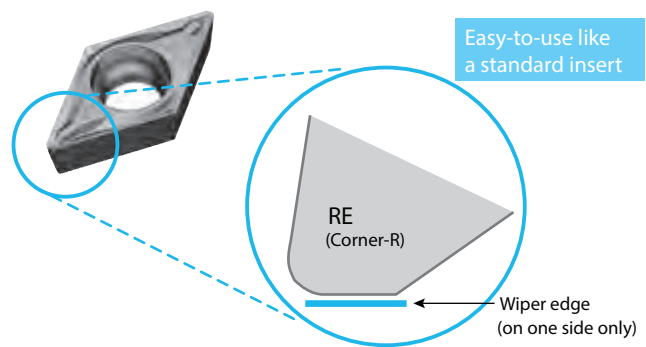

- When use a handed insert,
- you need to correct program for ramping.
 - it provides accurate inside corner-R machining.
- ➔ Less program correction is required as well as easy-to-use like a standard insert
- * Position of cutting edge differs from a standard insert. Cutting edge adjustment is required.

Caution (Finished edge line)

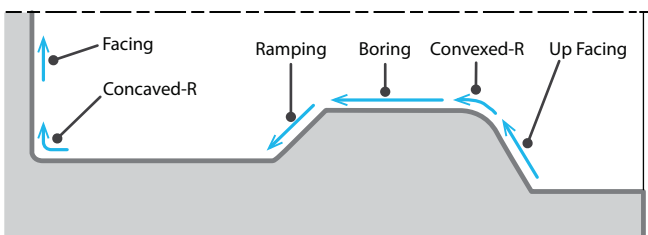

Neutral

Applications	Caution
Boring / Facing	Toolholders for D type and T type would not be able to provide sufficient performance depending on a toolholder. Please use an applicable toolholder.
Up Facing / Ramping	For D type and T type inserts, program corrections on Z-axis direction are required.
Convexed-R / Concaved-R	Do not use wiper inserts if a precise R shape is needed.

Handed

Applications	Caution
Boring	Toolholders for D type and TP type would not be able to provide sufficient performance depending on a toolholder. Please use an applicable toolholder.
Ramping	For D type and TP type inserts, program corrections on Z-axis direction are required.
Convexed-R / Concaved-R	Surface finish quality is as standard insert is.
Up Facing	Surface finish quality is as standard insert is.
Facing	Surface finish quality is as standard insert is.

Cautions when machining inside corner-R

Do not use this wiper insert if a precise inside corner-R is required when such a machining in the figure below.

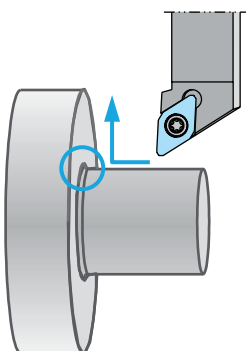

DCMX / TC(P)MX * Neutral WP chipbreaker

- More incomplete cutting and excessive cutting during machining with this chipbreaker than the machining with a standard insert
- The inside corner-R dimension become smaller

CCMT * Neutral DCMX / TPMX * Handed WP chipbreaker

- No problem in the finished line on workpiece (Adjustments are required)

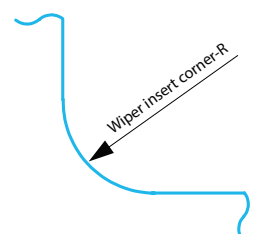
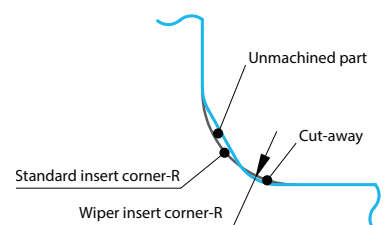

R



Technical information

Precautions when using Wiper inserts

WP chipbreaker (Positive insert) Edge position offset adjustment

Neutral

For D type and T type, cutting edge offsets are required.

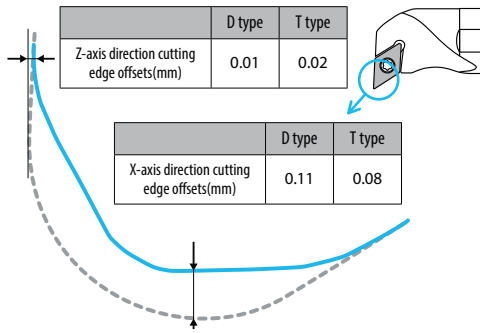

— Wiper edge geometry
 - - - Standard insert edge line

For D type and T type inserts, program corrections are required for ramping and up facing.

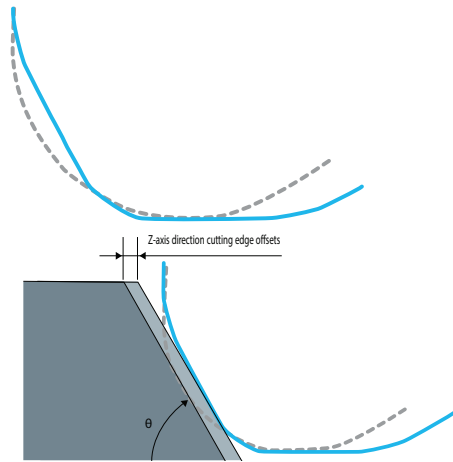
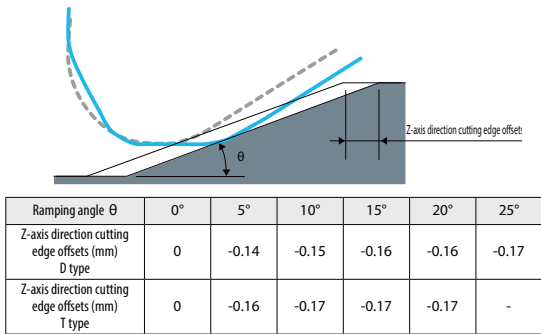

Handed

For D type and T type, cutting edge offsets are required.

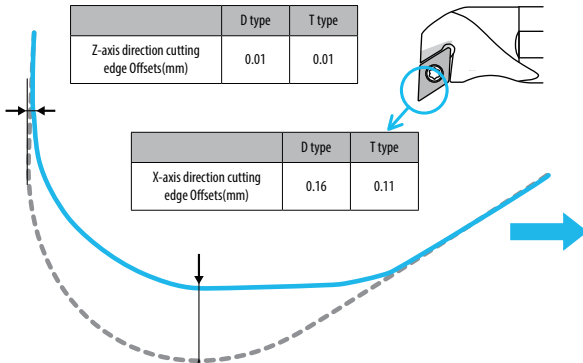

— Wiper edge geometry
 - - - Standard insert edge line

For D type and T type inserts, program corrections are required for ramping.

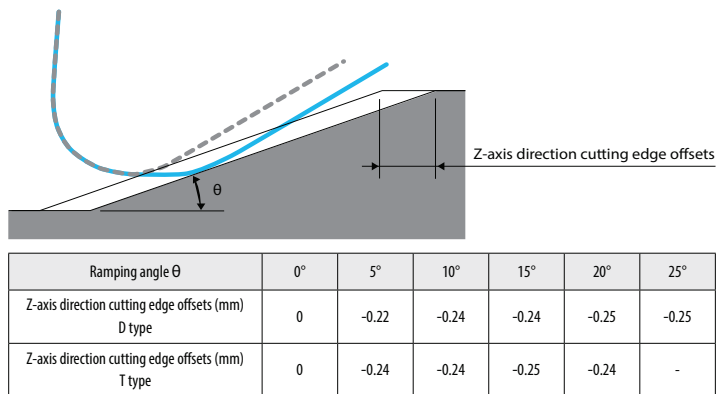







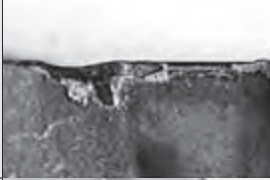

R

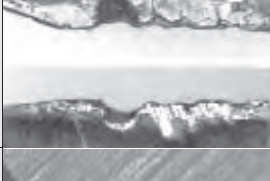

Technical information

Cutting edges figuration and countermeasures

Typical cutting edge figuration		Observation	Causes	Countermeasures
Nose wear		<ul style="list-style-type: none"> Deterioration of surface roughness and dimensional accuracy 	<ul style="list-style-type: none"> Too high Vc End of tool life 	<ul style="list-style-type: none"> Reduce Vc Change to higher wear resistant grade
Notching		<ul style="list-style-type: none"> Burr formation Cutting force increase 	<ul style="list-style-type: none"> Too high f and Vc 	<ul style="list-style-type: none"> Sharper cutting performance Reduce Vc Change to higher heat resistant grade
Crater wear		<ul style="list-style-type: none"> Chip control deterioration Surface finish deterioration (peeled surface) 	<ul style="list-style-type: none"> Too high Vc 	<ul style="list-style-type: none"> Reduce Vc Change to high speed type like Cermet or Al₂O₃ coated insert grade
Plastic deformation		<ul style="list-style-type: none"> Workpiece dimension changes Crack at nose 	<ul style="list-style-type: none"> Too high cutting load Inappropriate insert grade 	<ul style="list-style-type: none"> Change to harder grade Reduce f and ap
Crack from wear		<ul style="list-style-type: none"> Surface finish's sudden deterioration Workpiece dimension changes 	<ul style="list-style-type: none"> Too high Vc 	<ul style="list-style-type: none"> Change the tool earlier Change to higher wear resistant grade
Chipping		<ul style="list-style-type: none"> Cutting force increase Surface roughness deterioration 	<ul style="list-style-type: none"> Too high f Chattering Lack of insert toughness 	<ul style="list-style-type: none"> Reduce f and ap Change to more rigid toolholder Change to tougher grade
Crack from welding or built-up edge		<ul style="list-style-type: none"> Surface finish deterioration Cutting force increase 	<ul style="list-style-type: none"> Too low Vc 	<ul style="list-style-type: none"> Increase Vc Improve sharp cutting performance (rake angle, chamfer)
Mechanical fracture		<ul style="list-style-type: none"> Sudden cracking Unstable tool life 	<ul style="list-style-type: none"> Too high f and ap Chattering 	<ul style="list-style-type: none"> Change to tougher grade Enlarge chamfer Enlarge Corner-R(RE) Change to more rigid toolholder
Fracture from thermal crack		<ul style="list-style-type: none"> Cracking by heat cycle Possible in interrupted machining and milling 	<ul style="list-style-type: none"> Too high Vc and f 	<ul style="list-style-type: none"> Reduce f Reduce Vc Change to dry cutting
Flaking		<ul style="list-style-type: none"> Possible in hard materials machining Possible in machining with chattering 	<ul style="list-style-type: none"> Lack of insert toughness Poor rigidity of toolholder 	<ul style="list-style-type: none"> Change to tougher grade (TiC-base ceramic to CBN.) Change to more rigid toolholder Change edge preparation

R



Technical information

Turning

Trouble	Check item	Insert grades				Cutting conditions				Tool geometry					Setting		Machine					
		Countermeasures	Change to harder grade	Change to tougher grade	Change to more thermal shock resistant grade	Change to more welding resistant grade	Vc	f	ap	Tool path review	Coolant		Chipbreaker review	Rake angle	Corner-R(RE)	Approach angle	Edge strength / Honing	Change to higher tolerance (M→G)	Toolholder rigidity	Workpiece / Tool Installation	Overhang length	Power, rigidity
											Wet	Dry										
Trouble item						Higher (Larger) ↑ Lower (Smaller) ↓																
Unstable dimension	Unstable workpiece dimension	Unsuitable insert tolerance																				
		Tool and workpiece evacuation											●	● ↑	● ↓	● ↓			●	●	●	●
Unstable dimension	Frequent offset during machining	Flank wear increase	●												● ↑							
		Unsuitable cutting conditions					● ↓	● ↑														
		Built-up edge				●	● ↑															
Surface roughness deterioration	Poor surface roughness	Poor cutting by tool wear	●			●	● ↓				●		●	● ↑	● ↑		● ↓	●				
		Chipping		●				● ↓	● ↓				●		● ↑	● ↑				●	●	●
		Welding, built-up edge				●	● ↑				●		●	● ↑			● ↓	●				
		Unsuitable cutting conditions					● ↑	● ↓	● ↓		●											
		Unsuitable tool geometry										●		● ↑		● ↓	●					
		Vibration, chattering		●			● ↓	● ↓ ^{*1}	● ↓				●	● ↑	● ↓	● ↓	● ↓		●	●	●	●
Heat	Deterioration of accuracy or tool life by cutting heat	Unsuitable cutting conditions				● ↓	● ↓	● ↓		●												
		Unsuitable insert grades and tool geometry	●									●	● ↑			● ↓						
Burr, workpiece chip off and scuffing	Burr	Unsuitable cutting conditions				● ↓	● ↑		●	●												
		Unsuitable insert grades and tool geometry	●									●	● ↑	● ↓	● ↓	● ↓						
	Workpiece chip off	Unsuitable cutting conditions					● ↓	● ↓	●													
		Unsuitable insert grades and tool geometry	●									●	● ↑	● ↑	● ↑	● ↓		●	●	●	●	
Scuffing	Unsuitable cutting conditions				● ↑	● ↓ ^{*2}			●													
	Unsuitable insert grades and tool geometry	●		●							●	● ↑			● ↓							
Edge damage	Wear increase at relief face, rake face	Flank wear	●			● ↓				●		●	● ↑	● ↑		● ↓						
		Rake face wear	●				● ↓	● ↓	● ↓		●		●	● ↑	● ↑							
	Notching	Notching				●	● ↓			●												
	Chipping	Vibration, chattering	●				● ↓	● ↓			●			● ↑	● ↑		●	●	●	●		
	Crack	Unsuitable insert grades and cutting conditions	●	●			● ↓	● ↓				●		● ↑	● ↑	● ↑		●	●	●		
	Thermal crack	Work hardness, unsuitable insert grades and cutting conditions		●			● ↓	● ↓	● ↓		●		●	● ↑		● ↓						
	Edge nose deformation	Edge nose deformation during interrupted machining	●				● ↓	● ↓	● ↓				●	● ↓	● ↑	● ↑	● ↑					
	Built-up edge	Work hardness, unsuitable insert grades and cutting conditions				●	● ↑	● ↑		●		●	● ↑			● ↓	●					
Chip control	Long, tangling chips	Unsuitable cutting conditions				● ↓ ^{*3}	● ↑	● ↑	●	●												
		Unsuitable tool geometry										●		● ↓	● ↓							
	Chips scattering	Unsuitable cutting conditions					● ↓	● ↓		●												
		Unsuitable tool geometry									●		●	● ↑	● ↑							

*1. To prevent chattering, the higher f may be suitable.

*2. To prevent scuffing, the higher f may be suitable.

*3. When using X chipbreaker insert for soft steel and low carbon steel, the higher Vc cuts chips short.



Technical information

Milling

Trouble	Trouble item	Check item		Insert grades		Cutting conditions						Tool geometry						Setting		Machine						
		Countermeasures	Change to harder grade	Change to tougher grade	Change to more thermal shock resistant grade	Change to more welding resistant grade	Vc	fz	ap	Cutter dia. cutting width review	Tool path review	Coolant		Relief angle	Corner angle	Edge strength / Honing	No. of inserts	Chip pocket	Wiper edge (Relief angle) review	Insert runout check	Cutter rigidity	Workpiece / tool installation	Overhang length	Power, rigidity		
							Higher (Larger)↑ Lower (Smaller)↓	Usage of mist	Dry			Larger ↑ Smaller ↓	More↑ Less↓												Larger↑ Smaller↓	
Edge damage	Flank wear increase	Unsuitable cutting conditions				●↓						●														
		Unsuitable tool geometry	●											●↑		●↓			●							
	Rake face wear increase	Unsuitable cutting conditions					●↓	●↓	●↓				●													
		Unsuitable tool geometry	●											●↑	●↑	●↓										
	Chipping, cracking	Unsuitable cutting conditions					●↓	●↓		●	●															
		Unsuitable tool geometry		●										●↓	●↑	●↑			●	●	●	●	●	●	●	●
Edge breakage by thermal shock	Unsuitable cutting conditions					●↓	●↓	●↓				●														
	Unsuitable tool geometry			●									●↑		●↓											
Built-up edge	Unsuitable cutting conditions					●↑	●↑					●														
	Unsuitable tool geometry				●								●↑		●↓											
Cutting accuracy	Poor surface finish	Unsuitable cutting conditions				●↑	●↓	●↓				●						●	●			●	●	●	●	
		Unsuitable tool geometry	●		●											●↓	●↓		●	●			●	●	●	
	Burr formation	Unsuitable cutting conditions					●↓	●↓	●↓	●	●															
		Unsuitable tool geometry												●↑	●↓	●↓			●							
	Workpiece chip off	Unsuitable cutting conditions					●↓	●↓		●																
		Unsuitable tool geometry												●↑	●↑	●↓	●↑		●							
Poor planeness / parallelism	Tool and workpiece evacuation					●↓	●↓				● ^{*5}	●	●	●↑	●↓	●↓	●↓	●	●	●	●	●	●	●		
Others	Heavy chattering, vibration	Unsuitable cutting conditions, installation				●↓	● ^{*1} ↓	● ^{*2} ↓	●	● ^{*4}			●	●↑	●↓	●↓	●↓					●	●	●	●	
		Unsuitable tool geometry				●↑	● ^{*3} ↓		●			● ^{*6}	●													
	Chip jamming	Unsuitable tool geometry											●	●↑				●↓	●↑							

*1. To prevent chattering, the higher fz may be suitable.

*2. To prevent chattering, the larger ap may be suitable.

*3. Higher fz may be suitable.

*4. Down-cut method is recommended for helical end milling.

*5. If the surface is warped by cutting heat.

*6. Compressed air is recommended.

R



Technical information

Drilling (MagicDrill series)

Trouble	Countermeasures	Check item		Insert grades		Cutting conditions		Tool geometry			Setting			Machine	
		Change to harder grade	Change to tougher grade	Vc	fz	Coolant discharge condition	Chipbreaker review	Inner edge's center height check (Core dia. check)		Toolholder rigidity improvement (Short type)	Workpiece / Tool installation	Insert installation	Offset check	Adjustable sleeve usage	Power, rigidity
								Higher (Larger)↑ Lower (Smaller)↓	Larger ↑ Smaller ↓						
Trouble item															
Edge damage	Unusual wear	Unsuitable cutting speed (too high)	●		●↓										
		Unsuitable cutting speed (too low)		●	●↑										
		Unsuitable coolant discharge					●								
		Poor rigidity of machine / workpiece								●					●
		Small hole dia.											●*1	●	
		Unsuitable insert grade	●												
	Inner edge cracking	No core, too small core							●↑						
		Poor rigidity of machine / workpiece								●	●				●
		Unstable drilling start				●↓									
		High hardness workpiece	●		●↓	●↓									
		Clogged chips			●↑				●↓						
		Unstable insert installation									●				
	Outer edge cracking	Poor rigidity of machine / workpiece								●					●
		Unstable drilling start				●↓									
		High hardness workpiece	●		●↓	●↓									
		Poor chip control		●	●↑										
		Unstable insert installation									●				
	Toolholder, others	Scratches on tool body	Poor rigidity of machine / workpiece								●				●
Inaccurate tool installment												●*1	●		
Clogged chips					●↑	●↓									
Unstable drilling start						●↓									
Poor hole dia. accuracy / Surface finish		Poor rigidity of machine / workpiece								●					●
		Poor rigidity of toolholder								●	●				
		Inaccurate tool installment										●*1	●		
		Clogged chips			●↑	●↓			●↓						
		Large core dia.							●↓						
		Unstable drilling start				●↓									
		Unsuitable coolant discharge					●								
Large vibration / chattering		Unsuitable cutting conditions, installation			●↑	●↓				●	●				●
		Unsuitable cutting conditions			●↑										
Long chips		Unsuitable chipbreaker							●						
		Lack of machine power			●↓	●↓			●						●

*1. For lathe operation



Technical information

Turning

Cutting speed

$$V_c = \frac{\pi \times D_m \times n}{1,000}$$

V_c : Cutting speed [m/min]

D_m : Workpiece dia. [mm]

n : Spindle revolution [min⁻¹]

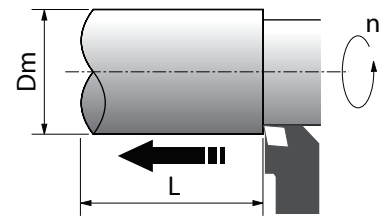

Power requirement

$$P_c = \frac{K_s \times V_c \times a_p \times f}{6,120 \times \eta}$$

P_c : Power requirement [kW]

P_{HP} : Power requirement (Horse power) [HP]

V_c : Cutting speed [m/min]

a_p : Depth of cut [mm]

f : Feed rate [mm/rev]

K_s : Specific cutting force [kgf/mm²]

η : Mechanical efficiency (0.7 ~ 0.8)

Ks [kgf/mm ²]	
Low carbon steel	190
Medium carbon steel	210
High carbon steel	240
Low alloy steel	190
High alloy steel	245
Cast iron	93
Malleable cast iron	120
Bronze, brass	70

Theoretical surface roughness

$$R_z(h) = \frac{f^2}{8 \times RE} \times 1,000$$

$R_z(h)$: Theoretical surface roughness [μ m]

f : Feed rate [mm/rev]

RE : Corner radius of insert [mm]

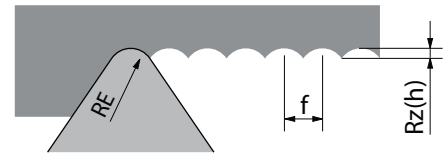

Chip removal volume

$$Q = V_c \times a_p \times f$$

Q : Chip removal volume [cm³/min=cc/min]

V_c : Cutting speed [m/min]

a_p : Depth of cut [mm]

f : Feed rate [mm/rev]

R

Technical information

Edge position compensation when changing corner-R(RE)

$$\Delta X = (RE - RE') \times \left\{ \frac{\cos \left(\frac{EPSR}{2} + (KRINS - 90^\circ) \right)}{\sin \frac{EPSR}{2}} - 1 \right\}$$

$$\Delta Z = (RE - RE') \times \left\{ \frac{\sin \left(\frac{EPSR}{2} + (KRINS - 90^\circ) \right)}{\sin \frac{EPSR}{2}} - 1 \right\}$$

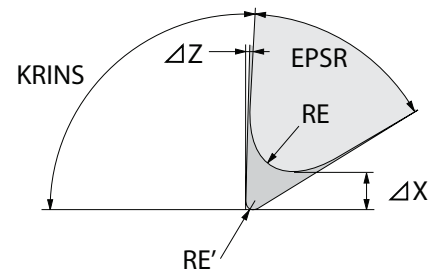

ΔX : X-axis direction cutting edge offsets [mm]

ΔZ : Z-axis direction cutting edge offsets [mm]

RE : Corner-R before change [mm]

RE' : Corner-R after change [mm]

$EPSR$: Insert corner angle [°]

$KRINS$: Toolholder's cutting edge angle [°]

Toolholder type	Insert corner angle EPSR	Cutting edge angle KRINS	ΔX	ΔZ
DCLN/PCLN	80°	95°	0.100 x (RE-RE')	0.100 x (RE-RE')
DTGN/PTGN	60°	91°	0.714 x (RE-RE')	0.030 x (RE-RE')
DDJN/PDJN	55°	93°	0.866 x (RE-RE')	0.099 x (RE-RE')
DDHN/PDHN	55°	107.5°	0.531 x (RE-RE')	0.531 x (RE-RE')
DVLN/PVLN	35°	95°	2.072 x (RE-RE')	0.273 x (RE-RE')
DVPN/PVPN	35°	117.5°	1.351 x (RE-RE')	1.351 x (RE-RE')
DSBN/PSBN	90°	75°	0.225 x (RE-RE')	-0.293 x (RE-RE')

Example: Compensation when changing corner-R from 0.8 to 0.4, using PCLN toolholder,

$$\Delta X = 0.100 \times (0.8 - 0.4) = 0.04(\text{mm})$$

$$\Delta Z = 0.100 \times (0.8 - 0.4) = 0.04(\text{mm})$$

Turning (Cutting time)

Cutting time (External turning case 1: 1 pass machining)

At constant revolution

$$T = \frac{60 \times L}{f \times n}$$

At constant cutting speed

$$T = \frac{60 \times \pi \times L \times D_m}{1,000 \times f \times V_c}$$

T : Cutting time [sec]

L : Cutting length [mm]

f : Feed rate [mm/rev]

n : Spindle revolution [min⁻¹]

D_m : Workpiece dia. [mm]

V_c : Cutting speed [m/min]

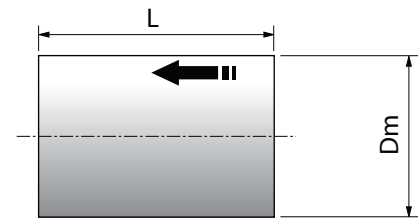

Cutting time (External turning case 2: multi-pass machining)

At constant revolution

$$T = \frac{60 \times L}{f \times n} \times N$$

At constant cutting speed

$$T = \frac{60 \times \pi \times L \times (D_1 + D_2)}{2 \times 1,000 \times f \times V_c} \times N$$

T : Cutting time [sec]

L : Cutting length per pass [mm]

ap : Depth of cut per pass [mm]

f : Feed rate [mm/rev]

n : Spindle revolution [min⁻¹]

D₁ : Max. dia. of workpiece [mm]

D₂ : Min. dia. of workpiece [mm]

V_c : Cutting speed [m/min]

N : Number of passes = (D₁ - D₂) / ap / 2 (if it is indivisible, obtain integer by rounding up one place of decimals.)

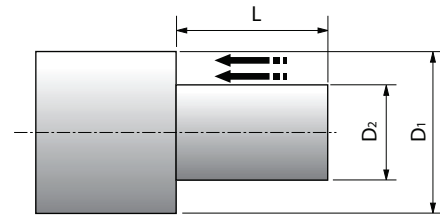

Cutting time (Facing)

At constant revolution

$$T = \frac{60 \times (D_1 - D_2)}{2 \times f \times n} \times N$$

At constant cutting speed

$$T_1 = \frac{60 \times \pi \times (D_1 + D_2) \times (D_1 - D_2)}{4,000 \times f \times V_c} \times N$$

T : Cutting time [sec]

T₁ : Cutting time before reaching
Max. spindle revolution [sec]

L : Cutting length [mm]

ap : Depth of cut per pass [mm]

f : Feed rate [mm/rev]

n : Spindle revolution [min⁻¹]

D₁ : Max. dia. of workpiece [mm]

D₂ : Min. dia. of workpiece [mm]

V_c : Cutting speed [m/min]

N : Number of passes = L / ap (if it is indivisible, obtain integer by rounding up one place of decimals.)

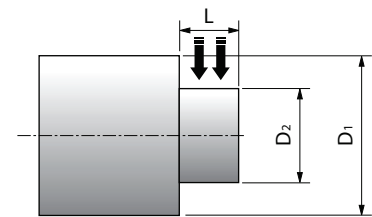

Cutting time (Grooving)

At constant revolution

$$T = \frac{60 \times (D_1 - D_2)}{2 \times f \times n}$$

At constant cutting speed

$$T_1 = \frac{60 \times \pi \times (D_1 + D_2) \times (D_1 - D_2)}{4,000 \times f \times V_c}$$

T : Cutting time [sec]

T₁ : Cutting time before reaching
Max. spindle revolution [sec]

L : Cutting length [mm]

f : Feed rate [mm/rev]

n : Spindle revolution [min⁻¹]

D₁ : Max. dia. of workpiece [mm]

D₂ : Min. dia. of workpiece [mm]

V_c : Cutting speed [m/min]

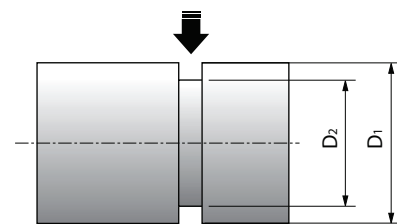

Cutting time (Cut-off)

At constant revolution

$$T = \frac{60 \times D_1}{2 \times f \times n}$$

At constant cutting speed

$$T_1 = \frac{60 \times \pi \times (D_1 + D_3) \times (D_1 - D_3)}{4,000 \times f \times V_c}$$

$$T_3 = T_1 + \frac{60 \times D_3}{2 \times f \times n_{\max}}$$

T : Cutting time [sec]

T₁ : Cutting time before reaching
Max. spindle revolution [sec]

T₃ : Cutting time when reaching
Max. spindle revolution [sec]

f : Feed rate [mm/rev]

n : Spindle revolution [min⁻¹]

n_{max} : Max. spindle revolution [min⁻¹]

D₁ : Max. dia. of workpiece [mm]

D₃ : Diameter when reaching max. spindle revolution [mm]

V_c : Cutting speed [m/min]

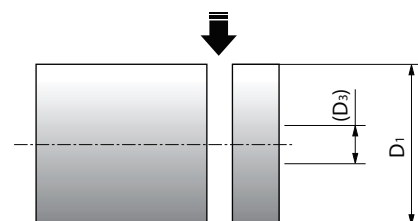

Milling

Cutting speed

$$V_c = \frac{\pi \times DC \times n}{1,000}$$

- V_c : Cutting speed [m/min]
- DC : Cutter dia. [mm]
- n : Spindle revolution [min^{-1}]

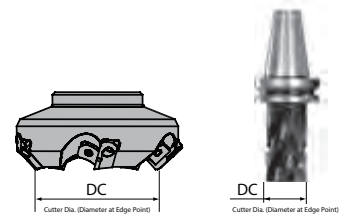
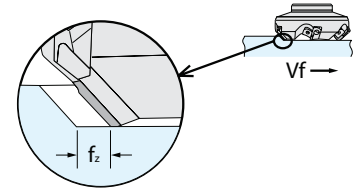

Table feed & feed per tooth

$$f_z = \frac{V_f}{Z \times n}$$

- f_z : Feed per tooth [mm/t]
- V_f : Table feed [mm/min]
- Z : No. of inserts
- n : Spindle revolution [min^{-1}]



Power requirement

$$P_c = \frac{K_s \times Q}{6,120 \times \eta} = \frac{K_s \times a_e \times V_f \times a_p}{6,120,000 \times \eta}$$

$$= \frac{K_s \times a_e \times f_z \times Z \times n \times a_p}{6,120,000 \times \eta}$$

$$P_{HP} = \frac{6,120}{4,500} \times P_c$$

- P_c : Power requirement [kW]
- P_{HP} : Power requirement (Horse power) [HP]
- a_e : Width of cut [mm]
- V_f : Table feed [mm/min]
- f_z : Feed per tooth [mm/t]
- Z : No. of inserts
- n : Spindle revolution [min^{-1}]
- a_p : Depth of cut [mm]
- K_s : Specific cutting force [kgf/mm²]
- η : Mechanical efficiency (0.7 ~ 0.8)
- Q : Chip removal volume [cm³/min=cc/min]

K _s [kgf/mm ²]	
Low carbon steel	190
Medium carbon steel	210
High carbon steel	240
Low alloy steel	190
High alloy steel	245
Cast iron	93
Malleable cast iron	120
Bronze, Brass	70

Chip removal volume

$$Q = \frac{a_e \times V_f \times a_p}{1,000} = \frac{a_e \times f_z \times Z \times n \times a_p}{1,000}$$

- Q : Chip removal volume [cm³/min=cc/min]
- a_e : Width of cut [mm]
- V_f : Table feed [mm/min]
- f_z : Feed per tooth [mm/t]
- Z : No. of inserts
- n : Spindle revolution [min^{-1}]
- a_p : Depth of cut [mm]

Cutting time

$$T = \frac{60 \times L'}{V_f} = \frac{60 \times L'}{f_z \times Z \times n}$$

- T : Cutting time [sec]
- L' : Total table transfer length [mm]
(= L+DC+2α)
- L : Workpiece length [mm]
- DC : Cutter dia. [mm]
- α : Idling distance [mm]
- V_f : Table feed [mm/min]
- f_z : Feed per tooth [mm/t]
- Z : No. of inserts
- n : Spindle revolution [min^{-1}]

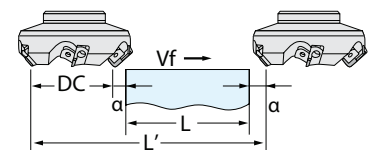

R



Technical information

True rake angle

$$\tan T = \tan R \times \cos C + \tan A \times \sin C$$

Inclination angle

$$\tan I = \tan A \times \cos C - \tan R \times \sin C$$

A (GAMP) : Axial rake angle (A.R.) [°] (-90° < A < 90°)

R (GAMF) : Radial rake angle (R.R.) [°] (-90° < R < 90°)

C (KAPR) : Approach angle [°] (0° < C < 90°)

T (GAMN) : True rake angle [°] (-90° < T < 90°)

I (GAMO) : Inclination angle [°] (-90° < I < 90°)

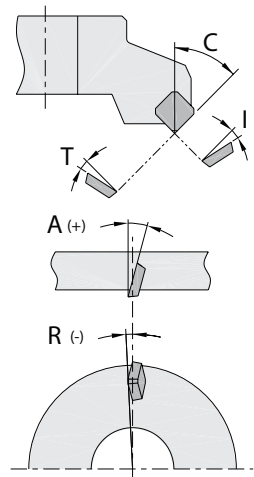

Ball-nose end mill cutting speed & revolution

$$n = \frac{1,000 \times V_a}{2 \times \pi \times \sqrt{ap(2RE-ap)}}$$

n : Revolution [min⁻¹]

RE : Radius of ball-nose end mill (Ball part's radius) [mm]

ap : Depth of cut [mm]

V_a : Cutting speed at actual dia. d [m/min]

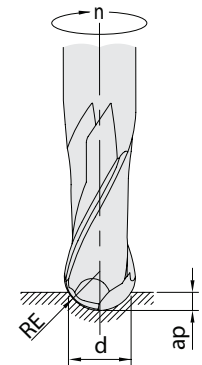

Drilling (MagicDrill series)

Cutting speed

$$V_c = \frac{\pi \times DC \times n}{1,000}$$

V_c : Cutting speed [m/min]

DC : Drill dia. [mm]

n : Spindle revolution [min⁻¹]

Feed rate (Milling)

$$V_f = f_z \times Z \times n$$

V_f : Table feed [mm/min]

f_z : Feed per tooth [mm/t]

Z : No. of inserts (No. of insert = 1)

n : Spindle revolution [min⁻¹]

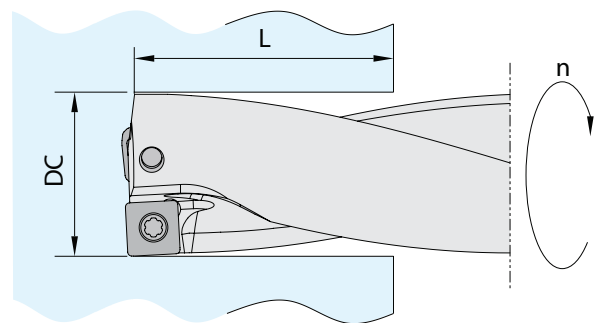

Technical information

Cutting time

$$T = \frac{60 \times L}{f \times n} = \frac{60 \times \pi \times DC \times L}{1,000 \times V_c \times f}$$

T : Cutting time [sec]

L : Drilling depth [mm]

f : Feed rate [mm/rev]

n : Spindle revolution [min⁻¹]

DC : Drill dia. [mm]

V_c : Cutting speed [m/min]

Tooling example 1: CNC automatic lathe (Gang type)

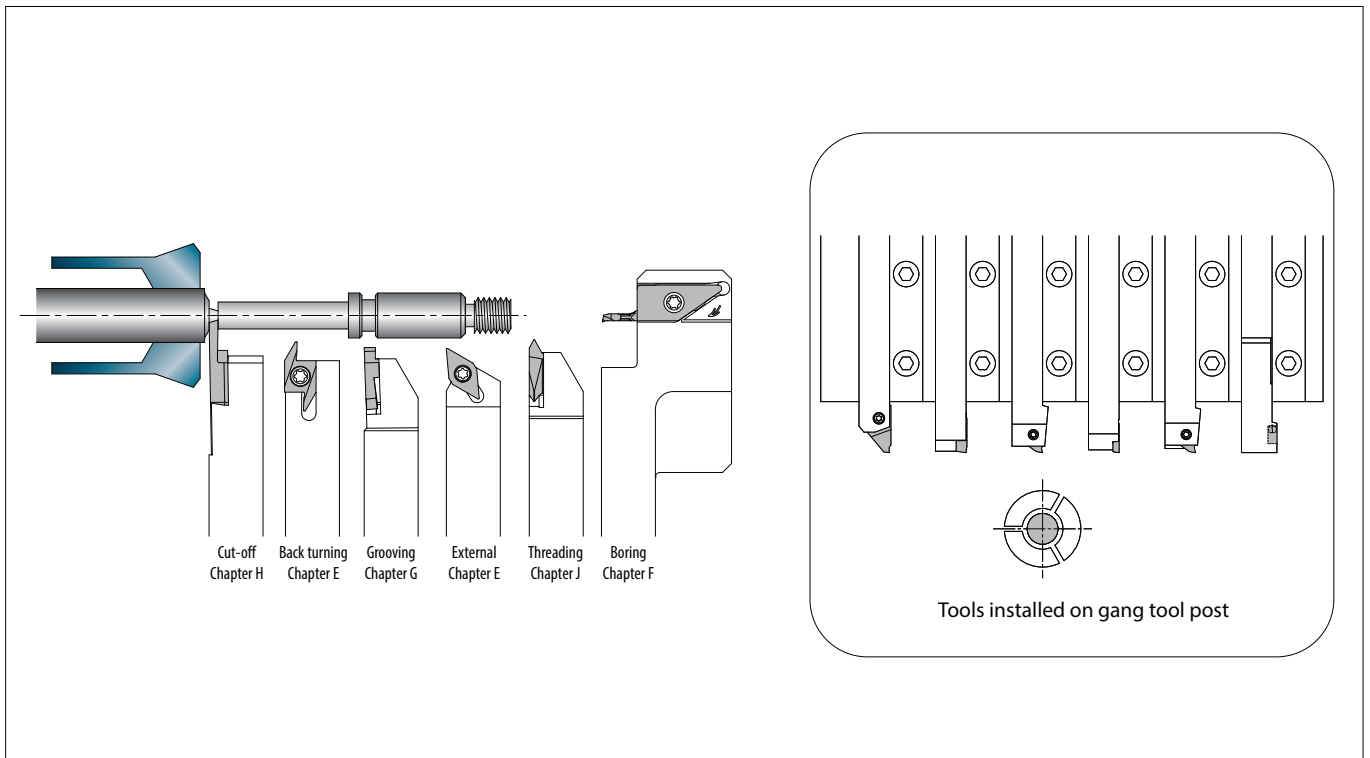

Tooling example 2: CNC automatic lathe (Gang type)

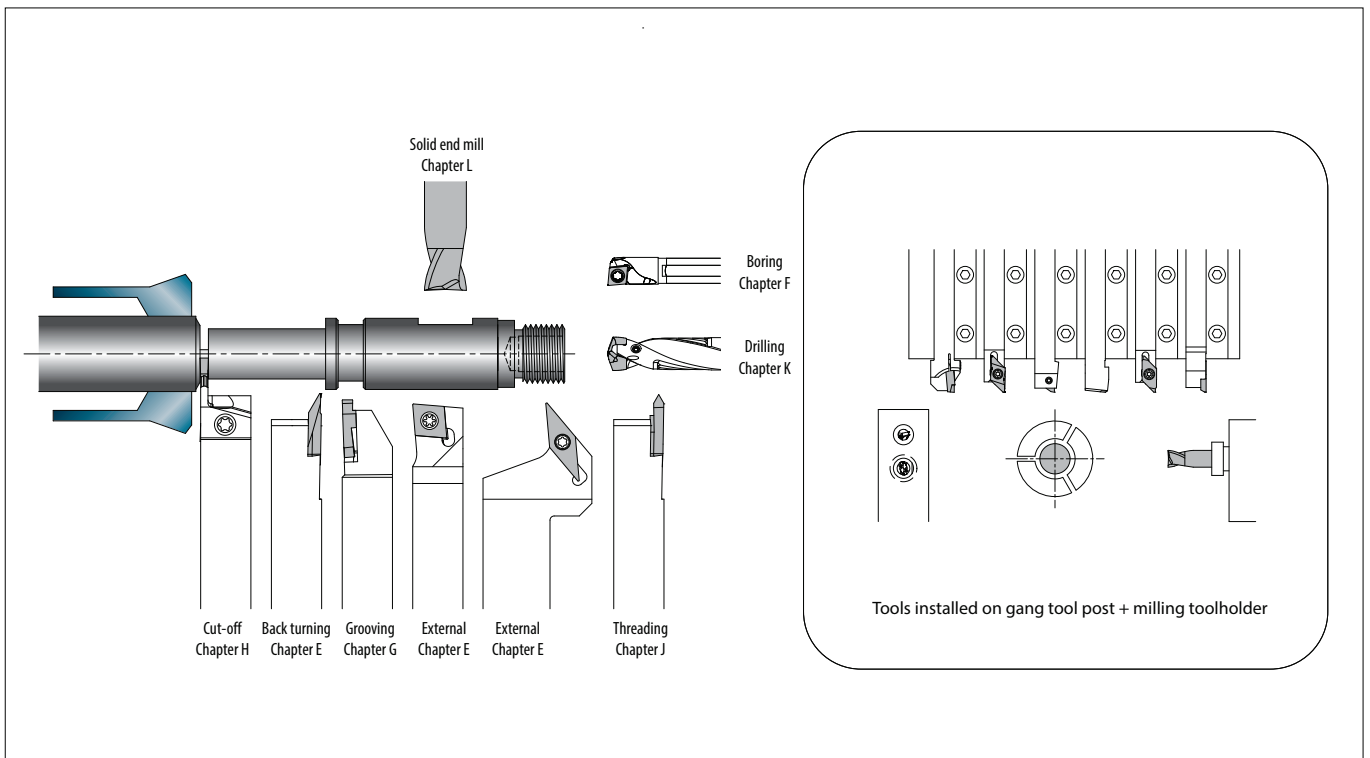

R



Technical information

Tooling example 3: CNC automatic lathe (Opposed gang type)

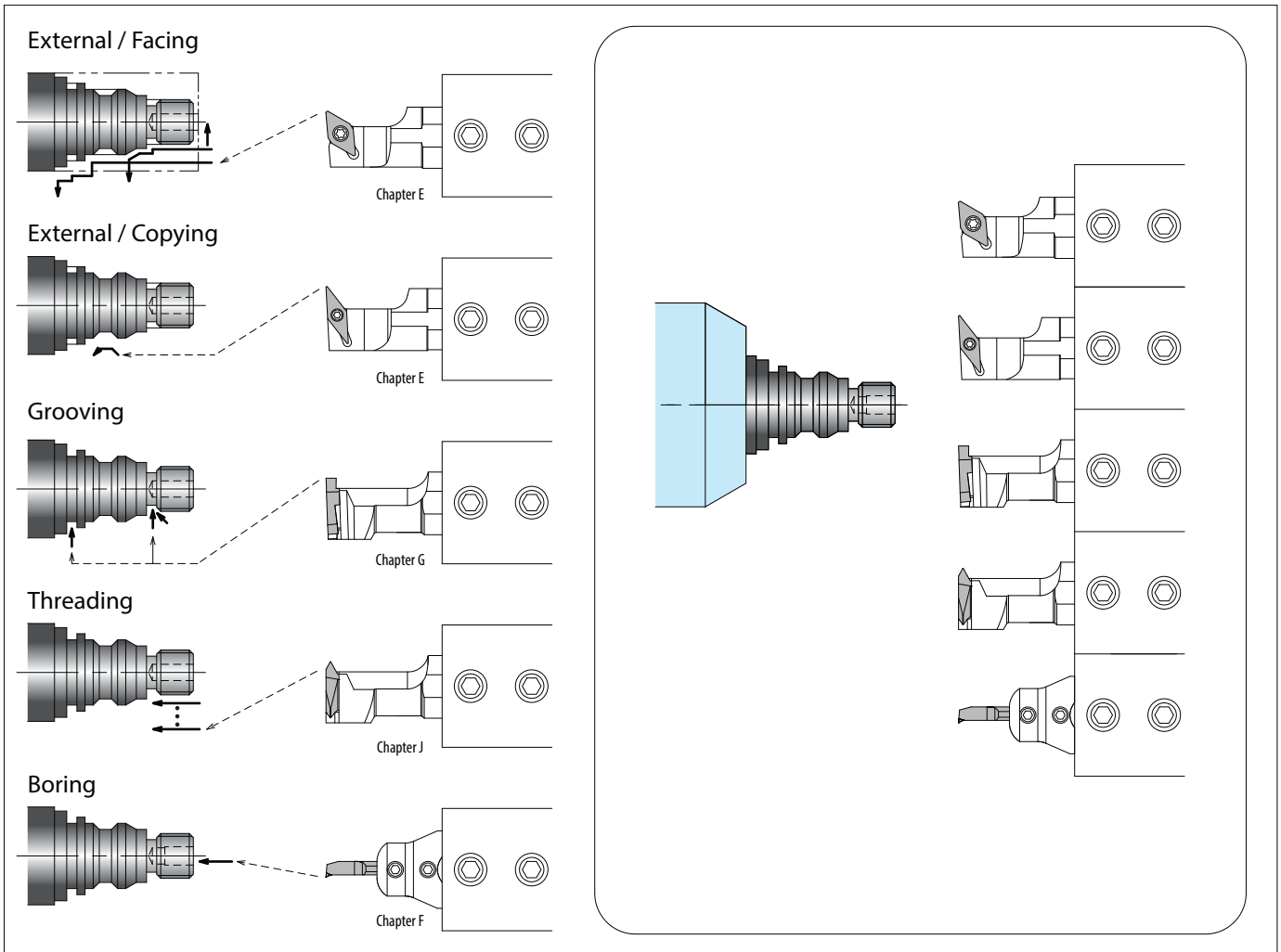

Tooling example 4: CNC automatic lathe (Turret type)

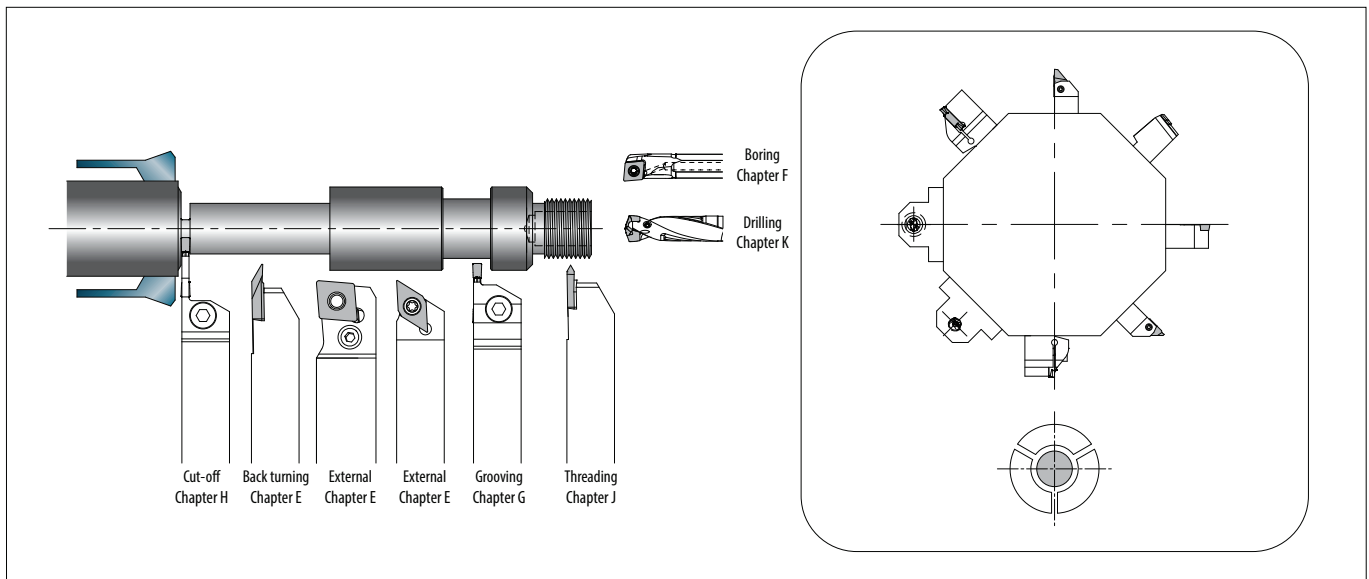

For Tooling Layout and Automatic Lathe List by Manufacturer, See Page **R46~R54**

R



Technical information

Citizen machinery (Cincom Products)

Model	Toolholder dimensions (Gang tool post)	Number of tools	Toolholder dimensions (Turret tool post)	Number of tools	Sleeve dia. (Horizontal/Opposed)	Max. cutting dia.	Remarks
A12/16	10 x 10 x 100	5			ø19.05/ø20	ø12/ø16	
A20	12(13) x 12(13) x 120 * Cut-off toolholder: □16mm	6			ø25.4	ø20	
A20 VII	12(13) x 12(13) x 120 * Cut-off toolholder: □16mm	6			ø25.4	ø20	
A32	16 x 16 x 150	6			ø25.4	ø32	
B12	10 x 10 x 100	5			ø19.05/ø20	ø12	
B12E/B16E	10 x 10 x 120(60)	5			ø19.05(ø20 ^Ø)	ø12/ø16	
B20	12(13) x 12(13) x 120	6			ø19.05/ø20	ø20	
BL12	10 x 10 x 60 ~ 120	5			ø20(ø19.05)	ø12	
BL20/25	12(13) x 12(13) x 120	4 ~ 7			ø20(ø19.05)	ø20/ø25	
C12/16	10 x 10 x 120	6			ø19.05	ø12/ø16	
C32	16 x 16 x 130	5			ø25.4	ø32	
D25	16 x 16 x 150 * Cut-off toolholder: □19mm				ø25.4	ø25	
F10			10 x 10 x 60	10	ø19.05	ø10	
F12			10 x 10 x 60	10	ø19.05	ø12	
F16			10 x 10 x 60	10	ø19.05	ø16	
F20			16(19) x 16(13) x 90	10	ø25.4	ø20	
F25			16(19) x 16(13) x 90	10	ø25.4	ø25	
FL25			16 x 16 x 90	12		ø25	
FL42			16 x 16 x 90	12		ø42	
G32			16(19) x 16(19) x 90	10	-	ø32	
K12/16	12(10) x 12(10) x 100	6(7)			ø19.05/ø20	ø12/ø16	
K12E/K16E	12 x 12 x 120	6			ø19.05/ø20	ø12/ø16	
L10	8 x 8 x 100 ~ 130	5			ø15.875	ø10	
L12	10 x 10 x 100	6			ø19.05	ø12	
L16	12(10) x 12(10) x 130	5			ø19.05	ø16	
L20,L20E	12 x 12 x 130 * Cut-off toolholder: □16mm	5			ø19.05	ø20	
L20X,L220	12(13,16) x 12(13,16) x 120 * Cut-off toolholder: □16mm	5 ~ 7			ø19.05	ø20	
L25	16 x 16 x 130	5			ø25.4	ø25	
L32	16 x 16 x 130	5			ø25.4	ø32	
M12	10 x 10 x 120	5	10 x 10 x 60	10 + α	ø19.05	ø12	
M16	10 x 10 x 120	5	10 x 10 x 60	10 + α	ø19.05	ø16	
M20	16 x 16 x 130	5	16 x 16 x 90	10 + α	ø25.4	ø20	
M32	16 x 16 x 130	5	16 x 16 x 90	10 + α	ø25.4	ø32	
MC20	13 x 13 x 120	2 + 2 + 2			ø19.05/ø20.0	ø20.0	
MSL12	10 x 10 x 120				-	ø12	
R04	8 x 8 x 120	5			ø15.875	ø4	
R07	8 x 8 x 120	5			ø15.875	ø7	
RL01	10(8) x 10(8) x 90				ø16(ø20)	ø10	
RL02	16 x 16 x 90				ø20	ø20	
RL21	10(12) x 10(12) x 90				ø19.05	ø35	

Manufacturers are in no particular order.

R



Technical information

Automatic lathe list by manufacturer

Citizen machinery (Miyano Products)

Model	Toolholder dimensions (Gang tool post)	Number of tools	Toolholder dimensions (Turret tool post)	Number of tools	Sleeve dia. (Horizontal/Opposed)	Number of tools	Max. cutting dia.	Remarks
ABX-51SY2			20 x 20 x 125(100)	24	ø25	48	ø51	
ABX-51SY2			20 x 20 x 125(100)	24	ø25	48	ø51	
ABX-51TH5			20 x 20 x 125(100)	36	ø25	72	ø51	
ABX-51THY2			20 x 20 x 125(100)	36	ø25	72	ø51	
ABX-64SY2			20 x 20 x 125(100)	24	ø25	48	ø64	
ABX-64SY2			20 x 20 x 125(100)	24	ø25	48	ø64	
ABX-64TH5			20 x 20 x 125(100)	36	ø25	72	ø64	
ABX-64THY2			20 x 20 x 125(100)	36	ø25	72	ø64	
BNA-34C			20 x 20 x 125(100)	8(16)	ø25	24	ø34	
BNA-34DHY			20 x 20 x 125(100)	14(22)	ø25	27	ø34	
BNA-34S			20 x 20 x 125(100)	8(16)	ø25	24	ø34	
BNA-42C/C2			20 x 20 x 125(100)	8(16)	ø25	24	ø42	
BNA-42DHY			20 x 20 x 125(100)	14(22)	ø25	27	ø42	
BNA-42DHY2			20 x 20 x 125(100)	14(22)	ø25	27	ø42	
BNA-42DHY3			20 x 20 x 125(100)	14(22)	ø25	27	ø42	
BNA-42GTY	20 x 20 x 125(100)	3	20 x 20 x 125(100)	8(16)	ø25	24(7)	ø42	
BNA-42MSY2			20 x 20 x 125(100)	8(16)	ø25	24	ø42	
BNA-42S/S2			20 x 20 x 125(100)	8(16)	ø25	24	ø42	
BNA-42C5/SY5			20 x 20 x 125(100)	12(24)	ø25	24	ø42	
BNC-42C7			20 x 20 x 125(100)	8(16)	ø25	24	ø42	
BND-51C2			20 x 20 x 125(100)	12	ø25	24	ø51	
BND-51S2			20 x 20 x 125(100)	12	ø25	24	ø51	
BND-51SY2			20 x 20 x 125(100)	12	ø25	24	ø51	
BNE-42S6			20 x 20 x 125(100)	24	ø25	48	ø42	
BNE-42SY6			20 x 20 x 125(100)	24	ø25	48	ø42	
BNE-51S6			20 x 20 x 125(100)	24	ø25	48	ø51	
BNE-51SY6			20 x 20 x 125(100)	24	ø25	48	ø51	
BNE-51MSY			20 x 20 x 125(100)	24	ø25	48	ø51	
BNE-51MY			20 x 20 x 125(100)	24	ø25	48	ø51	
BNE-65MY			20 x 20 x 125(100)	24	ø25	48	ø65	
BNJ-34S3/S5			20 x 20 x 125(100)	18	ø25	30	ø34	
BNJ-34SY3/SY5			20 x 20 x 125(100)	18	ø25	30	ø34	
BNJ-42S3/S5			20 x 20 x 125(100)	18	ø25	30	ø42	
BNJ-42S6			20 x 20 x 125(100)	20	ø25	40	ø42	
BNJ-42SY3/SY5			20 x 20 x 125(100)	18	ø25	30	ø42	
BNJ-42SY5			20 x 20 x 125(100)	18	ø25	30	ø42	
BNJ-42SY6			20 x 20 x 125(100)	20	ø25	40	ø42	
BNJ-51S3/S5			20 x 20 x 125(100)	18	ø25	30	ø51	
BNJ-51SY3/SY5			20 x 20 x 125(100)	18	ø25	30	ø51	
BNJ-51SY6			20 x 20 x 125(100)	20	ø25	40	ø51	
GN-3200	12(16) x 12(16) x 70 ~ 120	4 ~ 5			ø20		ø40	
GN-3200W	12(16) x 12(16) x 70 ~ 120	4 ~ 5			ø20		ø40	"Number of tools" is per turret.
GN-4200	12(16) x 12(16) x 70 ~ 120	6 ~ 7			ø20		ø40	
LX-06E2			20 x 20 x 125(100)	8	ø32	8		6 inch power chuck
LX-06E3			20 x 20 x 125(100)	8	ø32	8		6 inch power chuck
LX-08C			25 x 25 x 150	10	ø40	10		8 inch power chuck
LX-08E2			25 x 25 x 150	8	ø40	8		8 inch power chuck
LX-08E3			25 x 25 x 150	8	ø40	8		8 inch power chuck
LX-08R			20 x 20 x 125(100)	10	ø25	20		8 inch power chuck
LZ-01R2			20 x 20 x 125(100)	12	ø25	24		6 inch power chuck
LZ-01RY2			20 x 20 x 125(100)	12	ø25	24		6 inch power chuck
LZ-02R2			20 x 20 x 125(100)	10	ø25	20		8 inch power chuck
LZ-02RY2			20 x 20 x 125(100)	10	ø25	20		8 inch power chuck
RL01III	10 x 10 x 70 ~ 120	2 ~ 3			ø16		ø10	
RL01V	10 x 10 x 70 ~ 120	2 ~ 3			ø16		ø10	
RL03	12(16) x 12(16) x 70 ~ 120	4 ~ 5			ø20		ø40	
VCO3	12(16) x 12(16) x 70 ~ 120	4 ~ 5			ø20		ø40	

* Number of tools shown in parentheses is the maximum number of toolholder mountable including ø25 sleeves.

Manufacturers are in no particular order.

R



Technical information

Star Micronics

Model	Toolholder dimensions (Gang tool post)	Number of tools	Toolholder dimensions (Turret tool post)	Number of tools	Sleeve dia. (Front/Rear)	Number of tools	Max. cutting dia.	Remarks
SB-16 (A/C/D/E)	12 x 12 x 95 ~ 130	5			ø22/ø22	4/4	ø16	Only D/E for rear-end sleeves
	12(10) x 12(10) x 95 ~ 130	6			ø22/ø22	4/4	ø16	
SB-12II (C/E)	12 x 12 x 95 ~ 130	6			ø22/ø22	4/4	ø13	Only E for rear-end sleeves
SB-16II (C/E)	12(10) x 12(10) x 95 ~ 130	6			ø22/ø22	4/4	ø16	
SB-20 A/C/E	12 x 12 x 95 ~ 130	6			ø22/ø22	4/4	ø20	
SB-12R typeG	12 x 12 x 95 ~ 130	6			ø22/ø22	4/4	ø13	
	10 x 10 x 95 ~ 130	7			ø22/ø22	4/4		
SB-16III	12 x 12 x 95 ~ 130	5			ø22/ø22	4/4	ø16	
	10 x 10 x 95 ~ 130	6			ø22/ø22	4/4		
SB-16R/20R typeN	12 x 12 x 95 ~ 130	6			ø22/ø22	4/4	ø16/ø23	
	10 x 10 x 95 ~ 130	7			ø22/ø22	4/4		
SB-16R/20R typeG	12 x 12 x 95 ~ 130	6			ø22/ø22	4/4	ø16/ø23	
	10 x 10 x 95 ~ 130	7			ø22/ø22	4/4		
SB-16R/20R typeGB	12 x 12 x 95 ~ 130	6			ø22/ø22	4/4	ø16/ø23	
	10 x 10 x 95 ~ 130	7			ø22/ø22	4/4		
SC20	12 x 12 x 95 ~ 130	5			ø22/-	4/-	ø20	
	10 x 10 x 95 ~ 130	6			ø22/-	4/-		
SG-42			16 x 16 x 84 ~ 88(71 ~ 82) 20 x 20 x 84 ~ 88		ø22+ø32/-		ø42	
SL-7/10	10 x 10 x 95 ~ 115	6			ø16+ø22/ø16+ø22	4~6/6	ø10	
	8 x 8 x 68 ~ 115	6						
SR-10J	8 x 8 x 67 ~ 110 (Spacer is needed)	6			ø16/ø16+ø22	4/4	ø10	
SR-20RII	12 x 12 x 100 ~ 135	6			ø22/ø22	4/4	ø23	Toolpost for 2 toolholders (deep boring) on the front side
SR-20RIII	12 x 12 x 95 ~ 135	6			ø22/ø22	6/4	ø23	
SR-20J typeC	12 x 12 x 95 ~ 135	6			ø22/ø22	6/4	ø23	
SR-20J typeN	12 x 12 x 95 ~ 135	6			ø22/ø22	6/4	ø23	
SR-20III typeA	12 x 12 x 100 ~ 135	6			ø22/ø22	7/4	ø23	
SR-20III typeB	12 x 12 x 100 ~ 135	6			ø22/ø22	7/8	ø23	
SR-20IV typeA	12 x 12 x 100 ~ 130	7			ø22/ø22	6/8	ø23	
SR-20IV typeB	12 x 12 x 100 ~ 130	7			ø22/ø22	6/8	ø23	
SR-25J/32J	16 x 16 x 95 ~ 155	6			ø22+ø32/ø22	4/4	ø32	
SR-32III typeA	16 x 16 x 95 ~ 165	6			ø22+ø32/ø22	5/6	ø34	
SR-32III typeB	16 x 16 x 95 ~ 165	6			ø22+ø32/ø22	5/8	ø34	
SB-32III typeA	16 x 16 x 95 ~ 165	6			ø22+ø32/ø22	5/6	ø34	
	16 x 16 x 95 ~ 135	4			ø22+ø32/ø22	5/8	ø38	
SR-38 typeA	16 x 16 x 100	2						ø22+ø32/ø22
	20 x 20 x 105 ~ 135 (Cut-off)	1						
SR-38 typeB	16 x 16 x 95 ~ 135	4			ø22+ø32/ø22	5/8	ø38	
	16 x 16 x 100	2						
SR-38J	20 x 20 x 105 ~ 135 (Cut-off)	1			ø22+ø32/ø22	5/4	ø38	
	16 x 16 x 95 ~ 135 (Optional)	3						
ST-20			12 x 12 x 73 ~ 79		ø22+ø32/ø22+ø32		ø20	
			12 x 12 x 65 ~ 73 (Cut-off)					
			16 x 16 x 64 ~ 73					
			16 x 16 x 65 ~ 73 (Cut-off)					
ST-38			16 x 16 x 83 ~ 88		ø22+ø32/ø22+ø32		ø38	
			16 x 16 x 71 ~ 82					
			16 x 16 x 84 ~ 88 (Cut-off)					
			20 x 20 x 84 ~ 88					
			20 x 20 x 84 ~ 88 (Cut-off)					
SV-12/20	12 x 12 x 95 ~ 135	5	12 x 12 x 70 ~ 78		ø22+ø32/-		ø12/ø20	
	16 x 16 x 95 ~ 135	4	16 x 16 x 65 ~ 70					
SV-20R	12 x 12 x 95 ~ 135	7	12 x 12 x 70 ~ 78		ø22+ø32/ø22	-/8	ø23	
	16 x 16 x 95 ~ 135	6	16 x 16 x 65 ~ 70					
SV-32	16 x 16 x 95 ~ 135	4	16 x 16 x 60 ~ 78(80 ~ 88)		ø22+ø32/-		ø32	
	16 x 16 x 105 ~ 135	4	16 x 16 x 84 ~ 88					
SV-38R	20 x 20 x 115 ~ 135 (Cut-off)	1	16 x 16 x 71 ~ 82		ø22+ø32/ø34	-/8	ø38	
			20 x 20 x 84 ~ 88					
SW-12RII	10 x 10 x 95 ~ 115	7			ø16/ø22	4/8	ø13	
SW-20	12 x 12 x 80 ~ 150	6			ø22/ø22	4/8	ø23	
	16 x 16 x 80 ~ 144							
SX-38 typeA	16 x 16 x 95 ~ 135	4	16 x 16 x 84 ~ 88		ø22+ø32/ø34	-/8	ø38	
	20 x 20 x 105 ~ 135 (Cut-off)	1	16 x 16 x 71 ~ 82					
			20 x 20 x 84 ~ 88					
SX-38 typeB	16 x 16 x 95 ~ 135	4	16 x 16 x 84 ~ 88		ø22+ø32/ø34	-/8	ø38	
	20 x 20 x 105 ~ 135 (Cut-off)	1	16 x 16 x 71 ~ 82					
			20 x 20 x 84 ~ 88					

Manufacturers are in no particular order.

R



Technical information

Automatic lathe list by manufacturer

Eguro

Model	Toolholder dimensions (Gang tool post)	Number of tools	Toolholder dimensions (Turret tool post)	Number of tools	Sleeve dia. (Horizontal/Opposed)	Number of tools	Max. cutting dia.	Remarks
NUCBOY-8EX	12 x 12	6			ø20 or ø25 or ø30	5	ø20	
NUCLET-10EX/EL	16 x 16	6			ø20 or ø25 or ø30	5	ø25.5	
NUCPAL-10EX/EL	16 x 16	10			ø20 or ø25 or ø30	8	ø25.5	
NUCLET-10vv	16 x 16	6			ø20 or ø25 or ø30	5	ø25.5	
NUCBOY-8LL	12 x 12	2			ø20 or ø25 or ø30	2	ø20	
NUCLET-10LL	16 x 16	2			ø20 or ø25 or ø30	2	ø25.5	
NUCROBO-8EX	12 x 12	6			ø20 or ø25 or ø30	5	ø20	
NUCROBO-101	16 x 16	6			ø20 or ø25 or ø30	5	ø25.5	
NUCROBO-202	16 x 16	10			ø20 or ø25 or ø30	8	ø25.5	
SANAX-6	12 x 12	10			ø12 or ø16/ø30	3~6/2	ø15	
SANAX-10	16 x 16	10			ø20 or ø30/ø30	5~8/3	ø25.5	
SANATURN-6	12 x 12	5			ø16/ø30	3~5/2	ø15	
SANATURN-10	16 x 16	6			ø20/ø30	7/3	ø25.5	
EBN-10EX	12 x 12	5			ø20 or ø25 or ø30	4	ø25.5	
GL-120	12 x 12	4			-		ø20	
EB-6	8 x 8	2			-		ø15	
EB-8	10 x 10	2			-		ø20	
EB-10	10 x 10	2			-		ø25.5	

Manufacturers are in no particular order.

R



Technical information

Automatic lathe list by manufacturer

Tsugami

Model	Toolholder dimensions (Gang tool post)	Number of tools	Toolholder dimensions (Turret tool post)	Number of tools	Sleeve dia. (Horizontal/Opposed)	Number of tools	Max. cutting dia.	Remarks
B073-III	8 x 8 x 85	9	-	-	ø20/-	4/-	ø7	
B074/075-III	8 x 8 x 85	9	-	-	ø20/ø20	4/4(8)	ø7	
B0123-III	12 x 12 x 85	9	-	-	ø20/-	4/-	ø12	
B0124/125/126-III	12 x 12 x 85	9	-	-	ø20/ø20	4/4(8)	ø12	
B0128W	12 x 12 x 85	9	-	-	ø20/ø20	4/8	ø12	
B0203-III	12 x 12 x 85	9	-	-	ø20/-	4/-	ø20	
B0204/205/206-III	12 x 12 x 85	9	-	-	ø20/ø20	4/4(8)	ø20	
B0208W	12 x 12 x 85	9	-	-	ø20/ø20	4/8	ø20	
BM163-III	12 x 12 x 85	9	-	-	ø20/-	4/-	ø16	
BM164/165-III	12 x 12 x 85	9	-	-	ø20/ø20	4/4(8)	ø16	
BW127J-I / II	12 x 12 x 85	7	-	-	ø20/ø20	3/9	ø20	
BW128J-I / II	12 x 12 x 85	7	-	-	ø20/ø20	3/9	ø20	
BW128ZJ-I / II	12 x 12 x 85	7	-	-	ø20/ø20	3/9	ø20	
BW129ZJ-I / II	12 x 12 x 85	7	-	-	ø20/ø20	3/9	ø20	
BW207J-I / II	12 x 12 x 85/16 x 16 x 85	5/2	-	-	ø20/ø20	3/9	ø20	
BW208J-I / II	12 x 12 x 85/16 x 16 x 85	5/2	-	-	ø20/ø20	3/9	ø20	
BW208ZJ-I / II	12 x 12 x 85/16 x 16 x 85	5/2	-	-	ø20/ø20	3/9	ø20	
BW209ZJ-I / II	12 x 12 x 85/16 x 16 x 85	5/2	-	-	ø20/ø20	3/9	ø20	
B0265/265B/266-II	16 x 16 x 100	12	-	-	ø25/ø25	5/4	ø26	
B0325/325B/326-II	16 x 16 x 100	12	-	-	ø25/ø25	5/4	ø32	
B0385/385L	20 x 20 x 125	8	-	-	ø32/ø32	3/5	ø38	
B0265/266-III B0266/326-III	16 x 16 x 100	12	-	-	ø25/ø25	5/4	ø26/ø32	
B0265/325V-III B0266/326V-III	16 x 16 x 100	6	-	-	ø25/ø25	5/4	ø26/ø32	
B0385/6 (L)-III	16 x 16 x 100/20 x 20 x 125	11/1	-	-	ø32,ø25/ø32	3-2/5	ø38	
B0385/6 (L)V-III	16 x 16 x 100/20 x 20 x 125	5/1	-	-	ø32,ø25/ø32	3-2/5	ø38	
B038T	-	-	20 x 20 x 125	St.8	ø32/ø25	-	ø38	
BH20/BH20Z	12 x 12 x 85	4	12 x 12 x 85	St.12	ø25/ø32	-	ø20	
BH38	16 x 16 x 125	5	20 x 20 x 125	St.12	ø25/ø32	-	ø38.1	
C150/CH154	12 x 12 x 60 ~ 100	4 ~ 6	-	-	-	-	ø80	
C180	12 x 12 x 60 ~ 100	4 ~ 6	-	-	-	-	ø120	
C220/220T	12 x 12 x 60 ~ 100	6 ~ 8	-	-	-	-	ø120	
C300-IV	16 x 16 x 100 ~ 130	6 ~ 10	-	-	-	-	ø165	
C300H	16 x 16 x 100 ~ 130	6 ~ 10	-	-	-	-	ø165	
P013	8 x 8 x 100 ~ 120	6	-	-	ø16/-	3/-	ø1	
P014	8 x 8 x 100 ~ 120	6	-	-	ø16/ø16	3/3	ø1	
P033	8 x 8 x 100 ~ 120	6	-	-	ø16/-	3/-	ø3	
P034	8 x 8 x 100 ~ 120	6	-	-	ø16/ø16	3/3	ø3	
S205/206	12 x 12 x 100	8	-	-	ø22/ø20	5/4	ø20	
S205/206-II	12 x 12 x 100	9	-	-	ø25/ø25	7/4(8)	ø20	
SS207/SS207-5AX	12 x 12 x 100	8	-	-	ø22/ø20	4/4	ø20	
SS26	16 x 16 x 100	7	-	-	ø22/ø20	5/3	ø26	
SS32/32L	16 x 16 x 100	7	-	-	ø22/ø20	5/3	ø32	
SS267/SS267-5AX	16 x 16 x 100	8	-	-	ø25/ø25	4/4	ø26	
SS327/SS327-5AX	16 x 16 x 100	8	-	-	ø25/ø25	4/4	ø32	
BW269ZJ	16 x 16 x 100	7	-	-	ø25/ø25	5/(8)	ø26	
BW329ZJ	16 x 16 x 100	7	-	-	ø25/ø25	5/(8)	ø32	
MB25	-	-	20 x 20 x 90	2 x St.8	ø20/ø32	5/4	ø25	
M06JC-II	-	-	20 x 20 x 125	St.8	ø25	-	ø220/ø42	
M06J-II	-	-	25 x 25 x 150	St.8	ø32/ø40	-	ø260/ø51	
M08J-II	-	-	25 x 25 x 150	St.8	ø32/ø40	-	ø280/ø65	
M08JL5-II	-	-	25 x 25 x 150	St.8	ø32/ø40	-	ø280/ø65	
M08JL8-II	-	-	25 x 25 x 150	St.8	ø32/ø40	-	ø280/ø65	
M06D-II	-	-	25 x 25 x 150	St.12	ø40	-	ø260/ø51	
M08D-II	-	-	25 x 25 x 150	St.12	ø40	-	ø280/ø65	
M06DY-II	-	-	25 x 25 x 150	St.12	ø40	-	ø260/ø51	
M08DY-II	-	-	25 x 25 x 150	St.12	ø40	-	ø280/ø65	
M06SJ-II	-	-	25 x 25 x 150	St.12	ø40	-	ø260/ø51	
M08SJ-II	-	-	25 x 25 x 150	St.12	ø40	-	ø280/ø65	
M06SD-II	-	-	25 x 25 x 150	St.12	ø40	-	ø260/ø51	
M08SD-II	-	-	25 x 25 x 150	St.12	ø40	-	ø280/ø65	
M06SY-II	-	-	25 x 25 x 150	St.12	ø40	-	ø260/ø51	
M08SY-II	-	-	25 x 25 x 150	St.12	ø40	-	ø280/ø65	
TMU1	20 x 20 x 100 ~ 125	1	20 x 20 x 125	St.16	ø32/ø32	-	ø38	
TMB2	20 x 20 x 100 ~ 125	1	20 x 20 x 125	St.16	ø32/ø32	-	ø51	
TMA8F	20 x 20 x 100 ~ 125	1	-	-	ø32/ø32	-	ø65	
TMA8J	20 x 20 x 100 ~ 125	1	-	-	ø32/ø32	-	ø65	
TMA8H	20 x 20 x 100 ~ 125	1	-	-	ø32/ø32	-	ø65	

Manufacturers are in no particular order.

R



Technical information

Automatic lathe list by manufacturer

Nomura DS

Model	Toolholder dimensions (Gang tool post)	Number of tools	Toolholder dimensions (Turret tool post)	Number of tools	Sleeve dia. (Horizontal/Opposed)	Number of tools	Max. cutting dia.	Remarks
NN-10C	10 x 10 x 130	6			ø17		ø10	
NN-10CS	10 x 10 x 130	5			ø17	4	ø10	
NN-10SII	10 x 10 x 130	5			ø23		ø10	
NN-10T	10 x 10 x 130	7			ø23		ø10	
NN-10SB5	10 x 10 x 130	5			ø23		ø13	
NN-10EX2	10 x 10 x 120	6			ø16	4	ø10	
NN-10EX2	10 x 10 x 80	7			ø16	4	ø10	
NN-16SB5	10 x 10 x 130	5			ø23		ø16	
NN-16SB6 Type1	12.7 x 12.7 x 130*	7			ø17(ø22)	4	ø16	
NN-16SB6 Type2	12.7 x 12.7 x 130*	5			ø17(ø22)	4	ø16	
NN-16SB6 Type2.5	12.7 x 12.7 x 130*	6			ø17(ø22)	5	ø16	
NN-16SB6 Type3	12.7 x 12.7 x 130*	5			ø17(ø22)	4	ø16	
NN-16SB7	12.7 x 12.7 x 130*	5			ø16	4	ø16	
NN-16SB7-M8	12.7 x 12.7 x 130*	5			ø16	4	ø16	
NN-20SB	12.7 x 12.7 x 130*	5			ø16	3	ø20	
					ø22	2	ø20	
NN-16HIII	12 x 12 x 130	6			ø23		ø16	
NN-20HIII	12 x 12 x 130	6			ø23		ø20	
NN-16UIII	12 x 12 x 130	5			ø23		ø16	
NN-20UIII	12 x 12 x 130	5			ø23		ø20	
NN-20CS	12.7 x 12.7 x 130	5(6)			ø22	4	ø20(ø25)	
NN-20U5	12.7 x 12.7 x 150	5(6)			ø22	4	ø20(ø25)	
NN-32U5	12.7 x 12.7 x 150	3(4)			ø32	1	ø32	
	16 x 16 x 130	2			ø22	3		
NN-16UB5	12 x 12 x 130	5			ø23		ø16	
NN-20UB5	12 x 12 x 130	5			ø23		ø20	
NN-20UB7	12 x 12 x 130	6			ø23		ø20	
NN-20UB8	12.7 x 12.7 x 150*	5(6)			ø22	4	ø20(ø25)	
NN-20UB10	12.7 x 12.7 x 150*	5(6)			ø22	4	ø20(ø25)	
NN-32UB8	12.7 x 12.7 x 150*	3(4)			ø32	1	ø32	
	16 x 16 x 130	2			ø22	3		
NN-32UB10W	12.7 x 12.7 x 150*	3(4)			ø32	1	ø32	
	16 x 16 x 130	2			ø22	3		
NN-20YB	12 x 12 x 130	6			ø23		ø20	
NN-25YB/32YB	16 x 16 x 130	5			ø23/ø32		ø25/ø32	
NN-32YB5	16 x 16 x 130	5			ø22/ø32	4	ø32	
NN-32YB5 XB	16 x 16 x 130	6			ø22/ø32	5/1	ø32	
NN-16J	12.7 x 12.7 x 130*	6			ø23		ø16	
NN-20J	12.7 x 12.7 x 130*	6			ø23		ø20	
NN-20J2	12.7 x 12.7 x 130*	6			ø22	4	ø20	
NN-20J5	12.7 x 12.7 x 130*	6			ø22	4	ø20	
NN-20J5 XB	12.7 x 12.7 x 130*	5			ø22	4	ø20	
NN-32J	16 x 16 x 130	6			ø25	2	ø32	
					ø32	3		
NN-32DB	16 x 16 x 130	8			ø22	4	ø32	
					ø32	1		
NN-38KM	16 x 16 x 130	5			ø25	3	ø38	
					ø32	2		

* 12 x 12 toolholder mountable

Manufacturers are in no particular order.

R



Technical information

List of instruments and applicable small parts machining and toolholders

Models of major machine tool manufacturers				Applicable toolholders
Manufacturer	Model (Automatic lathe)	Toolholder size	Total length of attached toolholder (Max.)	
Citizen Machinery	A12,A16,B12,L12,RL01,RL21	10 x 10	100	... 1010F-..
	K12,K16	12 x 12		... 1212F-..
	RL02	16 x 16		... 1616H-..
	B12E,B16E,BL12,C12,C16,M12,M16 MSL12	10 x 10	120	... 1010JX-..
	A20,A20VII,B20,BL20,BL25,K12E,K16E L20X,L220,MC20	12 x 12		... 1212JX-..
	L16,L20,L20E	12 x 12	130	... 1212JX-..
	C32,L25,L32,M20,M32	16 x 16		150
	A32,D25			
Star Micronics	SW-12RII	10 x 10	120	... 1010JX-..
	SB-16A,SB-16C,SB-16D,SB-12II,SB-16II SB-12R/16R/20R,SR-20IV,SB-20A/C/E,SC20	12 x 12	130	... 1212JX-..
	SR-20RII,SR-20III,SV-12,SV-20,SR-20J	12 x 12	135	... 1212JX-..
	SV-20R,SV-32,SV-38R,SR-38J,SX-38	16 x 16		... 1616JX-..
	SR-25J,SR-32J,SW-20	16 x 16	150	... 1616JX-..
Tsumami	B0,BH20,BM,BW2	12 x 12	85	... 1212F-..
	C150,C180,C220,S205,S206,SS207	12 x 12	100	... 1212F-..
	BH38,B0265,B0266,B0325,B0326 SS26,SS32/32L,SS267,SS327	16 x 16		... 1616H-..
Nomura DS	NN-10C,NN-10CS,NN-10EX2,NN-10SII NN-10SB5,NN-10T,NN-16SB5	10 x 10	130	... 1010JX-..
	NN-16HIII,NN-16UB5,NN-16UIII NN-20HIII,NN-20UIII,NN-20UB5,NN-20YB	12 x 12		... 1212JX-..
	NN-25YB,NN-32YB5,NN-32J,NN-38KM	16 x 16		... 1616JX-..

Manufacturers are in no particular order.

R



Technical information

Parts compatibility of lever lock toolholders

- 1) For better usability of lever lock toolholders, some levers, lock screws and shims are modified.
- 2) It is highly recommended to use only new parts. However, they are compatible with conventional parts and can be used together with them.
- 3) It is possible to use new parts only with a toolholder which has been in use.
- 4) When purchasing replacements, order them stating the new numbers.
- 5) Some of the shims remain unmodified.

Classification	Toolholder description			Spare parts					
				Lever		Lock screw		Shim	
				New No.	Conventional	New No.	Conventional	New No.	Conventional
External turning toolholders	PCLN [®] /L-09	LL-1N	LL-1	LS-1N	LS-1	LC-32N	LC-32	
	-12	LL-2N	LL-2	LS-2N	LS-2	LC-42N	LC-42	
	-16	LL-5N	LL-5	LS-4N	LS-4	LC-53N	LC-53	
	PDJN [®] /L-11	LL-1DN	LL-1D	LS-1N	LS-1	LD-32N	LD-32	
	-15	LL-3N	LL-3	LS-2N	LS-2	LD-42		
	PSBN [®] /L-09	LL-1N	LL-1	LS-1N	LS-1	LS-32		
	-12	LL-2N	LL-2	LS-2N	LS-2	LS-42		
	PSKN [®] /L-09	LL-1N	LL-1	LS-1N	LS-1	LS-32		
	-12	LL-2N	LL-2	LS-2N	LS-2	LS-42		
	PSSN [®] /L-09	LL-1N	LL-1	LS-1N	LS-1	LS-32		
	-12	LL-2N	LL-2	LS-2N	LS-2	LS-42		
	PSDNN-09	LL-1N	LL-1	LS-1N	LS-1	LS-32		
	-12	LL-2N	LL-2	LS-2N	LS-2	LS-42		
	PTGN [®] /L	1212F-11	LL-03N	LL-03	LS-03N	LS-03	-		
	-11	LL-03TN	LL-03T	LS-03SN	LS-03S	-		
	-16	LL-1N	LL-1	LS-1N	LS-1	LT-32N	LT-32	
	-22	LL-2N	LL-2	LS-2N	LS-2	LT-42N	LT-42	
	PTFN [®] /L	1212F-11	LL-03N	LL-03	LS-03N	LS-03	-		
	-11	LL-03TN	LL-03T	LS-03SN	LS-03S	-		
	-16	LL-1N	LL-1	LS-1N	LS-1	LT-32N	LT-32	
	-22	LL-2N	LL-2	LS-2N	LS-2	LT-42N	LT-42	
	PRGC [®] /L-12	LL-1CN	LL-1C	LS-1N	LS-1	LR-12C		
	PRXC [®] /L-12							
	PRGN [®] /L-09	LL-1N	LL-1	LS-1N	LS-1	LR-80		
....-12		LL-2N	LL-2	LS-2N	LS-2	LR-81			
PWLN [®] /L-06	LL-1N	LL-1	LS-1N	LS-1	LW-32N	LW-32		
-08	LL-2N	LL-2	LS-2N	LS-2	LW-42N	LW-42		
Boring bars	<input type="checkbox"/> 16M-	PCLN [®] /L	09-20	LL-03SN	LL-03S	LS-03SN	LS-03S	-	
	<input type="checkbox"/> 20Q-		09-27	LL-1N	LL-1	LS-1SN	LS-1S	LC-32N	LC-32
	<input type="checkbox"/> 25R-		09-32						
-	12-..	LL-2N	LL-2	LS-2N	LS-2	LC-42N [®] /L	LC-42 [®] /L	
-	PDJN [®] /L	11-..	LL-1DN	LL-1D	LS-1SN	LS-1S	LD-32N	LD-32
-	PTUN [®] /L	11-..	LL-03TN	LL-03T	LS-03SN	LS-03S	-	
	S25R-	PTUN [®] /L	16-30	LL-03SN	LL-03S	LS-03SN	LS-03S	-	
	S32S-		16-40	LL-1N	LL-1	LS-1N	LS-1	LT-32N	LT-32
	S40T-		16-50						
	<input type="checkbox"/> 16M-	PWLN [®] /L	06-20	LL-03SN	LL-03S	LS-03SN	LS-03S	-	
<input type="checkbox"/> 20Q-	06-27		LL-1N	LL-1	LS-1SN	LS-1S	LW-32N	LW-32	
<input type="checkbox"/> 25R-	06-32								
....-	PWLN [®] /L	08-..	LL-2N	LL-2	LS-2N	LS-2	LW-42N [®] /L	LW-42 [®] /L	
Turning mill	T63H-	PCLN [®] /L	-DX12	LL-2N	LL-2	LS-2N	LS-2	LC-42N	LC-42
	T63H-	PCMNN	-□12						
	T63H-	PDJN [®] /L	-DX15	LL-3N	LL-3	LS-2N	LS-2	LD-42	
	T63H-	PDNNN	-□15						
	T63H-	PTGN [®] /L	-DX16	LL-1N	LL-1	LS-1N	LS-1	LT-32N	LT-32
	T63H-	PWLN [®] /L	-DX08	LL-2N	LL-2	LS-2N	LS-2	LW-42N	LW-42



Technical information

T



Descriptions of the products in this book are listed in alphanumeric order

T2-T23

Description	Page	Category
0		
061R ○○○○	J19	Threading
081R ○○○○	J19	Threading

1		
111 ⁹ /L... ○○○○S-○○	J26	Threading
111R A○○	J19	Threading
111R ○○BSPT	J13	Threading
111R ○○BSPT-TF	J13	Threading
111R ○○BSPT-TQ	J13	Threading
111R ○○○ISO	J7	Threading
111R ○○○ISO-TF	J7	Threading
111R ○○○ISO-TQ	J7	Threading
111R ○○○ISO	J7	Threading
111R ○○○○○	J19	Threading
16E ⁹ /L... ○○○○H-○○	J22	Threading
16E ⁹ /L... ○○○○JX-○○F	J22	Threading
16E ⁹ /L... ○○○○K-○○	J22	Threading
16E ⁹ /L... ○○○○M-○○	J22	Threading
16ER ○○ONPT	J14	Threading
16ER ○○BSPT	J12	Threading
16ER ○○BSPT-TF	J12	Threading
16ER ○○BSPT-TQ	J12	Threading
16ER ○○ONPT	J14	Threading
16ER ○○UN	J8	Threading
16ER ○○UN-TF	J8	Threading
16ER ○○UN-TQ	J8	Threading
16ER ○○○ISO	J6	Threading
16ER ○○○ISO-TF	J6	Threading
16ER ○○○ISO-TQ	J6	Threading
16ER ○○○ISO	J6	Threading
16ER ○○○TR	J20	Threading
16i ⁹ /L... ○○○○S-○○	J26, J27	Threading
161R AG○○	J19	Threading
161R A○○	J19	Threading
161R G○○	J19	Threading
161R ○○ONPT	J15	Threading
161R ○○BSPT	J13	Threading
161R ○○BSPT-TF	J13	Threading
161R ○○BSPT-TQ	J13	Threading
161R ○○ONPT	J15	Threading
161R ○○UN	J9	Threading
161R ○○UN-TF	J9	Threading
161R ○○UN-TQ	J9	Threading
161R ○○○ISO	J7	Threading
161R ○○○ISO-TF	J7	Threading
161R ○○○ISO-TQ	J7	Threading
161R ○○○ISO	J7	Threading
161R ○○○TR	J21	Threading
161R ○○○○	J19	Threading

2		
22ER N○○	J18	Threading
22ER ○○UN	J8	Threading
22ER ○○○ISO	J6	Threading
22ER ○○○TR	J20	Threading
221R N○○	J19	Threading
221R ○○UN	J9	Threading
221R ○○○ISO	J7	Threading
221R ○○○TR	J21	Threading

A		
A08X- SCLC ⁹ /L○○-○○AE	F60	Boring

Description	Page	Category
A08X- STLC ⁹ /L○○-○○AE	F88	Boring
A08X- STLP ⁹ /L○○-○○AE	F80	Boring
A08X- SWUB ⁹ /L○○-○○AE	F100	Boring
A10L- SCLC ⁹ /L○○-○○AE	F60	Boring
A10L- SCLP ⁹ /L○○-○○AE	F64	Boring
A10L- SDQC ⁹ /L○○-○○AE	F70	Boring
A10L- SDUC ⁹ /L○○-○○AE	F66	Boring
A10L- SDZC ⁹ /L○○-○○AE	F74	Boring
A10L- STLC ⁹ /L○○-○○AE	F88	Boring
A10L- STLP ⁹ /L○○-○○AE	F80	Boring
A10L- SVPC ⁹ /L○○-○○AE	F94	Boring
A10L- SWUB ⁹ /L○○-○○AE	F100	Boring
A12M- SCLC ⁹ /L○○-○○AE	F60	Boring
A12M- SCLP ⁹ /L○○-○○AE	F64	Boring
A12M- SDQC ⁹ /L○○-○○AE	F70	Boring
A12M- SDUC ⁹ /L○○-○○AE	F66	Boring
A12M- SDZC ⁹ /L○○-○○AE	F74	Boring
A12M- STLC ⁹ /L○○-○○AE	F88	Boring
A12M- STLP ⁹ /L○○-○○AE	F80	Boring
A12M- SVJC ⁹ /L○○-○○AE	F90	Boring
A12M- SVJP ⁹ /L○○-○○AE	F90	Boring
A12M- SVPB ⁹ /L○○-○○AE	F94	Boring
A12M- SVUC ⁹ /L○○-○○AE	F96	Boring
A12M- SVZC ⁹ /L○○-○○AE	F98	Boring
A12M- SWUP ⁹ /L○○-○○AE	F100	Boring
A16M- PCLNR○○-○○	F126	Boring
A16M- PTUNR○○-○○	F138	Boring
A16M- PWLNR○○-○○	F140	Boring
A16Q- SCLC ⁹ /L○○-○○AE	F60	Boring
A16Q- SCLP ⁹ /L○○-○○AE	F64	Boring
A16Q- SDQC ⁹ /L○○-○○AE	F70	Boring
A16Q- SDUC ⁹ /L○○-○○AE	F66	Boring
A16Q- SDZC ⁹ /L○○-○○AE	F74	Boring
A16Q- STLC ⁹ /L○○-○○AE	F88	Boring
A16Q- STLP ⁹ /L○○-○○AE	F80	Boring
A16Q- SVJC ⁹ /L○○-○○AE	F90	Boring
A16Q- SVPB ⁹ /L○○-○○AE	F94	Boring
A16Q- SVUB ⁹ /L○○-○○AE	F96	Boring
A16Q- SVZB ⁹ /L○○-○○AE	F98	Boring
A16Q- SWUP ⁹ /L○○-○○AE	F100	Boring
A20Q- PCLNR○○-○○	F126	Boring
A20Q- PDUNR○○-○○	F128	Boring
A20Q- PTUNR○○-○○	F138	Boring
A20Q- PWLNR○○-○○	F140	Boring
A20R- SCLC ⁹ /L○○-○○AE	F60	Boring
A20R- SCLP ⁹ /L○○-○○AE	F64	Boring
A20R- SDQC ⁹ /L○○-○○AE	F70	Boring
A20R- SDUC ⁹ /L○○-○○AE	F66	Boring
A20R- SDZC ⁹ /L○○-○○AE	F74	Boring
A20R- STLC ⁹ /L○○-○○AE	F88	Boring
A20R- STLP ⁹ /L○○-○○AE	F80	Boring
A20R- SVJB ⁹ /L○○-○○AE	F90	Boring
A20R- SVPB ⁹ /L○○-○○AE	F94	Boring
A20R- SVUB ⁹ /L○○-○○AE	F96	Boring
A20R- SVZB ⁹ /L○○-○○AE	F98	Boring
A20R- SWUP ⁹ /L○○-○○AE	F100	Boring
A20R- SZJB ⁹ /L○○-○○AE	F106	Boring
A20R- SZLB ⁹ /L○○-○○AE	F109	Boring
A20R- SZQB ⁹ /L○○-○○AE	F108	Boring
A20R- SZXB ⁹ /L○○-○○AE	F107	Boring
A20R- SZZB ⁹ /L○○-○○AE	F110	Boring
A25R- DCLN ⁹ /L○○-○○	F125	Boring
A25R- DSKN ⁹ /L○○-○○	F136	Boring
A25R- DTFN ⁹ /L○○-○○	F137	Boring

T



Index

Description	Page	Category
A25R- DWLN [®] /L 00-00	F142	Boring
A25R- PCLNR 00-00	F126	Boring
A25R- PDUNR 00-00	F128	Boring
A25R- PTUNR 00-00	F138	Boring
A25R- PWLNR 00-00	F140	Boring
A25S- SCLC [®] /L 00-00AE	F60	Boring
A25S- SCLP [®] /L 00-00AE	F64	Boring
A25S- SDQC [®] /L 00-00AE	F70	Boring
A25S- SDUC [®] /L 00-00AE	F66	Boring
A25S- SDZC [®] /L 00-00AE	F74	Boring
A25S- STLP [®] /L 00-00AE	F80	Boring
A25S- SVJB [®] /L 00-00AE	F90	Boring
A25S- SVPB [®] /L 00-00AE	F94	Boring
A25S- SVUB [®] /L 00-00AE	F96	Boring
A25S- SVZB [®] /L 00-00AE	F98	Boring
A25S- SZJB [®] /L 00-00AE	F106	Boring
A25S- SZLB [®] /L 00-00AE	F109	Boring
A25S- SZQB [®] /L 00-00AE	F108	Boring
A25S- SZXB [®] /L 00-00AE	F107	Boring
A25S- SZZB [®] /L 00-00AE	F110	Boring
A32S- DCLN [®] /L 00-00	F125	Boring
A32S- DDUN [®] /L 00-00	F130	Boring
A32S- DSKN [®] /L 00-00	F136	Boring
A32S- DTFN [®] /L 00-00	F137	Boring
A32S- DWLN [®] /L 00-00	F142	Boring
A32S- PDUNR 00-00	F128	Boring
A32S- SVJB [®] /L 00-00AE	F90	Boring
A32S- SVPB [®] /L 00-00AE	F94	Boring
A32S- SVUB [®] /L 00-00AE	F96	Boring
A32S- SVZB [®] /L 00-00AE	F98	Boring
A32S- SZJB [®] /L 00-00AE	F106	Boring
A32S- SZLB [®] /L 00-00AE	F109	Boring
A32S- SZQB [®] /L 00-00AE	F108	Boring
A32S- SZXB [®] /L 00-00AE	F107	Boring
A32S- SZZB [®] /L 00-00AE	F110	Boring
A40T- DCLN [®] /L 00-00	F125	Boring
A40T- DDUN [®] /L 00-00	F130	Boring
A40T- DSKN [®] /L 00-00	F136	Boring
A40T- DTFN [®] /L 00-00	F137	Boring
A40T- DWLN [®] /L 00-00	F142	Boring
A40T- SVJB [®] /L 00-00AE	F90	Boring
A50U- DDUN [®] /L 00-00	F130	Boring
AABSR 0000JX-00F	E20	Small tools
AABWR 0000JX-00F	E21, E22	Small tools
ABS 00R0000	B112	Turning indexable inserts
ABS 00R0000M	B112	Turning indexable inserts
ABW 00R0000	B112	Turning indexable inserts
ABW 00R0000M	B112	Turning indexable inserts
ACL [®] /L 0000JX-00FF	E26	Small tools
AD 00U	F124	Boring
AD 00V	F124	Boring
AD 00W	F124	Boring
ADJC [®] /L 0000JX-00FF	E29	Small tools
APMT 000000EL-NB0	M145	Milling
APMT 000000ER-NB0	M145	Milling
APMT 000000ER-NB0P	M145	Milling
AVJB [®] /L 0000JX-00FF	E40	Small tools

B

BDGT 00T000FR	C62, M69	CBN & PCD Tools, Milling
BDGT 00T000FR-JA	M69	Milling
BDGT 00T000FR-LE	C62, M69	CBN & PCD Tools, Milling
BDGT 000000FR-JA	M69	Milling
BDMT 00T000ER-JS	M69, M106	Milling

Description	Page	Category
BDMT 00T000ER-JT	M69	Milling
BDMT 00T000ER-N0	M99	Milling
BDMT 00T000FR	C62, M69	CBN & PCD Tools, Milling
BDMT 000000ER-JS	M69, M78, M106	Milling
BDMT 000000ER-JT	M69, M78	Milling
BDMT 000000ER-N0	M99	Milling
BDMT 000000FR	C62, M69	CBN & PCD Tools, Milling

C

C045X- SCLCR00-000E ZP	F32	Boring
C04G- SCLC [®] /L 00-00AN	F62	Boring
C04X- SJLC [®] /L 00-0000	F78	Boring
C04X- SJZC [®] /L 00-0000	F79	Boring
C050X SCLCR00-000E ZP	F32	Boring
C050X- SWUBR00-0000E ZP	F36	Boring
C05H- SCLC [®] /L 00-00AN	F62	Boring
C05H- SWUB [®] /L 00-00AN	F102	Boring
C060X- SCLCR00-000E ZP	F32	Boring
C060X- SWUBR00-0000E ZP	F36	Boring
C06J- SCLC [®] /L 00-00AN	F62	Boring
C06J- STLB [®] /L 00-00AN	F82	Boring
C06J- STXB [®] /L 00-0000	F86	Boring
C06J- STZB [®] /L 00-0000	F87	Boring
C06J- SWUB [®] /L 00-00AN	F102	Boring
C070X SCLCR00-000E ZP	F32	Boring
C070X- STLBR00-0000E ZP	F34	Boring
C070X- SWUBR00-0000E ZP	F36	Boring
C07K- SCLC [®] /L 00-00AN	F62	Boring
C07K- SWUB [®] /L 00-00AN	F102	Boring
C080X- SCLCR00-000E ZP	F32	Boring
C080X- STLPR00-0000E ZP	F34	Boring
C08X- STXP [®] /L 00-0000	F86	Boring
C10X- STXP [®] /L 00-0000	F86	Boring
CBSN [®] /L 0000K-00	D68	External turning
CBSN [®] /L 0000M-00	D68	External turning
CBSNR 0000B-00-A00	F115	Boring
CCET 00T000FL-USF	B63	Turning indexable inserts
CCET 00T000FR-USF	B63	Turning indexable inserts
CCET 00T000MFL-J	B65	Turning indexable inserts
CCET 00T000MFL-U	B63	Turning indexable inserts
CCET 00T000MFL-USF	B63	Turning indexable inserts
CCET 00T000MFR-J	B65	Turning indexable inserts
CCET 00T000MFR-U	B63	Turning indexable inserts
CCET 00T000MFR-USF	B63	Turning indexable inserts
CCET 00T000ML-P	B63	Turning indexable inserts
CCET 00T000MR-P	B63	Turning indexable inserts
CCET 00T000FL-USF	B63	Turning indexable inserts
CCET 00T000FR-USF	B63	Turning indexable inserts
CCET 00T000MFL-U	B63	Turning indexable inserts
CCET 00T000MFL-USF	B63	Turning indexable inserts
CCET 00T000MFR-U	B63	Turning indexable inserts
CCET 00T000MFR-USF	B63	Turning indexable inserts
CCET 000000FL-USF	B63	Turning indexable inserts
CCET 000000FR-USF	B63	Turning indexable inserts
CCET 000000L-FSF	B61	Turning indexable inserts
CCET 000000MFL-J	B65	Turning indexable inserts
CCET 000000MFL-U	B63	Turning indexable inserts
CCET 000000MFL-USF	B63	Turning indexable inserts
CCET 000000MFR-J	B65	Turning indexable inserts
CCET 000000MFR-U	B63	Turning indexable inserts
CCET 000000MFR-USF	B63	Turning indexable inserts
CCET 000000ML-F	B62	Turning indexable inserts
CCET 000000ML-FSF	B61	Turning indexable inserts



Description	Page	Category
CCET ○○○○○MR-F	B62	Turning indexable inserts
CCET ○○○○○MR-FSF	B61	Turning indexable inserts
CCET ○○○○○R-FSF	B61	Turning indexable inserts
CCET ○○○○○FL-USF	B63	Turning indexable inserts
CCET ○○○○○FR-USF	B63	Turning indexable inserts
CCET ○○○○○L-FSF	B61	Turning indexable inserts
CCET ○○○○○MFL-U	B63	Turning indexable inserts
CCET ○○○○○MFL-USF	B63	Turning indexable inserts
CCET ○○○○○MFR-J	B65	Turning indexable inserts
CCET ○○○○○MFR-U	B63	Turning indexable inserts
CCET ○○○○○MFR-USF	B63	Turning indexable inserts
CCET ○○○○○ML-F	B62	Turning indexable inserts
CCET ○○○○○ML-FSF	B61	Turning indexable inserts
CCET ○○○○○MR-F	B62	Turning indexable inserts
CCET ○○○○○R-FSF	B61	Turning indexable inserts
CCGT ○○T○○	B60	Turning indexable inserts
CCGT ○○T○○AH	B66	Turning indexable inserts
CCGT ○○T○○AP	B66	Turning indexable inserts
CCGT ○○T○○EL-U	B65	Turning indexable inserts
CCGT ○○T○○ER-U	B65	Turning indexable inserts
CCGT ○○T○○FL-U	B64	Turning indexable inserts
CCGT ○○T○○FR-U	B64	Turning indexable inserts
CCGT ○○T○○L-A○	B66	Turning indexable inserts
CCGT ○○T○○MEL-U	B65	Turning indexable inserts
CCGT ○○T○○MER-U	B65	Turning indexable inserts
CCGT ○○T○○MF	B61	Turning indexable inserts
CCGT ○○T○○MFL-U	B64	Turning indexable inserts
CCGT ○○T○○MFP-GF	B58	Turning indexable inserts
CCGT ○○T○○MFP-GQ	B59	Turning indexable inserts
CCGT ○○T○○MFP-SK	B59	Turning indexable inserts
CCGT ○○T○○MFP-SKS	B59	Turning indexable inserts
CCGT ○○T○○MFR-U	B64	Turning indexable inserts
CCGT ○○T○○MP-CK	B59	Turning indexable inserts
CCGT ○○T○○R-A○	B66	Turning indexable inserts
CCGT ○○T○○FL-U	B64	Turning indexable inserts
CCGT ○○T○○FR-U	B64	Turning indexable inserts
CCGT ○○T○○MF	B61	Turning indexable inserts
CCGT ○○T○○MFL-U	B64	Turning indexable inserts
CCGT ○○T○○MFP-SKS	B59	Turning indexable inserts
CCGT ○○T○○MFR-U	B64	Turning indexable inserts
CCGT ○○○○○	B60	Turning indexable inserts
CCGT ○○○○○AP	B66	Turning indexable inserts
CCGT ○○○○○EL-U	B65	Turning indexable inserts
CCGT ○○○○○ER-U	B65	Turning indexable inserts
CCGT ○○○○○FL-U	B64	Turning indexable inserts
CCGT ○○○○○FR-U	B64	Turning indexable inserts
CCGT ○○○○○L-A○	B66	Turning indexable inserts
CCGT ○○○○○L-F	B62	Turning indexable inserts
CCGT ○○○○○MEL-U	B65	Turning indexable inserts
CCGT ○○○○○MER-U	B65	Turning indexable inserts
CCGT ○○○○○MF	B61	Turning indexable inserts
CCGT ○○○○○MFL-U	B64	Turning indexable inserts
CCGT ○○○○○MFP-GF	B58	Turning indexable inserts
CCGT ○○○○○MFP-GQ	B59	Turning indexable inserts
CCGT ○○○○○MFP-PF	B58	Turning indexable inserts
CCGT ○○○○○MFP-SK	B59	Turning indexable inserts
CCGT ○○○○○MFP-SKS	B59	Turning indexable inserts
CCGT ○○○○○MFR-U	B64	Turning indexable inserts
CCGT ○○○○○ML-F	B62	Turning indexable inserts
CCGT ○○○○○MP-CF	B58	Turning indexable inserts
CCGT ○○○○○MP-CK	B59	Turning indexable inserts
CCGT ○○○○○MR-F	B62	Turning indexable inserts
CCGT ○○○○○R-A○	B66	Turning indexable inserts
CCGT ○○○○○R-F	B62	Turning indexable inserts

Description	Page	Category
CCGT ○○○○○FL-U	B64	Turning indexable inserts
CCGT ○○○○○FR-U	B64	Turning indexable inserts
CCGT ○○○○○L-F	B62	Turning indexable inserts
CCGT ○○○○○MF	B61	Turning indexable inserts
CCGT ○○○○○MFL-U	B64	Turning indexable inserts
CCGT ○○○○○MFP-SKS	B59	Turning indexable inserts
CCGT ○○○○○MFR-U	B64	Turning indexable inserts
CCGT ○○○○○ML-F	B62	Turning indexable inserts
CCGW ○○T○○	B66, C39	Turning indexable inserts, CBN & PCD Tools
CCGW ○○T○○NE	C39	CBN & PCD Tools
CCGW ○○T○○SE	C39	CBN & PCD Tools
CCGW ○○○○○	B66, C39	Turning indexable inserts, CBN & PCD Tools
CCGW ○○○○○NE	C39	CBN & PCD Tools
CCGW ○○○○○SE	C39	CBN & PCD Tools
CCLN [®] /L ○○○K-○○	D49	External turning
CCLN [®] /L ○○○M-○○	D49	External turning
CCLN [®] /L ○○○M-○○A	D60	External turning
CCLN [®] /L ○○○P-○○	D49	External turning
CCMT ○○T○○	B60, C39	Turning indexable inserts, CBN & PCD Tools
CCMT ○○T○○APD	C40	CBN & PCD Tools
CCMT ○○T○○GK	B60	Turning indexable inserts
CCMT ○○T○○HQ	B60	Turning indexable inserts
CCMT ○○T○○MQ	B61	Turning indexable inserts
CCMT ○○T○○NE	C39	CBN & PCD Tools
CCMT ○○T○○PP	B60	Turning indexable inserts
CCMT ○○T○○SE	C39	CBN & PCD Tools
CCMT ○○T○○WP	B60	Turning indexable inserts
CCMT ○○○○○	C39	CBN & PCD Tools
CCMT ○○○○○GK	B60	Turning indexable inserts
CCMT ○○○○○HQ	B60	Turning indexable inserts
CCMT ○○○○○NE	C39	CBN & PCD Tools
CCMT ○○○○○PP	B60	Turning indexable inserts
CCMT ○○○○○SE	C39	CBN & PCD Tools
CCMT ○○○○○WP	B60	Turning indexable inserts
CCMW ○○T○○MEF	C20	CBN & PCD Tools
CCMW ○○T○○S○○○○MES	C20	CBN & PCD Tools
CCMW ○○T○○S○○○○MET	C20	CBN & PCD Tools
CCMW ○○T○○S○○○○SET	C20	CBN & PCD Tools
CCMW ○○T○○T○○○○ME	C20	CBN & PCD Tools
CCMW ○○T○○T○○○○SE	C20	CBN & PCD Tools
CCMW ○○○○○S○○○○MES	C20	CBN & PCD Tools
CCMW ○○○○○S○○○○SET	C20	CBN & PCD Tools
CCMW ○○○○○T○○○○ME	C20	CBN & PCD Tools
CCMW ○○○○○T○○○○SE	C20	CBN & PCD Tools
CCRN [®] /L ○○○M-○○A	D60	External turning
CDJN [®] /L ○○○M-○○	D50	External turning
CDJN [®] /L ○○○P-○○	D50	External turning
CELN [®] /L ○○○M-○○	D51	External turning
CIN [®] /L ○○○S-○○	J27	Threading
CINR ○○○S-○○	J27	Threading
CNGA ○○○○○	B22	Turning indexable inserts
CNGA ○○○○○MEF	C8	CBN & PCD Tools
CNGA ○○○○○ME○	C8	CBN & PCD Tools
CNGA ○○○○○S○○○○	B113	Turning indexable inserts
CNGA ○○○○○S○○○○ME	C8	CBN & PCD Tools
CNGA ○○○○○S○○○○MEH	C8	CBN & PCD Tools
CNGA ○○○○○S○○○○MEP	C8	CBN & PCD Tools
CNGA ○○○○○S○○○○MET	C8	CBN & PCD Tools
CNGA ○○○○○S○○○○MEW	C8	CBN & PCD Tools
CNGA ○○○○○T○○○○	B113	Turning indexable inserts
CNGA ○○○○○T○○○○ME	C8	CBN & PCD Tools
CNGG ○○○○○AH	B23	Turning indexable inserts

Description	Page	Category
CNGG ○○○○○○FP-TK	B19	Turning indexable inserts
CNGG ○○○○○○HQ	B17	Turning indexable inserts
CNGG ○○○○○○%L	B23	Turning indexable inserts
CNGG ○○○○○○%L-AO	B23	Turning indexable inserts
CNGG ○○○○○○%L-S	B23	Turning indexable inserts
CNGG ○○○○○○%L-OR	B23	Turning indexable inserts
CNGG ○○○○○○MFP-SK	B19	Turning indexable inserts
CNGG ○○○○○○TK	B20	Turning indexable inserts
CNGG ○○○○○○Z	B23	Turning indexable inserts
CNGM ○○○○○○ME-HD	C9	CBN & PCD Tools
CNGM ○○○○○○ME-HH	C9	CBN & PCD Tools
CNGM ○○○○○○ME-HL	C9	CBN & PCD Tools
CNGN ○○○○○○S○○○○○	B113	Turning indexable inserts
CNGN ○○○○○○T○○○○○	B113	Turning indexable inserts
CNGU ○○○○○○MFP-SK	B55	Turning indexable inserts
CNGU ○○○○○○MFR-F	B55	Turning indexable inserts
CNGU ○○○○○○MFR-U	B55	Turning indexable inserts
CNGU ○○○○○○MFR-F	B55	Turning indexable inserts
CNGU ○○○○○○MFR-U	B55	Turning indexable inserts
CNMA ○○○○○○	B22	Turning indexable inserts
CNMA ○○○○○○S○○○○○	B13	Turning indexable inserts
CNMG ○○○○○○	B18	Turning indexable inserts
CNMG ○○○○○○AH	B23	Turning indexable inserts
CNMG ○○○○○○C	B22	Turning indexable inserts
CNMG ○○○○○○CJ	B17	Turning indexable inserts
CNMG ○○○○○○CQ	B17	Turning indexable inserts
CNMG ○○○○○○GC	B22	Turning indexable inserts
CNMG ○○○○○○GP	B16	Turning indexable inserts
CNMG ○○○○○○GS	B17	Turning indexable inserts
CNMG ○○○○○○GT	B18	Turning indexable inserts
CNMG ○○○○○○HQ	B17	Turning indexable inserts
CNMG ○○○○○○KG	B21	Turning indexable inserts
CNMG ○○○○○○KH	B21	Turning indexable inserts
CNMG ○○○○○○KQ	B21	Turning indexable inserts
CNMG ○○○○○○MQ	B20	Turning indexable inserts
CNMG ○○○○○○MS	B20	Turning indexable inserts
CNMG ○○○○○○MU	B20	Turning indexable inserts
CNMG ○○○○○○PG	B17	Turning indexable inserts
CNMG ○○○○○○PH	B18	Turning indexable inserts
CNMG ○○○○○○PP	B16	Turning indexable inserts
CNMG ○○○○○○PQ	B16	Turning indexable inserts
CNMG ○○○○○○PS	B18	Turning indexable inserts
CNMG ○○○○○○PT	B18	Turning indexable inserts
CNMG ○○○○○○SG	B21	Turning indexable inserts
CNMG ○○○○○○SQ	B20	Turning indexable inserts
CNMG ○○○○○○TK	B20	Turning indexable inserts
CNMG ○○○○○○TN-V	B17	Turning indexable inserts
CNMG ○○○○○○WE	B16	Turning indexable inserts
CNMG ○○○○○○WF	B16	Turning indexable inserts
CNMG ○○○○○○WP	B16	Turning indexable inserts
CNMG ○○○○○○WQ	B16	Turning indexable inserts
CNMG ○○○○○○XF	B19	Turning indexable inserts
CNMG ○○○○○○XP	B19	Turning indexable inserts
CNMG ○○○○○○XQ	B19	Turning indexable inserts
CNMG ○○○○○○XS	B19	Turning indexable inserts
CNMG ○○○○○○ZS	B22	Turning indexable inserts
CNMM ○○○○XL-SX	B21	Turning indexable inserts
CNMM ○○○○XR-SX	B21	Turning indexable inserts
CNMM ○○○○○○M	C34	CBN & PCD Tools
CNMM ○○○○○○M-NE	C34	CBN & PCD Tools
CNMM ○○○○○○M-SE	C34	CBN & PCD Tools
CNMM ○○○○○○PX	B19	Turning indexable inserts
CNMN ○○○○○○S○○○○○	C16	CBN & PCD Tools
CNMN ○○○○○○T○○○○○	B113	Turning indexable inserts

Description	Page	Category
CNMM ○○○○○○E-GK	B55	Turning indexable inserts
CPGB ○○○○○○S○○○○○MES	C21	CBN & PCD Tools
CPGB ○○○○○○S○○○○○MET	C21	CBN & PCD Tools
CPGB ○○○○○○T○○○○○ME	C21	CBN & PCD Tools
CPGB ○○○○○○T○○○○○SE	C21	CBN & PCD Tools
CPMB ○○○○○○	B67	Turning indexable inserts
CPMH ○○○○○○	B67, C41	Turning indexable inserts, CBN & PCD Tools
CPMH ○○○○○○HQ	B67	Turning indexable inserts
CPMH ○○○○○○L-Y	B67	Turning indexable inserts
CPMH ○○○○○○NE	C41	CBN & PCD Tools
CPMH ○○○○○○R-Y	B67	Turning indexable inserts
CPMH ○○○○○○SE	C41	CBN & PCD Tools
CPMT ○○○○○○GP	B67	Turning indexable inserts
CPMT ○○○○○○PP	B67	Turning indexable inserts
CPMT ○○○○○○XP	B67	Turning indexable inserts
CPMT ○○○○○○XQ	B67	Turning indexable inserts
CRDNN ○○○○K-○○	D58	External turning
CRDNN ○○○○M-○○	D58	External turning
CRDNN ○○○○M-○○A	D61	External turning
CRDNN ○○○○P-○○	D58	External turning
CRDNN ○○○○P-○○A	D61	External turning
CRDNN ○○○○R-○○	D58	External turning
CRSN [%] L ○○○○K-○○	D58	External turning
CRSN [%] L ○○○○M-○○	D58	External turning
CRSN [%] L ○○○○M-○○A	D61	External turning
CRSN [%] L ○○○○P-○○	D58	External turning
CRSN [%] L ○○○○P-○○A	D61	External turning
CS-N [%] L ○○○○M-○○	D52	External turning
CSDNN ○○○○K-○○	D54	External turning
CSDNN ○○○○M-○○	D54	External turning
CSDNN ○○○○M-○○A	D64	External turning
CSDNN ○○○○P-○○	D54	External turning
CSKN [%] L ○○○○K-○○	D53	External turning
CSKN [%] L ○○○○M-○○	D53	External turning
CSKNR ○○○○M-○○A	D63	External turning
CSKNR ○○○○P-○○	D53	External turning
CSRN [%] L ○○○○K-○○	D52	External turning
CSRN [%] L ○○○○M-○○	D52	External turning
CSRN [%] L ○○○○M-○○A	D63	External turning
CSRN [%] L ○○○○P-○○	D52	External turning
CSRN [%] L ○○○○R-○○	D52	External turning
CSSN [%] L ○○○○K-○○	D54	External turning
CSSN [%] L ○○○○M-○○	D54	External turning
CSSN [%] L ○○○○M-○○A	D64	External turning
CSYN [%] L ○○○○M-○○	D53	External turning
CTJN [%] L ○○○○K-○○	D56	External turning
CTJN [%] L ○○○○M-○○	D56	External turning
CTJN [%] L ○○○○M-○○A	D66	External turning
CTUN [%] L ○○○○K-○○	D56	External turning
CTUN [%] L ○○○○M-○○	D56	External turning

D

DA ○○○○M-FTP	K12	Drilling
DA ○○○○M-GM	K6, K7, K8, K9	Drilling
DA ○○○○M-HQP	K14, K15, K16	Drilling
DA ○○○○M-HQS	K17	Drilling
DA ○○○○M-KM	K10, K11	Drilling
DC ○○○○M-SC	K34, K35, K36	Drilling
DCET ○○T○○○FL-JSF	B76	Turning indexable inserts
DCET ○○T○○○FL-USF	B74	Turning indexable inserts
DCET ○○T○○○FR-JSF	B76	Turning indexable inserts



Description	Page	Category
DCGT ○○○○○○MFL-U	B75	Turning indexable inserts
DCGT ○○○○○○MFP-SKS	B68	Turning indexable inserts
DCGT ○○○○○○MFR-U	B75	Turning indexable inserts
DCGT ○○○○○○ML-F	B73	Turning indexable inserts
DCGT ○○○○○○MR-F	B73	Turning indexable inserts
DCGT ○○○○○○R-F	B73	Turning indexable inserts
DCGW ○○T○○○	B78	Turning indexable inserts
DCGW ○○○○○○	B78	Turning indexable inserts
DCLN%L ○○○○K-○○	D8	External turning
DCLN%L ○○○○K-○○JCT	D9	External turning
DCLN%L ○○○○M-○○	D8	External turning
DCLN%L ○○○○M-○○JCT	D9	External turning
DCMT ○○T○○○	B70, C42	Turning indexable inserts, CBN & PCD Tools
DCMT ○○T○○○APD	C42	CBN & PCD Tools
DCMT ○○T○○○GK	B70	Turning indexable inserts
DCMT ○○T○○○GP	B69	Turning indexable inserts
DCMT ○○T○○○HQ	B70	Turning indexable inserts
DCMT ○○T○○○L-NE	C42	CBN & PCD Tools
DCMT ○○T○○○MQ	B71	Turning indexable inserts
DCMT ○○T○○○NE	C42	CBN & PCD Tools
DCMT ○○T○○○PP	B69	Turning indexable inserts
DCMT ○○T○○○R-NE	C42	CBN & PCD Tools
DCMT ○○T○○○SE	C42	CBN & PCD Tools
DCMT ○○T○○○XP	B71	Turning indexable inserts
DCMT ○○T○○○XQ	B71	Turning indexable inserts
DCMT ○○○○○○	C42	CBN & PCD Tools
DCMT ○○○○○○GK	B70	Turning indexable inserts
DCMT ○○○○○○GP	B69	Turning indexable inserts
DCMT ○○○○○○HQ	B70	Turning indexable inserts
DCMT ○○○○○○L-NE	C42	CBN & PCD Tools
DCMT ○○○○○○MQ	B71	Turning indexable inserts
DCMT ○○○○○○NE	C42	CBN & PCD Tools
DCMT ○○○○○○PP	B69	Turning indexable inserts
DCMT ○○○○○○R-NE	C42	CBN & PCD Tools
DCMT ○○○○○○SE	C42	CBN & PCD Tools
DCMT ○○○○○○XP	B71	Turning indexable inserts
DCMW ○○T○○○MEF	C22	CBN & PCD Tools
DCMW ○○T○○○S○○○○○MES	C22	CBN & PCD Tools
DCMW ○○T○○○S○○○○○MET	C22	CBN & PCD Tools
DCMW ○○T○○○S○○○○○SET	C22	CBN & PCD Tools
DCMW ○○T○○○T○○○○○ME	C22	CBN & PCD Tools
DCMW ○○T○○○T○○○○○SE	C22	CBN & PCD Tools
DCMW ○○○○○○S○○○○○MET	C22	CBN & PCD Tools
DCMW ○○○○○○S○○○○○SET	C22	CBN & PCD Tools
DCMW ○○○○○○T○○○○○ME	C22	CBN & PCD Tools
DCMW ○○○○○○T○○○○○SE	C22	CBN & PCD Tools
DCMX ○○T○○○L-WP	B69	Turning indexable inserts
DCMX ○○T○○○R-WP	B69	Turning indexable inserts
DCMX ○○T○○○WP	B69	Turning indexable inserts
DCMX ○○○○○○L-WP	B69	Turning indexable inserts
DCMX ○○○○○○R-WP	B69	Turning indexable inserts
DCMX ○○○○○○WP	B69	Turning indexable inserts
DDHN%L ○○○○K-○○○○	D15	External turning
DDHN%L ○○○○M-○○○○	D15	External turning
DDJN%L ○○○○K-○○JCT	D14	External turning
DDJN%L ○○○○K-○○○○	D13	External turning
DDJN%L ○○○○M-○○JCT	D14	External turning
DDJN%L ○○○○M-○○○○	D13	External turning
DMC ○○○H	M149	Milling
DMC ○○○SX	M148	Milling
DMC ○○○SX-○○○	M148	Milling
DMC ○○○SXT	M148	Milling
DNGA ○○○○○○MEF	C10	CBN & PCD Tools

Description	Page	Category
DNGA ○○○○○○ME○	C10	CBN & PCD Tools
DNGA ○○○○○○S○○○○○	70	
DNGA ○○○○○○S○○○○○ME	C10	CBN & PCD Tools
DNGA ○○○○○○S○○○○○MEH	C10	CBN & PCD Tools
DNGA ○○○○○○S○○○○○MEP	C10	CBN & PCD Tools
DNGA ○○○○○○S○○○○○MET	C10	CBN & PCD Tools
DNGA ○○○○○○T○○○○○	B114	Turning indexable inserts
DNGA ○○○○○○T○○○○○ME	C10	CBN & PCD Tools
DNGG ○○○○○○AH	B31	Turning indexable inserts
DNGG ○○○○○○FP-TK	B28	Turning indexable inserts
DNGG ○○○○○○L	B31	Turning indexable inserts
DNGG ○○○○○○L-A○	B31	Turning indexable inserts
DNGG ○○○○○○L-S	B31	Turning indexable inserts
DNGG ○○○○○○MFP-SK	B28	Turning indexable inserts
DNGG ○○○○○○R	B31	Turning indexable inserts
DNGG ○○○○○○R-A○	B31	Turning indexable inserts
DNGG ○○○○○○R-S	B31	Turning indexable inserts
DNGG ○○○○○○TK	B28	Turning indexable inserts
DNGM ○○○○○○ME-HD	C11	CBN & PCD Tools
DNGM ○○○○○○ME-HH	C11	CBN & PCD Tools
DNGM ○○○○○○ME-HL	C11	CBN & PCD Tools
DNGN ○○○○○○S○○○○○	B114	Turning indexable inserts
DNGN ○○○○○○T○○○○○	B114	Turning indexable inserts
DNGU ○○○○○○MER-U	B56	Turning indexable inserts
DNGU ○○○○○○MFP-SK	B56	Turning indexable inserts
DNGU ○○○○○○MFR-F	B56	Turning indexable inserts
DNGU ○○○○○○MFR-U	B56	Turning indexable inserts
DNMA ○○○○○○	B31	Turning indexable inserts
DNMG ○○○○○○	B27	Turning indexable inserts
DNMG ○○○○○○AH	B31	Turning indexable inserts
DNMG ○○○○○○C	B30	Turning indexable inserts
DNMG ○○○○○○CJ	B25	Turning indexable inserts
DNMG ○○○○○○CQ	B25	Turning indexable inserts
DNMG ○○○○○○GC	B30	Turning indexable inserts
DNMG ○○○○○○GP	B24	Turning indexable inserts
DNMG ○○○○○○GS	B25	Turning indexable inserts
DNMG ○○○○○○GT	B26	Turning indexable inserts
DNMG ○○○○○○HQ	B25	Turning indexable inserts
DNMG ○○○○○○KG	B30	Turning indexable inserts
DNMG ○○○○○○KH	B30	Turning indexable inserts
DNMG ○○○○○○KQ	B30	Turning indexable inserts
DNMG ○○○○○○MQ	B28	Turning indexable inserts
DNMG ○○○○○○MS	B29	Turning indexable inserts
DNMG ○○○○○○MU	B29	Turning indexable inserts
DNMG ○○○○○○PG	B26	Turning indexable inserts
DNMG ○○○○○○PH	B27	Turning indexable inserts
DNMG ○○○○○○PP	B24	Turning indexable inserts
DNMG ○○○○○○PQ	B24	Turning indexable inserts
DNMG ○○○○○○PS	B26	Turning indexable inserts
DNMG ○○○○○○PT	B26	Turning indexable inserts
DNMG ○○○○○○R-LD	B28	Turning indexable inserts
DNMG ○○○○○○SQ	B29	Turning indexable inserts
DNMG ○○○○○○SQ	B29	Turning indexable inserts
DNMG ○○○○○○TK	B28	Turning indexable inserts
DNMG ○○○○○○TN-V	B25	Turning indexable inserts
DNMG ○○○○○○XF	B27	Turning indexable inserts
DNMG ○○○○○○XP	B27	Turning indexable inserts
DNMG ○○○○○○XQ	B27	Turning indexable inserts
DNMG ○○○○○○XS	B27	Turning indexable inserts
DNMG ○○○○○○ZS	B30	Turning indexable inserts
DNMM ○○○○○○M	C35	CBN & PCD Tools
DNMM ○○○○○○M-NE	C35	CBN & PCD Tools
DNMM ○○○○○○M-SE	C35	CBN & PCD Tools
DNMM ○○○○○○PX	B27	Turning indexable inserts



Description	Page	Category
DNMU ○○○○○E-GK	B56	Turning indexable inserts
DNMX ○○○○○WF	B24	Turning indexable inserts
DPET ○○T○○FL-USF	B79	Turning indexable inserts
DPET ○○T○○FR-USF	B79	Turning indexable inserts
DPET ○○T○○L-FSF	B79	Turning indexable inserts
DPET ○○T○○MFR-USF	B79	Turning indexable inserts
DPET ○○T○○MR-FSF	B79	Turning indexable inserts
DPET ○○T○○R-FSF	B79	Turning indexable inserts
DPET ○○T○○FR-USF	B79	Turning indexable inserts
DPET ○○T○○MFR-USF	B79	Turning indexable inserts
DPET ○○T○○MR-FSF	B79	Turning indexable inserts
DPET ○○T○○R-FSF	B79	Turning indexable inserts
DPET ○○○○○FL-USF	B79	Turning indexable inserts
DPET ○○○○○FR-USF	B79	Turning indexable inserts
DPET ○○○○○L-FSF	B79	Turning indexable inserts
DPET ○○○○○MFR-USF	B79	Turning indexable inserts
DPET ○○○○○ML-FSF	B79	Turning indexable inserts
DPET ○○○○○MR-FSF	B79	Turning indexable inserts
DPET ○○○○○R-FSF	B79	Turning indexable inserts
DPET ○○○○○FR-USF	B79	Turning indexable inserts
DPET ○○○○○MFR-USF	B79	Turning indexable inserts
DPET ○○○○○R-FSF	B79	Turning indexable inserts
DSBN%L ○○○○K-○○	D19	External turning
DSBN%L ○○○○M-○○	D19	External turning
DTGN%L ○○○○K-○○	D22	External turning
DTGN%L ○○○○K-○○JCT	D23	External turning
DTGN%L ○○○○M-○○	D22	External turning
DTGN%L ○○○○M-○○JCT	D23	External turning
DVLN%L ○○○○K-○○	D30	External turning
DVLN%L ○○○○K-○○JCT	D31	External turning
DVLN%L ○○○○M-○○	D30	External turning
DVLN%L ○○○○M-○○JCT	D31	External turning
DVLNL ○○○○K-○○JCT	D31	External turning
DVLNL ○○○○M-○○JCT	D31	External turning
DVLNR ○○○○K-○○JCT	D31	External turning
DVLNR ○○○○M-○○JCT	D31	External turning
DVPN%L ○○○○K-○○	D32	External turning
DVPN%L ○○○○K-○○JCT	D33	External turning
DVPN%L ○○○○M-○○	D32	External turning
DVPN%L ○○○○M-○○JCT	D33	External turning
DVPLNL ○○○○K-○○JCT	D33	External turning
DVPLNL ○○○○M-○○JCT	D33	External turning
DVPNR ○○○○K-○○JCT	D33	External turning
DVPNR ○○○○M-○○JCT	D33	External turning
DVVNN ○○○○K-○○	D34	External turning
DVVNN ○○○○K-○○JCT	D35	External turning
DVVNN ○○○○M-○○	D34	External turning
DVVNN ○○○○M-○○JCT	D35	External turning
DWLN%L ○○○○K-○○	D43	External turning
DWLN%L ○○○○K-○○JCT	D44	External turning
DWLN%L ○○○○M-○○	D43	External turning
DWLN%L ○○○○M-○○JCT	D44	External turning

E

E08L- SCLC%L○○-○○AN	F62	Boring
E08L- SCLCR○○-○○AN○/○	F62	Boring
E08L- STLP%L○○-○○AN	F82	Boring
E08L- SWUB%L○○-○○AN	F102	Boring
E10N- SCLC%L○○-○○AN	F62	Boring
E10N- SCLCR○○-○○AN○/○	F62	Boring
E10N- SCLP%L○○-○○AN	F65	Boring
E10N- SCLPR○○-○○AN○/○	F65	Boring
E10N- SDQC%L○○-○○A	F72	Boring
E10N- SDQCR○○-○○A-○/○	F72	Boring

Description	Page	Category
E10N- SDUC%L○○-○○A	F68	Boring
E10N- SDUCR○○-○○A-○/○	F68	Boring
E10N- SDZCR○○-○○A	F76	Boring
E10N- STLP%L○○-○○AN	F82	Boring
E10N- STLPR○○-○○AN○/○	F82	Boring
E10N- SVPBR○○-○○A	F95	Boring
E10N- SWUB%L○○-○○AN	F102	Boring
E10N- SWUBR○○-○○AN○/○	F102	Boring
E12Q- SCLC%L○○-○○A	F62	Boring
E12Q- SCLCR○○-○○A-○/○	F62	Boring
E12Q- SCLP%L○○-○○A	F65	Boring
E12Q- SCLPR○○-○○A-○/○	F65	Boring
E12Q- SDQC%L○○-○○A	F72	Boring
E12Q- SDQCR○○-○○A-○/○	F72	Boring
E12Q- SDUC%L○○-○○A	F68	Boring
E12Q- SDUCR○○-○○A-○/○	F68	Boring
E12Q- SDZCR○○-○○A	F76	Boring
E12Q- STLP%L○○-○○A	F82	Boring
E12Q- STLPR○○-○○A-○/○	F82	Boring
E12Q- SVPBR○○-○○A	F95	Boring
E12Q- SVUCR○○-○○A	F97	Boring
E12Q- SWUP%L○○-○○A	F102	Boring
E12Q- SWUPR○○-○○A-○/○	F102	Boring
E16X- SCLC%L○○-○○A	F62	Boring
E16X- SCLCR○○-○○A-○/○	F62	Boring
E16X- SCLP%L○○-○○A	F65	Boring
E16X- SCLPR○○-○○A-○/○	F65	Boring
E16X- SDQC%L○○-○○A	F72	Boring
E16X- SDQCR○○-○○A-○/○	F72	Boring
E16X- SDUC%L○○-○○A	F68	Boring
E16X- SDUCR○○-○○A-○/○	F68	Boring
E16X- SDZCR○○-○○A	F76	Boring
E16X- STLP%L○○-○○A	F82	Boring
E16X- STLPR○○-○○A-○/○	F82	Boring
E16X- SVPBR○○-○○A	F95	Boring
E16X- SVUBR○○-○○A	F97	Boring
E16X- SWUP%L○○-○○A	F102	Boring
E16X- SWUPR○○-○○A-○/○	F102	Boring
E20S- SCLC%L○○-○○A	F62	Boring
E20S- SCLCR○○-○○A-○/○	F62	Boring
E20S- SCLP%L○○-○○A	F65	Boring
E20S- SCLPR○○-○○A-○/○	F65	Boring
E20S- SDQC%L○○-○○A	F72	Boring
E20S- SDQCR○○-○○A-○/○	F72	Boring
E20S- SDUC%L○○-○○A	F68	Boring
E20S- SDUCR○○-○○A-○/○	F68	Boring
E20S- SDZCR○○-○○A	F76	Boring
E20S- STLP%L○○-○○A	F82	Boring
E20S- STLPR○○-○○A-○/○	F82	Boring
E20S- SVPBR○○-○○A	F95	Boring
E20S- SVUBR○○-○○A	F97	Boring
E20S- SWUP%L○○-○○A	F102	Boring
E20S- SWUPR○○-○○A-○/○	F102	Boring
E25T- SCLC%L○○-○○A	F62	Boring
E25T- SCLCR○○-○○A-○/○	F62	Boring
E25T- SCLP%L○○-○○A	F65	Boring
E25T- SCLPR○○-○○A-○/○	F65	Boring
E25T- SDQC%L○○-○○A	F72	Boring
E25T- SDQCR○○-○○A-○/○	F72	Boring
E25T- SDUC%L○○-○○A	F68	Boring
E25T- SDUCR○○-○○A-○/○	F68	Boring
E25T- STLP%L○○-○○A	F82	Boring
E25T- STLPR○○-○○A-○/○	F82	Boring
E25T- SVPBR○○-○○A	F95	Boring

T



Index

Description	Page	Category
EZ5T-SVUBR○○○A	F97	Boring
ENET○○○PAER-C	M157	Milling
ENET○○○PAER-G	M157	Milling
ENET○○○PAER-R	M157	Milling
ENGN○○○○○S○○○○	B115	Turning indexable inserts
ENGN○○○○○T○○○○	B115	Turning indexable inserts
EZB ⁹ /L○○○○○HP-○○○H	F16	Boring
EZBCR○○○○○-○○○-○○	F27	Boring
EZBFR○○○○○-○○○	F24	Boring
EZBPR○○○○○-○○○	F26	Boring
EZBPR○○○○○-○○○-○○	F26	Boring
EZBR○○○○○-○○○NB	C58, F22	CBN & PCD Tools, Boring
EZBR○○○○○HP-○○○F	F19	Boring
EZBR○○○○○HP-○○○G	F18	Boring
EZBR○○○○○HP-○○○H-LT	F17	Boring
EZBR○○○○○ST-○○○F	F21	Boring
EZBR○○○○○ST-○○○H	F20	Boring
EZBTR○○○○○-○○○	F30	Boring
EZF ⁹ /L○○○○○-...	G103	Grooving
EZG ⁹ /L○○○○○-...	G71	Grooving
EZGR○○○○○-...-○○○S	G71	Grooving
EZH○○○○○.○○○CT-○○○	F38, F39	Boring
EZH○○○○○.HP-○○○	F40, F41	Boring
EZH○○○○○.ST-○○○	F42, F43	Boring
EZH○○○○○CT-○○○	F38, F39	Boring
EZH○○○○○HP-○○○	F40, F41	Boring
EZH○○○○○ST-○○○	F42, F43	Boring
EZTR○○○○○-○○○-○○○	J40	Threading
EZVBR○○○○○-○○○	F28	Boring

F

FGGL○○○○-○○	G50	Grooving
FGGR○○○○-○○	G50	Grooving
FMM○○-○○	G134	Grooving
FMN○	G134	Grooving
FTK○	G139	Grooving

G

GA○○	G61	Grooving
GBA32L○○○-○○○F	G7	Grooving
GBA32R○○○-○○○	C52, G7	CBN & PCD Tools, Grooving
GBA32R○○○-○○○F	G7	Grooving
GBA32R○○○-○○○R	G7	Grooving
GBA43L○○○-○○○	C52, G9, G12	CBN & PCD Tools, Grooving
GBA43L○○○-○○○F	G10	Grooving
GBA43L○○○-○○○GM	G11	Grooving
GBA43L○○○-○○○MY	G11	Grooving
GBA43L○○○-○○○R	G12	Grooving
GBA43L○○○-○○○RF	G12	Grooving
GBA43L○○○-○○○	G9	Grooving
GBA43R○○○-○○○	C52, G8, G12	CBN & PCD Tools, Grooving
GBA43R○○○-○○○F	G10	Grooving
GBA43R○○○-○○○F	G10	Grooving
GBA43R○○○-○○○GM	G11	Grooving
GBA43R○○○-○○○MY	G11	Grooving
GBA43R○○○-○○○MY	G11	Grooving
GBA43R○○○-○○○R	G12	Grooving
GBA43R○○○-○○○RF	G12	Grooving
GBA43R○○○-○○○	G8	Grooving
GBF32L	G22	Grooving
GBF32L○○○-○○○	G22	Grooving
GBF32L○○○-○○○F	G20	Grooving
GBF32R○○○-○○○	G21	Grooving

Description	Page	Category
GBF32R○○○-○○○F	G20	Grooving
GBF32R○○○-○○○GL	G20	Grooving
GC08L○○○-○○○	G75	Grooving
GC08R○○○-○○○	G75	Grooving
GC08R○○○-○○○R	G75	Grooving
GC10L○○○-○○○	G75	Grooving
GC10R○○○-○○○	G75	Grooving
GC10R○○○-○○○R	G75	Grooving
GC12L○○○-○○○	G75	Grooving
GC12R○○○-○○○	G75	Grooving
GC12R○○○-○○○R	G75	Grooving
GDFG○○○○N-○○○GS	G111	Grooving
GDFM○○○○N-○○○DM	G111	Grooving
GDFM○○○○N-○○○GH	G111	Grooving
GDFM○○○○N-○○○GM	G111	Grooving
GDFM○○○○N-○○○R-CM	G111	Grooving
GDFMS○○○○N-○○○DM	G111	Grooving
GDG○○○○N-○○○GS	G31, G90	Grooving
GDG○○○○N-○○○PG	H20	Cut-Off
GDG○○○○R-○○○PG-○○○D	H20	Cut-Off
GDGS○○○○N-○○○NB	C30, C54, G33	CBN & PCD Tools, Grooving
GDM○○○○L-○○○PF-○○○D	H20	Cut-Off
GDM○○○○N-○○○GL	G31	Grooving
GDM○○○○N-○○○GM	G30	Grooving
GDM○○○○N-○○○GMI	G90	Grooving
GDM○○○○N-○○○PF	H20	Cut-Off
GDM○○○○N-○○○PH	G32, H21	Grooving, Cut-Off
GDM○○○○N-○○○PM	H21	Cut-Off
GDM○○○○N-○○○PQ	H20	Cut-Off
GDM○○○○N-○○○R-CM	G32, G90	Grooving
GDM○○○○R-○○○PF-○○○D	H20	Cut-Off
GDM○○○○R-○○○PM-○○○D	H21	Cut-Off
GDM○○○○R-○○○PQ-○○○D	H20	Cut-Off
GDM○○○○B-○○○	G91	Grooving
GDMS○○○○N-○○○GM	G30	Grooving
GDMS○○○○N-○○○PH	G32, H21	Grooving, Cut-Off
GDMS○○○○N-○○○PM	H21	Cut-Off
GDMS○○○○R-○○○PM-○○○D	H21	Cut-Off
GER○○○-○○○AR	G78	Grooving
GE ⁹ /L○○○-○○○A	G78	Grooving
GER○○○-○○○BR	G78	Grooving
GE ⁹ /L○○○-○○○B	G78	Grooving
GER○○○-○○○C	G79	Grooving
GER○○○-○○○CM	G78	Grooving
GER○○○-○○○CR	G79	Grooving
GE ⁹ /L○○○-○○○C	G79	Grooving
GER○○○-○○○D	G79	Grooving
GER○○○-○○○DM	G78	Grooving
GER○○○-○○○DR	G79	Grooving
GE ⁹ /L○○○-○○○D	G79	Grooving
GER○○○-○○○E	G80	Grooving
GER○○○-○○○EM	G80	Grooving
GE ⁹ /L○○○-○○○E	G80	Grooving
GFV ⁹ /L○○○○K-○○○A	G127	Grooving
GFV ⁹ /L○○○○K-○○○B	G127	Grooving
GFV ⁹ /L○○○○M-○○○A	G127	Grooving
GFV ⁹ /L○○○○M-○○○B	G127	Grooving
GFV ⁹ /L○○○○M-○○○C	G127	Grooving
GFV ⁹ /L○○○○M-○○○C	G127	Grooving
GFVS ⁹ /L○○○○K-○○○AA	G125	Grooving
GFVS ⁹ /L○○○○K-○○○B	G129	Grooving
GFVS ⁹ /L○○○○M-○○○AA	G125	Grooving
GFVS ⁹ /L○○○○M-○○○B	G129	Grooving



Description	Page	Category
GFVS ⁹ /L ○○○○M-○○○C	G129	Grooving
GFVS ⁹ /L ○○○○M-○○○○C	G129	Grooving
GFVT ⁹ /L ○○○○K-○○AA	G125	Grooving
GFVT ⁹ /L ○○○○K-○○○B	G130	Grooving
GFVT ⁹ /L ○○○○M-○○AA	G125	Grooving
GFVT ⁹ /L ○○○○M-○○○B	G130	Grooving
GFVT ⁹ /L ○○○○M-○○○C	G130	Grooving
GFVT ⁹ /L ○○○○M-○○○○C	G130	Grooving
GH ○○○○-○○	G61	Grooving
GH ○○○○B-○	G93	Grooving
GHU ○○-○○	G61, G92	Grooving
GIA ○○	G96	Grooving
GIV ⁹ /L ○○○○B-○○○A	G133	Grooving
GIV ⁹ /L ○○○○B-○○○B	G133	Grooving
GIV ⁹ /L ○○○○B-○○○C	G133	Grooving
GIV ⁹ /L ○○○○-○A	G86	Grooving
GIV ⁹ /L ○○○○-○AE	G87	Grooving
GIV ⁹ /L ○○○○-○AW	G88	Grooving
GIV ⁹ /L ○○○○-○B	G86	Grooving
GIV ⁹ /L ○○○○-○BE	G87	Grooving
GIV ⁹ /L ○○○○-○BW	G88	Grooving
GIV ⁹ /L ○○○○-○C	G86	Grooving
GIV ⁹ /L ○○○○-○CE	G87	Grooving
GIV ⁹ /L ○○○○-○CW	G88	Grooving
GIV ⁹ /L ○○○○-○S	G86	Grooving
GIV ⁹ /L ○○○○-○SE	G87	Grooving
GIV ⁹ /L ○○○○-○SS	G86	Grooving
GMG ○○○○-○○MG	G49, G94, G137	Grooving
GMG ○○○○-○○MS	G48	Grooving
GMG ○○○○-○○R	G49	Grooving
GMG ○○○○-○○RU	G49	Grooving
GMGA ○○○○-○○R	G50, G94, G137	Grooving
GMGW ○○○○-○○R	C56, G66	CBN & PCD Tools, Grooving
GMGW ○○○○-○○R-HR	C56, G66	CBN & PCD Tools, Grooving
GML ○-○D	G52, H35	Grooving, Cut-Off
GML ○-○-○D	G52, H35	Grooving, Cut-Off
GMM ○○○○-MT	G51, H34	Grooving, Cut-Off
GMM ○○○○-NB	G51, H34	Grooving, Cut-Off
GMM ○○○○-TK	G51, H34	Grooving, Cut-Off
GMM ○○○○-TMR	H34	Cut-Off
GMM ○○○○-○○	G50	Grooving
GMM ○○○○-○○R	G50	Grooving
GMM ○○○○-○○MS	G48	Grooving
GMM ○○○○-○○MW	G48, G94, G137	Grooving
GMM ○○○○-○○R	G49	Grooving
GMM ○○○○-○○V	G98	Grooving
GMM ○○○○R-MT-○D	G52, H35	Grooving, Cut-Off
GMM ○○○○ ⁹ /L-MT-○D	G52, H35	Grooving, Cut-Off
GMM ○○○○R-TK-○D	G52, H35	Grooving, Cut-Off
GMM ○○○○R-TMR-○D	H35	Cut-Off
GMN ○	C31, C55, G51, G53, H34	CBN & PCD Tools, Grooving, Cut-Off
GMN ○-TK	G51, H34	Grooving, Cut-Off
GMN ○-○	G51, H34	Grooving, Cut-Off
GMR ○-TK-○D	G52, H35	Grooving, Cut-Off
GMR ○-○D	G52, H35	Grooving, Cut-Off
GMR ○-○-○D	G52, H35	Grooving, Cut-Off
GMR ○-○-○D	G52, H35	Grooving, Cut-Off
GOMT ○○T○○ER-D	M210	Milling
GOMT ○○○○○ER-D	M210	Milling
GVFL ○○○-○○○A	G126	Grooving

Description	Page	Category
GVFL ○○○-○○○AA	G124	Grooving
GVFL ○○○-○○○AR	G126	Grooving
GVFL ○○○-○○○B	C53, G126	CBN & PCD Tools, Grooving
GVFL ○○○-○○○BR	G126	Grooving
GVFL ○○○-○○○C	G126	Grooving
GVFR ○○○-○○○A	G126	Grooving
GVFR ○○○-○○○AA	G124	Grooving
GVFR ○○○-○○○AR	G126	Grooving
GVFR ○○○-○○○B	C53, G126, M274	CBN & PCD Tools, Grooving, Milling
GVFR ○○○-○○○BR	G126	Grooving
GVFR ○○○-○○○C	C53, G126	CBN & PCD Tools, Grooving
GVR (○○○-○○○C)	M273	Milling
GVR ○○○-○○○A	C53, G84, G85, M273	CBN & PCD Tools, Grooving, Milling
GVR ○○○-○○○AR	G85, M273	Grooving, Milling
GV ⁹ /L ○○○-○○○AR	G85	Grooving
GV ⁹ /L ○○○-○○○A	G84	Grooving
GVR ○○○-○○○B	C53, G85, M273	CBN & PCD Tools, Grooving, Milling
GVR ○○○-○○○BR	G85, M273	Grooving, Milling
GV ⁹ /L ○○○-○○○B	G85	Grooving
GVR ○○○-○○○C	G85, M273	Grooving, Milling
GV ⁹ /L ○○○-○○○C	G85	Grooving
GVR ○○○-○○○S	G84, M273	Grooving, Milling
GVR ○○○-○○○SS	G84, M273	Grooving, Milling
GV ⁹ /L ○○○-○○○SS	G84	Grooving
GV ⁹ /L ○○○-○○○S	G84	Grooving

H

HA32 PCLN ⁹ /L○○-○○	F116	Boring
HA32 PDUN ⁹ /L○○-○○	F118	Boring
HA32 PTFN ⁹ /L○○-○○	F120	Boring
HA32 SCLC ⁹ /L○○-○○	F122	Boring
HA32 SDUC ⁹ /L○○-○○	F123	Boring
HA40 PCLN ⁹ /L○○-○○	F116	Boring
HA40 PDUN ⁹ /L○○-○○	F118	Boring
HA40 PTFN ⁹ /L○○-○○	F120	Boring
HA50 PCLN ⁹ /L○○-○○	F116	Boring
HA50 PDUN ⁹ /L○○-○○	F118	Boring
HA50 PTFN ⁹ /L○○-○○	F120	Boring

J

JCET ○○○○○L-FSF	B80	Turning indexable inserts
JCET ○○○○○ML-F	B80	Turning indexable inserts
JCET ○○○○○ML-FSF	B80	Turning indexable inserts
JCET ○○○○○MR-F	B80	Turning indexable inserts
JCET ○○○○○MR-FSF	B80	Turning indexable inserts
JCET ○○○○○R-FSF	B80	Turning indexable inserts
JCGT ○○○○○L-F	B80	Turning indexable inserts
JCGT ○○○○○R-F	B80	Turning indexable inserts
JOMT ○○T○○ER-D	M210	Milling
JOMT ○○○○○ER-D	M210	Milling

K

KCGT ○○○○○ER-AM	M165	Milling
KCGT ○○○○○FR-AL	M165	Milling
KGA ⁹ /L ○○○○K-○	G64	Grooving
KGA ⁹ /L ○○○○M-○	G64	Grooving
KGAR ○○○○K-○	G64	Grooving
KGAR ○○○○M-○	G64	Grooving
KGB ⁹ /L ○○○○K-○○	G16	Grooving
KGB ⁹ /L ○○○○K○○-○○	G16	Grooving
KGB ⁹ /L ○○○○M-○○	G16	Grooving
KGB ⁹ /L ○○○○M○○-○○	G16	Grooving

T



Index

Description	Page	Category
KGBA [®] /L ○○○○H○○○	G13	Grooving
KGBA [®] /L ○○○○K○○	G13	Grooving
KGBA [®] /L ○○○○K○○JCT	G15	Grooving
KGBA [®] /L ○○○○K○○○	G13	Grooving
KGBA [®] /L ○○○○K○○○JCT	G15	Grooving
KGBA [®] /L ○○○○K○○○OT	G13	Grooving
KGBA [®] /L ○○○○M○○	G13	Grooving
KGBA [®] /L ○○○○M○○○	G13	Grooving
KGBA [®] /L ○○○○M○○○OT	G13	Grooving
KGBAS [®] /L ○○○○K○○	G14	Grooving
KGBAS [®] /L ○○○○K○○○	G14	Grooving
KGBAS [®] /L ○○○○K○○○OT	G14	Grooving
KGBAS [®] /L ○○○○M○○	G14	Grooving
KGBAS [®] /L ○○○○M○○○	G14	Grooving
KGBAS [®] /L ○○○○M○○○OT	G14	Grooving
KGBF [®] /L ○○○○JX○○F	G23	Grooving
KGBFR ○○○○JX○○FJCTM	G24	Grooving
KGBFS [®] /L ○○○○JX○○	G25	Grooving
KGBS [®] /L ○○○○K○○	G17	Grooving
KGBS [®] /L ○○○○K○○○	G17	Grooving
KGBS [®] /L ○○○○M○○	G17	Grooving
KGBS [®] /L ○○○○M○○○	G17	Grooving
KGD [®] /L ○○○○F○○	G35, H22	Grooving, Cut-Off
KGD [®] /L ○○○○F○○○	G35, H22	Grooving, Cut-Off
KGD [®] /L ○○○○F○○○OD○○	H22	Cut-Off
KGD [®] /L ○○○○H○○○	G34, H28	Grooving, Cut-Off
KGD [®] /L ○○○○JX○○	G35, H22	Grooving, Cut-Off
KGD [®] /L ○○○○JX○○○	G35, H22	Grooving, Cut-Off
KGD [®] /L ○○○○JX○○○D○○	H22	Cut-Off
KGD [®] /L ○○○○JX○○D○○	G35, H22	Grooving, Cut-Off
KGD [®] /L ○○○○JX○○○OT○○	G34, H28	Grooving, Cut-Off
KGD [®] /L ○○○○K○○○OD○○	G35, H22	Grooving, Cut-Off
KGD [®] /L ○○○○K○○○OT○○	G34, H28	Grooving, Cut-Off
KGD [®] /L ○○○○K○○○OT○○JCT	G36, H31	Grooving, Cut-Off
KGD [®] /L ○○○○M○○○OT○○	G34, H28	Grooving, Cut-Off
KGD [®] /L ○○○○P○○○OT○○	G34	Grooving
KGDF [®] /L ○○○○K○○○○B-Z	G118	Grooving
KGDF [®] /L ○○○○K○○○○B-Z	G118	Grooving
KGDF [®] /L ○○○○M○○○○B-Z	G118	Grooving
KGDF [®] /L ○○○○M○○○○B-Z	G118	Grooving
KGDI [®] /L ○○○○B○○	G91	Grooving
KGDL ○○○○JX○○○JCTM	G39, H27	Grooving, Cut-Off
KGDL ○○○○JX○○JCTM	G39, H27	Grooving, Cut-Off
KGDR ○○○○JX○○○JCTM	G39, H27	Grooving, Cut-Off
KGDR ○○○○JX○○JCTM	G39, H27	Grooving, Cut-Off
KGDS [®] /L ○○○○JX○○○B	H24	Cut-Off
KGH [®] /L ○○○○K○○	G62	Grooving
KGH [®] /L ○○○○M○○	G62	Grooving
KGH [®] /L ○○○○M○○○	G62	Grooving
KGH [®] /L ○○○○P○○	G62	Grooving
KGH [®] /L ○○○○P○○○	G62	Grooving
KGHS [®] /L ○○○○K○○	G63	Grooving
KGHS [®] /L ○○○○M○○	G63	Grooving
KGIAR ○○○○B○○	G97	Grooving
KGM [®] /L ○○○○F○○○	G55, H38	Grooving, Cut-Off
KGM [®] /L ○○○○F○○○○	G55, H38	Grooving, Cut-Off
KGM [®] /L ○○○○H○○	G56, H39	Grooving, Cut-Off
KGM [®] /L ○○○○H○○○	G57, H40	Grooving, Cut-Off
KGM [®] /L ○○○○JX○○	G55, H38	Grooving, Cut-Off
KGM [®] /L ○○○○JX○○○	G55, H38	Grooving, Cut-Off
KGM [®] /L ○○○○K○○	G56, H39	Grooving, Cut-Off
KGM [®] /L ○○○○K○○○	G57, H40	Grooving, Cut-Off

Description	Page	Category
KGM [®] /L ○○○○M○○	G56, H39	Grooving, Cut-Off
KGM [®] /L ○○○○M○○○	G57, H40	Grooving, Cut-Off
KGM [®] /L ○○○○P○○○	G57, H40	Grooving, Cut-Off
KGMMR ○○○○M○○	G58	Grooving
KGMR ○○○○K○○	G56, H39	Grooving, Cut-Off
KGMR ○○○○M○○	G56, H39	Grooving, Cut-Off
KGMR ○○○○M○○○	G57, H40	Grooving, Cut-Off
KGMSR ○○○○M○○	G58	Grooving
KGMUR ○○○○M	G60	Grooving
KGMW [®] /L ○○○○M○○	G67	Grooving
KIGBA [®] /L ○○○○○○	G89	Grooving
KIGHR ○○○○B○○	G93	Grooving
KIGM [®] /L ○○○○B○○	G95	Grooving
KIGMUR ○○○○B○○	G95	Grooving
KITG [®] /L ○○○○T○○	J39	Threading
KNMX ○○○○○○L○○	B32	Turning indexable inserts
KNMX ○○○○○○R○○	B32	Turning indexable inserts
KPKB ○○○	H49	Cut-Off
KPKB ○○○○JCT	H48	Cut-Off
KPKH [®] /L ○○○○K○○	H56	Cut-Off
KPKH [®] /L ○○○○K○○○D○○	H56	Cut-Off
KPKH [®] /L ○○○○K○○○JCT	H55	Cut-Off
KPKH [®] /L ○○○○M○○	H56	Cut-Off
KPKH [®] /L ○○○○M○○○D○○	H56	Cut-Off
KPKTB ○○○○JCT	H50	Cut-Off
KTKB ○○○○S	H60	Cut-Off
KTKB ○○○○SS	H60	Cut-Off
KTBL ○○○○S	H60	Cut-Off
KTBR ○○○○S	H60	Cut-Off
KTKF [®] /L ○○○○F○○	J29	Threading
KTKF [®] /L ○○○○F○○○SA	H18	Cut-Off
KTKF [®] /L ○○○○JX○○	E15, H9, J29	Small tools, Cut-Off, Threading
KTKF [®] /L ○○○○JX○○○SA	H18	Cut-Off
KTKF [®] /L ○○○○JX○○○SB	H18	Cut-Off
KTKF [®] /L ○○○○M○○	E15, J29	Small tools, Threading
KTFL ○○○○JX○○	E16, H10, J30	Small tools, Cut-Off, Threading
KTFL ○○○○JX○○○JCTM	H15	Cut-Off
KTFR ○○○○JX○○○Y	E16, H12, J31	Small tools, Cut-Off, Threading
KTFR ○○○○JX○○○JCTM	H15	Cut-Off
KTKH [®] /L ○○○○F○○S	H61	Cut-Off
KTKH [®] /L ○○○○H○○S	H61	Cut-Off
KTKH [®] /L ○○○○K○○S	H61	Cut-Off
KTKH [®] /L ○○○○K○○○T○○S	H61	Cut-Off
KTKH [®] /L ○○○○M○○S	H61	Cut-Off
KTKH [®] /L ○○○○M○○○T○○S	H61	Cut-Off
KTKB ○○○○	H51	Cut-Off
KTCTBF ○○○○	H51	Cut-Off
KTN ○○○○M○○	J22	Threading
KTN ○○○○P○○	J22	Threading
KTN [®] /L ○○○○H○○	J22	Threading
KTN [®] /L ○○○○JX○○○F	J22	Threading
KTN [®] /L ○○○○K○○	J22	Threading
KTNR ○○○○K○○○JCT	J23	Threading
KTNR ○○○○M○○	J22	Threading
KTNR ○○○○M○○○JCT	J23	Threading
KTNR ○○○○P○○	J22	Threading
KTNSR ○○○○H○○	J24	Threading
KTNSR ○○○○K○○	J24	Threading
KT [®] /L ○○○○F○○	J37	Threading
KT [®] /L ○○○○H○○	J37	Threading
KT [®] /L ○○○○K○○	J37	Threading
KT [®] /L ○○○○M○○	J37	Threading
KT [®] /L ○○○○F○○○F	J35	Threading



Description	Page	Category
KTTXR ○○○○JX-○○F	J35	Threading
KTTXR ○○○○K-○○F	J35	Threading
KUA-KPC4-KGD ○T○○	G40	Grooving
KUA-KPC4-KGD ⁹ /L ○T○○	G40	Grooving
KUA-KPC4-KGDR ○T○○	G40	Grooving
KUA-KPC5-KGD ○T○○	G40	Grooving
KUA-KPC5-KGD ⁹ /L ○T○○	G40	Grooving
KUA-KPC5-KGDR ○T○○	G40	Grooving
KUA-KPC6-KGD ○T○○	G40	Grooving
KUA-KPC6-KGD ⁹ /L ○T○○	G40	Grooving

L

LCMT ○○○○○○-GH-E	K52	Drilling
LCMT ○○○○○○-GH-I	K54	Drilling
LCMT ○○○○○○-GM-E	K52	Drilling
LCMT ○○○○○○-GM-I	K54	Drilling
LCMT ○○○○○○-SM-E	K52	Drilling
LCMT ○○○○○○-SM-I	K54	Drilling
LNEU ○○○○-○○	M223	Milling
LNEU ○○○○-○○○	M223	Milling
LNEU ○○○○-○○S	M223	Milling
LNEU ○○○○-○○S○	M223	Milling
LNGX ○○○○○○	M30, M172	Milling
LNGX ○○○○○○R-TT	M30, M172	Milling
LOGT ○○○○○○FR-AM	M59	Milling
LOGU ○○○○PAER-GM	M131	Milling
LOGU ○○○○○○ER-GH	M199	Milling
LOGU ○○○○○○ER-GM	M36, M131, M199	Milling
LOMU ○○○○○○ER-GH	M59, M92	Milling
LOMU ○○○○○○ER-GM	M59, M92, M192	Milling
LOMU ○○○○○○ER-SM	M59, M92	Milling
LPGT ○○○○○○ER-GM	M204	Milling

M

MCSE ○○○	M264	Milling
MCSE ○○○-W	M264	Milling
MCSE ○○○-○○D	M264	Milling
MEAS ○○-S○○-○○○T	M164	Milling
MEAS ○○-S○○-○○○T-○○○	M164	Milling
MEAS ○○○R-○○○T-M	M164	Milling
MEC ○○-M○○-○○○T	M68	Milling
MEC ○○-M○○-○○○T-○T	M68	Milling
MEC ○○-S○○-○○	M64, M65	Milling
MEC ○○-S○○-○○T	M64	Milling
MEC ○○-S○○-○○T-○	M64	Milling
MEC ○○-S○○-○○○○○○	M65	Milling
MEC ○○-S○○-○○○○○○○	M65	Milling
MEC ○○-S○○-○○○○○○T	M65	Milling
MEC ○○-S○○-○○○○○○T-○	M65	Milling
MEC ○○-W○○-○○○T○	M66	Milling
MEC ○○-W○○-○○○T○-H	M66	Milling
MEC ○○-W○○-○○○○○-H	M66	Milling
MEC ○○○R-○○○T	M67	Milling
MEC ○○○R-○○○T-M	M67	Milling
MEC ○○○R-○○○T-MN	M67	Milling
MEC ○○○R-○○○TN	M67	Milling
MEC ○○○R-○○○○T	M67	Milling
MEC ○○○R-○○○○T-M	M67	Milling
MECH ○○○S○○-○○○-○T	M94	Milling
MECH ○○○-W○○-○○○-○-○T	M94	Milling
MECH ○○○R-○○○-○T	M95	Milling
MECH ○○○R-○○○-○T-M	M95	Milling

Description	Page	Category
MECH ○○○R○○-○○○T-BT○○	M96	Milling
MECH ○○○R○○-○○○T-F	M97	Milling
MECH ○○○S○○-○○○-○-○TXT	M94	Milling
MECHT ○○-S○○-○○○-○-○T	M105	Milling
MECHT ○○R-○○○-○-○T-M	M105	Milling
MECHT ○○R-○○○○○-○-○T-M	M105	Milling
MECX ○○-S○○-○○○-○T	M76	Milling
MECX ○○-S○○-○○○○○-○-○T	M76	Milling
MECX ○○-W○○-○○○-○T	M76	Milling
MECX ○○○R-○○○-○T-M	M77	Milling
MECX ○○○R-○○○-○T-M	M77	Milling
MEF ○○-S○○	M266	Milling
METS ○○-S○○	M269	Milling
METS ○○-S○○-H	M269	Milling
MEV ○○-M○○-○○○-○T	M86	Milling
MEV ○○-S○○-○○○-○T	M84	Milling
MEV ○○-S○○-○○-○○○-○T	M84	Milling
MEV ○○○R-○○○-○T	M85	Milling
MEV ○○○R-○○○-○T-M	M85	Milling
MEW ○○-M○○-○○○-○T	M57	Milling
MEW ○○-S○○-○○○-○T	M54	Milling
MEW ○○-S○○-○○-○○○-○T	M54	Milling
MEW ○○○R-○○○-○T	M56	Milling
MEW ○○○R-○○○-○T-M	M56	Milling
MEWH ○○○-S○○-○○○-○-○T	M90	Milling
MEWH ○○○-W○○-○○○-○-○T	M90	Milling
MEWH ○○○R-○○○-○-○T-M	M91	Milling
MEWH ○○○S○○-○○○-○-○TXT	M90	Milling
MEY ○○-S○○	M208	Milling
MEY ○○-S○○-○○-W-H	M209	Milling
MEY ○○-S○○-○○○	M208	Milling
MEY ○○-S○○-○○○H	M208	Milling
MEY ○○-S○○-○○○-W-H	M209	Milling
MFAH ○○○RS-○T-M-SF	M156	Milling
MFAH ○○○RS-○T-SF	M156	Milling
MFAH ○○○RS-○T-M-SF	M156	Milling
MFAH ○○○RS-○T-SF	M156	Milling
MFH ○○-M○○-○○○-○T	M180, M191, M198, M205	Milling
MFH ○○-S○○-○○○-○T	M178, M179, M189, M196, M204	Milling
MFH ○○-S○○-○○○-○T-○○○	M178, M189, M196	Milling
MFH ○○-W○○-○○○-○T	M178, M189, M196, M204	Milling
MFH ○○○-○○○-○T	M190	Milling
MFH ○○○-○○○-○T-M	M190	Milling
MFH ○○○-○○○-○T-○○M	M190	Milling
MFH ○○○-○○○-○T	M190	Milling
MFH ○○○-○○○-○T-M	M190	Milling
MFH ○○○R-○○○-○T	M176, M177	Milling
MFH ○○○R-○○○-○T-M	M176, M177, M197	Milling
MFH ○○○R-○○○-○T-○○M	M176, M177	Milling
MFK ○○○R-○○○-○T	M40	Milling
MFK ○○○R-○○○-○T-M	M40	Milling
MFK ○○○R-○○○-○T-M-SF	M42	Milling
MFK ○○○R-○○○-○T-SF	M42	Milling
MFK ○○○R-○○○-○T	M40	Milling
MFK ○○○R-○○○-○T-M	M40	Milling
MFK ○○○R-○○○-○T-M-SF	M42	Milling
MFK ○○○R-○○○-○T-SF	M42	Milling
MFLN ○○○○○R-○T	M34, M35, M130	Milling



Description	Page	Category
MFLN ○○○○R-OT-M	M34, M35, M130	Milling
MFLN ○○○○R-OT	M34, M35, M130	Milling
MFLN ○○○○R-OT-M	M34, M35, M130	Milling
MFPN ○○○○P/L-OT	M13	Milling
MFPN ○○○○R-S-OT	M15	Milling
MFPN ○○○○R-S-OT-G	M23	Milling
MFPN ○○○○R-OT	M13	Milling
MFPN ○○○○R-OT-G	M21	Milling
MFPN ○○○○R-OT-M	M12	Milling
MFPN ○○○○R-OT-M-G	M21	Milling
MFPN ○○○○R-OT	M13	Milling
MFPN ○○○○R-OT-G	M21	Milling
MFPN ○○○○R-OT-M	M12	Milling
MFPN ○○○○R-OT-M-G	M21	Milling
MFSE ○○○○P/L-OT	M28	Milling
MFSE ○○○○P/L-OT	M28	Milling
MFSE ○○○○-OT-W-M	M28	Milling
MFSE ○○○○R-OT	M28	Milling
MFSE ○○○○R-OT-M	M28	Milling
MFSE ○○○○R-OT-W	M28	Milling
MFSE ○○○○R-OT-W-M	M28	Milling
MFSE ○○○○R-OT-M	M28	Milling
MFSE ○○○○R-OT-W	M28	Milling
MFSN ○○○○R-S-OT-G	M125	Milling
MFSN ○○○○R-OT-G	M123	Milling
MFSN ○○○○R-OT-M-G	M123	Milling
MFSN ○○○○R-OT-G	M123	Milling
MFSN ○○○○R-OT-M-G	M123	Milling
MFWN ○○○○R-S-OT	M112	Milling
MFWN ○○○○R-S-OT-OT	M118	Milling
MFWN ○○○○R-OT	M110	Milling
MFWN ○○○○R-OT-M	M109	Milling
MFWN ○○○○R-OT-MC	M109	Milling
MFWN ○○○○R-OT-OT	M117	Milling
MFWN ○○○○R-OT-M	M117	Milling
MFWN ○○○○R-OT-OT	M117	Milling
MFWN ○○○○R-OT-OT-M	M117	Milling
MFWN ○○○○R-OT	M110	Milling
MFWN ○○○○R-OT-M	M109	Milling
MGI ○○○○-A	M272	Milling
MGI ○○○○-B	M272	Milling
MGI ○○○○-C	M272	Milling
MGI ○○○○-S	M272	Milling
MGI ○○○○-SS	M272	Milling
MRF ○○-S-○	M242	Milling
MRF ○○-S-○-○○	M242	Milling
MRFW ○○-S-○	M243	Milling
MRFW ○○-S-○-○○	M243	Milling
MRW ○○-S-○-○-OT	M250	Milling
MRW ○○-S-○-○-OT-○○	M250	Milling
MRW ○○-W-○-○-OT	M250	Milling
MRW ○○○R-○-OT	M248	Milling
MRW ○○○R-○-OT-M	M248	Milling
MRW ○○○R-○-OT	M248	Milling
MRW ○○○R-○-OT-M	M248	Milling
MRX ○○-M-○-○-OT	M259	Milling
MRX ○○-S-○-○-OT	M258	Milling
MRX ○○-S-○-○-OT-○○	M258	Milling
MRX ○○-W-○-○-OT	M258	Milling
MRX ○○○R-○-OT	M255	Milling
MRX ○○○R-○-OT-M	M255	Milling
MSR ○○○R-BT-○	M144	Milling

Description	Page	Category
MSR ○○○R-○	M143	Milling
MSR ○○○R-○-○○○○	M143	Milling
MSR ○○○R-○M	M143	Milling
MSRS ○○○○R-○-OT	M137	Milling
MSRS ○○○○R-○-OT-M	M137	Milling
MSRS ○○○○R-OT	M49	Milling
MSRS ○○○○R-OT-M	M49	Milling
MSRS ○○○○R-OT	M49	Milling
MSRS ○○○○R-OT-M	M49	Milling
MSTA ○○N○○○-OT	M217	Milling
MSTA ○○N○○○-OT	M217	Milling
MSTB ○○○AN○○○○-OT	M220	Milling
MSTB ○○○SN○○○○-OT	M222	Milling
MSTB ○○○AN○○○○-OT	M221	Milling
MSTC ○○○AL○○○○-○○	M232	Milling
MSTC ○○○AL○○○○-○○-OT	M232	Milling
MSTC ○○○AL○○○○-○○-OT	M232	Milling
MSTC ○○○AN○○○○-○○	M227	Milling
MSTC ○○○AN○○○○-○○-OT	M227	Milling
MSTC ○○○AR○○○○-○○	M230	Milling
MSTC ○○○AR○○○○-○○-OT	M230	Milling
MSTC ○○○AR○○○○-○○-OT	M230	Milling
MSTC ○○○SL○○○○-○○-OT	M233	Milling
MSTC ○○○SL○○○○-○○-OT	M233	Milling
MSTC ○○○SN○○○○-○○-OT	M228	Milling
MSTC ○○○SR○○○○-○○-OT	M231	Milling
MSTC ○○○SR○○○○-○○-OT	M231	Milling
MVG ○○○○	M274	Milling
MVLN ⁹ /L ○○○○K-○○	D36	External turning
MVLN ⁹ /L ○○○○M-○○	D36	External turning
MVVNN ○○○○K-○○	D37	External turning
MVVNN ○○○○M-○○	D37	External turning

N

NDCT ○○○○○FR	M150	Milling
NDCT ○○○○○TR	M150	Milling
NDCT ○○○○○TRX	M150	Milling
NDCW ○○○○○FRX	C62, M150, M280	CBN & PCD Tools, Milling
NDCW ○○○○○FRX-NE	C62, M150, M280	CBN & PCD Tools, Milling
NDCW ○○○○○TR	M150	Milling
NDCW ○○○○○TRX	M150	Milling

O

OFMT ○○○○○EN-GT	M47	Milling
OFMT ○○○○○EN-SH	M47	Milling
OFMT ○○○○○ER-SH	M47	Milling

P

PCLN ⁹ /L ○○○○H-○○	D10	External turning
PCLN ⁹ /L ○○○○K-○○	D10	External turning
PCLN ⁹ /L ○○○○M-○○	D10	External turning
PCLN ⁹ /L ○○○○P-○○	D10	External turning
PCLNR ○○○○JX-○○FF	E63	Small tools
PDHN ⁹ /L ○○○○K-○○	D17	External turning
PDHN ⁹ /L ○○○○M-○○	D17	External turning
PDJN ⁹ /L ○○○○H-○○	D16	External turning
PDJN ⁹ /L ○○○○K-○○	D16	External turning
PDJN ⁹ /L ○○○○M-○○	D16	External turning
PDJN ⁹ /L ○○○○M-○○U	D16	External turning
PDJN ⁹ /L ○○○○P-○○	D16	External turning
PDJN ⁹ /L ○○○○P-○○U	D16	External turning
PKM ○○○L-○○○PM-○D	H46	Cut-Off

T



Index

Description	Page	Category
PKM ○○N-○○PH	H46	Cut-Off
PKM ○○N-○○PM	H46	Cut-Off
PKM ○○R-○○PM-○D	H46	Cut-Off
PNEA ○○○XNTN-T○○○○○	M44	Milling
PNEG ○○○XNEN-GL	M44	Milling
PNEG ○○○XNER-W	M44	Milling
PNEG ○○○XNTR-T○○○○○	M44	Milling
PNEG ○○○XNTR-T○○○○○W	M44	Milling
PNEU ○○○ANEL-GL	M16	Milling
PNEU ○○○ANER-GL	M16	Milling
PNEU ○○○ANER-W	M16	Milling
PNMG ○○○XNEN-GH	M44	Milling
PNMG ○○○XNEN-GM	M44	Milling
PNMU ○○○ANEL-GM	M16	Milling
PNMU ○○○ANER-GH	M16	Milling
PNMU ○○○ANER-GM	M16	Milling
PNMU ○○○ANER-SM	M16	Milling
PNMU ○○○XNER-GH	M24	Milling
PNMU ○○○XNER-GM	M24	Milling
PNMU ○○○XNER-SM	M24	Milling
PRGC [®] YL ○○○K-○○	D40	External turning
PRGC [®] YL ○○○M-○○	D40	External turning
PRGCR ○○○M-○○BE	D67	External turning
PRGN [®] YL ○○○K-○○	D42	External turning
PRGN [®] YL ○○○M-○○	D42	External turning
PRXC [®] YL ○○○K-○○	D40	External turning
PRXC [®] YL ○○○M-○○	D40	External turning
PRXC [®] YL ○○○Q-○○	D40	External turning
PSBN [®] YL ○○○K-○○	D19	External turning
PSBN [®] YL ○○○M-○○	D19	External turning
PSDNN ○○○H-○○	D21	External turning
PSDNN ○○○K-○○	D21	External turning
PSDNN ○○○M-○○	D21	External turning
PSKN [®] YL ○○○K-○○	D20	External turning
PSKN [®] YL ○○○M-○○	D20	External turning
PSSN [®] YL ○○○H-○○	D20	External turning
PSSN [®] YL ○○○K-○○	D20	External turning
PSSN [®] YL ○○○M-○○	D20	External turning
PTFN [®] YL ○○○F-○○	D25	External turning
PTFN [®] YL ○○○H-○○	D25	External turning
PTFN [®] YL ○○○K-○○	D25	External turning
PTFN [®] YL ○○○M-○○	D25	External turning
PTGN [®] YL ○○○F-○○	D24	External turning
PTGN [®] YL ○○○H-○○	D24	External turning
PTGN [®] YL ○○○K-○○	D24	External turning
PTGN [®] YL ○○○M-○○	D24	External turning
PTLNR ○○○JX-○○FF	E64	Small tools
PVLN [®] YL ○○○M-○○Q	D38	External turning
PVPN [®] YL ○○○K-○○Q	D38	External turning
PVPN [®] YL ○○○M-○○Q	D38	External turning
PVVNN ○○○K-○○Q	D39	External turning
PVVNN ○○○M-○○Q	D39	External turning
PWLN [®] YL ○○○H-○○	D45	External turning
PWLN [®] YL ○○○K-○○	D45	External turning
PWLN [®] YL ○○○M-○○	D45	External turning

R

RBG ○○K○○○○○	B123	Turning indexable inserts
RCGX ○○○M-○○AQ	B81	Turning indexable inserts
RCGX ○○○○○E○○○	B123	Turning indexable inserts
RCGX ○○○○○P○○○○○	B123	Turning indexable inserts
RCGX ○○○○○T○○○○○	B123	Turning indexable inserts
RCMT ○○○M-○○BB	B109	Turning indexable inserts
RCMX ○○○M○	B81	Turning indexable inserts

Description	Page	Category
RDFG ○○FR	M244	Milling
RDGT ○○○○M○ER-GM	M260	Milling
RDGT ○○○○M○ER-SM	M260	Milling
RDHX ○○T○M○T	M281	Milling
RDHX ○○○○M○T	M281	Milling
RDMT ○○T○M○H	M281	Milling
RDMT ○○○○M○EN-GH	M260	Milling
RDMT ○○○○M○ER-GM	M260	Milling
RNGN ○○○○○E○○○	B116	Turning indexable inserts
RNGN ○○○○○K○○○○○	B116	Turning indexable inserts
RNGN ○○○○○S○○○○○	B116	Turning indexable inserts
RNGN ○○○○○T○○○○○	B116	Turning indexable inserts
RNMG ○○○○○○	B33	Turning indexable inserts
RNMN ○○○○○S○○○○○	C17	CBN & PCD Tools
ROMU ○○○○M○ER-GH	M251	Milling
ROMU ○○○○M○ER-GM	M251	Milling
ROMU ○○○○M○ER-SM	M251	Milling
RPGN ○○○○○E○○○	B120	Turning indexable inserts
RPGN ○○○○○T○○○○○	B120	Turning indexable inserts
RPGT ○○T○M○ER-GM	M260	Milling
RPGT ○○T○M○ER-SM	M260	Milling
RPGT ○○○○M○ER-GM	M260	Milling
RPGT ○○○○M○ER-SM	M260	Milling
RPGX ○○○○○E○○○	B123	Turning indexable inserts
RPGX ○○○○○T○○○○○	B123	Turning indexable inserts
RPMT ○○T○M○	M281	Milling
RPMT ○○T○M○EN-GH	M260	Milling
RPMT ○○T○M○ER-GM	M260	Milling
RPMT ○○○○M○	M281	Milling
RPMT ○○○○M○-BB	B109	Turning indexable inserts
RPMT ○○○○M○-H	M281	Milling
RPMT ○○○○M○EN-GH	M260	Milling
RPMT ○○○○M○ER-GM	M260	Milling

S

S045X- SCLCR○○○○EZP	F31	Boring
S050X- SCLCR○○○○EZP	F31	Boring
S050X- SWUBR○○○○EZP	F36	Boring
S060X- SCLCR○○○○EZP	F31	Boring
S060X- SWUBR○○○○EZP	F36	Boring
S06H- STL [®] YL○○○○A	F81	Boring
S06H- STL [®] YL○○○○AE	F80	Boring
S070X- SCLCR○○○○EZP	F31	Boring
S070X- STLB [®] ○○○○EZP	F33	Boring
S070X- SWUBR○○○○EZP	F36	Boring
S080X- SCLCR○○○○EZP	F31	Boring
S080X- STLPR○○○○EZP	F33	Boring
S08X- SCLC [®] YL○○○○A	F61	Boring
S08X- STLC [®] YL○○○○A	F89	Boring
S08X- STLP [®] YL○○○○A	F81	Boring
S08X- SWUB [®] YL○○○○A	F101	Boring
S10H- SCLC [®] YL○○○○AE	F60	Boring
S10H- SWUB [®] YL○○○○A	F101	Boring
S10H- SWUB [®] YL○○○○AE	F100	Boring
S10L- SCLC [®] YL○○○○A	F61	Boring
S10L- SCLP [®] YL○○○○A	F64	Boring
S10L- SDQC [®] YL○○○○A	F71	Boring
S10L- SDUC [®] YL○○○○A	F67	Boring
S10L- SDZC [®] YL○○○○A	F75	Boring
S10L- STLC [®] YL○○○○A	F89	Boring
S10L- STLP [®] YL○○○○A	F81	Boring
S10L- SVPC [®] YL○○○○A	F94	Boring
S10L- SWUB [®] YL○○○○A	F101	Boring
S10M- STWP [®] YL○○○○E	F84, J47	Boring, Threading



Description	Page	Category
S10M-STWPR	F85, J47	Boring, Threading
S12F-KGBFL	G26	Grooving
S12F-KTTXL	J35	Threading
S12F-SCLCL	E54	Small tools
S12F-SDLCL	E56	Small tools
S12F-STWL	G107	Grooving
S12F-STWR	F57	Boring
S12F-SVNR	F50	Boring
S12F-SVNR	F54	Boring
S12F-SVUCL	E59	Small tools
S12L-CTUPR	F113	Boring
S12M-SCLC	F61	Boring
S12M-SCLP	F64	Boring
S12M-SDQC	F71	Boring
S12M-SDUC	F67	Boring
S12M-SDZC	F75	Boring
S12M-STLC	F89	Boring
S12M-STLP	F81	Boring
S12M-STWP	F84, J47	Boring, Threading
S12M-STWPR	F85, J47	Boring, Threading
S12M-SVJC	F91	Boring
S12M-SVJP	F91	Boring
S12M-SVPB	F94	Boring
S12M-SVUC	F96	Boring
S12M-SVZC	F99	Boring
S12M-SWUP	F101	Boring
S14G-SVNR	F50	Boring
S14G-SVNR	F54	Boring
S14H-KGBFL	G26	Grooving
S14H-KTTXL	J35	Threading
S14H-SCLCL	E54	Small tools
S14H-SDLCL	E56	Small tools
S14H-SDUCL	E55	Small tools
S14H-STWL	G107	Grooving
S14H-STWR	F57	Boring
S14H-SVUCL	E59	Small tools
S15F-KGBFL	G26	Grooving
S15F-KTTXL	J35	Threading
S15F-SCLCL	E54	Small tools
S15F-SDLCL	E56	Small tools
S15F-SDUCL	E55	Small tools
S15F-STWL	G107	Grooving
S15F-STWR	F57	Boring
S15F-SVUCL	E59	Small tools
S16F-KGBFL	G26	Grooving
S16F-KTNL	J25	Threading
S16F-KTTXL	J35	Threading
S16F-SCLCL	E54	Small tools
S16F-SDLCL	E56	Small tools
S16F-STWL	G107	Grooving
S16F-STWR	F57	Boring
S16F-SVUCL	E59	Small tools
S16H-SVNR	F50	Boring
S16H-SVNR	F54	Boring
S16M-PCLN	F126	Boring
S16M-PTUN	F138	Boring
S16M-PWLN	F140	Boring
S16N-CSKPR	F112	Boring
S16N-CTUP	F113	Boring
S16Q-SCLC	F61	Boring
S16Q-SCLP	F64	Boring
S16Q-SDQC	F71	Boring
S16Q-SDUC	F67	Boring
S16Q-SDZC	F75	Boring

Description	Page	Category
S16Q-SSKPR	F111	Boring
S16Q-STLC	F89	Boring
S16Q-STLP	F81	Boring
S16Q-STWPR	F85, J47	Boring, Threading
S16Q-SVJC	F91	Boring
S16Q-SVPB	F94	Boring
S16Q-SVUB	F96	Boring
S16Q-SVZB	F99	Boring
S16Q-SWUP	F101	Boring
S16R-STWP	F84, J47	Boring, Threading
S19G-KGBFL	G26	Grooving
S19G-KTTXL	J35	Threading
S19G-SCLCL	E54	Small tools
S19G-SDLCL	E56	Small tools
S19G-SDUCL	E55	Small tools
S19G-STWL	G107	Grooving
S19G-STWR	F57	Boring
S19G-SVUB	E58	Small tools
S19G-SVUCL	E59	Small tools
S19H-SVNR	F50	Boring
S19H-SVNR	F51	Boring
S19H-SVNR	F55	Boring
S19H-SVNR	F54	Boring
S19K-KGBFL	G26	Grooving
S19K-KTNL	J25	Threading
S19K-KTTXL	J35	Threading
S19K-SCLCL	E54	Small tools
S19K-SDLCL	E56	Small tools
S19K-SDUCL	E55	Small tools
S19K-STWL	G107	Grooving
S19K-STWR	F57	Boring
S19K-SVUB	E58	Small tools
S19K-SVUCL	E59	Small tools
S19N-SVNR	F50	Boring
S19N-SVNR	F54	Boring
S20-DRV	K56, K58, K60, K62, K64	Drilling
S20-DRXR	K92, K94, K96, K97	Drilling
S20-DRZ	K78, K80, K82	Drilling
S20-DRZ	K78, K80, K82	Drilling
S20G-KGBFL	G26	Grooving
S20G-KTTXL	J35	Threading
S20G-SCLCL	E54	Small tools
S20G-SDLCL	E56	Small tools
S20G-SDUCL	E55	Small tools
S20G-STWL	G107	Grooving
S20G-STWR	F57	Boring
S20G-SVUB	E58	Small tools
S20G-SVUCL	E59	Small tools
S20H-SVNR	F50	Boring
S20H-SVNR	F51	Boring
S20H-SVNR	F55	Boring
S20H-SVNR	F54	Boring
S20K-KGBFL	G26	Grooving
S20K-KTNL	J25	Threading
S20K-KTTXL	J35	Threading
S20K-SCLCL	E54	Small tools
S20K-SDLCL	E56	Small tools
S20K-SDUCL	E55	Small tools
S20K-STWL	G107	Grooving
S20K-STWR	F57	Boring

Description	Page	Category
S20K-SVUBL	E58	Small tools
S20K-SVUCL	E59	Small tools
S20Q-CSKPR	F112	Boring
S20Q-CTUP	F113	Boring
S20Q-PCLN	F126	Boring
S20Q-PDUN	F128	Boring
S20Q-PTUN	F138	Boring
S20Q-PWLN	F140	Boring
S20R-SCLC	F61	Boring
S20R-SCLP	F64	Boring
S20R-SDQC	F71	Boring
S20R-SDUC	F67	Boring
S20R-SDZC	F75	Boring
S20R-STLC	F89	Boring
S20R-STLP	F81	Boring
S20R-STWPR	F85, J47	Boring, Threading
S20R-SVJB	F91	Boring
S20R-SVPB	F94	Boring
S20R-SVUB	F96	Boring
S20R-SVZB	F99	Boring
S20R-SWUP	F101	Boring
S20X-STWP	F84, J47	Boring, Threading
S22K-KGBFL	G26	Grooving
S22K-KTNL	J25	Threading
S22K-SDLCL	E56	Small tools
S22K-SDUCL	E55	Small tools
S22K-STWL	G107	Grooving
S22K-STWR	F57	Boring
S22K-SVNR	F51	Boring
S22K-SVNR	F55	Boring
S25-DRV	K56, K58, K60, K62, K64	Drilling
S25-DRXR	K92, K94, K96, K97	Drilling
S25-DRZ	K78, K80, K82	Drilling
S25-DRZ	K82	Drilling
S25-DRZ	K78, K80, K82	Drilling
S25-DRZ	K82	Drilling
S25.0G-SVNR	F51	Boring
S25.0G-SVNR	F55	Boring
S25.0H-KGBFL	G26	Grooving
S25.0H-KTNL	J25	Threading
S25.0H-KTTXL	J35	Threading
S25.0H-SCLCL	E54	Small tools
S25.0H-SDLCL	E56	Small tools
S25.0H-SDUCL	E55	Small tools
S25.0H-SVUBL	E58	Small tools
S25.0H-SVUCL	E59	Small tools
S25.0J-STWL	G107	Grooving
S25.0J-STWR	F57	Boring
S25H-SVNR	F50	Boring
S25H-SVNR	F54	Boring
S25K-KGBFL	G26	Grooving
S25K-KTNL	J25	Threading
S25K-KTTXL	J35	Threading
S25K-SCLCL	E54	Small tools
S25K-SDLCL	E56	Small tools
S25K-SDUCL	E55	Small tools
S25K-STWL	G107	Grooving
S25K-STWR	F57	Boring
S25K-SVUBL	E58	Small tools
S25K-SVUCL	E59	Small tools

Description	Page	Category
S25Q-SVNR	F50	Boring
S25Q-SVNR	F54	Boring
S25R-PCLN	F126	Boring
S25R-PDQN	F133	Boring
S25R-PDUN	F128, F132	Boring
S25R-PDZN	F134	Boring
S25R-PTUN	F138	Boring
S25R-PWLN	F140	Boring
S25S-SCLC	F61	Boring
S25S-SCLP	F64	Boring
S25S-SDQC	F71	Boring
S25S-SDUC	F67	Boring
S25S-SDZC	F75	Boring
S25S-STLP	F81	Boring
S25S-SVJB	F91	Boring
S25S-SVPB	F94	Boring
S25S-SVUB	F96	Boring
S25S-SVZB	F99	Boring
S25S-WWLN	F143	Boring
S25X-CSKPR	F112	Boring
S25X-CTUN	F146	Boring
S25X-CTUP	F113	Boring
S25X-STWP	F84	Boring
S32-DRV	K56, K59, K60, K62, K64	Drilling
S32-DRXR	K92, K94, K96, K97	Drilling
S32-DRZ	K79, K81	Drilling
S32-DRZ	K81, K83, K84	Drilling
S32-DRZ	K79	Drilling
S32-DRZ	K83	Drilling
S32S-CTUP	F113	Boring
S32S-PCLN	F126	Boring
S32S-PDQN	F133	Boring
S32S-PDUN	F128, F132	Boring
S32S-PDZN	F134	Boring
S32S-PTUN	F138	Boring
S32S-PWLN	F140	Boring
S32S-SVJB	F91	Boring
S32S-SVPB	F94	Boring
S32S-SVUB	F96	Boring
S32S-SVZB	F99	Boring
S32S-WWLN	F143	Boring
S40-DRV	K57, K59, K61, K62, K63, K64	Drilling
S40-DRXR	K92, K94, K96, K97	Drilling
S40-DRZ	K79, K81	Drilling
S40-DRZ	K79, K81, K83, K84	Drilling
S40T-CELNR	F145	Boring
S40T-PCLN	F126	Boring
S40T-PDQN	F133	Boring
S40T-PDUN	F132	Boring
S40T-PDZN	F134	Boring
S40T-PTUN	F138	Boring
S40T-PWLN	F140	Boring
S40T-SVJB	F91	Boring
S40X-CTUP	F113	Boring
S50-DRV	K61, K63, K64	Drilling
S50-DRW	K102, K103, K104, K105	Drilling

T



Index

Description	Page	Category
S50- DRZ○○○○-○○CR	K85	Drilling
SABSR ○○○○F-○○F	E20	Small tools
SABSR ○○○○JX-○○F	E20	Small tools
SABSR ○○○○K-○○F	E20	Small tools
SABWR ○○○○JX-○○F	E21, E22	Small tools
SABWR ○○○○K-○○F	E21, E22	Small tools
SCLC [®] /L ○○○○F-○○	E28	Small tools
SCLC [®] /L ○○○○F-○○FF	E26	Small tools
SCLC [®] /L ○○○○H-○○	E28	Small tools
SCLC [®] /L ○○○○JX-○○FF	E26	Small tools
SCLC [®] /L ○○○○K-○○	E28	Small tools
SCLC [®] /L ○○○○M-○○	E28	Small tools
SCLCR ○○○○JX-○○FFJCTM	E27	Small tools
SCLNR ○○○○F-○○FF	E60	Small tools
SCLNR ○○○○K-○○FF	E60	Small tools
SCMT ○○T○○○HQ	B82	Turning indexable inserts
SCMT ○○○○○○-GH-E	K53	Drilling
SCMT ○○○○○○-GH-I	K55	Drilling
SCMT ○○○○○○-GM-E	K53	Drilling
SCMT ○○○○○○-GM-I	K55	Drilling
SCMT ○○○○○○-SM-E	K53	Drilling
SCMT ○○○○○○-SM-I	K55	Drilling
SCMT ○○○○○○-XM-E	K53	Drilling
SCMT ○○○○○○-XM-I	K55	Drilling
SDCT ○○○○○○EN-SD	M237	Milling
SDCT ○○○○○○FN-SE	M237	Milling
SDET ○○○○○○SN-SB	M237	Milling
SDET ○○○○○○SR-SB ○○○○○○SL-SB	M237	Milling
SDJC [®] /L ○○○○F-○○	E31	Small tools
SDJC [®] /L ○○○○F-○○FF	E29	Small tools
SDJC [®] /L ○○○○H-○○	E31	Small tools
SDJC [®] /L ○○○○JX-○○FF	E29	Small tools
SDJC [®] /L ○○○○K-○○	E31	Small tools
SDJC [®] /L ○○○○M-○○	E31	Small tools
SDJCR ○○○○JX-○○-F○○	E23	Small tools
SDJCR ○○○○JX-○○FF-Y	E32	Small tools
SDJCR ○○○○JX-○○FFJCTM	E30	Small tools
SDJCR ○○○○JX○○○○JCTM	E30	Small tools
SDKN ○○○○AUFN	C62, M276, M280	CBN & PCD Tools, Milling
SDKN ○○○○AUFN-NE	C62, M280	CBN & PCD Tools, Milling
SDKN ○○○○AUTN	M276	Milling
SDKR ○○○○AUEN-S	M276	Milling
SDKW ○○T○○○FN	M264	Milling
SDKW ○○T○○○TN	M264	Milling
SDKW ○○○○AESN	M281	Milling
SDKW ○○○○AETN	M281	Milling
SDLC [®] /L ○○○○F-○○FF	E34	Small tools
SDLC [®] /L ○○○○H-○○FF	E34	Small tools
SDLC [®] /L ○○○○JX-○○FF	E34	Small tools
SDLNR ○○○○F-○○FF	E61	Small tools
SDLNR ○○○○K-○○FF	E61	Small tools
SDLP [®] /L ○○○○F-○○FF	E37	Small tools
SDLP [®] /L ○○○○JX-○○FF	E37	Small tools
SDMR ○○○○AUER-H	M276	Milling
SDMT ○○T○○○C	M264	Milling
SDMT ○○○○AESR-H	M281	Milling
SDMT ○○○○○○E-K	M270	Milling
SDNC [®] /L ○○○○JX-○○F	E35	Small tools
SDNCN ○○○○F-○○	E35	Small tools
SDNCN ○○○○H-○○	E35	Small tools
SDNCN ○○○○JX-○○	E35	Small tools
SDXC [®] /L ○○○○JX-○○	E34	Small tools
SEEN ○○○○AFFN	C62, M280	CBN & PCD Tools, Milling

Description	Page	Category
SEEN ○○○○AFFN-NE	C62, M280	CBN & PCD Tools, Milling
SEEN ○○○○AFFR-W	M276	Milling
SEEN ○○○○AFTN	M276	Milling
SEEN ○○○○AFTR-W	M276	Milling
SEET ○○T○○AGFN-AL	M30	Milling
SEET ○○T○○AGSN-GL	M30	Milling
SEET ○○T○○AGSN-SL	M30	Milling
SEKN ○○○○AFFN	M276	Milling
SEKN ○○○○AFTN	M276	Milling
SEKN ○○○○EFTR	M276	Milling
SEKR ○○○○AFEN-S	M276	Milling
SEKT ○○○○AFEN-S	M281	Milling
SEKW ○○○○AFTN	M281	Milling
SEKW ○○○○○○FN	M264	Milling
SEKW ○○○○○○TN	M264	Milling
SEMR ○○○○AFER-H	M276	Milling
SEMT ○○○○○○C	M264	Milling
SF12- DRA○○○M-○	K25, K26, K27	Drilling
SF12- DRA○○○M-○.○	K24	Drilling
SF12- DRC○○○M-○	K42, K43, K44	Drilling
SF16- DRA○○○M-○	K25, K26, K27	Drilling
SF16- DRA○○○M-○.○	K24	Drilling
SF16- DRA○○○M-○○	K28	Drilling
SF16- DRC○○○M-○	K42, K43, K44	Drilling
SF20- DRA○○○M-○	K25, K26, K27	Drilling
SF20- DRA○○○M-○.○	K24	Drilling
SF20- DRA○○○M-○○	K28	Drilling
SF20- DRC○○○M-○	K42, K43, K44	Drilling
SF25- DRA○○○M-○	K25, K26, K27	Drilling
SF25- DRA○○○M-○.○	K24	Drilling
SF25- DRA○○○M-○○	K28	Drilling
SF25- DRC○○○M-○	K42, K43, K44	Drilling
SF32- DRA○○○M-○	K25, K26, K27	Drilling
SHE ○○○○-○○	K72	Drilling
SIGC [®] /L ○○○○-EH	G76	Grooving
SIGC [®] /L ○○○○-WH	G77	Grooving
SIGC [®] /L ○○○○-WH-L○○	G77	Grooving
SIGC [®] /L ○○○○-WH-L○○○	G77	Grooving
SIGE [®] /L ○○○○A-EH	G81	Grooving
SIGE [®] /L ○○○○A-WH	G82	Grooving
SIGE [®] /L ○○○○B-EH	G81	Grooving
SIGE [®] /L ○○○○B-WH	G82	Grooving
SIGE [®] /L ○○○○C-EH	G81	Grooving
SIGE [®] /L ○○○○C-WH	G82	Grooving
SIGE [®] /L ○○○○D-EH	G81	Grooving
SIGE [®] /L ○○○○E-EH	G81	Grooving
SIGER ○○○○B-WH-○○	G83	Grooving
SIGER ○○○○C-WH-○○	G83	Grooving
SIN [®] /L ○○○○S-○○	J26	Threading
SIN [®] /L ○○○○S-○○E	J26	Threading
SINR ○○○○S-○○	J26	Threading
SINR ○○○○S-○○E	J26	Threading
SLT ○○-○○SKB	M218	Milling
SLT ○○-○○SKD	M218	Milling
SNCN ○○○○XNTN	M278	Milling
SNGA ○○○○○○	B37	Turning indexable inserts
SNGA ○○○○○○MEF	C12	CBN & PCD Tools



Description	Page	Category
SNGA ○○○○○○S○○○○○	B117	Turning indexable inserts
SNGA ○○○○○○S○○○○○ME	C12	CBN & PCD Tools
SNGA ○○○○○○S○○○○○MEH	C12	CBN & PCD Tools
SNGA ○○○○○○S○○○○○MEP	C12	CBN & PCD Tools
SNGA ○○○○○○S○○○○○MET	C12	CBN & PCD Tools
SNGA ○○○○○○T○○○○○	B117	Turning indexable inserts
SNGA ○○○○○○T○○○○○ME	C12	CBN & PCD Tools
SNGG ○○○○○○L-B	B37	Turning indexable inserts
SNGG ○○○○○○L-C	B37	Turning indexable inserts
SNGG ○○○○○○L-○R	B37	Turning indexable inserts
SNGG ○○○○○○R-B	B37	Turning indexable inserts
SNGG ○○○○○○R-C	B37	Turning indexable inserts
SNGG ○○○○○○R-○R	B37	Turning indexable inserts
SNGN ○○○○○○S○○○○○	B117	Turning indexable inserts
SNGN ○○○○○○T○○○○○	B117	Turning indexable inserts
SNKN ○○○○XNTN	M278	Milling
SNMA ○○○○○○	B37	Turning indexable inserts
SNMA ○○○○○○S○○○○○	B117	Turning indexable inserts
SNMF ○○○○XNTN	M278	Milling
SNMF ○○○○○○	B109	Turning indexable inserts
SNMG ○○○○○○	B34	Turning indexable inserts
SNMG ○○○○○○C	B36	Turning indexable inserts
SNMG ○○○○○○GC	B37	Turning indexable inserts
SNMG ○○○○○○HQ	B34	Turning indexable inserts
SNMG ○○○○○○KG	B36	Turning indexable inserts
SNMG ○○○○○○KH	B36	Turning indexable inserts
SNMG ○○○○○○L-C	B37	Turning indexable inserts
SNMG ○○○○○○MQ	B36	Turning indexable inserts
SNMG ○○○○○○MS	B36	Turning indexable inserts
SNMG ○○○○○○MU	B36	Turning indexable inserts
SNMG ○○○○○○PG	B34	Turning indexable inserts
SNMG ○○○○○○PH	B35	Turning indexable inserts
SNMG ○○○○○○PQ	B34	Turning indexable inserts
SNMG ○○○○○○PS	B34	Turning indexable inserts
SNMG ○○○○○○PT	B34	Turning indexable inserts
SNMG ○○○○○○R-C	B37	Turning indexable inserts
SNMG ○○○○○○SG	B36	Turning indexable inserts
SNMG ○○○○○○XP	B35	Turning indexable inserts
SNMG ○○○○○○XQ	B35	Turning indexable inserts
SNMG ○○○○○○XS	B35	Turning indexable inserts
SNMG ○○○○○○ZS	B37	Turning indexable inserts
SNMM ○○○○○○PX	B35	Turning indexable inserts
SNMN ○○○○○○	B38, M278	Turning indexable inserts, Milling
SNMN ○○○○○○S○○○○○	C18	CBN & PCD Tools
SNMN ○○○○○○T○○○○○	B117	Turning indexable inserts
SNMU ○○○○○○EN-GH	M126	Milling
SNMU ○○○○○○EN-GM	M126	Milling
SNMU ○○○○○○EN-SM	M126	Milling
SOMT ○○○○○○ER-FL	M181	Milling
SOMT ○○○○○○ER-GH	M181	Milling
SOMT ○○○○○○ER-GM	M181	Milling
SOMT ○○○○○○ER-LD	M181	Milling
SPCN ○○○○EDTR	M277	Milling
SPCN ○○○○EETR○	M277	Milling
SPCN ○○○○XPTR	M277	Milling
SPCT ○○T○○○EN-SD	M236	Milling
SPCT ○○T○○○FN-SE	M236	Milling
SPEN ○○○○EER	M277	Milling
SPEN ○○○○EESR	M277	Milling
SPET ○○T○○○E%L-SB	M236	Milling
SPET ○○T○○○E%L-SB	M236	Milling
SPGH ○○○○○○L	B82	Turning indexable inserts
SPGN ○○○○○○	B83, C43, M277	Turning indexable inserts, CBN & PCD Tools, Milling

Description	Page	Category
SPGN ○○○○○○NE	C43	CBN & PCD Tools
SPGN ○○○○○○S○○○○○	B121	Turning indexable inserts
SPGN ○○○○○○T○○○○○	B121	Turning indexable inserts
SPGR ○○○○○○%L	B83	Turning indexable inserts
SPGR ○○○○○○R	B83	Turning indexable inserts
SPKN ○○○○EDER	M277	Milling
SPKN ○○○○EDFR	M277	Milling
SPKN ○○○○EDTR	M277	Milling
SPKN ○○○○EDT%L	M277	Milling
SPKN ○○○○XETR	M277	Milling
SPKN ○○○○XPFR	M277	Milling
SPKN ○○○○XPTR	M277	Milling
SPKR ○○○○EDER-S	M277	Milling
SPMN ○○○○○○	B83, M277	Turning indexable inserts, Milling
SPMR ○○○○EDER-H	M277	Milling
SPMR ○○○○○○	B83	Turning indexable inserts
SPMR ○○○○○○G	B83	Turning indexable inserts
SPMT ○○○○EDER-NB○	M50	Milling
SPMT ○○○○EDER-NB○P	M50	Milling
SPMT ○○○○EDER-V	M50	Milling
SPMT ○○○○EDSR-NB○T	M50	Milling
SPMT ○○○○○○E-Z	M267	Milling
SPMT ○○○○○○EN-NB○	M138	Milling
SPMT ○○○○○○EN-NB○P	M138	Milling
SPMT ○○○○○○EN-V	M138	Milling
SRCP%L ○○○○B-○-○A○	F114	Boring
SS10- DRA○○○M-○	K19, K20, K21	Drilling
SS10- DRA○○○M-○,○	K18	Drilling
SS10- DRC○○○M-○	K37, K38, K39	Drilling
SS12- DRA○○○M-○	K19, K20, K21	Drilling
SS12- DRA○○○M-○,○	K18	Drilling
SS12- DRC○○○M-○	K37, K38, K39	Drilling
SS14- DRA○○○M-○	K19, K20, K21	Drilling
SS14- DRA○○○M-○,○	K18	Drilling
SS14- DRC○○○M-○	K37, K38, K39	Drilling
SS16- DRA○○○M-○	K19, K20, K21	Drilling
SS16- DRA○○○M-○,○	K18	Drilling
SS16- DRC○○○M-○	K37, K38, K39	Drilling
SS18- DRA○○○M-○	K19, K20, K21	Drilling
SS18- DRA○○○M-○,○	K18	Drilling
SS18- DRC○○○M-○	K37, K38, K39	Drilling
SS20- DRA○○○M-○	K19, K20, K21	Drilling
SS20- DRA○○○M-○,○	K18	Drilling
SS20- DRC○○○M-○	K37, K38, K39	Drilling
SS25- DRA○○○M-○	K19, K20, K21	Drilling
SS25- DRA○○○M-○,○	K18	Drilling
SS25- DRC○○○M-○	K37, K38, K39	Drilling
SS32- DRA○○○M-○	K19, K20, K21	Drilling
SS32- DRA○○○M-○,○	K18	Drilling
SS32- DRC○○○M-○	K37, K38, K39	Drilling
STGC%L ○○○○E-○	E38	Small tools
STGC%L ○○○○F-○	E38	Small tools

Description	Page	Category
STGC ⁹ /L ○○○○H-○○	E38	Small tools
STGC ⁹ /L ○○○○K-○○	E38	Small tools
STGC ⁹ /L ○○○○M-○○	E38	Small tools
STGP ⁹ /L ○○○○F-○○	E39	Small tools
STGP ⁹ /L ○○○○H-○○	E39	Small tools
STGPR ○○○○E-○○	E39	Small tools
STLNR ○○○○F-○○FF	E62	Small tools
STLNR ○○○○K-○○FF	E62	Small tools
STWL ○○○○F-○○	G106	Grooving
STWL ○○○○K-○○	G106	Grooving
STWL ○○○○M-○○	G106	Grooving
STWR ○○○○F-○○	F56	Boring
STWSR ○○○○F-○○T	G109	Grooving
STWSR ○○○○JX-○○T	G109	Grooving
SVJB ⁹ /L ○○○○JX-○○FF	E40	Small tools
SVJB ⁹ /L ○○○○K-○○	E41	Small tools
SVJB ⁹ /L ○○○○K-○○N	E41	Small tools
SVJB ⁹ /L ○○○○M-○○	E41	Small tools
SVJB ⁹ /L ○○○○M-○○N	E41	Small tools
SVJBR ○○○○JX-○○FFICTM	E41	Small tools
SVJC ⁹ /L ○○○○F-○○FF	E44	Small tools
SVJC ⁹ /L ○○○○JX-○○FF	E44	Small tools
SVJP ⁹ /L ○○○○F-○○FF	E47	Small tools
SVJP ⁹ /L ○○○○JX-○○FF	E47	Small tools
SVJPR ○○○○JX-○○FFICTM	E47	Small tools
SVLC ⁹ /L ○○○○F-○○FF	E44	Small tools
SVLC ⁹ /L ○○○○JX-○○FF	E44	Small tools
SVLP ⁹ /L ○○○○F-○○FF	E48	Small tools
SVLP ⁹ /L ○○○○JX-○○FF	E48	Small tools
SVLPR ○○○○JX-○○F○○	E24	Small tools
SVNR ○○○○H-○○N	F48	Boring
SVNR ○○○○K-○○N	F48	Boring
SVNR ○○○○M-○○N	F48	Boring
SVNSR ○○○○K-○○○○N	F49	Boring
SVNSR ○○○○K-○○○○XN	F53	Boring
SVNSR ○○○○M-○○○○N	F49	Boring
SVNSR ○○○○M-○○○○XN	F53	Boring
SVPB ⁹ /L ○○○○JX-○○	E42	Small tools
SVPB ⁹ /L ○○○○K-○○	E42	Small tools
SVPB ⁹ /L ○○○○K-○○N	E42	Small tools
SVPB ⁹ /L ○○○○M-○○	E42	Small tools
SVPB ⁹ /L ○○○○M-○○N	E42	Small tools
SVPCR ○○○○F-○○FF	E45	Small tools
SVPCR ○○○○JX-○○FF	E45	Small tools
SVPPR ○○○○F-○○FF	E49	Small tools
SVPPR ○○○○JX-○○FF	E49	Small tools
SVVBN ○○○○F-○○	E43	Small tools
SVVBN ○○○○H-○○	E43	Small tools
SVVBN ○○○○JX-○○	E43	Small tools
SVVBN ○○○○K-○○	E43	Small tools
SVVBN ○○○○K-○○N	E43	Small tools
SVVBN ○○○○M-○○	E43	Small tools
SVVBN ○○○○M-○○N	E43	Small tools
SVVCN ○○○○JX-○○	E46	Small tools
SZLB ⁹ /L ○○○○K-○○C	E52	Small tools
SZLB ⁹ /L ○○○○M-○○C	E52	Small tools
SZPB ⁹ /L ○○○○K-○○C	E52	Small tools
SZPB ⁹ /L ○○○○M-○○C	E52	Small tools
SZVBN ○○○○K-○○C	E53	Small tools
SZVBN ○○○○M-○○C	E53	Small tools

T

TBET ○○○○○ML	B84	Turning indexable inserts
TBET ○○○○○MR	B84	Turning indexable inserts

Description	Page	Category
TBET ○○○○○ML	B84	Turning indexable inserts
TBET ○○○○○MR	B84	Turning indexable inserts
TBGN ○○○○○S○○○○○	B122	Turning indexable inserts
TBGN ○○○○○T○○○○○	C25	CBN & PCD Tools
TBGT ○○○○○CF	B84	Turning indexable inserts
TBGT ○○○○○L	B84	Turning indexable inserts
TBGT ○○○○○MFP-PF	B84	Turning indexable inserts
TBGT ○○○○○MP-CF	B84	Turning indexable inserts
TBGT ○○○○○R	B84	Turning indexable inserts
TBGT ○○○○○L	B84	Turning indexable inserts
TBGW ○○○○○	B84, C44	Turning indexable inserts, CBN & PCD Tools
TBGW ○○○○○NE	C44	CBN & PCD Tools
TBMT ○○○○○	C44	CBN & PCD Tools
TBMT ○○○○○DP	B84	Turning indexable inserts
TBMT ○○○○○NE	C44	CBN & PCD Tools
TCET ○○○○○FL-USF	B85	Turning indexable inserts
TCET ○○○○○FR-USF	B85	Turning indexable inserts
TCET ○○○○○MFR-USF	B85	Turning indexable inserts
TCET ○○○○○FL-USF	B85	Turning indexable inserts
TCET ○○○○○FR-USF	B85	Turning indexable inserts
TCET ○○○○○MFR-USF	B85	Turning indexable inserts
TCGT ○○○○○EL-U	B86	Turning indexable inserts
TCGT ○○○○○ER-U	B86	Turning indexable inserts
TCGT ○○○○○FL-U	B86	Turning indexable inserts
TCGT ○○○○○FR-U	B86	Turning indexable inserts
TCGT ○○○○○L-A○	B87	Turning indexable inserts
TCGT ○○○○○MEL-U	B86	Turning indexable inserts
TCGT ○○○○○MER-U	B86	Turning indexable inserts
TCGT ○○○○○MFL-U	B86	Turning indexable inserts
TCGT ○○○○○MFR-U	B86	Turning indexable inserts
TCGT ○○○○○R-A○	B87	Turning indexable inserts
TCGT ○○○○○FR-U	B86	Turning indexable inserts
TCGT ○○○○○MFL-U	B86	Turning indexable inserts
TCGT ○○○○○MFR-U	B86	Turning indexable inserts
TCGW ○○○○○	B87	Turning indexable inserts
TCGW ○○○○○NE	C45	CBN & PCD Tools
TCGW ○○○○○SE	C45	CBN & PCD Tools
TCMT ○○T○○○HQ	B85	Turning indexable inserts
TCMT ○○○○○	C45	CBN & PCD Tools
TCMT ○○○○○HQ	B85	Turning indexable inserts
TCMT ○○○○○NE	C45	CBN & PCD Tools
TCMT ○○○○○SE	C45	CBN & PCD Tools
TCMX ○○○○○WP	B85	Turning indexable inserts
TEEN ○○○○PTFR	C62, M280	CBN & PCD Tools, Milling
TEEN ○○○○PTFR-NE	C62, M280	CBN & PCD Tools, Milling
TEEN ○○○○PTTR	M279	Milling
TEKN ○○○○PTFR	C62, M279	Milling
TEKN ○○○○PTFR-NE	C62	CBN & PCD Tools
TEKN ○○○○PTTR	M279	Milling
TEKR ○○○○PTFR-S	M279	Milling
TEMR ○○○○PTFR-H	M279	Milling
TGF32R ○○○○○	C52, G68	CBN & PCD Tools, Grooving
TGF32 ⁹ /L ○○○○○	G68	Grooving
TKF ○○R○○○-GTP	40, E12	Small tools
TKF12 ⁹ /L... ○○○○F-○○	H9	Cut-Off
TKF12 ⁹ /L... ○○○○JX-○○	H9	Cut-Off
TKF12 ⁹ /L... ○○○○M-○○	H9	Cut-Off
TKF12L ○○○-AS	C57	CBN & PCD Tools
TKF12R ○○○-AGT	C57, E14	CBN & PCD Tools, Small tools
TKF12R ○○○-AS	C57, E14	CBN & PCD Tools, Small tools
TKF12 ⁹ /L ○○○-AS	E14	Small tools
TKF12R ○○○-NB	C57, E14, H6	CBN & PCD Tools, Small tools, Cut-Off
TKF12R ○○○-NB○○DR	H7	Cut-Off



Description	Page	Category
TKF12R ○○○-S	H6	Cut-Off
TKF12R ○○○-S-○○DR	H6	Cut-Off
TKF12R ○○○-S	H6	Cut-Off
TKF12R ○○○-T	H6	Cut-Off
TKF12R ○○○-T-○○DR	H6	Cut-Off
TKF16 ⁹ /L... ○○○○F-○○	H9	Cut-Off
TKF16 ⁹ /L... ○○○○JX-○○	H9	Cut-Off
TKF16 ⁹ /L... ○○○○M-○○	H9	Cut-Off
TKF16L ○○○-AS	C57	CBN & PCD Tools
TKF16R ○○○-AS	C57	CBN & PCD Tools
TKF16R ○○○-AS TKF○○L ○○○-AS	E14	Small tools
TKF16R ○○○-NB	H8	Cut-Off
TKF16R ○○○-NB-○○DR	H8	Cut-Off
TKF16R ○○○-S	H8	Cut-Off
TKF16R ○○○-S-○○DR	H8	Cut-Off
TKF16R ○○○-T	H8	Cut-Off
TKF16R ○○○-T-○○DR	H8	Cut-Off
TKFB ○○○○○○○MR	30, E12	, Small tools
TKFB ○○○○○○○GQ	30, E12	, Small tools
TKFB ○○○○○○○M	30, E12	, Small tools
TKFB ○○○○○○○P-GQ	30, E12	, Small tools
TKFT12	J28	Threading
TKFT12 LA○○○○○	J28	Threading
TKFT12 LB○○○○○	J28	Threading
TKFT12 LN○○○○○	J28	Threading
TKL ○	H58	Cut-Off
TKL ○-P	H58	Cut-Off
TKL ○,○	H58	Cut-Off
TKN ○	H58	Cut-Off
TKN ○-P	H58	Cut-Off
TKN ○,○	H58	Cut-Off
TKN ○,○-P	H58	Cut-Off
TKR ○	H58	Cut-Off
TKR ○-P	H58	Cut-Off
TKR ○,○	H58	Cut-Off
TKR ○,○-P	H58	Cut-Off
TNEG ○○○○○L-SSF	B45	Turning indexable inserts
TNEG ○○○○○R-SSF	B45	Turning indexable inserts
TNGA ○○○○○○	B44	Turning indexable inserts
TNGA ○○○○○MEF	C13	CBN & PCD Tools
TNGA ○○○○○ME○	C13	CBN & PCD Tools
TNGA ○○○○○S○○○○○	B118	Turning indexable inserts
TNGA ○○○○○S○○○○○ME	C13	CBN & PCD Tools
TNGA ○○○○○S○○○○○MEH	C13	CBN & PCD Tools
TNGA ○○○○○S○○○○○MEP	C13	CBN & PCD Tools
TNGA ○○○○○S○○○○○MET	C13	CBN & PCD Tools
TNGA ○○○○○T○○○○○	B118	Turning indexable inserts
TNGA ○○○○○T○○○○○ME	C13	CBN & PCD Tools
TNGG ○○○○○AH	B44	Turning indexable inserts
TNGG ○○○○○FP-TK	B42	Turning indexable inserts
TNGG ○○○○○L	B46	Turning indexable inserts
TNGG ○○○○○L-A○	B44	Turning indexable inserts
TNGG ○○○○○L-B	B45	Turning indexable inserts
TNGG ○○○○○L-C	B46	Turning indexable inserts
TNGG ○○○○○L-S	B45	Turning indexable inserts
TNGG ○○○○○L-○○R	B46	Turning indexable inserts
TNGG ○○○○○M-SK	B42	Turning indexable inserts
TNGG ○○○○○MFP-SK	B42	Turning indexable inserts
TNGG ○○○○○R	B46	Turning indexable inserts
TNGG ○○○○○R-A○	B44	Turning indexable inserts
TNGG ○○○○○R-B	B45	Turning indexable inserts
TNGG ○○○○○R-C	B46	Turning indexable inserts
TNGG ○○○○○R-S	B45	Turning indexable inserts
TNGG ○○○○○R-○○R	B46	Turning indexable inserts

Description	Page	Category
TNGG ○○○○○TK	B42	Turning indexable inserts
TNGN ○○○○○S○○○○○	B118	Turning indexable inserts
TNGN ○○○○○T○○○○○	B118	Turning indexable inserts
TNGU ○○○○○MER-U	B57	Turning indexable inserts
TNGU ○○○○○MFR-F	B57	Turning indexable inserts
TNGU ○○○○○MFR-U	B57	Turning indexable inserts
TNGU ○○○○○MFR-F	B57	Turning indexable inserts
TNMA ○○○○○○	B44	Turning indexable inserts
TNMG ○○○○○○	B40	Turning indexable inserts
TNMG ○○○○○AH	B44	Turning indexable inserts
TNMG ○○○○○C	B43	Turning indexable inserts
TNMG ○○○○○CQ	B39	Turning indexable inserts
TNMG ○○○○○GC	B43	Turning indexable inserts
TNMG ○○○○○GP	B39	Turning indexable inserts
TNMG ○○○○○GS	B40	Turning indexable inserts
TNMG ○○○○○GT	B40	Turning indexable inserts
TNMG ○○○○○HQ	B39	Turning indexable inserts
TNMG ○○○○○KG	B43	Turning indexable inserts
TNMG ○○○○○KH	B43	Turning indexable inserts
TNMG ○○○○○KQ	B43	Turning indexable inserts
TNMG ○○○○○L-C	B46	Turning indexable inserts
TNMG ○○○○○L-ST	B43	Turning indexable inserts
TNMG ○○○○○MQ	B42	Turning indexable inserts
TNMG ○○○○○MS	B42	Turning indexable inserts
TNMG ○○○○○MU	B42	Turning indexable inserts
TNMG ○○○○○PG	B40	Turning indexable inserts
TNMG ○○○○○PH	B41	Turning indexable inserts
TNMG ○○○○○PP	B39	Turning indexable inserts
TNMG ○○○○○PQ	B39	Turning indexable inserts
TNMG ○○○○○PS	B40	Turning indexable inserts
TNMG ○○○○○PT	B40	Turning indexable inserts
TNMG ○○○○○R-C	B46	Turning indexable inserts
TNMG ○○○○○R-LD	B42	Turning indexable inserts
TNMG ○○○○○R-ST	B43	Turning indexable inserts
TNMG ○○○○○SG	B43	Turning indexable inserts
TNMG ○○○○○TK	B42	Turning indexable inserts
TNMG ○○○○○XF	B41	Turning indexable inserts
TNMG ○○○○○XP	B41	Turning indexable inserts
TNMG ○○○○○XQ	B41	Turning indexable inserts
TNMG ○○○○○XS	B41	Turning indexable inserts
TNMG ○○○○○ZS	B43	Turning indexable inserts
TNMM ○○○○○M	C36	CBN & PCD Tools
TNMM ○○○○○M-NE	C36	CBN & PCD Tools
TNMM ○○○○○M-SE	C36	CBN & PCD Tools
TNMM ○○○○○PX	B41	Turning indexable inserts
TNMM ○○○○○S○○○○○	C19	CBN & PCD Tools
TNMX ○○○○○WF	B39	Turning indexable inserts
TOMT ○○○○○ER-GM	M87	Milling
TOMT ○○○○○ER-SM	M87	Milling
TPEH ○○○○○ML-P	B92	Turning indexable inserts
TPEH ○○○○○MR-P	B92	Turning indexable inserts
TPET ○○○○○FL-USF	B94	Turning indexable inserts
TPET ○○○○○FR-USF	B94	Turning indexable inserts
TPET ○○○○○L-FSF	B92	Turning indexable inserts
TPET ○○○○○MFL-USF	B94	Turning indexable inserts
TPET ○○○○○MFR-USF	B94	Turning indexable inserts
TPET ○○○○○ML-FSF	B92	Turning indexable inserts
TPET ○○○○○MR-FSF	B92	Turning indexable inserts
TPET ○○○○○R-FSF	B92	Turning indexable inserts
TPET ○○○○○L-FSF	B92	Turning indexable inserts
TPET ○○○○○ML-FSF	B92	Turning indexable inserts
TPET ○○○○○R-FSF	B92	Turning indexable inserts
TPGB ○○○○○○	B94, C46	Turning indexable inserts, CBN & PCD Tools

T

Index

Description	Page	Category
TPGB ○○○○○MEF	C23	CBN & PCD Tools
TPGB ○○○○○NE	C46	CBN & PCD Tools
TPGB ○○○○○SE	C46	CBN & PCD Tools
TPGB ○○○○○S○○○○MES	C23	CBN & PCD Tools
TPGB ○○○○○S○○○○MET	C23	CBN & PCD Tools
TPGB ○○○○○S○○○○SET	C23	CBN & PCD Tools
TPGB ○○○○○T○○○○ME	C23	CBN & PCD Tools
TPGB ○○○○○T○○○○SE	C23	CBN & PCD Tools
TPGB ○○○○○○	B94	Turning indexable inserts
TPGH ○○○○○L	B90	Turning indexable inserts
TPGH ○○○○○L-H	B93	Turning indexable inserts
TPGH ○○○○○ML	B91	Turning indexable inserts
TPGH ○○○○○ML-H	B93	Turning indexable inserts
TPGH ○○○○○MR	B91	Turning indexable inserts
TPGH ○○○○○R	B90	Turning indexable inserts
TPGH ○○○○○R-H	B93	Turning indexable inserts
TPGN ○○○○○○	B96, C48, M279, M280	Turning indexable inserts, CBN & PCD Tools, Milling
TPGN ○○○○○NE	C48	CBN & PCD Tools
TPGN ○○○○○SE	C48	CBN & PCD Tools
TPGN ○○○○○S○○○○○	B122	Turning indexable inserts
TPGN ○○○○○S○○○○SET	C25	CBN & PCD Tools
TPGN ○○○○○T○○○○○	B122	Turning indexable inserts
TPGN ○○○○○T○○○○ME	C25	CBN & PCD Tools
TPGN ○○○○○T○○○○SE	C25	CBN & PCD Tools
TPGR ○○○○○L-A	B96	Turning indexable inserts
TPGR ○○○○○L-B	B96	Turning indexable inserts
TPGR ○○○○○L-C	B96	Turning indexable inserts
TPGR ○○○○○L-F	B96	Turning indexable inserts
TPGR ○○○○○R-A	B96	Turning indexable inserts
TPGR ○○○○○R-B	B96	Turning indexable inserts
TPGR ○○○○○R-C	B96	Turning indexable inserts
TPGR ○○○○○R-F	B96	Turning indexable inserts
TPGT ○○○○○AP	B94	Turning indexable inserts
TPGT ○○○○○CF	B88	Turning indexable inserts
TPGT ○○○○○L-H	B93	Turning indexable inserts
TPGT ○○○○○MFP-PF	B88	Turning indexable inserts
TPGT ○○○○○MP-CF	B88	Turning indexable inserts
TPGW ○○○○○S○○○○MET	C24	CBN & PCD Tools
TPGW ○○○○○T○○○○ME	C24	CBN & PCD Tools
TPGW ○○○○○T○○○○SE	C24	CBN & PCD Tools
TPKN ○○○○PDR	M279	Milling
TPKN ○○○○PDR	M279	Milling
TPKR ○○○○PDR-S	M279	Milling
TPMH ○○○○○○	C47	CBN & PCD Tools
TPMH ○○○○○L-NE	C47	CBN & PCD Tools
TPMH ○○○○○NE	C47	CBN & PCD Tools
TPMH ○○○○○SE	C47	CBN & PCD Tools
TPMN ○○○○○○	B96, M279	Turning indexable inserts, Milling
TPMR ○○○○PDR-H	M279	Milling
TPMR ○○○○○○	B95	Turning indexable inserts
TPMR ○○○○○DP	B95	Turning indexable inserts
TPMR ○○○○○G	B95	Turning indexable inserts
TPMR ○○○○○GP	B95	Turning indexable inserts
TPMR ○○○○○HQ	B95	Turning indexable inserts
TPMT ○○○○○APD	C47	CBN & PCD Tools
TPMT ○○○○○GP	B89	Turning indexable inserts
TPMT ○○○○○HQ	B89	Turning indexable inserts
TPMT ○○○○○PP	B88	Turning indexable inserts
TPMT ○○○○○XP	B89	Turning indexable inserts
TPMT ○○○○○XQ	B89	Turning indexable inserts
TPMX ○○○○○L-WP	B88	Turning indexable inserts
TPMX ○○○○○R-WP	B88	Turning indexable inserts
TPMX ○○○○○WP	B88	Turning indexable inserts

Description	Page	Category
TT32L ○○○○	J36, J38	Threading
TT43ER ○○○M ○○○M ○○○M ○○○M	J36	Threading
TT43 ³ /L ○○○○	J36, J38	Threading
TTX32R ○○○○	J34	Threading
TTX32R ○○○○S	J34	Threading
TWBR... ○○○○K-○○	F56	Boring
TWBR... ○○○○M-○○	F56	Boring
TWBTR ○○○○○○○○	F58	Boring
TWFGTR ○○○○	G108	Grooving

V

VBET ○○○○○L-FSF	B98	Turning indexable inserts
VBET ○○○○○ML-F	B98	Turning indexable inserts
VBET ○○○○○ML-FSF	B98	Turning indexable inserts
VBET ○○○○○ML-Y	B99	Turning indexable inserts
VBET ○○○○○MR-F	B98	Turning indexable inserts
VBET ○○○○○MR-FSF	B98	Turning indexable inserts
VBET ○○○○○MR-Y	B99	Turning indexable inserts
VBET ○○○○○R-FSF	B98	Turning indexable inserts
VBET ○○○○○L-FSF	B98	Turning indexable inserts
VBET ○○○○○ML-F	B98	Turning indexable inserts
VBET ○○○○○ML-FSF	B98	Turning indexable inserts
VBET ○○○○○ML-Y	B99	Turning indexable inserts
VBET ○○○○○MR-F	B98	Turning indexable inserts
VBET ○○○○○MR-FSF	B98	Turning indexable inserts
VBET ○○○○○MR-Y	B99	Turning indexable inserts
VBET ○○○○○R-FSF	B98	Turning indexable inserts
VBGT ○○○○○L-F	B98	Turning indexable inserts
VBGT ○○○○○L-Y	B99	Turning indexable inserts
VBGT ○○○○○ML-F	B98	Turning indexable inserts
VBGT ○○○○○ML-Y	B99	Turning indexable inserts
VBGT ○○○○○MR-F	B98	Turning indexable inserts
VBGT ○○○○○MR-Y	B99	Turning indexable inserts
VBGT ○○○○○R-F	B98	Turning indexable inserts
VBGT ○○○○○R-Y	B99	Turning indexable inserts
VBGT ○○○○○L-F	B98	Turning indexable inserts
VBGT ○○○○○L-Y	B99	Turning indexable inserts
VBGT ○○○○○ML-F	B98	Turning indexable inserts
VBGT ○○○○○ML-Y	B99	Turning indexable inserts
VBGT ○○○○○MR-F	B98	Turning indexable inserts
VBGT ○○○○○MR-Y	B99	Turning indexable inserts
VBGT ○○○○○R-F	B98	Turning indexable inserts
VBGT ○○○○○R-Y	B99	Turning indexable inserts
VBGT ○○○○○L-F	B98	Turning indexable inserts
VBGT ○○○○○L-Y	B99	Turning indexable inserts
VBGT ○○○○○ML-F	B98	Turning indexable inserts
VBGT ○○○○○ML-Y	B99	Turning indexable inserts
VBGT ○○○○○MR-F	B98	Turning indexable inserts
VBGT ○○○○○MR-Y	B99	Turning indexable inserts
VBGT ○○○○○R-F	B98	Turning indexable inserts
VBGT ○○○○○R-Y	B99	Turning indexable inserts
VBGW ○○○○○MEF	C26	CBN & PCD Tools
VBGW ○○○○○S○○○○MES	C26	CBN & PCD Tools
VBGW ○○○○○S○○○○MET	C26	CBN & PCD Tools
VBGW ○○○○○S○○○○SET	C26	CBN & PCD Tools
VBGW ○○○○○T○○○○ME	C26	CBN & PCD Tools
VBGW ○○○○○T○○○○SE	C26	CBN & PCD Tools
VBMT ○○○○○○	C49	CBN & PCD Tools
VBMT ○○○○○GP	B97	Turning indexable inserts
VBMT ○○○○○HQ	B97	Turning indexable inserts
VBMT ○○○○○NE	C49	CBN & PCD Tools
VBMT ○○○○○PP	B97	Turning indexable inserts
VBMT ○○○○○SE	C49	CBN & PCD Tools
VBMT ○○○○○VF	B97	Turning indexable inserts
VCET ○○○○○ML-F	B101	Turning indexable inserts
VCET ○○○○○ML-Y	B101	Turning indexable inserts
VCET ○○○○○MR-F	B101	Turning indexable inserts
VCET ○○○○○MR-Y	B101	Turning indexable inserts
VCET ○○○○○ML-Y	B101	Turning indexable inserts
VCET ○○○○○ML-Y	B101	Turning indexable inserts
VCET ○○○○○MR-Y	B101	Turning indexable inserts
VCET ○○○○○MR-Y	B101	Turning indexable inserts
VCET ○○○○○MR-Y	B101	Turning indexable inserts
VCET ○○○○○AH	B101	Turning indexable inserts



Description	Page	Category
VCGT ○○○○○○AP	B101	Turning indexable inserts
VCGT ○○○○○○L-A○	B101	Turning indexable inserts
VCGT ○○○○○○MFP-GF	B100	Turning indexable inserts
VCGT ○○○○○○MFP-SKS	B100	Turning indexable inserts
VCGT ○○○○○○MP-CF	B100	Turning indexable inserts
VCGT ○○○○○○R-A○	B101	Turning indexable inserts
VCGW ○○○○○○S○○○○○MET	C27	CBN & PCD Tools
VCGW ○○○○○○S○○○○○SET	C27	CBN & PCD Tools
VCGW ○○○○○○T○○○○○ME	C27	CBN & PCD Tools
VCGW ○○○○○○T○○○○○SE	C27	CBN & PCD Tools
VCMT ○○○○○○	C50	CBN & PCD Tools
VCMT ○○○○○○HQ	B100	Turning indexable inserts
VCMT ○○○○○○NE	C50	CBN & PCD Tools
VCMT ○○○○○○PP	B100	Turning indexable inserts
VCMT ○○○○○○SE	C50	CBN & PCD Tools
VCMT ○○○○○○VF	B100	Turning indexable inserts
VNBR ○○○○-○○	F45	Boring
VNBR ○○○○-○○NB	C59, F46	CBN & PCD Tools, Boring
VNBR ○○○○-○○S	F44	Boring
VNBR ○○○○-○○○	F45	Boring
VNBR ○○○○-○○○NB	F46	Boring
VNBR ○○○○-○○○S	F44	Boring
VNBR ○○○○○○S	F44	Boring
VNBR ○○○○○○S	F44	Boring
VNBR ○○○○○○S	F44	Boring
VNBR ○○○○○○S	F44	Boring
VNBR ○○○○○○S	F44	Boring
VNBR ○○○○○○S	F44	Boring
VNBTR ○○○○-○○	F47	Boring
VNBTR ○○○○-○○○	F47	Boring
VNBXR ○○○○-○○S	F52	Boring
VNBXR ○○○○-○○○S	F52	Boring
VNBXR ○○○○-○○○S	F52	Boring
VNBXR ○○○○-○○○S	F52	Boring
VNFGR ○○○○-○○NB	G61, G105	CBN & PCD Tools, Grooving
VNFGR ○○○○-○○	G105	Grooving
VNGA ○○○○○○	B49	Turning indexable inserts
VNGA ○○○○○○MEF	C14	CBN & PCD Tools
VNGA ○○○○○○ME○	C14	CBN & PCD Tools
VNGA ○○○○○○S○○○○○	B119	Turning indexable inserts
VNGA ○○○○○○S○○○○○ME	C14	CBN & PCD Tools
VNGA ○○○○○○S○○○○○MEH	C14	CBN & PCD Tools
VNGA ○○○○○○S○○○○○MEP	C14	CBN & PCD Tools
VNGA ○○○○○○S○○○○○MET	C14	CBN & PCD Tools
VNGA ○○○○○○T○○○○○	B119	Turning indexable inserts
VNGA ○○○○○○T○○○○○ME	C14	CBN & PCD Tools
VNGG ○○○○○○%L	B49	Turning indexable inserts
VNGG ○○○○○○%L-S	B49	Turning indexable inserts
VNGG ○○○○○○M-SK	B48	Turning indexable inserts
VNGG ○○○○○○MFP-SK	B48	Turning indexable inserts
VNGR ○○○○-○○NB	G60	CBN & PCD Tools
VNGR ○○○○-○○NB	G73	Grooving
VNGR ○○○○-○○	G73	Grooving
VNMA ○○○○○○S○○○○○	B119	Turning indexable inserts
VNMG ○○○○○○	B47	Turning indexable inserts
VNMG ○○○○○○GP	B47	Turning indexable inserts
VNMG ○○○○○○HQ	B47	Turning indexable inserts
VNMG ○○○○○○KG	B48	Turning indexable inserts
VNMG ○○○○○○KH	B48	Turning indexable inserts
VNMG ○○○○○○L-VC	B47	Turning indexable inserts
VNMG ○○○○○○MQ	B48	Turning indexable inserts
VNMG ○○○○○○MS	B48	Turning indexable inserts
VNMG ○○○○○○MU	B48	Turning indexable inserts
VNMG ○○○○○○PP	B47	Turning indexable inserts
VNMG ○○○○○○PQ	B47	Turning indexable inserts
VNMG ○○○○○○R-VC	B47	Turning indexable inserts

Description	Page	Category
VNMG ○○○○○○SG	B48	Turning indexable inserts
VNMG ○○○○○○TN-V	B47	Turning indexable inserts
VNMG ○○○○○○VF	B47	Turning indexable inserts
VNMM ○○○○○○M	C37	CBN & PCD Tools
VNMM ○○○○○○M-NE	C37	CBN & PCD Tools
VNMM ○○○○○○M-SE	C37	CBN & PCD Tools
VNTR ○○○-○○	J44	Threading
VPET ○○○○○○FL-USF	B104	Turning indexable inserts
VPET ○○○○○○FR-USF	B104	Turning indexable inserts
VPET ○○○○○○L-FSF	B103	Turning indexable inserts
VPET ○○○○○○MFL-J	B104	Turning indexable inserts
VPET ○○○○○○MFL-U	B104	Turning indexable inserts
VPET ○○○○○○MFL-USF	B104	Turning indexable inserts
VPET ○○○○○○MFR-J	B104	Turning indexable inserts
VPET ○○○○○○MFR-U	B104	Turning indexable inserts
VPET ○○○○○○MFR-USF	B104	Turning indexable inserts
VPET ○○○○○○ML-F	B103	Turning indexable inserts
VPET ○○○○○○ML-FSF	B103	Turning indexable inserts
VPET ○○○○○○MR-F	B103	Turning indexable inserts
VPET ○○○○○○MR-FSF	B103	Turning indexable inserts
VPET ○○○○○○R-FSF	B103	Turning indexable inserts
VPET ○○○○○○FL-USF	B104	Turning indexable inserts
VPET ○○○○○○FR-USF	B104	Turning indexable inserts
VPET ○○○○○○MFL-U	B104	Turning indexable inserts
VPET ○○○○○○MFR-J	B104	Turning indexable inserts
VPET ○○○○○○MFR-U	B104	Turning indexable inserts
VPET ○○○○○○MFR-USF	B104	Turning indexable inserts
VPET ○○○○○○MR-F	B103	Turning indexable inserts
VPET ○○○○○○MR-FSF	B103	Turning indexable inserts
VPET ○○○○○○R-FSF	B103	Turning indexable inserts
VPGT ○○○○○○CF	B102	Turning indexable inserts
VPGT ○○○○○○CK	B102	Turning indexable inserts
VPGT ○○○○○○MFP-GF	B102	Turning indexable inserts
VPGT ○○○○○○MFP-SKS	B102	Turning indexable inserts
VPGT ○○○○○○MP-CF	B102	Turning indexable inserts
VPGT ○○○○○○MP-CK	B102	Turning indexable inserts

W

WBET ○○○○○○ML-F	B105	Turning indexable inserts
WBET ○○○○○○ML-P	B106	Turning indexable inserts
WBET ○○○○○○MR-F	B105	Turning indexable inserts
WBET ○○○○○○MR-P	B106	Turning indexable inserts
WBET ○○○○○○ML-F	B105	Turning indexable inserts
WBGD ○○○○○○L-F	B106	Turning indexable inserts
WBGD ○○○○○○MFPL-PF	B105	Turning indexable inserts
WBGD ○○○○○○MFPR-PF	B105	Turning indexable inserts
WBGD ○○○○○○MPL-CF	B105	Turning indexable inserts
WBGD ○○○○○○MPR-CF	B105	Turning indexable inserts
WBGD ○○○○○○R-F	B106	Turning indexable inserts
WBGD ○○○○○○L-F	B106	Turning indexable inserts
WBGW ○○○○○○L	B106	Turning indexable inserts
WBGW ○○○○○○S○○○○○LSET	C28	CBN & PCD Tools
WBGW ○○○○○○T○○○○○L-SE	C28	CBN & PCD Tools
WBMT ○○○○○○L	C51	CBN & PCD Tools
WBMT ○○○○○○L-DP	B105	Turning indexable inserts
WBMT ○○○○○○L-NE	C51	CBN & PCD Tools
WBMT ○○○○○○L-SE	C51	CBN & PCD Tools
WBMT ○○○○○○R-DP	B105	Turning indexable inserts
WCMT ○○T○○○	K101	Drilling
WCMT ○○○○○○	K101	Drilling
WNEU ○○○○○○EN-GL	M113	Milling
WNGA ○○○○○○MEF	C15	CBN & PCD Tools
WNGA ○○○○○○S○○○○○ME	C15	CBN & PCD Tools
WNGA ○○○○○○S○○○○○MET	C15	CBN & PCD Tools

Description	Page	Category
WNGA	○○○○○○T○○○○○ME	C15 CBN & PCD Tools
WNGG	○○○○○○AH	B54 Turning indexable inserts
WNGG	○○○○○○L	B54 Turning indexable inserts
WNGG	○○○○○○L-S	B54 Turning indexable inserts
WNGG	○○○○○○R	B54 Turning indexable inserts
WNGG	○○○○○○R-S	B54 Turning indexable inserts
WNGG	○○○○○○TK	B52 Turning indexable inserts
WNGT	○○○○○○FN-AM	M113 Milling
WNMA	○○○○○○	B54 Turning indexable inserts
WNMG	○○T○○○HQ	B51 Turning indexable inserts
WNMG	○○○○○○	B52 Turning indexable inserts
WNMG	○○○○○○C	B54 Turning indexable inserts
WNMG	○○○○○○CJ	B51 Turning indexable inserts
WNMG	○○○○○○CQ	B51 Turning indexable inserts
WNMG	○○○○○○GC	B54 Turning indexable inserts
WNMG	○○○○○○GP	B50 Turning indexable inserts
WNMG	○○○○○○GS	B51 Turning indexable inserts
WNMG	○○○○○○GT	B52 Turning indexable inserts
WNMG	○○○○○○HQ	B51 Turning indexable inserts
WNMG	○○○○○○KG	B53 Turning indexable inserts
WNMG	○○○○○○KH	B53 Turning indexable inserts
WNMG	○○○○○○KQ	B53 Turning indexable inserts
WNMG	○○○○○○MQ	B53 Turning indexable inserts
WNMG	○○○○○○MS	B53 Turning indexable inserts
WNMG	○○○○○○MU	B53 Turning indexable inserts
WNMG	○○○○○○PG	B51 Turning indexable inserts
WNMG	○○○○○○PH	B52 Turning indexable inserts
WNMG	○○○○○○PP	B50 Turning indexable inserts
WNMG	○○○○○○PQ	B50 Turning indexable inserts
WNMG	○○○○○○PS	B51 Turning indexable inserts
WNMG	○○○○○○PT	B51 Turning indexable inserts
WNMG	○○○○○○SG	B53 Turning indexable inserts
WNMG	○○○○○○TK	B52 Turning indexable inserts
WNMG	○○○○○○WE	B50 Turning indexable inserts
WNMG	○○○○○○WF	B50 Turning indexable inserts
WNMG	○○○○○○WP	B50 Turning indexable inserts
WNMG	○○○○○○WQ	B50 Turning indexable inserts
WNMG	○○○○○○XP	B52 Turning indexable inserts
WNMG	○○○○○○XQ	B52 Turning indexable inserts
WNMG	○○○○○○XS	B52 Turning indexable inserts
WNMG	○○○○○○ZS	B54 Turning indexable inserts
WNMM	○○○○○○M-NE	C38 CBN & PCD Tools
WNMM	○○○○○○M-SE	C38 CBN & PCD Tools
WNMU	○○○○○○EN-GH	M113, M119 Milling
WNMU	○○○○○○EN-GM	M113, M119 Milling
WNMU	○○○○○○EN-SM	M113, M119 Milling
WPGT	○○○○○○L-Y	B107 Turning indexable inserts
WPGT	○○○○○○ML-Y	B107 Turning indexable inserts
WPGT	○○○○○○MR-Y	B107 Turning indexable inserts
WPGT	○○○○○○R-Y	B107 Turning indexable inserts
WPGW	○○○○○○	B107 Turning indexable inserts
WPMT	○○○○○○	C51 CBN & PCD Tools
WPMT	○○○○○○GP	B107 Turning indexable inserts
WPMT	○○○○○○HQ	B107 Turning indexable inserts
WPMT	○○○○○○NE	C51 CBN & PCD Tools
WPMT	○○○○○○SE	C51 CBN & PCD Tools
WTENN	○○○○K-○○N	D28 External turning
WTENN	○○○○M-○○N	D28 External turning
WTJN ⁹ /L	○○○○K-○○N	D27 External turning
WTJN ⁹ /L	○○○○M-○○N	D27 External turning
WTRN ⁹ /L	○○○○K-○○N	D27 External turning
WTRN ⁹ /L	○○○○M-○○N	D27 External turning
WWLN ⁹ /L	○○○○K-○○	D46 External turning
WWLN ⁹ /L	○○○○M-○○	D46 External turning

Z

Description	Page	Category
ZBMT	○○T○○○GF	B108 Turning indexable inserts
ZBMT	○○T○○○R-GF-○○D	B108 Turning indexable inserts
ZCMT	○○T○○○	K76 Drilling
ZCMT	○○T○○○SP	K76 Drilling
ZCMT	○○T○○○SU	K76 Drilling
ZCMT	○○○○○○	K76 Drilling
ZCMT	○○○○○○SP	K76 Drilling
ZCMT	○○○○○○SU	K76 Drilling
ZXMT	○○T○○○GH	K90 Drilling
ZXMT	○○T○○○GM	K90 Drilling
ZXMT	○○T○○○SM	K90 Drilling
ZXMT	○○○○○○GH	K90 Drilling
ZXMT	○○○○○○GH-E	K90 Drilling
ZXMT	○○○○○○GM	K90 Drilling
ZXMT	○○○○○○GM-E	K90 Drilling
ZXMT	○○○○○○GM-I	K90 Drilling
ZXMT	○○○○○○SM	K90 Drilling
ZXMT	○○○○○○SM-E	K90 Drilling



Tool Management

Economy, security and access control

ECONOMY

- Reduction of stock
- Visible distribution of costs
- Cost allocation
- Reduction of administrative costs
- Decrease waste and tool usage

EFFICIENCY

- Automate tool orders
- Minimize ineffective time
- Real-time overview of your stock

FLEXIBLE AND SMART DESIGN

- Optimised design for saving space
- Personal configuration of bins
- Registration of multiple suppliers



Contact Kyocera or your local distributor
for more information.

Offices (Countries/Regions)

*Japanese technical staff stationed in branch office

Japan

SALES - PRODUCTION - TECHNICAL CENTER
KYOCERA Corporation, International Sales Dept. *
6 Takeda Tobadono-cho, Fushimi-ku,
Kyoto 612-8501, Japan
Phone: +81-75-604-3473 Fax: +81-75-604-3472
<http://global.kyocera.com/prdct/tool/index.html>

Denmark

SALES - PRODUCTION - TECHNICAL CENTER
KYOCERA UNIMERCO Tooling A/S
Drejervej 2, DK-7451 Sunds, Denmark
Phone: +45-97-14-14-11 Fax: +45-97-14-14-86
www.kyocera-unimerco.com www.kyocera-unimerco.dk

Germany

SALES - TECHNICAL CENTER
KYOCERA UNIMERCO Tooling GmbH *
Hammfeldsdamm 6, D-41460 Neuss, Germany
Phone: +49-2131-1637-115 Fax: +49-2131-1637-152
www.kyocera-unimerco.de

United Kingdom

SALES - PRODUCTION - TEST CENTER
KYOCERA UNIMERCO Tooling Ltd.
Unit 1, Saville Business Park 101 Attercliffe Road
UK-Sheffield S4 7WW, United Kingdom
Phone: +44-0114-2788787 Fax: +44-0114-2757155
www.kyocera-unimerco.co.uk

France

SALES
KYOCERA UNIMERCO TOOLS S. A. S.
Parc Tertiaire Silic, 21 Rue de Villeneuve,
BP 90439, 94528 Rungis Cedex, France
Phone: +33-1-4173-7330 Fax: +33-1-4173-7359
www.kyocera-unimerco.fr

Italy

SALES - TECHNICAL CENTER
KYOCERA UNIMERCO Tooling S.r.l. unipersonale
Viale delle Industrie 20/5, 20044 Arese (MI), Italy
Phone: +39-02-00620-845 Fax: +39-02-00620-848
www.kyocera-unimerco.it

Spain

SALES
KYOCERA UNIMERCO Tooling GmbH, Spain Branch
Calle de Manacor 2, 28290 Las Matas, Madrid, Spain
Phone: +34-91-631-83-92 Fax: +34-91-631-82-19
www.kyocera-unimerco.es

Norway

SALES
KYOCERA UNIMERCO Tooling AS
Karihaugveien 89, N-1086 Oslo, Norway
Phone: +47-22-72-06-02 Fax: +47-22-30-92-20
www.kyocera-unimerco.no

Sweden

SALES
KYOCERA UNIMERCO Tooling AB
Sagaholmsvägen 9, S-553 02 Jönköping, Sweden
Phone: +46-36-34-46-00 Fax: +46-36-31-32-00
www.kyocera-unimerco.se

Finland

SALES
KYOCERA UNIMERCO Tooling Oy
Niemenkatu 73, FI-15140 Lahti, Finland
Phone: +358-3-7776070 Fax: +358-3-7776072
www.kyocera-unimerco.fi

Poland

SALES
KYOCERA UNIMERCO Tooling Sp. z o.o.
ul. Gwiazdzista 66, 53-413 Wrocław, Poland
Phone: +48-71-381-12-15 Fax: +48-71-381-12-16
www.kyocera-unimerco.pl

Czech Republic

SALES
KYOCERA UNIMERCO Tooling s.r.o.
Videnska 102, CZ-619 00 Brno, Czech Republic
Phone: +45-97-14-14-11 Fax: +45-97-14-14-86

Turkey

SALES - TECHNICAL CENTER
KYOCERA BILGINOGLU Precision Tools Industry & Trade A.S. *
Ikitelli OSB Mah. Fatih 7B Blok Sk.2 - Basaksehir / Istanbul, Turkey
Phone: +90-212-612-55-45 Fax: +90-212-612-65-85
www.kyocera-bilginoglu.com.tr

Lithuania

SALES
KYOCERA UNIMERCO Tooling UAB
Titnago g.10, LT-02300 Vilnius, Lithuania
Phone (+370 (5) 260 23 95 Fax (+370) (5) 260 23 94

USA

SALES - TECHNICAL CENTER
KYOCERA Precision Tools *
102 Industrial Park Road, Hendersonville, NC 28792, USA
Phone: +1-828-693-6596 Fax: +1-828-692-1344
www.kyoceraprecisiontools.com

Mexico

SALES
KYOCERA Mexico Services S.A. de C.V. Leon Office *
HT-SUITE 703 nivel 7, plaza de la Paz No.102 Puerto interior C.P 36275, Silao
Guanajuato, Mexico
Phone & Fax: +52-477-772-0172

Brazil

SALES - TECHNICAL CENTER
KYOCERA do Brasil Componentes Industriais Ltda. *
Rua Yashica 65, Jd. Bela Vista, Sorocaba,
Sao Paulo, Brazil, CEP 18016-440
Phone: +55-15-3227-3800 Fax: +55-15-3237-7529
www.kyocera-componentes.com.br

Korea

SALES - PRODUCTION - TECHNICAL CENTER
KYOCERA Precision Tools Korea Co., Ltd.
2LT 69BL, Namdong Industrial Estate 11,
Namdong-Daero 215 Beon-Gil Namdong-Gu, Incheon, 21633, Korea
Phone: +82-32-821-8365 Fax: +82-32-821-8369
www.kptk.co.kr

China

SALES - PRODUCTION - TECHNICAL CENTER
KYOCERA (China) Sales & Trading Corporation *
Room 140, Building A3, Daning Central Square, No. 700 Wanrong Road,
Jingan District, Shanghai, 200072, P.R.China
Phone: +86-21-3660-7711 Fax: +86-21-5638-6200
www.kyocera.com.cn/prdct/cuttingtool

Taiwan

SALES
KYOCERA Asia Pacific Pte. Ltd. Taipei Branch
8F, No.101, Sec.2, Nanjing East Road, Taipei 10457, Taiwan
Phone: +886-2-2567-2008 Fax: +886-2-2567-2700
www.kyocera.com.tw

Singapore

SALES
KYOCERA Asia Pacific Pte. Ltd. *
298 Tiong Bahru Road, #13-03/05 Central Plaza, Singapore 168730
Phone: +65-6373-6700 Fax: +65-6271-0600
www.kyocera.com.sg/products/cuttingtools/index.html

India

SALES
KYOCERA CTC Precision Tools Pvt. Ltd. *
Unit No's: 102 A to D, Tower A, Ground Floor, Signature Towers,
South City 1, Sector 30, Gurugram, 122001, India
Phone: +91-124-432-1963

Indonesia

SALES
KYOCERA Asia Pacific Pte. Ltd. Indonesia Representative Office *
Jin Niaga Raya Kav. AA3 Blok AB6, Jababeka II,
Cikarang-Bekasi-Jawa Barat, Indonesia 17530 Indonesia
Phone: +62-21-29083848 Fax: +62-21-29083846

Thailand

SALES - TECHNICAL CENTER
KYOCERA Asia Pacific (Thailand) Co., Ltd. *
1 Capital Work Place Building 7th Floor, Soi Chamchan,
Sukhumvit55 Road, Klongton Nua, Wattana, Bangkok 10110, Thailand
Phone: +66-2-030-6688 Fax: +66-2-030-6600

Vietnam

SALES
KYOCERA Asia Pacific Pte. Ltd. Ho Chi Minh Representative Office
5F Somerset Chancellor Court 21-23 Nguyen Thi Minh Khai District 1,
HCM City, Vietnam
Phone: +84-28-3822-1240 Fax: +84-28-3822-1241

Philippines

SALES
KYOCERA Asia Pacific Pte. Ltd. Manila Branch
11B Kingston Tower, Block 2, Lot 1 Acacia Avenue,
Madrigal Business Park Alabang, Muntinlupa City 1770, Philippines
Phone: +63-2-519-7189 Fax: +63-2-775-0532

Malaysia

SALES
KYOCERA (Malaysia) Sdn. Bhd. (Head Office)
Lot 4A, Lower Level 3, Hotel Equatorial Penang, No. 1 Jalan Bukit Jambul,
11900 Penang, Malaysia
Phone +60-4-641-4190 Fax +60-4-641-4205



The official Kyocera Tool App

Find latest information about Kyocera Cutting Tools here
Download now



Co2 emission calculator

visualize your current emissions output and implement changes
for more sustainable manufacturing.



Subscribe to our channels



KYOCERA UNIMERCO Tooling GmbH

Hammfelddamm 6 • 41460 Neuss • Germany

Tel +49 (0) 2131 8819 115 | Fax +49 (0) 2131 1637 152

kutde@kyocera-unimerco.com | www.kyocera-unimerco.com



ISO9001 JMI-0036



EMS 635470 / ISO 14001

TZE01007

© 2022 KYOCERA UNIMERCO